

Introduction

Thank you for purchasing this SHARP mobile handset. Before and while using the handset, please read this manual thoroughly and retain it for future reference. This handset is your partner. Handle it carefully at all times to ensure its long-term performance.









About this Operation Manual

Instruction scheme

Instructions in this manual are carefully designed to help you operate the handset smoothly and easily. At the beginning of each section, the steps that have to be followed to reach the function you wish to utilise are shown (Example 1). The steps for all subsequent subsections are simplified (Example 2). Make sure to press  to enter your selection.

Example 1:

(Excerpt from "Viewing the Contacts List" on page 9-54)

- 1** Press .
The main menu appears.
- 2** Press , ,  or  to highlight "Contacts" and press .
- 3** Press  or  to highlight "Contacts list" and press .
The index view of the "Contacts list" appears.

In example 1, each step to reach the "Contacts list" is shown.







Example 2:

(Excerpt from "Selecting the Memory for saving" on page 9-55)

- 1** At the main menu, select in the following order: "Contacts" → "Contacts list."
- 2** Press  [Options].
The "Options" menu appears.

In example 2, the steps to reach the "Contacts list" are simplified as shown above (step1).



, , , ,  and  [Options] indicate the operation keys in this manual. For information on the keys and handset operations, refer to "Parts and Controls" on page 4-22.

Symbols



This indicates useful extra information for operating the handset.



This indicates important background information or items that need to be recognised when operating the handset.



This indicates operations that require extreme caution before performing on the handset.

NOTICE

- We strongly recommend that you keep separate permanent written records of all important data. Data may be lost or altered in virtually any electronic memory product under certain circumstances.

Therefore, we assume no responsibility for data lost or otherwise rendered unusable, whether as a result of improper use, repairs, defects, battery replacement, use after the specified battery life has expired or any other cause.

- We assume no responsibility, directly or indirectly, for financial losses or claims from third parties resulting from the use of this product and any of its functions, such as stolen credit card numbers, the loss or alteration of stored data, etc.
- All company and/or product names are trademarks and/or registered trademarks of their respective holders.
- Screen layouts illustrated in this operation manual may differ from those on the handset.
The information described in this operation manual is subject to change without notice.
- Some of the functions described in this operation manual may not be supported by all networks.
- We assume no responsibility for content, information, etc. downloaded from the network.

- The CGS-LCD used for the main display is a world advanced technology product, giving you fine picture quality. Occasionally, a few black or bright pixels may appear on the screen. Please note that this will not have any impact on any of the features or performance.

Copyright

According to copyright laws, the reproduction, alteration and use of material protected by copyright (music, pictures, etc.) is only permitted for personal or private use. If the user is not in possession of more extensive copyrights or has not received explicit permission from the copyright owner to reproduce, alter or use a copy which is made or modified in this way, this is considered to be a violation of the copyright laws and gives the copyright owner the right to claim damages. For this reason, avoid the illegal use of material protected by copyright.

Windows is a registered trademark of Microsoft Corporation in the United States and/or other countries.

Powered by JBlend™, Copyright1997-2004 Aplix Corporation. All rights reserved.
Java and all Java-based trademarks and logos are trademarks or registered trademarks of Sun Microsystems, Inc. in the U.S. and other countries.
JBlend and all JBlend-based trademarks and logos are trademarks or registered trademarks of Aplix Corporation in Japan and other countries.

In this product, JBlend™ is incorporated. JBlend™ is a Java execution environment that Aplix developed for implementing advanced performance and fast operation on small-memory systems. JBlend and JBlend logo are trademarks or registered trademarks of Aplix Corporation in Japan and other countries.



Licensed by Inter Digital Technology Corporation under one or more of the following United States Patents and/or their domestic or foreign counterparts and other patents pending, including U.S. Patents: 4,675,863; 4,779,262; 4,785,450 & 4,811,420.

Licensed under U.S. Patent 4,558,302 and foreign counterparts.

CP8 PATENT

SD logo  is a trademark.

T9 Text Input is licensed under one or more of the following: U.S. Pat. Nos. 5,818,437, 5,953,541, 5,187,480, 5,945,928 and 6,011,554; Australian Pat. No. 727539; Canadian Pat. No. 1,331,057; United Kingdom Pat. No. 2238414B; Hong Kong Standard Pat. No. HK0940329; Republic of Singapore Pat. No. 51383; Euro. Pat. No. 0 842 463 (96927260.8) DE/DK, FI, FR, IT, NL,PT,ES,SE,GB; Republic of Korea Pat. Nos. KR201211B1 and KR226206B1; and additional patents are pending worldwide.

Use of this product in any manner that complies with the MPEG-4 Visual Standard is prohibited, except for use directly related to (a) data or information (i) generated by and obtained without charge from a consumer not thereby engaged in a business enterprise, and (ii) for personal use only; and (b) other uses specifically and separately licensed by MPEG LA, L.L.C.

Bluetooth is a trademark of the Bluetooth SIG, Inc.



The Bluetooth word mark and logos are owned by the Bluetooth SIG, Inc. and any use of such marks by Sharp is under license. Other trademarks and trade names are those of their respective owners.

BROWSER BY



OPENWAVE



Safety Precautions and Conditions of Use

Your handset conforms to international regulations insofar as it is used under normal conditions and in accordance with the following instructions.

Electromagnetic waves

- Do not turn on your handset aboard an aircraft (as your handset may interfere with the aircraft's electronic systems and disrupt the cellular network). Current legislation forbids use and legal action can be taken against the user.
- Do not turn on your handset in a hospital, except in designated areas. Use of your handset's functions may affect the performance of electronic medical devices (pacemakers, hearing aids, insulin pumps, etc.). When handset functions are on, do not bring it near medical equipment or into areas in which medical equipment is being used. If you have a hearing aid or a pacemaker, only use the handset on the opposite side of your body from where it is located. The handset should be kept at least 15.24 cm (6 inches) from a pacemaker ANYTIME the handset is switched on.
- Do not turn on your handset near gas or flammable substances. Observe the rules concerning the use of handsets at petrol stations, chemical plants and at all sites where a risk of explosion exists.

1-4

Caring for your handset

- Do not allow children to use your handset without supervision.
- Never attempt to disassemble, repair or modify your handset. Such action may result in bodily injury or damage to the unit or other property. The product can only be repaired by authorised service personnel.
- Never allow any metallic objects (e.g., staples, paper clips) to become inserted into your handset, as this could result in the generation of excess heat or fire.
- Do not use solvents to clean your handset. Use only a soft, dry cloth.
- Do not drop your handset or subject it to severe impacts. Bending the body and pushing the display or keys with force can damage the handset.
- Do not carry your handset in your back pocket as it could break when you sit down. The display is made of glass and is particularly fragile.
- Never touch liquid that may leak from a broken liquid crystal display (LCD), as doing so may cause a skin rash.
- Avoid touching the external connector on the underside of the handset, since the delicate components within can be damaged by static electricity.
- Never use or store your handset in the following locations:
 - Anywhere it may be exposed to water (e.g. bathroom or sauna)

- Conditions of high humidity (e.g., rain or fog)
- Conditions of extreme high temperatures (e.g., near fire or in a sealed automobile)
- In direct sunlight
- Locations or sites subject to strong vibration
- It is advised that the device not be used by a driver while the vehicle is moving except in an emergency. Speak only into a fixed, neck-slung or clipped-on microphone when it will not distract your attention from the road. Also see "Precautions Concerning Vehicle Use" on page 1-7.
- Never dispose of your device with ordinary waste.

Battery

- Use your handset only with batteries, chargers and accessories recommended by the manufacturer. The manufacturer disclaims any liability for damage caused by the use of other chargers, batteries or accessories.
- Use only the standard accessory battery (CE-BL200).
- Recommended temperature for using and storing batteries is approximately 20°C (68°F).
- The battery's performance is limited in low temperatures, particularly below 0°C (32°F) and the handset may not work temporarily regardless of the amount of remaining battery power.
- Exposing the handset to extreme temperatures will shorten battery life.
- The battery can be charged and discharged hundreds of times but it will eventually wear out. When the operating time (talk time and standby time) is noticeably shorter than normal, it is time to buy a new battery.
- Network configuration and handset usage will affect talk time and standby time. Using games, camera or Music Player will hasten battery consumption.
- When the battery charging alert is displayed on the screen, charge the battery as soon as possible. If you continue using your handset ignoring the alert, the handset may malfunction and all data and settings you have stored may be lost at any moment.
- Charge the new battery as soon as possible after removing the old one.
- Before removing the battery from the handset, make sure the handset is turned off.
- Do not touch the battery terminals. Batteries can cause damage, injury or burns if a conductive material touches exposed terminals. When the battery is detached from the handset, use a cover made of nonconductive material to keep and carry the battery safely.
- Never attempt to disassemble or modify the battery.
- Never touch any fluid that may leak from the internal battery, as doing so may result in injury to the skin or eyes.

- Never drop your handset or subject it to severe shock. This may cause the internal battery to leak, ignite and/or rupture. Immediately remove your handset from the vicinity of any open flame in the event the internal battery leaks or emits an unusual odour.

CAUTION

RISK OF EXPLOSION IF BATTERY IS REPLACED
BY AN INCORRECT TYPE.
DISPOSE OF USED BATTERIES ACCORDING
TO THE INSTRUCTIONS
See "Battery Disposal" below.

Battery Disposal

- Take the used battery to the local waste depot.
- Do not expose the used battery to an open flame. Do not dispose in water or dispose with household waste.

BATTERY DISPOSAL

THIS PRODUCT CONTAINS LITHIUM-ION BATTERY.
THIS BATTERY MUST BE DISPOSED OF PROPERLY.
CONTACT LOCAL AGENCIES FOR INFORMATION ON
RECYCLING AND DISPOSAL OPTIONS IN YOUR
AREA.

Aerial Care

- Do not touch the aerial unnecessarily while using the handset. If it is held, call quality may be hindered

leading to shortened talk-time and stand-by time because the handset may have to operate on a higher power level than is necessary.

- Use only the aerial supplied or one approved by Sharp for your handset. Using unauthorised or modified aerial may damage the handset. Moreover, since the handset may violate the appropriate regulations, it may lose performance or exceed the limitation of SAR levels.
- To avoid impaired performance, do not damage the aerial of the handset.
- While talking directly into the microphone, hold the handset so that the aerial is upwards over your shoulder.
- To avoid interfering with blasting operations, please turn off the handset in a blasting area or in a place where a "turn off two-way radio" sign is posted.

RF Connector

- This RF connector is for connecting Sharp-approved aerial to the handset. Do not connect unapproved or modified equipment as this may damage the handset or cause the SAR limit to be exceeded.
- Do not touch or crowd the connector unnecessarily as this may affect standby and call times.

Camera Operation

- Learn picture quality, file formats, etc. beforehand. Pictures are saved in JPEG format.
- Be careful not to move your hand while taking pictures. If the handset moves while taking a picture, the picture may be blurred. When taking a picture, hold the handset firmly or use the delay timer to prevent it from moving.
- Clean the lens before taking a picture. Fingerprints, oil, etc. on the lens hinder focusing. Wipe with a soft cloth before taking a picture.

Miscellaneous

- As the handset uses an electronic storage unit, data may be lost or corrupted under various circumstances.
- Before connecting the handset to a PC or a peripheral device, read the operation manual carefully.
- If the handset's battery has been removed for some time its or the handset has been reset, the unit's clock and calendar may be initialised. The date and time should be updated.
- Use only the included headset for hands-free operation. Some handset functions may not work when unauthorised hands-free are used.
- The handset uses a magnet to recognise that the handset is closed. Do not place magnetic cards near your handset or get the card caught in the handset as it may damage the recorded data.

Environment

- Keep your handset away from extreme heat. Do not leave on the dashboard of a car or near a heater. Do not leave it in any place that is extremely damp or dusty.
- Since this product is not waterproof, do not use it or store it where fluids can splash onto it. Raindrops, water spray, juice, coffee, steam, perspiration, etc. may also cause a malfunction.

Precautions Concerning Vehicle Use

- It is the user's responsibility to verify if local laws permit the use of a handset in a vehicle. Give full attention to driving. Pull off onto the side of the road and park the car before making or answering a call.
- If local laws permit, we recommend that you use your handset with the included hands-free Kit.
- Refrain from putting the stereo headset (supplied) into both ears while you are driving.
- Use of your handset's functions may interfere with the vehicle's electronic systems, such as the ABS antilock brakes or the air-bag. To ensure no such problem occurs, please check with your dealer or car manufacturer before using your handset.
- Only allow qualified service personnel to install the vehicle accessories. The manufacturer disclaims any liability for damage which may result as a consequence of improper use or use contrary to the instructions contained herein.

FCC Declaration of Conformity

Triple-band phone: TM200 with USB cable(CE-UC32) and AC charger(CE-EA32)

This device complies with part 15 of the FCC Rules. Operation is subject to the following two conditions:

- (1) This device may not cause harmful interference, and
- (2) this device must accept any interference received, including interference that may cause undesired operation.

Responsible Party:

SHARP ELECTRONICS CORPORATION
Sharp Plaza, Mahwah, New Jersey 07430
TEL:1-800-BE-SHARP

Tested To Comply With FCC Standards
FOR HOME OR OFFICE USE



FCC Notice

The phone may cause TV or radio interference if used in close proximity to receiving equipment. The FCC can require you to stop using the phone if such interference cannot be eliminated.

Information To User

This equipment has been tested and found to comply with the limits of a Class B digital device, pursuant to Part 15 of the FCC Rules. These limits are designed to provide reasonable protection against harmful interference in a

residential installation. This equipment generates, uses and can radiate radio frequency energy and, if not installed and used in accordance with the instructions, may cause harmful interference to radio communications. However, there is no guarantee that interference will not occur in a particular installation; If this equipment does cause harmful interference to radio or television reception, which can be determined by turning the equipment off and on, the user is encouraged to try to correct the interference by one or more of the following measures:

- 1 Reorient/Relocate the receiving antenna.
- 2 Increase the separation between the equipment and receiver.
- 3 Connect the equipment into an outlet on a circuit different from that to which the receiver is connected.
- 4 Consult the dealer or an experienced radio/TV technician for help.

CAUTION: Changes or modifications not expressly approved by the manufacturer responsible for compliance could void the user's authority to operate the equipment.

Exposure to Radio Waves

THIS MODEL PHONE MEETS THE GOVERNMENT'S REQUIREMENTS FOR EXPOSURE TO RADIO WAVES.

Your wireless phone is a radio transmitter and receiver. It is designed and manufactured not to exceed the emission limits for exposure to radio frequency (RF) energy set by the Federal Communications Commission of the U.S. Government. These limits are part of comprehensive guidelines and establish permitted level of RF energy for the general population.

The guidelines are based on standards that were developed by independent scientific organizations through periodic and thorough evaluation of scientific studies. The standards include a substantial safety margin designed to assure the safety of all persons, regardless of age and health. The exposure standard for wireless mobile phones employs a unit of measurement known as the Specific Absorption Rate, SAR. The SAR limit set by the FCC is 1.6W/kg, * Tests for SAR are conducted using standard operating positions specified by the FCC with the phone transmitting at its highest certified power level in all tested frequency bands. Although the SAR is determined at the highest certified power level, the actual SAR level of the phone while operating can be well below the maximum value. This is because the phone is designed to operate at multiple power levels so as to use only the power required to reach

the network. In general, the closer you are to a wireless base station antenna, the lower the power output.

Before a phone model is available for sale to the public, it must be tested and certified to the FCC that it does not exceed the limit established by the government-adopted requirement for safe exposure. The tests are performed in positions and locations (e.g., at the ear and worn on the body) as required by FCC for each model. The highest SAR value for this model phone when tested for use at the ear is 0.631W/kg and when worn on the body, as described in this operation manual is 1.42W/kg. Body-worn Operation; This device has been tested for typical body-worn operations with the back of the phone touching the body. Body-worn operations are restricted to belt-clips, holsters or similar accessories that have no metallic component in the assembly. The use of accessories that do not satisfy these requirements may not comply with FCC RF exposure requirements, and should be avoided. While these may be differences between the SAR levels of various phones and at various positions, they all meet the government requirement for safe exposure.

The FCC has granted an Equipment Authorization for this model phone with all reported SAR levels evaluated as in compliance with the FCC RF emission guidelines. SAR information on this model phone is on file with the FCC and can be found under the Display Grant section of <http://www.fcc.gov/oet/fccid> after searching on FCC ID APYNAR0058.

Additional information on Specific Absorption rates (SAR) can be found on the Cellular Telecommunications & Internet Association (CTIA) web-site at:
<http://www.phonefacts.net>

* In the United States and Canada, the SAR limit for mobile phones used by the public is 1.6Watts/kg (W/kg) averaged over one gram of tissue. The standard incorporates a substantial margin of safety to give additional protection for the public and to account for any variations in measurements.

Declaration of Conformity

Hereby, Sharp Telecommunications of Europe Ltd, declares that this TM200 is in compliance with the essential requirements and other relevant provisions of Directive 1995/5/EC.

A copy of the original declaration of conformity can be found at the following Internet address:
<http://www.sharp-mobile.com/tm/>

SAR

Your handset has been designed, manufactured and tested so as not to exceed the limits for exposure to electromagnetic fields recommended by the Council of the European Union. These limits are part of comprehensive guidelines developed by independent scientific organizations. The guidelines include a

substantial safety margin designed to assure the safety of the handset user and others and to take into account variations in age and health, individual sensitivities and environmental conditions. European standards provide for the amount of radio frequency electromagnetic energy absorbed by the body when using a handset to be measured by reference to the Specific Absorption Rate (SAR). The SAR limit for the general public is currently 2 watts per kilogram averaged over 10 grams of body tissue. Your handset SAR value is 0.265 watts per kilogram.

This has been tested to ensure that this limit is not exceeded even when the handset is operating at its highest certified power. In use however your handset may operate at less than full power because it is designed to use only sufficient power to communicate with the network.

Table of Contents

Introduction	1-1	Using the Camera	7-38
About this Operation Manual	1-1	Taking Pictures	7-38
NOTICE	1-2	Shooting Video Images	7-42
Copyright	1-2	Common Functions & Information	7-45
Safety Precautions and Conditions of Use	1-4	Create Photo/Video Mode Indicators	7-49
FCC Declaration of Conformity	1-8	Entering Text	8-51
Exposure to Radio Waves	1-9	Text Table for Multi-tap Input	8-51
Declaration of Conformity	1-10	Selecting the Input Method	8-52
SAR	1-10	Selecting the Input Language	8-52
Quick Setup	3-13	Using Text Templates	8-53
Using the Memory Card	3-18	Copying, Cutting and Pasting Text	8-53
If You Upgrade Your Handset	3-21	Using the Contacts List	9-54
Parts and Controls	4-22	Contacts List Basics	9-54
Main Handset Unit	4-22	Selecting the Memory	9-55
Display Indicators	4-25	Saving Information to the Contacts List	9-56
Guide to the Main Menu	5-28	Dialling from the Contacts List	9-57
Using the Main Menu	5-28	Editing the Contacts List	9-59
List of Menu Function Items	5-30	Setting the Groups	9-63
Basic Handset Operations	6-32	Memory Status	9-65
Making a Call	6-32	Setting the Speed Dial List	9-65
Answering a Call	6-32	Checking Own Numbers	9-66
Redialling	6-33	Accessing “t-zones”	10-67
Useful Functions	6-34	Viewing the Browser	10-67
		Using the Message Service	11-68
		Message Types Available with the Handset	11-68

Creating and Sending Messages	11-69	Checking the Duration of Calls	14-125
Receiving and Reading Messages	11-74	Checking the Cost of Calls	14-125
Deleting Messages	11-78	Checking the Amount of Data Communication	14-127
Settings for the Messages	11-79	Setting the Handset	15-128
Making Text Templates	11-81	Setting the Display Language	15-128
Using Voice Mail	11-82	Setting the Main Display	15-128
Memory Status	11-83	Setting the External Display	15-132
Setting Cell Broadcasts	11-83	Resetting the Phone Setting	15-135
Setting Cell Info	11-85	Setting the Profiles	15-136
Browsing the WAP Alerts	11-85	Call Settings	15-143
Enjoying Multi Media	12-86	Call Forwarding	15-147
Using Pictures	12-86	Setting Networks	15-148
Using Sounds	12-96	Setting the Date and Time	15-151
Using Games or Applications	12-106	Setting Security	15-153
Using Videos	12-107	Setting an Account	15-158
Using Music	12-110	Customising Keys	15-162
Memory Status	12-113	Master Reset	15-163
Using the Personal Organiser	13-114	Connecting to a PC	16-164
Using the Calendar	13-114	Installing Software	16-164
Using the Alarm	13-116	Connecting the Handset	16-165
Using the Calculator	13-119	Troubleshooting	17-167
Using Memo Recording	13-120	Index	18-170
Using the Phone Help	13-121		
Using the Call History	14-122		
Calling from the Call Log	14-122		
Saving a Call Log to the Contacts List	14-123		
Deleting a Call Log	14-124		
Clearing Call Logs	14-124		

Quick Setup

Quick Setup gives you the basic information you need to start using your handset.

Step 1: Unpacking

Check that the following items are included:

- Handset (the battery cover attached)
- Rechargeable Li-ion battery
- AC charger
- Hands free EARphone & MIC (Stereo)
- Operation Manual

Some other brochures or supplements may also be included.

Purchase SD memory card separately.

CONTAINS LITHIUM-ION BATTERY.
MUST BE DISPOSED OF PROPERLY.

Step 2: Inserting the SIM Card and the Battery

In order to access the available services, do not forget to insert a SIM card and a battery. The SIM card carries the user's identity for accessing the network and also stores personal information such as the phone directory and SMS messages. Only use a 3V SIM card with your handset.



If you already have a mobile phone before purchasing this handset, you may use your previous SIM card with the new handset. In this case, refer to "If You Upgrade Your Handset" on page 3-21.

Quick Setup

- 1** Press (①) and slide the battery cover in the direction of the arrow (②).

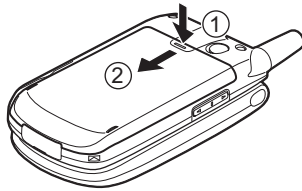

Quick Setup

- 2** Remove the battery cover.

- 3** Slide the SIM card into the SIM holder as illustrated.
Do not touch the metal part of the SIM terminal.

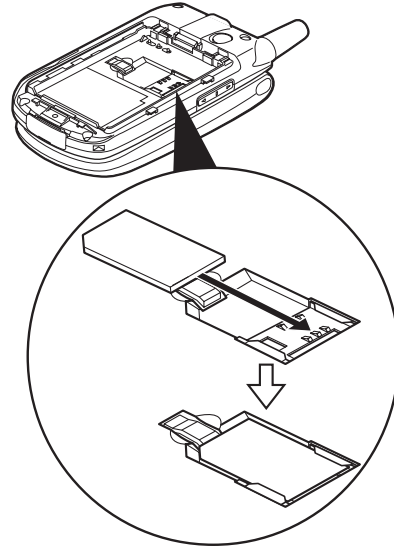

- 4** Position the battery with the model name facing up. Insert its top end into slot (1) as illustrated and insert the other end into position (2).

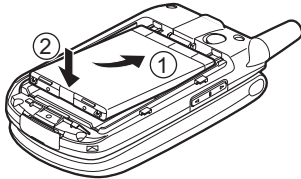

- 5** Align the battery cover with the battery compartment as illustrated and slide it in the direction of the arrow until it clicks.

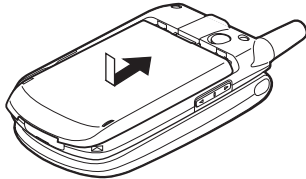

Removing the SIM Card

In step 3 on page 3-14, press the tab securing the card and slide it in the opposite direction from the SIM holder.

Step 3: Charging the Battery

The battery is not fully charged when you purchase the handset. Charge the battery for at least 2 hours before using. Use only the included AC charger.

Using the Charger

- 1** Insert the charger plug into an AC outlet.
- 2** Open the external connector cap and insert the charger (label facing up) into the USB/Charger connector. The battery indicator in the display () starts animating.

Quick Setup

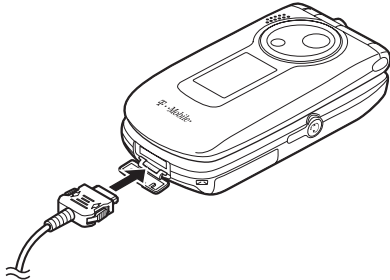

3 When charging is complete, the Indicator stops animating.



- *The standard charging time is approximately 2 hours.*
- *Charging time may vary depending on the state of the battery and other conditions. For information on the battery, refer to "Battery" on page 1-5.*

Removing the charger





Disconnect the charger plug from the AC outlet and unplug the charger from the handset.

To charge using the cigarette lighter charger

The optional cigarette lighter charger (CE-CL30) supplies power for charging from the cigarette lighter socket of a car.

Battery Status

Check the battery indicator displayed in the upper left of the display to estimate remaining battery power. When the battery is empty, "  " appears on the display and an alarm sounds. The battery may only last for another 5 minutes. If you are using your handset, charge the battery immediately.

Battery Indicators	Charge Level
	Sufficiently charged
	Partially charged
	Charging recommended
	Charging required
	Empty

Step 4: Turning On Your Handset

Open the handset and press  and hold for approximately 2 seconds.

The standby screen appears in the main display.



- For information on key operations, refer to “Parts and Controls” on page 4-22.
- When turning on the handset, you may be asked to enter a PIN (Personal Identification Number) code. Enter it and press . For more information, refer to “If You Upgrade Your Handset” on page 3-21 and the brochures supplied with the SIM card.















Turning Off Your Handset

Press  and hold for approximately 2 seconds.





Step 5: Setting the Date and Time

Set the date and time before using the handset. If date and time are left unset, you cannot operate some time-based functions correctly.

- 1 Open the handset.

- 2 Press .
The main menu appears.
- 3 Press , ,  or  to highlight “Settings” and press .
- 4 Press  or  to highlight “Date & Time” and press .
- 5 Press  or  to highlight “Set date/time” and press .
- 6 Enter the month, day, year and time using the digit keys and press .
If you enter the time in the 12-hour format, press  to switch between am and pm.



- For more information on how to set date and time, refer to “Setting the Date and Time” on page 15-151.
- You can also use , ,  or  to edit the date and time.

Using the Memory Card

The data storage area of the handset can be enhanced by using the memory card. If you wish to use the handset for taking pictures or recording videos, sounds or music, use of the memory card is recommended.

Quick Setup

Inserting the Memory Card

- 1 Turn off the handset.
- 2 Open the SD memory card slot cover.

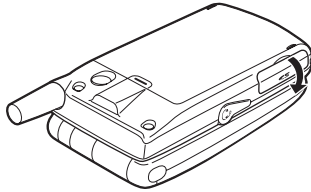

- 3 Insert the memory card all the way in.

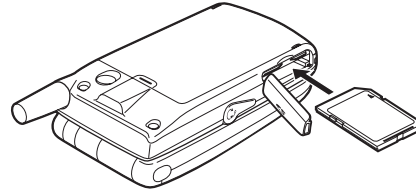

- 4 Close the cover.

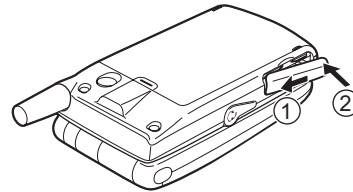



- When you turn on the handset while the memory card is in, the message "Memory card is in" appears in the main display and the memory card indicator is displayed in both the main and external display.
- When you insert the memory card while the handset is turned on, the message "Memory card is inserted" appears in the main display and the memory card indicator is displayed in both the main and external display.



- Use SD memory cards up to 1 GB or MMC up to 128 MB. Note that some types of MMC may not be compatible with your handset.
- The miniSD memory card with SD card adapter cannot be used with your handset.
- Be sure to insert the card in the correct direction and orientation.
- The SD memory card has a write-protect switch that prevents you from deleting contents by accident. If you slide the switch to the lock position, you cannot save or delete files.
- Do not open the memory card cover while the memory card is being formatted, written or read. The card may be damaged beyond use.
- Keep all memory cards out of the reach of small children.

Memory Card Folder Configurations

Some folders are created on the memory card. The pictures, sounds and video clips are stored in appropriate folder.

Main Display

- : Appears when the card is inserted.
- : Appears when the card is inserted and locked.
- : Appears when the card is damaged or unusable.
- : Appears when the card is locked, damaged or unusable.
- : Appears when the card is being written or read (the arrow in the icon is green.)
- : Appears when the card is being formatted (the arrow in the icon is red.)

External Display

- : Appears when the card is inserted.
- : Appears when the card is inserted and locked.
- : Appears when the card is damaged or unusable.
- : Appears when the card is locked, damaged or unusable.
- : Appears when the card is being written or read (the arrow in the icon is green.)
- : Appears when the card is being formatted (the arrow in the icon is red.)

Removing the Memory Card

- 1 Turn off the handset.
- 2 Open the SD memory card slot cover, remove the card and close the cover.

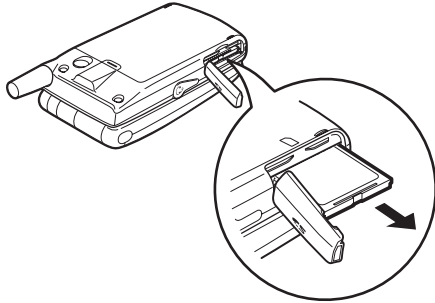

- *When you remove the memory card while the handset is turned on, the message "Memory card is removed" appears in the main display and the memory card icon disappears from both the main and external displays.*
- *Do not remove the memory card while the memory card is being formatted, written or read.*

Formatting the Memory Card

If you wish to clear all data stored in the memory card, format the memory card according to the following steps. The handset code is needed to format the memory card. For information on the handset code, refer to "Enabling the Handset Lock" on page 15-154.

- 1 Press .
The main menu appears.
- 2 Press , , or to highlight "Settings" and press .
- 3 Press or to highlight "Memory card" and press .
- 4 Press or to highlight "Format" and press .
- 5 Enter your handset code and press .
If you wish to cancel, press [Back] before entering the handset code.

If You Upgrade Your Handset

If you have a mobile phone before purchasing this handset, you may use your previous SIM card with the new handset. In this case, you are required to prepare the PIN code used for the old mobile phone to setup.

Entering the PIN Code

If you insert a SIM card you have used for your previous mobile phone, you may be requested to enter a PIN code when you turn on your handset. For more information on the PIN code, refer to "Setting Security" on page 15-153.

- 1 Enter the PIN code that you used for your old mobile phone.
- 2 Press .



- If your PIN code is entered incorrectly three times in a row, the SIM card is locked.
- To release the lock, try entering the PUK (Personal Unblocking Key) code (8 digits) provided by your service provider. For more information on the code, contact your service provider.



You can copy the "Contacts list" entries in your previous SIM card. For information on copying the "Contacts list" entries, refer to "Copying Entries Between Memories" on page 9-61 or "Copying All Entries from the SIM Card to the Handset Memory" on page 9-62.

Parts and Controls

Main Handset Unit

Before reading this operation manual, becoming familiar with the names and locations of parts and controls is recommended.

Also, in this section are icons and indications that change in the display.

Parts and Controls

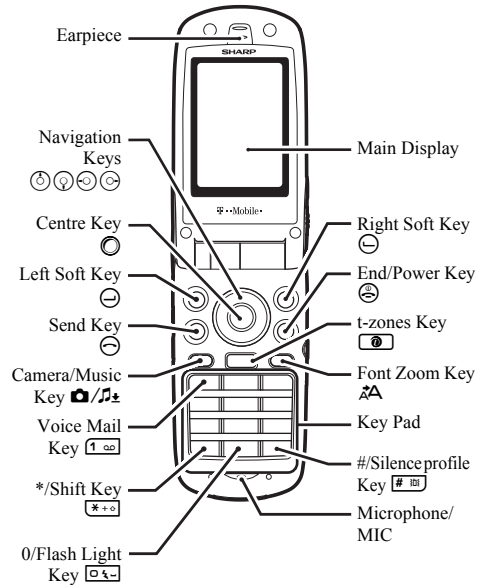
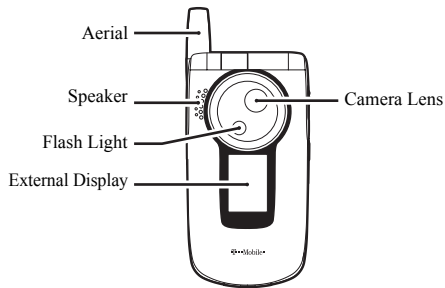

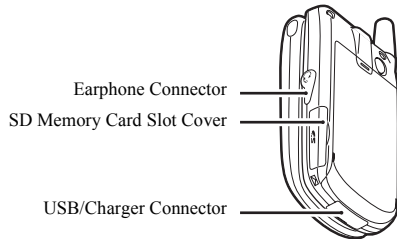
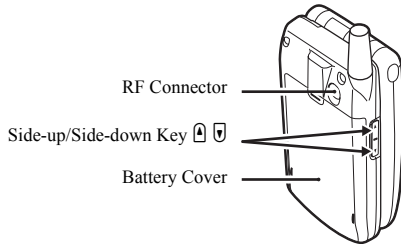

Hands free EARphone & MIC Connection

- 1 Put the pad over the earphone. You can use the hands free EARphone & MIC without the pads.
- 2 Open the earphone connector cap and insert the hands free EARphone & MIC plug into the earphone connector.
For information on how to answer a call, refer to "Answering a Call" on page 6-32.

Flip Functions

Parts and Controls

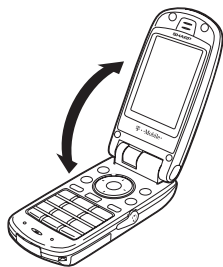

When open:

- the main display is turned on and the keypad lights up.

When closed:

- the external display is turned on and lights up.
- Java™ applications are suspended.
- the handset sends the busy tone to the caller.
For information on how to set this function, refer to "Settings for Flipping the Handset Closed" on page 15-146.
- calls are terminated.
For information on how to set this function, refer to "Settings for Flipping the Handset Closed" on page 15-146.



If closing the handset in "Create photo/video" mode, all unsaved data will be lost.





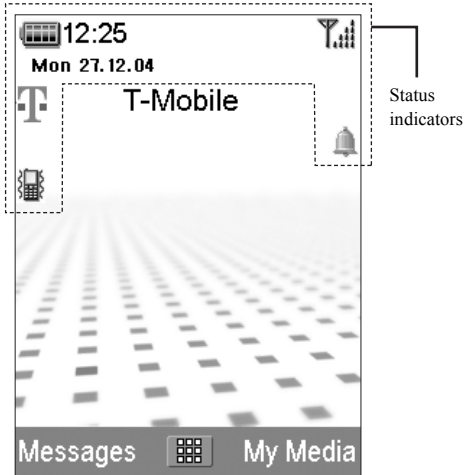









Display Indicators

















Main Display



This section describes the status indicators displayed at the top of the screen.

Status Indicators

1.  /  : Indicates the strength of the received signal or that the service is out of range.
2.  : Indicates the battery level.
3.  : Appears when in call.
4.  /  : Appears when a new SMS/MMS message has arrived.
5.  : Appears when your handset is GPRS* enabled and within range. Flashes during GPRS transmission.
6.  /  : Appears when the WAP or MMS message communication is in CSD** or GPRS mode.
7.  : Appears when the font zoom function is active.
8.  : Appears when the memory card is inserted.
9.  : Appears when at least one unheard voice mail recording is remaining.
10.  /  : Appears when a Java™ application is executed (colour) or suspended (B/W).







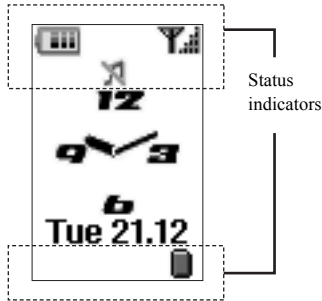

11.  /  : Appears when viewing secure WAP*** browser.
12.  : Appears when the USB cable (supplied with the PC Link Kit) is connected to your handset.
13.  /  : Appears when *Bluetooth* wireless setting is enabled.
14.  : Appears when "All calls" in the "Call diverts" settings (page 15-147) is set.
15.  : Appears when your handset is roaming outside of your network.
16.  /  /  /  /  /  : Indicates the handset's profiles: T-Mobile/My profile/Conference/Activity/In car/Silent (page 15-136).
17.  : Appears when the "Outbox" contains messages you failed to send.
18.  : Appears when "Ringing volume" (page 15-136) is set to "Silent."
19.  : Appears when the alarm (page 13-116) is set.
20.  : Appears when vibration (page 15-137) is set.
21. **T9** : Appears when the T9 text input method is activated.







22. **Abc / ABC / abc / 123** : Indicates the text input method: First letter upper case mode/Upper case mode/Lower case mode/Numeric mode.
***GPRS**: For information on the term, refer to the page 15-162.
****CSD**: For information on the term, refer to the page 15-162.
*****WAP**: For information on the term, refer to the page 15-162.

External Display



Status Indicators

-  /  : Indicates the strength of the received signal or that the service is out of range.
-  : Indicates the battery level.
-  /  /  /  : Appears when new messages are received/the mailbox is full/receiving messages/sending messages.
-  : Appears when the handset is in data connection mode.

-  : Appears when at least one unheard voice mail recording is remaining.
-  : Appears when the "Outbox" contains messages you failed to send.
-  : Appears when "Ringing volume" (page 15-136) is set to "Silent."
-  : Appears when "All calls" in the "Call diverts" settings (page 15-147) is set to "On."
-  : Appears when the USB cable (supplied with PC Link Kit) is connected to your handset.
-  : Appears when the alarm (page 13-116) is set.
-  : Appears when the memory card is inserted.

Guide to the Main Menu

Using the Main Menu

Guide to the Main Menu



After turning on your handset, the **standby screen** appears. If you wish to use any functions other than the basic call operation, press **⓪** once to get the **main menu**. This has 9 icons for functions, operations and settings. When you reach the main menu, use **⬆**, **⬇**, **⬅** or **➡** (**navigation keys**) to navigate the cursor and press **⓪** to select the function you wish to enjoy.



In this manual, the operation required to access functions is described by the operation of the navigation keys.

- | | | |
|---------------------------|-------------------|---------------------------|
| 1 SAT/
Profiles | 2 My Media | 3 Call
Register |
| 4 Messages | 5 t-zones | 6 Contacts |
| 7 Organiser | 8 Camera | 9 Settings |

Basic Key Operations

Soft keys and the centre key

Your handset uses soft keys (☺ and ☹) to help navigate the handset. At the bottom left and right side of the display, the respective operations of the keys are shown. The function of each soft key at any given time is displayed at the bottom left and right of the screen.

The function of the centre key is displayed in the centre by a graphical icon.

Example:

When ☹ [Back] is displayed:

Press ☹ [Back] to return to the previous menu.

When ☺ [Select] is displayed:

Press ☺ [Select] to select a menu item.

Navigation keys

⌂, ⏪, ⏩, ⏴, ⏵ indicate the navigation keys.

When you navigate the cursor to select an item, press ⌂, ⏪, ⏩ or ⏴ to highlight the item and press ⏵.

The end/power key

Press ⏴ to return to the standby screen.

Camera/Music key

Press 📷/🎵 to enter the "Create photo" mode (page 7-38).

Press and hold 📷/🎵 for approximately 2 seconds to activate "My Music" (page 12-110).

Font Zoom key

Press ⌂ to change the display font size.

By pressing the key, the display font size switches.



- To return to the previous menu, you can also press ☹ except when returning to the standby screen.
- To select an item in the menu, ☺ [Select] can be used instead of ⏵. Also, ☺ can be used to select an item when ▶ is displayed at the right side of the display.
- When selecting items using ⌂ or ⏪, ▲ and ▼ (scroll indicator) appear at the right edge of the display in case there are more menus that cannot be displayed at one time on the display.
- ⌂ may not be supported by some functions.

List of Menu Function Items

This table shows you the items in the function level (1st level), their respective menus (2nd level) and their page numbers.

Main Menu (1st level)	Sub Menu (2nd level) & Page No.
Profiles*	T-Mobile (page 15-136)
	My profile (page 15-136)
	Conference (page 15-136)
	Activity (page 15-136)
	In car (page 15-136)
Silent (page 15-136)	
SIM Application**	
My Media	Photos (page 12-86)
	Pictures (page 12-86)
	Sounds (page 12-96)
	Games & more (page 12-106)
	Videos (page 12-107)
	Music (page 12-110)
Memory status (page 12-113)	
Call Register	Missed calls (page 14-122)
	Received calls (page 14-122)
	Dialled numbers (page 14-122)
	Call timers (page 14-125)
	Call costs (page 14-125)
Data counter (page 14-127)	

Main Menu (1st level)	Sub Menu (2nd level) & Page No.
Messages	Create message (page 11-69)
	Inbox (page 11-74)
	Drafts (page 11-74)
	Sent (page 11-74)
	Outbox (page 11-74)
	Delete messages (page 11-78)
	Settings (page 11-79)
	Text templates (page 11-81)
	Voice mail (page 11-82)
	Memory status (page 11-83)
Cell Broadcasts (page 11-83)***	
Cell info (page 11-85)	
WAP Alerts (page 11-85)	
t-zones	(page 10-67)
Contacts	Contacts list (page 9-54)
	Speed dial list (page 9-65)
	My numbers (page 9-66)
Organiser	Calendar (page 13-114)
	Alarm (page 13-116)
	Calculator (page 13-119)
	Memo recording (page 13-120)
Phone help (page 13-121)	
Camera	Create photo (page 7-38)
	Create video (page 7-42)

Main Menu (1st level)	Sub Menu (2nd level) & Page No.
	Phone settings (page 15-128)
	Profiles (page 15-136)
	Memory card (page 3-20)
	Connectivity (page 15-143)
	Java™
Settings	Date & Time (page 15-151)
	Security (page 15-153)
	Account settings (page 15-158)
	Internet
	Favourites settings (page 15-162)
	Master reset (page 15-163)

- * If you insert a non SAT-compatible SIM card, the "SIM Application" does not appear and "Profiles" appears instead. For information on "Profiles" settings, refer to "Setting the Profiles" on page 15-136.
- ** If you insert a SAT-compatible SIM card, the information on the SIM card appears in the "SIM Application" menu. For information on the SIM card, contact your service provider.
- *** This menu may not be available depending on your SIM card.



Basic Handset Operations

This section describes basic phone call functions.
Confirm that the handset is on.

Making a Call

- 1 Open the handset and enter a phone number with the keypad.
- 2 Confirm the number and press .
Start talking when the connection is established.

If you enter a wrong number

Press  [Clear] to delete one digit. Press  [Clear] and hold for approximately 2 seconds to delete the last line. The handset returns to standby mode when all lines are deleted.



Ending a Call

Press  to end the call.





Closing the handset also ends a call. For information on the other operations when handset is closed, refer to "Settings for Flipping the Handset Closed" on page 15-146.

Answering a Call

- 1 The handset rings for an incoming call.
The handset vibrates when the vibration is set to "Enable" or "Link to sound." For information on the vibration setting, refer to "Setting the Vibration" on page 15-137.
- 2 Press  or  [Answer].
The call is connected and "" appears.

When the Any Key Answer Function is Activated

To answer a call, press any key except  or  [Busy]. For information on "Any Key Answer," refer to "Setting Any Key Answer" on page 15-142.

When the hands free EARphone & MIC is connected

To answer a call, press and hold the button of the hands free EARphone & MIC for approximately 2 seconds.



- When the Hands free EARphone & MIC is connected to the handset and the “Any Key Answer” function is set to “On,” you can answer calls by pressing the or key.
- When the handset is connected to Bluetooth headset and “Automatic answer” is set to “On,” the handset automatically connects the call after the specified time and you can talk to the caller. For information on “Automatic answer,” refer to “Setting the Automatic Answer” on page 15-142.
- When the handset is not connected to the hands free EARphone & MIC, press to activate hands free function.
- If your subscription includes the CLI (Calling Line Identification) service, the caller’s number appears on the screen. If the caller’s name and number are stored in the “Contacts list,” the caller’s name and phone number appear on the screen.
- When receiving a call from a person whose picture is registered in the “Contacts list,” the receiving display and the picture appear alternately. For more information on the “Contacts list” refer to “Using the Contacts List” on page 9-54.
- If the number is a restricted number, “withheld” appears.

Rejecting an Incoming Call

You can reject a call you do not wish to answer.

- 1 Press while the handset is ringing.



You can also reject an incoming call by closing the handset.

Redialling

The handset keeps a record of phone numbers for the 10 most recent missed, received or dialled calls. You can retrieve these phone numbers to make calls.

- 1 Press while the handset is in standby mode.
- 2 Press or to highlight a category from “Missed calls,” “Received calls” and “Dialled numbers.”
- 3 Press or to highlight the number you wish to call.
- 4 Press to redial the call.

Setting Automatic Redialling

This function makes the handset redial automatically when the first redial attempt is unsuccessful. For information on “Auto redial,” refer to “Activating Auto Redial” on page 15-145.

Useful Functions

Speed Dialling

Up to 9 phone numbers from the “Contacts list” memory (Handset and SIM) can be assigned to speed dials. You can call the numbers using the digit keys. For information on the “Speed dial list,” refer to “Setting the Speed Dial List” on page 9-65.

- 1 To dial a number using speed dial, press and hold any of the digit keys (to) and for approximately 2 seconds.

The phone number stored in the “Speed dial list” is dialled.



cannot be used as speed dial because it is already assigned to “Voice mail.”

Call Waiting

This service enables you to talk to a third party while you are in the middle of another call. After activating this service, a beep tone notifies you of the second call.

To activate this service, refer to “Activating the Call Waiting Service” on page 15-143.

- 1 During a call, press [Options].
The “Options” menu appears.

- 2 Press or to highlight “Hold & Answer” and press .
- The second party is put on hold and you can talk to the third party.

- 3 Press [Options].
The “Options” menu appears.

- 4 Press or to highlight “Swap calls” and press .
- You can switch between the two calls.







- 5 Press [Options].
The “Options” menu appears.

- 6 Press or to highlight “Release call” and press .
- The current call ends and return to the held call.



- *The call waiting service may not be available on all networks. Contact your service provider for more information.*
- *If you do not wish to answer the second call, press [Options] and press or to highlight “Busy,” then press in step 2.*

Accessing the SMS Menu During a Call

- 1 During a call, press  [Options].
The "Options" screen appears.
- 2 Press  or  to highlight "SMS" and press .
- 3 Press  or  to highlight one of following options.

Selecting "Create message":









allows you to create an SMS message.

Selecting "Inbox," "Sent" or "Drafts":

allows you to access these folders. For more information on the SMS message, refer to "Using the Message Service" on page 11-68.

Conference Call

This service enables you to call 2 people or more at the same time. You can talk with 5 participants at most with this service. To make a conference call, you must have one active call and one held call.

- 1 With one active call and one held call, press  [Options].
The "Options" menu appears.
- 2 Press  or  to highlight "Multiparty" and press .
- 3 Press  or  to highlight "Conference all" and press  to initiate the conference call.
You can talk with all the people on the line.
- 4 Press  to end the conference call.
The conference call ends.

To add new participants to the conference call

- 1 During the call, press \ominus [Options] and select "Dial."
- 2 Enter the phone number you wish to include in the conference call.
- 3 Press \ominus .
After the call is connected, continue from step 1 of "Conference Call" (page 6-35).
If you wish to include other participants in the conference call, perform the process again.

To put all the participants on hold

- 1 During the call, press \ominus [Options] and select in the following order:
"Multiparty" \rightarrow "Conference all."
- 2 Press \odot or \oslash to highlight "Conference hold all" and press \odot .

To reject adding participants

- 1 During the call, press \ominus [Options].
The "Options" menu appears.
- 2 Press \odot or \oslash to highlight "Busy" to send the busy tone and press \odot .

To put the current call on hold and continue having a conference call with the remaining participants

- 1 During the call, press \ominus [Options] and select in the following order:
"Multiparty" \rightarrow "Conference all."
- 2 Press \odot or \oslash to highlight "Exclude" and press \odot .

To end the call with all participants









- 1 During the call, press \ominus [Options] and select in the following order:
"Multiparty" \rightarrow "Conference all."
- 2 Press \odot or \oslash to highlight "Release all" and press \odot .

To end the call with a conference call participant

- 1 During a conference call, press \odot or \oslash to highlight the person that you wish to disconnect from the conference call.
- 2 Press \ominus [Options].
The "Options" menu appears.
- 3 Press \odot or \oslash to highlight "Release call" and press \odot .

To have a conversation with participants privately

When you wish to have a conversation with one of the participants privately, you can select a person from the conference list and put others on hold.

- 1 During a conference call, press  or  to highlight the person that you wish to talk in private with.
- 2 Press  [Options].
The "Options" menu appears.
- 3 Press  or  to highlight "Multiparty" and press .
- 4 Press  or  to highlight "Private" and press .
- 5 When you have finished the private conversation, continue from step 1 of "Conference Call" (page 6-35).



The conference call service may not be available on all networks. Contact your service provider for more information.

Using the Camera

This handset features a built-in camera capable of taking two million dots high-quality pictures. The camera lets you take pictures or video clips and features a digital zoom and auto focus functions. Once you've taken your picture or video, you can save it, then send it to others via MMS or E-mail message.

Taking Pictures

Using the Camera







- *By pressing Camera/Music key (page 4-22), you can enter the "Create photo" mode directly. In this case, start the operation from step 4.*
- *If you use the memory card (page 3-18), you can select a memory (handset memory or memory card) before taking pictures. For information on how to select a memory, refer to "Selecting the Memory" on page 7-45.*



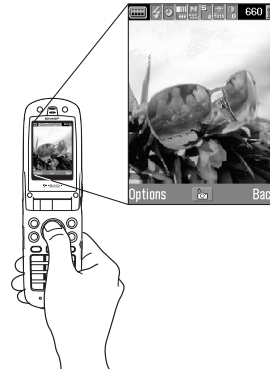

In "Create photo" mode, certain functions will be available only when the picture size is set to "Small" or "Tiny." For information on how to set the picture size in "Create photo" mode, refer to "Selecting the Picture Size" on page 7-39.

- 1 Press .
The main menu appears.
- 2 Press , , or to highlight "Camera" and press .
- 3 Press or to highlight "Create photo" and press .
- 4 Hold the camera as illustrated below.



- 5** Press .
The shutter sound is heard and the shot picture appears.
- 6** Press  to save the picture.
The picture is saved to "My photos."
Press  [Cancel] in this step. You can take the picture again.
If you wish to send the taken picture, refer to "Shooting and Sending a Picture/Video Function" on page 7-48.



- If you wish to leave "Create photo" mode without saving the taken picture, press  before step 6.
- While in "Create photo" mode, you can switch to "Create video" mode. Press  [Options] to display "Options" menu and select "Change to video mode," then press .









- This handset uses a CCD sensor. Although this handset has been manufactured carefully, some pictures may still appear too bright or too dark.
- If the handset has been left in a warm place for a long time before taking or registering a picture, the picture quality may be poor.
- Pictures taken with the camera may differ from the actual image of the subject in colour and brightness.

Selecting the Picture Size

Pictures are saved in JPEG format in the following six sizes.

2 M pixel:	1224 × 1632 dots
1 M pixel:	858 × 1144 dots
Large:	768 × 1024 dots
Medium:	480 × 640 dots
Small:	240 × 320 dots
Tiny:	120 × 160 dots

- 1 At the main menu, select in the following order: "Camera" → "Create photo."
- 2 Press  [Options].
The "Options" menu appears.
- 3 Press  or  to highlight "Photo size" and press .
- 4 Press  or  to highlight the picture size you wish to select and press .

Selecting the Picture Quality

- 1 At the main menu, select in the following order: "Camera" → "Create photo."
- 2 Press  [Options].
The "Options" menu appears.

- 3 Press or to highlight "Photo quality" and press .
- 4 Press or to highlight "Normal" or "Fine" and press .

Adjusting the Brightness of the Picture

- 1 At the main menu, select in the following order: "Camera" → "Create photo."
- 2 Press (brighter) or (darker) to adjust the brightness (exposure level) of the picture.



Return to the standby mode to reset the brightness setting to default.

Selecting the Shutter Sound

You can select the shutter sound from three preset patterns.

- 1 At the main menu, select in the following order: "Camera" → "Create photo."
- 2 Press [Options].
The "Options" menu appears.
- 3 Press or to highlight "Shutter sound" and press .

- 4 Press or to highlight the sound you wish to select and press .
- You can select from "Pattern 1," "Pattern 2" or "Pattern 3."
To play back the shutter sound, press [Play].

Viewing the Saved Pictures

You can review the pictures saved in "My photos."













- 1 At the main menu, select in the following order: "Camera" → "Create photo."
 - 2 Press [Options].
The "Options" menu appears.
 - 3 Press or to highlight "My photos" and press .
- The thumbnail index for saved pictures appears.
- 4 Press , , or to select the image you wish to view and press .
- The selected picture appears.



- *When you save pictures, the assigned file names are "YMMDDnnn.jpg" (YMMDD is Y (Year), M (Month), D (Day) and nnn is a 3 digit number).*
- *You can view the file name and size of your pictures in the thumbnail index.*

Selecting the Frame

You can select and set a frame from preset patterns or saved pictures.

- 1 At the main menu, select in the following order: "Camera" → "Create photo."
- 2 Press  [Options].
The "Options" menu appears.
- 3 Press  or  to highlight "Add frame" and press .
- 4 Press  or  to highlight "Preset frames" or "Off" and press .
If you do not wish to add a frame, select "Off."
- 5 Press , ,  or  to select the frame you wish to view and press .













- You can only select a frame when the picture size is set to "Small" or "Tiny."
- If you activate "Continuous shooting," you cannot set a frame.

Using Continuous Shooting

Four pictures are taken in succession. Auto shooting and manual shooting are available.

- 1 At the main menu, select in the following order: "Camera" → "Create photo."

- 2 Press  [Options].
The "Options" menu appears.
- 3 Press  or  to highlight "Continuous shooting" and press .
- 4 Press  or  to highlight "Auto shooting" or "Manual shooting" and press .
"Auto shooting": Four pictures are taken in a row by pressing .
"Manual shooting": Pictures are taken one by one by pressing .
 To cancel continuous shooting, select "Off" in this step.
- 5 Press  to start continuous shooting.
When the continuous shooting is finished, the pictures taken are saved automatically.
To end the function, press  [Cancel].



- You can only use the continuous shooting function when the picture size is set to "Small" or "Tiny."
- If you select a frame when taking pictures, you cannot use the continuous shooting function.

Shooting Video Images

You can record video clips with sound.



If you use the memory card (page 3-18), you can select a memory (handset memory or memory card) before recording video clips. For information how to select a memory, refer to "Selecting the Memory" on page 7-45.



Using the Camera

- 1 Press **OK**.
The main menu appears.
- 2 Press **Left**, **Right**, **Up** or **Down** to highlight "Camera" and press **OK**.
- 3 Press **Left** or **Right** to highlight "Create video" and press **OK**.
The video image appears in the display.

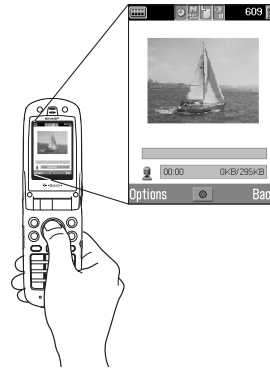

- 4 Hold the camera as illustrated below.



- 5 Press **OK**.
The sound indicating the start of video recording is heard and the recording starts.
If you press **OK** again, the recording stops and the sound indicating the end of video recording is heard.

- 6** Press  [Options] and select "Save" and press  to save the recorded video clip to "My videos." If you wish to send saved video clips, refer to "Sending Videos as Attachments" on page 12-108. If you wish to send the video clip, refer to "Shooting and Sending a Picture/Video Function" on page 7-48.









- While in "Create video" mode, you can switch to "Create photo" mode. Press  [Options] to display "Options" menu, select "Change to camera mode," then press .
- If you wish to record video clips without sound, press  [Options], select "Voice record" and set it "Off."









The maximum size of a video clip that can be recorded at one time is 295 kbytes.

Selecting Video Size



- 1** At the main menu, select in the following order: "Camera" → "Create video."
- 2** Press  [Options]. The "Options" menu appears.
- 3** Press  or  to highlight "Video size" and press .

- 4** Press  or  to highlight "Large" or "Small" and press .

Selecting Video Quality

- 1** At the main menu, select in the following order: "Camera" → "Create video."
- 2** Press  [Options]. The "Options" menu appears.
- 3** Press  or  to highlight "Video quality" and press .
- 4** Press  or  to highlight "Normal" or "Fine" and press .

Adjusting the Brightness of Video Clips















In "Create video" mode, press  (brighter) or  (darker) to adjust the brightness (exposure level) of video clips.





Return to the standby mode to reset the brightness setting to default.

Viewing Saved Video Clips

You can view saved video clips in “My videos.”

- 1 At the main menu, select in the following order: “Camera” → “Create video.”
- 2 Press  [Options].
The “Options” menu appears.
- 3 Press  or  to highlight “My videos” and press .
The thumbnail index for saved video clips appears.
- 4 Press , ,  or  to select the video clip you wish to playback and press .
- 5 Press .
The selected video clip is played back.
To pause playback, press .
To resume playback, press  again.
To stop playback, press  [Back].
- 6 After you have viewed the video clip, press  [Back].
The display returns to the thumbnail index.









- *When you save video clips, the assigned file names are “YMMDDnnn.3gp” (YMMDD is Y (Year), M (Month), D (Day) and nnn is a 3 digit number).*
- *The file name and size of your pictures are displayed in the thumbnail index.*
- *If the video clip has been recorded with sound, the volume can be adjusted by pressing  or .*
- *The volume depends on the “Ringing Volume” setting (page 15-136). The volume is 0 when “Ringing Volume” is set to “Silent” or “Step Tone.”*

Common Functions & Information

This section describes useful common functions you can use for both camera and video.







Selecting the Memory

If you use the memory card (page 3-18), you can select a memory (handset memory or memory card) before taking pictures or recording videos for the data storage.



- 7** At the main menu, select in the following order: "Camera" → "Create photo" or "Create video."
- 8** Press  [Options].
The "Options" menu appears.
- 9** Press  or  to highlight "Save to" and press .
- 10** Press  or  to highlight "Handset" or "Memory card" and press .



Selecting Focus Mode

You can select a focus mode from the following three alternatives.

- 1** At the main menu, select in the following order: "Camera" → "Create photo" or "Create video."
- 2** Press  [Options].
The "Options" menu appears.
- 3** Press  or  to highlight "Focus mode" and press .
- 4** Press  or  to highlight "Autofocus," "Semi-autofocus" or "Manual focus" and press .

Autofocus: Focus automatically by pressing .

Semi-autofocus: Once  is pressed, the focal length will be fixed. Press  again to take the picture with fixed focus.

Manual focus: By pressing , focal length can be changed. Press  to take the picture with the focus set manually.



Once you set "Semi-autofocus" in step 4, make sure that you have to press  twice to take a picture.

Using the Digital Zoom Function

- 1 At the main menu, select in the following order: “Camera” → “Create photo” or “Create video.”
- 2 Press to zoom in (the subject becomes larger) or press to zoom out (the subject becomes smaller.)

The zooming ratio indicators appear automatically when or is pressed and disappear when the key is released.

The available zooming steps depend on the camera settings.



The digital zoom function is not available when picture size is set to “2 M pixel” in “Create photo” mode.

Using the Delay Timer

- 1 At the main menu, select in the following order: “Camera” → “Create photo” or “Create video.”
- 2 Press [Options]. The “Options” menu appears.
- 3 Press or to highlight “Delay timer” and press .

- 4 Press or to highlight “On” and press . “” appears and returns to “Create photo/video” mode.
- 5 Press to start the delay timer. 10 seconds after the timer starts, the shutter sounds and the camera takes a picture or starts recording video.

To cancel the delay timer







- 1 Press [Options] while the delay timer setting is on. The “Options” menu appears.
- 2 Press or to highlight “Delay timer” and press .
- 3 Press or to highlight “Off” and press . The delay timer turns off.



- If is pressed while the delay timer is operating, the picture is taken immediately.
- If you wish to stop taking pictures with the timer, press [Cancel] while the delay timer is operating.

Using the Flash Light

When taking a picture or recording video in a dark place, you can use the Flash light.

- 1 At the main menu, select in the following order: "Camera" → "Create photo" or "Create video."
- 2 Press  [Options].
The "Options" menu appears.
- 3 Press  or  to highlight "Flash light" and press .
- 4 Press  or  to highlight "On" or "Off" and press .







Pressing  also activates the Flash light.



Changing the View Finder

You can use the external display as the view finder. This function is convenient for taking a self-portrait or a group picture.

- 1 At the main menu, select in the following order: "Camera" → "Create photo" or "Create video."

- 2 Press  [Options].
The "Options" menu appears.
- 3 Press  or  to highlight "Change viewfinder" and press .
The main display is turned off and the image through the camera lens appears in the external display and focus mode is set to "Autofocus."
When taking a picture or stopping a video recording, the view finder automatically switches to the main display.



You can also change the view finder by pressing  () in "Create photo/video" mode.

Shooting and Sending a Picture/Video Function



After taking a picture or recording video, you can send it directly from "Create photo/video" mode via MMS or E-mail message.

- 1 After taking a picture or recording video, press .





The "Send to" list appears.

When recording a video clip, options appear when pressing  to stop recording.

The last address where a message was sent is at the top of the list.

- 2 Press  or  to highlight the phone number or E-mail address of the recipient.

If you cannot find the phone number or E-mail address that you wish to send the picture to, select "Others..." and enter the necessary information.

- 3 Press .
Press  or  to highlight "Send" and press .
The message is sent.



When attaching a photo/picture file to a message, the size of the file is automatically reduced if exceeding the maximum (295 kbytes) size to send.



You can also send a voice memo after recording. For information on the voice memos, refer to "Using Memo Recording" on page 13-120.

Deleting Photo/Video Clips

For information on how to delete photos or video clips, refer to page 12-96 for deleting photos and page 12-109 for deleting video clips.

When the Memory Space is Low

When the available memory space in "My photos/My videos" is low, the remaining shots indicator in the upper left of the screen turns red. If the memory space becomes zero and when you try to take a photos again, "Memory full. You cannot take a picture!" ("Memory full. You cannot record a video!" in the "Create video" mode) appears.

Create Photo/Video Mode Indicators

Flash light indicator (page 7-47)

: On

Delay timer indicator (page 7-46)

: Indicates the delay timer is set.

Continuous shooting indicators (for the "Create photo" mode only) (page 7-41)

: Indicates pictures are taken in continuous shooting mode.

photo/video quality indicators (page 7-39, page 7-43)

Indicates the quality of the picture or video to be recorded.

: Normal





: Fine

Photo size indicators (for "Create photo" mode only) (page 7-39)

 2 M pixel: 1224 × 1632 dots

 1 M pixel: 858 × 1144 dots

 Large: 768 × 1024 dots

 Medium: 480 × 640 dots

 Small: 240 × 320 dots

 Tiny: 120 × 160 dots

Focus mode indicators (page 7-45)

: Autofocus

: Semi-autofocus

: Manual focus

Focusing bar

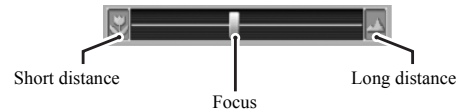

Photo/video brightness (exposure level) indicators (page 7-40, page 7-43)

 (+2): Bright

 (+1): ↓

 (±0): Normal

 (-1): ↓

 (-2): Dark

Remaining shots/Sets indicator

: Indicates that the remaining number of pictures is still over 1000.

123: Indicates the remaining number of photos or video clips that can be taken or recorded.

Memory indicators (page 7-45)

 : Indicates photos/videos are saved on handset memory.

 : Indicates photos/videos are saved on memory card.

Zooming ratio indicators (page 7-46)

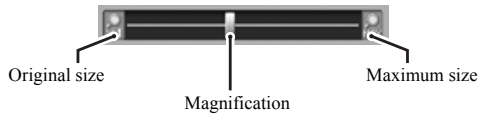

Voice record indicators (for "Create video" mode only) (page 7-43)

 : On

 : Off

Using the Camera

Entering Text

This section provides information on how to enter text using the handset keypad for contacts list entries and messages, etc. Before you try to enter text, you should familiarise yourself with the different text input methods. In multi-tap input method, several characters are assigned to each key and you enter the desired character by pressing the key a few times.

Text Table for Multi-tap Input

The table indicates how many times you need to press a certain key to display the character you wish to enter. Pressing the key changes the character in order as shown in the table. When you reach the last character, it returns to the first one.

Example: Press **[2=abc]** once. "A" appears. Press twice. "B" appears.

English Mode

Key	Upper Case Characters	Lower Case Characters	Numeric
[1=0]	. (full stop) , (comma) - (hyphen) ? ! ' (apostrophe) @ : 1		
[2=abc]	ABC2	abc2	2
[3=def]	DEF3	def3	3
[4=ghi]	GHI4	ghi4	4

Key	Upper Case Characters	Lower Case Characters	Numeric
[5=jkl]	JKL5	jkl5	5
[6=mno]	MNO6	mno6	6
[7=pqrs]	PQRS7	pqrs7	7
[8=tuv]	TUV8	tuv8	8
[9=wxyz]	WXYZ9	wxyz9	9
[0=space]	(space) += <> € £ \$ ¥ % & 0		0
[* + 0]	* + P?		

[# 00]	. , ? ! ; : - + # * @ ' " () _ & € £ \$ % / ~ < > § = \ ¥ ¿ ¡ ^ ^ [] { } □ Å Ä Æ å ä æ à Ç È é ê ì Ñ ñ Ö Ø ö ø ò ß Ü ü ù Δ Φ Γ Λ Ω Π Ψ Σ Θ ≡ (space) (return)
---------------	--

[0=space]-[9=xyz]: Press and hold to enter numbers 0-9.















[* + 0]: Press and hold to shift to sentence mode, Upper case, Lower case or Numeric (Abc, ABC, abc or 123).

[# 00]: Press and hold to shift between multi-tap and T9 mode.

Selecting the Input Method

T9 Text Input

T9 text input method is a shortcut to enter text easily and quickly.

- 1 In the text entry screen, press  [Options].
The “Options” menu appears.
- 2 Press  or  to highlight “Input method” and press .
- 3 Press  or  to highlight the T9 mode (T9 Abc, T9 ABC, T9 abc) you wish to select and press .
“T9” appears at the top of the display.
- 4 Press each key once for any letter on that key.
Example: To enter the word “How,” press   .
.
- 5 If the word shown isn’t the one you want, press  or  and highlight the correct one.
- 6 Press  to select the word.



If the correct word is not shown in step 5, enter the correct word again after switching to the multi-tap input method.









If you press  instead of step 6, a space is inserted next to the selected word.

Entering Symbols and Punctuation

To enter symbols or punctuation, press .











Selecting the Input Language

You can select the input language in the text entry screen.

- 1 In the text entry screen, press  [Options].
The “Options” menu appears.
- 2 Press  or  to highlight “Input language” and press .
- 3 Press  or  to highlight the language you wish to select and press .

Using Text Templates

You can use the sentences registered in "Text templates" when entering text. For information on how to create the text templates, refer to "Saving Phrases to the Text Template" on page 11-81.













- 1 In the text entry screen, press , ,  or  to move the cursor to the point you wish to insert the template.
- 2 Press  [Options].
The "Options" menu appears.
- 3 Press  or  to highlight "Text template" and press .
- 4 Press  or  to highlight the text template you wish to select and press .
The selected text template is inserted.

Copying, Cutting and Pasting Text

The options help you complete editing smoothly.

Copying and Cutting









- 1 When you are editing text, press  [Options].
The "Options" menu appears.

- 2 Press  or  to highlight "Copy" or "Cut" and press .
- 3 Press , ,  or  to move the cursor to the first letter to be copied or cut and press .
- 4 Press , ,  or  to move the cursor to the last letter to be copied or cut and press .



*"Cut" removes the information from its original location and relocates it when you use "Paste."
"Copy" leaves the information in its original location and makes another copy of the information when you use "Paste."*

Pasting

- 1 After the "Copy" and "Cut" operation, press , ,  or  to move the cursor to the point you wish to insert the letters and press  [Options].
The "Options" menu appears.
- 2 Press  or  to highlight "Paste" and press .

Using the Contacts List

In the “Contacts list,” you can store the phone numbers and E-mail addresses of your friends, family and colleagues, etc. Using “Contacts list,” you can dial or send messages easily without entering a phone number or an E-mail address manually.

Contacts List Basics

In the “Contacts list,” you can store up to 500 phone numbers and E-mail addresses. In each entry, you can store the following items.

Items stored in the handset memory

- Name:** Up to 30 characters
Phone number: Up to 40 digits, 3 phone numbers / entry
E-mail Address: Up to 60 characters, 2 addresses / entry
Group: Selectable from 8 groups
Address: Up to 100 characters
Note: Up to 60 characters
Thumbnail image: 1 image

Items stored in the SIM memory

- Name:** The number of characters that can be stored differs depending on the SIM card you use.
Phone number: Up to 40 digits



The capacity of the “Contacts list” differs when storing in your handset memory and when storing in the SIM card. For example, you cannot store a thumbnail image in the “Contacts list” in the SIM card.

Viewing the Contacts List

- 1 Press .
The main menu appears.
- 2 Press , , or to highlight “Contacts” and press .
- 3 Press or to highlight “Contacts list” and press .
The index view of the “Contacts list” appears.



You can also access the “Contacts list” by pressing while in standby mode.













The “Contacts list” stored in the handset is empty when you purchase the handset.

Selecting the Memory











You can store new entries in the “Contacts list.” Before saving new entries or viewing stored entries in the “Contacts list,” you can select the handset memory or the SIM card memory.

Selecting the Memory for saving







- 1 At the main menu, select in the following order: “Contacts” → “Contacts list.”
- 2 Press  [Options].
The “Options” menu appears.
- 3 Press  or  to highlight “Advanced” and press .
- 4 Press  or  to highlight “Save to” and press .
- 5 Press  or  to highlight “Handset,” “Selection” or “SIM” and press .

If you select “Selection,” you can select the memory (handset or SIM card) each time a new entry is saved. For information on how to select the memory when saving a new entry, refer to “Saving Information to the Contacts List” on page 9-56.

Selecting the Memory for viewing

- 1 At the main menu, select in the following order: “Contacts” → “Contacts list.”
- 2 Press  [Options].
The “Options” menu appears.
- 3 Press  or  to highlight “Advanced” and press .
- 4 Press  or  to highlight “Source” and press .
- 5 Press  or  to highlight “Handset,” “SIM” or “SIM + Handset” and press .

Saving Information to the Contacts List

- 1** At the main menu, select in the following order: "Contacts" → "Contacts list."
- 2** Press  [Options].
The "Options" menu appears.
- 3** Press  or  to highlight "Add new contact" and press .
The "New Entry" screen appears.
If you select "Selection" in step 5 of "Selecting the Memory for saving" (page 9-55), specify the memory (Handset or SIM) each time before making an entry.
When selecting "Handset entry":
Items you can enter are "Name," "Phone 1," "Phone 2," "Phone 3," "E-mail 1," "E-mail 2," "Group," "Address" and "Note."
When selecting "SIM entry":
Items you can enter are only "Name" and "Phone."
- 4** Press  or  to highlight the item you wish to enter and press .
The entry screen appears. For information on how to enter text, refer to "Entering Text" on page 8-51.







- 5** When you finish entering the information, press  [Save].



For information on items or the number of the characters you can enter in the handset or SIM card memory, refer to "Contacts List Basics" on page 9-54.

Adding a Phone Number from Call Register Entries

You can enter the phone numbers and names of the caller in the "Contacts list" from "Call Register" logs such as "Missed calls," "Received calls" or "Dialled numbers."

- 1** Display the "Call Register" log you wish to select from.
For information on "Call Registers," refer to "Using the Call History" on page 14-122.
- 2** Press  or  to highlight the number you wish to save in the "Contacts list" and press  [Options].
The "Options" menu appears.
- 3** Press  or  to highlight "Save to Contacts" and press .
- 4** Follow the steps from step 3 of "Saving Information to the Contacts List" to complete the operation.







Saving an Input Phone Number to the Contacts List

- 1 After you enter the phone number in standby mode, press  [Save].
- 2 Follow the steps from step 3 of "Saving Information to the Contacts List" (page 9-56) to complete the operation.

Dialling from the Contacts List

When dialling from the "Contacts list," display the index view of the "Contacts list" first.







Dialling from the Contacts List

- 1 At the main menu, select in the following order: "Contacts" → "Contacts list."
- 2 Press  or  to highlight the name you wish to call and press  to dial.
If there are two or more entries registered in the selected entry, press  or  to highlight the phone number you wish to call and press .
If no entries are found in the list, you can create an entry from the list. Press  [Options] and follow step 3 onward of "Saving Information to the Contacts List" (page 9-56).















If you cannot find the name you wish to dial or send messages to, follow the steps in "Searching a Name and Number in the Contacts List" (page 9-58).

Dialling from the Details Screen

- 1 At the main menu, select in the following order: "Contacts" → "Contacts list."
- 2 Press  or  to highlight the name which contains the phone number you wish to dial and press .
The detail screen appears.
- 3 Press  or  to highlight the phone number you wish to dial and press  to dial.







Sending Messages from the Details Screen

- 1 At the main menu, select in the following order: "Contacts" → "Contacts list."
- 2 Press  or  to highlight the name you wish to call and press .
The detail screen appears.
- 3 Press  or  to highlight the phone number or E-mail address of the recipient you wish to send a message to.
- 4 Press  [Options].
The "Options" menu appears.
- 5 Press  or  to highlight "Send message" and press .
- 6 Press  or  to highlight "via SMS," "via MMS" or "via E-mail" and press .

Using the Contacts List

Searching a Name and Number in the Contacts List

If you cannot find the name or number you wish to call at a glance in index view, you can search for it by entering the first few characters.

- 1 At the main menu, select in the following order: "Contacts" → "Contacts list."
- 2 Press  [Options].
The "Options" menu appears.
- 3 Press  or  to highlight "Search" and press .
- 4 Enter the first few characters of the name you wish to call.
Matched results appear in alphabetical order. If there is no exact entry in the "Contacts list," the similar names appear alphabetically.
- 5 Press  or  to scroll through the list for selecting the name you wish to call and press .
The detail screen of the "Contacts list" appears.



You can also dial by pressing  when the name you wish to call is highlighted in step 4.

Editing the Contacts List



If you cannot find the name you wish to edit, follow the steps in "Searching a Name and Number in the Contacts List" (page 9-58).

Editing a Contacts List Entry

- 1 At the main menu, select in the following order: "Contacts" → "Contacts list."
 - 2 Press or to highlight the name you wish to edit.
 - 3 Press [Options].
The "Options" menu appears.
 - 4 Press or to highlight "Edit" and press .
 - 5 Press or to highlight the item you wish to edit and press .
 - 6 When you have finished editing, press .
- If you wish to edit another item, repeat steps 5 and 6.

- 7 Press [Save].
The changes are saved.
If you do not wish to save the changes, press [Options] before step 7 and press or to highlight "Cancel," then press .

Adding a Thumbnail Image to Entries (for the handset entry only)

You can add a thumbnail image to entries in the handset memory.

- 1 At the main menu, select in the following order: "Contacts" → "Contacts list."
 - 2 Press or to highlight the entry you wish to add a thumbnail image to and press .
 - 3 Press [Options].
The "Options" menu appears.
 - 4 Press or to highlight "Caller ID" and press .
 - 5 Press or to highlight "My photos" or "My pictures" and press .
- The thumbnail list you selected appears.

- 6 Press , , or to highlight a thumbnail image you wish to add and press .
- 7 Press [Save] to add a thumbnail image to the entry.



- *Picture up to 150 kbytes can be added to entries as a thumbnail image.*
- *You cannot add thumbnail images to entries in the SIM Memory.*

To change the thumbnail image in the “Contacts list” entry

Select “Change” after step 4 and select “My photos” or “My pictures.”

To remove the thumbnail image in the “Contacts list” entry

Select “Remove” after step 4.



The “Options” menu items “Change” and “Remove” appear only when a thumbnail image is added to the selected entry.













If you delete an image added as a thumbnail in “My photos” or “My pictures,” the corresponding thumbnail image is also removed.

Setting the Ringtone for a Contacts List Entry (for the handset entry only)



You can set a ringtone or the vibration to a “Contacts list” entry in the handset memory.









- 1 At the main menu, select in the following order: “Contacts” → “Contacts list.”
- 2 Press or to highlight the name you wish to set and press .
The detail screen appears.
- 3 Press [Options].
The “Options” menu appears.
- 4 Press or to highlight “Ringtone” and press .
- 5 Press or to highlight “On” and press .
If you wish to cancel the ringtone setting, select “Off” in this step.
- 6 Press or to highlight “Assign melody” and press .
- 7 Press or to highlight “My sounds,” “My music” or “T-Mobile” and press .
The files in “T-Mobile” are preset data.

- 8** Press  or  to highlight the ringtone you wish to set and press  [Select].
For more information on how to select a ringtone, refer to "Setting a Melody as the Ringtone" on page 15-137.
- 9** Press  or  to highlight "Vibration" and press .
- 10** Press  or  to highlight "Enable," "Disable" or "Link to sound" and press .
For information on how to set the vibration, refer to "Setting the Vibration" on page 15-137.
- 11** When setting is complete, press  [Back] and  [Save].

Copying Entries Between Memories

You can copy entries between the handset and SIM card memories. This function is useful when you wish to backup entries or organise your memory space. Before copying, make sure which memory's entries are displayed on the display.

- 1** At the main menu, select in the following order: "Contacts" → "Contacts list."
- 2** Press  or  to highlight the name which you wish to copy to another memory.









- 3** Press  to display the detail screen and press  or  to highlight the phone number you wish to copy.
 - 4** Press  [Options].
The "Options" menu appears.
 - 5** Press  or  to highlight "Copy to SIM" to copy the entry to the SIM card or "Copy to handset" to copy the entry to the handset memory and press .
- The name and the phone number selected in step 2 are copied to the other memory.
If you select "Copy to SIM," the message "Some data may be lost. OK?" appears. Press  [Yes] to complete the operation.



Even if multiple phone numbers are registered to one name, you can copy only one phone number per name to the SIM card.











Copying All Entries from the SIM Card to the Handset Memory

You can copy all entries from the SIM card to the handset memory at once. This function is useful when you restore the handset memory with the backup copy in the SIM Card.

- 1 At the main menu, select in the following order: "Contacts" → "Contacts list."
- 2 Press  [Options].
The "Options" menu appears.
- 3 Press  or  to highlight "Advanced" and press .
- 4 Press  or  to highlight "Copy all from SIM" and press .
- 5 Press  [Yes].
If you wish to cancel, press  [No] in this step.

Using the Contacts List



Swapping the Location Number of the Phone Number (for SIM card entries only)







- 1 At the main menu, select in the following order: "Contacts" → "Contacts list."
- 2 Press  or  to highlight the desired name and press .
- 3 Press  or  to highlight the desired phone number and press  [Options].
The "Options" menu appears.
- 4 Press  or  to highlight "Swap" and press .
- 5 Enter the location number you wish to swap and press .

Deleting a Contacts List Entry



If you cannot find the desired name, follow the steps in "Searching a Name and Number in the Contacts List" (page 9-58).

- 1 At the main menu, select in the following order: "Contacts" → "Contacts list."
- 2 Press  or  to highlight the name you wish to delete.







- 3** Press  [Options].
The "Options" menu appears.
- 4** Press  or  to highlight "Delete" and press .
- 5** Press  [Yes].
If you wish to cancel, press  [No] in this step.









Once you delete a "Contacts list" entry, it cannot be restored.

Deleting All Contacts List Entries

You can delete all entries in the "Contacts list." Before deleting all "Contacts list" entries, ensure that you are accessing the memory you wish to delete. For information on how to select the memory for "Contacts list" entries, refer to "Selecting the Memory" on page 9-55.

- 1** At the main menu, select in the following order: "Contacts" → "Contacts list."
- 2** Press  [Options].
The "Options" menu appears.
- 3** Press  or  to highlight "Advanced" and press .
- 4** Press  or  to highlight "Delete all entries" and press .

- 5** Enter your handset code and press .
- For information on the handset code, refer to "Enabling the Handset Lock" on page 15-154.
- 6** Press  or  to highlight "Handset entries" or "SIM entries" and press .
- 7** Press  [Yes].
If you wish to cancel, press  [No] in this step.









Once you delete all entries in the "Contacts list," they cannot be restored.

Setting the Groups

You can set group icons when saving the "Contacts list" entries to the handset memory so that you can easily find and edit them.

Viewing Groups

- 1** At the main menu, select in the following order: "Contacts" → "Contacts list."
- 2** Press  [Options].
The "Options" menu appears.
- 3** Press  or  to highlight "Group" and press .
- 4** Press  or  to highlight "View groups" and press .

- 5** Press or to highlight the group name you wish to hide/view and press . The check box indicates that the group has been selected.



In step 5, press [Options] to display the "Options" menu and select "Select current only" to view only the selected group or "Select all" to view all groups.

Group Call





You can set different ringtones for each group. When you purchase this handset, groups are set to off. If you do not set a group ringtone, the ringtone assigned in "Profiles" is used. For information on "Profiles," refer to "Setting the Profiles" on page 15-136.

- 1** At the main menu, select in the following order: "Contacts" → "Contacts list."
- 2** Press [Options]. The "Options" menu appears.
- 3** Press or to highlight "Group" and press .
- 4** Press or to highlight "Group call" and press .
- 5** Press or to highlight the group name you wish to set and press .

- 6** Press or to highlight "On" and press . If you wish to cancel the ringtone setting, select "Off" in this step.
- 7** Press or to highlight "Assign melody" and press .
- 8** Press or to highlight "My sounds," "My music" or "T-Mobile" and press . The files in "T-Mobile" are preset data.
- 9** Press or to highlight the ringtone you wish to set and press [Select]. For more information on how to select a ringtone, refer to "Setting a Melody as the Ringtone" on page 15-137.
- 10** Press or to highlight "Vibration" and press .
- 11** Press or to highlight "Enable," "Disable" or "Link to sound" and press . For information on how to set the vibration, refer to "Setting the Vibration" on page 15-137.

Memory Status

You can check the number of entries registered in the "Contacts list."

- 1 At the main menu, select in the following order: "Contacts" → "Contacts list."
- 2 Press  [Options].
The "Options" menu appears.
- 3 Press  or  to highlight "Memory status" and press .
You can check the memory status of the handset memory and SIM card.













Setting the Speed Dial List

You can set a maximum of 9 phone numbers in the "Speed dial list."



For information on making a call with Speed dialling, refer to "Speed Dialling" on page 6-34.

Setting Contacts List entries in the Speed Dial List





- 1 At the main menu, select in the following order: "Contacts" → "Contacts list."
- 2 Press  or  to highlight the name you wish to add to the "Speed dial list" and press .
The "Contacts list" screen appears.
- 3 Press  or  to highlight the phone number you wish to add to the "Speed dial list" and press  [Options].
The "Options" menu appears.
- 4 Press  or  to highlight "Add to Speed dial" and press .
- 5 Press  or  to highlight the Speed dial number you wish to set and press .



The nine digit keys correspond to list numbers.

Checking Own Numbers

You can check your own voice, data and fax phone numbers.

- 1 At the main menu, select “Contacts.”
- 2 Press  or  to highlight “My numbers” and press .
- 3 Press  or  to highlight “Voice,” “Data” or “Fax.”

The phone number you wish to check appears.



- “Voice,” “Data” or “Fax” may not be displayed depending on the SIM card.
- Also the terms and the numbers of the records displayed in the display for “Voice,” “Data” or “Fax” may differ depending on the SIM card.
- If your number is not saved on your SIM card, you can enter it yourself. (Certain SIM cards do not support this function.)

Using the Contacts List

Accessing “t-zones”

The handset is already designed to access the “t-zones” multimedia services from T-Mobile and receive information from the service.

“t-zones” is your gateway to entertainment, information and excitement. For accessing “t-zones” and mobile Internet surfing, the handset has the browser (WAP) preinstalled. Through the browser, you can get useful information and data. Web pages you can access and view are designed for handset configurations.



If you have any problems connecting to this network, call your network operator.

Viewing the Browser

Press  while the handset is in standby mode.

The handset starts to access the “t-zones” site.

 can also be used while the handset is in the main menu or 2nd level menu.

Navigating a Web Page

   :

Navigate the highlights on the screen.

:

Performs the option displayed in the lower centre of the screen.

:

Launches the browser option menu.

:

Selects an action displayed in the lower left corner of the screen.

 (short press):

Exit the browser.

Using the Message Service

This section provides information on how to create, send, receive and read messages using the handset. With the handset, you can send and receive not only text messages but also messages with pictures, sounds or videos. Pictures taken and sounds and video clips recorded with the handset can be sent to other handsets or e-mail addresses for viewing if they have the same media playback capability.

Message Types Available with the Handset

With the handset, three types of messages are available.

SMS (Short Message Service): This service enables you to send text only messages of up to 1024 characters to other users. You can send or receive messages even if you are talking on the handset. Also text templates are available to help you compose messages.

MMS (Multimedia Message Service): Your handset is already enabled to deal with file attached messages. You can send messages with graphical images, photographs, sounds or video clips attached, and receive Browser (WAP) alerts.

E-Mail: This function enables you to directly access the E-mail messaging service for your Internet service provider. You can also send or receive files through the

service. For information on how to set up your E-mail function, refer to "Setting an Account" on page 15-158.



- *When sending an SMS message, messages exceeding 160 characters are divided during the sending process. If the recipient uses a compatible handset, divided messages are recombined and delivered as one message. If sent to a non-compatible handset, messages are divided into 152 character lots and delivered separately.*
- *When sending an MMS message, the size of the message that can be sent is up to 295 kbytes.*
- *Some messaging functions may not be available, depending on the network service you use. If you experience any problems using these services, contact your service provider for details.*

Creating and Sending Messages

Basic Operation

The following steps show you the basic way to create and send messages.

- 1 Press .
The main menu appears.
- 2 Press , , or to highlight "Messages" and press .
The "Messages" menu appears.
- 3 Press or to highlight "Create message" and press .
- 4 Press or to highlight "SMS," "MMS" or "E-mail" and press .
- 5 Enter the phone number or E-mail address of the destination you wish to send the message to and press .
If you are sending an SMS message:
You can only enter a phone number.
If you are sending an MMS message:
You can enter either a phone number or an E-mail address.
If you are sending an E-mail message:
You can only enter an E-mail address.

In step 5, you can use several useful optional functions for selecting a destination or reselecting message type, etc. For information on these functions, refer to "Address Options" on page 11-70.

- 6 Enter your message.
For information on how to enter text, refer to "Entering Text" on page 8-51.
In step 6, you can use several useful optional functions such as using text templates or attaching files to the message, etc. For information on these functions, refer to "Message Options" on page 11-71.



You can check the message length at the top right of the message screen to figure out how many more characters you can enter.

- 7 When you have finished writing the message, press .
- 8 Press or to highlight "Send" and press .
The handset starts to send the message. After sending the message, the message is listed in the "Sent" box.
If you wish to save the message in the "Drafts" box, select "Save to Drafts."



- *When sending SMS message of more than 160 characters, a confirmation message appears. Press [Yes] to send or [No] to cancel.*
- *If the MMS or E-mail messages cannot be sent for some reason, the message stays in the "Outbox" and [Outbox] is displayed on the standby screen.*

Address Options

In step 5 of "Basic Operation" (page 11-69), you can use following useful optional functions.

To select a destination from "Contacts list"

- 1 Press [Options] (or press [V]) in step 5. The "Options" menu appears.
- 2 Press [Up] or [Down] to highlight "Contacts list" press [Enter].
The "Contacts list" appears and you can search for the phone number entering only the first few characters. For information on how to search "Contacts list" entries, refer to "Searching a Name and Number in the Contacts List" on page 9-58.

To select a destination from "History"

In "History," the last 8 destinations sent using messages (SMS, MMS or E-mail messages) are recorded.

- 1 Press [Options] in step 5. The "Options" menu appears.
- 2 Press [Up] or [Down] to highlight "History" press [Enter]. The destination list appears.
- 3 Press [Up] or [Down] to highlight the destination you wish to send the message to and press [Enter].
If you wish to delete one of the destinations from the list, press [Options] and select "Delete" and press [Enter].



To reselect the message type



After selecting "SMS," "MMS" or "E-mail message" in step 4 of "Basic Operation" (page 11-69), you can change to another type of message later on.

- 3 Press [Options]. The "Options" menu appears.
- 4 Press [Up] or [Down] to highlight "Change to SMS," "Change to MMS" or "Change to E-mail" and press [Enter].
The message type is reselected. Follow the operation from step 6 of "Basic Operation" on page 11-69.

To add recipients to the message

- 1 After entering a destination, press [Options]. The "Options" menu appears.

2 Press  or  to highlight "Add another contact" and press .

3 Press  or  to highlight "To," "Cc" or "Bcc" and .

If you are sending an SMS message, only the "To" list screen appears. If you are sending an MMS message, you cannot select "Bcc."

4 Enter the phone number or E-mail address of the additional recipient and press .

If you are sending an SMS message, select a blank line from the "To" list and enter a phone number.

5 When adding recipients is complete, press  [Back].



You can enter up to 60 characters for "To," "Cc" or "Bcc." This may be limited depending on your service provider. Contact your service provider if you have a problem sending mail.





Message Options



In step 6 of "Basic Operation" (page 11-69), you can use following useful optional functions.



To use the text templates

The text templates you have created and stored in the handset are also available when creating messages. For

information on how to create text templates, refer to "Making Text Templates" on page 11-81.

1 When making a message in any message type ("SMS," "MMS" or "E-mail"), press , ,  or  to move the cursor to the point you wish to insert the text template, and press  [Options].

2 Press  or  to highlight "Text template" and press .

3 Press  or  to highlight the template you wish to enter from the list and press .

















You can continue to make the message. If you wish to end the message, go to step 7 of "Basic Operation" on page 11-69.

To attach data (for MMS and E-mail only)

You can send photos, pictures, sounds and video clips by attaching them to MMS or E-mail message.



- When attaching video clips, "Slide show" is automatically set to "Off."
- NVA (e-Animation file), AAC and MP3 cannot be attached to the message.
- When attaching a photo/picture file to a message, the size of the file is automatically reduced if exceeding the maximum (295 kbytes) size to send.









- 1** In step 6, of “Basic Operation” (page 11-69), press  [Options].
The “Options” menu appears.
- 2** Press  or  to highlight “Attach” and press .
- 3** Press  or  to highlight “Photo,” “Picture,” “Sound,” “Video” or “Music” and press .
The list of “My photos,” “My pictures,” “My sounds,” “My videos” or “My music” appears.
- 4** Press  or  to highlight the file you wish to attach and press .
The selected picture, sound or video clip is attached.
- 5** Press  to return to the message edit screen.
If you wish to remove the attached data, press  or  to highlight the file name you wish to remove and press  [Options]. Press  [Yes] to remove or press  [No] to cancel.

To send a message using the message template (for MMS only)

You can send message templates with an image and voice attached.





- 1** In step 6 of “Basic Operation” (page 11-69), press  [Options].
The “Options” menu appears.

11-72

- 2** Press  or  to highlight “Message template” and press .
“Discard message?” appears. Press  [Yes] to go to next step or press  [No] to go back to text editor.
- 3** Press  or  to highlight a template you wish to send and press .

To Create the slide show (for MMS only)

This function enables you to create messages that have up to 10 slides. Each slide can contain one picture, one sound file and up to 1000 characters (up to the message total of 295 kbytes.)





- 1** In step 6 of “Basic Operation” (page 11-69), press  [Options].
The “Options” menu appears.
- 2** Press  or  to highlight “Slide control” and press .
The options available for the slide are:
Add: Add a new slide.
Remove: Remove the active slide.
Previous: Navigate to the previous slide.
Next: Navigate to the next slide.



- *Video clip data cannot be attached to the message as slide data.*
- *If you select "Off," you can attach 20 pictures, sounds or video clips up to 295 kbytes in total.*
- *To enable the slide show you must set "On" in the "Slide show" setting. For information on the "Slide show" setting, refer to "Settings for the Messages" on page 11-79.*

To add the subject of the message (for MMS and E-mail only)

You can add a subject for the message before sending.





- 1** After entering a message, press  in step 6 of "Basic Operation" (page 11-69).
- 2** Press  or  to highlight "Subject" and press .
- 3** Enter the subject of the message and press .



You can enter up to 40 characters as the subject. This may be limited depending on your network service. Contact your service provider if you have problem sending mail.

To preview the message before sending (for MMS and E-mail only)

You can preview the message before sending.







- 1** After entering a message, press  in step 6 of "Basic Operation" (page 11-69).
- 2** Press  or  to highlight "Preview message" and press .

To reselect the message type

You can change to another message type in step 6 of "Basic Operation" (page 11-69).

For information on reselecting message type, refer to "To reselect the message type" on page 11-70.

Sending a Message from the Drafts Box

- 1** At the main menu, select in the following order: "Messages" → "Drafts."
- 2** Press  or  to highlight the message you wish to send and press  [Options]. The "Options" menu appears.
- 3** Press  or  to highlight "Send" and press . If you wish to modify the message, press "Edit message" instead of selecting "Send" in this step.



Receiving and Reading Messages

Receiving Messages

When the handset is within the service area, SMS and MMS messages are automatically received and saved in the "Inbox." Meanwhile, you need to operate manually to receive E-mail messages held at the service provider. For information on how to receive E-mail messages, refer to "To receive E-mail messages."

Also, you may need to download MMS messages manually. For information on how to download MMS messages manually, refer to "To retrieve a message (for MMS only)" on page 11-78.

When receiving messages, the following indicators appear at the top of the standby screen depending on the type of the received message.

SMS:  **MMS:**  **E-mail:** 



When you receive an SMS message, the sender's phone number and a part of the message appears. When the sender's phone number is stored in the "Contacts list," the sender's name appears instead of the phone number.

11-74



- A message with "" (SMS message), "" (MMS) or "" (MMS with attachment) icon indicates an unread message.
- If the "Inbox," "Sent" or "Drafts" box is full, a red icon is displayed. Delete unwanted messages. For information on how to delete messages, refer to "Deleting Messages" on page 11-78.

To receive E-mail messages

- 1 At the main menu, select in the following order: "Messages" → "Inbox."
"New E-mail check" appears. If you select ☹ [Yes], the messages are delivered.
For information on "Check confirmation," refer to "The E-mail message settings" on page 11-80.

Reading Messages

Choose message in the "Inbox" to read the received messages.





- 1 At the main menu, select in the following order: "Messages" → "Inbox."
MMS messages marked with a clip denote messages with attachments.
- 2 Press ⬆ or ⬇ to highlight the message you wish to read and press ⬅.
- 3 Press ⬆ or ⬇ to scroll through the message.

- When you have finished reading the message, press  [Back].

Replying and Forwarding Messages

You can reply to the sender of a received message or forward the received message to another destination. Also, you can modify the received message when replying or forwarding. You can also call the sender of the message using the phone number contained in the message.

To reply to a message







- After reading a message or selecting a message in "Inbox," press  [Options].
The "Options" menu appears.
- Press  or  to highlight "Reply" and press .
- Enter your message.
For information on how to enter text, refer to "Entering Text" on page 8-51.
- Press  and select "Send."



If you wish to reply to all addresses on an MMS or E-mail message, select "Reply All" in step 3.

To forward a message

- At the main menu, select in the following order: "Messages" → select "Inbox" or "Sent."

- Press  or  to highlight the message you wish to forward.
 - Press  [Options].
The "Options" menu appears.
 - Press  or  to highlight "Forward" and press .
 - Enter the phone number or E-mail address of the recipient and press .
- If you wish to select the phone number (for SMS and MMS message) or E-mail address (for MMS and E-mail message) in the "Contacts list," refer to "Searching a Name and Number in the Contacts List" on page 9-58.



- When you forward a message, the attached data is also sent to the recipient. However, the handset will not send AAC, MP3 and any data it recognises as having copyrights.*
- The "Subject" field is automatically filled with the original subject preceded by "Fw.:" The original message cannot be changed.*

To call the sender

You can call the sender of an SMS or MMS message in the "Inbox" whose address (From) is the phone number.

- 1 At the main menu, select in the following order: "Messages" → "Inbox."
- 2 Press or to highlight the message from the sender you wish to call and press [Options]. The "Options" menu appears.
- 3 Press or to highlight "Call sender" and press .

To extract the phone number from the received message

You can call using phone number contained only in the received SMS message.

- 1 At the main menu, select in the following order: "Messages" → select "Inbox," "Drafts" or "Sent."
- 2 Press or to highlight the message that contains the phone number you wish to extract and press .
- 3 Press [Options]. The "Options" menu appears.

- 4 Press or to highlight "Extract numbers" and press .
Phone numbers embedded in the message appear.
- 5 Press [Options].
- 6 Press or to highlight "Call" and press .
The handset starts to call the number.



If you select "Send via SMS/MMS" in step 6, you can use the number to make message. If you select "Save to Contacts," you can save the number in the "Contacts list."

Modifying a message

You can modify an original message you made before or after sending it if the message you wish to modify is in the "Drafts," "Sent" or "Outbox."

- 1 At the main menu, select in the following order: "Messages" → "Drafts," "Sent" or "Outbox."
- 2 Press or to highlight a message you wish to modify.
- 3 Press [Options].
The "Options" menu appears.
- 4 Press or to highlight "Edit message" and press .
- 5 Modify the message and press .



- You can also modify received messages when replying or forwarding them. For information on how to reply or forward messages, refer to “Replying and Forwarding Messages” on page 11-75.
- You cannot modify a “Slide show” message that is created on another handset.

Saving the Phone Number or E-mail Address of a Sender

- 1 At the main menu, select in the following order: “Messages” → select “Inbox,” “Drafts,” “Sent” or “Outbox.”
- 2 Press or to highlight the message from the sender you wish to save.
- 3 Press [Options].
The “Options” menu appears.
- 4 Press or to highlight “Save to Contacts” and press .
For information on how to enter name and other information, refer to “Saving Information to the Contacts List” on page 9-56.

To check sender/receiver information (for MMS and E-mail only)

- 1 At the main menu, select in the following order: “Messages” → select “Inbox,” “Drafts,” “Sent” or “Outbox.”
- 2 Press or to highlight the message you wish to check and press [Options].
The “Options” menu appears.
- 3 Press or to highlight “Details” and press .
The sender’s or receiver’s phone number or E-mail address, time and date stamp, subject and size appear.

To resend a message in the Outbox

- 1 At the main menu, select in the following order: “Messages” → “Outbox.”
- 2 Press or to highlight the message you wish to resend and press [Options].
The “Options” menu appears.
- 3 Press or to highlight “Re-send” and press .

To lock messages (for MMS and E-mail only)

MMS and E-mail messages can be locked so they are not deleted by accident.

- 1 At the main menu, select in the following order: "Messages" → select "Inbox" or "Sent."
- 2 Press or to highlight the message you wish to lock or unlock and press [Options]. The "Options" menu appears.
- 3 Press or to highlight "Lock/Unlock" and press .

To retrieve a message (for MMS only)

- 1 At the main menu, select in the following order: "Messages" → "Inbox."
- 2 Press or to highlight the alert you wish to download.
- 3 Press [Options]. The "Options" menu appears.
- 4 Press or to highlight "Download" and press .



You can press to start downloading instead of steps 3 and 4.

Using the Message Service

11-78

Deleting Messages

Deleting a message

- 1 At the main menu, select in the following order: "Messages" → select "Inbox," "Drafts," "Sent" or "Outbox."
- 2 Press or to highlight the message you wish to delete and press [Options]. The "Options" menu appears.
- 3 Press or to highlight "Delete" and press .

Deleting messages by message type

If you wish to delete all of a certain type of message in a box at one time, the following deleting option meets the need.

- 1 At the main menu, select in the following order: "Messages" → "Delete messages."
 - 2 Press or to highlight "Inbox," "Sent," "Drafts" or "Outbox" and press .
- Each delete option is categorised by message type. Select one of menu items (SMS, MMS or E-mail) and press to delete all messages of a certain selected type.



If you wish to delete all messages in a certain box, select "All Inbox/Drafts/Sent/Outbox messages."

Deleting All messages

If you wish to delete all messages in "Inbox/Drafts/Sent/Outbox" at one time, perform the following operation.

- 1 At the main menu, select in the following order: "Messages" → "Delete messages."
- 2 Press or to highlight "All messages" and press .



Once you have deleted messages, they cannot be restored.



You cannot delete locked messages. For information on how to lock messages, refer to "To lock messages (for MMS and E-mail only)."

Settings for the Messages

The steps below are instructions on SMS, MMS and E-mail message settings.

- 1 Press .
The main menu appears.
- 2 Press , , or to highlight "Messages" and press .
The "Messages" menu appears.
- 3 Press or to highlight "Settings" and press .
- 4 Press or to highlight "SMS" or "MMS message" and press .

The SMS message settings

After step 4 of "Setting for the Messages," set the following items.

When you finish making settings, press [Back].

Message centre:

Enter the message centre number to enable the service.

Message lifetime:

Set the time span that the message service centre continually tries to send the message to the recipient you specified.

Message format:

Select a message format from the 7 choices.

Connection type:

Select a connection type.

Optimisation:

Converts double-byte characters (such as European characters with an accent) into single-byte characters before sending the message. Note that you may be charged double for sending double-byte character messages.

The MMS message settings

After step 4 of "Setting for the Messages," set the following items.

When you finish making settings, press  [Back].

Account setting:

Refer to "Setting an Account" on page 15-158.

Home network:

Defers MMS message downloads when you use your home network.

Roaming download:

Defers MMS message download when roaming outside of your network.

Allow delivery report:

Enables "Delivery report" when receiving a message that applies to the "Delivery report" function.

Anonymous reject:

Rejects messages from unknown or empty addresses.

Auto delete:

Deletes the oldest message automatically when the "Sent" box is full.

Slide show:

Enables slide show when sending a message.

Advanced:

- Priority: prioritises composed messages.
- Delivery report: enables delivery report.
- Expiry time: sets the expiry time for messages stored in the server.
- Slide interval: sets the slide display time when sending a message.

The E-mail message settings**Account settings:**









Refer to "Setting an Account" on page 15-158.

Check confirmation:

Select "Inbox" and Check your new E-mail.





Making Text Templates

You can register up to 20 text templates for frequently used text on the handset.





- 1 Press .
The main menu appears.
- 2 Press , ,  or  to highlight "Messages" and press .
- 3 Press  or  to highlight "Text templates" and press .
The list of the text templates appear.

Saving Phrases to the Text Template







120 characters may be saved in any text template.

- 1 At the main menu, select in the following order: "Messages" → "Text templates."
- 2 Press ,  to highlight the item you wish to register and press .
- 3 Enter the text and press .
For information on how to enter text, refer to "Entering Text" on page 8-51.

Editing Text Templates

- 1 At the main menu, select in the following order: "Messages" → "Text templates."
The list of the text templates appear.
- 2 Press  or  to highlight the item you wish to edit and press .
- 3 Edit the text template and press .
For more information on how to enter text, refer to "Entering Text" on page 8-51.









Viewing Text Templates

- 1 At the main menu, select in the following order: "Messages" → "Text templates."
- 2 Press  or  to highlight the item you wish to view and press  [Options].
The "Options" menu appears.
- 3 Press  or  to highlight "View" and press .
The selected text template is displayed.
When you have finished confirmation, press  [Back].



You cannot edit the text template in step 3.

Deleting Text Templates

- 1 At the main menu, select in the following order: "Messages" → "Text templates."
- 2 Press  or  to highlight the item you wish to delete and press  [Options]. The "Options" menu appears.
- 3 Press  or  to highlight "Delete" and press .
- 4 Press  [Yes].
The selected text template is deleted.
If you wish to cancel deletion, press  [No] in this step.















Once you delete the text template, it cannot be restored.

Using the Message Service



Using Voice Mail

You can use the voice mail service depending on the service provider you use. For information on the voice mail service, contact your service provider.

Calling Voice Mail









- 1 Press .
The main menu appears.
- 2 Press , ,  or  to highlight "Messages" and press .
- 3 Press  or  to highlight "Voice mail" and press .
- 4 Press  or  to highlight "Call Voice mail" and press .

Setting Voice Mail

- 1 At the main menu, select in the following order: "Messages" → "Voice mail."
- 2 Press  or  to highlight "Voice mail setting" and press .

Memory Status

This function helps you to check the memory status of "Messages."















- 1 Press .
- 2 The main menu appears.
- 3 Press , ,  or  to highlight "Messages" and press .
- 4 Press  or  highlight "Memory status" and press .
The memory status is indicated by using bar chart.

Setting Cell Broadcasts





This setting enables you to receive cell broadcast messages such as weather forecasts and traffic reports. If you are in a certain network area, your handset receives the broadcast information for your subscription.



This menu may not be available with some mobile networks. Contact your service provider for details.













- 1 Press .
- The main menu appears.
- 2 Press , ,  or  to highlight "Messages" and press .
- The "Messages" menu appears.
- 3 Press  or  to highlight "Cell Broadcasts" and press .
- The "Cell Broadcasts" menu appears.
- 4 Press  or  to highlight "On/Off" and press .
- 5 Press  or  to highlight "On" to set the Cell Broadcasts on or "Off" to set it off and press .

Reading Cell Broadcast Messages

- 1 When you receive a cell broadcast message, press .
A popup is displayed over the standby screen.
- 2 Press  or  to scroll through the message.
- 3 When you finish reading, press .

Subscribing to Cell Broadcasts

Select the page of the cell broadcast message that you want.

- 1 At the main menu, select the following order: "Messages" → "Cell Broadcasts."
- 2 Press  or  to highlight "Settings" and press .
- 3 Press  or  to highlight "Set info subjects" and press .
- 4 Press  or  to highlight "Add/Remove" and press .
- 5 Press  or  to highlight the page you wish to view and press .
When you have finished viewing, press  [Back].















- You can set a maximum of four subjects for subscription in step 5.
- When you cannot find the page you wish to view in the list that appears in step 5, select "Create subject" in step 4 and enter the subject code to add a page. For details on the subject code, contact your service provider.

Setting Cell Info

Cell info is the message information that operators send to subscribers in certain areas. When you receive cell info, the message (network info) is displayed on the standby screen.

 *This function may not be available on all phone networks. Contact your service provider for more information.*

Enabling/Disabling Cell Info



- 1 Press .
The main menu appears.
- 2 Press , ,  or  to highlight "Messages" and press .
The "Messages" menu appears.
- 3 Press  or  to highlight "Cell info" and press .
The "Cell info" menu appears.
- 4 Press  or  to highlight "On" or "Off" and press .

 *If cell info is set to "On," the standby time will decrease because of increase in battery usage.*

Browsing the WAP Alerts

WAP Alerts are web based messages sent from a service provider to subscribers. You can view the messages in the "WAP Alerts" menu.

 *This function may not be available on all networks. Contact your service provider for more information.*

- 1 At the main menu, select in the following order: "Messages" → "WAP Alerts."
The "WAP Alerts" list appears.
- 2 Press  or  to highlight a message and press .



Enjoying Multi Media





The "My Media" menu enables you to enjoy using multi media such as pictures, sounds, video clips and music tracks you created using the handset. You can download the various contents through the "t-zones" web site. You can also use and enjoy games and applications downloaded from the "t-zones" web site.

Using Pictures













In the "My Media" menu, "My photos" and "My pictures" are prepared for you to enjoy handling pictures. "My photos" is the space for storing pictures taken with the built-in digital camera, and "My pictures" is for storing pictures downloaded through the mobile Internet. Both "My photos" and "My pictures" have several useful functions for you to view, edit, and attach pictures with messages. Also, you can set pictures as wallpaper and if you wish to get more wallpapers for the handset, you can download them through the mobile Internet. With your handset, you can enjoy using "More pictures" services produced by T-Mobile. They enhance your pleasure of using pictures with the handset.

The picture formats available on the handset are:

-  : PNG format
-  : JPEG format
-  : e-Animation file (NVA)

-  : GIF format
-  : BMP format
-  : WBMP format
-  : WPNG format

Downloading Pictures

- 1** Press .
The main menu appears.
- 2** Press , ,  or  to highlight "My Media" and press .
- 3** Press  or  to highlight "Pictures" and press .
- 4** Press  or  to highlight "More pictures" and press .
The download channel for pictures and wallpapers appears. Select one of the channels and press  to access the service. When the service appears on the main display, follow the instructions to download pictures.

Viewing Pictures

- 1 At the main menu, select in the following order: "My Media" → "Photos" → "My photos," or "Pictures" → "My pictures."
The thumbnail index appears.



To access pictures taken with the built-in digital camera, select "My photos." To access pictures downloaded through the mobile Internet, select "My pictures."

- 2 Press , , or to select an image in the thumbnail index you wish to view and press .
The selected picture is displayed.
When you have finished viewing the picture, press [Back].



When viewing a picture from "My pictures," the maximum size of the picture that can be displayed is 295 kbytes.

To scroll the picture

After displaying the picture in step 2, press , , or to scroll the picture.



Some pictures cannot be scrolled depending on the picture size.

To view the pictures saved in memory card

- 2 After step 1, press [Options].
The "Options" menu appears.
- 3 Press or to highlight "Switch to memory card" and press .
The thumbnail index shows the pictures saved in memory card.



- *When you view the pictures saved in memory card, the menu item switches to "Switch to Handset."*
- *Pictures stored in memory card may not be viewed, edited, moved or copied depending on its file size or picture size.*

Sending Pictures as Attachments

You can attach the pictures to the MMS or E-mail message.

- 1 At the main menu, select in the following order: "My Media" → "Photos" → "My photos," or "Pictures" → "My pictures."
The thumbnail index appears.



- *To access pictures taken with the built-in digital camera, select "My photos." To access pictures downloaded through the mobile Internet, select "My pictures."*
 - *When attaching a photo/picture file to a message, the size of the file is automatically reduced if exceeding the maximum (295 kbytes) size to send.*
- 2 Press , , or to select an image in the thumbnail index you wish to attach and press . The selected picture is displayed.
 - 3 Press [Options]. The "Options" menu appears.
 - 4 Press or to highlight "Send via MMS" or "Send via E-mail" and press .
Following procedure is the same as making a message. For information on how to make a message, refer to the "Basic Operation" on page 11-69. Perform the operation from step 5 (Entering a phone number or an E-mail address.)



If you wish to view the full picture before sending it, press to display the image in step 2 before pressing [Options]. Then select "Send via MMS" or "Send via E-mail" in the "Options" menu.

Setting the stored image as wallpaper

- 1 At the main menu, select in the following order: "My Media" → "Photos" → "My photos," or "Pictures" → "My pictures."

The thumbnail index appears.



To access pictures taken with the built-in digital camera, select "My photos." To access pictures downloaded through the mobile Internet, select "My pictures."

- 2 Press , , or to select an image in the thumbnail index you wish to view and press [Options]. The "Options" menu appears.
- 3 Press or to highlight "Set as Wallpaper" and press .
- 4 Press or to highlight "Main Display" or "External Display" and press .
- 5 Press .
The displayed picture is set as the wallpaper.



If you wish to view the full size image of the picture before setting it as the wallpaper, press to display the image in step 2 before pressing [Options]. Then select "Wallpaper" in the "Options" menu.

Editing Pictures

You can edit pictures by retouching, adding frames or stamps or rotating. Also, you can adjust the size of the picture or rename the picture file.



The picture size may change after the editing operation.

To reduce picture size

- At the main menu, select in the following order: "My Media" → "Photos" → "My photos," or "Pictures" → "My pictures."
The thumbnail index appears.



To access pictures taken with the built-in digital camera, select "My photos." To access pictures downloaded through the mobile Internet, select "My pictures."

- Press , , or to select an image in the thumbnail index you wish to reduce the size of and press .
The selected picture is displayed.
- Press [Options].
The "Options" menu appears.

- Press or to highlight "Edit photo" and press .
If you are in "My picture," the menu item in step 4 is "Edit picture."
- Press or to highlight "Reduce photo size" and press .
If you are in "My picture" the menu item in step 5 is "Reduce picture size."
The options for reducing the picture size appear.
The following shows the menu items depending on the size of picture or photo selected.

When "2M pixel" is selected:

1M pixel (858×1144)
Large (768×1024)
Medium (480×640)
Small (240×320)
Tiny (120×160)

When "1M pixel" is selected:

Large (768×1024)
Medium (480×640)
Small (240×320)
Tiny (120×160)

When "Large" is selected:

Medium (480×640)
Small (240×320)
Tiny (120×160)

When “Medium” is selected:

Small (240×320)

Tiny (120×160)

When “Small” is selected:

Tiny (120×160)

- 6** Press or to highlight one of the menu items and press .
The picture size is reduced.

To reduce picture quality

- 1** At the main menu, select in the following order: “My Media” → “Photos” → “My photos,” or “Pictures” → “My pictures.”
The thumbnail index appears.



To access pictures taken with the built-in digital camera, select “My photos.” To access pictures downloaded through the mobile Internet, select “My pictures.”

- 2** Press , , or to select an image in the thumbnail index you wish to reduce the size of and press .
The selected picture is displayed.
- 3** Press [Options].
The “Options” menu appears.

- 4** Press or to highlight “Edit photo” and press .
If you are in “My picture,” the menu item in step 4 is “Edit picture.”
- 5** Press or to highlight “Reduce photo quality” and press .
The picture quality is reduced.

To retouch pictures

- 1** At the main menu, select in the following order: “My Media” → “Photos” → “My photos,” or “Pictures” → “My pictures.”
The thumbnail index appears.



To access pictures taken with the built-in digital camera, select “My photos.” To access pictures downloaded through the mobile Internet, select “My pictures.”

- 2** Press , , or to select an image in the thumbnail index you wish to retouch and press .
The selected picture is displayed.
- 3** Press [Options].
The “Options” menu appears.
- 4** Press or to highlight “Edit picture” and press .

5 Press or to highlight “Retouch” and press .

6 Press or to highlight one of the options below and press .

The “Retouch” options:

Sepia, Sparkling, Ripples, Tile, Emboss, Oil painting, Clear frame, Round frame, Soft frame, Zigzag frame

7 The selected option is confirmed on the display. Press to apply. If you wish to cancel, press [Cancel].



When you retouch a picture, a new retouched picture is created as the other file and the original picture is saved.

To add a frame to pictures

1 At the main menu, select in the following order: “My Media” → “Photos” → “My photos,” or “Pictures” → “My pictures.” The thumbnail index appears.



To access pictures taken with the built-in digital camera, select “My photos.” To access pictures downloaded through the mobile Internet, select “My pictures.”

2 Press , , or to select an image in the thumbnail index you wish to add a frame to and press .

The selected picture is displayed.

3 Press [Options]. The “Options” menu appears.

4 Press or to highlight “Edit picture” and press .

5 Press or to highlight “Add frame” and press .

6 Press , , or to select a frame and press .

7 The selected option is confirmed on the display. Press to apply. If you wish to cancel, press [Cancel].



When you add a frame to a picture, a new picture with a frame is created as the other file and the original picture is saved.

To add stamps to pictures

1 At the main menu, select in the following order: “My Media” → “Photos” → “My photos,” or “Pictures” → “My pictures.” The thumbnail index appears.



To access pictures taken with the built-in digital camera, select "My photos." To access pictures downloaded through the mobile Internet, select "My pictures."



- 2** Press , , or to select an image in the thumbnail index you wish to add stamps to and press .
The selected picture is displayed.
- 3** Press [Options].
The "Options" menu appears.
- 4** Press or to highlight "Edit picture" and press .
- 5** Press or to highlight "Add stamps" and press .
- 6** Press , , or to select a stamp and press .
- 7** Press , , or to move the cursor to the point you wish to add the stamp and press .
To add more stamps, press [Options] and select "Other Stamps," and then repeat steps 6 and 7.
- 8** To finish stamping, press [Options] and select "Save."



When you add stamps to a picture, a new picture with stamps is created as the other file and the original picture is saved.

To rotate pictures

- 1** At the main menu, select in the following order: "My Media" → "Photos" → "My photos," or "Pictures" → "My pictures."
The thumbnail index appears.
- To access pictures taken with the built-in digital camera, select "My photos." To access pictures downloaded through the mobile Internet, select "My pictures."
- 2** Press , , or to select an image in the thumbnail index you wish to rotate and press .
The selected picture is displayed.
 - 3** Press [Options].
The "Options" menu appears.
 - 4** Press or to highlight "Edit picture" and press .
 - 5** Press or to highlight "Rotate" and press .
The picture is rotated 90° counterclockwise.

- 6 Press  once to rotate the picture 90° counterclockwise.
- 7 Press  [Save].











Adjusting the size of pictures

You can adjust the size of pictures for any purpose such as for displaying in the external display.

- 1 At the main menu, select in the following order: “My Media” → “Photos” → “My photos,” or “Pictures” → “My pictures.”
The thumbnail index appears.



To access pictures taken with the built-in digital camera, select “My photos.” To access pictures downloaded through the mobile Internet, select “My pictures.”

- 2 Press , ,  or  to select an image you wish to adjust the size of and press  [Options]. The “Options” menu appears.
- 3 Press  or  to highlight “Adjust size” and press .
- 4 Press  or  to highlight one of the size options and press .

The “Adjust size” options:









Main display, External display, Power on/off, Incoming, Alarm

Renaming the picture

- 1 At the main menu, select in the following order: “My Media” → “Photos” → “My photos,” or “Pictures” → “My pictures.”
The thumbnail index appears.



To access pictures taken with the built-in digital camera, select “My photos.” To access pictures downloaded through the mobile Internet, select “My pictures.”

- 2 Press , ,  or  to select an image in the thumbnail index you wish to change the name of and press  [Options].
The “Options” menu appears.
 - 3 Press  or  to highlight “Rename” and press .
- The text entry screen appears. For more information on how to enter text, refer to “Entering Text” on page 8-51.
- 4 When you have finished renaming, press  to save.



If you wish to view the full picture before renaming it, press to display the image in step 2 before pressing [Options]. Then select "Rename" in the "Options" menu.



The following characters cannot be used for the file name: /, \, :, *, ?, ", <, >, | and . (full stop).

Setting Pictures as Caller ID

You can add pictures to the "Contacts list" and set the pictures as Caller ID.

- 1 At the main menu, select in the following order: "My Media" → "Photos" → "My photos," or "Pictures" → "My pictures." The thumbnail index appears.



To access pictures taken with the built-in digital camera, select "My photos." To access pictures downloaded through the mobile Internet, select "My pictures."

- 2 Press , , or to select an image in the thumbnail index you wish to add to the "Contacts list" and press [Options]. The "Options" menu appears.

- 3 Press or to highlight "Set as Caller ID" and press .

Two options appear. Select "Existing entry" or "New entry" according to your purpose.



When adding the picture to "Contacts list" as the Caller ID, the maximum size of the picture that can be added is 150 kbytes. Only pictures stored in the handset memory are available for the Caller ID.

To save the picture to an existing entry

- 4 After step 3, press or to highlight "Existing entry" and press .

To save the picture in a new entry

- 4 After step 3, press or to highlight "New Entry" and press .

Checking the Picture Information

- 1 At the main menu, select in the following order: "My Media" → select "My photos" or "My pictures." The thumbnail index appears.



To access pictures taken with the built-in digital camera, select "My photos." To access pictures downloaded through the mobile Internet, select "My pictures."

- 2 Press , , or to select an image in the thumbnail index whose details you wish to check and press .
The selected picture is displayed.
- 3 Press [Options].
The "Options" menu appears.
- 4 Press or to highlight "Photo details" and press .
If you are in "My picture," the menu item in step 4 is "Picture details."

Moving or Copying Pictures to Memory Card

- 1 At the main menu, select in the following order: "My Media" → "Photos" → "My photos," or "Pictures" → "My pictures."
The thumbnail index appears.



To access pictures taken with the built-in digital camera, select "My photos." To access pictures downloaded through the mobile Internet, select "My pictures."

- 2 Press , , or to select an image you wish to move or copy to memory card and press [Options].
The "Options" menu appears.
- 3 Press or to highlight "Move to memory card" or "Copy to memory card" and press .



If you view the pictures saved in memory card, the menu items switch to "Move to Handset" and "Copy to Handset," and you can move or copy pictures from memory card to the handset memory.

Deleting Pictures

- 1 At the main menu, select in the following order: "My Media" → "Photos" → "My photos," or "Pictures" → "My pictures." The thumbnail index appears.



To access pictures taken with the built-in digital camera, select "My photos." To access pictures downloaded through the mobile Internet, select "My pictures."

- 2 Press , , or to select an image in the thumbnail index you wish to delete and press [Options]. The "Options" menu appears.
- 3 Press or to highlight "Delete" and press .
- 4 Press or to highlight "One photo/picture" or "All pictures" and press .
- 5 Press [Yes].
If you wish to cancel deletion, press [No] in this step.



Once you delete a picture, it cannot be restored.



If you wish to view the full picture before deleting, press to display the image in step 2 before pressing [Options] and then select "Delete" in the "Options" menu.

Using Sounds

In the "Sounds" function mode, you can download various sounds and ringtones from the "t-zones" web site.













The sound formats available on the handset are:

	Original Ringtones (composed in Melody Editor)
	SMAF format
	MIDI format
	i Melody format
	WAVE format
	AMR format







- *SMAF (Synthetic music Mobile Application Format) is a music data format for handsets.*
- *AAC & MP3 format files are also supported. For information on these file formats, refer to "Using Music" on page 12-110.*

Downloading Sounds

- 1 Press .
The main menu appears.
- 2 Press , ,  or  to highlight "My Media" and press .
- 3 Press  or  to highlight "Sounds" and press .
The "Sounds" menu appears.
- 4 Press  or  to highlight "t-music" and press .
The download channel for sounds and ringtones appears.

Playing Back Sounds





- 1 At the main menu, select in the following order: "My Media" → "Sounds" → "My sounds."
The list of "My sounds" appears.

- 2 Press  or  to highlight an item you wish to playback and press .
Playback of the selected sound file starts.
When you wish to stop playback, press .



You can playback or stop the sound file in the "Options" menu by pressing  [Options] in step 2.

Playing Back sounds saved in memory card

- 1 At the main menu, select in the following order: "My Media" → "Sounds" → "My sounds."
The list of "My sounds" appears.
- 2 Press  [Options].
The "Options" menu appears.
- 3 Press  or  to highlight "Switch to memory card" and press .
The list of "My sounds" shows the sound file names saved in memory card.



When you access sound files saved in the memory card, the menu item switches to "Switch to handset."

Sending Sounds as Attachments

- 1 At the main menu, select in the following order: “My Media” → “Sounds” → “My sounds.”
The list of “My sounds” appears.
- 2 Press or to highlight the file you wish to send as an attachment and press [Options].
The “Options” menu appears.
- 3 Press or to highlight “Send via MMS message” or “Send via E-mail” and press .
For information on how to create messages, refer to “Using the Message Service” on page 11-68.



Sounds with a red icon cannot be sent as an attachment.

Checking the Sound Information

- 1 At the main menu, select in the following order: “My Media” → “Sounds” → “My sounds.”
The list of “My sounds” appears.
- 2 Press or to highlight a file whose details you wish to check and press [Options].
The “Options” menu appears.
- 3 Press or to highlight “Sound details” and press .

12-98







Changing the Name of Sound Files

- 1 At the main menu, select in the following order: “My Media” → “Sounds” → “My sounds.”
The list of “My sounds” appears.
- 2 Press or to highlight a file whose name you wish to change and press [Options].
The “Options” menu appears.
- 3 Press or to highlight “Rename” and press .
The text entry screen appears. For information on how to enter text, refer to “Entering Text” on page 8-51.
- 4 When you have finished renaming, press to save.



*The following characters cannot be used for a file name: /, \, :, *, ?, ", <, >, | and . (full stop).*

Moving or Copying Sounds to Memory Card







- 1 At the main menu, select in the following order: "My Media" → "Sounds" → "My sounds."
The list of "My sounds" appears.
- 2 Press  or  to select a sound file you wish to move or copy to the memory card and press  [Options].
The "Options" menu appears.
- 3 Press  or  to highlight "Move to memory card" or "Copy to memory card" and press .













If you access sound files saved in a memory card, the menu items switch to "Move to handset" and "Copy to handset," and you can move or copy sounds from memory cards to the handset memory.

Moving or Copying Sounds to My music

- 1 At the main menu, select in the following order: "My Media" → "Sounds" → "My sounds."
- 2 The list of "My sounds" appears.

- 3 Press  or  to select a sound file you wish to move or copy to "My music" and press  [Options].
- 4 The "Options" menu appears.
- 5 Press  or  to highlight "Move to My music" and press .

Deleting Sounds

- 1 At the main menu, select in the following order: "My Media" → "Sounds" → "My sounds."
The list of "My sounds" appears.
- 2 Press  or  to highlight an item you wish to delete and press  [Options].
The "Options" menu appears.
- 3 Press  or  to highlight "Delete" and press .
- 4 Press  or  to highlight "One sound" or "All sounds" and press .
- 5 Press  [Yes].
If you wish to cancel, press  [No] in this step.



Once you delete a sound file, it cannot be restored.

Using Melody Editor

You can create original ringtones by using “Melody editor.”

Your original ringtone is registered in “My sounds.”

To create an original ringtone

Enter the name of the melody

- 1 At the main menu, select in the following order: “My Media” → “Sounds” → “Melody editor.”
- 2 Press or to highlight “Create new” and press .
- 3 Enter the title of your original ringtone and press .
You can enter up to 24 characters as the title. For information on how to enter text, refer to “Entering Text” on page 8-51.

Setting tempo and the type of chords

- 4 Press or to highlight one of the tempos below and press .
The tempos:

“Allegro (Fast)”	↓	150
“Moderato (Normal)”	↓	125
“Andante (Slow)”	↓	107
“Adagio (Very Slow)”	↓	94

Tempo is defined by the number of crochet beats (↓) played per minute (bpm).

- 5 Press or to highlight “8 chords,” “16 chords” or “32 chords” and press .
The “Score input” screen appears.

Input melody

- 6 Press the digit key to specify the pitch of the musical note or rest.
For more information, refer to “To input a melody” on page 12-101.
- 7 Press or to specify the length of the musical note or rest.
For more information, refer to “To input a melody” on page 12-101.
- 8 Press after inputting one note.
Input the next note after the cursor moves to the right.
- 9 Repeat steps 6 to 8 to complete the melody.
When you press during input, the melody that you have entered is played back.
Press [Options] and select “Play before Cursor” while entering notes to playback the melody displayed on the screen up to the cursor position.
Press [Options] and select “Select Chord” to select another chord. Repeat steps 6 to 8 to input notes for the new chord.

Save the ringtone

- 10** When you finish inputting, press [Options].
The "Options" menu appears.
- 11** Press or to highlight "Save" and press .
- 12** Press or to highlight "Save to My sounds" and press .



You can copy, cut, and paste notes by using the "Options" menu in the "Score input" screen.



If the capacity or memory in "My sounds" becomes insufficient, the message "Maximum capacity: 250 Not registered." or "Not registered. Memory full." is displayed. The display returns to the screen of step 12. Try again after deleting unnecessary items.

To input a melody

Specifying the pitch of the musical note

You can specify the pitch of a musical note and rest by pressing the keys shown below.

C (Do)	D (Re)	E (Mi)	F (Fa)	G (Sol)	A (La)	B (Si)	Rest

Pressing the keys above once specifies a crotchet (\downarrow) in middle scale (no mark).

Pressing the same key repeatedly shifts the note through the available octave range (\blacktriangle or \blacktriangledown added corresponding to octave range).

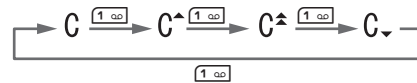

Pressing or while a note is selected causes the note to move a semitone higher or lower.

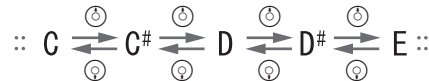

Pressing enters a Crochet rest \downarrow .

Specifying the length of notes and rests

You can specify the length of each musical note and rest by pressing **[*+o]** or **[#] [M]** repeatedly. Pressing **[#] [M]** changes the length of notes and rests in reverse to pressing **[*+o]**.

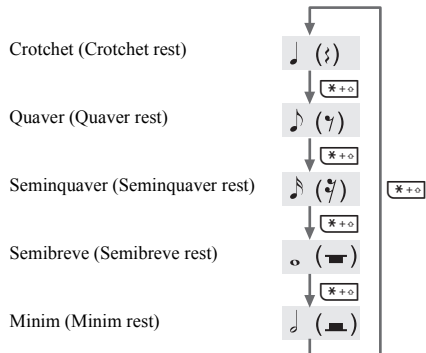

If you wish to specify a dotted note or a triplet, press **[S wxyz]** after selecting the target note.



- You cannot make a dotted semi quaver (dotted semi quaver rest) or a dotted semi breve (dotted semi breve rest).
- Three continuous notes are required for a triplet.

Specifying a tie

To specify a tie, press **[S wxyz]** after selecting the target notes.









An underscore () is displayed next to the note and the note is tied with the next.





To enter the next note, press **[C]** and move the cursor to the right, then repeat the operation to input the melody. If the cursor is positioned next to a note, you can repeat the note immediately to the left of the cursor by pressing **[C]** or **[Q]**.

Sample steps to input melody









To get used to inputting melodies, input the simple melody shown below.



- 1** At the main menu, select in the following order: "My Media" → "Sounds" → "Melody editor" → "Create new."
- 2** Enter the title of your original ringtone and press .
- 3** Select the tempo and the type of chords.
The "Score input" screen appears. For information on selecting the tempo and the type of chords, refer to "Setting tempo and the type of chords" on page 12-100.
- 4** Press  to input "C."
The "C" note sounds and the "C" crotchet appears in the "Score input" screen.
- 5** Press  to move the cursor.
- 6** Press  to input "G."
- 7** While selecting "G" crotchet, press  to change the length of the note.
"G" crotchet changes to "G" quaver.
- 8** Press  to move the cursor.
- 9** Press  to input a crotchet rest and press  to change the crotchet rest to a quaver rest.
A quaver rest appears next to the "G" note in the "Score input" screen.







- 10** Press  to move the cursor.
- 11** Press  to input an "E" note and press  to move the note one semitone lower.
- 12** Press  to play back the melody.

To edit the existing melody







- 1** At the main menu, select in the following order: "My Media" → "Sounds" → "Melody editor."
 - 2** Press  or  to highlight "Existing melodies" and press .
 - 3** Press  or  to highlight the melody you wish to edit and press  [Options].
The "Options" menu appears.
 - 4** Press  or  to highlight "Edit data" and press .
- The title entry (edit) screen appears.
After this step, follow the steps from step 6 of "To create an original ringtone" on page 12-100.







You can also start editing the existing melody from "My sounds" by following the next steps.

- 1** At the main menu, select in the following order: “My Media” → “Sounds” → “My sounds.”
- 2** Press  or  to highlight the item you wish to edit and press  [Options].
The “Options” menu appears.
- 3** Press  or  to highlight “Edit data” and press .
Only a user created melody can be selected in this step.









To set the tone of each chord

- 1** In the “Score input” screen, press  [Options].
(Refer to “To create an original ringtone” on page 12-100.)
The “Options” menu appears.
- 2** Press  or  to highlight “Set tone” and press .
The “Set tone” screen appears.
- 3** Press  or  to change the category of tones. You can select tones from the following 16 categories:
Pianos, Organs, Basses, Chimes, Guitars, Strings 1, Strings 2, Reeds, Synth Leads, Brasses, Flutes/Pipes, Synth Pads, Synth Effects, Percussions, Ethnics, Effects









- 4** Press  or  to highlight a tone.
The selected tone is applied to the selected chord. Press  [Options] in this step and select “Play current chord” to play back the melody input in the selected tone.
Press  [Options] in this step and select “Confirm tones” to play back the scale (1 octave from C) in the selected tone.
- 5** Press  to set the tone and go back to the “Score input” screen.



You can also reach the “Set tone” screen for the existing melodies from “My sounds” by following the next steps.



- 1** At the main menu, select in the following order: “My Media” → “Sounds” → “My sounds.”
- 2** Press  or  to highlight the item whose tone you wish to set and press  [Options].
The “Options” menu appears.
Only a user created melody can be selected in this step.
- 3** Press  or  to highlight “Set tone” and press .
- 4** Press  or  to highlight the chord whose tone you wish to set and press .
The “Set tone” screen appears.







To set the strength of each chord

- 1** In the “Score input” screen, press  [Options]. (Refer to “To create an original ringtone” on page 12-100.)
The “Options” menu appears.
- 2** Press  or  to highlight “Set strength” and press .
The “Set strength” screen appears.
- 3** Press  or  to highlight “Loud,” “Medium” or “Soft” and press .
By pressing  [Play] in this step before pressing , you can check the strength of the selected chord.



You can also reach the “Set strength” screen for existing melodies from “My sounds” by following the next steps.

- 1** At the main menu, select in the following order: “My Media” → “Sounds” → “My sounds.”
- 2** Press  or  to highlight the item whose strength you wish to set and press  [Options].
The “Options” menu appears.
Only a user created melody can be selected in this step.

- 3** Press  or  to highlight “Set strength” and press .
- 4** Press  or  to highlight the chord whose strength you wish to set and press .
The “Set strength” screen appears.

Using Games or Applications

You can use various kinds of games and applications with the handset. To use games and applications, download these via the Internet. Some games and applications offer the ability to connect to a network either within a game or through a network based application.



Applications may be both localised (no connectivity) and network based (using the mobile Internet to update information/play games). You may be charged for using network-based applications. Please contact your service provider for more information.

Downloading Games or Applications

Before downloading games or applications, you are asked to confirm what you are about to receive. After checking the information on the confirmation screen, the game or application can be downloaded. User authentication may be required on some information screens.

- 1 Press .
The main menu appears.
- 2 Press , , or to highlight "My Media" and press .

12-106

- 3 Press or to highlight "Games & more" and press .
The "Games & more" menu appears.
- 4 Press or to highlight "t-games" and press .
The download channel to games or applications appears.





Starting a Game or an Application

- 1 At the main menu, select in the following order: "My Media" → "Games & more" → "My games & more."
The list of "My games & more" appears.
The games and the applications downloaded to the handset are listed in chronological order.
- 2 Press or to highlight a game or application you wish to start.
- 3 Press .
The selected game or application starts.
If you run network based games or applications, you can select a connection to the network.







To end the game or application

- 1 While you are running the application, press .
- 2 Press or to highlight "End" and press .

To suspend the game or application









- 1 While you are running the application, press .
- 2 Press  or  to highlight "Suspend" and press .

Viewing the Game or Application information

- 1 At the main menu, select in the following order: "My Media" → "Games & more" → "My games & more."
The list of "My games & more" appears.
 - 2 Press  or  to highlight a game or application whose information you wish to view and press  [Options].
The "Options" menu appears.
 - 3 Press  or  to highlight "Application details" and press .
- The detailed information screen appears.

Deleting the Game or Application

- 1 At the main menu, select in the following order: "My Media" → "Games & more" → "My games & more."
The list of "My games & more" appears.

- 2 Press  or  to highlight a game or application you wish to delete and press  [Options].
The "Options" menu appears.
- 3 Press  or  to highlight "Delete" and press .
- 4 Press  [Yes].
The selected game or application is deleted.
If you wish to cancel, press  [No] in this step.



You cannot delete preinstalled applications.









Once you delete a game or application, it cannot be restored.

Using Videos

The "Videos" function enables you to play back the video clips created using the built-in digital camera. Also, more video clips for the handset are available via the mobile Internet service.

Downloading Video Clips

- 1 Press .
- 2 Press , ,  or  to highlight "My Media" and press .

- 3 Press or to highlight “Videos” and press .
The “Videos” menu appears.
- 4 Press or to highlight “t-movies” and press .

Playing Back Videos

- 1 At the main menu, select in the following order: “My Media” → “Videos” → “My videos.”
The thumbnail index for “My videos” appears.
- 2 Press , , or to select the image of the video clip in the thumbnail index you wish to play back and press .
The selected video clip is displayed and press .

To play back the videos saved in memory card

- 2 After step 1, press [Options].
The “Options” menu appears.
- 3 Press or to highlight “Switch to memory card” and press .
The thumbnail index appears.



When you access the video clip files saved in the memory card, the menu item switches to “Switch to handset.”

12-108

Changing the name of the video

- 1 At the main menu, select in the following order: “My Media” → “Videos” → “My videos.”
The thumbnail index for “My videos” appears.
- 2 Press , , or to select the image of the video clip in the thumbnail index you wish to change the name of and press [Options].
The “Options” menu appears.
- 3 Press or to highlight “Rename” and press .
The text entry screen appears. For information on how to enter text, refer to “Entering Text” on page 8-51.
- 4 After renaming, press to save.



*The following characters cannot be used for a file name: /, \, :, *, ?, ", <, >, | and . (full stop).*

Sending Videos as Attachments

- 1 At the main menu, select in the following order: “My Media” → “Videos” → “My videos.”
The thumbnail index for “My videos” appears.
- 2 Press , , or to select the image of the video clip in the thumbnail index you wish to send with a message and press [Options].
The “Options” menu appears.

- 3** Press or to highlight “Send via MMS” or “Send via E-mail” and press .
- For more information on creating messages, refer to “Using the Message Service” on page 11-68.

Checking Video Information

- 1** At the main menu, select in the following order: “My Media” → “Videos” → “My videos.”
The thumbnail index for “My videos” appears.
- 2** Press , , or to select the image of the video clip in the thumbnail index you wish to check the details of and press [Options].
The “Options” menu appears.
- 3** Press or to highlight “Video details” and press .

Moving or Copying Videos to Memory Card

- 1** At the main menu, select in the following order: “My Media” → “Videos” → “My videos.”
The thumbnail index for “My videos” appears.
- 2** Press , , or to select a video clip file you wish to move or copy to the memory card and press [Options].
The “Options” menu appears.

- 3** Press or to highlight “Move to memory card” or “Copy to memory card” and press .



When you access video clip files saved in the memory card, the menu items switch to “Move to handset” and “Copy to handset,” and you can move or copy videos from memory card to the handset memory.

Deleting Videos

- 1** At the main menu, select in the following order: “My Media” → “Videos” → “My videos.”
The thumbnail index for “My videos” appears.
- 2** Press , , or to select the thumbnail image of the video clip you wish to delete and press [Options].
The “Options” menu appears.
- 3** Press or to highlight “Delete” and press .
- 4** Press or to highlight “One video clip” or “All video clips.”
- 5** Press [Yes].
If you wish to cancel, press [No] in this step.



Once you delete a video file, it cannot be restored.