

GC7

User's Manual

0261.2 W9U091

Chapter 1: Getting Started	1
1.1 Your Device	1
Front	1
Back.....	1
Top.....	2
Down	2
1.2 Accessories	2
1.3 Installing Memory Card	3
1.4 Charging Battery	3
LED Indicator	4
1.5 Using Headsets	4
1.6 Turning the Device On or Off	5
1.7 Unlocking the Screen	6
Chapter 2: The Basics	7
2.1 Home Screen	7
Extended Home screen	7
Status Bar Icons	8
Shortcut menu.....	9
Using widgets	10
Applications.....	10
Setting wallpaper	11
2.2 Adjusting Volume	12
2.3 Setting up Wi-Fi	13
2.4 Contacts	15
Adding contacts	15
Importing contacts	16
Backing up contacts.....	16
Favorite contacts.....	17
Chapter 3: Entering Information	18
3.1 On-Screen Keyboard	18
Using the on-screen keyboard	18
Setting input method.....	19
3.2 Configuring Keyboard Settings	19
Chapter 4: Email	20
4.1 Email Accounts	20
Setting up an Internet email account	20
Viewing email accounts	20
4.2 Using Email	21
Composing and sending emails	21
Receiving emails	22
Reading and replying to emails	22
Managing email folders.....	23
Customizing email settings.....	24

Chapter 5: Using Internet	25
5.1 Browsing Web Pages.....	25
Managing web pages	26
Chapter 6: Google Applications.....	27
6.1 Gmail	27
Signing in to Gmail	27
Refreshing Gmail.....	27
Creating and sending emails.....	27
Reading and replying to emails	28
Forwarding emails	28
Managing emails	28
Viewing folder labels	29
Searching for emails	29
Configuring Gmail settings	29
6.2 Talk	30
Signing in to Google Talk	30
Google Talk options	30
Starting chat.....	30
Configuring Google Talk settings	31
6.3 Maps	32
Viewing Map.....	32
Finding places.....	33
6.4 Navigation	33
Getting directions	34
Finding your current location	34
6.5 Latitude	35
Starting Latitude	35
Configuring privacy settings	35
6.6 Market.....	36
Searching for applications	36
Downloading applications	36
Removing applications	36
6.7 Places	37
6.8 Google Search	37
Searching information by entering text	37
6.9 Voice Search.....	38
6.10 YouTube	38
Watching videos	38
Uploading videos.....	38
Searching videos.....	38
Chapter 7: Using Bluetooth.....	39
7.1 Connecting to Bluetooth Devices	39
Chapter 8: Multimedia Applications	40
8.1 Photos and Videos	40
Taking a photo.....	40

Recording a video.....	41
Reviewing a photo.....	41
Reviewing a video.....	42
Configuring camera settings.....	42
8.2 Viewing Photos & Videos.....	44
Viewing photos.....	44
Playing videos.....	45
8.3 Using Music Player.....	45
Music screen.....	45
Playing music.....	47
Managing playlists.....	47
8.4 Sharing Media.....	48
Viewing media files.....	48
Downloading media files.....	49
Sharing media files.....	49
Uploading media files.....	50
Chapter 9: Applications.....	51
9.1 Browser.....	52
9.2 Calculator.....	53
9.3 Calendar.....	53
9.4 Camera.....	53
9.5 Clock.....	54
9.6 Contacts.....	54
9.7 Downloads.....	54
Managing files.....	54
9.8 Email.....	54
9.9 File Browser.....	55
Managing files and folders.....	55
9.10 FM Radio.....	56
9.11 Gallery.....	56
9.12 Gmail.....	57
9.13 Google Search.....	57
9.14 Latitude.....	57
9.15 Maps.....	57
9.16 Market.....	57
9.17 Music.....	57
9.18 Myriad UPnP Remote.....	57
9.19 Myriad UPnP Server.....	57
9.20 Navigation.....	58
9.21 Places.....	58
9.22 Settings.....	58
9.23 Talk.....	58
9.24 TouchPal Input.....	58
9.25 Voice Search.....	58
9.26 YouTube.....	58
Chapter 10: Managing Your Device.....	59
10.1 Device Settings.....	59

Wireless & networks	59
Sound	59
Screen	59
Location & security	60
Applications	60
Accounts & sync	61
Privacy	61
Storage	61
Language & input	61
Accessibility	62
Date & time	62
About tablet	62
10.2 Changing Basic Settings	63
Date and time settings	63
Alarms settings	63
Display settings	64
Ringtone settings	64
10.3 Using Wireless & networks	64
10.4 Protecting Your Device	65
Screen lock protection settings	65
10.5 Resetting the Device	65
Safety Information	66
Specifications	70

Chapter 1: Getting Started

1.1 Your Device

Front

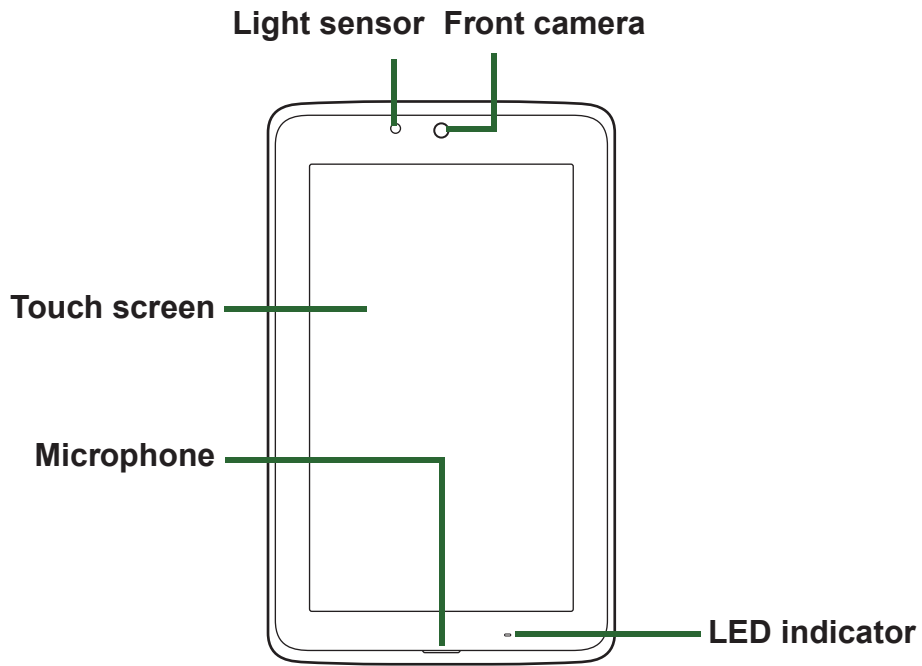

Back

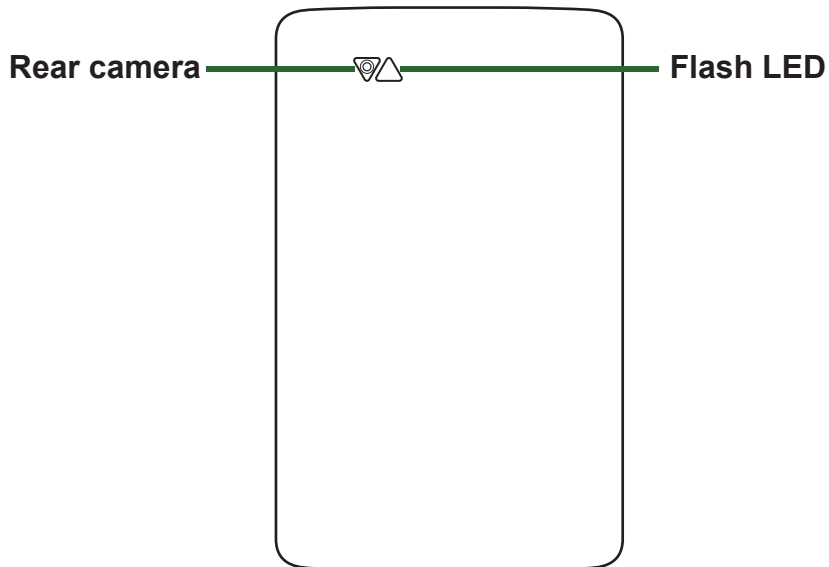

Top

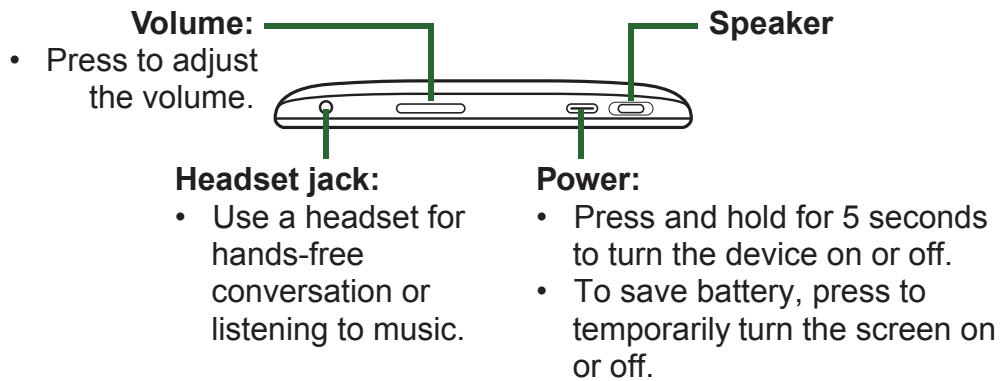

Down

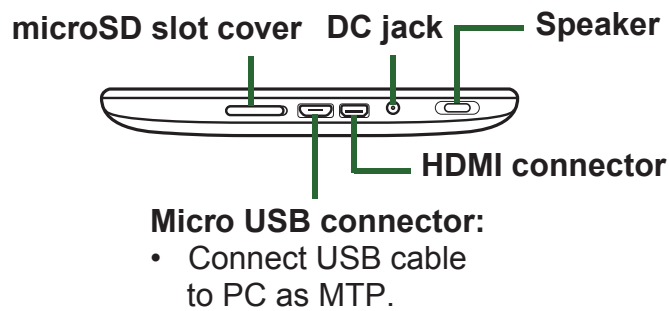

1.2 Accessories

Your package comes with the following items. If any of them is missing, please contact your retailer.

- Tablet
- AC adapter
- Micro USB cable
- Headset
- Quick Start Guide

1.3 Installing Memory Card

You need a microSD[®] card to store photos, music, videos, and other data.

To install the memory card

1. Open the card cover.
2. Insert the microSD card as shown. Make sure the gold contacts are facing down.

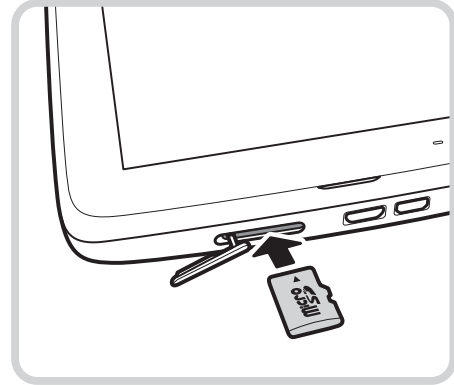

To remove the memory card

1. Open the card cover.
2. Push to eject the microSD card from the slot.



NOTE: Do not remove the memory card while the device is turned on. Sudden removal of the memory card may cause data loss or unpredictable system hang up.

1.4 Charging Battery

The battery is only partially charged. To fully charge the battery, charge it for 2 hours.

Charge the battery

1. Connect one end of the AC adaptor to the DC jack of the device.
2. Plug the other end of the AC adaptor to the wall outlet to start charging.

When the battery is charging and the device is turned on, the  icon is displayed on the status bar. When the battery is fully charged, the  icon is displayed on the status bar.

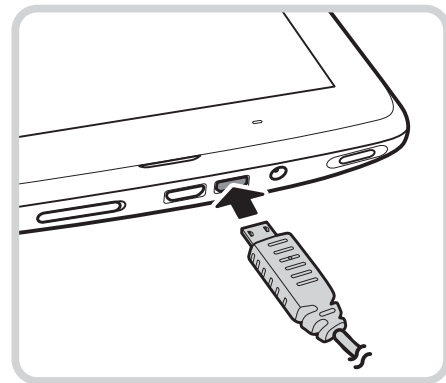

LED Indicator

Device State	LED Color	Indication
Power On	Orange (solid)	Battery is charging.
	Green (solid)	Battery is fully charged.
	Green and Orange (blinking)	Battery overheat (A warning “Battery temperature is too high, stop battery charging!” message appears on the screen).
		Charging error (short circuit/over voltage/no battery inside the device/extended charging time).
Power Off	Orange (solid)	Battery is charging.
	Green (solid)	Battery is fully charged.
	Green and Orange (blinking)	Charging error (short circuit/over voltage/no battery inside the device/extended charging time).

1.5 Using Headsets

For hands-free conversation or listening to music, plug a headset to the headset jack.

NOTE:

- When using a headset, your ability to hear outside sounds may be limited. Do not use headset if it will endanger you.
- When using a headset, do not set the volume to its maximum as it may damage your hearing.

1.6 Turning the Device On or Off

After installing the memory card and charging the battery, the device is ready to be turned on.

To turn on your device

Press and hold the **Power** button until the device vibrates.

To turn off your device

1. Press and hold the **Power** button for 1 second.
2. A pop-up window appears, tap **OK** to confirm.

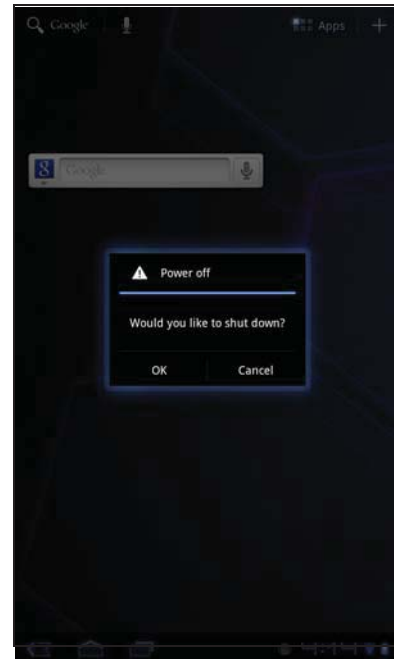

To set your device to Sleep mode



To set the device to sleep mode, press the **Power** button. This will turn the display off.

To turn the display on, press the **Power** button again.

1.7 Unlocking the Screen

By default, the screen automatically locks after a period of inactivity. You can set the length of time until the screen locks, see “Screen” on page 59.

To unlock the screen

1. Press the **Power** button to turn on the display from Sleep mode.
2. Tap  and drag the middle circle () to  to unlock the screen.



Chapter 2: The Basics

2.1 Home Screen

From the Home screen, you can quickly access common features and view notifications of received messages, battery and connection status.

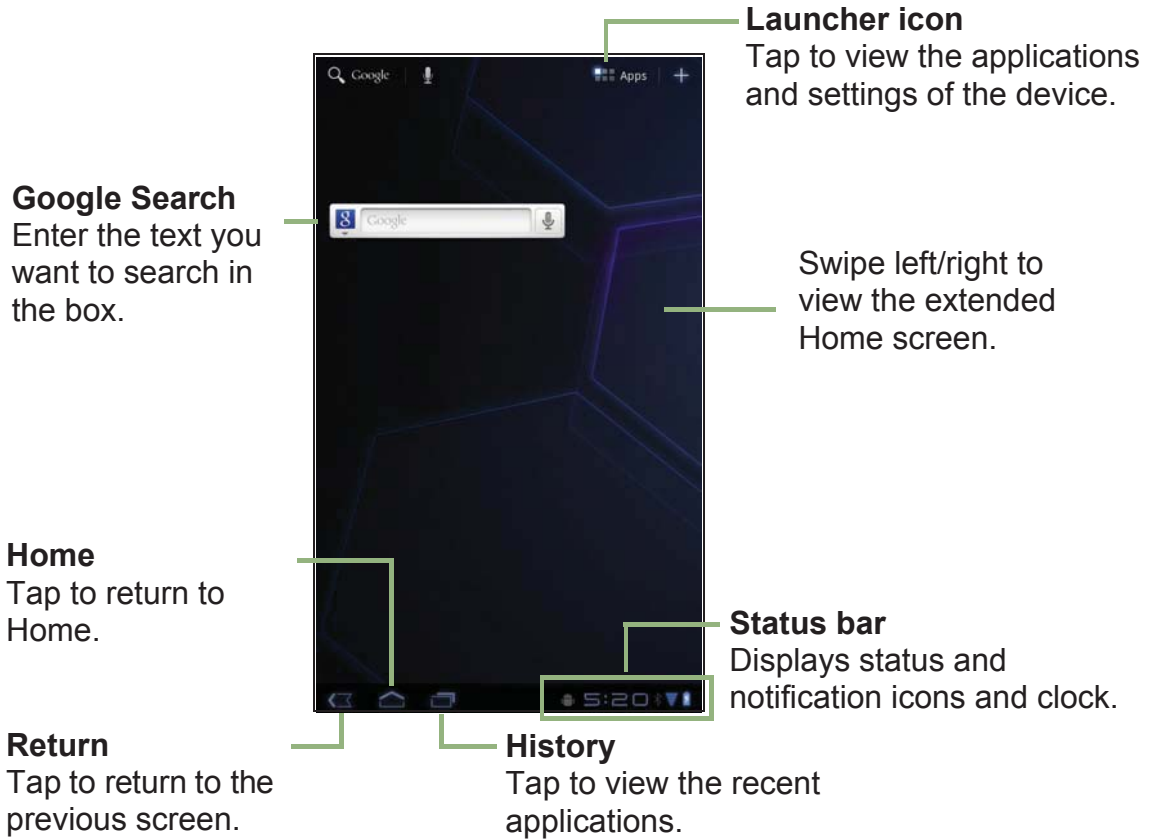

Extended Home screen

Swipe your finger to the left or right across the Home screen.

The two extensions to the left and to the right of the Home screen provide more space for icons, widgets, shortcuts, and other items.

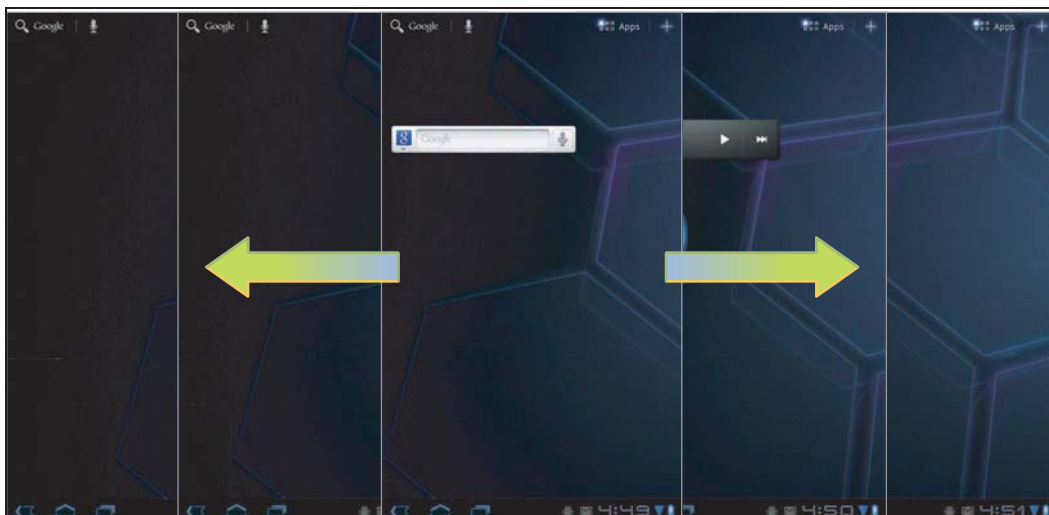









Status Bar Icons

Status bar icons indicate different types of information.

The icons on the status bar indicate the following information:



Icon	Description
	Battery is full.
	Battery is low.
	Battery is completely discharged.
	Battery is charging.
	Myriad UPnP Remote is active.

Icon	Description
	Wi-Fi is connected.
	Bluetooth connection is active.
	File downloading in progress.
	New email notification.

Tap the status bar and scroll up to view notifications or view system information easily. To close the window, tap .



Shortcut menu

The shortcut menu allows you to easily access an application from the Home screen. To open an application, tap an icon.

Customizing shortcut menu

To add a shortcut:

1. Tap **+**.
2. Tap **App shortcuts** to display the applications.
3. To add an item, drag the application icon to the specific Home screen.

You can also add a shortcut by pressing and holding the application icon, then drag it to the specific Home screen.



To remove shortcut:

1. Tap and hold an application icon.

The **Remove** icon appears on the top right of the Home screen.

2. Drag the application icon to **Remove** icon to delete. The application icon is removed from the Home screen.

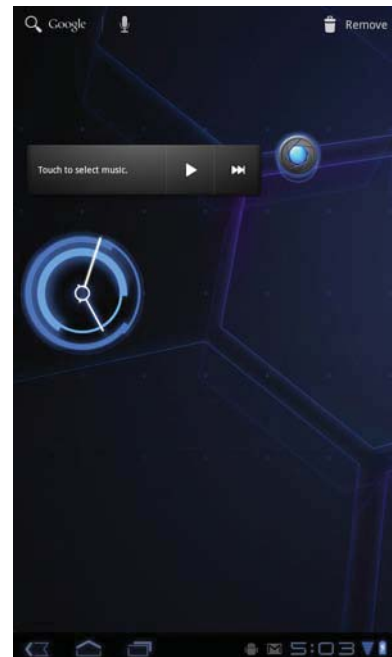



Using widgets

Save time with live updates right on the Home screen and get all your personalized updates in one place.

You may add and customize the Widgets on the Home screen as you like.

1. From the Home screen, tap . All available widgets is displayed.
2. To add widget, drag the widget icon to the specific Home screen.

To remove widgets:

1. From the Home screen, tap and hold the desired widget. The  Remove icon appears on the top right of the Home screen.
2. Drag the widget to  icon to delete it from the Home screen.



Applications

Tap  to view the applications and settings of the device.

- Tap an icon to access the application.





Setting wallpaper

You can customize the wallpaper of your Home screen with a default wallpaper or with pictures taken with your device.

Set wallpaper from Wallpaper gallery

1. From the Home screen, tap  > **Wallpapers**.
2. Tap **Wallpapers**.
All default wallpapers are displayed.
3. Tap the desired wallpaper to set as Home screen wallpaper.

Set wallpaper from My Gallery

1. From the Home screen, tap  > **Wallpapers**.
2. Tap **Gallery**.
3. Browse the files. Tap to select the picture you want to use as wallpaper.
4. Drag your finger to select the crop area.
5. Tap  **ok** to set the cropped photo as wallpaper.

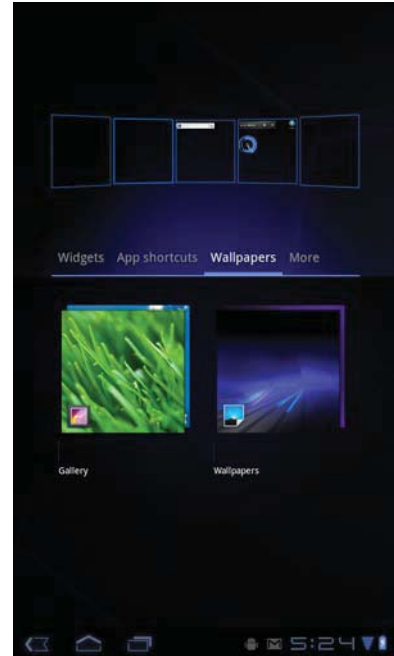

2.2 Adjusting Volume

This device features three types of volume which can be adjusted separately:

- **Ringer volume:** Set the volume for notifications.
- **Media volume:** Set the volume for music and videos.
- **Alarm volume:** Set the volume for alarms.

To adjust the volume

1. From the Home screen, tap  > **Settings** > **Sound**.
2. Tap **Volume**.
3. To adjust the volume, do either of the following:
 - a. Drag the respective volume slider to adjust the volume.
 - b. Press the volume button to adjust the volume.
NOTE: When the device is set to silent mode, all sounds are turned off except media and alarm.
4. Tap **OK** to save your settings.



2.3 Setting up Wi-Fi

This device only uses Wi-Fi connection. You need to connect to a wireless network before surfing the Internet or using the related applications that require internet connection.

To turn Wi-Fi on or off

1. From the Home screen, tap  **Apps** > **Settings** > **Wireless & networks**.
2. Tap **Wi-Fi** check box to turn Wi-Fi function on or off.

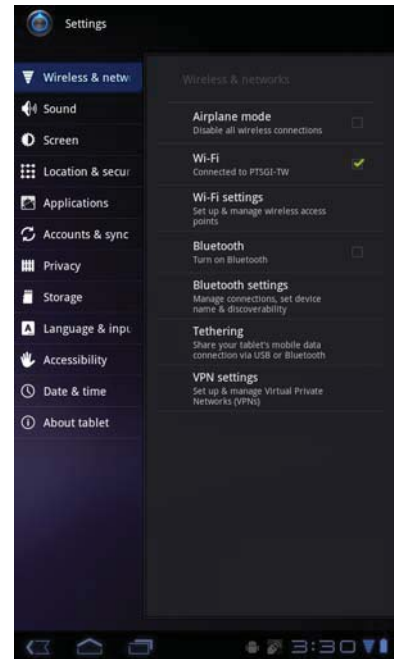

To connect to a Wi-Fi network

1. Turn Wi-Fi on.
2. Tap **Wi-Fi settings** > **Network notification** to start detecting networks.
3. The available networks are listed. Tap a network to connect to or tap **Add Wi-fi network** to manually add a connection.
4. If you select an unsecured network, the connection is automatically established. Otherwise, proceed to the next step.

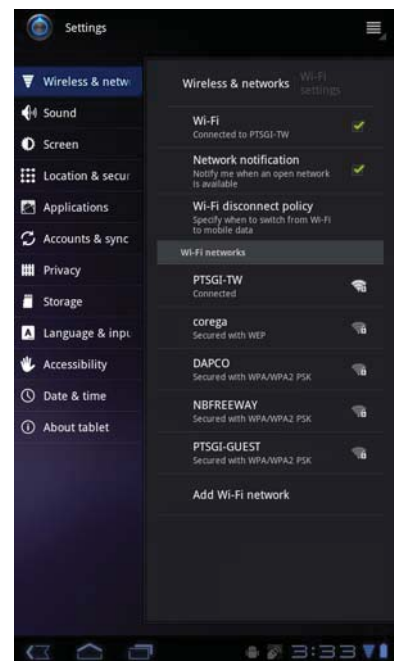

- When connecting to a secured network, you will be prompted for the password. Enter the password, then tap **Connect**.

When Wi-Fi is connected, the  connection icon is displayed on the status bar.



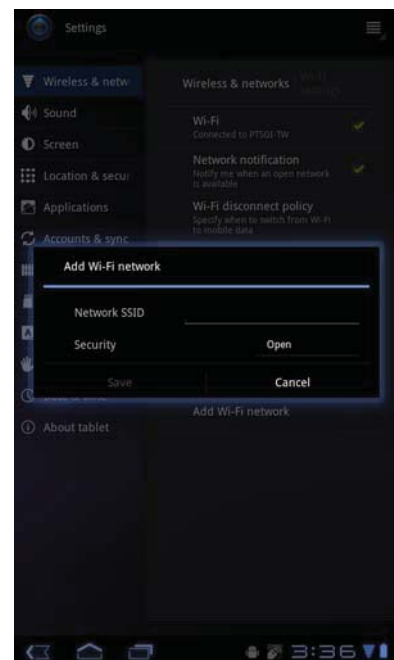

To add Wi-Fi network

- From the Home screen, tap  **Apps** > **Settings** > **Wireless & networks**.
- Tap **Wi-Fi settings**.
- In Wi-Fi networks, tap **Add Wi-Fi network**. A new window is displayed.
- Follow the on-screen instructions and enter the necessary information, then tap **Save** to save the settings.



To view Wi-Fi settings



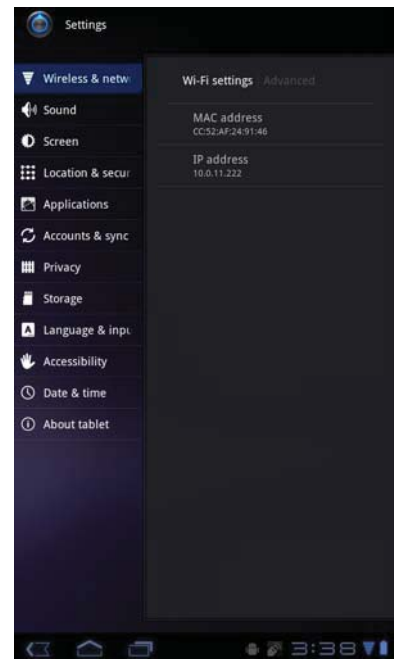

1. From the Home screen, tap  > **Settings** > **Wireless & networks**.
2. Tap **Wi-Fi settings** >  > **Advanced**.
The details on MAC address and IP address appear on the screen.



2.4 Contacts

Contacts lets you store names, phone numbers, email, and other information. Contacts are stored in the phone memory. You can also add the frequently used contacts to the Starred list. See “Favorite contacts” on page 17.

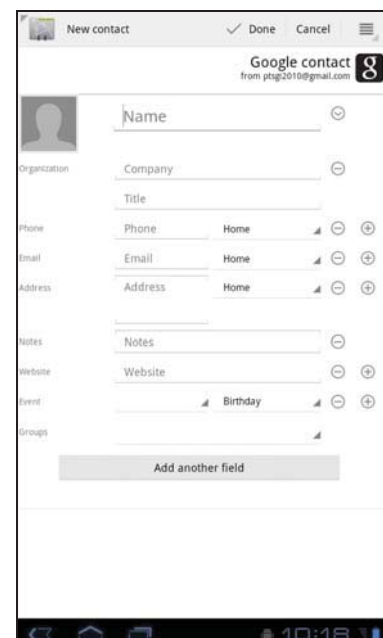

Adding contacts

1. From the Home screen, tap  > **Contacts**.
2. Tap .
3. Enter contact information such as name, phone number, email address, etc.
4. When finished, tap  to save the contact or tap  to exit without saving any changes.



Importing contacts

You can import contacts from the memory card to your device.

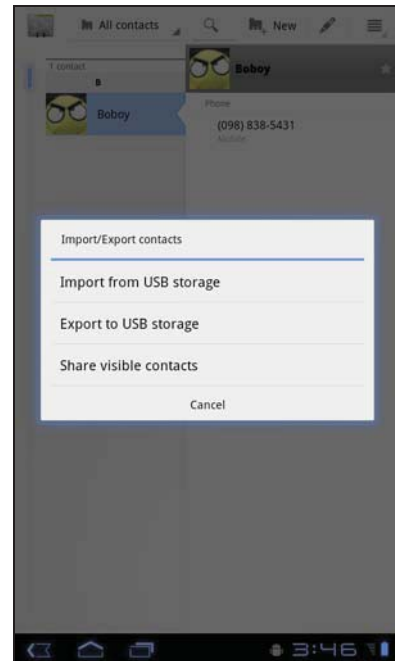

1. From the Home screen, tap  > **Contacts**.
2. Tap  > **Import/Export**.
3. Select **Import from Storage**.
4. Select vCard files to import and tap **OK**.



Backing up contacts

You can copy contacts to the memory card to back up your contacts information.

Export contacts to the memory card

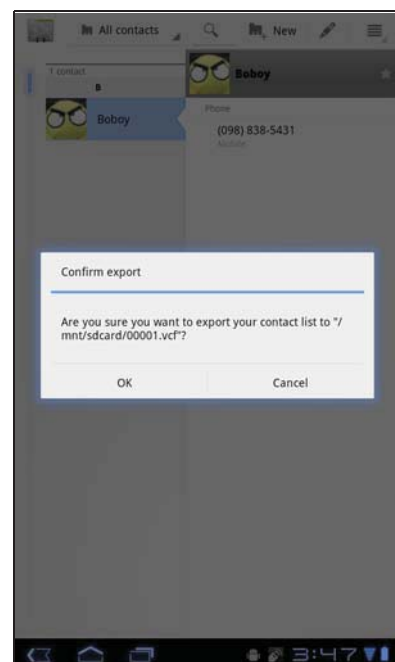

1. From the Home screen, tap  > **Contacts**.
2. Tap  > **Import/Export** > **Export to Storage**.
NOTE: Copying contacts to the memory card will overwrite the old backup file.
3. A warning message pops up, tap **OK** to proceed. All contacts are copied to the internal storage.



Favorite contacts



Add the most frequently called contacts to the Starred contact list to help you access contacts quickly and easily.

Add to Starred List

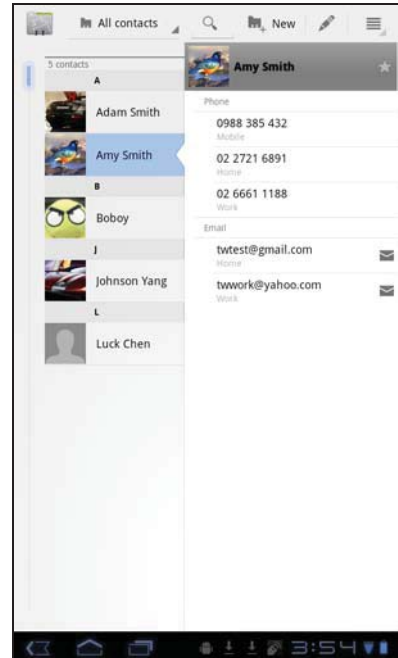
1. From the Home screen, tap  > **Contacts**.
2. From **All contacts** list, tap a contact.
3. Tap  and the icon turns blue.
The contact is now displayed in the **Starred** list.



Remove from Starred List

1. From the Home screen, tap  > **Contacts**.
2. Tap the group list, tap **Starred**.
The **Starred** list is displayed.
3. Tap a contact and tap .
The contact is removed from the **Starred** list.

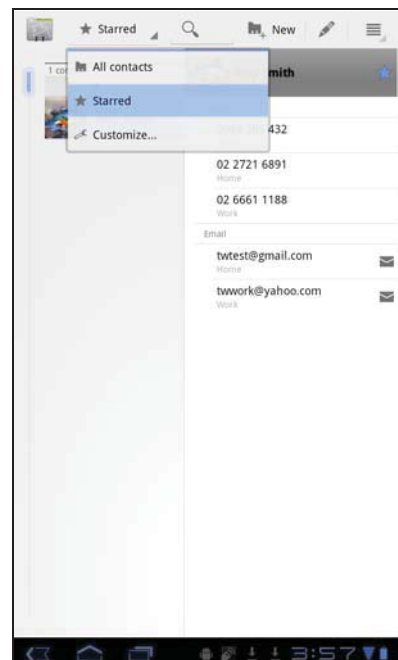

Chapter 3: Entering Information

3.1 On-Screen Keyboard

The on-screen keyboard appears when an application requires text input, such as messaging and writing emails. The keyboard input method is activated by default.

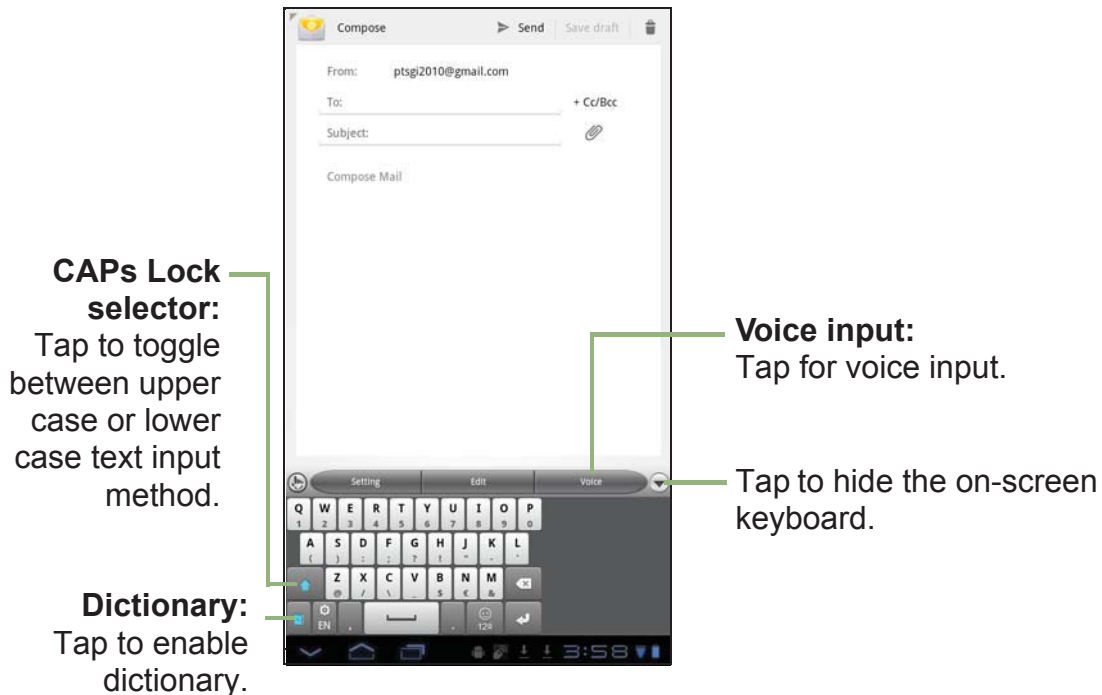

Using the on-screen keyboard

Tap the screen to display the on-screen keyboard.





Lowercase keyboard



Uppercase keyboard



Numbers and symbols



- Tap the keys to enter the characters.
- To toggle between upper and lower case letter display, tap .
- To display the numeric and symbols keyboard, tap . To switch back to lower case letter display, tap .

Setting input method

1. On the on-screen keyboard, tap .
The **InputMethod Menu** appears on the screen.
2. Tap **Settings** to change the keyboard settings.

3.2 Configuring Keyboard Settings

Use keyboard aids to set up various input settings.

1. From the Home screen, tap  **Apps** > **Settings** > **Language & input**.
2. Tap **Configure input methods** > **Settings**.
You can also access this setting by tapping  **Apps** > **TouchPal Input**.
3. Select the applicable options from the following keyboard settings:
 - **Key press sound**: Select to adjust the volume level of the clicking sound when a key is touched.
 - **Key press vibration**: Select to adjust the vibration amplitude level when a key is touched.
 - **Show Popup**: Select to enable popup effect when a key is touched.
 - **Keyboard layout**: Select to configure the settings for Keyboard Layout, Chinese Input Layout, and English Input Layout.
 - **TouchPal Input**: Select to configure the basic keyboard settings.
 - **Language**: Select to set the keyboard language.

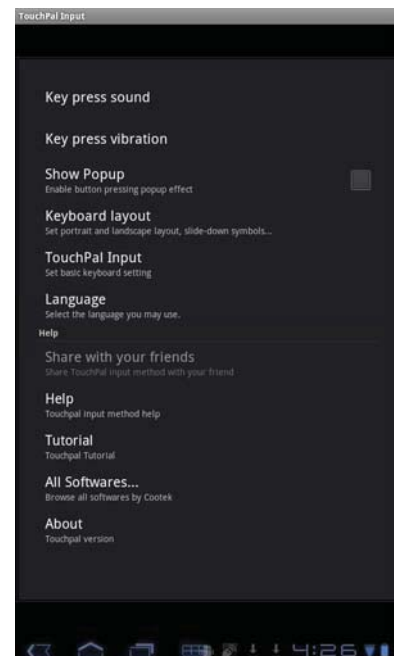

Chapter 4: Email

Use **Email** to send and receive email messages via your internet email accounts.

4.1 Email Accounts

Your device can send and receive emails just as you do with a computer. Your device supports email accounts provided by an Internet Service Provider (ISP) or web-based email, such as Hotmail, Yahoo! Mail, etc.

Setting up an Internet email account

1. From the Home screen, tap **Apps** > **Email**.
2. Enter your **Email address** and **Password**.
3. Tap **Next**. The device will automatically retrieve the email settings.
 - To add another email account, tap **Account settings** > **Add account**.
4. Set your account options and tap **Next**.
5. Enter **Your Name** and **Account display name**.

NOTE: The **Account display name** is the name shown to the recipients of your emails.
6. Tap **Next**.
Once the account set up is completed, the device will automatically retrieve your emails.



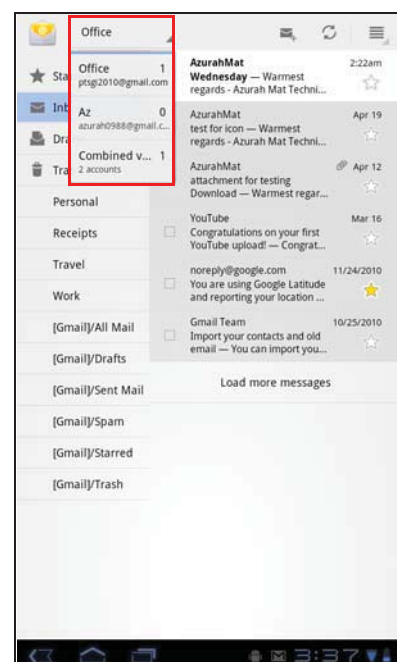

Viewing email accounts

1. From the Home screen, tap **Apps** > **Email**.
2. Tap the account picker box at the top left of the screen.
3. Tap the account you want to access from the available email accounts.



Customizing email settings

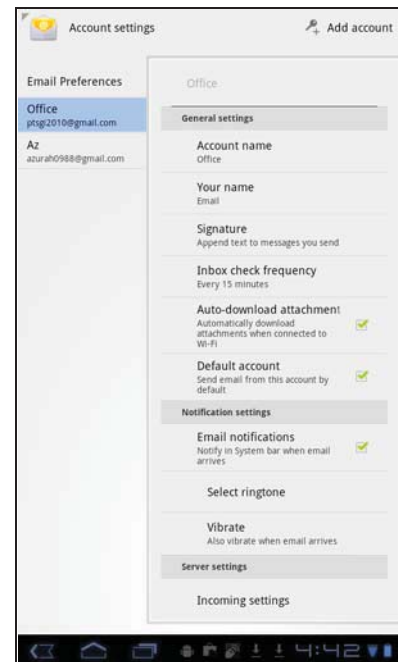

Configure message settings using the **Account settings** menu.

1. From the Home screen, tap  > **Email**.
2. Tap the account you want to access.
3. Tap  > **Account settings** to open the email setting menu.



4.2 Using Email

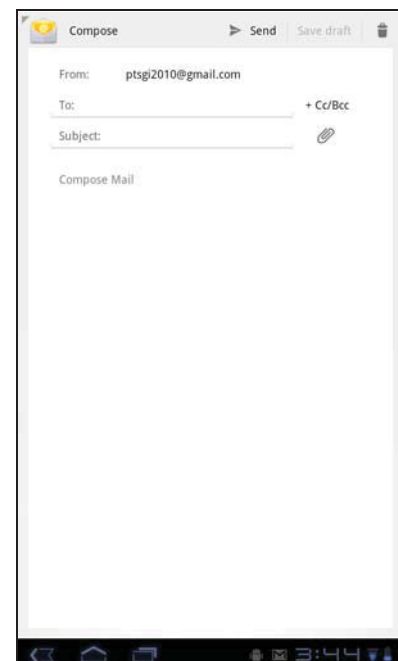

Composing and sending emails

1. From the Home screen, tap  > **Email**.
2. Tap an email account.
3. Tap .
4. In the **To** field, enter the recipient's email address.
5. Enter a **Subject**.
6. Compose your email.
7. Tap .



Sending an email from Contacts

You can send an email to a contact with an email address stored in Contacts.

1. From the Home screen, tap  > **Contacts**.
2. Tap a name to open contact.
3. Tap **Email Home** or **Email Work**.
4. Enter a **Subject**.
5. Compose your email.
6. Tap .



Adding attachments to an email message

1. On the Compose screen, tap .
2. Select the file that you want to attach.

Receiving emails

Emails are automatically received in your Inbox when the device connects to a wireless network.

To manually receive emails

1. From the Home screen, tap  > **Email**.
2. Tap an email account.
3. Tap .

Reading and replying to emails

Inbox displays email headers. Download the email to view the complete content.



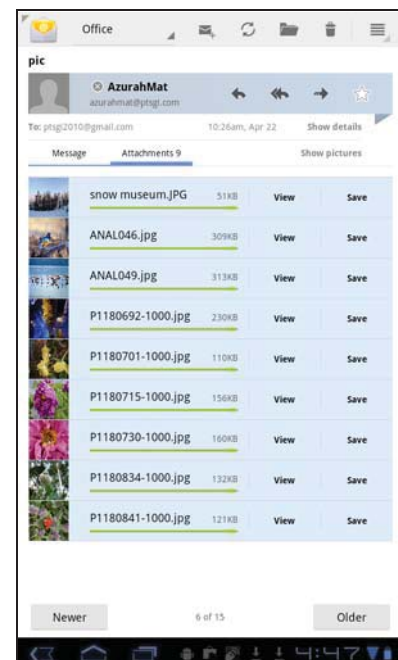

To download attachments

1. From the Home screen, tap  > **Email**.
2. Tap an email account.
3. Tap a message to open.
4. Tap **Attachment** tab and do any of the following:
 - Tap **View** to view the attachment.
 - Tap **Save** to save the attachment.

NOTE: Only supported file types can be opened on the device.



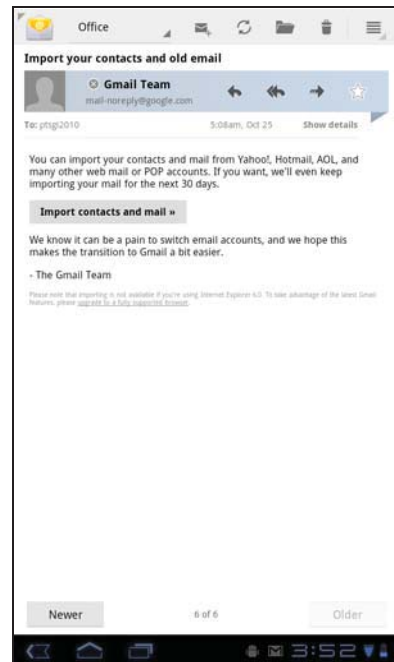

To reply or forward an email

1. From the Home screen, tap  > **Email**.
2. Tap an email account.
3. Tap a message to open.
4. Do any of the following:
 - Tap  (Reply) or  (Reply all) to reply the email.
 - Tap  (Forward). Then enter the recipient in the **To** field.
5. Compose your message.
6. Tap  **Send**.





Managing email folders

To delete an email

1. From the Home screen, tap  > **Email**.
2. Tap an email account.
3. Tap a message to open.
4. Tap  to delete an email.

To move an email to a folder

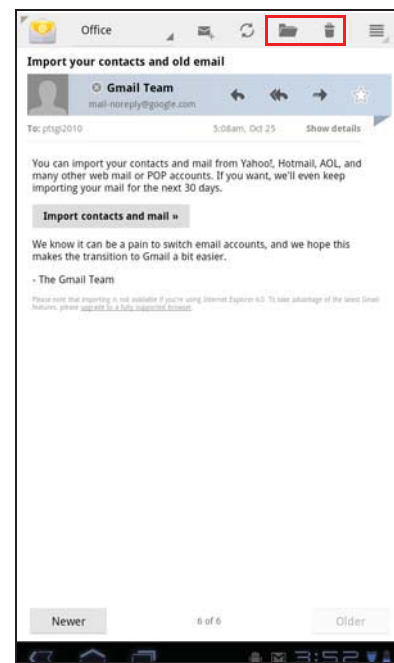

1. From the Home screen, tap  > **Email**.
2. Tap an email account.
3. Tap a message to open.
4. Tap  and tap the desired folder to move the current email to the selected folder.





Customizing email settings

You can configure the general settings of your email account such as account name, email checking frequency, default account, notifications, and server settings.

To set up your account name



1. From the Home screen, tap  > **Email**.
2. Tap an email account.
3. Tap  > **Account settings** to view the email account settings.
4. Tap **Account name** to change the account name.
5. Tap **OK** to confirm.

To set up email checking frequency



1. From the Home screen, tap  > **Email**.
2. Tap an email account.
3. Tap  > **Account settings** to view the email account settings.
4. Tap **Inbox check frequency**.

You can set the device to automatically check for new email every 5 minutes, every 10 minutes, every 15 minutes, every 30 minutes, every hour, or never.

To set up default account

1. From the Home screen, tap  > **Email**.
2. Tap an email account.
3. Tap  > **Account settings** to view the email account settings.
4. Tap **Default account** to send email from this account by default.

To delete an email account

1. From the Home screen, tap  > **Email**.
2. Tap the email account to delete.
3. Tap  > **Account settings** > **Remove account**.
4. Tap **OK** to confirm.

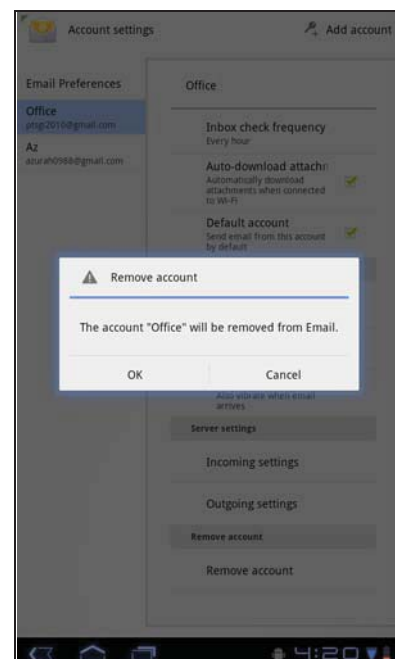
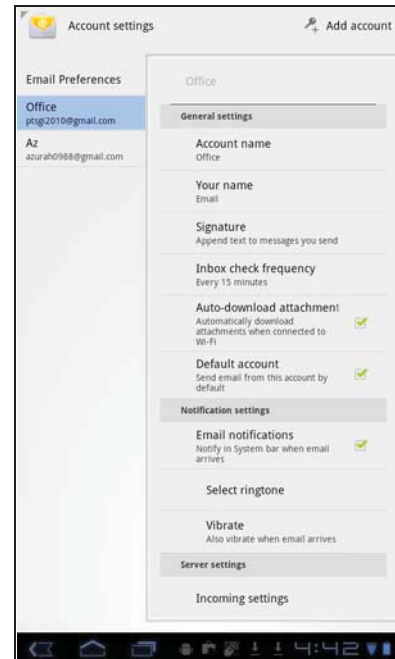

Chapter 5: Using Internet

5.1 Browsing Web Pages

1. From the Home screen, tap  > **Browser**.
2. Tap the address bar.
3. Type the URL. As you type, a list of URL suggestions appears on the screen.
4. Tap a match item in the list.

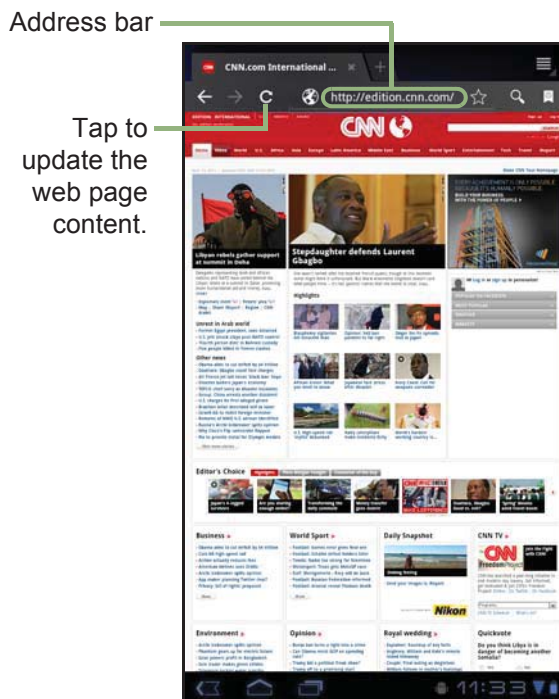

To scroll the page

To scroll up or down, swipe your finger down or up. To scroll left or right, tap and swipe your finger to the right or left.

To set Home page

1. While viewing a web page, tap  > **Settings** > **Set home page**.
2. Enter the URL of the page that you want to set as home page.
3. Select **Current page** or **Default page**.
4. Tap **OK** to save your settings.

Managing web pages

While viewing a web page, tap  to configure the browser settings:

- **General:** Select to set home page, and configure sync data and autofill settings.
- **Privacy & Security:** Select to configure privacy and security settings including cache, history, cookies, form data, location, and etc.
- **Advanced:** Select to set search engine, open in background, enable JavaScript, enable plug-ins, advanced settings for individual website, page content settings, and reset all settings to the factory default.
- **Labs:** Select to set quick control access and show the most visited pages.

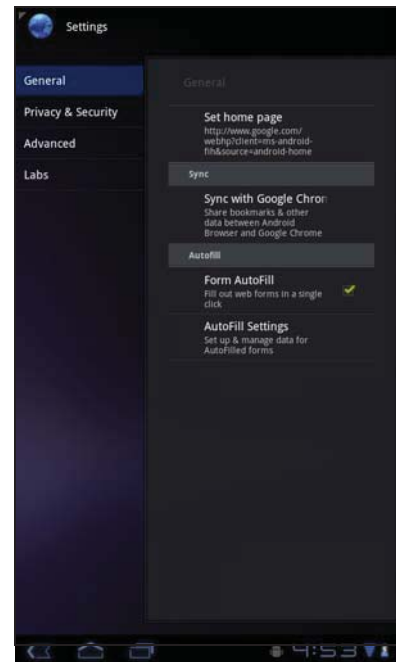

Chapter 6: Google Applications

The following sections cover Android and Google applications that come pre-installed on your device.

6.1 Gmail

Gmail is the email service provided by Google.

Signing in to Gmail

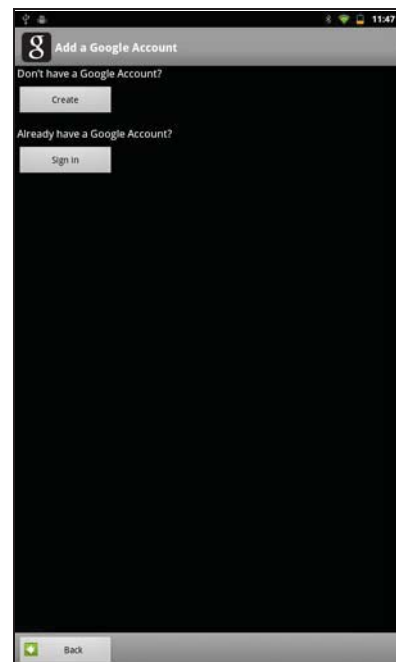

1. From the Home screen, tap  > **Gmail**.
2. Tap **Create** or **Sign in** in your Google account.
3. Follow the on-screen instructions to login or create your Gmail account.
4. Once logged in, you can begin reading and sending emails from your Gmail account.



Refreshing Gmail





1. From the Home screen, tap  > **Gmail**.
2. Tap **Menu** > **Refresh**.

Creating and sending emails

1. From the Home screen, tap  > **Gmail**.
2. Tap **Menu** > **Compose**.
3. Enter the recipient.
4. Enter the subject and compose your message.
5. If necessary, do any of the following:
 - To add Cc/Bcc, tap **Menu** > **Add Cc/Bcc**.
 - To attach files, tap **Menu** > **Attach**.
 - To save as draft, tap  or tap **Menu** > **Save draft**.
6. Tap  to send the email.





Reading and replying to emails

1. From the Home screen, tap  > **Gmail**.
2. Tap an email to read.
3. To reply, tap  (Reply) or  (Reply all).
4. Compose your message.
5. Tap  to send the email.

To preview and download attachments

1. From the Home screen, tap  > **Gmail**.
2. Tap an email to read.
3. Scroll to the end of the email and do any of the following:
 - To preview an attachment, tap **Preview**.
 - To download an attachment, tap **Download**.

Forwarding emails

1. From the Home screen, tap  > **Gmail**.
2. Tap an email to open.
3. To forward, tap .
4. Enter the recipient.
5. Tap  to send the email.

Managing emails

To delete emails

1. From the Home screen, tap  > **Gmail**.
2. Tap and hold an email, then tap **Delete**.

To add a star to emails

1. From the Home screen, tap  > **Gmail**.
2. Tap the star icon.

To select emails

1. From the Home screen, tap  > **Gmail**.
2. Tap the check icon.

To mark emails as read or unread

1. From the Home screen, tap  > **Gmail**.
2. Tap and hold an email, then tap **Mark read** or **Mark unread**.

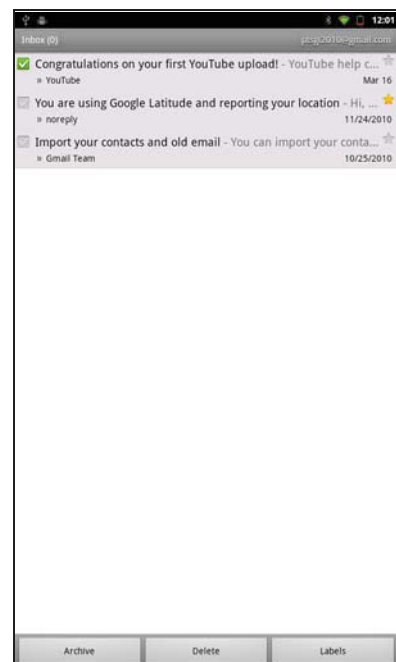
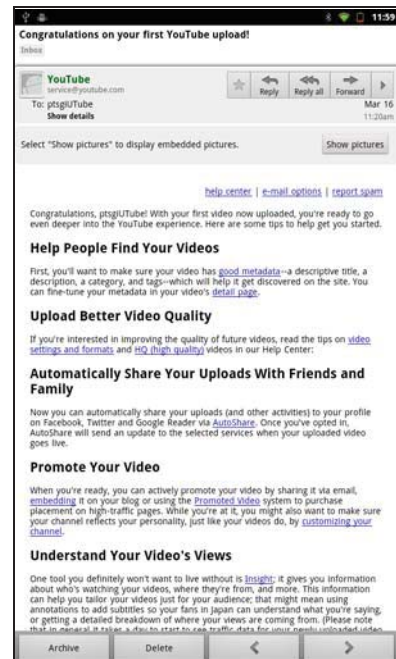

To place emails in archive

1. From the Home screen, tap  > **Gmail**.
2. Tap and hold an email, then tap **Archive**.

To mute emails

1. From the Home screen, tap  > **Gmail**.
2. Tap and hold an email, then tap **Mute**.



To change labels of emails

1. From the Home screen, tap  > **Gmail**.
2. Tap and hold an email, then tap **Change labels**.
3. Tap a label, then tap **OK**.

Viewing folder labels

1. From the Home screen, tap  > **Gmail**.
2. Tap **Menu** > **Go to labels**.

Searching for emails

1. From the Home screen, tap  > **Gmail**.
2. Tap **Menu** > **Search**.
3. Type the text to search, then tap .

Configuring Gmail settings

1. From the Home screen, tap  > **Gmail**.
2. Tap **Menu** > **More** > **Settings**.
3. Tap one of the following settings:
 - **Signature**: Add a text signature to your outgoing emails.
 - **Confirm actions**: Prompt for confirmation before archiving, deleting, or sending emails.
 - **Reply all**: Make “Reply all” as the default when replying emails.
 - **Auto-advance**: Select which screen to show after you delete or archive a conversation.
 - **Message text size**: Set the font size used in emails.
 - **Batch operations**: Allow label operations on more than one conversation.
 - **Clear search history**: Remove all the searches you have performed.
 - **Labels**: Select which labels are synchronized.
 - **Email notifications**: Displays a notification icon on the status bar when an email is received.
 - **Select ringtone**: Select email notification ringtone.
 - **Vibrate**: Enable the device to vibrate when an email is received.
 - **Notify once**: Notify once for new email, not for every new email.

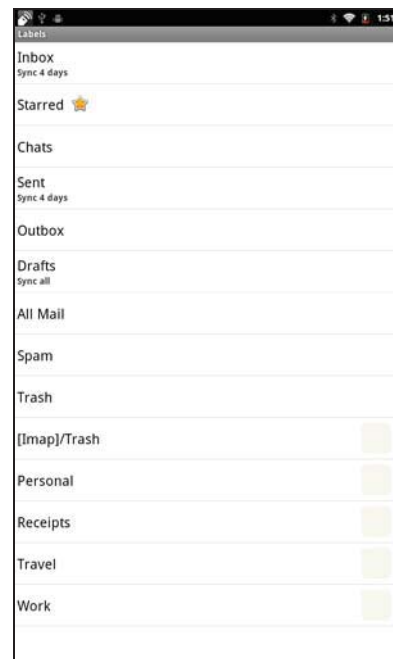

6.2 Talk

Use Google **Talk** to chat with your friends who also have Google accounts.







Signing in to Google Talk

1. From the Home screen, tap  > **Talk**.
2. Select an account and tap **Sign in**.

If you log in for the first time, enter your username and password, then tap **Sign in**.



Google Talk options

Once logged in, you can begin using Google Talk and do any of the following:

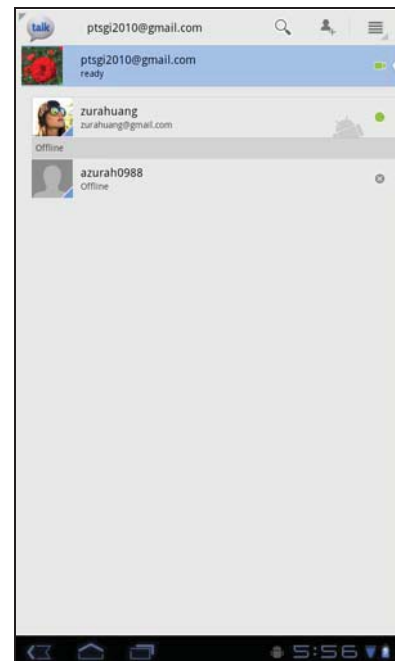
- To view friends list, tap  > **All friends**.
- To add friends to friend's list, tap .
- To search a person, tap .
- To sign out, tap  > **Sign out**.
- To configure Google Talk settings, tap  > **Settings**.
- To block a person, tap and hold an account and tap **Block friend**.
- To close all chats, tap  > **Close all chats**.











Starting chat



1. From the Home screen, tap  > **Talk**.
2. Tap a friend on your friends list.
3. Type your message, then tap .

Chatting Options

The following options can be accessed when a chat window is opened:

- To start video chat, tap  > **Video chat**.
- To chat off record, tap  > **Chat off record**.
- To switch chats, tap  > **Switch chats**.
- To view the Friends list window, tap  > **Friends list**.
- To invite another friend to join the chat, tap  > **Add to chat**.
- To close the chat, tap  > **End chat**.
- To clear previous chat history, tap  > **Clear chat history**.
- To insert smileys, tap  > **Insert smiley**.
- To view your friend's profile, tap  > **View in contacts**.

Configuring Google Talk settings

1. From the Home screen, tap  > **Talk**.
2. Tap  > **Settings**.
3. Tap one of the following settings:
 - **Sign in automatically:** Enable to automatically sign in when Google Talk is opened.
 - **Mobile indicator:** Enable to show mobile indicator to your friends.
 - **Set status to away when screen is turned off:** Enable to set status to away when the screen is turned off.
 - **IM notifications:** Enable to display a notification icon when an instant message is received.
 - **Notification Ringtone:** Select the ringtone to use when an instant message is received.
 - **Vibrate:** Enable to vibrate when an instant message is received.
 - **Invitation notifications:** Enable to display a notification icon when friends invitations are received.
 - **Video chat notifications:** Enable to display a notification icon when a video chat invitation is received.
 - **Video chat Ringtone:** Select the ringtone to use when a video chat invitation is received.
 - **Vibrate:** Enable to vibrate when a video chat invitation is received.
 - **Blocked friends:** View the blocked friends list.
 - **Clear search history:** Clear previous Google Talk chat searches from showing up in the Search box.
 - **Manage account:** Set the general sync settings and manage accounts.

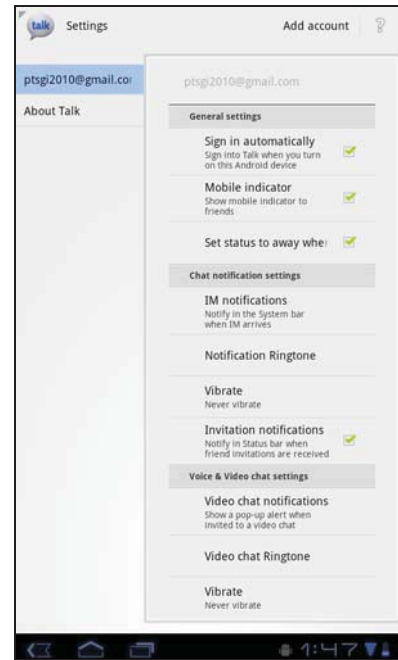

6.3 Maps



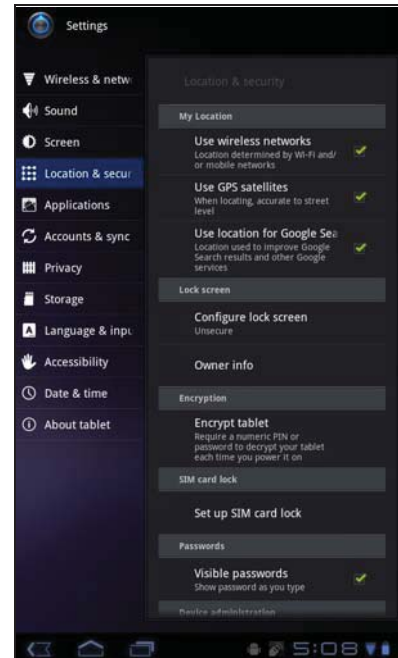

Use Google **Maps**TM to find places, view traffic and direction information, and find your friends' location.

Before starting **Maps**TM, do the following:

1. From the Home screen, tap  > **Settings** > **Location & security**.
2. Tap to enable **Use wireless networks**.
3. Tap to enable **Use GPS satellites**.





Viewing Map

1. From the Home screen, tap  > **Maps**.
2. Do any of the following:
 - Tap and hold an area on the map to view the address.
 - Slide your finger on the screen to scroll the map.
 - Tap the zoom controls to zoom in or out.
 - To select nearby attractions, tap  then tap the desired category.
 - To select Map mode, tap  then tap **Traffic**, **Satellite**, **Terrain**, **Buzz**, **Latitude**, **My Maps**, **Wikipedia**, **Transit Lines**, or **Favorite Places**.
 - To find your location, tap .
 - To search for a place of interest, tap the **Search Maps** box then type in a keyword to begin search.
 - To get direction, tap the address box and tap .



Finding places

1. From the Home screen, tap  > **Maps**.
2. Tap the **Search Maps** box.
3. Type the place to search on the text field.
4. Tap .
A callout appears to indicate the location of the searched place.

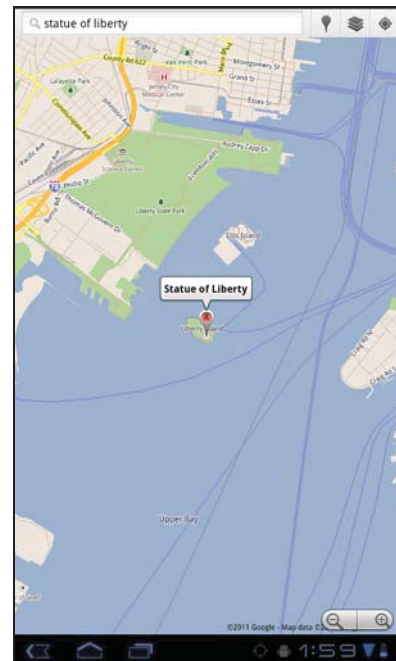

6.4 Navigation







Google Maps **Navigation** allows you to say the destination and get voice directions.

NOTE: Not available in all locations.

Before starting **Navigation**, do the following:



1. From the Home screen, tap  > **Settings** > **Location & security**.
2. Tap to enable **Use wireless networks**.
3. Tap to enable **Use GPS satellites**.

Getting directions

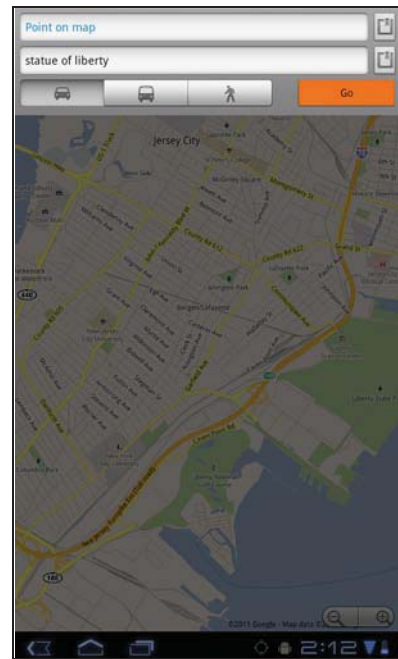
1. From the Home screen, tap  > **Navigation**.
2. Enter the starting point and the ending point, or tap the corresponding  and select an option.
3. Select a direction icon.
 -  : Driving directions
 -  : Transit directions
 -  : Walking directions
4. Tap  to view the directions.



Finding your current location



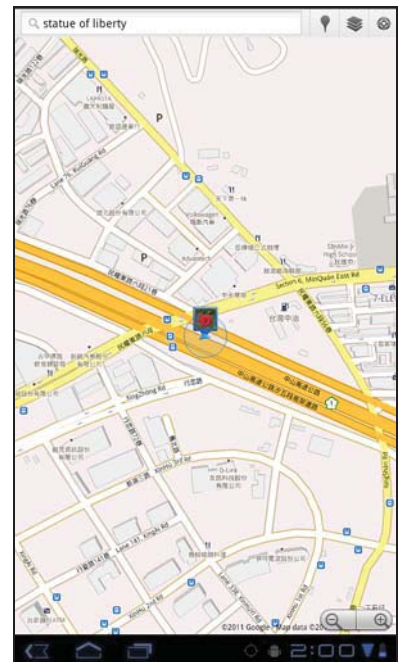

1. From the Home screen, tap  > **Navigation**.
2. Tap  to view your location on the map.
A blue blinking arrow indicates your current location on the map.



6.5 Latitude

With **Latitude**, you can view your friends' location and share your location to them on Google Maps™.

Starting Latitude

1. From the Home screen, tap  > **Latitude**.
2. Do any of the following:
 - To add friends, tap .
 - To refresh your friends list, tap .
 - To share your current location with your friends, tap  and select a place from the available list.
 - To view the map, tap your account > .
 - To change your privacy settings, tap your account > **Edit privacy settings**.



Configuring privacy settings

1. From the Home screen, tap  > **Latitude**.
2. Tap your account > **Edit privacy settings**.
3. Tap one of the following:
 - **Detect your location:** Select to automatically update your location.
 - **Set your location:** Select to manually set your location on the map.
 - **Do not detect your location:** Select to hide your location from your friends.
 - **Enable location history:** Select to store your previous locations and visualize them on the Latitude website.
 - **Enable automatic check-ins:** Select to enable you to check in at places that you chose.
 - **Enable check-in notifications:** Select to enable notifications that suggest places to check in.
 - **Manage your places:** Select to manage and modify your automatic check-ins and muted places.
 - **Sign out of Latitude:** Tap to sign out from Latitude.

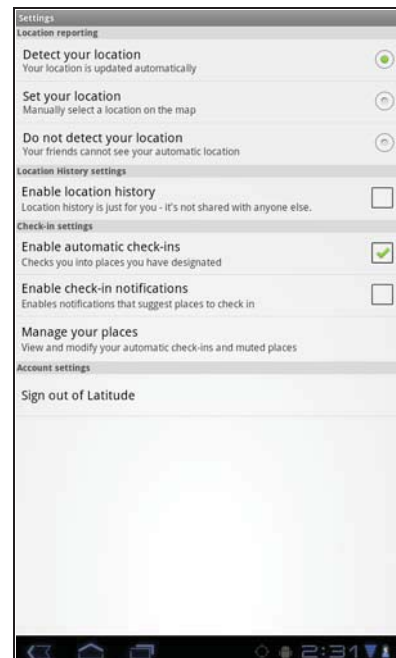

6.6 Market

Android **Market**[™] allows you to purchase and download games and other applications to your device.

When opening Android **Market** for the first time, the Terms of Service is displayed on screen. Tap **Accept** to accept the terms and continue.

NOTE: Android Market may not be supported in some countries.

Searching for applications

1. From the Home screen, tap  > **Market**.





2. To browse for an application, tap a category to view available applications.
3. To search, tap **Search Market** box.
4. Type the application name, then tap .

Downloading applications

1. From the Home screen, tap  > **Market**.
2. Search for desired application.
3. Tap the application that you want to download.
4. Tap **DOWNLOAD** > **OK**.

Removing applications

1. From the Home screen, tap  > **Market**.
2. Tap . The list of downloaded applications are displayed on screen.
3. Tap the application that you want to remove.
4. Tap **Uninstall**.

6.7 Places

Places is a location-based application that helps you find the places and things around you. Local information available includes restaurants, coffee shops, bars, hotels, attractions, ATMs, gas stations, and more. This application also helps you get where you are going with maps and directions.

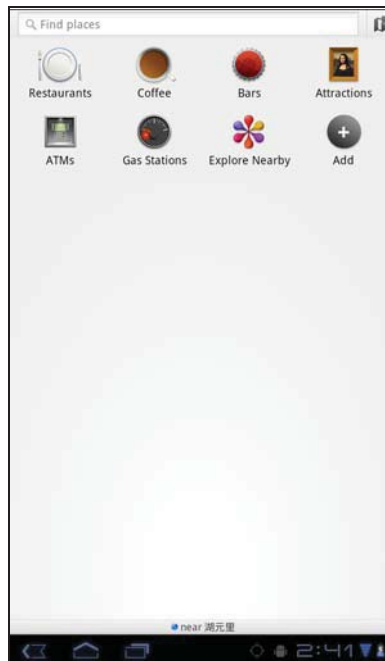

From the Home screen, tap  > **Places**.



6.8 Google Search

From the Home Screen, you can search information on your device and on the web with **Google Search** right away.

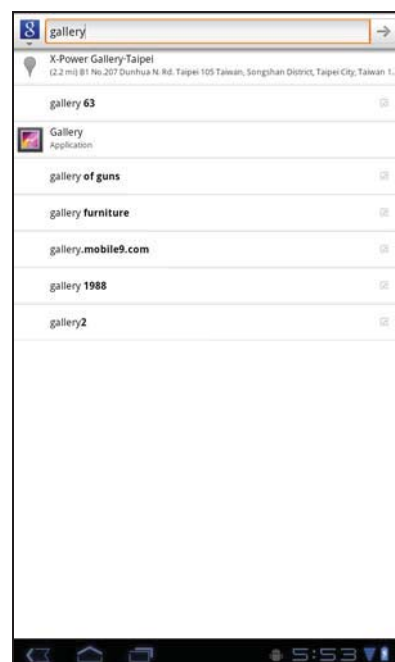

Searching information by entering text

1. From the Home screen, tap  > **Google Search** or tap **Google Search** widget.
2. Enter the text you are searching in the **Quick Search** box.
3. As you type, matching items on your device and suggestions from Google web search are added to the list of previously chosen search results. Tap a match item in the list.
4. If what you are searching is not in the list, tap  in the **Quick Search** box. The Browser opens, displaying results of a Google search on the web.



6.9 Voice Search

Speak your query to search item on Google, or for applications or contacts on your device.

1. From the Home screen, tap  > **Voice Search** or tap  in the **Quick Search** box.
2. A dialog opens, prompting you to speak the words that you want to search for.
3. When you are finished speaking, **Voice Search** analyzes your speech and displays the results of your search.
If **Voice Search** misunderstands you, Quick Search Box presents a list of similar-sounding search terms.

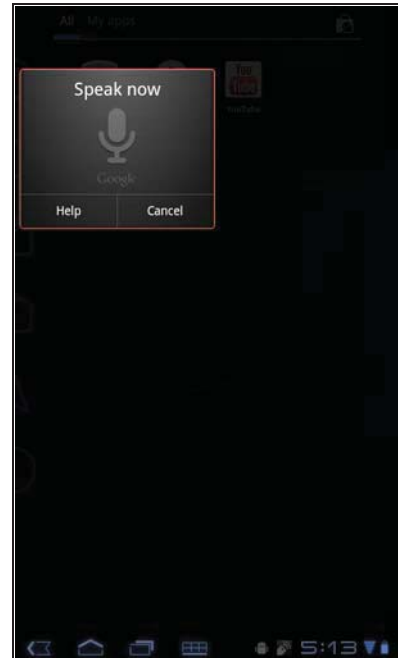



6.10 YouTube

YouTube allows you to watch, upload, and download videos to your device.



Watching videos

1. From the Home screen, tap  > **YouTube**.
2. Tap a video to start playback.

Uploading videos

1. From the Home screen, tap  > **YouTube**.
2. Tap  to record your video.
3. Sign in to your **YouTube** account.
4. Follow the on-screen instructions to upload your video.

Searching videos

1. From the Home screen, tap  > **YouTube**.
2. To search for videos, tap .
3. Type the keyword to search.
4. Tap .

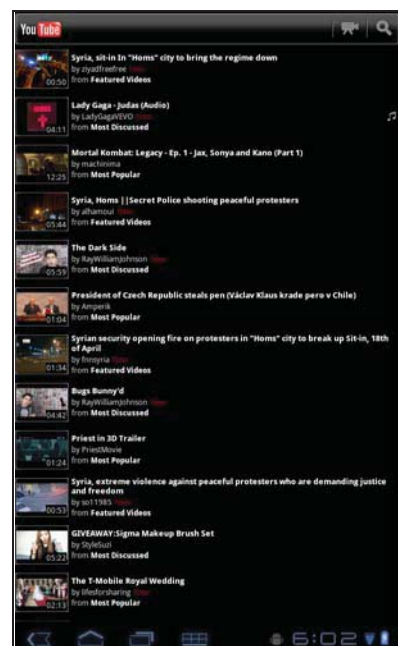

Chapter 7: Using Bluetooth

Bluetooth modes

- **On:** Bluetooth is turned on. Your device detects other Bluetooth devices, but your device is not visible to others.
- **Discoverable:** Bluetooth is turned on and your device is visible to other Bluetooth devices.
- **Off:** Bluetooth is turned off.

To turn Bluetooth on or off

1. From the Home screen, tap  **Apps** > **Settings** > **Wireless & networks**.
2. Tap **Bluetooth** check box to activate the Bluetooth function.
3. To make your device visible to others, tap **Bluetooth settings** > **Discoverable** check box to make this device visible to other devices.

7.1 Connecting to Bluetooth Devices

A connection to a Bluetooth device is called a partnership. You need to pair and create a partnership with a Bluetooth device to exchange information.

1. From the Home screen, tap  **Apps** > **Settings** > **Wireless & networks**.
2. Tap **Bluetooth settings** to view the menu options.
3. To search for a new device, tap **Find nearby devices** > **Scan for devices**.
4. Tap a detected device.
5. To start pairing, enter the **PIN** and tap **OK**.

NOTE:

- The PIN of the device must be the same PIN on the other bluetooth device.
 - On some devices, tap **Pair** to start pairing.
6. The paired bluetooth device name is displayed.

NOTE: Once a partnership has been created, connecting to that device again will no longer require entering the PIN.

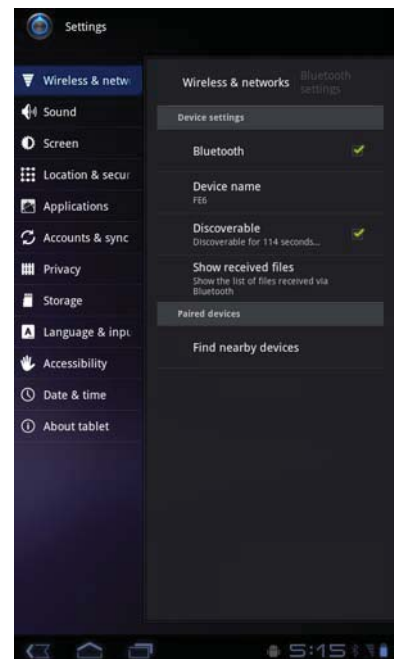





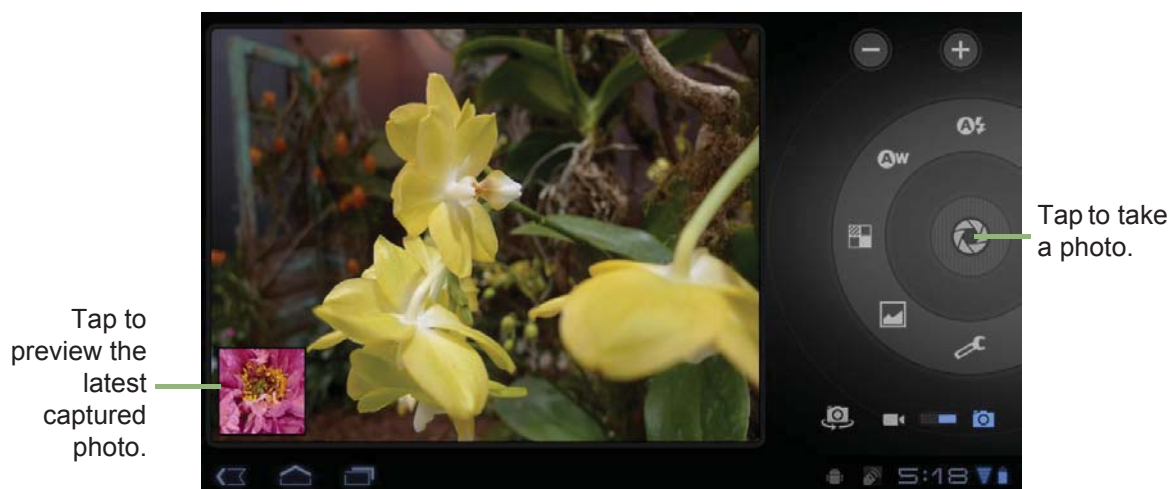

Chapter 8: Multimedia Applications

8.1 Photos and Videos

This device is equipped with rear and front cameras to take photos and videos. By default, your device uses the rear camera to take photos or record videos.





Taking a photo

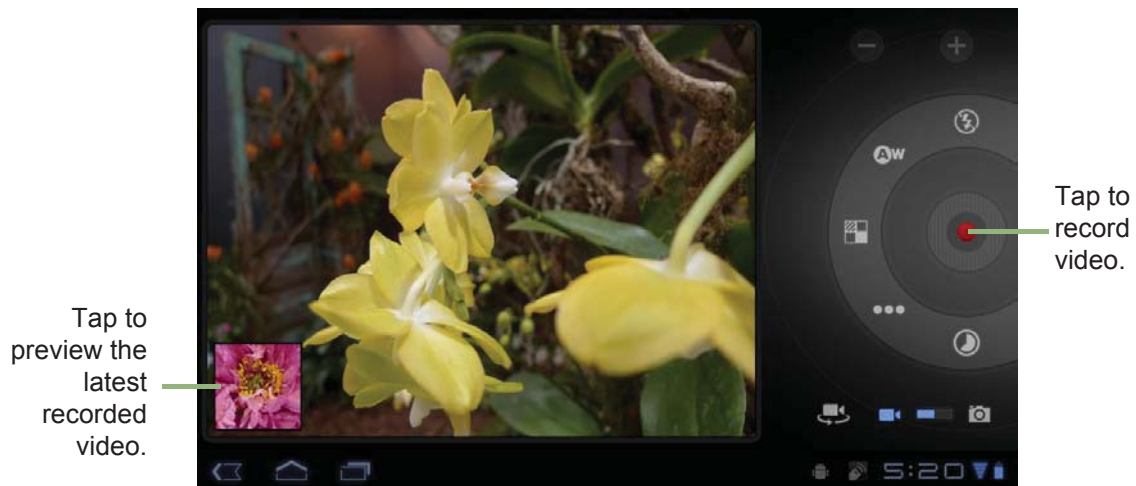

1. From the Home screen, tap **Apps** > **Camera**.
To switch to front camera, tap .
2. Aim the device at the subject.
Tap  /  to zoom in/out on the subject.
3. Tap  to take the shot.
To focus on the image before taking the shot, tap and hold . The focus frame turns green to indicate that the focus is set.





Recording a video



1. From the Home screen, tap  > **Camera**.
2. Tap  to switch to Camcorder mode.
To switch to front camera, tap .
3. Aim the device at the subject.
4. To start recording, tap .
To stop recording, tap .

Reviewing a photo







After taking a photo, tap the window located at bottom left corner to preview the latest captured photo on the screen.

- Tap  to start the slideshow.
- Tap  to share the photo via Picasa, Bluetooth, Gmail, or Email.
- Tap  to delete the photo. Then, tap **Confirm Delete** to confirm file deletion.
- Tap  to view photo details, rotate the photo to the left/right, set the photo as contact photo/wallpaper, or crop the photo.
- Tap  to return to Camera mode.



Reviewing a video

After recording a video, tap the window located at bottom left corner to preview the latest recorded video on the screen.

- Tap  to play the video.
- Tap  to start the slideshow.
- Tap  to share the video via YouTube, Bluetooth, Gmail, or Email.
- Tap  to delete the video. Then, tap **Confirm Delete** to confirm file deletion.
- Tap  to view the video details.
- Tap  to return to Camcorder mode.

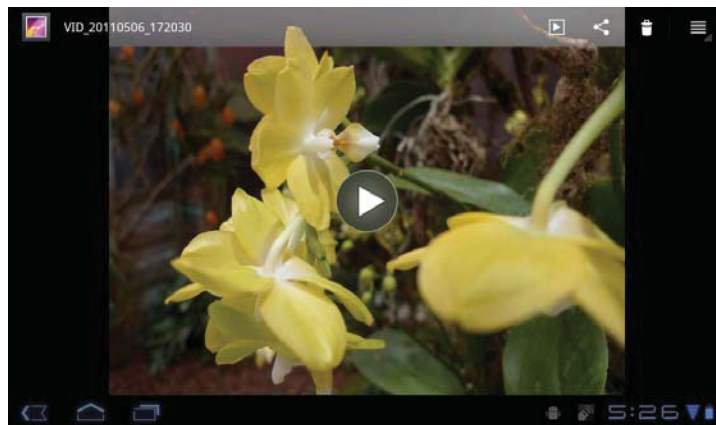

Configuring camera settings

Tap the icon (on the right side of the screen) to access the respective camera/camcorder menu. Swipe your finger up and down to scroll the page for more options.



Tap an option to configure camera settings.

Tap to view and adjust the general settings of your camera:





Mode	Setting	Available options
Camera mode	Flash mode	Auto, On, Off
	White balance	Auto, Incandescent, Daylight, Fluorescent, Cloudy
	Color effect	None, Mono, Sepia, Negative, Solarize
	Scene mode	Auto, Action, Portrait, Landscape, Night, Night portrait, Theatre, Beach, Snow
	Store location	Off, On
	Focus mode	Auto, Infinity, Macro
	Exposure	-2, -1, 0, +1, +2
	Picture size	5M Pixels, 3M Pixels, 2M Pixels, 1M Pixels, VGA
	Picture quality	Super fine, Fine, Normal
	Restore default	OK, Cancel
Video mode	Flash mode	On, Off
	White balance	Auto, Incandescent, Daylight, Fluorescent, Cloudy
	Color effect	None, Mono, Sepia, Negative, Solarize
	Video quality	High, Low, YouTube (High, 15m)
	Time lapse interval	Off, 1s, 1.5s, 2s, 2.5s, 3s, 5s, 10s

8.2 Viewing Photos & Videos

Viewing photos

1. From the Home screen, tap  > **Gallery**.
2. Tap the desired folder to view the images in thumbnails.
3. Tap an image to view.



4. Swipe your finger to the left/right to view the previous/next image.
 - To play the slideshow, tap .
 - To share the photo via Picasa, Bluetooth, Gmail, or Email, tap .
 - To delete the photo, tap . Then, tap **Confirm Delete** to confirm file deletion.
 - To edit the photo, tap  to show more options.



Playing videos

1. From the Home screen, tap  > **Gallery**.
2. Tap the desired folder to view the videos in thumbnails.
3. Tap the video to playback.



8.3 Using Music Player

You can transfer music to the device from the computer. From the Home screen, tap  > **Music**.

Music screen

- **Playback screen:** Displays the playback area with the playback controls.

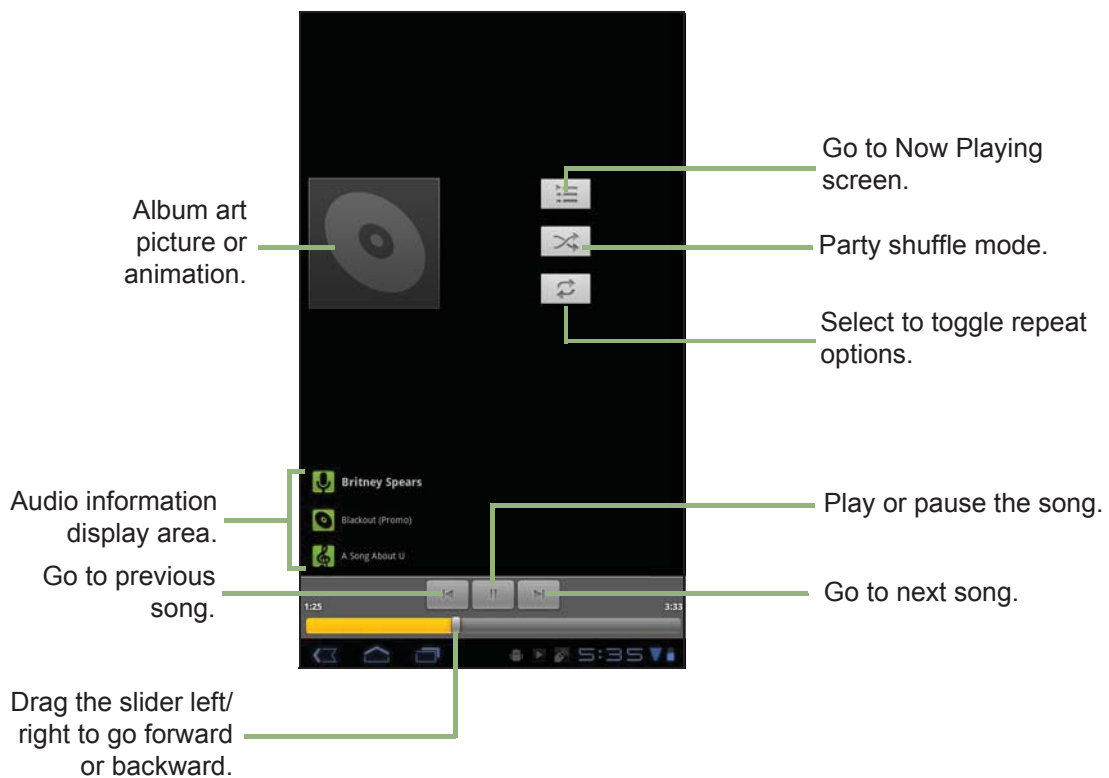

- **Library screen:** Displays folder categories to search for media files. It contains the following categories: **Artists**, **Albums**, **Songs**, and **Playlists**.



- **Now Playing screen:** Displays the song currently playing. Drag the media files to arrange the sequence for playback.

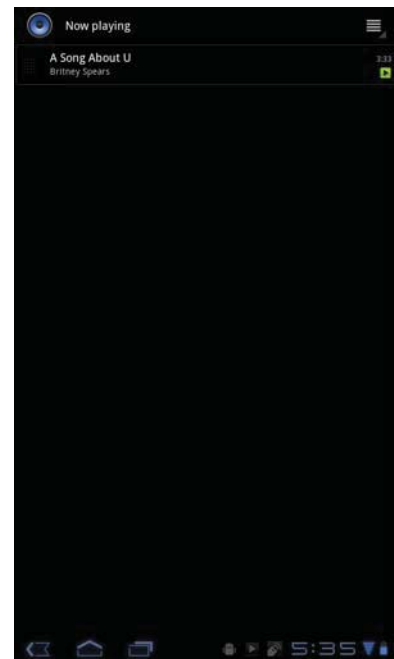

Playing music

To play music

1. From the Home screen, tap  > **Music**.
The Library screen is displayed.
2. Tap **Songs** to view the list of songs.
3. Tap a song to play.



Managing playlists

To add a music file to playlist

Add songs to a specific playlist or create a playlist.

1. From the Home screen, tap  > **Music**.
The Library screen is displayed.
2. Browse for the song that you want to add in a playlist.
3. Tap and hold the song.
4. Tap **Add to playlist**.
5. Select from the current playlist or tap **New** to create a new playlist. The song is added to the playlist.

NOTE: If you create a new playlist, enter the playlist name, then tap **Save**.



To remove a music file from playlist

1. From the Home screen, tap  > **Music**.
The Library screen is displayed.
2. Tap **Playlists** and browse for the playlist.
3. Tap and hold the song that you want to remove from the playlist.
4. Tap **Remove from playlist**.
The song is removed from the playlist.

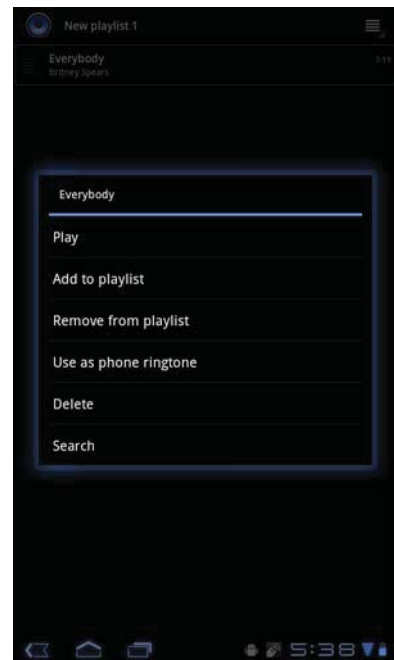





8.4 Sharing Media

Once your device has an active network connection, you can share media content on your device to other shared computers or NAS devices located on the same network as your device.

Viewing media files



You can view the media content stored on other shared computers or NAS device located on the same network.

1. From the Home screen, tap  > **Myriad UPnP Remote**.
2. On the top of the screen, select the appropriate media player type.
 - To play videos, select **My Video Player**.
 - To play music, select **My Music Player**.
 - To view photos, select **My Slideshow**.
3. Tap the desired media server from the server list.
4. Browse the media files on the available folders.
5. Tap the desired file(s) to play.
A green tick icon appears on the selected file.
6. Slide  up, and tap  to play/view the selected file(s).
 - To add the selected file(s) into the playlist, tap .



Downloading media files

You can download the media content stored on other media server to your device.

1. From the Home screen, tap  > **Myriad UPnP Server**.
2. Tap the desired media server from the server list.
3. Browse the media files on the available folders.
4. Tap the desired file(s) to download.
A green tick icon appears on the selected file.
5. Slide  up, and tap  to download the selected file(s).
All files are saved in the memory card.

Sharing media files



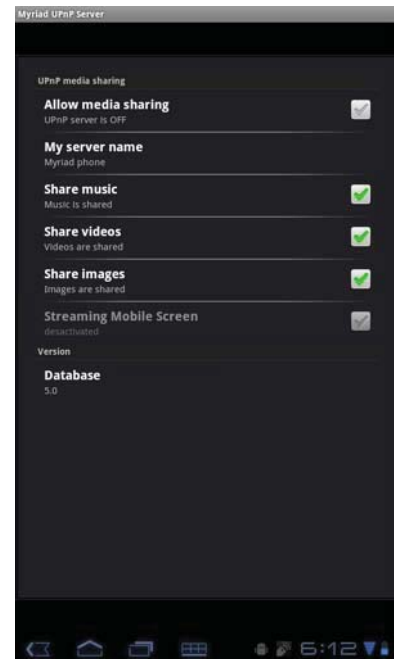

You can share the media content stored on your device to other media servers located on the same network.

1. From the Home screen, tap  > **Myriad UPnP Server**.
2. Tap the item that you want to share.
3. To change the server name, tap **My server name**.
Enter the server name and tap **OK**.
4. After all settings are completed, tap **Allow media sharing** check box to activate the Media Share function.
5. To view the media files, see “Viewing media files” on page 48.



Uploading media files

You can upload the media content stored on your device to other media servers.

1. From the Home screen, tap  > **Myriad UPnP Server**.
2. Tap **Allow media sharing** check box to activate the Media Share function.
3. Tap  to exit and tap **Myriad UPnP Remote**.
4. Tap your device media server.
5. Browse the media files on the available folders.
6. Tap the desired file(s) to upload.
A green tick icon appears on the selected file.
7. Slide  up, and tap  to upload the selected file(s).













NOTE: When switching from one Wi-Fi network to another, it is recommended to restart **Myriad UPnP Remote** application and tap  > **Kill all UPnP activities** check box to reset all media sharing activities.

Chapter 9: Applications

Your device comes with the following pre-installed applications.

Application	Description
 Browser	Browse the web and download files from the Internet. See page 25.
 Calculator	Perform basic arithmetic functions, such as addition, subtraction, multiplication, and division. See page 53.
 Calendar	Create and track schedule or appointments. See page 53.
 Camera	Capture photos and record videos. See page 40.
 Clock	Set up alarms. See page 63.
 Contacts	Store names, numbers, email, and other information. See page 15.
 Downloads	View or delete the files that you have downloaded in Browser, Gmail, or Email. See page 54.
 Email	Send and receive email messages. See page 21.
 File Browser	Manage audio, video, photo, and other files. See page 55.
 FM Radio	Tune and listen to the radio. See page 56.
 Gallery	View and edit photos and videos. See page 44.
 Gmail	Access your Gmail account on your device. See page 27.
 Google Search	Search applications and contacts on your device, and the Internet using Google Search. See page 37.
 Latitude	See your friends' locations and share yours with them. You need to sign in with your Google account to use this feature. See page 35.
 Maps	View the map and get directions to your destination. See page 32.

Application	Description
 Market	Purchase games and other applications from Android Market and download them to your device. See page 36.
 Music	Play and manage music and audio files on your device. See page 45.
 Navigation	Use to track your location, find places, and get driving directions to your destination. See page 33.
 Myriad UPnP Remote	Use to view the media content stored on other media server or NAS storage on the same network. See page 48.
 Myriad UPnP Server	Use to share your device media content with other computers on the same network. See page 49.
 Places	Help you to find the places around you. Local information available includes restaurants, coffee shops, bars, hotels, attractions, ATMs, gas stations, and more. See page 37.
 Settings	Configure wireless settings and other general settings of your device. See page 59.
 Talk	Log in and chat with friends using Google Talk. See page 30.
 TouchPal Input	Configure the keyboard settings. See page 19.
 Voice Search	Use Google Search by saying the word instead of typing them. See page 38.
 YouTube	Watch videos from YouTube on your device. See page 38.

9.1 Browser

Open the **Browser** to view web pages. See “Browsing Web Pages” on page 25.

9.2 Calculator

With **Calculator**, you can perform basic arithmetic functions on your device.



1. From the Home screen, tap  > **Calculator**.
2. Use the on-screen calculator keypads to perform arithmetic calculation.



9.3 Calendar

The **Calendar** lets you schedule and sound alarms for appointments, meetings and other events. Scheduled appointments for the day can be displayed on the Home screen.

To schedule an event

1. From the Home screen, tap  > **Calendar**.
2. Tap .
3. Enter the event details.
4. Select the date and time for **From** and **To** fields.
NOTE: For an all-day event, check **All day**.
5. To set repetition, select the repetition from the list.
6. To set a reminder, select the time from the list.
7. When finished, tap .

TIP: From the Calendar screen, tap and hold a day or a time slot then set a new appointment on the tapped date or time.

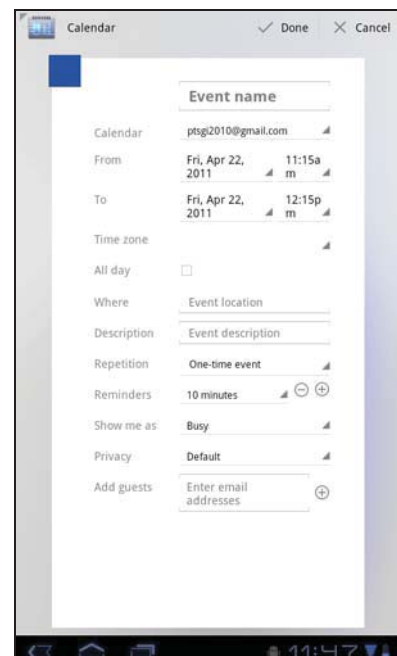

9.4 Camera

Capture photos and record videos with this device. See “Photos and Videos” on page 40.

9.5 Clock

Set alarms with this device. See “Alarms settings” on page 63.

9.6 Contacts

View or manage your contact list. See “Contacts” on page 15.



9.7 Downloads

Use **Downloads** to view or delete what you have downloaded in Browser, Gmail, or Email.

NOTE: The downloaded files are stored in the “Download” folder in your memory card.

1. From the Home screen, tap  > **Download**.
2. Tap an item to view it.

Managing files

- To delete a file, tap the check box on the left side of the image. A green tick appears, tap **Delete**.
- To sort the file by size, tap  > **Sort by size**.
- To sort the file by time, tap  > **Sort by time**.
- To view files that have been downloaded earlier, tap the headings.

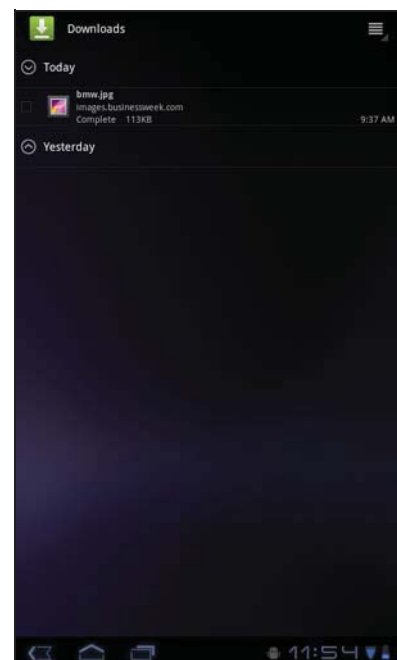

9.8 Email







Use **Email** to connect to your remote mailbox and retrieve your email messages from your device. See “Using Email” on page 21.

9.9 File Browser

File Browser lets you browse the contents of your device and the memory card.

1. From the Home screen, tap  **Apps** > **File Browser**.
2. Tap the folder list and tap the folder you want to explore.

Managing files and folders



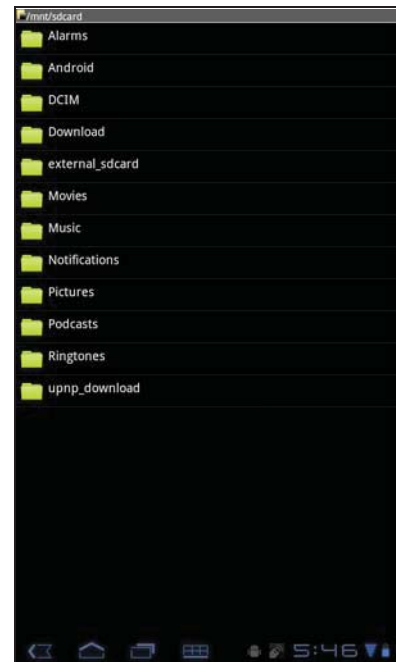





- To open a folder or file, tap the file or folder.
- To move, delete, rename or view file or folder details, tap and hold to view the options. Then tap a desired option.
- To copy, tap and hold a file or folder, then tap **Copy**. To paste a file or folder, tap  > **Paste**.
- To create a new folder, tap  > **New folder**.
- To sort items, tap  > **Sort**, then tap a sorting option.
- To mark a file or folder, tap  > **Mark**.
- To copy all files and folders, tap  > **Copy all**.
- To delete all files and folders, tap  > **Delete all**.
- To search for a file, tap  > **More** > **Search**.



9.10 FM Radio

FM Radio lets you listen to the FM radio.

NOTE: You must connect a headset or an earphone to use this function.

1. From the Home screen, tap  > **FM Radio**.
2. Do any of the following:
 - To manually tune to a frequency, tap on a desired frequency.
 - To tune to another radio station, tap  or .
 - To view the Favorite List, tap .
 - To add the current radio station into the Favorite list, tap , and then enter the station name and tap **OK**.
 - To set the desired radio station frequency, tap . Enter the radio frequency and tap **OK**.
 - To turn on the speaker, tap  > **Speaker**.
 - To mute the sound, tap  > **Mute**.
 - To change other radio settings, tap  > **Settings**.



9.11 Gallery

You can view your captured images, recorded video clips, and downloaded images in **Gallery**.

1. From the Home screen, tap  > **Gallery**.
2. Tap the desired folder to view the camera pictures or camera videos.
The images or videos are displayed in thumbnails.
3. To view photos or videos, see “Viewing Photos & Videos” on page 44.

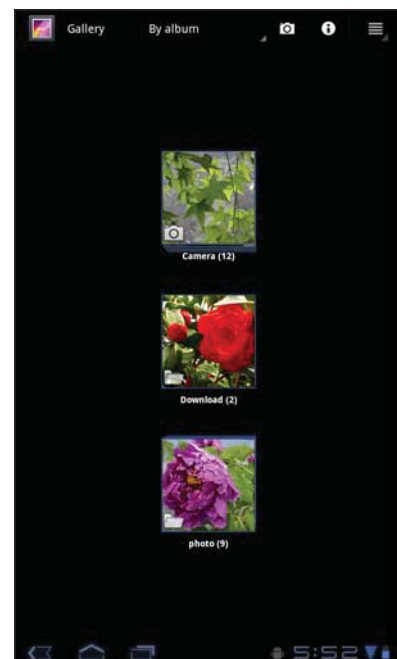

9.12 Gmail

Use **Gmail** to send and receive emails using your Google email account. See “Gmail” on page 27.

9.13 Google Search

Search information on your device and on the web with **Google Search**. See “Google Search” on page 37.

9.14 Latitude

Latitude allows you to keep track of your friends’ location and share your location to them. See “Latitude” on page 35.

9.15 Maps

Use **Maps** to view the map and get directions to your destination. See “Maps” on page 32.

9.16 Market

Use **Market** to purchase and download games and other applications to your device. See “Market” on page 36.

9.17 Music

Use **Music** to play music files or recorded voice files. See “Using Music Player” on page 45.

9.18 Myriad UPnP Remote

With **Myriad UPnP Remote**, you share media content on your device to other shared computers or NAS devices located on the same network as your device. See “Sharing Media” on page 51.

9.19 Myriad UPnP Server

Use **Myriad UPnP Server** to enable media sharing stored on your device to other media servers located on the same network. See “Sharing media files” on page 52.

9.20 Navigation

Use **Navigation** to locate your location and provide a real time turn by turn direction to your chosen destination. See “Navigation” on page 33.

9.21 Places

Places is a location-based application that helps you find the places and things around you. See “Places” on page 37.

9.22 Settings

In the **Settings** menu, you can view and make adjustments for wireless & network settings, device general settings and security settings. See “Device Settings” on page 59.

9.23 Talk

Use **Talk** to chat with your friends. See “Talk” on page 30.

9.24 TouchPal Input

Use **TouchPal Input** to configure the keyboard settings. See “Configuring Keyboard Settings” on page 19.

9.25 Voice Search

Use **Voice Search** to say the words to search in the Internet using Google search engine. See “Voice Search” on page 38.

9.26 YouTube

Use **YouTube** to watch, upload, and view videos from YouTube using your device. See “YouTube” on page 38.

Chapter 10: Managing Your Device

10.1 Device Settings

From the Home screen, tap  > **Settings** to view and adjust the settings of your device. Settings menu is categorized into: **Wireless & networks**, **Sound**, **Screen**, **Location & security**, **Applications**, **Accounts & sync**, **Privacy**, **Storage**, **Language & input**, **Accessibility**, **Date & time**, and **About tablet**.

Wireless & networks

Application	Description
Airplane mode	Disable all wireless connections.
Wi-Fi settings	Manage Wi-Fi connections, scan and connect to available Wi-Fi networks.
Bluetooth settings	Manage connections, set device name, and discoverability of the device.
Tethering	Share your tablet's mobile data connection via USB or Bluetooth.
VPN settings	Set up and manage Virtual Private Networks (VPNs).

Sound

Application	Description
Vibrate	Device vibrates for incoming calls (only during Silent mode).
Volume	Adjust the volume for media, notification, and alarms.
Notification ringtone	Set your default notification ringtone.
Audible selection	Enable/disable sound when making screen selection.
Screen lock sounds	Play sounds when locking or unlocking the screen.
Haptic feedback	Play sound when pressing soft keys and on certain UI interactions.

Screen

Application	Description
Brightness	Adjust the brightness of the screen.
Auto-rotate screen	Switch orientation automatically when rotating the device.
Animation	Show animation when opening and closing windows.

Application	Description
Timeout	Adjust delay before the screen automatically goes off.

Location & security

Application	Description
Use wireless networks	Allow location to be determined by Wi-Fi and/or mobile networks
Use GPS satellites	Enable GPS satellites.
Use location for Google	Use location to improve Google Search results and other Google services.
Configure lock screen	Set the lock screen with a pattern, PIN, or password.
Owner info	Show owner info on the lock screen.
Encrypt tablet	Set user to enter a PIN or password to decrypt your device each time you turn it on.
Visible passwords	Show passwords as you type.
Device administrators	Add or remove device administrators.
Use secure credential	Allow applications to access secure certificates and other credentials.
Install from USB storage	Install encrypted certificates from USB storage.
Set password	Set or change the credential storage password.
Clear credentials	Clear credential storage of all contents and reset its password.

Applications

Application	Description
Manage applications	Manage and remove installed applications.
Running services	View and control currently running services.
Storage use	View storage used by applications.
Battery use	View the battery usage on the currently running applications.
Unknown sources	Allow to install non-market applications.
Development	Set options for application development.

Accounts & sync

Application	Description
Background data	Enable background data usage.
Auto-sync	Automatically sync data.
Manage accounts	Tap Add account to add an account to configure synchronization settings for Calendar, Contacts, and Gmail.

Privacy

Applications	Description
Back up my data	Back up the current settings and other application data.
Back up account	Back up the account data for debugging purpose.
Automatic restore	Automatically restore backed up settings and other data after application reinstallation.
Factory data reset	Delete all data on the device and restore to factory default settings.

Storage

Application	Description
USB storage	Show available memory card storage.
Internal storage	Show available device storage.

Language & input

Application	Description
Select language	Set the on-screen display language for your device.
Voice recognizer settings	Set the voice recognizer settings.
Text-to-speech settings	Set the text-to-speech settings.
Current input method	Set on-screen keyboard input method.
Input method selector	Set the input method selector setting.
Configure input methods	Configure on-screen keyboard settings.

Accessibility

Application	Description
Download accessibility	Configure the settings for the downloaded application with an accessibility feature.

Date & time

Application	Description
Automatic date & time	Check to use network provided time.
Automatic time zone	Check to use network provided time zone.
Set date	Set the date.
Set time	Set the time.
Select time zone	Select the time zone of your current location.
Use 24-hour format	Set the clock to 24-hour format.
Select date format	Set the preferred date format.

About tablet

Check the system update and view device status, battery usage, legal information, model number, and software version.

10.2 Changing Basic Settings

Date and time settings

To automatically set date and time

1. From the Home screen, tap  > **Settings** > **Date & time**.
2. Tap **Automatic date & time** and **Automatic time zone** to automatically set the date and time according to the network.

To manually set date and time

1. From the Home screen, tap  > **Settings** > **Date & time**.
2. Tap **Set date** to set the date.
 - To adjust the date, tap the month, day, or year field, and tap ▲ or ▼ to increase or decrease the value. Tap **Set** to apply the values.
 - To change the date format, tap **Select date format**, and select the date format from the list.
3. Tap **Select time zone** to select the time zone from the list.
4. Tap **Set time** to set the time.
 - To adjust the time, tap the hour, minute, second or AM/PM field, and tap + or - to increase or decrease the value. Tap **Set** to apply the values.
 - To use 24-hour format, tap **Use 24-hour format**.

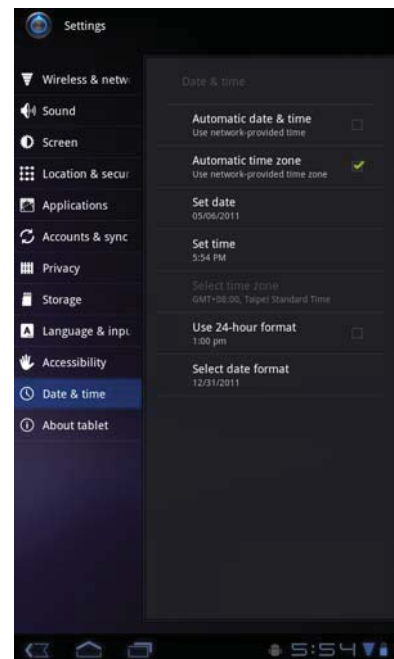

Alarms settings

You can set up alarms on this device.

To set the alarm

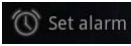
1. From the Home screen, tap  > **Clock**.
2. Tap .
3. To add an alarm, tap **Add alarm**.
4. Tap the ▲ or ▼ to set the alarm time, and tap **Set**.
5. To set repeat mode, tap **Repeat**. Tap one or more options, then tap **OK**.
6. To set the ringtone, tap **Ringtone**. Tap an option, then tap **OK**.
7. To vibrate when alarm sounds, check **Vibrate**.
8. To enter an alarm label, tap **Label**.
9. After all settings are completed, tap **Done**.



Display settings

The display settings of this device affect the battery and external power level.

To turn off backlight when the device is idle

1. From the Home screen, tap  > **Settings** > **Screen**.
2. Tap **Timeout**.
3. Select from the screen timeout list. Your setting is automatically saved.

To adjust brightness

1. From the Home screen, tap  > **Settings** > **Screen**.
2. Tap **Brightness**.
3. Drag the **Brightness** slider to adjust brightness settings.
4. Tap **OK** when finished.

To change the screen orientation

1. From the Home screen, tap  > **Settings** > **Screen**.
2. Tap **Auto-rotate screen** to automatically switch the screen orientation when rotating the device.

Ringtone settings

You can assign a default ringtone whenever a new notification is received.

To change the notification ringtone

1. From the Home screen, tap  > **Settings** > **Sound**.
2. Tap **Notification ringtone**.
3. Tap the preferred ringtone from the list.
4. Tap **OK** to confirm.

10.3 Using Wireless & networks

Wireless & networks allows you to manage Wi-Fi, Bluetooth, Tethering, and Virtual Private Networks (VPNs).

1. From the Home screen, tap  > **Settings** > **Wireless & networks**.
2. If necessary, do any of the following:
 - To enable or disable **Wi-Fi** or **Bluetooth**, tap their corresponding boxes.
 - To configure Wi-Fi or Bluetooth settings, tap **Wi-Fi settings** or **Bluetooth settings**.
 - To share your device mobile data connection via USB or Bluetooth, tap **Tethering**.
 - To set up and manage Virtual Private Networks (VPNs), tap **VPN settings**.

10.4 Protecting Your Device

You can protect your device from unauthorized users by requiring the PIN code or entering a password.

Screen lock protection settings

You can increase your device security by creating a screen unlock pattern (disabled by default). When enabled, you must draw the correct unlock pattern on the screen to unlock and regain access to the device.

1. From the Home screen, tap  > **Settings** > **Location & security**.
2. Tap **Configure lock screen**.
3. Tap **Pattern** to draw pattern to unlock screen.
4. Follow on-screen instructions to draw your own personal unlock pattern and tap **Continue**.
5. Redraw your unlock pattern again and tap **Confirm**.

10.5 Resetting the Device

You can reset your device to its factory defaults.

1. From the Home screen, tap  > **Settings** > **Privacy**.
2. Tap **Factory data reset**.
3. Tap **Reset tablet** to reset.

Safety Information

Please read before proceeding

- Use only the battery and the power adapter provided by the manufacturer. Use of unauthorized accessories may void your warranty.
- Avoid using the device near electromagnetic sources such as TVs, radios, and microwave ovens.
- Unplug the power adapter from the wall outlet during lightning storms to avoid electric shock or fire.
- Do not expose the device or the battery to direct sunlight.
- Do not store your device in temperatures higher than 50°C.
- Do not use harsh chemicals or detergents to clean your device.
- Do not handle the device with wet hands while it is being charged. This may cause an electric shock or serious damage to the device.
- The operating temperature for this device is from 0°C to 50°C.
- [Following all precautions and instructions will increase the life of the device.](#)

SAFETY PRECAUTIONS FOR BATTERY USE

- Use only approved battery.
- Keep the battery dry and away from any liquid since this may cause a short circuit.
- Keep the battery away from metal objects since this may cause a short circuit.
- Do not use damaged or deformed batteries.
- If the battery emits a foul odor, discontinue use.
- Keep the battery away from babies and small children.
- [The battery is not removable.](#)
- [End users shall not remove the embedded battery by themselves.](#)

If the battery leaks:

- Do not allow the leaking fluid to come in contact with your skin, eyes or clothing. If already in contact, rinse with clean water immediately and seek medical advice.
- Keep the battery away from fire since this may cause the battery to explode.
- Do not attempt to open or service the battery yourself.
- Do not dispose battery in fire or water.
- Recycle or dispose used batteries according to the local regulations.

ROAD AND ENVIRONMENTAL SAFETY

- Turn off the device in areas with a potentially explosive atmosphere or where flammable objects exist such as gas stations, fuel depots, and chemical plants among others. Sparks from these areas could cause explosion or fire and result in injury or even death.
- Do not use device while driving a vehicle.

SAFETY IN AIRCRAFT

Do not use the device on board an aircraft. The device's network signals may cause interference to the navigation system. As a safety measurement, it is against the law in most countries to use the device on board an aircraft.

Copyright© 2011. All Rights Reserved.

Android is a trademark of Google Inc. Use of this trademark is subject to Google Permissions.

This product has an Android™ platform based on Linux, which can be expanded by a variety of JME-based application SW.

All products use in this device and trademarks mentioned herein are trademarks or registered trademarks of their respective owners.

Google™, the Google logo, Android™, the Android logo and Gmail™ are trademarks of Google Inc. Use of this trademark is subject to Google Permissions.

Wi-Fi and the Wi-Fi CERTIFIED logo are registered trademarks of the Wireless Fidelity Alliance.

microSD™ is a trademark of SD Card Association.

Bluetooth and the Bluetooth logo are trademarks owned by Bluetooth SIG, Inc.

Java, JME and all other Java-based marks are trademarks or registered trademarks of Sun Microsystems, Inc. in the United States and other countries.

The prediction engine of the input method is TOUCHPAL, provided by COOTEK.

SAR Information

THIS MOBILE DEVICE MEETS GUIDELINES FOR EXPOSURE TO RADIO WAVES. Your mobile device is a radio transmitter and receiver. It is designed not to exceed the limits for exposure to radio waves recommended by international guidelines. These guidelines were developed by the independent scientific organization ICNIRP and include safety margins designed to assure the protection of all persons, regardless of age and health.

The exposure guidelines for mobile devices employ a unit of measurement known as the Specific Absorption Rate or SAR. The SAR limit stated in the ICNIRP guidelines is 2.0 W/kg averaged over 10 grams of tissue. Tests for SAR are conducted using standard operating positions with the device transmitting at its highest certified power level in all tested frequency bands. The actual SAR level of an operating device can be below the maximum value because the device is designed to use only the power required to reach the network. That amount changes depending on a number of factors such as how close you are to a network base station. The highest SAR value under the ICNIRP guidelines for use of the device at the body is 0.423 W/kg.

Use of device accessories and enhancements may result in different SAR values.

SAR values may vary depending on national reporting and testing requirements and the network band. [The device could be used with a separation distance of 0 cm to the human body.](#)

FCC Regulations:

- This device complies with part 15 of the FCC Rules. Operation is subject to the following two conditions: (1) This device may not cause harmful interference, and (2) this device must accept any interference received, including interference that may cause undesired operation.
- This device has been tested and found to comply with the limits for a Class B digital device, pursuant to Part 15 of the FCC Rules. These limits are designed to provide reasonable protection against harmful interference in a residential installation. This equipment generates, uses and can radiate radio frequency energy and, if not installed and used in accordance with the instructions, may cause harmful interference to radio communications. However, there is no guarantee that interference will not occur in a particular installation. If this equipment does cause harmful interference to radio or television reception, which can be determined by turning the equipment off and on, the user is encouraged to try to correct the interference by one or more of the following measures:
 - Reorient or relocate the receiving antenna.
 - Increase the separation between the equipment and receiver.
 - Connect the equipment into an outlet on a circuit different from that to which the receiver is connected.
 - Consult the dealer or an experienced radio/TV technician for help.

Changes or modifications not expressly approved by the party responsible for compliance could void the user's authority to operate the equipment.

- The antenna(s) used for this transmitter must not be co-located or operating in conjunction with any other antenna or transmitter

RF Exposure Information (SAR)

This device is in compliance with SAR for general population /uncontrolled exposure limits in ANSI/IEEE C95.1-1999 and had been tested in accordance with the measurement methods and procedures specified in OET Bulletin 65 Supplement C.

This equipment complies with FCC RF radiation exposure limits set forth for an uncontrolled environment. This device was tested for operations with the device contacted directly to the human body to the back side of the EUT. To maintain compliance with FCC RF exposure compliance requirements, avoid direct contact to the transmitted antenna during transmitting. The highest SAR value for the device as reported to the FCC when worn on the body, as described in this user guide is **1.46 W/kg** (Body-worn measurements differ among device models, depending upon available enhancements and FCC requirements.)

WEEE Notice

The WEEE logo on the product or on its box indicates that this product must not be disposed of or dumped with your other household waste. You are liable to dispose of all your electronic or electrical waste equipment by relocating over to the specified collection point for recycling of such hazardous waste. Isolated collection and proper recovery of your electronic and electrical waste equipment at the time of disposal will allow us to help conserve natural resources. Moreover, proper recycling of the electronic and electrical waste equipment will ensure safety of human health and environment. For more information about electronic and electrical waste equipment disposal, recovery, and collection points, please contact your local city center, household waste disposal service, shop from where you purchased the equipment, or manufacturer of the equipment.

RoHS Compliance

This product is in compliance with Directive 2002/95/EC of the European Parliament and of the Council of 27 January 2003, on the restriction of the use of certain hazardous substances in electrical and electronic equipment (RoHS) and its amendments.

European Union Regulatory Conformance

The equipment complies with the RF Exposure Requirement 1999/519/EC, Council Recommendation of 12 July 1999 on the limitation of exposure of the general public to electromagnetic fields (0–300 GHz). This equipment meets the following conformance standards: EN50360, EN62209-1, EN60950-1, IEC60950-1, EN50332-1/2, EN301489-1, EN301489-3, EN301489-7, EN301489-17, EN301489-24, EN301511, EN301908-1/2, EN300328, EN300440-1/2, EN55022, EN55024.

For the device which tests accordance to EN60950-1:2006, it is mandatory to perform audio tests for EN50332. This device have been tested to comply with the Sound Pressure Level requirement laid down in the applicable EN 50332-1 and EN 50332-2 standards. Permanent hearing loss may occur if earphones or headphones are used at high volume for prolonged periods of time.



A pleine puissance, l'écoute prolongée du baladeur peut endommager l'oreille de l'utilisateur.

The conformity assessment procedure has been followed with the involvement of the following Notified Body:

PHOENIX TESTLAB

Identification mark: CE0700 (Notified Body) CE

CE 0700 !

Changes or modifications to this product not authorized by the manufacturer could void the EMC compliance and negate your authority to operate the product. This product has demonstrated EMC compliance under conditions that included the use of compliant peripheral devices and shielded cables between system components. It is important that you use compliant peripheral devices and shielded cables between system components to reduce the possibility of causing interference to radios, televisions, and other electronic devices.

We, hereby, declare that this cellular, Wi-Fi, & Bluetooth radio is in compliance with the essential requirements and other relevant provisions of Directive 1999/5/EC.

Power saving reminder:

CE Energy-Related Products Directive 2009/125/EC Information

Please ask the local distributor, supplier or importer below information:

- The related information of recycle or dispose.
- The related information of spare parts issue.
- Maintenance service.
- [When you don't use this device for a long period, please turn off this device and you can save more electric power.](#)

Intellectual Property Right Information

Right to all technologies and products that comprise this device are the property of their respective owners:

This product has an Android platform based on Linux, which can be expanded by a variety of Java-Script-based application SW.

Google, the Google logo, Android, the Android logo, Gmail, and YouTube are trademarks of Google Inc.

Bluetooth and the Bluetooth logo are trademarks owned by Bluetooth SIG, Inc.

Java, JME and all other Java-based marks are trademarks or registered trademarks of Sun Microsystems, Inc. in the United States and other countries.

microSD is a trademark of SD Card Association.

The prediction engine of the input method is TOUCHPAL, provided by COOTEK.

This equipment may be operated in:							
AT	BE	BG	CH	CY	CZ	DE	DK
EE	ES	FI	FR	GB	GR	HU	IE
IT	IS	LI	LT	LU	LV	MT	NL
NO	PL	PT	RO	SE	SI	SK	TR

Products with 2.4-GHz Wireless LAN Devices France

For 2.4-GHz wireless LAN operation of this product, certain restrictions apply. This equipment may use the entire-2400-MHz to 2483.5-MHz frequency band (channels 1 through 13) for indoor applications. For outdoor use, only 2400-2454 MHz frequency band (channels 1-9) may be used. For the latest requirements, see <http://www.art-telecom.fr>.

Specifications

Connectivity	
GPS	GPS / AGPS
Wi-Fi	802.11 b/g/n
Bluetooth	2.1 with EDR
USB	USB 2.0 High-Speed client (micro-B type)
Power	
Battery	2 cell battery pack (1600mAH, in series), unremovable
AC Adapter	AC input voltage: 100-240Vac, 50/60Hz AC input current: 200mAac max. DC output voltage: 12Vdc (typical) DC output current: 1.5 A (typical)
Temperature	
Operating	-15°C to 50°C
Non-operating / Storage	-20°C to 70°C
Charging	0°C to 50°C
Humidity	
Operating	10% to 90% non-condensing
Non-operating / Storage	5% to 95% non-condensing

A

- Address bar 25
- Adjust
 - brightness 64
 - date and time 63
- Applications 51
- Assign
 - notification ringtone 64

B

- Battery
 - Charge 3
- Bluetooth 39
 - connecting 39
- Browser
 - home page 25
 - settings 26

C

- Calculator 53
- Camera
 - recording videos 41
 - settings 42
 - taking photos 40
- Clock 54
- Contacts 15

D

- Device
 - protect 65
 - reset 65
 - settings 59
- Display
 - backlight 64
 - brightness 64
 - orientation 64

Downloads 54

E

- Email 20
 - accounts set up 20
 - add attachments 21
 - composing 21
 - managing 23
 - reading and replying 22
 - receiving 22
 - sending 21

F

File Browser 55

FM Radio 56

G

- Gallery 56
- Gmail 27
- Google Search 37

H

- Headset 4
- Home screen 7

I

- Icons
 - Status Bar 8
- Internet 25
 - browsing 25

K

- Keyboard
 - on-screen 18

L

Latitude 35

M

- Maps 32
- Market 36
 - downloading applications 36
 - removing applications 36
 - searching applications 36
- Media Sharing
 - downloading files 49
 - sharing files 49
 - uploading files 50
 - viewing files 48
- Micro USB port 2
- Music 57
 - music player 45
- Myriad UPnP Remote 48, 57
- Myriad UPnP Server 57

N

Navigation 33

P

- Photo
 - taking photos 40
 - viewing photos 41
- Places 37

P

- button 2
- turn on and off 5

S**S**
Screen

- orientation 64

Settings

- alarms 63
- basic 63
- date and time 63
- display 64
- keyboard 19
- ringtone 64

T

Talk 30

Text

- entering 18

TouchPal Input 58

U

Unlock screen 6

V

Video

- recording videos 41
- viewing videos 42

Voice Search 38

Volume

- adjusting 12

W

Wireless & networks 64

- Bluetooth 39
- tethering 64
- VPN settings 64
- Wi-Fi 13

Y

YouTube 38

- searching videos 38
- uploading videos 38
- watching videos 38