

SHARP®

LC-20DV20U

COMBINATION LIQUID CRYSTAL
TELEVISION AND DVD/CD PLAYER
COMBINÉ TÉLÉVISEUR ACL ET
LECTEUR DVD/CD
COMBINACION TELEVISOR CON PANTALLA
DE CRISTAL LÍQUIDO CON DVD/DISCOS COMPACTOS

OPERATION MANUAL
MODE D'EMPLOI
MANUAL DE OPERACIÓN



NOM 1245



DD **DOLBY**
DIGITAL

DVD
VIDEO



dts
DIGITAL OUT

COMPACT
disc
DIGITAL AUDIO

MP3

HDMI
HIGH-DEFINITION MULTIMEDIA INTERFACE

HIGH-DEFINITION TELEVISION
HDTV
MONITOR



Products that have earned the ENERGY STAR® are designed to protect the environment through superior energy efficiency.

Les produits agréés ENERGY STAR® sont conçus pour protéger l'environnement par un rendement énergétique supérieur.

Los productos que han ganado la marca ENERGY STAR® han sido diseñados para proteger el medio ambiente mediante una eficiencia superior en el uso de la energía.

ENGLISH

FRANÇAIS

ESPAÑOL

LC-20DV20U

COMBINATION LIQUID CRYSTAL TELEVISION AND DVD/CD PLAYER

ENGLISH

OPERATION MANUAL

- The illustrations and on-screen displays in this operation manual are for explanation purposes and may vary slightly from the actual operations.
- Menu items that are not selectable are grayed out.

IMPORTANT:



To aid reporting in case of loss or theft, please record the TV/DVD's model and serial numbers in the space provided. The numbers are located at the rear of the TV/DVD.

Model No.:

Serial No.:

IMPORTANT INFORMATION

WARNING: TO REDUCE THE RISK OF FIRE OR ELECTRIC SHOCK, DO NOT EXPOSE THIS PRODUCT TO RAIN OR MOISTURE.

	CAUTION RISK OF ELECTRIC SHOCK DO NOT OPEN	
CAUTION: TO REDUCE THE RISK OF ELECTRIC SHOCK, DO NOT REMOVE COVER (OR BACK). NO USER-SERVICEABLE PARTS INSIDE. REFER SERVICING TO QUALIFIED SERVICE PERSONNEL.		



The lightning flash with arrow-head symbol, within an equilateral triangle, is intended to alert the user to the presence of uninsulated "dangerous voltage" within the product's enclosure that may be of sufficient magnitude to constitute a risk of electric shock to persons.



The exclamation point within a triangle is intended to alert the user to the presence of important operating and maintenance (servicing) instructions in the literature accompanying the product.

IMPORTANT INFORMATION

CAUTION: TO PREVENT ELECTRIC SHOCK, MATCH WIDE BLADE OF PLUG TO WIDE SLOT, FULLY INSERT.

CAUTION:

DO NOT PLACE THIS PRODUCT ON AN UNSTABLE CART, STAND, TRIPOD, BRACKET, OR TABLE. THE PRODUCT MAY FALL CAUSING SERIOUS PERSONAL INJURY AND SERIOUS DAMAGE TO THE PRODUCT. USE ONLY WITH A CART, STAND, TRIPOD, BRACKET, OR TABLE RECOMMENDED BY THE MANUFACTURER OR SOLD WITH THE PRODUCT. FOLLOW THE MANUFACTURER'S INSTRUCTIONS WHEN INSTALLING THE PRODUCT AND USE MOUNTING ACCESSORIES RECOMMENDED BY THE MANUFACTURER. A PRODUCT AND CART COMBINATION SHOULD BE MOVED WITH CARE. QUICK STOPS, EXCESSIVE FORCE, AND UNEVEN SURFACES MAY CAUSE THE PRODUCT AND CART COMBINATION TO OVERTURN.



WARNING: FCC Regulations state that any unauthorized changes or modifications to this equipment not expressly approved by the manufacturer could void the user's authority to operate this equipment.

U.S.A. ONLY

CAUTION:

This product satisfies FCC regulations when shielded cables and connectors are used to connect the unit to other equipment. To prevent electromagnetic interference with electric appliances such as radios and televisions, use shielded cables and connectors for connections.

U.S.A. ONLY

"Note to CATV system installer: This reminder is provided to call the CATV system installer's attention to Article 820-40 of the National Electrical Code that provides guidelines for proper grounding and, in particular, specifies that the cable ground shall be connected to the grounding system of the building, as close to the point of cable entry as practical."

U.S.A. ONLY

This product utilizes tin-lead solder, and fluorescent lamp containing a small amount of mercury. Disposal of these materials may be regulated due to environmental considerations. For disposal or recycling information, please contact your local authorities or the Electronic Industries Alliance: www.eia.org

CAUTION:

THIS DIGITAL VIDEO PLAYER EMPLOYS A LASER SYSTEM.

TO ENSURE PROPER USE OF THIS PRODUCT, PLEASE READ THIS USER'S GUIDE CAREFULLY AND RETAIN FOR FUTURE REFERENCE. SHOULD THE UNIT REQUIRE MAINTENANCE, CONTACT AN AUTHORIZED SERVICE LOCATION SEE SERVICE PROCEDURE.

USE OF CONTROLS, ADJUSTMENTS OR THE PERFORMANCE OF PROCEDURES OTHER THAN THOSE SPECIFIED HEREIN MAY RESULT IN HAZARDOUS RADIATION EXPOSURE.

TO PREVENT DIRECT EXPOSURE TO LASER BEAM, DO NOT TRY TO OPEN THE ENCLOSURE. VISIBLE LASER RADIATION MAY BE PRESENT WHEN THE ENCLOSURE IS OPENED. DO NOT STARE INTO BEAM.

DECLARATION OF CONFORMITY

SHARP COMBINATION LIQUID CRYSTAL TELEVISION AND DVD CD PLAYER, MODEL LC-20DV20U.

This device complies with Part 15 of the FCC Rules. Operation is subject to the following two conditions:

(1) This device may not cause harmful interference, and (2) this device must accept any interference received, including interference that may cause undesired operation.

RESPONSIBLE PARTY:

SHARP ELECTRONICS CORPORATION

Sharp Plaza, Mahwah, New Jersey 07430-2135

TEL: 1-800-BE-SHARP

For Business Customers: URL <http://www.sharpusa.com>

U.S.A. ONLY

INFORMATION:

This equipment has been tested and found to comply with the limits for a Class B digital device, pursuant to Part 15 of the FCC Rules. These limits are designed to provide reasonable protection against harmful interference in a residential installation. This equipment generates, uses and can radiate radio frequency energy and, if not installed and used in accordance with the instructions, may cause harmful interference to radio communications. However, there is no guarantee that interference will not occur in a particular installation. If this equipment does cause harmful interference to radio or television reception, which can be determined by turning the equipment off and on, the user is encouraged to try to correct the interference by one or more of the following measures:

—Reorient or relocate the receiving antenna.

—Increase the separation between the equipment and receiver.

—Connect the equipment into an outlet on a circuit different from that to which the receiver is connected.

—Consult the dealer or an experienced radio/TV technician for help.

U.S.A. ONLY

Trademarks

• Manufactured under license from Dolby Laboratories. "Dolby" and the double-D symbol are trademarks of Dolby Laboratories.

• "HDMI, the HDMI logo and High-Definition Multimedia Interface are trademarks or registered trademarks of HDMI Licensing LLC."

• "DTS" and "DTS Digital Out" are trademarks of Digital Theater Systems, Inc.

DEAR SHARP CUSTOMER

Thank you for your purchase of the Sharp Combination Liquid Crystal Television and DVD/CD player. To ensure safety and many years of trouble-free operation of your product, please read the Important Safety Instructions carefully before using this product.

IMPORTANT SAFETY INSTRUCTIONS

Electricity is used to perform many useful functions, but it can also cause personal injuries and property damage if improperly handled. This product has been engineered and manufactured with the highest priority on safety. However, improper use can result in electric shock and/or fire. In order to prevent potential danger, please observe the following instructions when installing, operating and cleaning the product. To ensure your safety and prolong the service life of your Liquid Crystal Television, please read the following precautions carefully before using the product.

- 1) Read these instructions.
- 2) Keep these instructions.
- 3) Heed all warnings.
- 4) Follow all instructions.
- 5) Do not use this apparatus near water.
- 6) Clean only with dry cloth.
- 7) Do not block any ventilation openings. Install in accordance with the manufacturer's instructions.
- 8) Do not install near any heat sources such as radiators, heat registers, stoves, or other apparatus (including amplifiers) that produce heat.
- 9) Do not defeat the safety purpose of the polarized or grounding-type plug. A polarized plug has two blades with one wider than the other. A grounding type plug has two blades and a third grounding prong. The wide blade or the third prong are provided for your safety. If the provided plug does not fit into your outlet, consult an electrician for replacement of the obsolete outlet.
- 10) Protect the power cord from being walked on or pinched particularly at plugs, convenience receptacles, and the point where they exit from the apparatus.
- 11) Only use attachments/accessories specified by the manufacturer.
- 12) Use only with the cart, stand, tripod, bracket, or table specified by the manufacturer, or sold with the apparatus. When a cart is used, use caution when moving the cart/apparatus combination to avoid injury from tip-over.
- 13) Unplug this apparatus during lightning storms or when unused for long periods of time.
- 14) Refer all servicing to qualified service personnel. Servicing is required when the apparatus has been damaged in any way, such as power-supply cord or plug is damaged, liquid has been spilled or objects have fallen into the apparatus, the apparatus has been exposed to rain or moisture, does not operate normally, or has been dropped.



Additional Safety Information

- 15) Power Sources—This product should be operated only from the type of power source indicated on the marking label. If you are not sure of the type of power supply to your home, consult your product dealer or local power company. For products intended to operate from battery power, or other sources, refer to the operating instructions.
- 16) Overloading—Do not overload wall outlets, extension cords, or integral convenience receptacles as this can result in a risk of fire or electric shock.
- 17) Object and Liquid Entry—Never push objects of any kind into this product through openings as they may touch dangerous voltage points or short-out parts that could result in a fire or electric shock. Never spill liquid of any kind on the product.
- 18) Damage Requiring Service—Unplug this product from the wall outlet and refer servicing to qualified service personnel under the following conditions:
 - a) When the AC cord or plug is damaged,
 - b) If liquid has been spilled, or objects have fallen into the product,
 - c) If the product has been exposed to rain or water,
 - d) If the product does not operate normally by following the operating instructions.
Adjust only those controls that are covered by the operating instructions as an improper adjustment of other controls may result in damage and will often require extensive work by a qualified technician to restore the product to its normal operation,
 - e) If the product has been dropped or damaged in any way, and
 - f) When the product exhibits a distinct change in performance - this indicates a need for service.
- 19) Replacement Parts—When replacement parts are required, be sure the service technician has used replacement parts specified by the manufacturer or have the same characteristics as the original part. Unauthorized substitutions may result in fire, electric shock, or other hazards.
- 20) Safety Check—Upon completion of any service or repairs to this product, ask the service technician to perform safety checks to determine that the product is in proper operating condition.
- 21) Wall or ceiling mounting—When mounting the product on a wall or ceiling, be sure to install the product according to the method recommended by the manufacturer.

IMPORTANT SAFETY INSTRUCTIONS

- Water and Moisture — Do not use this product near water - for example, near a bath tub, wash bowl, kitchen sink, or laundry tub; in a wet basement; or near a swimming pool; and the like.
- Stand — Do not place the product on an unstable cart, stand, tripod or table. Placing the product on an unstable base can cause the product to fall, resulting in serious personal injuries as well as damage to the product. Use only a cart, stand, tripod, bracket or table recommended by the manufacturer or sold with the product. When mounting the product on a wall, be sure to follow the manufacturer's instructions. Use only the mounting hardware recommended by the manufacturer.
- Selecting the location — Select a place with no direct sunlight and good ventilation.
- Ventilation — The vents and other openings in the cabinet are designed for ventilation. Do not cover or block these vents and openings since insufficient ventilation can cause overheating and/or shorten the life of the product. Do not place the product on a bed, sofa, rug or other similar surface, since they can block ventilation openings. This product is not designed for built-in installation; do not place the product in an enclosed place such as a bookcase or rack, unless proper ventilation is provided or the manufacturer's instructions are followed.
- The Liquid Crystal panel used in this product is made of glass. Therefore, it can break when the product is dropped or applied with impact. Be careful not to be injured by broken glass pieces in case the panel breaks.
- Heat — The product should be situated away from heat sources such as radiators, heat registers, stoves, or other products (including amplifiers) that produce heat.
- The Liquid Crystal panel is a very high technology product with 3,147,264 thin film transistors, giving you fine picture details. Occasionally, a few non-active pixels may appear on the screen as a fixed point of blue, green or red. Please note that this does not affect the performance of your product.
- Lightning — For added protection for this television equipment during a lightning storm, or when it is left unattended and unused for long periods of time, unplug it from the wall outlet and disconnect the antenna. This will prevent damage to the equipment due to lightning and power-line surges.
- Power Lines — An outside antenna system should not be located in the vicinity of overhead power lines or other electric light or power circuits, or where it can fall into such power lines or circuits. When installing an outside antenna system, extreme care should be taken to keep from touching such power lines or circuits as contact with them might be fatal.
- Outdoor Antenna Grounding — If an outside antenna is connected to the television equipment, be sure the antenna system is grounded so as to provide some protection against voltage surges and built-up static charges. Article 810 of the National Electrical Code, ANSI/NFPA 70, provides information with regard to proper grounding of the mast and supporting structure, grounding of the lead-in wire to an antenna discharge unit, size of grounding conductors, location of antenna-discharge unit, connection to grounding electrodes, and requirements for the grounding electrode.

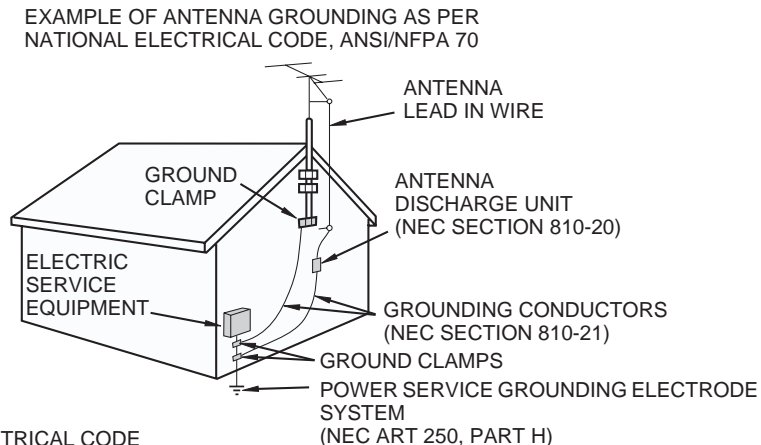





- To prevent fire, never place any type of candle or flames on the top or near the TV set.
- To prevent fire or shock hazard, do not expose this product to dripping or splashing. No objects filled with liquids, such as vases, should be placed on the product.
- To prevent fire or shock hazard, do not place the AC cord under the TV set or other heavy items.
- Turn off the main power and unplug the AC cord from the wall outlet before handling.
- Use a soft cloth and gently wipe the surface of the display panel. Using a hard cloth may scratch the panel surface.
- Use a soft damp cloth to gently wipe the panel when it is really dirty. (It may scratch the panel surface when wiped strongly.)
- If the panel is dusty, use an anti-static brush, which is commercially available, to clean it.
- To protect the panel, do not use a dirty cloth, liquid cleaners or chemical cloth to clean it, such materials may damage the panel surface.
- Do not display a still picture for a long time, as this could cause an afterimage to remain.
- Install the product on the place where the AC cord can be unplugged easily from the AC outlet, or from the AC INPUT terminal on the rear of the product.
- CONDENSATION — Moisture will form in the operating section of the player if the player is brought from cool surroundings into a warm room or if the temperature of the room rises suddenly. When this happens, player's performance will be impaired. To prevent this, let the player stand in its new surroundings for about an hour before switching it on, or make sure that the room temperature rises gradually. Condensation may also form during the summer if the player is exposed to the breeze from an air conditioner. In such cases, change the location of the player.
- DISC SLOT — Keep your fingers well clear of the disc slot as it is closing. Failure to do so may cause serious personal injury.
- LASER BEAM — Do not look into the opening of the disc slot or ventilation opening of the product to see the source of the laser beam. Doing so may cause sight damage.
- DISC — Do not use a cracked, deformed, or repaired disc. These discs are easily broken and may cause serious personal injury and product malfunction.

Disc

Discs which can be played back

In this unit, use only discs that meet the standard, such as those bearing the below logo marks on the disc label surface. If you use a non-standard disc, we cannot guarantee playback. Even if such a disc can be played back, we cannot guarantee the image or sound quality. The DVD logo is a registered trademark.

Media type	Logo mark
DVD-Video	
DVD-R/RW (Video format only)	
Audio CD*	
CD-R/CD-RW (CD-DA, MP3, WMA or JPEG format)	

- * This unit is designed to playback music Compact Discs (CD) that conform to the CD standard. CDs that contain (copy-restriction) signals to protect copyrights cannot be played back.
- Some CD-R/RWs and DVD-R/RW can not be played back depending on the recording conditions.
- 8 cm discs can be played without an adapter.

Region management information

This unit is designed and manufactured to support the region management information that is recorded on a DVD disc. If the region number written on the DVD disc does not correspond to the region number of this unit, this unit cannot play that disc.

- The region number of this unit is "1".
- The unit will play DVD-Video discs marked with labels containing "1" or "ALL".

Example:



Operating DVD-Video

- Some operations of DVD-Video may be prohibited by the manufacturer, or some operation methods or functions of the DVD-Video may be different from the description in this manual.
- If you attempt an operation that is prohibited by either the disc or the unit, a "⏸" mark will appear on the TV screen. For operations prohibited by the disc, see the information that came with the disc.
- When the menu screen or the operation guide appears during disc playback, follow the displayed information.

Discs which cannot be played back

The discs listed below cannot be played back in general. Even if one of these can be played back, it may not be played back correctly. If a disc is played back by mistake, extensively loud sounds may blow the speakers or may damage the hearing of those in hearing range. Do not playback the discs listed below.

CDG, Photo-CD, CD-ROM, CD-TEXT, CD-EXTRA, SACD, PD, DVD-ROM, SVCD, CVD, VCD, DVD-RAM, DVD+R/RW, DVD audio, etc.

The following DVD-Video discs may not be played back on this unit:

- DVD-Video that do not have the region number "1" or "ALL".
- PAL or SECAM DVD-Video.
- Prohibited or business-use DVD-Video.

CD-R/CD-RWs cannot be played back for the following reasons.

- Compatibility of the disc and this unit.
- Compatibility of the disc and the recorder used.
- Unfinalised discs.

Never use the following discs or accessories. It may cause serious damage to the TV/DVD.

- Irregular shaped discs such as card shaped, heart shaped
- The ring protector or other disc accessories
- The 8cm disc adapter
- Stickered or papered discs
- Discs with scotch tape, glue or other remains of labels

Title/Chapter/Track

A DVD-Video has large partitions called "Titles", and smaller partitions within them called "Chapters".

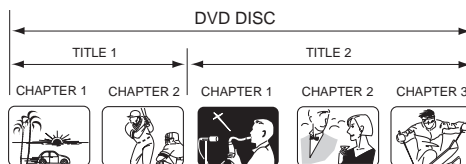

A audio CD has other partitions called "Tracks". A number is allotted to each partition and these numbers are called "title numbers", "chapter numbers" or "track numbers".

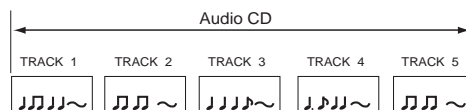

Disc

Handling discs

Removing the Disc from its case

Be sure to hold the edge of disc. Do not touch the surface of the disc.

Pick up the disc gently from the case.

- Do not scratch the disc.
- Do not get dirt on the surface of the disc.
- Do not stick a label or adhesive tape on the disc.
- Do not drop or bend the disc.



Storing discs

- Store the disc in the case to avoid any risk of scratches, dirt or damage.
- Do not leave the disc exposed to direct sunlight or in hot or humid places.

Cleaning discs

Wipe the disc with a clean, dry cloth from the center outward toward the edges.

- Do not wipe the disc in a circular motion around the center.
- Do not use liquid or aerosol cleaners.

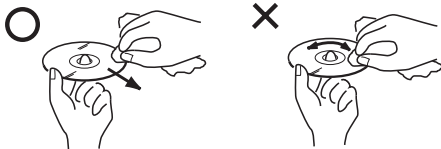



Notes on copyright

- This product incorporates copyright protection technology that is protected by U.S. patents and other intellectual property rights. Use of this copyright protection technology must be authorized by Macrovision, and is intended for home and other limited viewing uses only unless otherwise authorized by Macrovision. Reverse engineering or disassembly is prohibited.
- Unauthorized recording of copyrighted television programs, films, video cassettes and other materials may infringe the rights of copyright owners and be contrary to copyright laws.

Supplied accessories

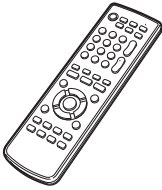
Make sure the following accessories are provided with the product.

Remote control unit (X1)	"AA" size battery (X2)	Operation manual (X1)
 <p>Page 8</p>	 <p>Page 8</p>	

QUICK REFERENCE

Ventilation & Cleaning Tips

Keep your TV/DVD in a well ventilated area and make sure not to place it by a heat source or use near water. The TV/DVD is designed for AC use only and should be used with supplied AC cord.



Clean the screen by spraying a soft lint free cloth with water to lightly moisten. Gently wipe and avoid pressing on the screen. To clean the outer cabinet, use the same method. Do not use liquid or aerosol cleaners.



The screen is glass and can be scratched or broken when dropped or impacted.

QUICK INSTALLATION TIPS

1. Attach your antenna to the back of the TV/DVD.
(See page 12.)
2. Connect the AC plug for the TV/DVD into the wall outlet.
3. How to turn on the TV/DVD for the first time.

- A) Press **POWER** on TV/DVD.

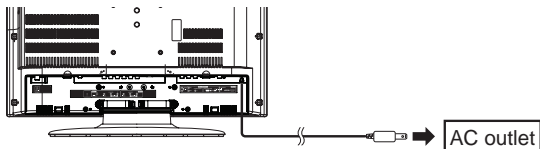

- Place the TV/DVD close to the AC outlet, and keep the power plug within reach.

NOTE

- **TO PREVENT RISK OF ELECTRIC SHOCK, DO NOT TOUCH UN-INSULATED PARTS OF ANY CABLES WITH THE AC CORD CONNECTED.**

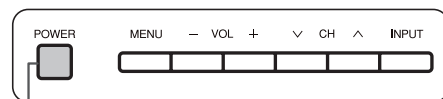

POWER

- B) POWER indicator on the front of the TV/DVD lights GREEN.

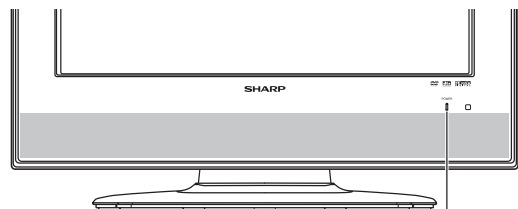

POWER indicator

QUICK REFERENCE

If the remote control fails to operate TV/DVD functions, replace the batteries in the remote control unit.

1 Open the battery cover.

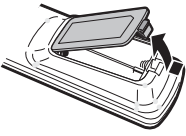

2 Insert two "AA" size batteries (supplied with the product).

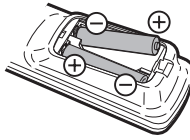

3 Close the battery cover.

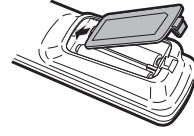

- Place the batteries with their terminals corresponding to the (+) and (-) indications in the battery compartment.

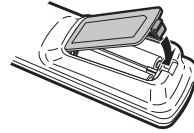

NOTE

Improper use of batteries can result in chemical leakage or explosion. Be sure to follow the instructions below.

- Do not mix batteries of different types. Different types of batteries have different characteristics.
- Do not mix old and new batteries. Mixing old and new batteries can shorten the life of new batteries or cause chemical leakage in old batteries.
- Remove batteries as soon as they are worn out. Chemicals that leak from batteries that come in contact with skin can cause a rash. If you find any chemical leakage, wipe thoroughly with a cloth.
- The batteries supplied with this product may have a shorter life expectancy due to storage conditions.
- If you will not be using the remote control unit for an extended period of time, remove batteries from it.

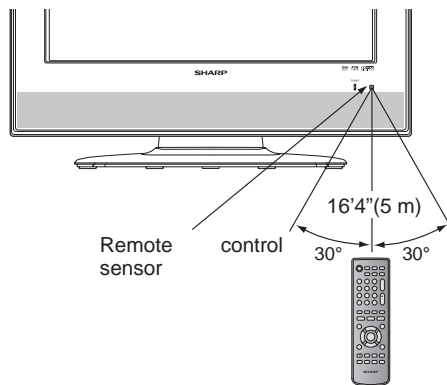

IMPORTANT:

The POWER indicator on the television should light GREEN indicating you have power to the TV/DVD.

If the POWER indicator on the television still does not light up, press **POWER** on the remote control to turn the power on.

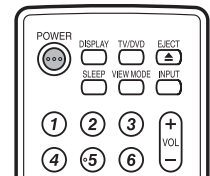

IMPORTANT:

IF THE UNIT DOES NOT POWER ON - UNPLUG THE TELEVISION FROM THE OUTLET AND REPEAT THE INSTALLATION STEPS.

IF YOU STILL ENCOUNTER NO POWER, PLEASE CONTACT US AT 1-800-BE-SHARP.

Please refer to the BASIC ADJUSTMENT SETTINGS SECTION and basic Initial setup functions and USING EXTERNAL EQUIPMENT SECTION for other device connections (DVD, VCR, AUDIO, etc) in your operation manual.

Contents

IMPORTANT INFORMATION	2	Connecting a PC (Personal Computer)	27
Trademarks	2	Viewing an image from a PC	27
DEAR SHARP CUSTOMER	3	Displaying an image from a PC	27
IMPORTANT SAFETY INSTRUCTIONS	3	Picture and Audio adjustment in the	
DISC	5	PC mode	28
Discs which can be played back	5	PC compatibility chart.....	28
Discs which cannot be played back	5	Watching the DVD	29
Title/Chapter/Track	5	Preparation	29
Handling discs	6	Turning on the power	29
Supplied accessories	7	Select the DVD mode	29
QUICK REFERENCE	7	Turning off the power	29
Contents	9	Playback procedure.....	30
Part names	10	Status display of disc.....	30
TV/DVD (Front)	10	Special playback	31
TV/DVD (Right)	10	Zooming	31
TV/DVD (Rear)	10	Locating desired scene	31
Remote control unit	11	Repeat playback.....	32
Preparation	12	A-B Repeat playback.....	32
Using the remote control unit	12	Marking desired scenes	32
Cautions regarding remote control unit	12	Program playback (only CD)	33
Antennas	12	Random playback (only CD)	33
Watching TV	13	Changing angles	33
Preparation.....	13	Title selection	33
Turning on the power	13	DVD menu	33
Select the TV mode.....	13	Changing soundtrack language.....	34
Turning off the power	13	Subtitles.....	34
Changing channels.....	13	MP3/WMA/JPEG CD playback	35
Changing volume/sound.....	13	MP3/WMA/JPEG CD information.....	35
Initial setup	14	MP3/WMA CD playback	36
Setting MTS/SAP stereo mode	15	JPEG CD playback.....	36
Setting surround sound	15	About file menu	36
Basic adjustment settings	16	Setting the JPEG interval	37
Menu operation buttons.....	16	Setting the select files	37
Menu items.....	16	Function setup	38
Picture adjustments.....	17	Basic operation buttons.....	38
Color temperature	17	Menu items.....	38
Cinema mode	17	Setting the language	39
Back lighting	17	Setting the aspect ratio of TV screen	39
Sound adjustment	18	Setting on screen display	40
Labeling channels	18	Setting the picture mode	40
Using external equipment	19	Dynamic Range Control	40
Displaying an external equipment image	19	Parental control setting.....	41
Connecting a DVD player or a digital TV STB		To change the parental level	41
(Cable).....	19	Temporary disabling of rating level by DVD	
Connecting a VCR, game console or		disc	42
camcorder	19	Appendix	43
Connecting HDMI equipment	20	Language code list	43
Displaying an image from HDMI equipment.....	20	Troubleshooting.....	44
Selecting HDMI audio input source	20	Troubleshooting-PC mode	44
Using digital audio output	20	Troubleshooting-DVD.....	45
Useful adjustment settings	21	Specifications	46
Input label.....	21	Calling for Service	48
AV mode.....	21	LIMITED WARRANTY	48
View mode for 4:3 programs	22		
View mode for HD programs	22		
Picture scroll.....	22		
Aspect	22		
Closed captions.....	23		
Password setting for parental control	24		
Parental control (V-CHIP).....	25		
TV Parental Guidelines (TV Guidelines)	26		
Voluntary movie rating system (MPAA).....	26		
How to temporarily release the V-CHIP block ...	26		
Reactivating the temporarily released V-CHIP			
block	26		

Part names

TV/DVD (Front)

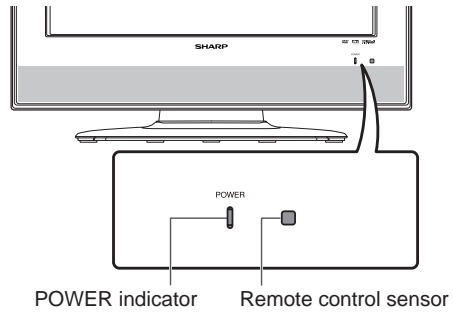
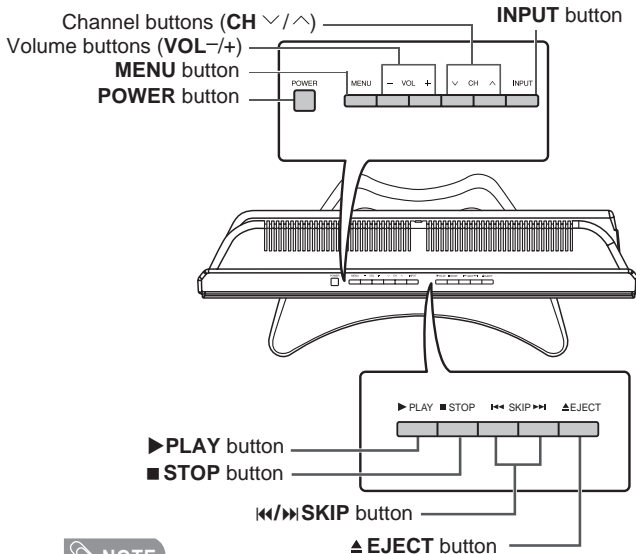

TV/DVD (Right)

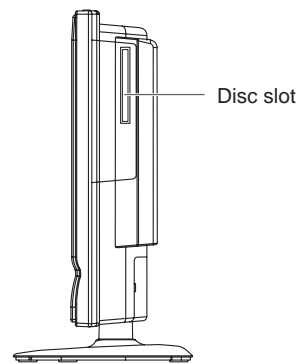

NOTE

- **INPUT**, **CH** (∇)/(\wedge), **VOL** ($-$)/($+$) and **MENU** on the main unit have the same functions as the same buttons on the remote control. Fundamentally, this operation manual provides a description based on operation using the remote control.
- To change the vertical angle of the TV/DVD, tilt the screen up to 5 degrees forward or 7 degrees backward. Please adjust the angle so that the TV/DVD can be watched most comfortably.

TV/DVD (Rear)

Listening with headphones

Plug the headphone mini-plug into the headphone jack located on the back of the main unit.

On-screen display



Adjust the sound volume using **VOL** ($+$)/($-$) on the remote control.

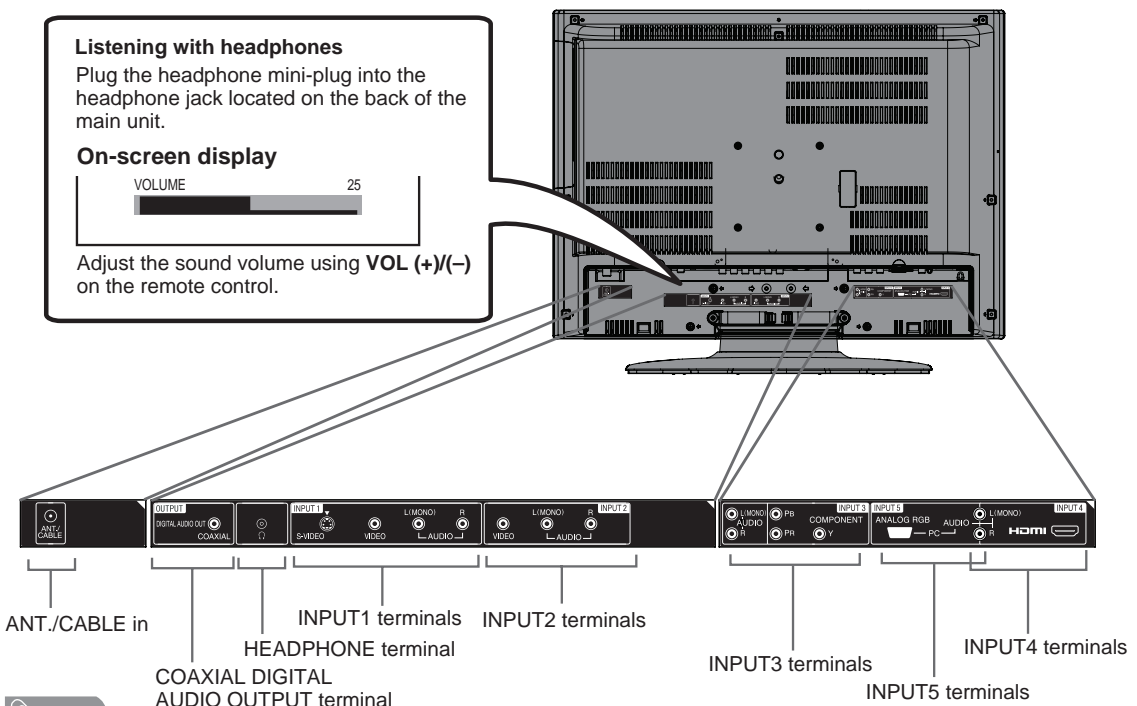

NOTE

- Headphones are not included in the supplied accessories.
- No sound is heard from the main unit speakers when a headphone mini-plug is connected into the headphone jack.
- Do not set the volume at a high level. Hearing experts advise against extended listening at high volume levels.

Remote control unit

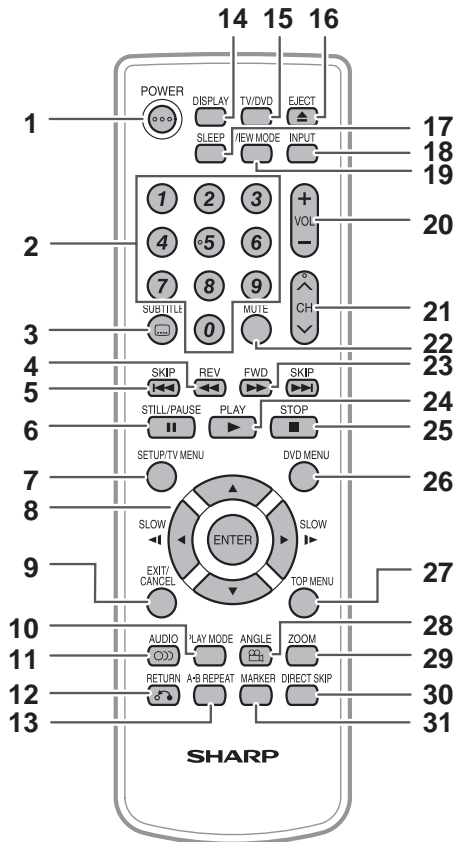

- 1 **POWER:** Switch the power on or enters standby mode. (See page 13.)
- 2 **0 – 9:** Set the channel. (See page 13.)
- 3 **SUBTITLE:** Set subtitle. (See page 34.)
- 4 **REV :** Review playback. (See page 31.)
- 5 **SKIP** : Skip chapter to reverse or forward direction. (See page 31.)
- 6 **STILL/PAUSE:** Still picture of DVD / Pause CD sound. (See page 31.)
- 7 **SETUP/TV MENU:** TV mode - Display menu of TV /DVD mode - Call up initial setup mode. (See pages 16, 38.)
- 8 **▲/▼/◀/▶/ENTER:** Select a desired item on the screen.
SLOW : Reverse/Forward -slow motion. (See page 31.)
- 9 **EXIT/CANCEL:** Turn off the menu screen / Reset information in the menu.
- 10 **PLAY MODE:** Select playback mode. (See page 33.)
- 11 **AUDIO:** Display the MTS setting menu. / Change sound track language. (See pages 15,34.)
- 12 **RETURN:** Turn off the DVD setup menu screen.
- 13 **A-B REPEAT:** Repeat playback between A and B. (See page 32.)

- 14 **DISPLAY:** Display the current channel (or input source) information on the screen. Press again to clear the display.
 - Analog channel status will display on the screen for approx. 4 seconds.
- 15 **TV/DVD:** Switch between TV/AV and DVD. (See pages 13, 29.)
- 16 **EJECT:** Eject the disc. (See page 30.)
- 17 **SLEEP:** Set a time when the TV automatically switches to standby. Each time you this button, the sleep timer automatically starts counting down.
 - If you want to adjust the sleep timer again, you can press this button repeatedly then change the time setting.
 - Select "0h00m" by pressing SLEEP repeatedly to cancel the sleep timer.
 - The TV will enter the standby mode when the remaining time reaches zero.
- 18 **INPUT:** Select input source. (TV, INPUT1-5) (See page 20.)
- 19 **VIEW MODE:** Select the screen size. (See page 22.)
- 20 **VOL +/-:** Set the volume. (See page 13.)
- 21 **CH** : Select the channel. (See page 13.)
- 22 **MUTE:** Mute the sound. "MUTE" will be displayed on the screen, and the sound is silenced. The muting feature can be released by pressing this button again or one of the VOL +/- buttons.
- 23 **FWD:** Fast forward playback. (See page 31.)
- 24 **PLAY:** Playback. (See page 30.)
- 25 **STOP:** Stop. (See page 30.)
- 26 **DVD MENU:** Display DVD menu. (See page 33.)
- 27 **TOP MENU:** Select title. (See page 33.)
- 28 **ANGLE:** Change playback channel. (See page 33.)
- 29 **ZOOM:** Zoom. (See page 31.)
- 30 **DIRECT SKIP:** Locating desired scene of DVD. (See page 31.)
- 31 **MARKER:** Index (DVD). (See page 32.)

NOTE

- When using the remote control unit, point it at the TV/ DVD. (See page 8.)

Preparation

Using the remote control unit

Use the remote control unit by pointing it towards the remote control sensor on the TV. Objects between the remote control unit and the remote control sensor may prevent proper operation.

Cautions regarding remote control unit

- Do not expose the remote control unit to shock. In addition, do not expose the remote control unit to liquids, and do not place in an area with high humidity.
- Do not install or place the remote control unit under direct sunlight. The heat may cause deformation of the remote control unit.
- The remote control unit may not work properly if the remote control sensor on the TV is under direct sunlight or strong lighting. In such cases, change the angle of the lighting or the TV, or operate the remote control unit closer to the remote control sensor.

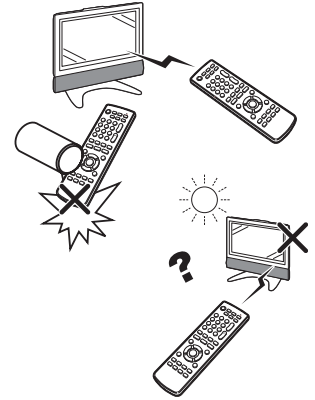

Antennas

To enjoy a clearer picture, use an outdoor antenna. The following is a brief explanation of the types of connections that are used for a coaxial cable. If your outdoor antenna uses a 75-ohm coaxial cable with an F-type connector, plug it into the antenna terminal at the rear of the TV set.

1. A 75-ohm system is generally a round cable with F-type connector that can easily be attached to a terminal without tools (Commercially available).

F-type connector

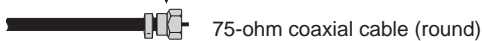

2. A 300-ohm system is a flat "twin-lead" cable that can be attached to a 75-ohm terminal through a 300/75-ohm adapter (Commercially available).

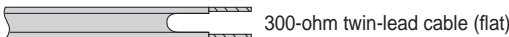

NOTICE F-type connector should be finger-tightened only.

When connecting the RF cable to the TV set, do not tighten F-type connector with tools. If tools are used, it may cause damage to your TV set. (The breaking of internal circuit, etc.)



F-type connector

75-ohm coaxial cable

Connecting Antenna Cable

- ① Cable without a CATV converter



- ② VHF/UHF antenna

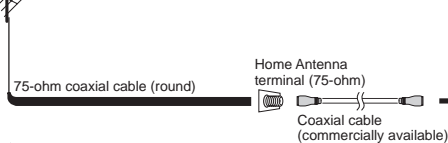

- ③ Combination VHF/UHF antenna

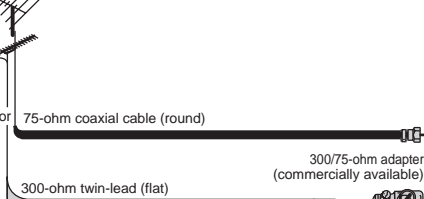

- ④ Separate VHF/UHF antenna

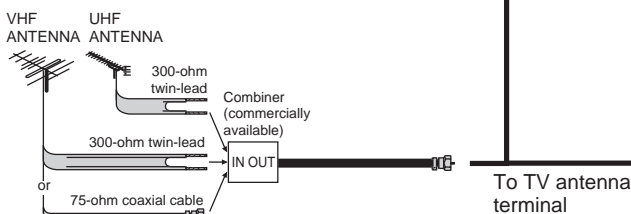

- Connect the antenna cable to the TV using one of the methods in the illustration as shown (①, ②, ③ or ④).

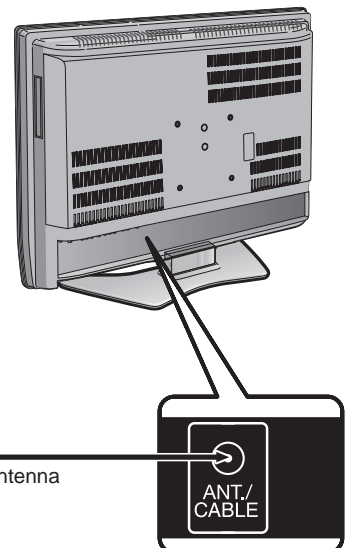

Watching TV

Simple operations for watching a TV program

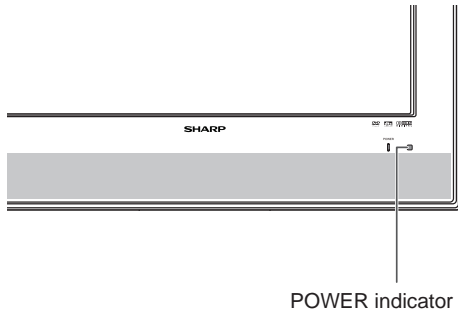
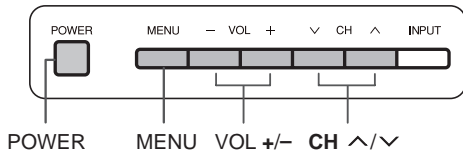

TV/DVD status indicator (POWER)

ON	Lighting (Green)
OFF/Standby	Lighting (Red)

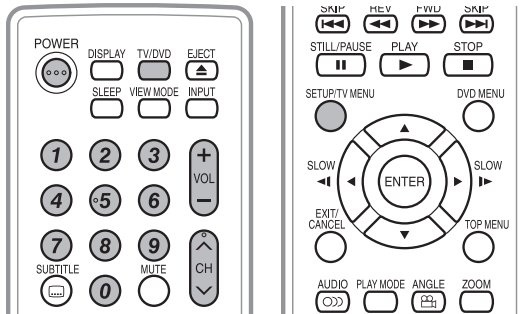

Preparation

Perform the following steps before you press **POWER** on the remote control unit.

1. Insert the batteries into the remote control unit. (See page 8.)
2. Connect the antenna cable to the TV/DVD. (See page 12.)
3. Plug in the AC cord to the AC outlet. (See page 7.)

Turning on the power

Press **POWER** on the TV/DVD, or **POWER** on the remote control.

- POWER indicator (Green): The TV/DVD is on.

Select the TV mode

Press **TV/DVD** to select the TV mode.

NOTE

- The LANGUAGE setup menu will appear automatically when **TV MENU** is pressed on for the first time.

Turning off the power

Press **POWER** on the TV/DVD, or **POWER** on the remote control.

- The TV enters standby mode and the image on the screen disappears.
- The POWER indicator on the TV/DVD changes to Red.

NOTE

- If you are not going to use this TV/DVD for a long period of time, be sure to remove the AC cord from the power outlet.
- Weak electric power is still consumed even when **POWER** is turned off.
- If a station being viewed stops broadcasting, the TV will automatically shut itself off after 15 minutes.

Changing channels

You can change channels in several ways.

Method 1

Using **CH ^/v** on the remote control unit or on the TV/DVD.

Method 2

Using remote control buttons **0-9** to select channels for VHF/UHF/CATV.

To select a 1 or 2-digit channel number (e. g., Channel 5):
Press **5**

To select a 3-digit channel number (e. g., Channel 115):
Press **1→1→5**

NOTE

- When selecting a 1-digit channel number, it is not necessary to press **0** before the number.
- If you push "0" by itself, nothing will happen.
- Complete the above steps within a few seconds.

Changing volume/sound

Changing the volume

You can change the volume on the TV/DVD or on the remote control unit.

Using **VOL +/-**

- To increase the volume, press **VOL +**.
- To decrease the volume, press **VOL -**.



NOTE

- **VOL +/-** on the TV/DVD operates the same as **VOL +/-** on the remote control unit.

Watching TV

Initial setup

Language setting

When you press TV MENU for the first time, the LANGUAGE setup menu will appear automatically.

Select from among 3 languages: English, French and Spanish.

- 1 Press ◀/▶ to select the desired language from the list.

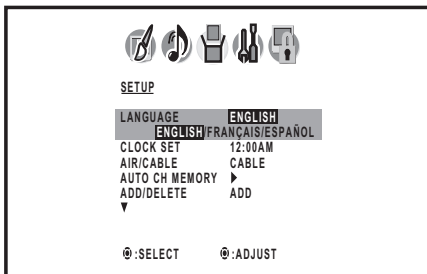

Clock setting

Please set correct time manually.

- 2 Press ▲/▼ to select "CLOCK SET". Press ◀/▶ to select HOUR or MINUTE, then press ▲/▼ to set the present time. After setting the time correctly, press ENTER.

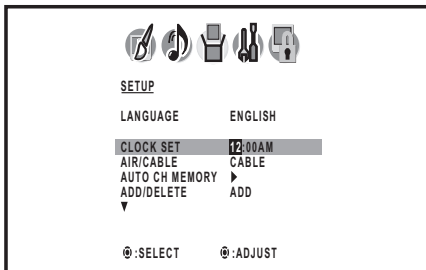

Antenna setting

Make sure what kind of connection is made with your TV/DVD when selecting "AIR" or "CABLE".

- 3 Press ▲/▼ to select "AIR/CABLE", then press ◀/▶ to select "AIR" or "CABLE".

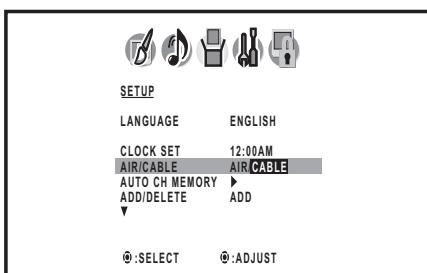

Channel search

AUTO CHANNEL MEMORY makes the TV/DVD look for all channels viewable in the set area.

- 4 Press ▲/▼ to select "AUTO CH MEMORY"

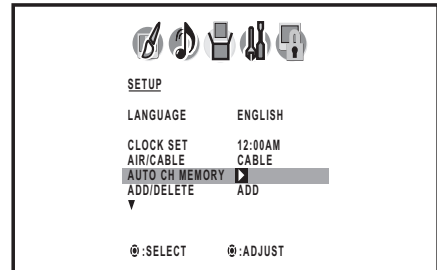

Press ◀/▶. The TV/DVD will begin memorizing all the channels available in your area.

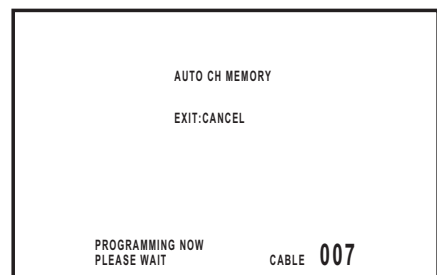

Skipping stored channel

You can set channel selection disabled using CH ^/∨.

- 1 Select the channel you want to skip.
- 2 Press TV MENU and the MENU screen displays.
- 3 Press ◀/▶ to select (SETUP).
- 4 Press ▲/▼ to select "ADD/DELETE".
- 5 Press ◀/▶ to select "DELETE" for selected channel.
- 6 Press EXIT to return to the normal screen. Now, skipping channel is applied.

- To skip the other channels: Repeat steps 1-6.
- To release the skipping channel: Select "ADD" in step 5.

Watching TV

Setting MTS/SAP stereo mode

The TV/DVD has a feature that allows reception of sound other than the main audio for the program. This feature is called Multi-channel Television Sound (MTS). The TV/DVD with MTS can receive mono sound, stereo sound and Secondary Audio Programs (SAP). The SAP feature allows a TV/DVD station to broadcast other information, which could be audio in another language or something completely different like weather information.

You can enjoy Hi-Fi stereo sound or SAP broadcasts where available.

- **Stereo broadcasts**
View programs like live sporting events, shows and concerts in dynamic stereo sound.
- **SAP broadcasts**
Receive TV broadcasts in either MAIN or SAP sound.
MAIN sound: The normal program soundtrack (either in mono or stereo).
SAP sound: Listen to a second language, supplementary commentary or other information. (SAP is mono sound.)

If stereo sound is difficult to hear.

- Obtain a clearer sound by manually switching to fixed mono-sound mode.

NOTE

- MTS only operates while in TV mode.
- When the TV receives a stereo or SAP broadcast, the word "STEREO" or "SAP" displays on-screen every time you turn the TV on, change the channel, or press **DISPLAY**.

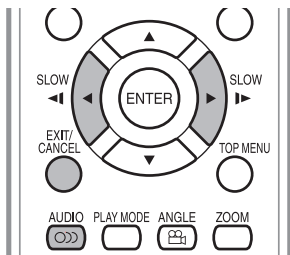

Changing MTS

You can change MTS as shown below to match the television broadcast signal.

- 1 Press **AUDIO** and the  (AUDIO) menu screen displays. "MTS" will be highlighted.

- 2 Press **AUDIO** again or  to select "STR (STEREO)", "SAP" or "MONO".

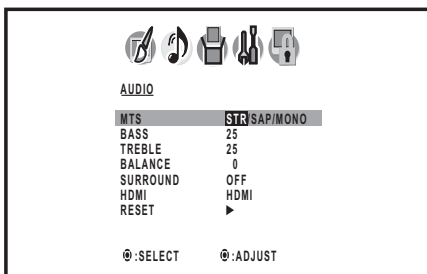

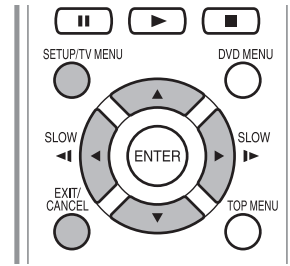

- 3 Press **EXIT** to return to the normal screen.

Setting surround sound



The surround sound feature expands the audio listening field wider and deeper to create exception sound quality from the TV/DVD's speakers.

- 1 Press **TV MENU** and the MENU screen displays.

- 2 Press  to select  (AUDIO).

- 3 Press  to select "SURROUND".

- 4 Press  to select the "ON" or "OFF".

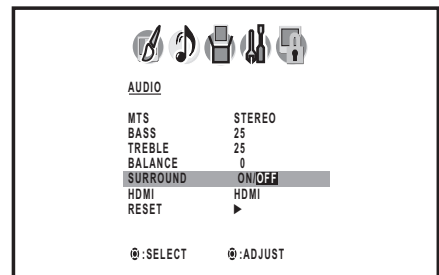

- 5 After your desired setting, press **EXIT** to return to the normal screen.

Basic adjustment settings

Menu operation buttons

Use the following buttons on the remote control to operate the menu.

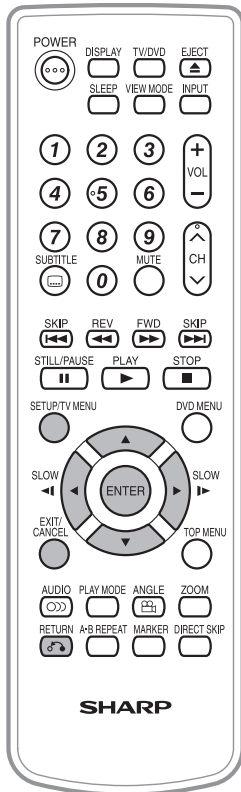

TV MENU: Press to open the menu screen.

▲/▼/◀/▶: Press to select a desired item on the screen or adjust a selected item.

ENTER: Press to go to the next step or complete the setting.

RETURN: Press to return to the previous step.

EXIT: Press to exit from the menu screen. All changed settings will be saved.

⊙: SELECT
ENTER: SET

⊙: ADJUST
EXIT: END

The lower part of the menu screen is an operational guide for the remote control. It will change in accordance with each menu setting screen.

Menu items

List of menu items to help you with operations

PICTURE

AV MODE	Page 21
BRIGHTNESS	Page 17
CONTRAST	Page 17
COLOR	Page 17
TINT	Page 17
SHARPNESS	Page 17
COLOR TEMPERATURE	Page 17
RESET (Picture adjustments)	Page 17

AUDIO

MTS	Page 15
BASS	Page 18
TREBLE	Page 18
BALANCE	Page 18
SURROUND	Page 15
HDMI	Page 20
RESET (Sound adjustments)	Page 18

SETUP

LANGUAGE	Page 14
CLOCK SET	Page 14
AIR/CABLE	Page 14
AUTO CH MEMORY	Page 14
ADD/DELETE	Page 14
CLOSED CAPTION	Page 23
VIEW MODE	Page 22
PICTURE SCROLL	Page 22
CINEMA MODE	Page 17
ASPECT	Page 22
BACK LIGHTING	Page 17

OPTION

CH LABEL	Page 18
VIDEO LABEL	Page 21

LOCKS

V-CHIP SET	Page 26
NEW PASSWORD	Page 24

Basic adjustment settings

Picture adjustments

Adjusts the picture to your preference with the following picture settings.

- 1 Press **TV MENU** and the MENU screen displays.
- 2 Press **◀/▶** to select  (PICTURE).
- 3 Press **▲/▼** to select a specific adjustment item (BRIGHTNESS, CONTRAST, COLOR, TINT, SHARPNESS).
- 4 Press **◀/▶** to adjust the item to the desired level.

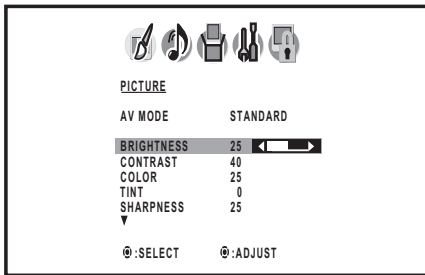

Selected item	◀ button	▶ button
BRIGHTNESS	For less brightness	For more brightness
CONTRAST	For less contrast	For more contrast
COLOR	For less color intensity	For more color intensity
TINT	Skin tones become purplish	Skin tones become greenish
SHARPNESS	For less sharpness	For more sharpness

- 5 Press **EXIT** to return to the normal screen.

NOTE

- For resetting all Picture adjustment items to the factory preset values, press **▲/▼** to select "RESET", and then press **◀/▶**.

Factory settings:

AV MODE.....STANDARD
 BRIGHTNESS / COLOR / SHARPNESS....center (25)
 CONTRASTcenter (40)
 TINTcenter (0)
 COLOR TEMPERATUREMEDIUM

Color temperature

For a better white balance, use color temperature correction.

- 1 Press **TV MENU** and the MENU screen displays.
- 2 Press **◀/▶** to select  (PICTURE).
- 3 Press **▲/▼** to select "COLOR TEMPERATURE".
- 4 Press **◀/▶** to select the mode you prefer.

Selected item	Description
COOL	White with Blueish tone
MEDIUM	Neutral
WARM	White with Reddish tone

- 5 Press **EXIT** to return to the normal screen.

Cinema mode

A smoother motion may be obtained by setting the CINEMA MODE to FILM when you view a DVD from the DVD player connected with the component input.

- 1 Press **TV MENU** and the MENU screen displays.
- 2 Press **◀/▶** to select  (SETUP).
- 3 Press **▲/▼** to select "CINEMA MODE".
- 4 Press **◀/▶** to select "FILM" or "VIDEO".

Selected item	Description
FILM	Film content viewing mode
VIDEO	Video content viewing mode

Back lighting

BACK LIGHTING adjusts the screen brightness for improved picture clarity.

- 1 Press **TV MENU** and the MENU screen displays.
- 2 Press **◀/▶** to select  (SETUP).
- 3 Press **▲/▼** to select "BACK LIGHTING".
- 4 Press **◀/▶** to adjust the screen brightness.
- 5 Press **EXIT** to return to the normal screen.

Basic adjustment settings

Sound adjustment

You can adjust the sound quality to your preference with the following settings.

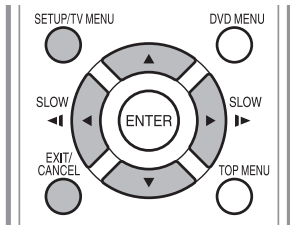

1 Press **TV MENU** and the MENU screen displays.

2 Press **◀/▶** to select (AUDIO).

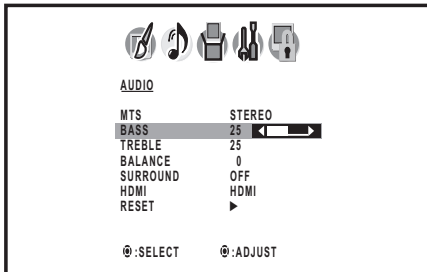

3 Press **▲/▼** to select a specific adjustment item (BASS, TREBLE, BALANCE).

4 Press **◀/▶** to adjust the item to the desired level.

Selected item	◀ button	▶ button
BASS	For weaker bass	For stronger bass
TREBLE	For weaker treble	For stronger treble
BALANCE	Decrease audio from the right speaker	Decrease audio from the left speaker

5 Press **EXIT** to return to the normal screen.

NOTE

- For resetting all Audio adjustment items to the factory preset values, press **▲/▼** to select "RESET", and then press **◀/▶**.

Factory settings:

BASScenter (25) BALANCE.... center (0)
TREBLEcenter (25)

Labeling channels

To create channel labels

1 Select a channel you want to label.

2 Press **TV MENU**, then press **◀/▶** to select (OPTION).
Press **▲/▼** to select "CH LABEL", then press **◀/▶**. The CH LABEL menu will appear.

3 Press **▲/▼** to select "SET/CLEAR". Press **◀/▶** to select "SET" then press **ENTER**.

4 Press **◀/▶** to enter a character in the first space. Press the button repeatedly until the character you want appears on the screen.

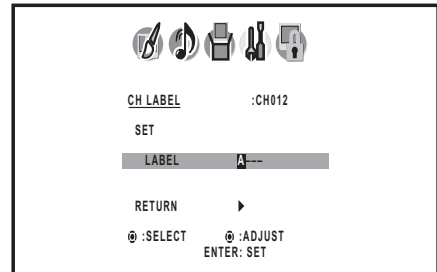

The characters rotation as follows:

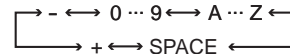

If the character which you desire appears, press **ENTER**. Repeat this step to enter the rest of the characters.

When you finish inputting the label name, press **ENTER**.

5 Press **EXIT** to return to the normal screen.

6 Repeat steps 1-5 for other channels. You can assign a label to each channel.

To erase channel labels

1 Select a channel with a label which you want to remove.

2 Press **TV MENU**, then press **◀/▶** to select (OPTION).
Press **▲/▼** to select "CH LABEL", then press **◀/▶** to display the CH LABEL menu.

3 Press **▲/▼** to select "SET/CLEAR". Press **◀/▶** to select "CLEAR", then press **ENTER**.

4 Press **EXIT** to return to the normal screen.

5 Repeat steps 1-4 to erase other channel labels.

Using external equipment

You can connect many types of external equipment to your TV/DVD like a DVD player, VCR, Digital TV STB, HDMI equipment, game console or camcorder. To view external source images, select the input source from **INPUT** on the remote control unit or on the TV/DVD.

Displaying an external equipment image

This explanation is for the setting when connecting a DVD player to the INPUT3 terminal.

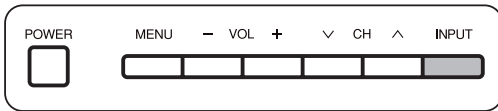
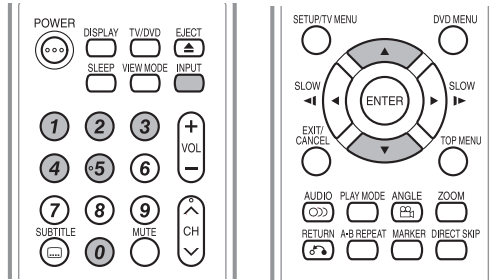

To watch a DVD image, select "INPUT3" from "SOURCE SELECTION" menu using **0-5** on the remote control.

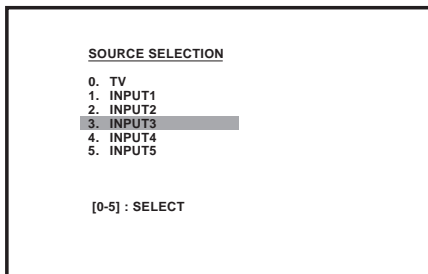

- Each time **INPUT** is pressed, "SOURCE SELECTION" item toggles.
- You can also select "SOURCE SELECTION" item by pressing **▲/▼**.

CAUTION

- To protect equipment, always turn off the TV before connecting a DVD player, VCR, Digital TV STB, HDMI equipment, game console, camcorder or other external equipment.

NOTE

- See pages 19 and 20 for external equipment connection.
- Please read the relevant operation manual (DVD player, etc.) carefully before making connections.
- Refer to your external equipment operation manual for the signal type.

Connecting a DVD player or a digital TV STB (Cable)

You can use the INPUT1, INPUT2 or INPUT3 terminals when connecting to a DVD player, a Digital TV STB (Cable) and other audiovisual equipment.

When using component cable. (INPUT3)

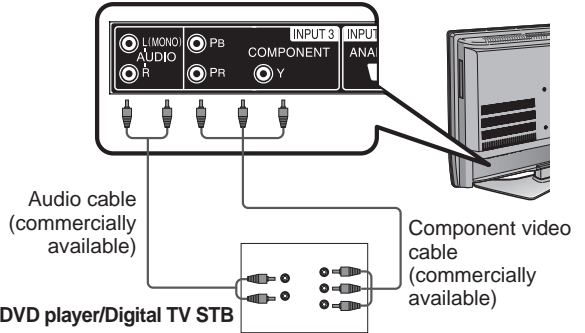

When using composite cable. (INPUT1 or 2)

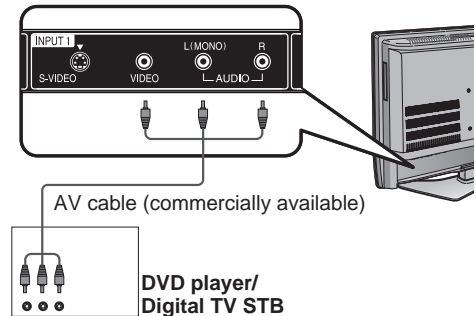

NOTE

- See page 20 for connecting a DVD player or a Digital TV STB to the HDMI terminal.

Connecting a VCR, game console or camcorder

A VCR, game console, camcorder and other audiovisual equipment can be conveniently connected using the INPUT1 or 2 terminals.

NOTE

- The S-video terminal takes priority over the video terminals.

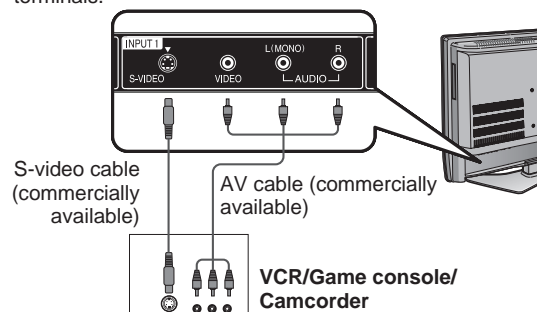

Using external equipment

Connecting HDMI equipment

You can use the INPUT4 terminal when connecting HDMI equipment.

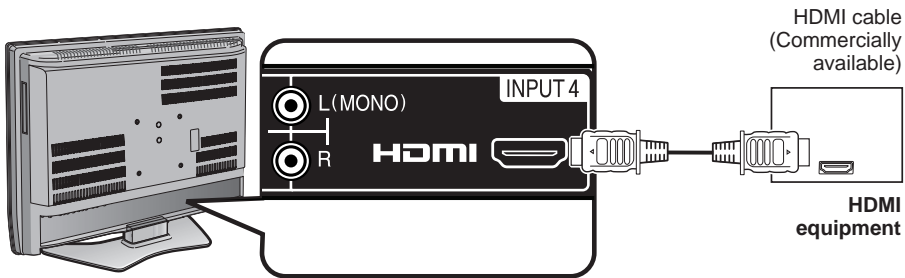

When using an HDMI-DVI conversion cable, use INPUT4 and AUDIO terminal.

Displaying an image from HDMI equipment

- 1 To watch an HDMI equipment image, select "INPUT4" from "SOURCE SELECTION" menu using **INPUT** on the remote control unit or on the TV. (See page 19.)

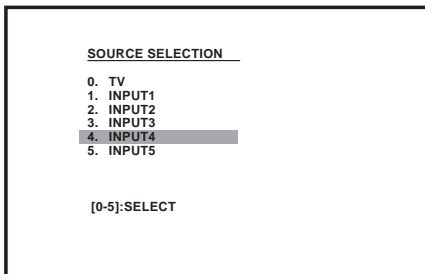

NOTE

- Refer to your external equipment operation manual for the signal type.

Selecting HDMI audio input source

- 1 Press **TV MENU** and the MENU screen displays.
- 2 Press **◀▶** to select  (AUDIO).
- 3 Press **▲▼** to select "HDMI".

4

Press **◀▶** to select "HDMI" or "DVI".

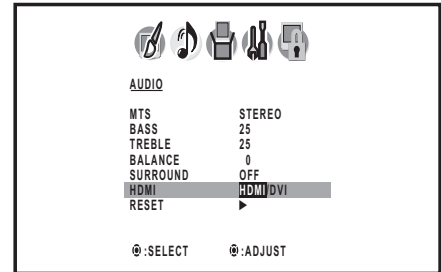

HDMI: When you connect the HDMI device to the TV, select this setting.

DVI: When you connect the DVI device to the TV with analog audio cords, select this setting.

5

Press **EXIT** to return to the normal screen.

Using digital audio output

It is possible to output audio through the COAXIAL DIGITAL AUDIO OUTPUT terminal in DVD mode only. PCM audio outputs from the terminal.

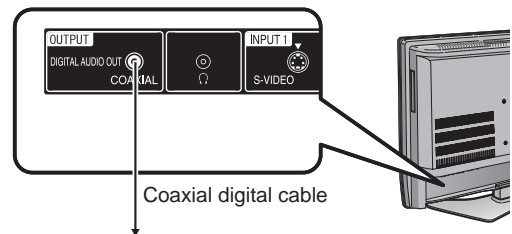

To coaxial digital input of external audio devices

NOTE

- Even when the TV is not in DVD mode, the audio may be output through the COAXIAL DIGITAL AUDIO OUTPUT terminal depending on the DVDs.

Useful adjustment settings

Input label

Let you set the input terminal displayed when using the "SOURCE SELECTION" menu or channel display.

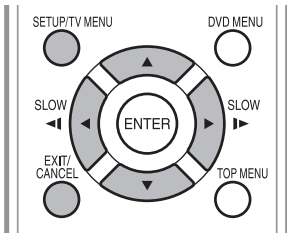

- 1 Press **TV MENU** and the MENU screen displays.
- 2 Press **◀/▶** to select (OPTION).
- 3 Press **▲/▼** to select "VIDEO LABEL", and then press **◀/▶**.
- 4 The VIDEO LABEL menu screen displays. Press **▲/▼** to select the specific input source which you want to change.
- 5 Press **◀/▶** to select the new label for the selected input source.

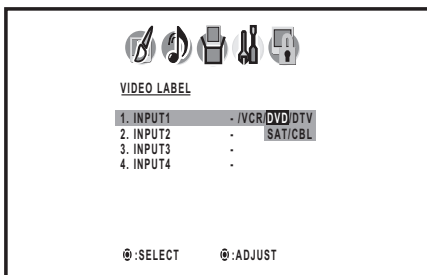

–	Uses the default label name
VCR	Video cassette recorder
DVD	DVD video
DTV	Digital TV set-top box
SAT	Satellite box
CBL	Cable box
HD	HDMI equipment

- 6 Press **EXIT** to return to the normal screen.

NOTE

- You cannot change label for "TV" input.

AV mode

AV mode gives you four viewing options to choose from to best match the surrounding environment of the TV/DVD, which can vary due to factors like room brightness, type of program watched or the type of image input from external equipment.

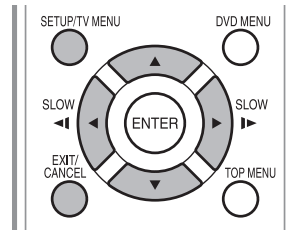

- 1 Press **TV MENU** and the MENU screen displays.
- 2 Press **◀/▶** to select (PICTURE).
- 3 Press **▲/▼** to select "AV MODE".
- 4 Press **◀/▶** to select the desired mode.
 - The mode can be chosen from the list below.

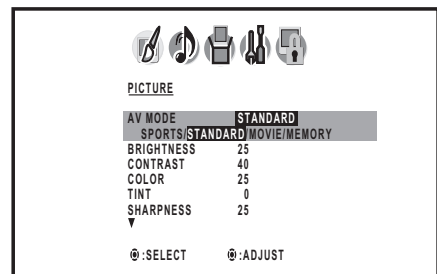

Selected item	Description
SPORTS	For a clear-cut image emphasizing high contrast, useful for sports viewing
STANDARD	For a highly defined image in a normal lighting
MOVIE	For a movie
MEMORY	Allows the user to customize settings as desired. You can set the mode for each input source.

- 5 Press **EXIT** to return to the normal screen.

NOTE

- You can select a different AV MODE item for each input mode. (For example, select STANDARD for TV input and SPORTS for VIDEO input.)

Useful adjustment settings

View mode for 4:3 programs

- 1 Press **VIEW MODE**.
 - The View mode menu displays.
 - The menu lists the view mode options selectable for the type of video signal currently being received.

- 2 Press **0-3** to select each view mode directly while the View mode menu is still on the screen.
 - Each time **VIEW MODE** is pressed, VIEW MODE item toggles.
 - You can also select VIEW MODE item by pressing **▲/▼**.
 - You can sequentially select a view mode that has its own aspect ratio.

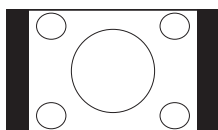
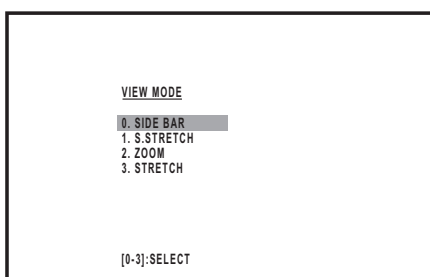

SIDE BAR:
Suitable for viewing conventional 4:3 programs in their normal format.

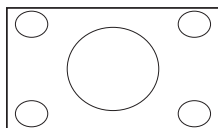

S.STRETCH (Smart stretch):
Suitable for stretching 4:3 programs to fill the screen.



ZOOM:
Suitable for viewing wide-screen 2.35:1 anamorphic DVDs in full screen.

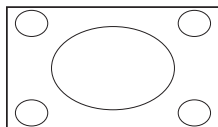

STRETCH:
This mode is useful for 1.78:1 DVDs. When viewing 1.85:1 DVDs, stretch mode will still show very thin black bands at the top and bottom of the screen.

NOTE

- You can enter to the same menu screen from **(SETUP)** menu.
- When this function is not available, "NOT AVAILABLE" will display.

View mode for HD programs

Stretch mode is available for HD programs. Suitable for viewing wide-screen 1.78:1 aspect-ratio programs. When viewing 1.85:1 programs, the stretch mode will still show very thin black bands at the top and bottom of the screen.

Picture scroll

For adjusting a picture's vertical position in ZOOM mode.

- 1 Press **TV MENU** and the MENU screen displays.
- 2 Press **◀/▶** to select **(SETUP)**.
- 3 Press **▲/▼** to select "PICTURE SCROLL", and then press **◀/▶**.
- 4 **SCROLL ADJUSTMENT** screen displays. To raise the picture, press **▲**. To lower the picture, press **▼**.

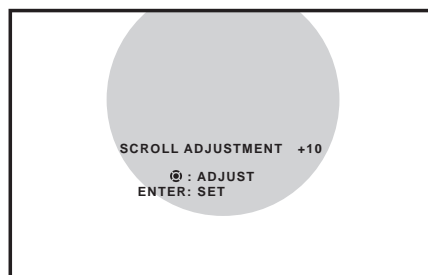

The scroll amounts are as follows:

- 480i/480p signal source:
ZOOM: -10 to +20

- 5 Press **EXIT** to return to the normal screen.

NOTE

- In SIDE BAR, S.STRETCH and STRETCH mode, PICTURE SCROLL will not work.

Aspect

When the ASPECT is set to ON and the TV receives a 480i signal, the picture size is automatically selected (as described in the following table).

- 1 Press **TV MENU** and the MENU screen displays.
- 2 Press **◀/▶** to select **(SETUP)**.
- 3 Press **▲/▼** to select "ASPECT", and then press **◀/▶** to select "ON" or "OFF".
- 4 Press **EXIT** to return to the normal screen.

Aspect ratio of signal source	Automatic aspect size (when ASPECT is ON)
4:3 Normal	SIDE BAR
16:9 Full	STRETCH
4:3 Letter box	ZOOM
Not defined	User-set mode

Useful adjustment settings

Closed captions

Your TV/DVD is equipped with an internal Closed Caption decoder. It allows you to view conversations, narration and sound effects as subtitles on your TV/DVD. Closed Captions are available on some TV programs and on some VHS home video tapes at the discretion of the program provider.

Not all programs and VHS videotapes offer closed captions. Please look for the "CC" symbol to ensure that captions will be shown.

In the Closed Caption system, there can be more than one caption service provided. Each is identified by its own number. The "C1" and "C2" services display subtitles of TV programs superimposed over the program's picture. Generally, Closed Captions in English are transmitted on C1 and Closed Captions in other languages are transmitted on C2.

In the Closed Caption system, the "Text1" or "Text2" services display text that is unrelated to the program being viewed (e.g., weather or news). These services are also superimposed over the program currently being viewed.

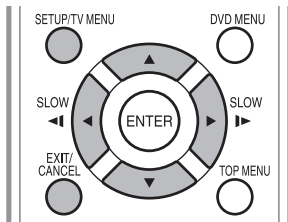

- 1 Tune the TV to the desired program.
- 2 Press **TV MENU** and the MENU screen displays.
- 3 Press ◀/▶ to select  (SETUP).
- 4 Press ▲/▼ to select "CLOSED CAPTION".
- 5 Press ◀/▶ to select your desired Closed Caption mode.

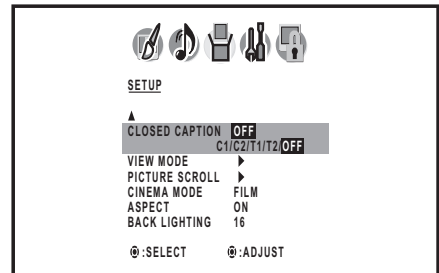

- 6 Press **EXIT** to return to the normal screen.

NOTE

- To turn the Closed Caption feature off, select "OFF".

NOTE

- If the program or video you selected is not closed-captioned, no captions will display on-screen.
- If text is not available in your viewing area, a black rectangle may appear on-screen. If this happens, set the Closed Caption feature to "OFF".
- When selecting Closed Captions, the captioning will be delayed approx. 10 seconds.
- If no caption signal is received, no captions will appear, but the television will remain in the Caption Mode.
- Misspellings or unusual characters may occasionally appear during Closed Captioning. This is normal with Closed Captioning, especially with live programs. This is because during live programs, captions are also entered live. These transmissions do not allow time for editing.
- When Captions are being displayed, on-screen displays, such as volume and mute may be seen but may interfere with Closed Captions.
- Some Cable TV systems and copy protection systems may interfere with the Closed Captioned signal.
- If using an indoor antenna or if TV reception is very poor, the Closed Caption Decoder may not appear or may appear with strange characters or misspelled words. In this case, adjust the antenna for better reception or use an outdoor antenna.

Useful adjustment settings

Password setting for parental control

Allows you to use a password to protect certain settings from being accidentally changed.

IMPORTANT:

Three conditions must be met to enable the V-Chip

- ① Password is registered.
- ② V-CHIP settings have been made.
- ③ "V-CHIP" is set to "ON".

Setting a password

- 1 Press **TV MENU** and the MENU screen displays.
- 2 Press **◀/▶** to select  (LOCKS).
- 3 Press **▲/▼**. The password entering menu displays.
- 4 Select and enter a password (4 digits) using the **number buttons (0–9)**, then press **ENTER**.

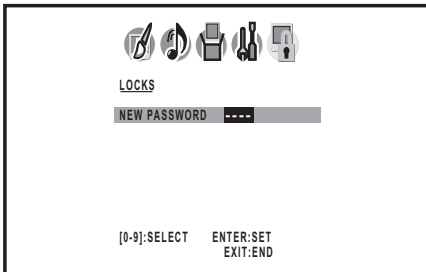

"*" appears instead of the number.

- 5 Enter the same password again to confirm, then press **ENTER**, the password is now registered and the LOCKS menu will appear on the screen.

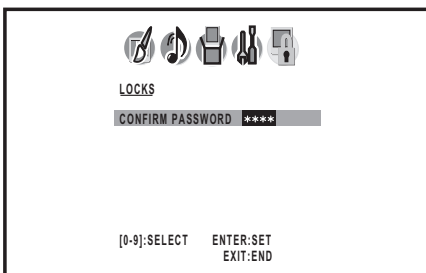

Changing the password

Allows you to change your current password.

- 1 Repeat steps 1 to 3 in **setting a password**.
 - The password entering menu displays.
- 2 Input the 4-digit password by using **0–9**, then press **ENTER**.
- 3 Press **▲/▼** to select "NEW PASSWORD", then press **◀/▶**.

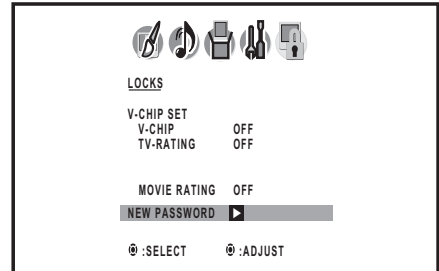

- 4 Enter a new password using **0–9**, then press **ENTER**.

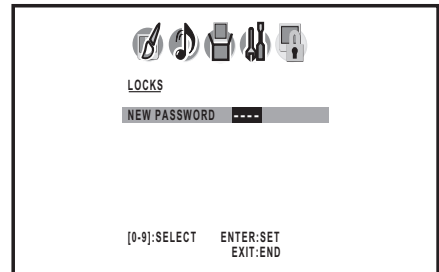

- 5 Enter the same password again to confirm, then press **ENTER**.

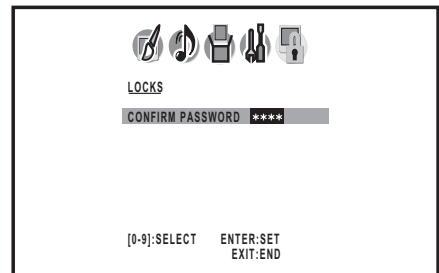

- 6 The screen returns to LOCKS menu. Your new password has been set.

NOTE

- As a precautionary measure, make a note of your password and keep it in a familiar place.

Useful adjustment settings

Parental control (V-CHIP)

V-CHIP is an electronic filtering device built into your TV/DVD. This tool gives parents a great degree of control over broadcasts accessed by their children. It allows parents to select programs judged suitable for child viewing while blocking ones judged not suitable. It does so automatically once you activate the V-CHIP feature in your TV/DVD.

V-CHIP SET menu will not be selectable from the menu if you do not first configure your password.

(See page 24 for password setting for parental control.)

- The U.S. has two rating systems for viewing content: movie ratings and TV Parental Guidelines.
- The TV Parental Guidelines work in conjunction with the V-CHIP to help parents screen out inappropriate television shows from their children.
- Movie ratings are used for original movies rated by the Motion Picture Association of America (MPAA) as watched on cable TV and not edited for television. The V-CHIP can also be set to block MPAA-rated movies.

TV Parental Guidelines

TV RATING		Content				
		FANTASY VIOLENCE	VIOLENCE	SEXUAL SITUATIONS	ADULT LANGUAGE	SEXUAL DIALOG
Suggested age	TV-Y (All children)					
	TV-Y7 (Directed to older children)	X				
	TV-G (General audience)					
	TV-PG (Parental Guidance suggested)		X	X	X	X
	TV-14 (Parents strongly cautioned)		X	X	X	X
	TV-MA (Mature audience only)		X	X	X	

X: Content rating can be set.

Voluntary movie rating system (MPAA)

MOVIE RATING	Description
G	General audiences. All ages admitted.
PG	Parental guidance suggested. Some material may not be suitable for children.
PG-13	Parents strongly cautioned. Some material may be inappropriate for children under 13.
R	Restricted. Under 17 requires accompanying parent or adult guardian (age varies in some jurisdictions).
NC-17	No one 17 and under admitted.
X	X is an older rating that is unified with NC-17 but may be encoded in the data of older movies.

EXAMPLE

- If you select "PG-13", this will automatically block the higher ratings "R", "NC-17" and "X".

NOTE

- Voluntary movie rating system only uses an age-based rating.

Useful adjustment settings

TV Parental Guidelines (TV Guidelines)

- 1 Press **TV MENU** and the MENU screen displays.
- 2 Press **◀/▶** to select  (LOCKS).
- 3 Press **▲/▼**. The password entering menu displays.
- 4 Input the 4-digit password by using **0–9**, then press **ENTER**.
The LOCKS menu displays.
- 5 Press **▲/▼** to select "TV RATING". Then press **◀/▶** to select the desired rating.

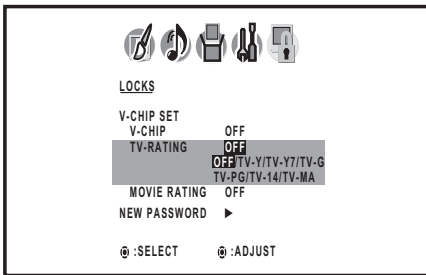

- When you select TV-Y7, TV-PG, TV-14 or TV-MA, "DISPLAY TO SET CONTENTS" will appear on the screen. Press **DISPLAY** to explain the rating. Press **▲/▼** to select the desired rating you want. Press **◀/▶** to select the setting "ON" or "OFF". Then press **RETURN**.
- See page 25 for setting details.

- 6 Press **▲/▼** to select "V-CHIP", then press **◀/▶** to select "ON".

Your setting are now set into memory.

- If "V-CHIP" is not set to "ON", the V-CHIP setting will not work.

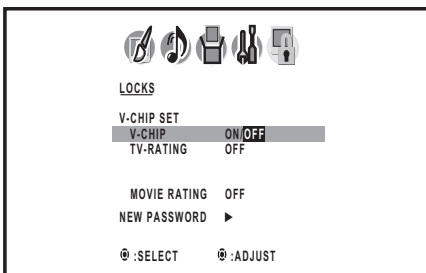

- 7 Press **EXIT** to return to the normal screen.

Voluntary movie rating system (MPAA)

- 1 Repeat steps 1 to 5 in **TV Parental Guidelines (TV Guidelines)**.
- 2 Press **▲/▼** to select "MOVIE RATING". Then press **◀/▶** to select desired setting.

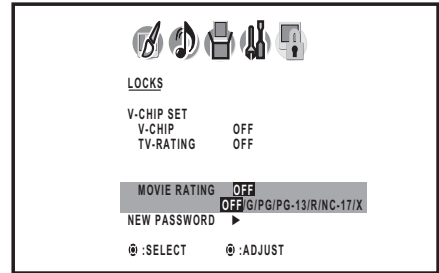

- See page 25 for setting details.

- 3 Press **EXIT** to return to the normal screen.

How to temporarily release the V-CHIP block

The V-CHIP block is working and censors a broadcast, "THIS PROGRAM HAS BEEN BLOCKED!" displays.

- 1 Press **MUTE** while the V-CHIP is working and then the password entering menu displays.
- 2 Enter your 4-digit password with **0–9**. At this time V-CHIP block temporarily releases.

Reactivating the temporarily released V-CHIP block

You can reactivate the temporarily released V-CHIP block as shown below.

Method 1:

Change to the other channel.

Method 2:

Switch off the TV power.

NOTE

- Performing any of the two above will activate the V-CHIP block.

Connecting a PC (Personal computer)

Viewing an image from a PC

Use the INPUT5 (PC) terminals to connect a PC.

NOTE

- The PC input terminals are DDC1/2B-compatible.
- Refer to page 28 for a list of PC signals compatible with the System.
- Make sure to select the same signal values for the output signal of a PC and the input signal of the TV/DVD set before connecting with the PC. (See page 28.)
- Depending on the PC being used, images may not be shown without converting the output signals into external output. Please refer to your PC's manuals regarding converting to external output.

Connecting the RGB cable



- Connect the RGB cable making sure that it fits correctly into the terminal. Then, firmly secure the connectors by tightening the screws on both sides of the plug.

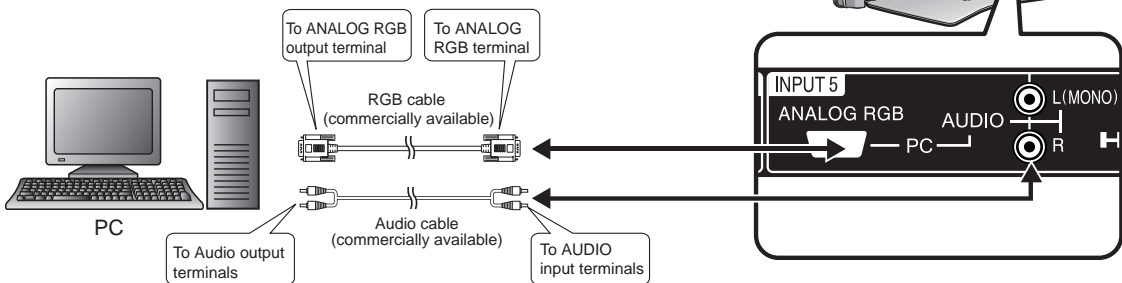
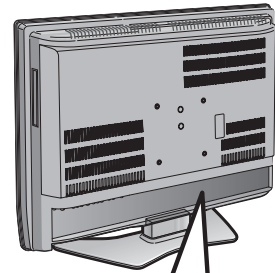

Signal names for 15-pin mini D-sub connector

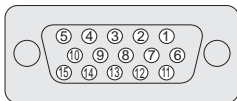

Pin No.	Signal name	Pin No.	Signal name	Pin No.	Signal name
①	R	⑥	GND (Ground)	⑪	Not connected
②	G	⑦	GND (Ground)	⑫	SDA
③	B	⑧	GND (Ground)	⑬	HD
④	Not connected	⑨	+5V	⑭	VD
⑤	CSYNC	⑩	GND (Ground)	⑮	SCL

NOTE

- Pin No. 5 is not used for inputting the signal.
- Pin No. 9 is not connected with the supplied RGB cable.

Displaying an image from a PC

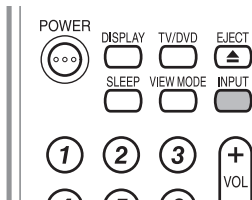

To view an image from a PC, perform the following procedure.

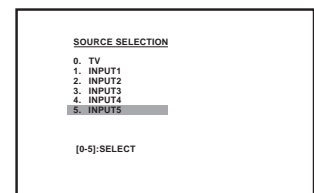

- ① Select the INPUT5 (PC) mode using **INPUT** on the remote control or the TV/DVD. (See page 19.)
- ② Select the PC input signal. (See page 28.)
- ③ Adjust the "PICTURE." items if the PC image does not come in clearly. (See page 28.)



Connecting a PC (personal computer)

Picture and Audio adjustments in the PC mode

There are a number of picture settings you can adjust to optimize the performance of the unit in PC mode.

- 1 Press **TV MENU** during PC mode. PC monitor menu will appear.
 - 2 Press **◀/▶** to select  (PICTURE) or  (AUDIO).
-
- 3 Press **▲/▼** to select a specific adjustment item.
 - 4 Press **◀/▶** to adjust the setting.
 - 5 Press **EXIT** to return to the normal screen.

PC compatibility chart

PC/MAC	Resolution	Horizontal Frequency (kHz)	Vertical Frequency (Hz)	Compatible		
PC	VGA	640 x 400	31.5	60		
			37.9	85		
		720 x 400	31.5	60		
			31.5	70	✓	
		640 x 480	37.9	85		
			37.5	75	✓	
	WVGA	848 x 480	43.3	85		
	SVGA	848 x 480	31.0	60	✓	
			35.1	56		
		800 x 600	37.9	60		
			48.1	72		
			46.9	75		
			53.7	85		
		XGA	1,024 x 768	48.4	60	✓
				56.5	70	
60.0				75		
68.7				85		
WXGA	1,280 x 720	44.8	60	✓		
	1,280 x 768	47.8	60	✓		
		48.1	60			
SXGA	1,280 x 1,024	47.7	60	✓		
MAC 13"	VGA	640 x 480	34.9	67		
MAC 16"	SVGA	832 x 624	49.7	75		
MAC 19"	XGA	1,024 x 768	60.2	75		

NOTE

- The numerical values of resolutions and frequencies mentioned above are standard. They may differ from the values when actually displayed.

Picture Adjustment

Selected Item	Description
BRIGHTNESS	To adjust the brightness of PC Monitor screen.
CONTRAST	To adjust the contrast of PC Monitor screen.
HOR POSITION	To adjust the horizontal position of the image on the PC Monitor screen. Each video standard will require a different value for this setting.
VER POSITION	To adjust the vertical position of the image on the PC Monitor screen. Each video standard will require a different value for this setting.
PHASE	This must be adjusted after the frequency has been set optimize picture quality.
CLOCK	To minimize any vertical bars or stripes visible on the screen background.
RED/GREEN/BLUE	To adjust the color temperature of the PC Monitor screen.
WVGA INPUT	Set to ON, when you select the WVGA mode on the PC.
WXGA INPUT	Set to ON, when you select the WXGA mode on the PC.

Audio Adjustment

Selected Item	Description
BASS	Press ◀ or ▶ to adjust the bass sound.
TREBLE	Press ◀ or ▶ to adjust the treble sound.
BALANCE	Press ◀ or ▶ to obtain an equal sound level from both speakers.
SURROUND	Press ◀ or ▶ to turn on or off the surround effect.

NOTE

- If no buttons are pressed for more than approx. 60 seconds, the PC Monitor Menu screen will return to normal Monitor screen automatically.
- The PC Monitor Menu settings are not effective for normal TV mode or external input modes.

NOTE

- For resetting all Picture adjustment items or Audio adjustment items to the factory preset values, press **▲/▼** to select "RESET", and then press **◀/▶**.
Factory settings;
Picture adjustment:
BRIGHTNESS..... center (25)
CONTRAST.....maximum (50)
RED/GREEN/BLUE..... center (25)

Audio adjustment:

BASS/TREBLE..... center (25)
BALANCEcenter (0)

Watching the DVD

Simple operations for watching a DVD.

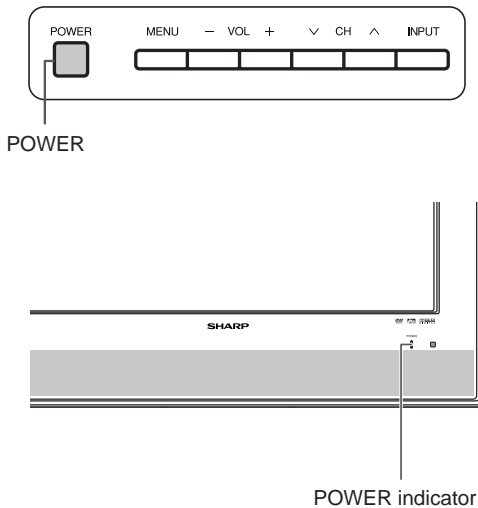

TV/DVD status indicator (POWER)

ON	Lighting (Green)
OFF/Standby	Lighting (Red)

POWER (On/Standby) TV/DVD

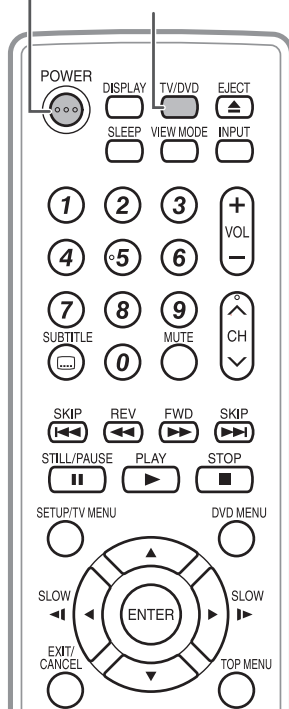

Preparation

Perform the following steps before you press **POWER** on the remote control unit.

1. Insert the batteries into the remote control unit. (See page 8.)
2. Connect the antenna cable to the TV/DVD. (See page 12.)
3. Plug in the AC cord to the AC outlet. (See page 7.)

Turning on the power

Press **POWER** on the TV/DVD, or **POWER** on the remote control.

- POWER indicator (Green): The TV/DVD is on.

Select the DVD mode

Press **TV/DVD** to select the DVD mode.

Turning off the power

Press **POWER** on the TV/DVD, or **POWER** on the remote control.

- The TV/DVD enters standby mode and the image on the screen disappears.
- The POWER indicator on the TV/DVD changes to Red.

NOTE

- If you are not going to use this TV/DVD for a long period of time, be sure to remove the AC cord from the power outlet.
- Weak electric power is still consumed even when **POWER** is turned off.
- If a station being viewed stops broadcasting, the TV/DVD will automatically shut itself off after 15 minutes. (TV mode only.)

Watching the DVD

Playback procedure

1

Place the disc in the disc slot with the label side facing forward. (If the disc has a label.) Hold the disc without touching its surface, align it with the guides, and place it in position.



2

On the screen, "▲" changes to "Reading" and then playback will commence.

- A menu screen appear on the TV screen, if the disc has a menu feature. In this case, press ▲/▼/◀/▶ or ENTER to operate a menu feature.

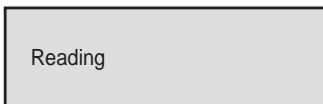

3

Press **STOP** to end playback.

- The unit memorizes the stopped point, depending on the disc. "■" appears on the screen. Press **PLAY** to resume playback (from the scene point).
- If you press **STOP** again ("■" appears on the screen) or unload the disc, the TV/DVD will clear the stopped point.

4

Press **EJECT**.

Remove the disc and then press **POWER**. The TV/DVD turns off.

When you eject the disc, you may hear mechanism noise, but it is not malfunction.

Status display of disc

Press **DISPLAY**. The status display of the disc will appear on the screen in order like the figure below.

DVD

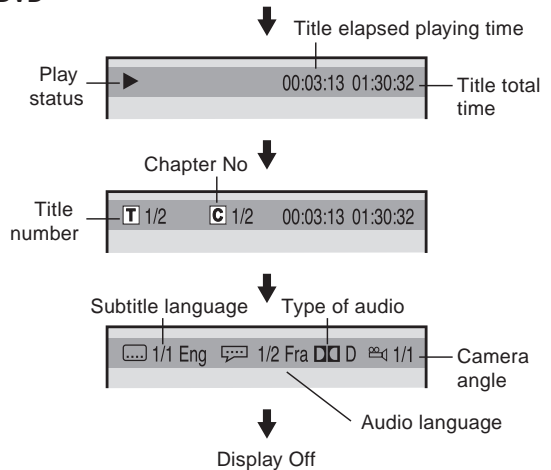

Audio CD

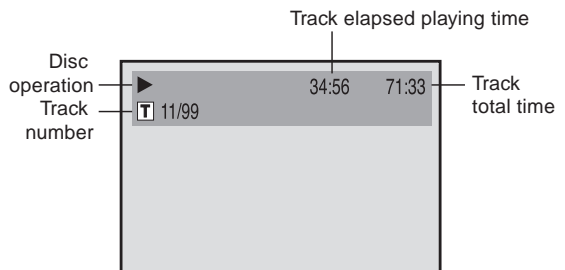

- When you play a CD disc, the status display will appear and remain on the screen.

NOTE

If the TV/DVD does not operate properly:

Static electricity, etc., may affect the player's operation. Disconnect the AC power cord once, then connect it again.

NOTE

- If a non-compatible disc is loaded, "Incorrect Disc", "Region Code Error" or "Parental Error" will appear on the TV screen according to the type of loaded disc. If these appear, check your disc again (see pages 5 and 41).
- Some discs may take a minute or so to start playback.
- When an 8 cm disc is placed into the disc slot, and the playback picture or menu display does not appear, press **PLAY**.
- A "Prohibition" symbol "⊞" may appear at the upper left of the screen. This symbol means either the feature you tried is not available on the disc, or the TV/DVD cannot access the feature at this time. This does not indicate a problem with the TV/DVD.
- When you set a single-faced disc label downwards (i.e. the wrong way up) "Reading" will appear on the display and then "Incorrect Disc" will be displayed.
- Some playback operations of DVDs may be intentionally fixed by software producers. Since this TV/DVD plays DVDs according to the disc content recorded, some playback features may not be available. Also refer to the instructions supplied with the DVDs.

Watching the DVD

Special playback

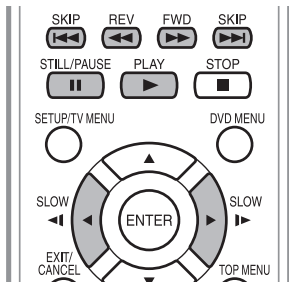

Fast Forward Playback

Press **FWD** during normal playback.

Each press of **FWD** will increase the speed of the search
 ►► (x 2), ►►►► (x 4), ►►►►►► (x 8), ►►►►►►►► (x 15).

(CD: ►► (x 2), ►►►► (x 4), ►►►►►► (x 8), ►►►►►►►► (x 20))

- To resume normal playback, press **PLAY**.
- The above figure shown in parentheses indicates the average speed multiplier.

Review Playback

Press **REV** during normal playback.

Each press of **REV** will increase the speed of the search
 ◀◀ (x 2), ◀◀◀◀ (x 4), ◀◀◀◀◀◀ (x 8), ◀◀◀◀◀◀◀◀ (x 15).

(CD: ◀◀ (x 2), ◀◀◀◀ (x 4), ◀◀◀◀◀◀ (x 8), ◀◀◀◀◀◀◀◀ (x 20))

- To resume normal playback, press **PLAY**.
- The above figure shown in parentheses indicates the average speed multiplier.

Still Playback

Press **STILL/PAUSE** during normal playback to pause playback.

- To resume normal playback, press **PLAY**.



Frame Advance

Press **STILL/PAUSE** during still playback.

One frame is advanced each time you press **STILL/PAUSE**.

- To resume normal playback, press **PLAY**.

Slow-motion Playback

Press **SLOW** (▶) or **SLOW** (◀) during normal playback or still playback.

Each press of **SLOW** will change the speed of the slow x1/2, x1/4, x1/6, x1/7.

- To resume normal playback, press **PLAY**.
- To resume the still playback, press **STILL/PAUSE**.

Locating a chapter or track

Press **SKIP** (▶▶) Forward or **SKIP** (◀◀) Reverse during playback to locate a chapter that you want to watch.

Each time you press the button, a chapter or track is skipped.

NOTE

The TV/DVD is capable of holding a still video image or On screen display image on your television screen indefinitely. If you leave the still video image or On screen display image displayed on your TV for an extended period of time, you risk permanent damage to your television screen.

Zooming

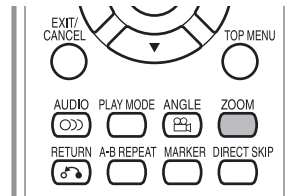

This TV/DVD will allow you to zoom in on the frame image. You can then make selections by switching the position of the frame.

1

Press **ZOOM** during playback.

The center part of the image will be zoomed in.

Each press of **ZOOM** will change the ZOOM magnification Q₁ (x 1.3), Q₂ (x 1.5) and Q₃ (x 2.0).

2

Press **▲/▼/◀/▶** to view a different part of the frame.

You may move the frame from the center position UP, DOWN, LEFT or RIGHT.

3

In the zoom mode press **ZOOM** repeatedly to return to a 1:1 view (Q Off).

NOTE

- You can select the Still Playback or Fast Forward (Review) Playback in the zoom mode.
- Some discs may not respond to zoom feature.

Locating desired scene

Use the title, chapter and time recorded on the disc to locate the desired point to playback.

1

Press **DIRECT SKIP** during playback.



2

Press **◀/▶** to select the "L" (Time), "T" (Title) or "C" (Chapter).

3

Press **Number buttons (0-9)** to input the number.

- If you input a wrong number, press **CANCEL**.
- Refer to the package supplied with the disc to check the numbers.

4

Press **ENTER**.

- Playback starts.
- When you change the title, playback starts from Chapter 1 of the selected title.
- Some discs may not work in the above operation.

Repeat playback

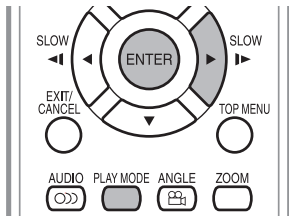

1 Press **PLAY MODE** during playback or stop mode.

2 Press **ENTER** to select "Chapter" or "Title".

- In case of Audio-CD, first press **▶** to select "Repeat" and then press **ENTER** to select "Track" or "All".

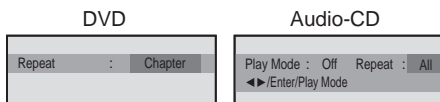

Press **PLAY MODE** again to make the screen disappear.

- Press **PLAY** to start Repeat playback.
- To resume normal playback, select Repeat "Off".

NOTE

- Some discs may not be compatible with the repeat operation.

A-B Repeat playback

A-B repeat playback allows you to repeat material between two selected points.

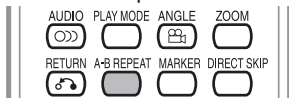

1 Press **A-B REPEAT** during playback. The start point is selected.

2 Press **A-B REPEAT** again. The end point is selected. Playback starts at the point that you selected. Playback stops at the end point, returns to Point A automatically, then starts again.

- To resume normal playback press **A-B REPEAT** again. "Off" appears on the screen.

NOTE

- In A-B Repeat mode, subtitles near the A or B locations may not be displayed.
- You cannot set the A-B Repeat for the scenes that include multiple angles.
- You may not be able to set A-B Repeat during certain scenes of the DVD.
- A-B Repeat does not work with an interactive DVD, MP3/WMA/JPEG-CD.

Marking desired scenes

The TV/DVD stores the points that you want to watch again up to 3 points. You can resume playback from each scene.

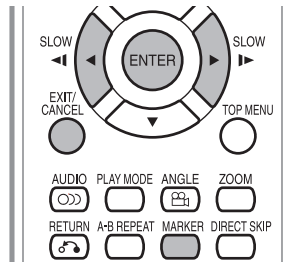

Marking the scenes

1 Press **MARKER** during playback.



2 Select the blank Marker using **◀/▶**, then press **ENTER** at the desired scene.

- Up to 3 scenes can be selected.
- Repeat this procedure to set the other 2 scenes.

3 Press **MARKER** to return to the normal screen.

Returning to the scenes

1 Press **MARKER** during playback or stop mode.

2 Press **◀/▶** to select the Marker 1-3.

3 Press **ENTER**. Playback starts from the marked scene.

To cancel the Marker

Follow the above steps 1~2, then press **CANCEL**.

NOTE

- Some discs may not work with the marking operation.
- The marking is cancelled when you eject the disc or turn the power off.
- Some subtitles recorded around the marker may fail to appear.

Watching the DVD

Program playback (only CD)

You can arrange the order of tracks on the disc.

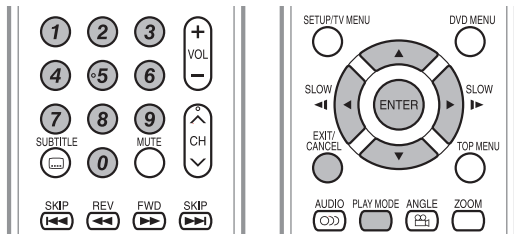

1 Press **PLAY MODE** in the stop mode.

2 Press **◀▶** to select “Play Mode”, then press **ENTER** to select “Program”.

3 **Example:** In case you wish to program in order of 7, 3, 11: Enter as **7 ▼, 3 ▼, 11.**

- If you input a wrong number, press **CANCEL**.

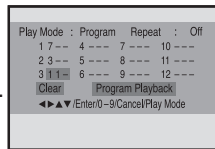

4 Press **▲/▼/◀▶** to select “Program Playback” and press **ENTER**. “Program Playback” will appear on the screen. The program you selected will begin to playback in the order set. To return to normal playback, select “Play Mode: Off” at step 2 above.

NOTE

- To cancel program play, select “Clear” at step 4 and press **ENTER**.
- The program is cancelled when you eject the disc or turn the power off.

Random playback (only CD)

1 Press **PLAY MODE** during playback or stop mode.

2 Press **◀▶** to select “Play Mode”, then press **ENTER** to select “Random”.

3 Press **PLAY**. “Random Play” will appear on the screen and Random playback will start. To return to normal playback, select “Play Mode : Off” at step 2 above.

NOTE

- Random playback cannot be combined with Repeat playback.

Changing angles

When playing back a disc recorded with multi-angle facility, you can change the view angle.

1 Press **ANGLE** during playback. The current angle will appear.



2 Press **ANGLE** repeatedly until the desired angle is selected.

NOTE

- In case of JPEG-playback, the JPEG-image is rotated 90 degrees to the right.
- Depending on the DVD, you may not be able to change the angles even if multi-angles are recorded on the DVD.

Title selection

Two or more titles are recorded on some discs. If the title menu is recorded on the disc, you can select the desired title.

1 Press **TOP MENU** during playback. Title menu appears on the screen.

2 Press **▲/▼/◀▶** to select the desired title.

3 Press **ENTER** or **PLAY**. The playback of the selected title will start.

DVD menu

Some DVDs allow you to select the disc contents using the menu.

When you play back these DVDs, you can select the subtitle language and soundtrack language, etc. using the DVD menu.

1 Press **DVD MENU** during playback. The DVD menu appears on the screen.

- Press **DVD MENU** again to resume playback at the scene when you pressed **DVD MENU**.

2 Press **▲/▼/◀▶** to select the desired item.

3 Press **ENTER**. The menu continues to another screen. Repeat steps 2 and 3 to set additional items if any.

NOTE

- Depending on the DVD, you may not be able to select the title. Depending on the DVD, a “title menu” may simply be called a “menu” or “title” in the instructions supplied with the disc.

Watching the DVD

Changing soundtrack language

You can select the language when you play a multilingual disc.

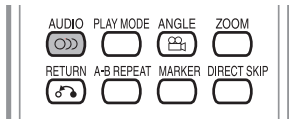

- 1 Press **AUDIO** during playback. The current soundtrack language will appear.

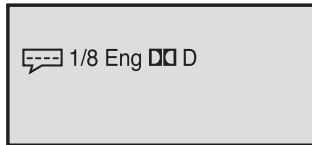

- 2 Press **AUDIO** repeatedly until the desired language is selected. The on-screen display will disappear after a few seconds.

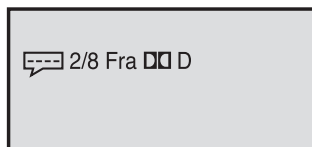

NOTE

- If the desired language is not heard after pressing **AUDIO** several times, the language is not recorded on the disc.
- Changing soundtrack language is cancelled when you eject the disc. The initial default language or available language will be heard if the disc is played back again.

Subtitles

Changing the subtitle language

You can select the language when playing back a disc recorded with multi-lingual subtitles.

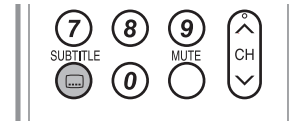

- 1 Press **SUBTITLE** repeatedly during playback until your desired language appears.

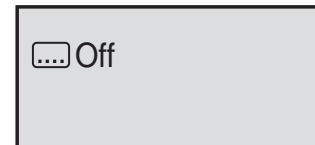

- 2 The on-screen display will disappear after a few seconds.

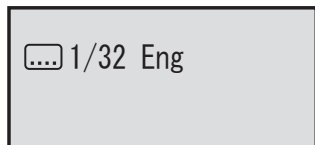

Turning the subtitles on and off

Press **SUBTITLE** during playback until "Off" appears.

NOTE

- Changing subtitle language is cancelled when you eject the disc.
- Some functions may not work on some DVDs. You may not be able to turn subtitles on or off or change subtitles. While playing the DVD, the subtitle may change when:
 - you eject or insert the disc.
 - you change the title.
- In some cases, the subtitle language is not changed to the selected one immediately.

MP3/WMA/JPEG CD playback

This TV/DVD can playback the MP3/WMA/JPEG-data which has been recorded on CD-R or CD-RW. To produce the MP3/WMA/JPEG-data, you need a Windows-PC with CD-R/RW drive and a MP3/WMA/JPEG-encoding Software (not supplied).

The Apple-HFS-System cannot be played.

NOTE

This TV/DVD requires discs/recordings to meet certain technical standards in order to achieve optimal playback quality. Pre-recorded DVDs are automatically set to these standards. There are many different types of recordable disc formats (including CD-R containing MP3/WMA files). Given the fact that technology in this area is still maturing, This unit cannot guarantee that all genre of recordable discs will produce optimal playback quality. The technical criteria set out in this owner's manual are meant as a guide only.

Please be advised that you must obtain permission from the applicable copyright owners to download copyrighted content, including music files, in any format, including the MP3 and WMA formats, prior to the downloading thereof.

MP3/WMA /JPEG CD information

Limitations on MP3/WMA/JPEG CD playback

- MP3/WMA/JPEG CD is the disc that is standardized by ISO9660, its file name must include 3-digits extension letters, "mp3", "wma", "jpg".
- MP3/WMA/JPEG CD must be correspond to the ISO standardized files.
- This TV/DVD can read 600 files per disc. If one directory has more than 600 files, it reads up to 600 files, the remaining files will be omitted.
- The unit is able to recognize up to a maximum of 50 directories per disc.
- MP3/WMA/JPEG CDs cannot be used for the purpose of recording.
- If the CD has both audio tracks and MP3/WMA/JPEG files, only audio tracks are played.
- It may take more than one minute for this unit to read MP3/WMA/JPEG files depending on its structure.
- Music recorded by "Joliet Recording Specification" can be played back, the file name is displayed (within 16 letters) on the screen. Long file names will be condensed.
- The music files recorded by "Hierarchical File System" (HFS) cannot be played.

Limitations on display

- The maximum number for display is 16 letters.
Available letters for display are the following: capital or small alphabets of A through Z, numbers of 0 through 9, and _ (under score).
- Other letters than those above are replaced in hyphen.

Notes on MP3/WMA/JPEG files

To playback MP3/WMA/JPEG CD in the recorded order,

1. Use MP3/WMA/JPEG software that records data alphabetically or numerically.
2. Name each file including two-digit or three-digit number (ex. "01" "02" or "001" "002").
3. Refrain from making too many sub-folders.

CAUTION:

- Some MP3/WMA/JPEG CDs cannot be played back depending on the recording conditions.
- The CD-R/RW that has no music data or non MP3/WMA/JPEG files cannot be played back.

Standard, sampling frequency, and the bit rate:

MP3 CD

MPEG-1 Audio

32kHz, 44.1kHz, 48kHz

32kbps ~ 320kbps (constant bit rate or variable bit rate)

The recommend recording setting for a high-quality sound is 44.1kHz of sampling frequency and 128kbps of constant bit rate.

WMA CD

WMA version 7, and 8

32kHz, 48kbps

44.1kHz, 48kbps ~ 192kbps

48kHz, 128kbps ~ 192kbps

The file recorded by mono, 48kHz, 48 kbps is not available to this unit.

Microsoft, Windows Media, and the Windows Logo are either registered trademarks or trademarks of Microsoft Corporation in the United States and/or other countries.

MP3/WMA CD playback

- 1 Load a disc on which MP3 or WMA files have been recorded in the disc slot.
- 2 "Reading" will appear on the TV screen. Reading time will depend on the number of files on the disc.
- 3 A file menu screen will appear on the TV screen. Press ◀▶ to select a folder.

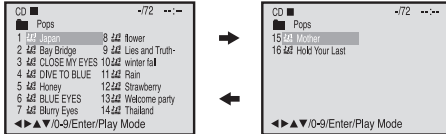

- 4 Press ▲/▼/◀▶ or a **Number button (0-9)** to select the desired file.
 - In case the folder includes more than 15 files, press ◀▶ to display next file list.
 - When **PLAY** has been pressed after displaying the file menu, playback begins automatically starting from the first file. In this case, if the first file is an MP3/WMA file, only MP3/WMA files are played back in order. If the first file is a JPEG file, the first JPEG file is played back.
- 5 Press **ENTER**. The selected file starts playing back.
- 6 Press **STOP** to end playback.
 - The TV/DVD records the stopped point. "■" appears on the screen. Press **PLAY** to resume playback (from the scene point).
 - If you press **STOP** again or unload the disc, the unit will clear the stopped point.

NOTE

- During MP3/WMA/JPEG-Playback, you cannot use SEARCH, or A-B Repeat functions.
- You can use Repeat (Track or All), Random functions and Program playback for MP3/WMA/JPEG CD Playback (see page 33).

JPEG CD playback

- 1 Insert a disc to play same method as step 1-2 left column.
- 2 A file menu screen will appear on the TV screen. Press ◀▶ to select a folder.
- 3 Press ▲/▼/◀▶ or **Number buttons (0-9)** to select the desired file.
 - When **PLAY** has been pressed after displaying the file menu, playback begins automatically starting from the first file. In this case, if the first file is a JPEG file, the first JPEG file is played back. If the first file is an MP3/WMA file, only MP3/WMA files are played back in order.
- 4 Press **ENTER**. The selected picture appears on the screen.
- 5 Press **STOP** to end playback. The file menu appears on the screen. If you want to watch the other file, repeat steps 3-4.

NOTE

- MP3 or WMA files on the KODAK Picture CD are not recognized on this unit.
- In case of JPEG-playback, the JPEG-image is rotated 90 degrees to the right.

About file menu

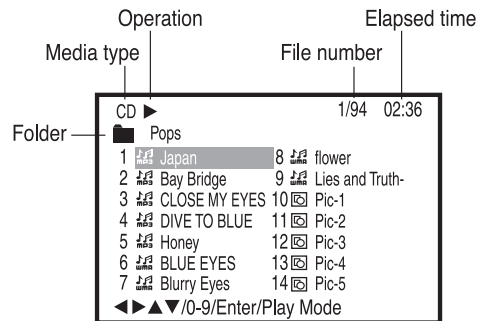

- : Indicates MP3 file
- : Indicates WMA file
- : Indicates JPEG file

Setting the JPEG interval

You can continuously playback all JPEG files automatically.

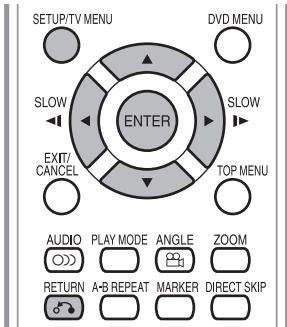

- 1 Press **SETUP** and the SETUP screen displays.
- 2 Press **◀▶** to select  (PICTURE), then press **▼** or **ENTER**.
- 3 Press **▲/▼** to select "JPEG Interval".
- 4 Press **◀▶** to select your desired time.

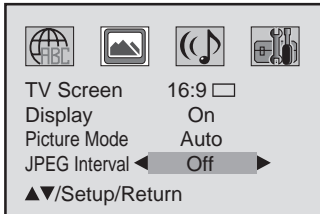

Selected item	Description
Off	Plays back one file at a time.
5 Seconds	Displays images in the form of a slide show. Every 5 seconds the image changes.
10 Seconds	Displays images in the form of a slide show. Every 10 seconds the image changes.
15 Seconds	Displays images in the form of a slide show. Every 15 seconds

- 5 Press **RETURN** to return to the normal screen.

NOTE

- You cannot display DVD SETUP screen when disc is playback.

Setting the select files

When playing back a CD containing a mixture of MP3, WMA and JPEG files, only MP3/WMA or JPEG files can be displayed on the file menu.

- 1 Press **SETUP** and the SETUP screen displays.
- 2 Press **◀▶** to select  (SETUP), then press **▼** or **ENTER**.
- 3 Press **▲/▼** to select "Select Files".
- 4 Press **◀▶** to select your desired file type.

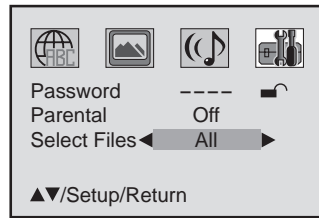

Selected item	Description
All	Displays all files.
Music Only	Displays only MP3/WMA files.
Pictures Only	Displays only JPEG files.

- 5 Press **RETURN** to return to the normal screen.

NOTE

- You cannot display DVD SETUP screen when disc is playback.

Function setup

Basic operation buttons

Use the following buttons on the remote control to operate the menu.

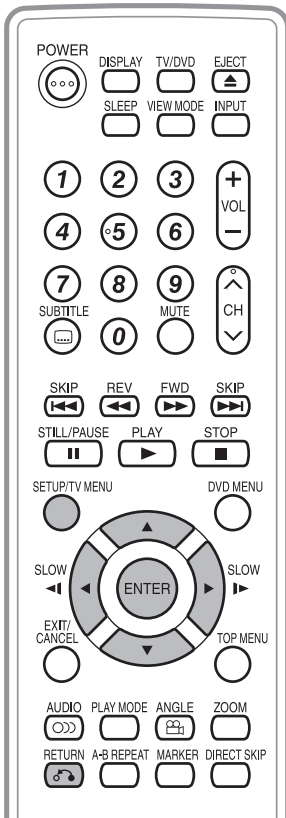

- SETUP:** Press to open the menu screen.
- ▲/▼/◀/▶:** Press to select a desired item on the screen or adjust a selected item.
- ENTER:** Press to go to the next step or complete the setting.
- RETURN:** Press to exit from the menu screen. All changed settings will be saved.

▲▼/Setup/Return

The lower part of the menu screen is an operational guide for the remote control. It will change in accordance with each menu setting screen.

Menu items

List of menu items to help you with operations



Menu	Page 39
Subtitle	Page 39
Audio	Page 39



TV Screen	Page 39
Display	Page 40
Picture Mode	Page 40
JPEG Interval	Page 37



DRC.....	Page 40
----------	---------



Password.....	Page 41
Parental	Page 41
Select Files.....	Page 37

NOTE

- You cannot display DVD SETUP screen when disc is playback.

Function setup

Setting the language

You can select the language of the disc menu messages of DVDs.

The same language can always be selected even if you replace the disc or turn the power off.

- 1 Press **SETUP** and the SETUP screen displays.
- 2 Press ◀▶ to select  (LANGUAGE), then press ▼ or **ENTER**.
- 3 Press ▲/▼ to select desired option.
- 4 Press ◀▶ to select your desired language (e.g. English).



Selected item	Description
English, Francais, Espanol:	The selected language will be heard or seen.
Other	Other language can be selected (see the "Language code list" on page 43).
Off (Subtitle)	Subtitles do not appear.
Original (Audio)	The unit will select the first priority language of each disc.

- 5 Press **RETURN** to return to the normal screen.



NOTE

- If the selected language is not recorded on the disc, the first priority language is selected.

Setting the aspect ratio of TV screen

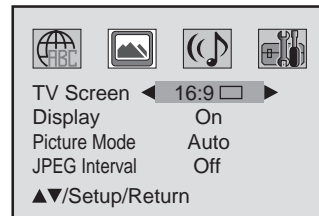
- 1 Press **SETUP** and the SETUP screen displays.
- 2 Press ◀▶ to select  (PICTURE), then press ▼ or **ENTER**.
- 3 Press ▲/▼ to select "TV Screen".
- 4 Press ◀▶ to select your desired screen type.



Selected item	Description
4:3 (Letter box) 	When playing back a wide screen-DVD disc, it displays the wide picture with black bands at the top and bottom of screen.
4:3 (Pan Scan) 	It displays the wide picture on the whole screen with left and right edges automatically cut off.
16:9 (Wide) 	Select this mode when connecting to a wide-screen TV. A wide screen picture is displayed full size.

- 5 Press **RETURN** to return to the normal screen.

NOTE

- If the DVD disc is not formatted in the pan & scan style, it displays 4:3 style.

Function setup

Setting on screen display

On screen display can be switched on or off when you press the **DISPLAY** button.

- 1 Press **SETUP** and the SETUP screen displays.
- 2 Press **◀▶** to select  (PICTURE), then press **▼** or **ENTER**.
- 3 Press **▲▼** to select "Display".
- 4 Press **◀▶** to select "On" or "Off".
 - If "Display" is not set to "On" on screen displays do not appear when you press any buttons except **SUBTITLE**, **PLAY MODE**, **MARKER**, **DIRECT SKIP** and **DISPLAY**.
- 5 Press **RETURN** to return to the normal screen.

Setting the picture mode

There are two types of source content in pictures recorded in DVD video discs: film content (pictures recorded from films at 24 frames per second) and video content (video signals recorded at 30 frames per second). Make this selection according to the type of content being viewed.

- 1 Press **SETUP** and the SETUP screen displays.
- 2 Press **◀▶** to select  (PICTURE), then press **▼** or **ENTER**.
- 3 Press **▲▼** to select "Picture Mode".
- 4 Press **◀▶** to select your desired picture mode.

Selected item	Description
Auto	Select this position normally. The DVD player automatically detects source content, film or video, of playback source.
Film	Suitable for playback of film content pictures.
Video	Suitable for playback of video content pictures.

- 5 Press **RETURN** to return to the normal screen.

Dynamic Range Control

DRC (Dynamic Range Control) enables you to control the dynamic range so as to achieve a suitable sound for your equipment.

- 1 Press **SETUP** and the SETUP screen displays.
- 2 Press **◀▶** to select  (AUDIO), then press **▼** or **ENTER**.
- 3 Press **▲▼** to select "DRC".
- 4 Press **◀▶** to select "On" or "Off".

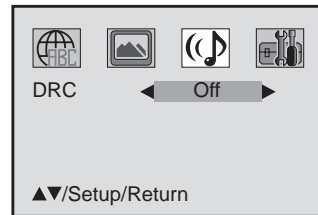

Selected item	Description
On	Loud sound such as explosion or similar is toned down slightly when played back. This makes it suitable for when it is connected to a stereo.
Off	It plays back at the recording level on the disc.

- 5 Press **RETURN** to return to the normal screen.

NOTE

- This function works only during playback of Dolby Digital recorded discs.
- The level of Dynamic Range Reduction may differ depending on DVD video disc.

Function setup

Parental control setting

Some discs are specified as not suitable for children. Playback of such discs can be restricted with this TV/DVD.

- 1 Press **SETUP** and the SETUP screen displays.
- 2 Press **◀/▶** to select  (SETUP), then press **▼** or **ENTER**.
- 3 Press **▲/▼** to select "Parental".
- 4 Press **◀/▶** until the level you require appears.

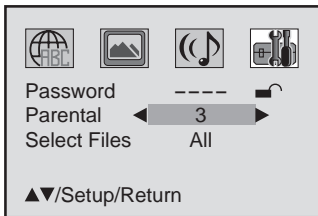

Selected item	Description
Level Off	The parental control setting does not function.
Level 8	Virtually all DVD software can be played back.
Level 1	DVD software for adults cannot be played back.

- Select from level 1 to level 8. The limitation will be more severe as the level number decreases.

- 5 Press **▲** to select "Password". Press **Number buttons (0-9)** to input a 4-digit password. Be sure to remember this number!
 - If you input a wrong number, press **CANCEL**.

- 6 Press **ENTER** to store the password.

NOTE

After the rating is locked, the setting cannot be changed unless you enter the correct password.

- 7 Press **RETURN** to return to the normal screen.

NOTE

- Depending on the discs, the TV/DVD may not be able to limit playback.
- Some discs may not be encoded with specific rating level information though its disc jacket says "adult." For those discs, the parental control feature will not work.

To change the parental level

- 1 Press **SETUP** and the SETUP screen displays.
- 2 Press **◀/▶** to select  (SETUP), then press **▼** or **ENTER**.
- 3 Press **▲/▼** to select "Password".
- 4 Press **Number buttons (0-9)** to enter the password you have stored.
 - If you input a wrong number, press **CANCEL**.

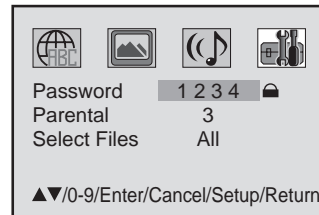

- 5 Press **ENTER**. The rating is now unlocked.
- 6 Press **▼** to select "Parental", then press **◀** or **▶** to change the parental level.
- 7 Press **▲** to select "Password", then press **Number buttons (0-9)** to enter the password.

NOTE

You can change the password at this time if you want.

- 8 Press **ENTER**. The parental level is changed and locked.

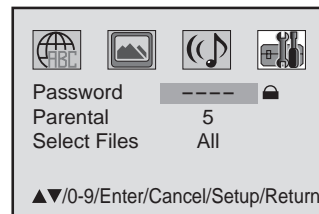

- 9 Press **RETURN** to return to the normal screen.

NOTE

If you forget the password...

1. Press **EJECT** to remove the disc.
2. While holding **STOP** down on the front panel, press **7** on the remote control for more than 2 seconds. "PASSWORD CLEAR" appears on the screen.
3. Enter a new password again.

Temporary disabling of rating level by DVD disc

Depending on the DVD disc, the disc may try to temporarily cancel the rating level that you have set. It is up to you to decide whether to cancel the rating level or not.

1 Load a DVD disc. (See page 30.)

2 If the DVD disc has been designed to temporarily cancel the rating level, the screen which follows the "Reading" screen will change, depending on which disc is played. If you select "YES" with pressing **ENTER**, "Your disc exceeds the parental control level 1." (e.g.) screen will then appear.

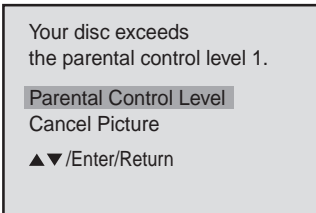

3 If you wish to cancel the set rating level temporarily, select "Parental Control Level" with ▲/▼, then press **ENTER**. If the 4-digits password at step 5 on page 41 has been set, the password entering screen will appear as shown in step 4 below. Alternatively, if the password has not been set, playback will commence. If you don't know (or have forgotten) the password, select "Cancel Picture". The setting screen will disappear. Press **EJECT** to remove the disc.

4 Enter the password with **Number buttons (0-9)**. Then press **ENTER**.

- If you interrupt the entering, press **RETURN**.

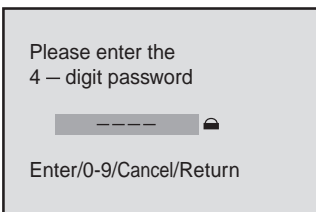

5 Playback will commence if the entered password was correct.

NOTE

- This temporary cancellation of the rating level will be kept until the disc is ejected. When the disc is ejected, the original rating level will be set again automatically.

Appendix

Language code list

Enter the appropriate code number for the initial settings “Menu”, “Subtitle” and/or “Audio” (see page 39).

Language Name	Code	Language Name	Code	Language Name	Code	Language Name	Code
Abkhazian	1112	Fiji	1620	Lingala	2224	Singhalese	2919
Afar	1111	Finnish	1619	Lithuanian	2230	Slovak	2921
Afrikaans	1116	French	1628	Macedonian	2321	Slovenian	2922
Albanian	2927	Frisian	1635	Malagasy	2317	Somali	2925
Amharic	1123	Galician	1722	Malay	2329	Spanish	1529
Arabic	1128	Georgian	2111	Malayalam	2322	Sundanese	2931
Armenian	1835	German	1415	Maltese	2330	Swahili	2933
Assamese	1129	Greek	1522	Maori	2319	Swedish	2932
Aymara	1135	Greenlandic	2122	Marathi	2328	Tagalog	3022
Azerbaijani	1136	Guarani	1724	Moldavian	2325	Tajik	3017
Bashkir	1211	Gujarati	1731	Mongolian	2324	Tamil	3011
Basque	1531	Hausa	1811	Nauru	2411	Tatar	3030
Bengali; Bangla	1224	Hebrew	1933	Nepali	2415	Telugu	3015
Bhutani	1436	Hindi	1819	Norwegian	2425	Thai	3018
Bihari	1218	Hungarian	1831	Oriya	2528	Tibetan	1225
Breton	1228	Icelandic	1929	Panjabi	2611	Tigrinya	3019
Bulgarian	1217	Indonesian	1924	Pashto, Pushto	2629	Tonga	3025
Burmese	2335	Interlingua	1911	Persian	1611	Turkish	3028
Byelorussian	1215	Irish	1711	Polish	2622	Turkmen	3021
Cambodian	2123	Italian	1930	Portuguese	2630	Twi	3033
Catalan	1311	Japanese	2011	Quechua	2731	Ukrainian	3121
Chinese	3618	Javanese	2033	Rhaeto-Romance	2823	Urdu	3128
Corsican	1325	Kannada	2124	Romanian	2825	Uzbek	3136
Croatian	1828	Kashmiri	2129	Russian	2831	Vietnamese	3219
Czech	1329	Kazakh	2121	Samoan	2923	Volapük	3225
Danish	1411	Kirghiz	2135	Sanskrit	2911	Welsh	1335
Dutch	2422	Korean	2125	Scots Gaelic	1714	Wolof	3325
English	1524	Kurdish	2131	Serbian	2928	Xhosa	3418
Esperanto	1525	Laothian	2225	Serbo-Croatian	2918	Yiddish	2019
Estonian	1530	Latin	2211	Shona	2924	Yoruba	3525
Faroese	1625	Latvian, Lettish	2232	Sindhi	2914	Zulu	3631

Troubleshooting

Problem	Possible Solution
<ul style="list-style-type: none"> No power 	<ul style="list-style-type: none"> Check if you pressed POWER on the remote control unit. (See page 13.) If the indicator on the TV/DVD does not light up, press POWER on the TV/DVD. Is the AC cord disconnected? (See page 7.) Has the power been turned on? (See page 13.)
<ul style="list-style-type: none"> Unit cannot be operated. 	<ul style="list-style-type: none"> External influences such as lightning, static electricity, may cause improper operation. In this case, operate the unit after first turning on the power of the TV/DVD or unplugging the AC cord and replugging it in after 1 or 2 minutes.
<ul style="list-style-type: none"> Remote control unit does not operate. 	<ul style="list-style-type: none"> Are batteries inserted with polarity (+, -) aligned? (See page 8.) Are batteries worn out? (Replace with new batteries.) Are you using it under strong or fluorescent lighting? Is a fluorescent light illuminated near the remote control sensor?
<ul style="list-style-type: none"> Picture is cut off screen. 	<ul style="list-style-type: none"> Are screen mode adjustments such as view mode choose made correctly? (See page 22.)
<ul style="list-style-type: none"> Strange color, light color, or color misalignment 	<ul style="list-style-type: none"> Adjust the picture tone. (See page 17.) Is the room too bright? The picture may look dark in a room that is too bright.
<ul style="list-style-type: none"> Power is suddenly turned off. 	<ul style="list-style-type: none"> Is the sleep timer set? (See page 11.) Check the power control settings. (See page 13.) The TV/DVD's internal temperature has increased. Remove any objects blocking vent or clean.
<ul style="list-style-type: none"> No picture 	<ul style="list-style-type: none"> Is connection to other components correct? (See pages 19 to 20.) Is correct input signal source selected after connection? (See page 19.) Is the correct input selected? (See page 19.) Is picture adjustment correct? (See page 17.)
<ul style="list-style-type: none"> No sound 	<ul style="list-style-type: none"> Is the volume too low? (See page 13.)

Troubleshooting-PC mode

Problem	Possible Solution
<ul style="list-style-type: none"> There is no image. 	<ul style="list-style-type: none"> Make sure the RGB cable is properly connected. (See page 27.) Make sure the output signal of the PC and the input signal setting of the LCD TV set are matched. (See page 28.) Some software prohibit video playback on an external display when playing back a video with a notebook PC. This is not attributable to a problem with the LCD TV set.
<ul style="list-style-type: none"> There is no sound. 	<ul style="list-style-type: none"> Make sure the PC audio cable is properly connected. (See page 27.) Check if the mute function activates, or if the volume is set to minimum. (See page 13.)
<ul style="list-style-type: none"> The image is not displayed in the center of the screen. 	<ul style="list-style-type: none"> Adjust "CLOCK" and "PHASE" using the PICTURE menu. (See page 28.) Adjust "HOR POSITION" and "VER POSITION" using the PICTURE menu. (See page 28.)

Cautions regarding use in high and low temperature environments

- When the TV/DVD is used in a low temperature space (e.g. room, office), the picture may leave trails or appear slightly delayed. This is not a malfunction, and the TV/DVD will recover when the temperature returns to normal.
 - Do not leave the TV/DVD in a hot or cold location. Also, do not leave the TV/DVD in a location exposed to direct sunlight or near a heater, as this may cause the cabinet to deform and the Liquid Crystal panel to malfunction.
- Storage temperature: -4°F to +140°F (-20°C to +60°C)

Appendix

Troubleshooting-DVD

Problem	Possible Solution
<ul style="list-style-type: none"> Playback doesn't start. 	<ul style="list-style-type: none"> No disc is inserted. (See page 30.) The disc may be dirty. Clean up the disc. (See page 6.) The TV/DVD cannot play CD-ROMs, etc. (See page 5.)
<ul style="list-style-type: none"> No picture. 	<ul style="list-style-type: none"> TV/DVD selector is not set correctly. (See page 29.)
<ul style="list-style-type: none"> No sound. 	<ul style="list-style-type: none"> Check the input selector of the amplifier is set properly. The TV/DVD is in the special playback mode. (See page 31.) Select the correct Audio Output position on AV amplifier.
<ul style="list-style-type: none"> Picture is distorted during fast reverse/forward playback. 	<ul style="list-style-type: none"> The picture will be distorted occasionally.
<ul style="list-style-type: none"> Stopping playback, search, slowmotion play, repeat play, or program play, etc. cannot be performed. 	<ul style="list-style-type: none"> Some discs may not do some of the functions.
<ul style="list-style-type: none"> No on-screen display. 	<ul style="list-style-type: none"> Select Display to On. (See page 40.)
<ul style="list-style-type: none"> No surround sound. 	<ul style="list-style-type: none"> The setup does not match your stereo system.
<ul style="list-style-type: none"> The TV/DVD or remote operation key is not functioning. 	<ul style="list-style-type: none"> Turn off the TV/DVD and unplug the AC power cord for several minutes, then replug it.
<ul style="list-style-type: none"> Playback does not start when the title is selected. 	<ul style="list-style-type: none"> Check the Parental setup. (See page 41.)
<ul style="list-style-type: none"> Audio soundtrack and/or subtitle language is not changed when you playback a DVD. 	<ul style="list-style-type: none"> Multilingual language is not recorded on the DVD disc. (See page 34.)
<ul style="list-style-type: none"> No subtitle. 	<ul style="list-style-type: none"> Some discs have no subtitles. (See page 34.) Subtitles are cleared. Press SUBTITLE. (See page 34.)
<ul style="list-style-type: none"> Angle cannot be changed. 	<ul style="list-style-type: none"> Multi-angles are not recorded on the DVD disc. (See page 33.)
<ul style="list-style-type: none"> " " appears on the screen. 	<ul style="list-style-type: none"> The function is prohibited with the TV/DVD or the disc. (See page 30.)

Specifications

Item		Model: LC-20DV20U	
LCD panel		20" Advanced Super View & BLACK TFT LCD	
Number of dots		3,147,264 dots (1366 x 768 x 3 dots)	
TV Function	TV-standard (CCIR)	American TV Standard NTSC System	
	Receiving Channel	VHF/UHF	VHF 2-13ch, UHF 14-69ch
		CATV	1-125ch (non-scrambled channel only.)
Y/C FILTER		3D Y/C FILTER	
Brightness		450 cd/m ²	
Backlight		60,000 hours (at Backlight Standard position)	
Viewing angles		H:170° V:170°	
Audio out		2.5W x 2	
Speakers		1 ¹³ / ₁₆ x 3 ²⁹ / ₃₂ in. (4.6 x 9.9 cm), 2pcs.	
Terminals	INPUT 1	AV in, S-VIDEO in	
	INPUT 2	AV in	
	INPUT 3	COMPONENT in, Audio in	
	INPUT 4	HDMI in with HDCP (640 x 480, 480P, 720P, 1080I), Audio in	
	INPUT 5	PC Connector: 15-pin mini D-sub PC, Audio in	
	OUTPUT	Coaxial digital audio out	
	ANT/CABLE	75 Ω Unbalance, F Type x 1 for Analog (VHF/UHF/CATV)	
	HEADPHONE	Mini jack for stereo (Ø3.5 mm)	
OSD language		English/French/Spanish	
Power Requirement		AC 120 V, 60 Hz	
Power Consumption		90 W (Standby 1W)	
Weight	w/o stand	17.5 lbs./7.9 kg	
	with stand	20.3 lbs./9.2 kg	
Dimension (W x H x D)	w/o stand	21 ²⁵ / ₃₂ x 15 ⁷ / ₈ x 4 ¹⁹ / ₆₄ inch	
	with stand	21 ²⁵ / ₃₂ x 17 ⁶¹ / ₆₄ x 8 ⁶³ / ₆₄ inch	
DVD section	Signal system	NTSC	
	Applicable disc	DVD (12 cm, 8 cm), CD (12 cm, 8 cm)	
	Frequency response	DVD: 4Hz - 22KHz/CD: 4Hz - 20KHz	
	Wow and flutter	Below Measurable Level	
	Pickup	CD : Wavelength: 780 - 790 nm Maximum output power: 7 mW DVD : Wavelength: 652 - 662 nm Maximum output power: 5 mW	
Operating temperature		+32°F to +104°F (0°C to +40°C)	

- * Typical time for power output decrease of about one-half assuming continuous use in a room with normal lighting, normal brightness and temperature at 77°F/25°C
- As part of policy of continuous improvement, SHARP reserves the right to make design and specification changes for product improvement without prior notice. The performance specification figures indicated are nominal values of production units. There may be some deviations from these values in individual units.

Dimensional Drawings

- The dimensional drawings are shown on the inside back cover.

CLEARING THE PASSWORD

If you forget the password, clear the password using the following procedure.

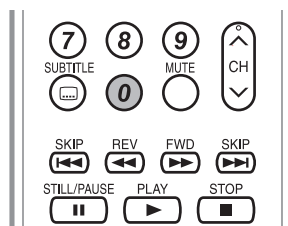
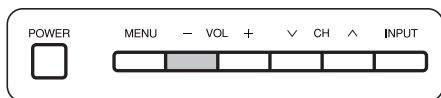

1

Press and hold both **VOL -** on the TV/DVD and press **0** on the remote control simultaneously for a few seconds until  (LOCKS) menu appears on the screen.

2

Now the old password was cleared. You can set the new password.

The password is

--	--	--	--

NOTE

- As a precautionary measure, make a note of your password above, cut it from this manual, and keep it in a safe place.

Calling for Service

For location of the nearest Sharp Authorized Service, or to obtain product literature, accessories, supplies, or customer assistance, please call 1-800-BE-SHARP.

LIMITED WARRANTY

CONSUMER LIMITED WARRANTY

SHARP ELECTRONICS CORPORATION warrants to the first consumer purchaser that this Sharp brand product (the "Product"), when shipped in its original container, will be free from defective workmanship and materials, and agrees that it will, at its option, either repair the defect or replace the defective Product or part thereof with a new or remanufactured equivalent at no charge to the purchaser for parts or labor for the period(s) set forth below.

This warranty does not apply to any appearance items of the Product nor to the additional excluded item(s) set forth below nor to any Product the exterior of which has been damaged or defaced, which has been subjected to improper voltage or other misuse, abnormal service or handling, or which has been altered or modified in design or construction.

In order to enforce the rights under this limited warranty, the purchaser should follow the steps set forth below and provide proof of purchase to the servicer.

The limited warranty described herein is in addition to whatever implied warranties may be granted to purchasers by law. ALL IMPLIED WARRANTIES INCLUDING THE WARRANTIES OF MERCHANTABILITY AND FITNESS FOR USE ARE LIMITED TO THE PERIOD(S) FROM THE DATE OF PURCHASE SET FORTH BELOW. Some states do not allow limitations on how long an implied warranty lasts, so the above limitation may not apply to you.

Neither the sales personnel of the seller nor any other person is authorized to make any warranties other than those described herein, or to extend the duration of any warranties beyond the time period described herein on behalf of Sharp.

The warranties described herein shall be the sole and exclusive warranties granted by Sharp and shall be the sole and exclusive remedy available to the purchaser. Correction of defects, in the manner and for the period of time described herein, shall constitute complete fulfillment of all liabilities and responsibilities of Sharp to the purchaser with respect to the Product, and shall constitute full satisfaction of all claims, whether based on contract, negligence, strict liability or otherwise. In no event shall Sharp be liable, or in any way responsible, for any damages or defects in the Product which were caused by repairs or attempted repairs performed by anyone other than an authorized servicer. Nor shall Sharp be liable or in any way responsible for any incidental or consequential economic or property damage. Some states do not allow the exclusion of incidental or consequential damages, so the above exclusion may not apply to you.

THIS WARRANTY GIVES YOU SPECIFIC LEGAL RIGHTS. YOU MAY ALSO HAVE OTHER RIGHTS WHICH VARY FROM STATE TO STATE.

Model Specific Section

Your Product Model Number & Description:

LC-20DV20U Combination Liquid Crystal Television And DVD/CD Player
(Be sure to have this information available when you need service for your Product.)

Warranty Period for this Product:

One (1) year parts and ninety (90) days labor from the date of purchase.

Additional Item(s) Excluded from Warranty Coverage (if any):

Non-rechargeable batteries.

Where to Obtain Service:

From a Sharp Authorized Servicer located in the United States. To find the location of the nearest Sharp Authorized Servicer, call Sharp toll free at 1-800-BE-SHARP.

What to do to Obtain Service:

Ship prepaid or carry in your Product to a Sharp Authorized Servicer. Be sure to have **Proof of Purchase** available. If you ship the Product, be sure it is insured and packaged securely. Please use two persons to carry the Product, transport it in its original packaging, and ensure that the Product is covered to avoid scratches and damage.

TO OBTAIN PRODUCT INFORMATION, CALL 1-800-BE-SHARP OR VISIT www.sharppusa.com

SHARP®

SHARP ELECTRONICS CORPORATION

Sharp Plaza, Mahwah, New Jersey 07430-2135

SHARP CORPORATION

SHARP®

LIMITED WARRANTY

Consumer Electronics Products

Congratulations on your purchase!

Sharp Electronics of Canada Ltd. (hereinafter called "Sharp") gives the following express warranty to the first consumer purchaser for this Sharp brand product, when shipped in its original container and sold or distributed in Canada by Sharp or by an Authorized Sharp Dealer:

Sharp warrants that this product is free, under normal use and maintenance, from any defects in material and workmanship. If any such defects should be found in this product within the applicable warranty period, Sharp shall, at its option, repair or replace the product as specified herein.

This warranty shall not apply to:

- (a) Any defects caused or repairs required as a result of abusive operation, negligence, accident, improper installation or inappropriate use as outlined in the owner's manual.
- (b) Any Sharp product tampered with, modified, adjusted or repaired by any party other than Sharp, Sharp's Authorized Service Centres or Sharp's Authorized Servicing Dealers.
- (c) Damage caused or repairs required as a result of the use with items not specified or approved by Sharp, including but not limited to head cleaning tapes and chemical cleaning agents.
- (d) Any replacement of accessories, glassware, consumable or peripheral items required through normal use of the product including but not limited to earphones, remote controls, AC adapters, batteries, temperature probe, stylus, trays, filters, belts, ribbons, cables and paper.
- (e) Any cosmetic damage to the surface or exterior that has been defaced or caused by normal wear and tear.
- (f) Any damage caused by external or environmental conditions, including but not limited to transmission line/power line voltage or liquid spillage.
- (g) Any product received without appropriate model, serial number and CSA/cUL markings.
- (h) Any products used for rental or commercial purposes.
- (i) Any installation, setup and/or programming charges.

Should this Sharp product fail to operate during the warranty period, warranty service may be obtained upon delivery of the Sharp product together with proof of purchase and a copy of this LIMITED WARRANTY statement to an Authorized Sharp Service Centre or an Authorized Sharp Servicing Dealer. In home warranty service may be provided at Sharp's discretion on any Sharp television with the screen size of 27" or larger and on any Sharp Over-the-Range Microwave Oven.

This warranty constitutes the entire express warranty granted by Sharp and no other dealer, service centre or their agent or employee is authorized to extend, enlarge or transfer this warranty on behalf of Sharp. To the extent the law permits, Sharp disclaims any and all liability for direct or indirect damages or losses or for any incidental, special or consequential damages or loss of profits resulting from a defect in material or workmanship relating to the product, including damages for the loss of time or use of this Sharp product or the loss of information. The purchaser will be responsible for any removal, reinstallation, transportation and insurance costs incurred. Correction of defects, in the manner and period of time described herein, constitute complete fulfillment of all obligations and responsibilities of Sharp to the purchaser with respect to the product and shall constitute full satisfaction of all claims, whether based on contract, negligence, strict liability or otherwise.

WARRANTY PERIODS:

	Parts & Labour (exceptions noted)
Audio Products	1 year
Camcorder	1 year
DVD Products	1 year
Projector	1 year (lamp 90 days)
LCD & Plasma Display TV	1 year
Microwave Oven	1 year (magnetron component-4 additional years)
Television Products	1 year (picture tube component-1 additional year)
VCR Products	1 year
Vacuum Cleaner	1 year

To obtain the name and address of the nearest Authorized Sharp Service Centre or Dealer, please contact:
SHARP ELECTRONICS OF CANADA LTD. 335 Britannia Road East, Mississauga, Ontario L4Z 1W9

For more information on this Warranty, Sharp Extended Warranty Offers, Sharp Canada Products, Accessory Sales, Dealer or Service Locations, please call (905) 568-7140
Visit our Web site: www.sharp.ca



Unit: inch/(mm)

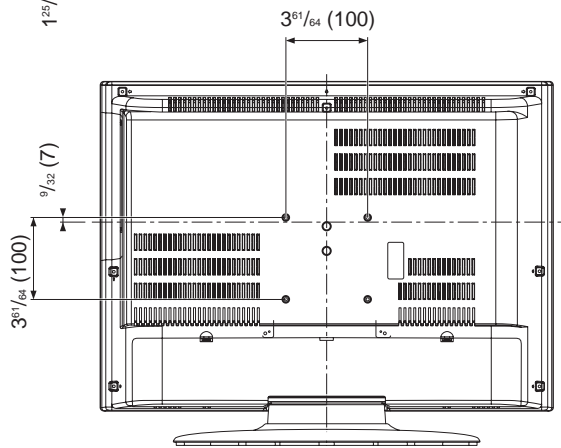
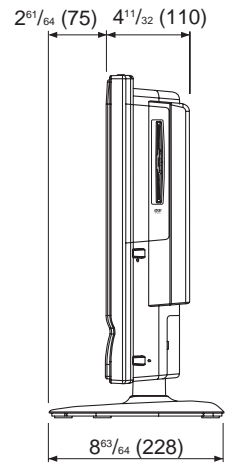
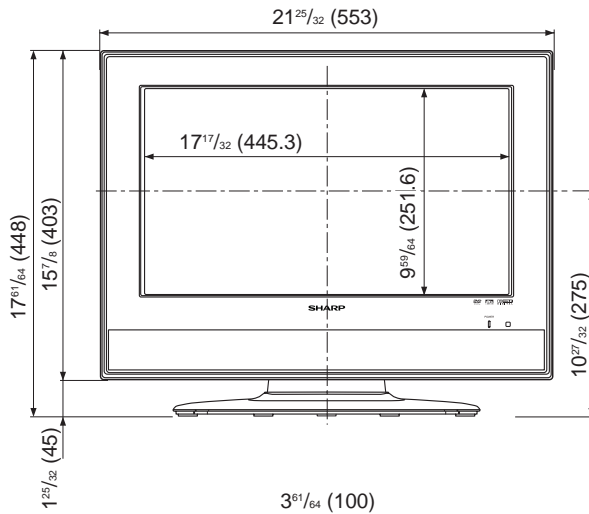
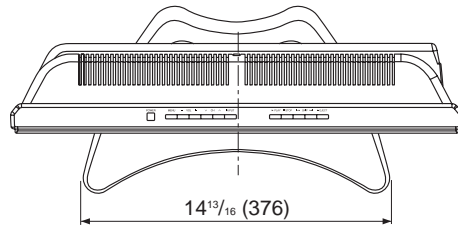

SHARP®

SHARP ELECTRONICS CORPORATION

Sharp Plaza, Mahwah, New Jersey 07430-2135

SHARP CORPORATION



J5X20431A SH 06/05

Printed in Thailand
Imprimé en Thaïlande
Impreso en Tailandia
9JDJ5X20431A
06P05-TH-NO