

SHARP®

English

ELECTRONIC CASH REGISTER
CAISSE ENREGISTREUSE
ELECTRONIQUE

MODEL
MODELE

ER-A347
ER-A347A

INSTRUCTION MANUAL
MANUEL D'INSTRUCTIONS



In U.S.A.:

WARNING

FCC Regulations state that any unauthorized changes or modifications to this equipment not expressly approved by the manufacturer could void the user's authority to operate this equipment.

Note: This equipment has been tested and found to comply with the limits for a Class A digital device, pursuant to Part 15 of the FCC Rules. These limits are designed to provide reasonable protection against harmful interference when the equipment is operated in a commercial environment.

This equipment generates, uses, and can radiate radio frequency energy and, if not installed and used in accordance with the instruction manual, may cause harmful interference to radio communications. Operation of this equipment in a residential area is likely to cause harmful interference in which case the user will be required to correct the interference at his own expense.

WARNING

Shielded interface cables must be used with this equipment to maintain compliance with EMC regulations.

AVERTISSEMENT

Les câbles d'interface blindés doivent être utilisés avec cet équipement pour maintenir la conformité aux normes EMC.

CAUTION

The AC power socket-outlet should be installed near the equipment and should be easily accessible.

ATTENTION

La prise de courant murale devra être installée à proximité de l'équipement et être facilement accessible.

FOR YOUR RECORDS

Please record below the model number and serial number for easy reference in case of loss or theft. These numbers are located on the right side of the unit. Space is provided for further pertinent data.

Model Number _____

Serial Number _____

Date of Purchase _____

Place of Purchase _____

INTRODUCTION

Thank you very much for your purchase of the SHARP Electronic Cash Register, Model ER-A347/ER-A347A. Please read this manual carefully before operating your register in order to gain full understanding of functions and features.

Please keep this manual for future reference. It will help you if you encounter any operational problems.

IMPORTANT

- Be careful when removing and replacing the printer cover, as the cutter mounted on it is sharp.
- Install the cash register in a location not subject to direct sunlight, unusual temperature changes, high humidity or splashing water.
Installation in such locations could cause damage to the cabinet and the electronic components.
- Never install the register in saline areas (e.g.: close to the sea).
Installing the register in such locations could cause component failure with the corrosion.
- Never operate the register with wet hands.
The water could seep into the interior of the register and cause component failure.
- When cleaning your register, use a dry, soft cloth. Never use solvents, such as benzene and/or thinner.
The use of such chemicals will lead to discoloration or deterioration of the cabinet.
- The register plugs into any standard wall outlet (120V AC).
Other electrical devices on the same electrical circuit could cause the register to malfunction.
- If the register malfunctions, call your local authorized dealer for service.
Do not try to repair the register yourself.
- For complete electrical disconnection, disconnect the main plug.

PRECAUTION

This register has a built-in memory protection circuit which is operated by rechargeable batteries. Please note that all batteries will, in time, dissipate their charge even if not used. Therefore to insure an adequate initial charge in the protection circuit, and to prevent any possible loss of memory upon installation, it is recommended that each unit be allowed to be recharged for a period of 24 to 48 hours prior to use. Also note that if the rechargeable batteries have been discharged completely, your cash register will be automatically initialized when you turn on the power.

In order to charge the batteries, the machine must be plugged in. This recharging precaution can prevent unnecessary initial service calls.

BATTERY DISPOSAL

This product contains Nickel Metal Hydride Battery. Must be Disposed of Properly. Contact Local Environmental Officials for Disposal Instructions.

This product utilizes tin-lead solder, and fluorescent lamp containing a small amount of mercury.
Disposal of these materials may be regulated due to environmental considerations.
For disposal or recycling information, please contact your local authorities, the Electronics Industries Alliance: www.eiae.org, the lamp recycling organization: www.lamprecycle.org or Sharp at 1-800-BE-SHARP (For U.S.A only)

CONTENTS

INTRODUCTION	1
IMPORTANT	1
PRECAUTION	1
CONTENTS	2
1 Parts and Their Functions	6
External View	6
Front view	6
Rear view	6
Printer	7
Keyboard	8
Keyboard layout	8
Function key list	8
Displays	9
Operator display	9
Customer display	10
Screen save mode	10
2 Selecting an Operating Mode	11
Operating Modes	11
Mode Selection	12
3 Prior to Making Entries	13
Preparations for Entries	13
Receipt and journal paper rolls	13
Receipt ON/OFF function	13
Clerk assignment	13
Error Warning	13
Selecting the Function from the Menu	14
HELP Function	15
The HELP menu and guidance messages	15
4 Entries	16
Item Entries	16
Single item entries	16
Repeat entries	18
Multiplication entries	19
Split-pricing entries	20
Single item cash sale (SICS)	21
PLU/UPC information inquiry (view) function	21
UPC learning function (creation and registration of unknown UPCs)	22
Display of Subtotals	23
Taxable subtotal	23
Including-tax subtotal (complete subtotal)	23
Finalization of Transaction	23
Cash or check tendering	23
Cash or check sale that does not need any tender entry	24
Charge (credit) sale	24
Mixed-tender sale (cash or check tendering + charge tendering)	24
Tax Calculation	25
Automatic tax	25
Manual tax	25
Tax delete	26
Tax status shift	26
Auxiliary Entries	27

Percent calculations (premium or discount)	27
Discount entries	28
Refund entries	28
Printing of non-add code numbers	29
Payment Treatment	29
Currency conversion.....	29
Received-on-account entries.....	30
Paid-out entries	31
No-sale (exchange)	31
Bottle return	31
TRAINING Mode.....	32
5 Correction	33
Correction of the Last Entry (Direct Void)	33
Correction of the Next-to-Last or Earlier Entries (Indirect Void).....	34
Subtotal Void.....	35
Correction after Finalizing a Transaction	35
6 Special Printing Function	36
Copy Receipt Printing	36
7 Manager Mode	37
Entering the Manager Mode	37
Override Entries.....	37
8 Reading (X) and Resetting (Z) of Sales Totals	38
How to take a X1/Z1 or X2/Z2 report	38
View report.....	38
Daily Sales Totals	40
General report	40
Department report	41
Individual group total report on department.....	41
Full group total report on department	41
Transaction report.....	41
Total in drawer report.....	41
PLU/UPC report by designated range	42
PLU/UPC report by associated department	42
Clerk reports	42
Hourly report.....	42
Periodic Report Sample.....	43
General information	43
Daily net report	43
9 Prior to Programming	44
Programming Keyboard Layout.....	44
How to Program Alphanumeric Characters	45
Mobile phone method	45
Entering character codes.....	46
10 Programming	47
Basic Instructions.....	47
Programming screen	47
Programming example	48
DEPT/PLU Programming.....	50
Department.....	51
PLU/UPC	52
PLU range	53
Functional Programming.....	54
Discount (⊖).....	55

Percent (<input type="text" value="%1"/> , %2)	56
Manual tax	56
RA	57
PO	57
Cash in drawer	57
Commission rate (Commission 1, Commission 2).....	57
Media Key Programming	58
Cash key (Cash).....	58
Check key (Check)	59
Charge key (<input type="text" value="CH1"/> , <input type="text" value="CH2"/>).....	59
Currency conversion (CONV1, CONV2)	60
Function Text Programming.....	61
Personnel Programming	63
Clerk	63
Manager	64
Mode Pass Code	64
Training Clerk	64
Terminal Programming.....	65
Date/Time Setting	65
Date/time	65
Optional Feature Selection	66
Basic System	67
Function Prohibit.....	68
Function Authority.....	69
Function Selection	70
Print Selection	71
UPC Function	72
Report Programming	73
Zero skip.....	74
Print select.....	75
Z Counter.....	76
Z1 General report	76
Journal data.....	76
Message Programming.....	77
Receipt logo.....	77
Device Configuration Programming.....	78
Keyboard	78
Display	79
Printer	79
EFT	79
RS port (COM1, COM2).....	80
On-line	80
Scanner	81
SRM (Sales Recording Module).....	81
Tax Programming.....	82
Tax system.....	83
Tax 1 through 4	84
Doughnut exempt	86
Automatic Sequencing Key Programming	87
Key Sequence	87
Reading of Stored Programs	88
Program reading sequence	88
Sample printouts.....	89

EFT Test Function.....	96
SD CARD Mode.....	97
Inserting and removing an SD memory card.....	97
SD card formatting.....	97
Folder creating.....	97
Folder name selecting.....	98
Data saving.....	98
Data loading.....	99
11 Universal Product Code (UPC) or European Article Number (EAN).....	100
UPC or EAN code.....	100
Add-on code.....	101
12 Operator Maintenance.....	102
In Case of Power Failure.....	102
In Case of Printer Error.....	102
Cautions in Handling the Printer and Recording Paper.....	102
Cautions in handling the printer.....	102
Cautions in handling the recording paper (thermal paper).....	102
Replacing the Paper Roll.....	103
Recording paper specifications.....	103
Installing Paper Rolls.....	103
Replacing the paper roll.....	106
Removing a Paper Jam.....	106
Cleaning the Printer (Printer Head/Sensor/Roller).....	107
Drawer and Drawer Lock Key.....	108
Removing the Till.....	108
Opening the Drawer by Hand.....	108
Drawer Lock Key.....	108
Before Calling for Service.....	109
13 Specifications.....	110

1

Parts and Their Functions

External View

■ Front view

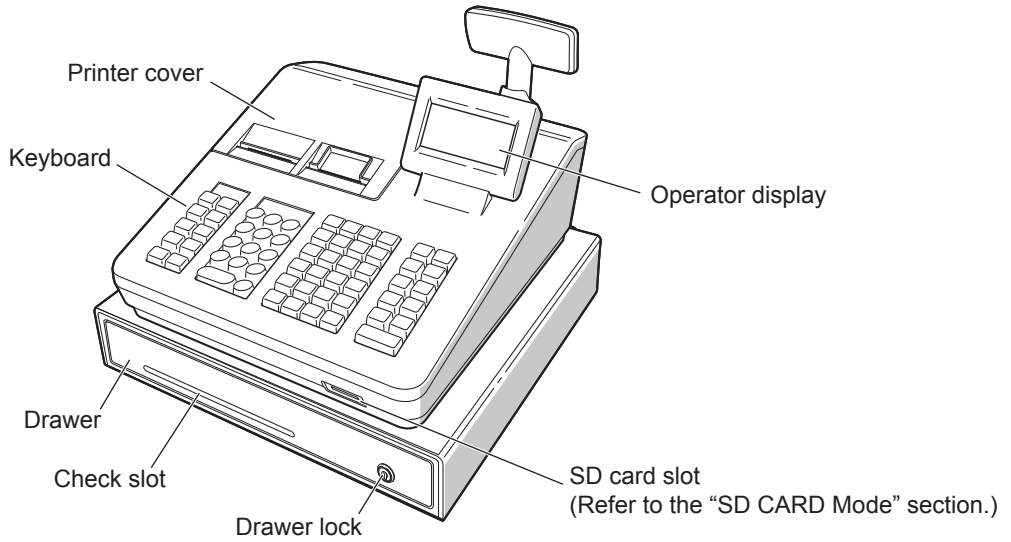

■ Rear view

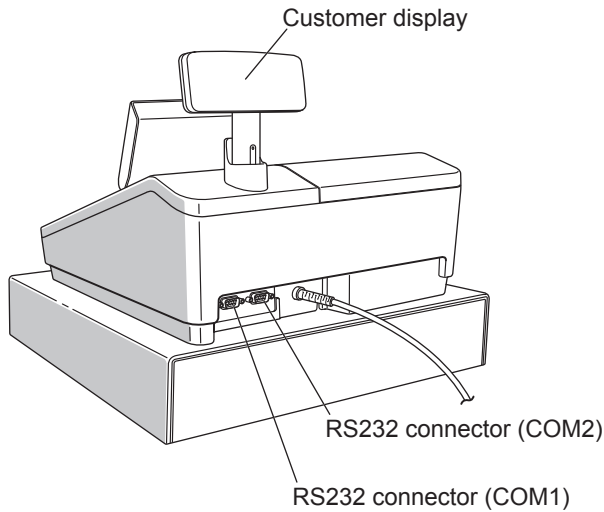

CAUTION: Before connecting the peripheral devices (EFT, scanner, etc.), make sure to unplug the AC power cord of the register.

Printer

The printer is a thermal printer, and therefore it does not require any type of ink ribbon or cartridge. The average life of the printer is approximately 6 million lines.

When removing the printer cover, lift up from the rear.

When installing the printer cover, hook it on the pawls at the front of the cabinet and shut it.

CAUTION: The paper cutter is mounted on the printer cover. Be careful not to cut yourself.

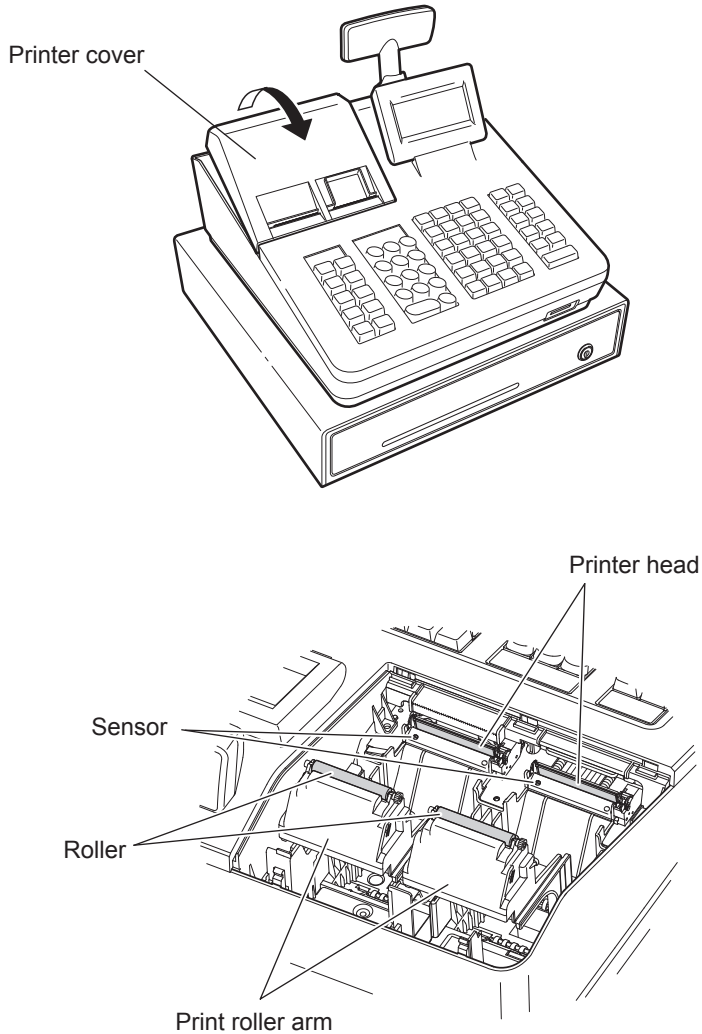

NOTE

Do not attempt to remove the paper with the print roller arm in the hold position. This may result in damage to the printer and printer head.

Keyboard

Keyboard layout

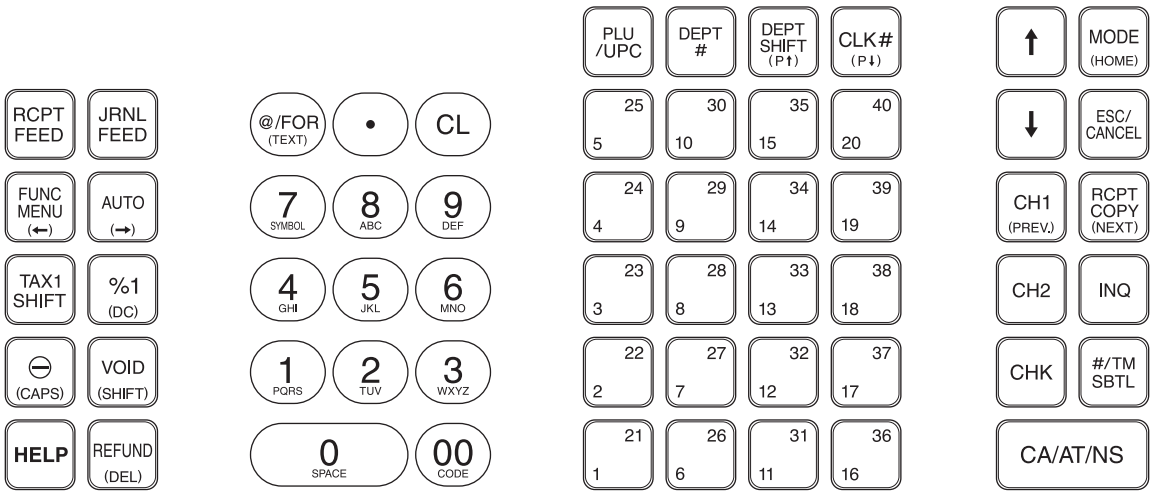

Function key list

	Receipt paper feed key		PLU/sub-department/UPC key
	Journal paper feed key		Department code entry key
	Function menu key		Department shift key
	Auto key		Clerk code entry key
	Tax1 shift key		Department 1-40 key
	Percent 1 key		Cursor (up/down arrow) key
	Discount key		Mode key
	Void key		Escape/Cancel key
	Help key		Charge 1 key
	Refund key		Receipt print key
	Multiplication key		Charge 2 key
	Decimal point key		PLU/UPC inquiry key
	Clear key		Check key
	Numeric key		Non-add code/Time display/Subtotal key
			Cash/Amount tender/No sale key

Displays

■ Operator display

• Screen example 1 (REG mode)

1@125.20 125.20
PLU00001
***TOTAL 132.71
150
REG R 01

Mode name
Status information Clerk code

Sales information area:
When a transaction information occupies more than 2 lines, you can scroll to the direction by using the keys. Sales information you have just entered such as items and prices will appear between 1st line and 2nd line. Total is always appear at 3rd line.

Numeric Entry Area:
Status area:

- Receipt ON/OFF status indicator (R) : Appears when the receipt ON-OFF function signs OFF.
- Sentinel mark (X) : Appears when the cash in drawer exceeds a programmed sentinel amount. The sentinel check is performed for the total cash in drawer.

• Screen example 2 (PROGRAM mode)

00001
PRICE 125.20
PLU00001
TYPE PRESET
DEPT.CODE 01
COMMISSION No. 0
PGM 01

Mode name Clerk code

Programming area: Programmable items are listed.
Status area:

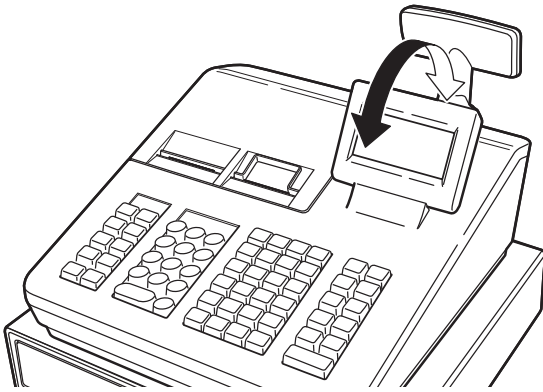

The display can be tilted back and forth to the best operational viewing angle.

NOTE

Do not try to force the display beyond its full position.

■ **Customer display**



■ **Screen save mode**

When you want to save the electric power or save the display's life, use the screen save function. This function can turn off the display and the LCD backlight when any clerk does not operate the register for an extended period of time. You can program the time for which your register should keep the normal status (in which the backlight is "ON") before it goes into the screen save mode.

This register will enter the screen save mode two minutes later by default.

To go back to the normal mode, press any key.

The backlight in display is a consumable part.

When the LCD display may no longer be adjusted and become darker, you should replace the LCD unit.

Consult your authorized SHARP dealer for further details.

2

Selecting an Operating Mode

When you turn the register on and press the **[MODE]** key, the mode selection window will appear on the display, listing available operating modes as shown below.

Mode selection window

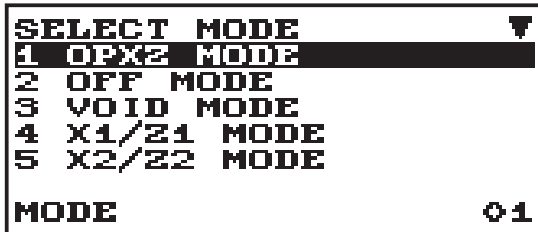

Operating Modes

You can select any mode other than REG from the list in the mode selection window. Your register supports the following operating modes:

REG mode	This mode allows you to enter various sales information. The mode selection window does not list this mode. To select this mode from the mode selection window, press the [ESC/CANCEL] key.
OPXZ mode	This mode allows clerks to take X or Z reports on their sales information.
OFF mode	This mode locks all operations of the register. When you select this mode, the window will disappear. Pressing any key turns the register ON.
VOID mode	This mode allows correction after finalizing a transaction.
X1/Z1 mode	This mode is used to take various daily total reports (X1/Z1 reports).
X2/Z2 mode	This mode is used to take various weekly or monthly reports (X2/Z2 reports).
PROGRAM mode	This mode is used to program various items.
SD CARD mode	This mode allows you to save and load the data of your register to and from an SD card.

Mode Selection

Procedure

Press the **MODE** key. The following mode screen is displayed.

```
SELECT MODE
1 OPX2 MODE
2 OFF MODE
3 VOID MODE
4 X1/Z1 MODE
5 X2/Z2 MODE
MODE 01
```

Use one of the following ways:

- Move the cursor to the desired option by using the **↑** or **↓** key, and press the **CA/AT/NS** key.
- Enter the desired option number by using a numeric key and press the **CA/AT/NS** key.

NOTE When you want to enter the REG mode, simply press the **ESC/CANCEL** key.

3

Prior to Making Entries

Preparations for Entries

■ Receipt and journal paper rolls

If the paper roll (receipt or journal) is not set in the register or it is getting low, install a new one according to section “Replacing the Paper Roll” under “Operator Maintenance.”

■ Receipt ON/OFF function

You can disable receipt printing in the REG mode to save paper using the receipt function.

Press the **HELP** key. Select “2 RECEIPT SW” and press the **CA/AT/NS** key. Select “OFF” to disable receipt printing and press the **CA/AT/NS** key. When the function is in the OFF status, the receipt off indicator “R” is highlighted.

NOTE Your register will print reports regardless of the receipt state. This means that the receipt roll must be installed even when the receipt state is “OFF”.

■ Clerk assignment

Prior to any item entries, a clerk must enter his/her clerk codes into the register.

To sign on:

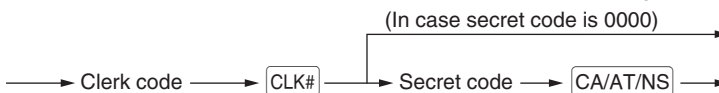

To sign off: → **CLK#** →

Error Warning

In the following examples, your register will go into an error state accompanied with a warning beep and the error message on the display. Clear the error state by pressing the **CL** key and then take the proper action to remedy the problem.

- When you exceed a 32-digit number (entry limit overflow):
Cancel the entry and reenter a correct number.
- When you make an error in key operation:
Clear the error and try the entry again.
- When you make an entry beyond a programmed amount entry limit:
Check to see if the entered amount is correct. If it is correct, it can be rung up in the MGR mode.
Contact your manager.
- When an including-tax subtotal exceeds eight digits:
Clear the error message by pressing the **CL** key and then press a media key to finalize the transaction.

Error escape function

To quit a transaction due to an error or an unforeseen event, use the error escape function as shown below:

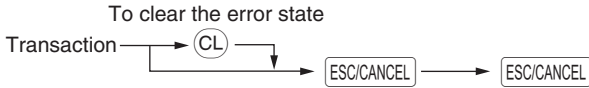

The transaction is voided (treated as a subtotal void) and the receipt is issued by this function. If you have already entered a tendered amount, the operation is finalized as a cash sale.

Selecting the Function from the Menu

Your register allows you to select functions from the menu.

The menu can be opened by pressing the **FUNC MENU** key.

• FUNCTION MENU

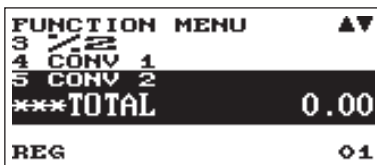
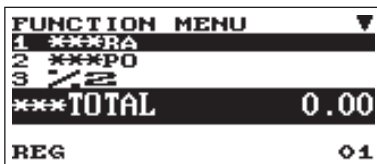

Procedure

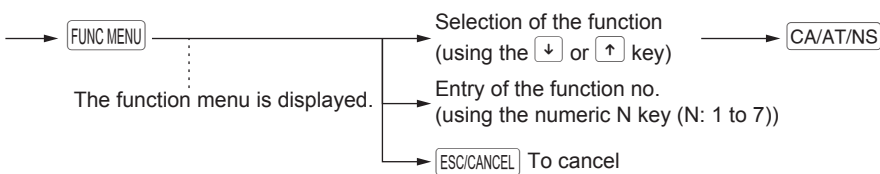

HELP Function

The HELP function allows you to print guidance messages for basic operation procedure of the register.

■ The HELP menu and guidance messages

Press the **HELP** key to display the operation menu. This menu provides a list of the procedures for which you can perform it or print the guidance messages.

Procedure

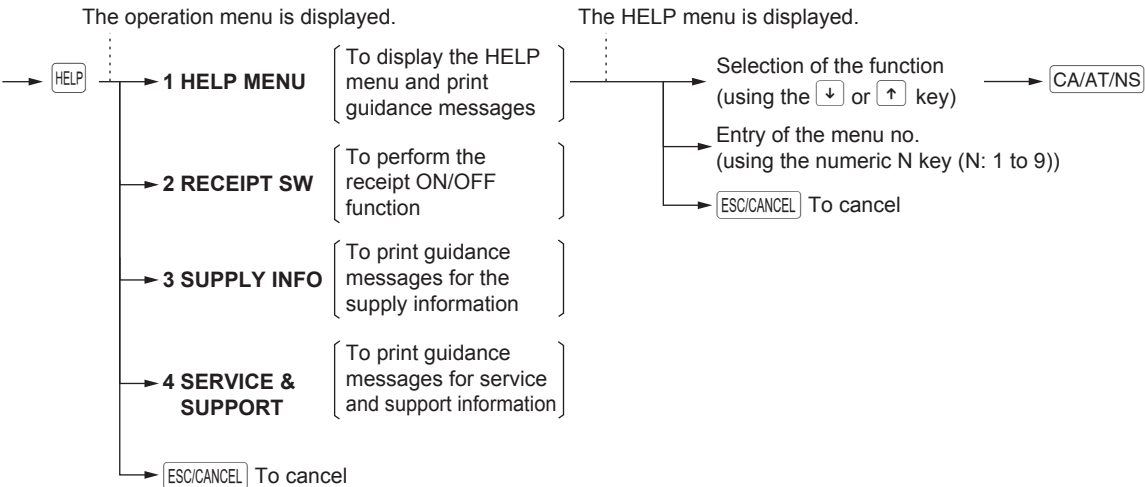

Example

Key operation	Print
HELP 1	<pre> 2 TAX RATE SETUP MODE SELECTION: PROGRAM MODE SELECT "2 SETTING". SELECT "12 TAX". EX) TAX1 RATE=6.25% MIN. AMT=\$3.00 SELECT "2 TAX1". SELECT "2 %TAX". 6.25(↓) 300 [CA/AT/NS] </pre>
2	

- HELP menu list
- 1 DATE/TIME
 - 2 TAX
 - 3 DEPARTMENT
 - 4 LOGO
 - 5 SALES REPORT
 - 6 RECEIPT
 - 7 CLERK
 - 8 SD CARD
 - 9 PC S/W INSTALL

4

Entries

Item Entries

■ Single item entries

Department entries

For a merchandise classification, the register provides a maximum of 99 departments. To the departments, group attributes such as taxable status are applied to items when they are entered.

NOTE When those departments for which the unit price has been programmed as zero (0) are entered, only the sales quantity is added.

• When using the department keys (for department 1 to 40)

For department 1 to 20, enter a unit price and press a department key. If you use a programmed unit price, press a department key only.

For department 21 to 40, enter a unit price, press the **DEPT SHIFT** key and press a department key. If you use a programmed unit price, press the **DEPT SHIFT** key and press a department key.

Procedure

When using a programmed unit price

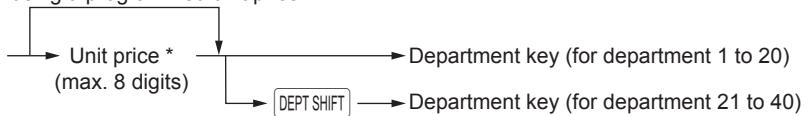

* Less than the programmed upper limit amounts

• When using the department code entry key

Enter a department (dept.) code and press the **DEPT#** key, then enter a unit price and press the **CA/AT/NS** key.

If the department code is programmed to preset price entry ("PRESET") type and a unit price is preset, the register will finish its registration operation.

Procedure

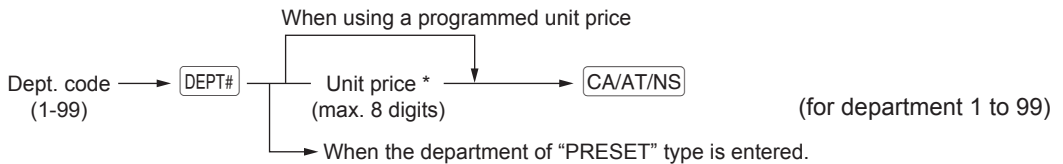

* Less than the programmed upper limit amounts

NOTE You can directly enter the code No. of the department using the numeric key. For the code No. exceeding the figure on the numerical key board (41 and above), use this function.

Example

Key operation	Print
1200 <input type="text" value="6"/>	1@ 12.00 T,\$12.00
<input type="text" value="5"/>	DEPT. 06
3 <input type="text" value="DEPT#"/>	1@ 7.10 T,\$7.10
520	DEPT. 05
<input type="text" value="CA/AT/NS"/>	1@ 5.20 T,\$5.20
<input type="text" value="4"/>	DEPT. 03
<input type="text" value="CA/AT/NS"/>	1@ 6.80 T,\$6.80
	DEPT. 04
	MDSE ST \$31.10
	TAX1 \$1.86
	ITEMS 4Q
	CASH \$32.96

PLU/sub-department (open price) entries

For another merchandise classification, the register provides a maximum of 7000* PLUs/sub-departments. PLUs are used to call up preset prices by a code entry. Sub-departments are used to classify merchandise into smaller groups under the departments. Every PLU and sub-department has a free code from 1 to 99999, and should belong to a department to obtain attributes of that department.

The register is pre-programmed to "PRESET" for entry type and zero (0) for unit price. To use PLU entries, their preset unit prices should be previously programmed. (Refer to the section "PLU/UPC" of "DEPT/PLU Programming")

To use sub-department entries, change to "OPEN" or "OPEN&PRESET" entry type for each PLU code.

* A total of 7000 codes, including UPC codes, can be programmed.

Enter a PLU code and press the key. If you not use a programmed unit price, you need to enter a unit price after pressing the key.

Procedure

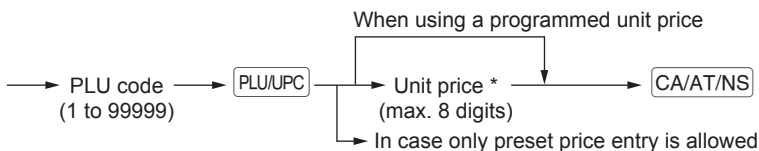

NOTE When those PLUs for which the unit price has been programmed as zero (0) are entered, only the sales quantity is added.

Example

Key operation	Print
PLU entry → 2 <input type="text" value="PLU/UPC"/>	1@ 5.10 T,\$5.10
Sub-department entry → {	PLU0002
	1@ 12.00 T,\$12.00
	PLU00016
	MDSE ST \$17.10
<input type="text" value="CA/AT/NS"/>	TAX1 \$1.02
<input type="text" value="CA/AT/NS"/>	ITEMS 2Q
	CASH \$18.12

UPC entries

You can enter the barcodes using scanner or keyboard. The barcodes which can be entered are UPC-A, UPC-E, EAN-8, EAN-13 and ITF-14.

For details of UPC code, please refer to "11 Universal Product Code (UPC) or European Article Number (EAN)".

Procedure

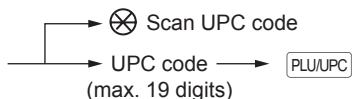

* After an UPC entry, you may be requested to enter a unit price with the display "UNDEFINED CODE" and beep sound. In this case, enter the unit price and press the **CA/AT/NS** key, enter the department code and press the **CA/AT/NS** key (UPC learning function).

Example

Key operation

5012345678900 **PLU/UPC**
CA/AT/NS

Print

1@ 3.10	1\$3.10
5012345678900#	
Item-A	
MDSE ST	\$3.10
TAX1	\$0.18
ITEMS 1Q	
CASH	\$3.28

Repeat entries

You can use this function for entering a sale of two or more the same items.

You can simply press the department key, **DEPT#**, or **PLU/UPC** key to repeat entry.

Example

Key operation

Repeated department entry (direct)	{	200 2 ²²
		2 ²²
		2 ²²
Repeated department entry (indirect)	{	4
		DEPT#
		680
		CA/AT/NS
Repeated PLU entry	{	10 PLU/UPC
		PLU/UPC
		PLU/UPC
Repeated UPC entry	{	5012345678900 PLU/UPC
		PLU/UPC
		PLU/UPC
Repeated subdepartment entry	{	60 PLU/UPC
		500 CA/AT/NS
		PLU/UPC
		CA/AT/NS

Print

3@ 2.00	1\$6.00
DEPT.02	
2@ 6.80	1\$13.60
DEPT.04	
3@ 8.20	1\$24.60
PLU00010	
2@ 3.10	1\$6.20
5012345678900#	
Item-A	
2@ 5.00	1\$10.00
PLU00060	
MDSE ST	\$60.40
TAX1	\$3.63
ITEMS 12Q	
CASH	\$64.03

■ Multiplication entries

Use this feature when you need to enter two or more the same items.

This feature helps you when you sell a large quantity of items or need to enter quantities that contain decimals.

Procedure

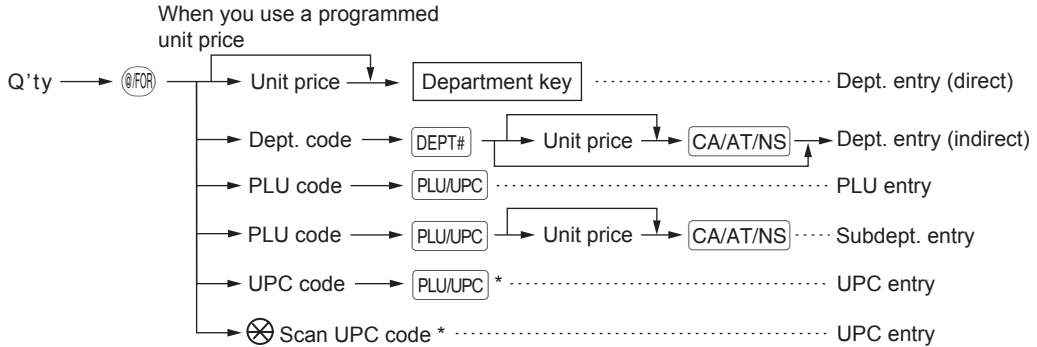

* After an UPC entry, you may be requested to enter a unit price with the display “UNDEFINED CODE” and beep sound. In this case, enter the unit price and press the **CA/AT/NS** key, enter the department code and press the **CA/AT/NS** key (UPC learning function).

- Q'ty: Up to four-digit integer + three-digit decimal
- Unit price: Less than a programmed upper limit
- Q'ty x unit price: Up to eight digits

Example

Key operation	Print
7 • 5 @/FOR	7.500@ 1.65 T,\$12.38
165 2 ²²	DEPT.02
2 @/FOR	2@ 2.50 T,\$5.00
5 DEPT#	DEPT.05
250	15@ 3.00 T,\$45.00
CA/AT/NS	PLU00008
15 @/FOR	8@ 3.10 T,\$24.80
8 PLU/UPC	5012345678900#
8 @/FOR	Item-A
5012345678900 PLU/UPC	3@ 1.00 T,\$3.00
3 @/FOR	PLU00060
60 PLU/UPC	MDSE ST \$90.18
100	TAX1 \$5.41
CA/AT/NS	ITEMS 29Q
CA/AT/NS	CASH \$95.59

■ Split-pricing entries

You will use this function when your customer wants to purchase more or less than the base quantity of a loose item.

Procedure

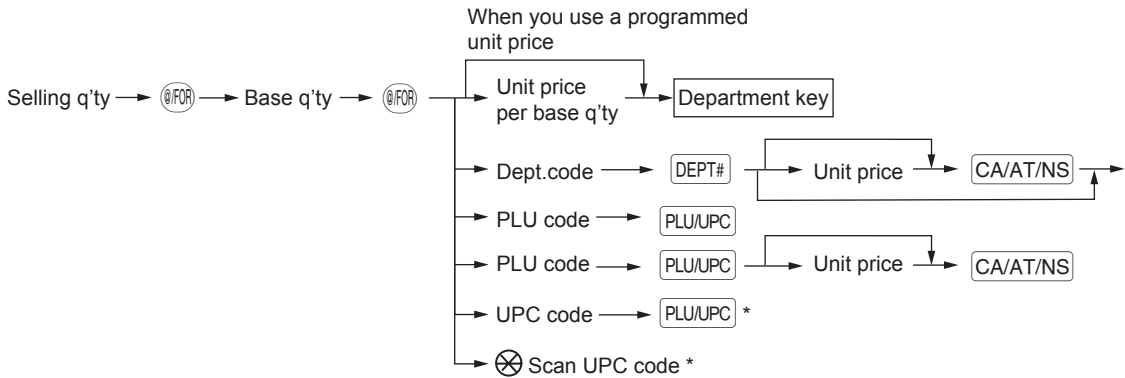

* After an UPC entry, you may be requested to enter a unit price with the display “UNDEFINED CODE” and beep sound. In this case, enter the unit price and press the **CA/AT/NS** key, enter the department code and press the **CA/AT/NS** key (UPC learning function).

- Selling quantity: Up to four-digit integer + three-digit decimal
- Base quantity: Up to two digits (integer)

Example

Key operation	Print
7 @/FOR 10 @/FOR	7@ 10/ 6.00 1\$4.20
600 2	DEPT.02
8 @/FOR 5 @/FOR	8@ 5/ 1.50 1\$2.40
35 PLU/UPC	PLU00035
5 @/FOR 6 @/FOR	5@ 6/ 3.60 1\$3.00
5045678912304 PLU/UPC	5045678912304#
CA/AT/NS	Item-C
	MDSE ST \$9.60
	TAX1 \$0.58
	ITEMS 3Q
	CASH \$10.18

■ Single item cash sale (SICS)

- This function is useful when a sale is for only one item and is for cash; such as a pack of cigarettes. This function is applicable only to those departments that have been set for SICS or to their associated PLUs, subdepartments or UPCs.
- The transaction is finalized and the drawer opens as soon as you press the department key, **DEPT#** key or **PLU/UPC** key.

Example

Key operation	Print												
For finishing the transaction → 250 → 3	<table border="1"> <tr> <td>1@ 2.50</td> <td>1\$2.50</td> </tr> <tr> <td>DEPT.03</td> <td></td> </tr> <tr> <td>MDSE ST</td> <td>\$2.50</td> </tr> <tr> <td>TAX1</td> <td>\$0.15</td> </tr> <tr> <td>ITEMS 1Q</td> <td></td> </tr> <tr> <td>CASH</td> <td>\$2.65</td> </tr> </table>	1@ 2.50	1\$2.50	DEPT.03		MDSE ST	\$2.50	TAX1	\$0.15	ITEMS 1Q		CASH	\$2.65
1@ 2.50	1\$2.50												
DEPT.03													
MDSE ST	\$2.50												
TAX1	\$0.15												
ITEMS 1Q													
CASH	\$2.65												

NOTE If an entry to a department, PLU/subdepartment or UPC set for SICS follows the ones to departments, PLUs/subdepartments or UPCs not set for SICS, it does not finalize and results in a normal sale.

■ PLU/UPC information inquiry (view) function

You can use this function when you want to know the unit price of the PLU/UPC item during transaction in the REG/MGR mode.

To use price inquiry function, follow the procedure below:

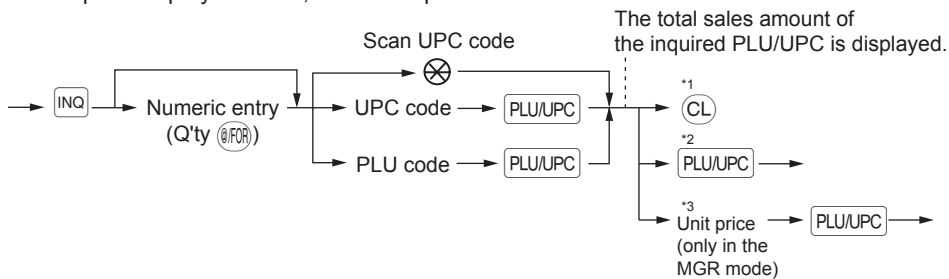

*1: Press the **CL** key to cancel the inquiring (view) mode.

*2: Press the **PLU/UPC** key when you want to register the unit price of the PLU/UPC displayed.

*3: You can change the unit price temporarily in the MGR mode. The unit price which is programmed in PROGRAM mode is not changed (This is considered a price override entry).

Example

Key operation	Display										
4901305920795 INQ PLU/UPC	<table border="1"> <tr> <td>1@1.20</td> <td>1.20</td> </tr> <tr> <td>Notebook</td> <td></td> </tr> <tr> <td>***TOTAL</td> <td>0.00</td> </tr> <tr> <td>PRICE INQ.</td> <td></td> </tr> <tr> <td>REG</td> <td>01</td> </tr> </table>	1@1.20	1.20	Notebook		***TOTAL	0.00	PRICE INQ.		REG	01
1@1.20	1.20										
Notebook											
***TOTAL	0.00										
PRICE INQ.											
REG	01										

NOTE For the repeat entry, press the **PLU/UPC** key when having pressed the **PLU/UPC** key.

■ UPC learning function (creation and registration of unknown UPCs)

When you enter or scan an undefined UPC code, you are required to enter its unit price and the associated department. The code, associated department and unit price entered are stored in the UPC file and used for future UPC sales entries.

NOTE

- When there is no capacity remained in the file, the data is not stored in the file.
- For the text for the UPC code, the text of its associated department is applied.
- You can use the UPC learning function in the training mode.

Procedure

"UNDEFINED CODE" is displayed with beep sounds and price input window is displayed.

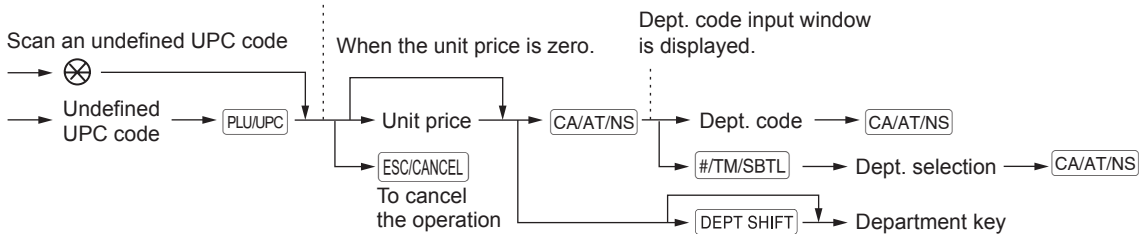

NOTE

For the repeat entry, use the **PLU/UPC** key.

Example

	Key operation	Print
"UNDEFINED CODE" is displayed.	5099887654302 PLU/UPC	1@ 7.50 1: \$7.50
	750 CA/AT/NS	5099887654302#
	5 CA/AT/NS	DEPT.05
	CA/AT/NS	MDSE ST \$7.50
		TAX1 \$0.45
		ITEMS 1Q
		CASH \$7.95

Display of Subtotals

The register provides the following types of subtotals.

■ Taxable subtotal

Taxable 1 subtotal:

Press the **TAX1** **SHIFT** and **#/TM/SBTL** keys in this order at any point during a transaction.

The sale subtotal of taxable 1 items will appear in the display with the function text "TAX1 ST".

■ Including-tax subtotal (complete subtotal)

Press the **#/TM/SBTL** key at any point during a transaction. The sale subtotal including tax will appear in the display with the function text "SUBTOTAL".

Finalization of Transaction

■ Cash or check tendering

Press the **#/TM/SBTL** key to get an including-tax subtotal, enter the amount tendered by your customer, then press the **CA/AT/NS** key if it is a cash tender or press the **CHK** key if it is a check tender. When the amount tendered is greater than the amount of the sale, your register will show the change due amount and the symbol "CHANGE." Otherwise your register will show the symbol "DUE" and a deficit. Make a correct tender entry.

Example

Cash tendering

Key operation	Print
} #/TM/SBTL 1000 CA/AT/NS	ITEMS 2Q ***TOTAL \$3.55 CASH \$10.00 CHANGE \$6.45

Check tendering

Key operation	Print
} #/TM/SBTL 1000 CHK	ITEMS 2Q ***TOTAL \$3.55 CHECK \$10.00 CHANGE \$6.45

■ Cash or check sale that does not need any tender entry

Enter items and press the **CA/AT/NS** key if it is a cash sale or press the **CHK** key if it is a check sale. Your register will display the total sales amount.

Example	Key operation	Print																				
	6 PLU/UPC 10 PLU/UPC CA/AT/NS	<table border="1"> <tr><td>1@ 3.50</td><td>T,\$3.50</td></tr> <tr><td>PLU00006</td><td></td></tr> <tr><td>1@ 8.20</td><td>T,\$8.20</td></tr> <tr><td>PLU00010</td><td></td></tr> <tr><td>MDSE ST</td><td>\$11.70</td></tr> <tr><td>TAX1</td><td>\$0.70</td></tr> <tr><td colspan="2">ITEMS 2Q</td></tr> <tr><td>CASH</td><td>\$12.40</td></tr> </table> <p>In the case of check sale</p> <table border="1"> <tr><td>ITEMS 2Q</td><td></td></tr> <tr><td>CHECK</td><td>\$12.40</td></tr> </table>	1@ 3.50	T,\$3.50	PLU00006		1@ 8.20	T,\$8.20	PLU00010		MDSE ST	\$11.70	TAX1	\$0.70	ITEMS 2Q		CASH	\$12.40	ITEMS 2Q		CHECK	\$12.40
1@ 3.50	T,\$3.50																					
PLU00006																						
1@ 8.20	T,\$8.20																					
PLU00010																						
MDSE ST	\$11.70																					
TAX1	\$0.70																					
ITEMS 2Q																						
CASH	\$12.40																					
ITEMS 2Q																						
CHECK	\$12.40																					

■ Charge (credit) sale

Enter items and press the **CH1** or **CH2** key.

Example	Key operation	Print																
	6 PLU/UPC 7 PLU/UPC #/TM/SBTL CH1	<table border="1"> <tr><td>1@ 3.50</td><td>T,\$3.50</td></tr> <tr><td>PLU00006</td><td></td></tr> <tr><td>1@ 2.10</td><td>T,\$2.10</td></tr> <tr><td>PLU00007</td><td></td></tr> <tr><td>MDSE ST</td><td>\$5.60</td></tr> <tr><td>TAX1</td><td>\$0.34</td></tr> <tr><td colspan="2">ITEMS 2Q</td></tr> <tr><td>CHARGE</td><td>\$5.94</td></tr> </table>	1@ 3.50	T,\$3.50	PLU00006		1@ 2.10	T,\$2.10	PLU00007		MDSE ST	\$5.60	TAX1	\$0.34	ITEMS 2Q		CHARGE	\$5.94
1@ 3.50	T,\$3.50																	
PLU00006																		
1@ 2.10	T,\$2.10																	
PLU00007																		
MDSE ST	\$5.60																	
TAX1	\$0.34																	
ITEMS 2Q																		
CHARGE	\$5.94																	

NOTE Amount tendering operations (i.e. change calculations) can be achieved by the **CH1** or **CH2** key when the "Media Key Programming" allows them.

■ Mixed-tender sale (cash or check tendering + charge tendering)

Example	Key operation	Print								
	} #/TM/SBTL 950 CA/AT/NS CH1	<table border="1"> <tr><td>ITEMS 2Q</td><td></td></tr> <tr><td>***TOTAL</td><td>\$12.40</td></tr> <tr><td>CASH</td><td>\$9.50</td></tr> <tr><td>CHARGE</td><td>\$2.90</td></tr> </table>	ITEMS 2Q		***TOTAL	\$12.40	CASH	\$9.50	CHARGE	\$2.90
ITEMS 2Q										
***TOTAL	\$12.40									
CASH	\$9.50									
CHARGE	\$2.90									

NOTE Press the **CHK** key in place of the **CA/AT/NS** key when your customer makes payment by checks.

Tax Calculation

Automatic tax

When the register is programmed with a tax rate (or tax table) and the tax status of an individual department is set for taxable, it computes the automatic tax on any item that is entered directly into the department or indirectly via a related PLU.

Example: Selling five \$6.70 items (dept. 1, taxable 1) and one \$7.15 item (PLU 85, taxable 2) for cash

Key operation	Print
5 @FOR 670 1 ²¹	5@ 6.70 T\$33.50
85 PLU/UPC	DEPT. 01
CA/AT/NS	1@ 7.15 T\$7.15
	PLU00085
	MDSE ST \$40.65
	TAX1 \$2.01
	TAX2 \$0.57
	ITEMS 6Q
	CASH \$43.23

Manual tax

The register allows you to enter tax manually after it finalizes an item entry.

Procedure

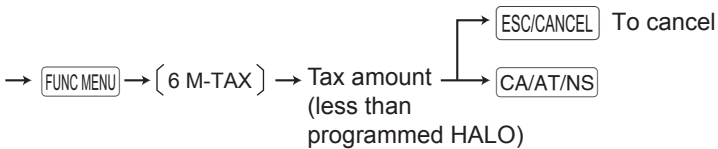

Example: Selling an \$8.00 item (dept. 12) for cash with 50 cents as tax

Key operation	Print
800 12 ³²	1@ 8.00 \$8.00
[FUNC.MENU] 6	DEPT. 12
50 CA/AT/NS	M-TAX \$0.50
CA/AT/NS	ITEMS 1Q
	CASH \$8.50

■ Tax delete

The automatic tax (tax 1, tax 2, or all tax (tax1 – tax 4)) can be deleted.

Procedure

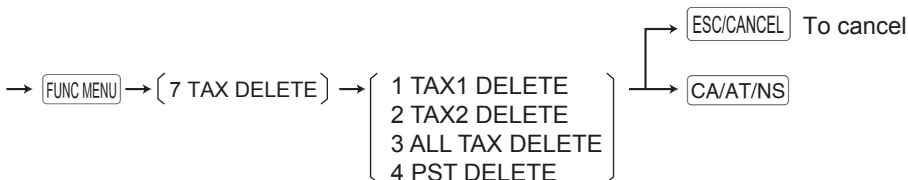

NOTE The "4 PST DELETE" function becomes effective only when the Canadian tax is selected.

Example: Selling a \$7.25 item (dept. 1, taxable 1) and another \$5.15 item (dept. 11, taxable 2) for cash and entering the sale as non-taxable

Key operation	Print																
725 [1] 21	<table border="1"> <tr><td>1@ 7.25</td><td>1 \$7.25</td></tr> <tr><td>DEPT. 01</td><td></td></tr> <tr><td>1@ 5.15</td><td>1 \$5.15</td></tr> <tr><td>DEPT. 11</td><td></td></tr> <tr><td>TAX1 ST</td><td>\$0.00</td></tr> <tr><td>TAX2 ST</td><td>\$0.00</td></tr> <tr><td>ITEMS 2Q</td><td></td></tr> <tr><td>CASH</td><td>\$12.40</td></tr> </table>	1@ 7.25	1 \$7.25	DEPT. 01		1@ 5.15	1 \$5.15	DEPT. 11		TAX1 ST	\$0.00	TAX2 ST	\$0.00	ITEMS 2Q		CASH	\$12.40
1@ 7.25		1 \$7.25															
DEPT. 01																	
1@ 5.15		1 \$5.15															
DEPT. 11																	
TAX1 ST		\$0.00															
TAX2 ST		\$0.00															
ITEMS 2Q																	
CASH		\$12.40															
515 [11] 31																	
[FUNC MENU] 7																	
Select "TAX1 DELETE"																	
[CA/AT/NS]																	
[FUNC MENU] 7																	
Select "TAX2 DELETE"																	
[CA/AT/NS]																	
[CA/AT/NS]																	

■ Tax status shift

The register allows you to shift the programmed tax status of each department or PLU/UPC by pressing the [TAX1 SHIFT] key before those keys. After each entry is completed, the programmed tax status of each key is resumed.

Example: Selling the following items for cash with their programmed tax status reversed

- One \$13.45 item of dept. 16 (non-taxable) as a taxable 1 item
- One \$7.00 item of PLU 25 (non-taxable) as a taxable 1 item
- One \$4.00 item of dept. 11 (taxable 1) as a non-taxable item

Key operation	Print																				
1345 [TAX1 SHIFT] [16] 36	<table border="1"> <tr><td>1@ 13.45</td><td>1 \$13.45</td></tr> <tr><td>DEPT. 16</td><td></td></tr> <tr><td>1@ 7.00</td><td>1 \$7.00</td></tr> <tr><td>PLU00025</td><td></td></tr> <tr><td>1@ 4.00</td><td>\$4.00</td></tr> <tr><td>DEPT. 11</td><td></td></tr> <tr><td>MDSE ST</td><td>\$24.45</td></tr> <tr><td>TAX1</td><td>\$1.23</td></tr> <tr><td>ITEMS 3Q</td><td></td></tr> <tr><td>CASH</td><td>\$25.68</td></tr> </table>	1@ 13.45	1 \$13.45	DEPT. 16		1@ 7.00	1 \$7.00	PLU00025		1@ 4.00	\$4.00	DEPT. 11		MDSE ST	\$24.45	TAX1	\$1.23	ITEMS 3Q		CASH	\$25.68
1@ 13.45		1 \$13.45																			
DEPT. 16																					
1@ 7.00		1 \$7.00																			
PLU00025																					
1@ 4.00		\$4.00																			
DEPT. 11																					
MDSE ST		\$24.45																			
TAX1		\$1.23																			
ITEMS 3Q																					
CASH	\$25.68																				
25 [TAX1 SHIFT] [PLU/UPC]																					
400 [TAX1 SHIFT] [11] 31																					
[CA/AT/NS]																					

Auxiliary Entries

■ Percent calculations (premium or discount)

- Your register provides percent calculations for a subtotal or each item entry depending on the programming.
- Percentage: 0.01 to 100.00%

Percent calculation for a subtotal

Example

Key operation		Print	
(When a discount of 10% is programmed for the %1 key.)	3 <input type="button" value="PLU/UPC"/> 2 <input type="button" value="@FOR"/> 5 <input type="button" value="PLU/UPC"/> <input type="button" value="#/TM/SBTL"/> <input type="button" value="%1"/> <input type="button" value="CA/AT/NS"/>	1@ 1.10 PLU00003 2@ 2.25 PLU00005 MDSE ST %1 MDSE ST TAX1 ITEMS 3Q CASH	1\$1.10 1\$4.50 \$5.60 -10.00% -0.56 \$5.04 \$0.34 \$5.38

Percent calculation for item entries

Example

Key operation		Print	
(When a premium of 15% is programmed for the %1 key.)	6 <input type="button" value="PLU/UPC"/> <input type="button" value="%1"/> 30 <input type="button" value="PLU/UPC"/> 7 • 5 <input type="button" value="%1"/> <input type="button" value="CA/AT/NS"/>	1@ 3.50 PLU00006 %1 1@ 5.00 PLU00030 %1 MDSE ST TAX1 ITEMS 2Q CASH	1\$3.50 15.00% \$0.53 1\$5.00 7.50% \$0.38 \$9.41 \$0.51 \$9.92

NOTE

- You can also enter a percent calculation from the function menu window. Press the key and select "3 %2" and enter a percent calculation.
- Availability of item % and/or subtotal % depends on the programming data of %1 and %2.

■ Discount entries

Your register allows you to deduct a certain amount less than a programmed upper limit after the entry of an item or the computation of a subtotal depending on the programming.

Discount for a subtotal

Example

Key operation	Print
6 <input type="button" value="PLU/UPC"/>	1@ 3.50 1\$3.50
60 <input type="button" value="PLU/UPC"/>	PLU00006
<input type="button" value="#/TM/SBTL"/>	1@ 12.00 1\$12.00
100 <input type="button" value="⊖"/>	PLU00060
<input type="button" value="CA/AT/NS"/>	MDSE ST \$15.50
	(-) -1.00
	MDSE ST \$14.50
	TAX1 \$0.93
	ITEMS 2Q
	CASH \$15.43

Discount for item entries

Example

Key operation	Print
7 <input type="button" value="PLU/UPC"/>	1@ 2.10 1\$2.10
75 <input type="button" value="⊖"/>	PLU00007
<input type="button" value="CA/AT/NS"/>	(-) -0.75
	MDSE ST \$1.35
	TAX1 \$0.12
	ITEMS 1Q
	CASH \$1.47

■ Refund entries

For a refund entry, press the key just before you press a department key, key, or key or just before you scan a UPC code. The operation before pressing the key is the same as the one of normal operation. For example, if a refund item is the one entered into a department, enter the amount of the refund, then press the key and the corresponding department key in this order; if an item entered into a PLU/UPC is returned, enter the corresponding PLU/UPC code, then press the and keys and if a refund item is the one entered into an UPC, press the key and scan the UPC code.

Example

Key operation	Print
3 <input type="button" value="REFUND"/> <input type="button" value="PLU/UPC"/>	-1@ 1.10 1R-1.10
7 <input type="button" value="⊖"/>	PLU00003
7 <input type="button" value="REFUND"/> <input type="button" value="PLU/UPC"/>	-7@ 2.10 1R-14.70
<input type="button" value="CA/AT/NS"/>	PLU00007
	MDSE ST -15.80
	TAX1 -0.95
	ITEMS 0Q
	CHANGE \$16.75

■ Printing of non-add code numbers

Enter a non-add code number such as a guest code number within a maximum of 16 digits and press the **#/TM/SBTL** key at any point during the entry of a sale. The non-add code is printed on the receipt.

Example

Key operation	Print
1230 #/TM/SBTL	#0000000000001230
700 1 ²¹	1@ 7.00 1 \$7.00
CH1	DEPT. 01
	MDSE ST \$7.00
	TAX1 \$0.42
	ITEMS 1Q
	CHARGE \$7.42

Payment Treatment

■ Currency conversion

Your register allows payment entries in foreign currency. Press the **FUNC MENU** key and select “CONV 1” or “CONV 2” to create a subtotal in foreign currency.

Procedure

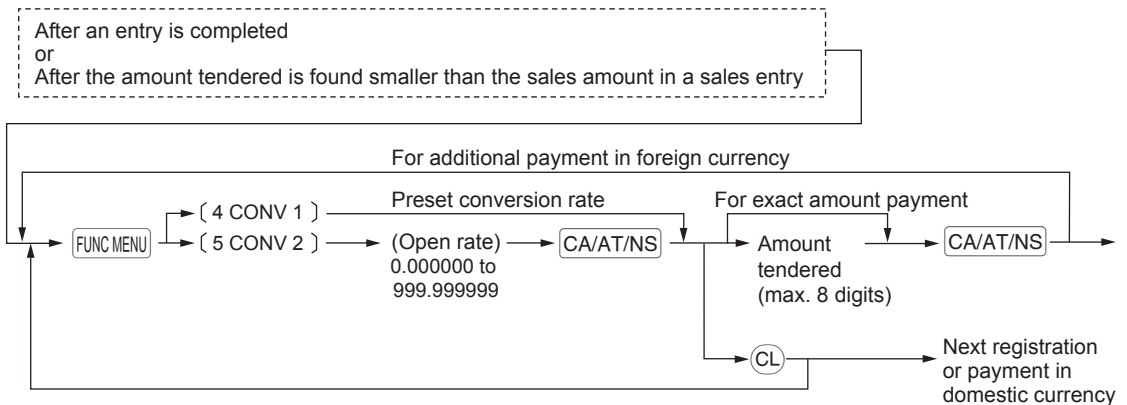

NOTE

- When the amount tendered is short, its equivalent in deficit is shown in domestic currency.
- Change amount will be displayed in domestic currency.

Example

Preset conversion rate (0.8063) :CONV 1

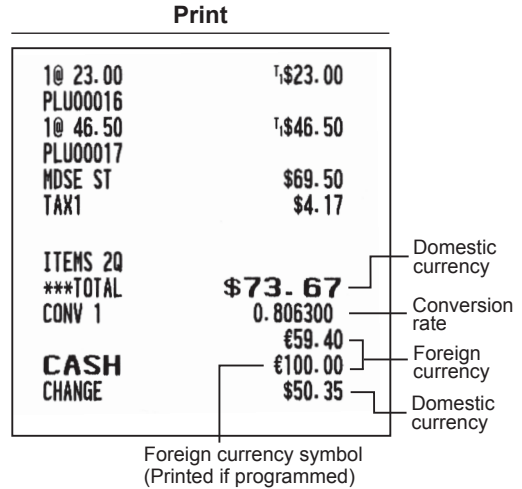
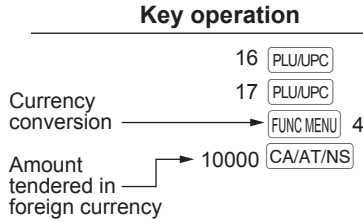

Example

Open conversion rate (1.275) :CONV 2

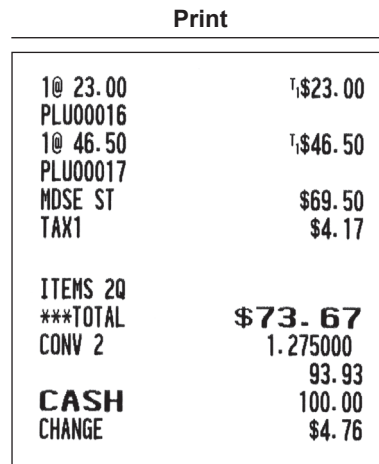
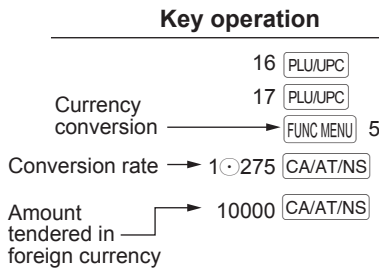

Received-on-account entries

When you receive on account from a customer, use this function.

From the FUNCTION MENU, select RA option to proceed the operation. You cannot receive RA in foreign currency.

Procedure

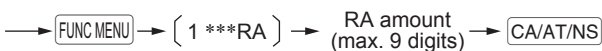

Example

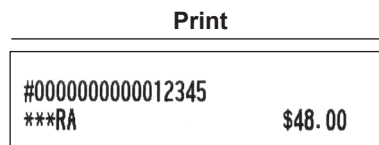
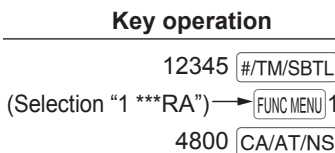

■ Paid-out entries

When you pay an amount to a vendor, use this function.

From the FUNCTION MENU, select PO option to proceed the operation.

Procedure

→ **FUNC MENU** → { 2 ***PO } → Amount (max. 9 digits) → **CA/AT/NS**

Example

Key operation	Print
6789 #/TM/SBTL (Selection "2 ***PO") → FUNC MENU 2 3000 CA/AT/NS	#0000000000006789 ***PO \$30.00

■ No-sale (exchange)

Simply press the **CA/AT/NS** key without any entry. The drawer will open and the printer will print "NO SALE" on the receipt. If you let your register print a non-add code number before pressing the **CA/AT/NS** key, a no sale entry is achieved with a non-add code number printed.

Print
NO SALE

■ Bottle return

This function is used to handle the deposit and payment (paid out) for returned empty bottles or cans. This function is applicable only to those departments that have been set for bottle return departments or their associated PLUs, sub-departments or UPCs.

Example

Key operation	Print
10 @FOR 15 DEPT SHIFT 20 CA/AT/NS	10@ -0.15 -1.50 DEPT. 40 ITEMS 00 CHANGE \$1.50

(When dept. 40 is programmed as a bottle return dept. and also a negative dept.)

TRAINING Mode

The training mode is used when the operator or the manager practices register operations.

When a clerk set in training is selected, the register automatically enters the training mode, while a clerk not set in training is selected, the register automatically enters the ordinary REG mode. A training text and a training clerk can be programmed.

The training operations are valid in all modes.

A mark which is identifying a training receipt is printed on the receipt which is issued in the training mode.

The consecutive number is not updated. The preceding number is repeated in printing.

Training clerk programming is performed in PROGRAM mode. (It allows only for one-clerk.)

The memory in clerk is updated in the training mode. Other memories are not updated.

The reading and resetting of training clerks is printed on the clerk reports. However, the sales total of training clerks is not included in the clerk total on the full clerk report.

Example

	Key operation	Print
Selecting the clerk set in training	5 <input type="button" value="PLU/UPC"/>	<p style="text-align: center;">TRAINING</p> <p>1@ 2.25 1\$2.25 PLU00005 3@ 1.10 1\$3.30 PLU00003 MDSE ST \$5.55 TAX1 \$0.33</p> <p>ITEMS 40 CASH \$5.88</p>
	3 <input type="button" value="@FOR"/>	
	3 <input type="button" value="PLU/UPC"/>	
	<input type="button" value="CA/AT/NS"/>	

5 Correction

Correction of the Last Entry (Direct Void)

If you make an incorrect entry relating to a department, PLU/subdepartment, UPC, percentage (%1, %2), discount (⊖), or item refund, you can void this entry by pressing the VOID key immediately after the incorrect entry.

Example

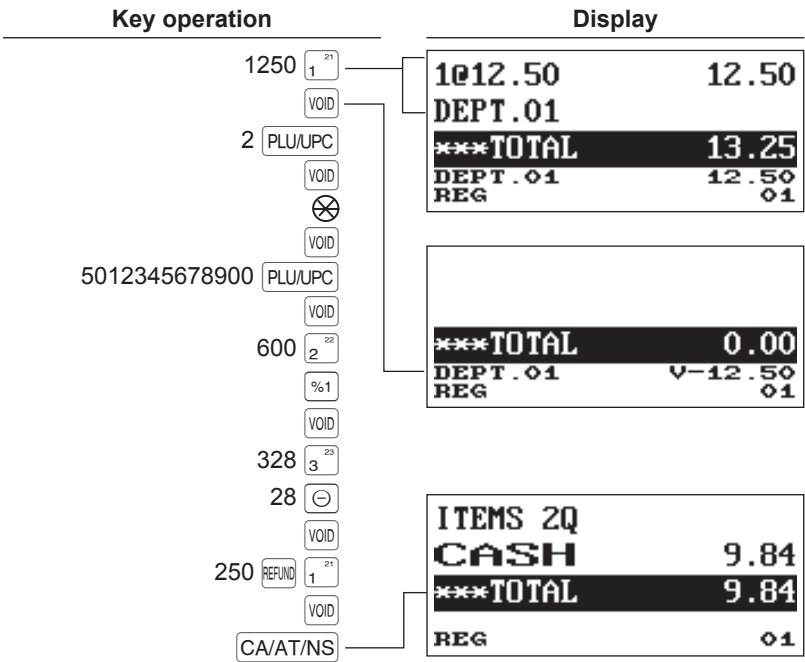

Correction of the Next-to-Last or Earlier Entries (Indirect Void)

If you find an incorrect entry before finalizing the transaction (e.g. before pressing the **CA/AT/NS** key), you can void the entry by the cursor operation or the key sequence operation.

Indirect void by cursor operation

You can void department, PLU/subdepartment, UPC, item refund, amount discount/premium and percent entries.

Move the cursor to the item to be voided, and press the **VOID** key.

Indirect void by key sequence operation

You can void department, PLU/subdepartment, UPC and item refund.

Press the **VOID** key just before you press a department key, **DEPT#** key or **PLU/UPC** key or just before you scan an UPC code. For the refund indirect void, press the **VOID** key after you press the **REFUND** key.

Example

(Indirect void by cursor operation)

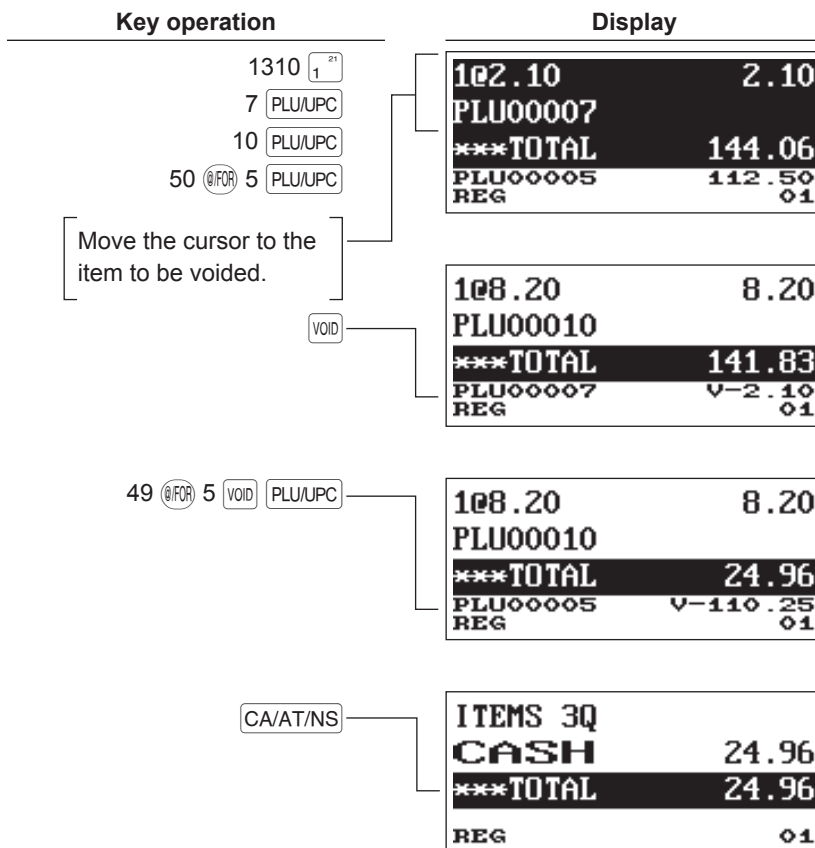

NOTE

The register allows you to enter the quantity to void only for the integer quantity.

→ [Selection the item to void by cursor] → [Entry the quantity to void (XXXX)] → **VOID**

Subtotal Void

You can void an entire transaction. Once subtotal void is executed, the transaction is aborted and the register issues a receipt.

Example

Key operation	Display								
1 PLU/UPC	<table border="1"> <tr><td>SBTL VOID</td><td>-134.85</td></tr> <tr><td>***TOTAL</td><td>0.00</td></tr> <tr><td>***TOTAL</td><td>0.00</td></tr> <tr><td>REG</td><td>01</td></tr> </table>	SBTL VOID	-134.85	***TOTAL	0.00	***TOTAL	0.00	REG	01
SBTL VOID		-134.85							
***TOTAL		0.00							
***TOTAL		0.00							
REG		01							
2 PLU/UPC									
10 PLU/UPC									
Subtotal void {									
		#/TM/SBTL							
		VOID							
	#/TM/SBTL								

Correction after Finalizing a Transaction

When you need to void incorrect entries that are found after finalizing a transaction or cannot be corrected by direct, indirect or subtotal void, follow this procedure.

1. Press the **MODE** key.
2. Select the "3 VOID MODE" by using the **↓** key, and press the **CA/AT/NS** key.
3. Repeat the entries that are recorded on an incorrect receipt. (All data in the incorrect receipt is removed from register memory; the voided amounts are added to the void mode totalizer.)

Incorrect receipt	Cancellation receipt																																																															
<table border="1"> <tr><td>#000102</td><td>10/02/2011</td><td>3:00:26PM</td></tr> <tr><td>01 CLERK01</td><td></td><td>111111</td></tr> <tr><td>3@ 12.50</td><td></td><td>T:\$37.50</td></tr> <tr><td>PLU00001</td><td></td><td></td></tr> <tr><td>1@ 5.10</td><td></td><td>T:\$5.10</td></tr> <tr><td>PLU00002</td><td></td><td></td></tr> <tr><td>MDSE ST</td><td></td><td>\$42.60</td></tr> <tr><td>TAX1</td><td></td><td>\$2.56</td></tr> <tr><td>ITEMS 4Q</td><td></td><td></td></tr> <tr><td>CASH</td><td></td><td>\$45.16</td></tr> </table>	#000102	10/02/2011	3:00:26PM	01 CLERK01		111111	3@ 12.50		T:\$37.50	PLU00001			1@ 5.10		T:\$5.10	PLU00002			MDSE ST		\$42.60	TAX1		\$2.56	ITEMS 4Q			CASH		\$45.16	<table border="1"> <tr><td>#000103</td><td>10/02/2011</td><td>3:01:00PM</td></tr> <tr><td>01 CLERK01</td><td></td><td>111111</td></tr> <tr><td></td><td>*VOID*</td><td></td></tr> <tr><td>3@ 12.50</td><td></td><td>T:\$37.50</td></tr> <tr><td>PLU00001</td><td></td><td></td></tr> <tr><td>1@ 5.10</td><td></td><td>T:\$5.10</td></tr> <tr><td>PLU00002</td><td></td><td></td></tr> <tr><td>MDSE ST</td><td></td><td>\$42.60</td></tr> <tr><td>TAX1</td><td></td><td>\$2.56</td></tr> <tr><td>ITEMS 4Q</td><td></td><td></td></tr> <tr><td>CASH</td><td></td><td>\$45.16</td></tr> </table>	#000103	10/02/2011	3:01:00PM	01 CLERK01		111111		*VOID*		3@ 12.50		T:\$37.50	PLU00001			1@ 5.10		T:\$5.10	PLU00002			MDSE ST		\$42.60	TAX1		\$2.56	ITEMS 4Q			CASH		\$45.16
#000102	10/02/2011	3:00:26PM																																																														
01 CLERK01		111111																																																														
3@ 12.50		T:\$37.50																																																														
PLU00001																																																																
1@ 5.10		T:\$5.10																																																														
PLU00002																																																																
MDSE ST		\$42.60																																																														
TAX1		\$2.56																																																														
ITEMS 4Q																																																																
CASH		\$45.16																																																														
#000103	10/02/2011	3:01:00PM																																																														
01 CLERK01		111111																																																														
	VOID																																																															
3@ 12.50		T:\$37.50																																																														
PLU00001																																																																
1@ 5.10		T:\$5.10																																																														
PLU00002																																																																
MDSE ST		\$42.60																																																														
TAX1		\$2.56																																																														
ITEMS 4Q																																																																
CASH		\$45.16																																																														

NOTE

Your register leaves the VOID mode whenever a transaction is canceled (i.e. finalized in the VOID mode). To void additional transactions, repeat steps 1 through 3 above.

6

Special Printing Function

Copy Receipt Printing

If your customer wants a receipt after you have finalized a transaction with the receipt ON-OFF function in the OFF status (no receipting), press the **RCPT COPY** key for receipting. Your register can also print a copy receipt when the receipt ON-OFF function is in the "ON" status.

Procedure

→ **RCPT COPY**

Example

Printing a receipt after making the entries shown below with the receipt ON-OFF function "OFF" status

Key operation	Print																		
2 PLU/UPC																			
3 @FOR																			
1 PLU/UPC																			
CA/AT/NS																			
For receipting → RCPT COPY																			
	Print on the receipt																		
	<table style="width: 100%; border-collapse: collapse;"> <tr> <td style="width: 70%;">1@ 5.10</td> <td style="text-align: right;">T,\$5.10</td> </tr> <tr> <td>PLU00002</td> <td></td> </tr> <tr> <td>3@ 12.50</td> <td style="text-align: right;">T,\$37.50</td> </tr> <tr> <td>PLU00001</td> <td></td> </tr> <tr> <td>MDSE ST</td> <td style="text-align: right;">\$42.60</td> </tr> <tr> <td>TAX1</td> <td style="text-align: right;">\$2.56</td> </tr> <tr> <td colspan="2"> </td> </tr> <tr> <td>ITEMS 4Q</td> <td></td> </tr> <tr> <td>CASH</td> <td style="text-align: right;">\$45.16</td> </tr> </table>	1@ 5.10	T,\$5.10	PLU00002		3@ 12.50	T,\$37.50	PLU00001		MDSE ST	\$42.60	TAX1	\$2.56			ITEMS 4Q		CASH	\$45.16
1@ 5.10	T,\$5.10																		
PLU00002																			
3@ 12.50	T,\$37.50																		
PLU00001																			
MDSE ST	\$42.60																		
TAX1	\$2.56																		
ITEMS 4Q																			
CASH	\$45.16																		

"COPY" is printed on the copy receipt.

COPY	
1@ 5.10	T,\$5.10
PLU00002	
3@ 12.50	T,\$37.50
PLU00001	
MDSE ST	\$42.60
TAX1	\$2.56
ITEMS 4Q	
CASH	\$45.16

7 Manager Mode

The manager mode is used when managerial decisions must be made concerning register entries, for example, for overriding limitations and for other various non-programming managerial tasks.

NOTE Normal register operations may also be performed in this mode.

Entering the Manager Mode

To enter the manager mode, use the following procedure in the REG mode:

Procedure

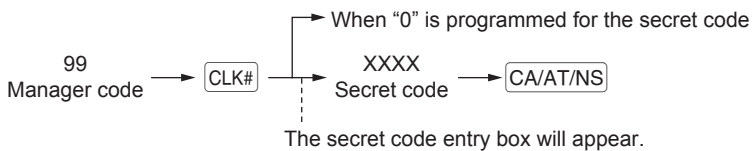

Example

If the code is correct, the register enters the manager mode.

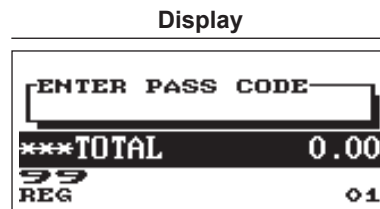

Override Entries

Programmed limits (such as maximum amounts) for functions can be overridden by placing the register in the manager mode.

Example

This example presumes that the register has been programmed not to allow coupon entries over 2.00.

Key operation	Print
REG-mode entries { 3 [PLU/UPC]	1@ 3.00 1 \$3.00
250 [⊖]Error	PLU00003
[CL]	(-) -2.50
Enter to the manager mode — 99 [CLK#]	MDSE ST \$0.50
250 [⊖]	TAX1 \$0.18
[CA/AT/NS]	ITEMS 1Q
	CASH \$0.68

NOTE • When a transaction is finalized, manager is automatically signed off.

8

Reading (X) and Resetting (Z) of Sales Totals

- Use the reading function (X) when you need to take the reading of sales information entered after the last resetting. You can take this reading any number of times. It does not affect the register's memory.
- Use the resetting function (Z) when you need to clear the register's memory. Resetting prints all sales information and clears the entire memory except for the GT1 through GT3, reset count, and consecutive number.
- X1 and Z1 reports show daily sales information. You can take these reports in the X1/Z1 mode.
- X2 and Z2 reports show periodic (monthly) consolidation information. You can take these reports in the X2/Z2 mode.
- In the OP X/Z mode, a clerk can take his or her report.
- If you want to stop the printing report, press the **ESC/CANCEL** key.

■ How to take a X1/Z1 or X2/Z2 report

[To take an X1 or X2 report:]

1. Press the **MODE** key.
2. Select the "4 X1/Z1 MODE" or "5 X2/Z2 MODE" by using the **↓** key, and press the **CA/AT/NS** key.
3. Select "2 READING" in the X1/Z1 mode or select "1 READING" in the X2/Z2 mode menu window and press in both cases **CA/AT/NS** key to display the items list.
4. Select the appropriate report title.
5. Press the **CA/AT/NS** key.

[To take a Z1 or Z2 report:]

1. Press the **MODE** key.
2. Select the "4 X1/Z1 MODE" or "5 X2/Z2 MODE" by using the **↓** key, and press the **CA/AT/NS** key.
3. Select "3 RESETTING" in the X1/Z1 mode or select "2 RESETTING" in the X2/Z2 mode menu window and press in both cases **CA/AT/NS** key to display the items list.
4. Select the appropriate report title.
5. Press the **CA/AT/NS** key.

■ View report

You can take view reports (display only) in the X1/Z1 mode for department sales, cash in drawer (CID) and sales total at the point you take the report.

1. Press the **MODE** key.
2. Select the "4 X1/Z1 MODE" by using the **↓** key, and press the **CA/AT/NS** key.
3. Select the "1 VIEW REPORT", and press the **CA/AT/NS** key.
4. Select "1 DEPT. SALES" to take a view report of department sales, "2 CASH IN DRAWER" to take a view report of cash in drawer, or "3 SALES TOTAL" to take a view report of sales total.
5. Press the **CA/AT/NS** key.

Report type	Description	Operating modes			Data to be entered
		OP X/Z	X1/Z1	X2/Z2	
GENERAL	General report		X1, Z1	X2, Z2	
<DEPT. MENU>					
BY RANGE	Department by group report		X1	X2	Department code (The range can be specified by entering start and end codes.)
BY GROUP	Individual department group report		X1	X2	Department group no. (1 to 12)
GROUP TOTAL	Department group total report		X1	X2	
<TRANS. MENU>					
TRANSACTION	Transaction report		X1	X2	
TL-ID	Total-in-drawer report		X1	X2	
<PLU/UPC MENU>					
BY RANGE	PLU/UPC sales report by specified range		X1, Z1	X2, Z2	PLU/UPC code (The range can be specified by entering start and end codes.)
BY DEPT	PLU/UPC report by associated department		X1, Z1	X2, Z2	Department code
<CLERK MENU>					
ALL CLERK	All clerk report		X1, Z1	X2, Z2	
IND. CLERK	Individual clerk report	X, Z	X1, Z1	X2, Z2	For the assigned clerk
HOURLY	Hourly report (all or by specified range)		X1		For an individual time range (The range can be specified by entering start and end times.)
	Hourly report (all)		Z1		
DAILY NET	Daily net report			X2, Z2	
SRM REPORT	SRM (Sales Recording Module) report			X2	Only for the Quebec fiscal

NOTE

The following reports relating to PLU/UPC is issued in the sequence of PLUs and UPCs. PLU/UPC and PLU/UPC BY DEPT.

Also the UPC codes are printed in the sequence shown below.

EAN-13
EAN-8
UPC-A
UPC-E
ITF-14

Daily Sales Totals

General report

Sample report

Z1		Mode title*1
		Reset counter
		Net grand total (GT2-GT3)
Z1 0014		Grand total of plus registration
GT1 \$00000439940.75		Grand total of minus registration
GT2 \$00000441411.51		Grand total of training mode registration
GT3 -00000001470.76		Dept. code
TR \$00000000037.24		Sales q'ty
DEPARTMENT		Sales amount
D01 535.000 Q		} "+" dept. counter and total
DEPT.01 \$7563.61		
D02 22.000 Q		
DEPT.02 \$1411.29		
D03 31.000 Q		} "-" dept. counter and total
DEPT.03 \$976.58		
D99 20.000 Q		} "+" bottle return dept. counter and total
DEPT.99 \$113.11		
*DEPT TL 1199.000 Q		} "-" bottle return dept. counter and total
\$18294.66		
D38 4.000 Q		} Subtotal ⊖ counter and total
DEPT.38 -8.72		
DEPT(-) 4.000 Q		} Subtotal percent 1 counter and total
-8.72		
D39 36.000 Q		} Net sales total
DEPT.39 \$18.70		
*BTTL TL 36.000 Q		
\$18.70		
TRANSACTION		
(-) 3 Q		
-5.37		
%1 3 Q		
-163.05		
%2 2 Q		
-73.65		
NET 1 \$18027.32		

- *1: When you take X1 report, "X1" is printed.
- *2: Printed in the Z1 report only.
- *3: When the Canadian tax system is selected, the following is printed here.

GST EXPT \$155.15	Exempt total from GST
PST TTL \$12.64	PST total
GST TTL \$11.49	GST total

TAX1 ST \$16718.16	Taxable 1 total	
GRS TAX1 \$1055.11	Gross tax 1 total	
RFD TAX1 -17.11	Refund tax 1 total	
TAX1 \$1038.00	Net tax 1 total	
TX1 EXPT \$2.60		
TAX2 ST \$271.15		
GRS TAX2 \$21.69		
M-TAX \$1.79		Manual tax total
----- *3		
TTL TAX \$1075.67	Tax total	
NET \$18015.83	Net total without tax	
NET2 \$19091.50	Net total with tax	
(-) 5 Q	} Item ⊖ counter and total	
-4.38		
%1 4 Q	} Item percent 1 counter and total	
-4.26		
%2 4 Q		
-4.51		
VOID 3 Q	} REG-mode void counter and total	
\$120.02		
SBTL VOID 2 Q	} Subtotal void counter and total	
\$206.39		
MGR VOID 9 Q	} Manager item void counter and total	
\$41.33		
VOID 3 Q	} Void-mode transaction counter and total	
\$41.33		
REFUND 8 Q	} Refund counter and total	
\$49.82		
***RA 2 Q	} Received on account counter and total	
\$380.00		
***PO 1 Q	} Paid out counter and total	
\$150.00		
NO SALE 4 Q	No-sales counter	
TRANS CT 378 Q	Customer counter	
NET3 \$19091.50	Sales total	
CASH 360 Q		} Cash counter and total
\$17659.37		
CHECK 7 Q	} Check sales counter and total	
\$795.55		
CHARGE 4 Q	} Charge1 sales counter and total	
\$234.68		
CHARGE- 1 Q	} Charge1 refund counter and total	
-12.28		
CHARGE2 2 Q		
\$57.63		
CHARGE2- 1 Q		
-19.51		
CONV 1 \$272.47	Foreign currency total (preset)	
CONV 2 236.08	Foreign currency total (open)	
****CID \$17742.38	Cash in drawer	
CA+CHK ID \$18537.93	Cash + check in drawer	
CHK/CG \$124.46	Change total for check tendering	

■ Department report

• Sample report

*X1 *	Mode title
DEPARTMENT	Report title
D01	512.000 Q
DEPT. 01	\$6498.93
D02	16.000 Q
DEPT. 02	\$1026.29
D03	9.000 Q
DEPT. 03	\$114.36
D04	5.000 Q
DEPT. 04	\$26.20
D99	9.000 Q
DEPT. 99	\$55.80
*DEPT TL	1113.000 Q
	\$15471.12
D38	4.000 Q
DEPT. 38	-8.72
DEPT (-)	4.000 Q
	-8.72
D39	36.000 Q
DEPT. 39	\$18.70
*BTTL TL	36.000 Q
	\$18.70
D40	47.000 Q
DEPT. 40	-35.25
BTTL (-)	47.000 Q
	-35.25

■ Full group total report on department

• Sample report

*X1 *	Mode title
GROUP TOTAL	Report title
GROUP01	571.000 Q
	\$7729.00
GROUP02	9.000 Q
	\$114.36
GROUP03	16.000 Q
	\$174.15
GROUP08	27.000 Q
	\$1154.19
GROUP09	20.000 Q
	\$869.08

} Group 1 total

■ Transaction report

• Sample report

*X1 *	Mode title
TRANSACTION	Report title

↓

This report shows the same transaction data as when a full sales report is run.

■ Individual group total report on department

• Sample report

*X1 *	Mode title
DEPT. IND. GROUP	Report title
D01	512.000 Q
DEPT. 01	\$6498.93
D02	16.000 Q
DEPT. 02	\$1026.29
D04	5.000 Q
DEPT. 04	\$26.20
D09	16.000 Q
DEPT. 09	\$107.20
D10	22.000 Q
DEPT. 10	\$70.38
GROUP01	571.000 Q
	\$7729.00

} Group 1 total

■ Total in drawer report

• Sample report

*X1 *	Mode title
TL-ID	Report title
***CID	\$5236.07
CA+CHK ID	\$5550.84

— Cash in drawer
— Cash plus check in drawer

■ PLU/UPC report by designated range

• Sample report

	X1	Mode title*
PLU/UPC		Report title
	00001-999999999999	Range
PLU		Sales q'ty and total
P00001	5.000 Q	
PLU00001	\$17.50	
P00002	3.000 Q	
PLU00002	\$15.30	
P00035	31.000 Q	
PLU00035	\$46.50	
***TOTAL	315.000 Q	PLU range sum
	\$1964.20	
UPC		UPC range sum
4901305920795#	6.000 Q	
Notebook	\$7.20	
5045678912304#	3.000 Q	
Item-C	\$10.80	
***TOTAL	66.000 Q	
	\$194.70	

■ PLU/UPC report by associated department

• Sample report

	X1	Mode title
PLU/UPC BY DEPT		Report title
DEPT. 01		Associate dept. code
PLU	D01	
P00002	3.000 Q	Sales q'ty and total
PLU00002	\$15.30	
P00005	11.000 Q	
PLU00005	\$24.75	
P00007	5.000 Q	
PLU00007	\$10.50	
***TOTAL	19.000 Q	PLU total
	\$50.55	
UPC		UPC total
5012345678900#	5.000 Q	
Item-A	\$15.50	
5045678912304#	3.000 Q	
Item-C	\$10.80	
***TOTAL	8.000 Q	
	\$26.30	

* When you take Z1 report, "Z1" is printed.
The UPC codes are printed out in the order of EAN-13, EAN-8, UPC-A, UPC-E and ITF-14.

■ Clerk reports

Individual clerk report

• Sample report

	OPX	Mode title*
IND. CLERK		Report title
	CLERK01	Clerk code
CLK#01		Clerk name
TRANS CT	44 Q	Customer counter
NET3	\$646.58	Customer counter
***CID	\$529.71	Sales total
CA+CHK ID	\$646.58	
CHK/CG	\$23.31	Net sales
NET	\$605.85	Commission 1 sales total
COM. SAL1	\$76.50	Commission 1 amount
COM. AMT1	\$3.83	
COM. SAL2	\$164.45	Commission amount total
COM. AMT2	\$11.51	
COM. TTL	\$15.34	Non commission sales total
NON COM.	\$364.90	

*: When you take OPZ report, "OPZ" is printed.

Full clerk report

The report prints in the same format as in the sample report of individual clerk, but all clerk's sales data is sorted by clerk code # (from #1 to #40).

■ Hourly report

• Sample report

	X1	Mode title*
HOURLY		Report title
6:00AM	22 Q	Customer counter
	\$127.68	Sales total
7:00AM	31 Q	
	\$809.13	
8:00AM	40 Q	
	\$579.83	
7:00PM	74 Q	
	\$1780.27	
8:00PM	108 Q	
	\$2668.81	

*: When you take Z1 report, "Z1" is printed.
When you take an hourly report by range, a report of the specified range of time (hour) is printed.

Periodic Report Sample

■ General information

The periodic reading or resetting reports are the same in format as those in the X1/Z1 report for daily sales. The mode indicator will read "X2" or "Z2".

• Sample X report

(Individual group total report on department)

X2	Mode title
GROUP TOTAL	Report title

• Sample Z report

(Full sales report)

Z2	Mode title
Z1 0013	Reset counter of daily total
Z2 0001	Reset counter of periodic consolidation
GT1 \$00000420849.25	Grand totals
GT2 \$00000421611.58	
GT3 -00000000762.33	
TR \$00000000037.24	

The subsequent printouts are the same in format as those in the X/Z report for daily totals.

■ Daily net report

• Sample report

X2	Mode title*
DAILY NET	Date
08/01	85 Q Customer counter
	\$2742.05 Sales total
08/02	117 Q
	\$4435.79
08/03	139 Q
	\$27255.60
08/29	133 Q
	\$16884.21
08/30	152 Q
	\$30145.75
***TOTAL	3089 Q Customer total
	\$421611.58 Net amount total

*: When you take Z report, "Z2" is printed instead of "X2".

9

Prior to Programming

When you are in the PROGRAM mode, the keyboard layout will be set to one of the programming layouts as shown below.

Programming Keyboard Layout

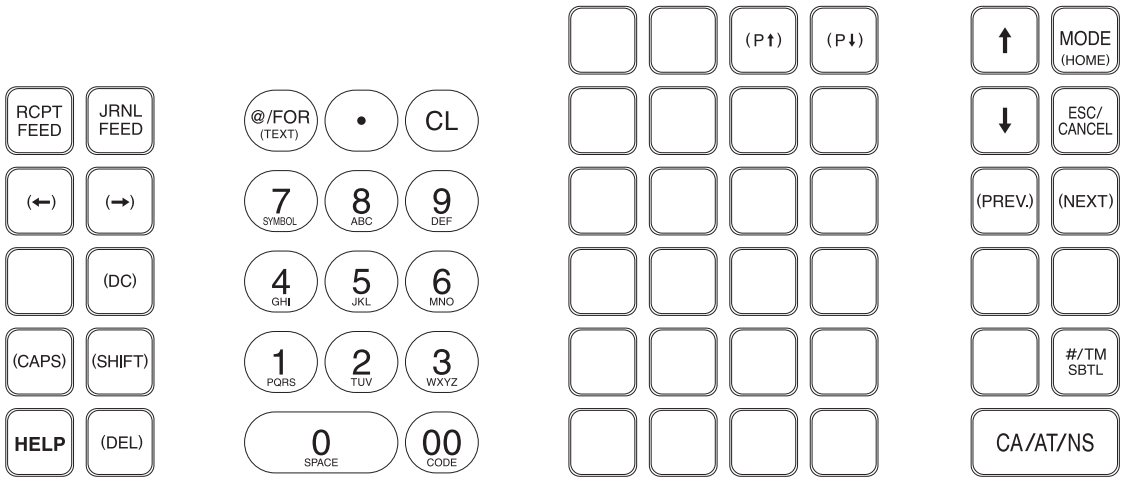

(SHIFT) (DC) (DEL) : Used for programming characters. For more information about programming characters, see the section “How to Program Alphanumeric Characters.”
 (CAPS) (TEXT) : Also the (DEL) key is used to delete the record item.

(←) (→) ↑ ↓ : Used to move the cursor.

CA/AT/NS : Used to program each setting and to finalize programming.

ESC/ CANCEL : Used to cancel programming and to get back to the previous screen.

(PREV) : Used to go back to the previous record, e.g., from the department 2 programming window back to the department 1 programming window.

(NEXT) : Used to go to the next record, for example, in order to program unit prices for sequential departments.

(P↓) : Used to scroll the window to go to the next page.

(P↑) : Used to scroll the window to go back to the previous page.

CL : Used to clear the last setting you have programmed or clear the error state.

• : Used to toggle between two or more options.

#/TM SBTL : Used to list those options which you can toggle by the • key.

Numeric keys : Used for entering figures.

How to Program Alphanumeric Characters

This section discusses how to program alphanumeric characters for various texts.

■ Mobile phone method

Entering alphanumeric characters

To enter a character, simply press a corresponding character key on the programming keyboard.

To enter “A”, press the “8” key.

To enter “B”, press the “8” key twice.

To enter “C”, press the “8” key three times.

Entering double-size characters

 : This key toggles the double-size character mode and the normal-size character mode. The default is the normal-size character mode. When the double-size character mode is selected, the letter “W” appears at the bottom of the display.

Entering upper-case letters

 : You can enter an upper-case letter by using this key. Press this key just before you enter the upper-case letter. You should press this key each time you enter an upper-case letter.

 : You can lock the upper-case letter mode once the this key is pressed.

Entering space

 : Enter a space in the cursor position.

To move the cursor

  : Moves the cursor.

To delete a character or figure

 : Deletes a character or figure in the cursor position.

To change the text input mode

 : This key toggles the text input mode, Alphabet (A), European character (Ä), numeric (1), and symbol (*).

■ Entering character codes

Numerals, letters and symbols are programmable by entering the **00** key and character codes. Use the following procedure with the cursor placed at the position where you want to enter characters:

To enter a digit, simply press a corresponding numeric key.

→ **00** → XXX XXX : character code (3 digits)

Character code:

032 - 047	032	033	034	035	036	037	038	039	040	041	042	043	044	045	046	047
		!	"	#	\$	%	&	'	()	*	+	,	-	.	/
048 - 063	048	049	050	051	052	053	054	055	056	057	058	059	060	061	062	063
	0	1	2	3	4	5	6	7	8	9	:	;	<	=	>	?
064 - 079	064	065	066	067	068	069	070	071	072	073	074	075	076	077	078	079
	@	A	B	C	D	E	F	G	H	I	J	K	L	M	N	O
080 - 095	080	081	082	083	084	085	086	087	088	089	090	091	092	093	094	095
	P	Q	R	S	T	U	V	W	X	Y	Z	[\]	^	_
096 - 111	096	097	098	099	100	101	102	103	104	105	106	107	108	109	110	111
	`	a	b	c	d	e	f	g	h	i	j	k	l	m	n	o
112 - 127	112	113	114	115	116	117	118	119	120	121	122	123	124	125	126	127
	p	q	r	s	t	u	v	w	x	y	z	{		}	~	Δ
128 - 143	128	129	130	131	132	133	134	135	136	137	138	139	140	141	142	143
	Ç	ü	é	â	ä	à	ã	ç	ê	ë	è	ï	î	ì	Ä	Å
144 - 159	144	145	146	147	148	149	150	151	152	153	154	155	156	157	158	159
	É	æ	ƒ	ô	ö	ò	û	ù	ÿ	ö	ü	ø	£	Ø	x	f
160 - 175	160	161	162	163	164	165	166	167	168	169	170	171	172	173	174	175
	á	í	ó	ú	ñ	Ñ	ª	º	¿	®	€	½	¼	¡	«	»
176 - 191	176	177	178	179	180	181	182	183	184	185	186	187	188	189	190	191
	⋮	⋮	⋮		‰	Á	Â	À	©	€		‰	‰	¢	¥	€
192 - 207	192	193	194	195	196	197	198	199	200	201	202	203	204	205	206	207
	T ₁	T ₂	T ₃	T ₄	z	3	4	z ₃	z ₄	z ₄	Å	↑	↓	=	Ó	Ø
208 - 223	208	209	210	211	212	213	214	215	216	217	218	219	220	221	222	223
	ð	Ð	Ê	Ë	È	€	Í	Î	Ï	Ë	Γ	■	■	¡	ì	■
224 - 239	224	225	226	227	228	229	230	231	232	233	234	235	236	237	238	239
	Ó	ß	Ô	Ò	Õ	Ö	µ	þ	Þ	Ú	Û	Ü	Ý	Ý	-	'
240 - 255	240	241	242	243	244	245	246	247	248	249	250	251	252	253	254	255
	-	±	=	¼	¶	§	÷	,	°	¨	.	1	3	2	■	(DC)

*(DC) : Double-size character code

10 Programming

This chapter explains how to program various items.

Before you start programming, press the **MODE** key and select the "6 PROGRAM MODE" or "7 SD CARD MODE" by using the **↓** key and press the **CA/AT/NS** key.

Basic Instructions

This section illustrates the basic programming by using an example of programming for departments.

■ Programming screen

Opening screen: When you select the "6 PROGRAM MODE", your display will show a programming opening screen corresponding to the mode you selected.

Mode you are in

Programming menu: Use the cursor keys or numeric key to select an option, and press the **CA/AT/NS** key.

Numeric entry and status information area

Code selecting screen (Dept. PLU):

Selected menu/option

Code number and its description
(In case of PLU/UPC, two lines are used for one code, upper line - code, lower line - description.)

Use the cursor keys or numeric keys to select an option, and press the **CA/AT/NS** key.

Numeric entry and status information area

Programming screen:

Selected code

Setting items:
Use the cursor keys to select an item.
To select an option, follow the instruction shown below.
Numeric entry: Use numeric keys
Character entry: Use character keys
Selective entry: Press ● key to toggle options, or press the **#/TM/SBTL** key to show the option list. Use the cursor keys to move the cursor and press the **#/TM/SBTL** or **CA/AT/NS** key to select it.

■ Programming example

Procedure

```
PROGRAM MODE
1 READING
2 SETTING
PGM 01
```

CA/AT/NS ↓ ↑ ESC/CANCEL

```
SETTING
1 DEPT/PLU
2 FUNCTIONS
3 MEDIA
4 FUNCTION TEXT
5 PERSONNEL
PGM 01
```

CA/AT/NS ↓ ↑ ESC/CANCEL

```
DEPT/PLU
1 DEPARTMENT
2 PLU/UPC
3 PLU RANGE
PGM 01
```

CA/AT/NS ↓ ↑ ESC/CANCEL

```
DEPARTMENT
01 DEPT.01
02 DEPT.02
03 DEPT.03
04 DEPT.04
05 DEPT.05
PGM 01
```

CA/AT/NS ↓ ↑ ESC/CANCEL

The following example shows how to program 2.00 for the unit price, "ABCDE" for the description, and "non-taxable 1" for department 1.

1. In the PROGRAM MODE screen, select "2 SETTING" by using the key and press the key.
 - The SETTING screen will appear.

NOTE

- You can also select "2 SETTING" by using numeric key "2," then press the key.
- If you return to the previous screen, press the key.

2. Select "1 DEPT/PLU"
 - The DEPT/PLU screen will appear.

NOTE

The arrow mark in the upper-right corner of the window shows that the window contains more options than are now on the screen. To scroll the window, press the or key. To return to the previous page, press the or key.

3. Select "1 DEPARTMENT."
 - The DEPARTMENT screen will appear, listing programmable departments.

4. Select "01 DEPT.01" to program for department 1.
 - The "01" window will appear.

```

01 PRICE      200      ▼
TYPE
TAX1          OPEN
TAX2          YES
TAX3          NO
PGM           NO
              01

```

```

01 PRICE      2.00    ▼
TYPE ABCDE
TAX1          OPEN
TAX2          YES
TAX3          NO
PGM           NO
              01

```

```

01 PRICE      2.00    ▼
TYPE ABCDE
TAX1          OPEN
TAX2          NO
TAX3          NO
PGM           NO
              01

```

- On the first page of the “01” window, program the unit price and description as follows:

NOTE

There are three entry patterns for the programming: the numeric entry, character entry, and selective entry.

- Move the cursor to “PRICE,” enter “200” by using numeric keys. → Numeric entry
- Move the cursor to “DEPT.01,” enter “ABCDE” by using character keys. → Character entry

If you want to clear setting, press the (CL) key before you press the (↓), (↑), (P↓), (P↑) or (CA/AT/NS) key.

- Press the (↓) key twice to move to the cursor to “TAX 1”, then program the register to set “non-taxable 1” as follows:

- Press the (•) key to select “NO.” → Selective entry

NOTE

The (•) key toggles between two options as follows:

NO→YES→NO→....

Pressing the (#/TM/SBTL) key displays all pertinent options.

- Select one of the following actions:

- To cancel the programming, press the (ESC/CANCEL) key. A confirmation window appears to ask you whether to save the data; select the option you prefer.
- To finalize the programming, press the (CA/AT/NS) key, then press the (ESC/CANCEL) key. You will return to the “DEPARTMENT” window.
- To program for the following department, press the (NEXT) key. The “02” window will appear. To return to the “01” window, press the (PREV) key.

The following sections describe how to program each item which is contained in a programming group.

DEPT/PLU Programming

Use the following procedure to select any option included in the department/PLU/UPC programming group:

Procedure

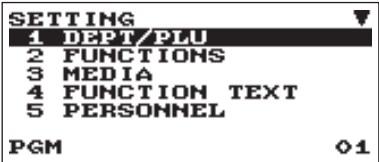

CA/AT/NS ↓ ↑ ESC/CANCEL

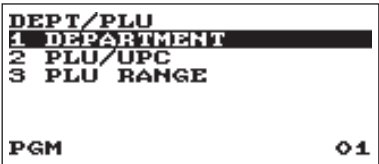

1. In the SETTING window, select “1 DEPT/PLU”
 - The DEPT/PLU window will appear.

2. Select any option from the following options list.

- 1 DEPARTMENT : Departments
- 2 PLU/UPC : PLUs/UPCs
- 3 PLU RANGE : A range of PLUs

The following illustration shows those options included in this programming group.

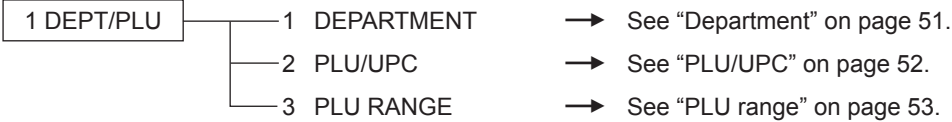

■ Department

The register can be equipped with maximum of 99 departments.

Use the following procedure to program for department.

NOTE To delete a department item in the "DEPARTMENT" window, select the item and press the  key. A confirmation window appears to ask you whether to delete the item, select the option you prefer.

Procedure

Select a pertinent dept. code from the departments list, or directly enter a department code.

Program each item as follows:

NOTE

For more information about the entry patterns, see the "Basic Instructions" section.



01	PRICE	0.00	DEPT	01
			TYPE	OPEN
			TAX1	YES
			TAX2	NO
			TAX3	NO
			PGM	01

- **PRICE (Use the numeric entry)**

Unit price (max. 8 digits)

- **Description (Use the character entry)**

Description for a department. Up to 16 characters can be entered. (Default text: DEPT.nn)

The screen continues.

- **TYPE (Use the selective entry)**

Type of unit price entry for departments

INHIBIT: Inhibited

OPEN: Open only

PRESET: Preset only

OPEN & PRESET: Open & preset

- **TAX 1 through 4 (Use the selective entry)**

Taxability for each department

YES: Taxable

NO: Non-taxable

- **SICS (Use the selective entry)**

Department type for SICS (Single Item Cash Sale)

YES: SICS department

NO: Normal department other than SICS department

- **SIGN (Use the selective entry)**

Selection of the sign (plus or minus)

+: Assign the plus sign

-: Assign the minus sign

- **HALO (Use the numeric entry)**

This function is intended for prevention of accidentally entered unreasonably amounts.

Limit amount: 0.00 to 999999.99

- **COMMISSION No. (Use the numeric entry)**

A commission group (0 to 2, 0: non commission) can be assigned to each department for commission for clerks. Each commission amount for each clerk is calculated based on a programmed commission rate and later printed on clerk reports.

- **GROUP No. (Use the numeric entry)**

01-09: Department group no. (0: non grouping)

- **BOTTLE RETURN (Use the selective entry)**

Select whether you use a department as normal department or for bottle return.

YES: Bottle return

NO: Normal department other than bottle return

■ PLU/UPC

NOTE

- In this manual, the word “UPC” represents UPC (Universal Product Code) and EAN (European Article Number).
- With regard to the UPC codes applicable to this register, please refer to the chapter 11.
- To delete a PLU/UPC item in the “PLU/UPC” window, select the item and press the **[DEL]** key. A confirmation window appears to ask you whether to delete the item, select the option you prefer.

Procedure

Select a pertinent PLU code, or directly enter a PLU code or UPC code.
(The UPC code can be entered by barcode scanning.)



```

00001
PRICE          0.00
                PLU00001
TYPE          PRESET
DEPT . CODE   01
COMMISSION No. 0
PGM           01
    
```

Program each item as follows:

- **PRICE (Use the numeric entry)**
Unit price of each price level (max. 8 digits)
- **Description (Use the character entry)**
Description for a PLU/UPC. Up to 16 characters can be entered. (Default text: PLUnnnnn for (PLUs))
- **TYPE (Use the selective entry)**
Type of unit price entry for PLUs
INHIBIT: Inhibited
OPEN: Open only
PRESET: Preset only
OPEN & PRESET: Open & preset

NOTE

For UPCs, it is fixed to “PRESET”.

• DEPT. CODE (Use the numeric entry)

Department code to be associated with the entered PLU/UPC
(01 through 99)

When a PLU/UPC is associated with a department, the following functions of the PLU/UPC depend on the programming for the department.

- Grouping (group 1 through 9)
- Single item cash sale
- Taxability

• COMMISSION No. (Use the numeric entry)

A commission group (0 to 2, 0: non commission) can be assigned to each PLU/UPC for commission for clerks. Each commission amount for each clerk is calculated based on a programmed commission rate and later printed on clerk reports.

■ PLU range

You can program PLUs in the designated range.

Procedure

```
PLU RANGE
START      00000
END        00000
OPERATION NEW&MAINT.
PGM                               01
```



```
00001-00010
PRICE
TYPE
DEPT CODE
COMMISSION No.
PGM                               01
```

Enter a value or select an option for each item as follows:

- **START (Use the numeric entry)**
Starting PLU code (max. 5 digits)
- **END (Use the numeric entry)**
Ending PLU code (max. 5 digits)
- **OPERATION (Use the selective entry)**
 - DELETE: Enables you to delete a specified range of PLUs.
 - MAINT.: Enables you to change the setting you have programmed.
 - NEW&MAINT.: Enables you to change the current setting when the specified codes have already been created or to create new codes when the specified codes have not been created yet.

Functional Programming

Use the following procedure to select any option included in the functional programming group:

Procedure

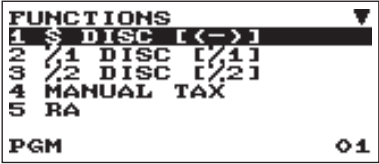
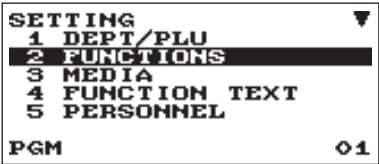

The screen continues.

1. In the SETTING window, select "2 FUNCTIONS."
 - The FUNCTIONS window will appear.

2. Select any option from the following options list.

1 \$ DISC [(-)]	Discount
2 %1 DISC [%1]	Percent 1
3 %2 DISC [%2]	Percent 2
4 MANUAL TAX	Manual tax
5 RA	Received on account
6 PO	Paid out
7 CASH IN DRAWER	Cash in drawer
8 COMMISSION1	Commission 1 rate
9 COMMISSION2	Commission 2 rate

The following illustration shows those options included in this programming group.

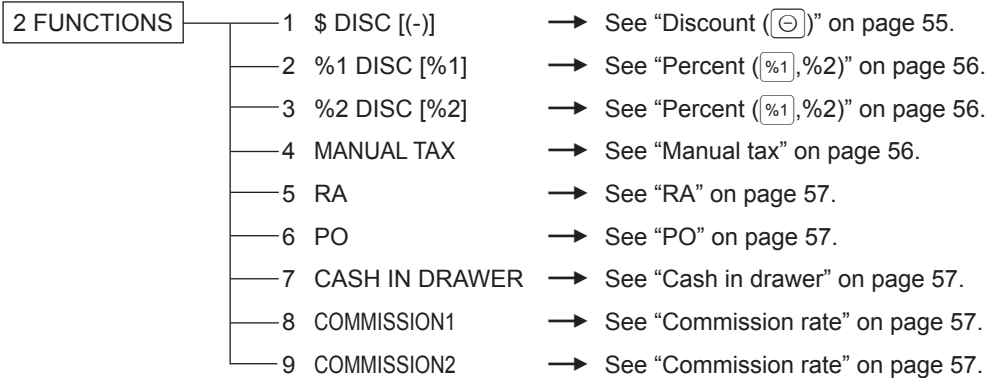

■ Discount (☹)

Procedure

```
$ DISC [←→]
AMOUNT ██████████ -0.00
TEXT ██████████ ← - →
SIGN ██████████ -
HALO ██████████ 999999.99
ITEM ██████████ YES
SUBTOTAL ██████████ YES
PGM ██████████ 01
```

The screen continues.

Program each item as follows:

- **AMOUNT (Use the numeric entry)**
Discount amount (max. 8 digits)
- **TEXT (Use the character entry)**
Description for the discount key. Up to 12 characters can be entered.
- **SIGN (Use the selective entry)**
Programming of the + or - sign assigns the premium or discount function to the discount key.
+: Plus amount (premium)
-: Minus amount (discount)
- **HALO (High Amount Lockout) (Use the numeric entry)**
This function is intended for prevention of accidentally entered unreasonably amounts.
Limit amount: 0.00 to 999999.99
- **ITEM (Use the selective entry)**
YES: Enables the item discount.
NO: Disables the item discount.
- **SUBTOTAL (Used the selective entry)**
YES: Enables the subtotal discount.
NO: Disables the subtotal discount.
- **TAX 1 through 4 (Use the selective entry)**
Taxability for the discount
YES: Taxable
NO: Non-taxable

■ Percent (%1 , %2)

Procedure

```

%1 DISC [%1]
RATE          -0.00%
TEXT          /-1
SIGN          -
HALO          100.00%
ITEM          NO
SUBTOTAL     YES
PGM          01
    
```

The screen continues.

Program each item as follows:

- **RATE (Use the numeric entry)**
Percent rate (0.00 to 100.00)
- **TEXT (Use the character entry)**
Description for the percent key. Up to 12 characters can be entered.
- **SIGN (Use the selective entry)**
Programming of the + or - sign assigns the premium or discount function to each percent key.
+: Plus (premium)
-: Minus (discount)
- **HALO (High Amount Lockout) (Use the numeric entry)**
This function is intended for prevention of accidentally entered unreasonably amounts.
HALO (High Amount Lockout) for the percent key (0.00 to 100.00)
- **ITEM (Use the selective entry)**
YES: Enables the item %.
NO: Disables the item %.
- **SUBTOTAL (Used the selective entry)**
YES: Enables the subtotal %.
NO: Disables the subtotal %.
- **TAX 1 through 4 (Use the selective entry)**
Taxability for the discount
YES: Taxable
NO: Non-taxable

■ Manual tax

Procedure

```

MANUAL TAX
HALO      999999.99
TEXT      M-TAX

PGM      01
    
```

Program each item as follows:

- **HALO (High Amount Lockout) (Use the numeric entry)**
This function is intended for prevention of accidentally entered unreasonably amounts.
Limit amount: 0.00 to 999999.99
- **TEXT (Use the character entry)**
Description for the manual tax key.
Up to 12 characters can be entered.

■ RA

You can program an upper limit amount and description for received-on-account key.

Procedure

RA	
HALO	9999999.99
TEXT	***RA
PGM	01

Program each item as follows:

- **HALO (High Amount Lockout) (Use the numeric entry)**
This function is intended for prevention of accidentally entered unreasonably amounts.
Limit amount: 0.00 to 9999999.99
- **TEXT (Use the character entry)**
Description for the received-on-account key. Up to 12 characters can be entered.

■ PO

You can program an upper limit amount and description for paid-out key.

Procedure

PO	
HALO	9999999.99
TEXT	***PO
PGM	01

Program each item as follows:

- **HALO (High Amount Lockout) (Use the numeric entry)**
This function is intended for prevention of accidentally entered unreasonably amounts.
Limit amount: 0.00 to 9999999.99
- **TEXT (Use the character entry)**
Description for the paid-out key. Up to 12 characters can be entered.

■ Cash in drawer

You can program the description and the upper limit amounts for cash in drawer (sentinel).

Procedure

CASH IN DRAWER	
HALO	9999999.99
TEXT	***CID
PGM	01

Program each item as follows:

- **HALO (High Amount Lockout) (Use the numeric entry)**
This function is intended for prevention of accidentally entered unreasonably amounts.
Limit amount: 0.00 to 9999999.99

NOTE When the cash in drawer amounts exceeds a limit amount, the sentinel mark (X) will be displayed.

- **TEXT (Use the character entry)**
Description for the cash in drawer. Up to 12 characters can be entered.

■ Commission rate (Commission 1, Commission 2)

Procedure

COMMISSION1	
RATE	0.00%
TEXT	COM.SAL1
PGM	01

Program each item as follows:

- **RATE (Use the numeric entry)**
Commission rate (0.00 to 999.99)
- **TEXT (Use the character entry)**
Description for the commission rate.
Up to 12 characters can be entered.

Media Key Programming

Use the following procedure to select any option included in the media group:

Procedure

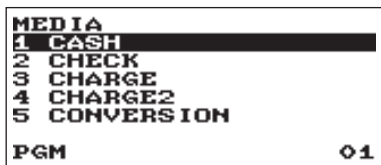
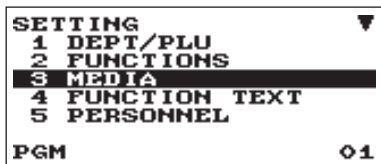

1. In the SETTING window, select “3 MEDIA.”
 - The MEDIA window will appear.

2. Select any option from the following options list.

1	CASH	Cash
2	CHECK	Check
3	CHARGE	Charge
4	CHARGE2	Charge 2
5	CONVERSION	Currency conversion

The following illustration shows those options included in this programming group.

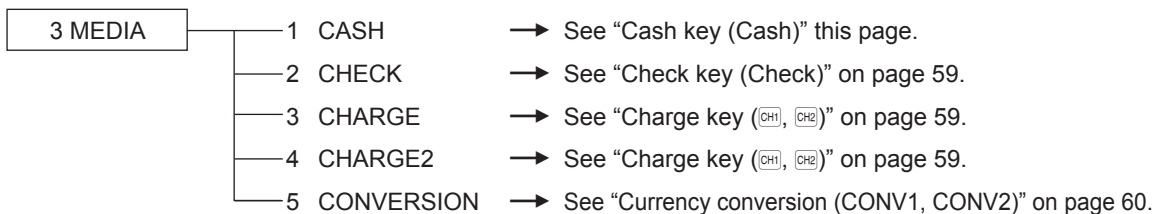

■ Cash key (Cash)

Procedure

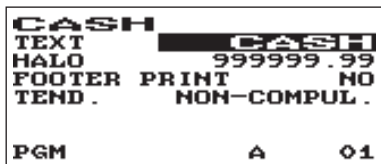

Program each item as follows:

- **TEXT (Use the character entry)**
Description for the cash key. Up to 12 characters can be entered.
- **HALO (High Amount Lockout) (Use the numeric entry)**
This function is intended for prevention of accidentally entered unreasonably amounts.
Limit amount: 0.00 to 999999.99
- **FOOTER PRINT (Use the selective entry)**
This item decides whether or not your register should print a message at the foot of a receipt when a specified cash key is used.
YES: Enables footer printing on the receipt.
NO: Disables footer printing on the receipt.
- **TEND. (Use the selective entry)**
NON-COMPUL.: Non-compulsory amount tendered entry.
COMPULSORY: Compulsory amount tendered entry.

■ Check key (Check)

Procedure

```
CHECK          CHECK
TEXT          ██████████
HALO          999999.99
FOOTER PRINT NO
TEND .       NON-COMPUL .

PGM          A    01
```

Program each item as follows:

- **TEXT (Use the character entry)**
Description for the check key. Up to 12 characters can be entered.
- **HALO (High Amount Lockout) (Use the numeric entry)**
This function is intended for prevention of accidentally entered unreasonably amounts.
Limit amount: 0.00 to 999999.99
- **FOOTER PRINT (Use the selective entry)**
YES: Enables footer printing on the receipt.
NO: Disables footer printing on the receipt.
- **TEND. (Use the selective entry)**
NON-COMPUL.: Non-compulsory amount tendered entry.
COMPULSORY: Compulsory amount tendered entry.

■ Charge key (CH1, CH2)

Procedure

```
CHARGE        CHARGE
+TEXT        ██████████
-TEXT        CHARGE-
HALO        999999.99
FOOTER PRINT NO
TEND .       INHIBITED

PGM          A    01
```

Program each item as follows:

- **+TEXT (Use the character entry)**
Description for the gross charge. Up to 12 characters can be entered.
- **-TEXT (Use the character entry)**
Description for the refund charge. Up to 12 characters can be entered.
- **HALO (High Amount Lockout) (Use the numeric entry)**
This function is intended for prevention of accidentally entered unreasonably amounts.
Limit amount: 0.00 to 999999.99
- **FOOTER PRINT (Use the selective entry)**
This item decides whether or not your register should print a message at the foot of a receipt when a specified charge key is used.
YES: Enables footer printing on the receipt.
NO: Disables footer printing on the receipt.
- **TEND. (Use the selective entry)**
COMPULSORY: Compulsory amount tendered entry.
INHIBITED: Inhibits amount tendered entry.

■ Currency conversion (CONV1, CONV2)

Procedure

```

CONVERSION          ▾
PRESET RATE        ENABLE
RATE               0.000000
TEXT              CONV 1
SYMBOL
TAB               2
OPEN RATE         ENABLE
PGM               01
    
```

The screen continues.

Program each item as follows:

- **PRESET RATE (Use the selective entry)**
 ENABLE: Enables preset rate
 DISABLE: Disable preset rate
- **RATE (Use the numeric entry)**
 Currency exchange rate (0.000000 to 999.999999)
- **TEXT (Use the character entry)**
 Description for the currency exchange key. Up to 12 characters can be entered.
- **SYMBOL (Use the character entry)**
 Currency descriptor. Up to 4 characters can be entered.
- **TAB (Use the selective entry)**
 Tabulation (0 to 3)
- **OPEN RATE (Use the selective entry)**
 ENABLE: Enables open rate
 DISABLE: Disable open rate
- **TEXT (Use the character entry) for the open rate**
 Description for the currency exchange key for the open rate.
 Up to 12 characters can be entered.
- **SYMBOL (Use the character entry) for the open rate**
 Currency descriptor for the open rate. Up to 4 characters can be entered.
- **TAB (Use the selective entry) for the open rate**
 Tabulation (0 to 3) for the open rate

NOTE

*Currency symbol is printed with (+) amount of foreign currency.
 The programmed character is printed at left side of amount.*

EX) Case of "EURO":

```

CONV1    1.234567
          EURO 1.23
    
```

↑
 Programmed symbol

Function Text Programming

You can program a maximum of 12 characters for each function by using the following table:

Procedure

```

SETTING
1 DEPT/PLU
2 FUNCTIONS
3 MEDIA
4 FUNCTION TEXT
5 PERSONNEL
PGM                                01
    
```



```

FUNCTION TEXT
1 NET1
2 TAX1 ST
3 GRS TAX1
4 RFD TAX1
5 TAX1
PGM                                01
    
```

The screen continues.

1. In the SETTING window, select "4 FUNCTION TEXT".
 - The FUNCTION TEXT window will appear.

2. Program each item as follows:
 - **Text (Use the character entry)**
Description for each function. Up to 12 characters can be entered.

List of function text

No.	Function	Default text
1	Net sales total	NET1
2	Net taxable 1 subtotal	TAX1 ST
3	Gross tax 1 total	GRS TAX1
4	Tax 1 total of refund entries	RFD TAX1
5	Net tax 1 total	TAX1
6	Exempt tax 1	TX1 EXPT
7	Net taxable 2 subtotal	TAX2 ST
8	Gross tax 2 total	GRS TAX2
9	Tax 2 total of refund entries	RFD TAX2
10	Net tax 2 total	TAX2
11	Exempt tax 2	TX2 EXPT
12	Net taxable 3 subtotal	TAX3 ST
13	Gross tax 3 total	GRS TAX3
14	Tax 3 total of refund entries	RFD TAX3
15	Net tax 3 total	TAX3
16	Exempt tax 3	TX3 EXPT
17	Net taxable 4 subtotal	TAX4 ST
18	Gross tax 4 total	GRS TAX4
19	Tax 4 total of refund entries	RFD TAX4
20	Net tax 4 total	TAX4
21	Exempt tax 4	TX4 EXPT
22	Gross manual tax total	GRS MTAX
23	Refund manual tax total	RFD MTAX
24	Tax total (on report)	TTL TAX
25	Net	NET

No.	Function	Default text
26	Sales total including tax total	NET2
27	Refund	REFUND
28	Item void	VOID
29	Void mode	VOID
30	Manager void	MGR VOID
31	Subtotal void	SBTL VOID
32	No sale	NO SALE
33	Transaction counter	TRANS CT
34	Net 3 (sales total, paid total)	NET3
35	Cash + check in drawer	CA+CHK ID
36	Check change	CHK/CG
37	(+) department total	*DEPT TL
38	(-) department total	DEPT(-)
39	(+) Bottle return dept. total	*BTTL TL
40	(-) Bottle return dept. total	BTTL(-)
41	Group 1	GROUP01
42	Group 2	GROUP02
43	Group 3	GROUP03
44	Group 4	GROUP04
45	Group 5	GROUP05
46	Group 6	GROUP06
47	Group 7	GROUP07
48	Group 8	GROUP08
49	Group 9	GROUP09
50	Commission amount 1	COM. AMT1

No.	Function	Default text
51	Commission amount 2	COM. AMT2
52	Commission amount total	COM. TTL
53	Non commission sale	NON COM.
54	Items	ITEMS
55	Merchandise subtotal	MDSE ST
56	Subtotal	SUBTOTAL
57	Total	***TOTAL
58	Change	CHANGE
59	Non add symbol (max. 8 characters)	#

No.	Function	Default text
60	Copy receipt title	COPY
61	Due (only display)	DUE
62	Receipt SW	RCP SW.
63	Non GST subtotal	GST EXPT
64	PST total	PST TTL
65	GST total	GST TTL
66	VAT exempt (for doughnut tax type 1)	VAT EXPT
67	Total tax (on receipt)	TOTAL TAX

Personnel Programming

Use the following procedure to select any option included in the personnel group:

Procedure

```

SETTING
1 DEPT/PLU
2 FUNCTIONS
3 MEDIA
4 FUNCTION TEXT
5 PERSONNEL
PGM 01
    
```



```

PERSONNEL
1 CLERK
2 MANAGER
3 MODE PASS CODE
4 TRAINING CLK
PGM 01
    
```

1. In the SETTING window, select "5 PERSONNEL."
 • The PERSONNEL window will appear.

2. Select any option from the following options list.

1	CLERK	Clerk
2	MANAGER	Manager
3	MODE PASS CODE	Mode Pass Code
4	TRAINING CLK	Training Clerk

The following illustration shows those options included in this programming group.

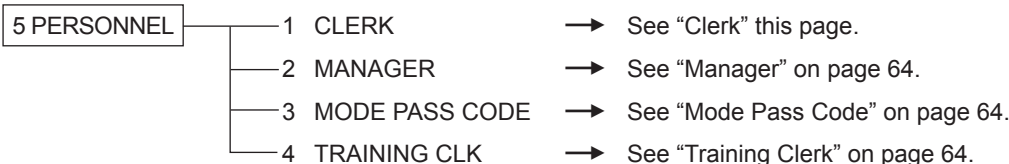

■ Clerk

Procedure

```

CLERK
01 CLERK01
02 CLERK02
03 CLERK03
04 CLERK04
PGM 01
    
```

Select a clerk code, or directly enter a clerk code.



```

01
PASS CODE 0000
AUTO KEY  CLERK01
          ENABLE
PGM 01
    
```

Program each item as follows:

- **PASS CODE (Use the numeric entry)**
 Pass code (max. 4 digits: 0001 to 9999/0000)
- **Text (Use the character entry)**
 Description for the clerk name (Up to 16 characters can be entered.)
- **AUTO KEY (Use the selective entry)**
 ENABLE: Enables operation of the key.
 DISABLE: Disables operation of the key.

NOTE To delete a clerk code in the "CLERK" window, select the clerk code and press the key. A confirmation window appears to ask you whether to delete the clerk, select the option you prefer.

■ Manager

You can program a secret code for manager.

Procedure

```
MANAGER
PASS CODE 0000

PGM 01
```

Program each item as follows:

- **PASS CODE (Use the numeric entry)**
Pass code (max. 4 digits: 0000 to 9999)

■ Mode Pass Code

You can program a secret code for each mode.

Procedure

```
MODE PASS CODE
VOID MODE 0000
OPX2      0000
VIEW REPORT 0000
X1        0000
Z1        0000
X2Z2     0000
PGM      01
```

The screen continues.

Program each item as follows:

- **VOID MODE (Use the numeric entry)**
Pass code (max 4 digits: 0000 to 9999)
- **OPXZ (Use the numeric entry)**
Pass code (max 4 digits: 0000 to 9999)
- **VIEW REPORT (Use the numeric entry)**
Pass code (max 4 digits: 0000 to 9999)
- **X1 (Use the numeric entry)**
Pass code (max 4 digits: 0000 to 9999)
- **Z1 (Use the numeric entry)**
Pass code (max 4 digits: 0000 to 9999)
- **X2Z2 (Use the numeric entry)**
Pass code (max 4 digits: 0000 to 9999)
- **PROGRAM (Use the numeric entry)**
Pass code (max 4 digits: 0000 to 9999)
- **SD CARD (Use the numeric entry)**
Pass code (max 4 digits: 0000 to 9999)

■ Training Clerk

You can set the training clerk code and text for the training mode title.

Procedure

```
TRAINING CLK
CODE 00
TEXT TRAINING

PGM 01
```

Program each item as follows:

- **CODE (Use the numeric entry)**
Clerk code in training (max. 2 digits: 00 to 40)
- **TEXT (Use the character entry)**
Description for the training mode title (Up to 12 characters can be entered.)

Terminal Programming

Use the following procedure to select any option included in the terminal group:

Procedure

```
SETTING          ▲▼
 6 TERMINAL
 7 DATE/TIME
 8 OPTIONAL
 9 REPORT
10 MESSAGE
PGM              01
```



```
TERMINAL
MACHINE#        000000
CONSECUTIVE#    000000
GT2              0.00
GT3              0.00
PGM              01
```

1. In the SETTING windows, select "6 TERMINAL."
 - The TERMINAL windows will appear.

2. Select any option from the following options list:
 - **MACHINE# (Use the numeric entry)**
Machine number (max. 6 digits: 0 to 999999)
 - **CONSECUTIVE# (Use the numeric entry)**
Enter a number (max. 6 digits: 0 to 999999) that is the desired starting number.
 - **GT2 (Use the numeric entry)**
Enter a number (max. 13 digits: 0 to 9999999999999)
 - **GT3 (Use the numeric entry)**
Enter a number (max. 13 digits: 0 to 9999999999999)

Date/Time Setting

You can set the date and time for the register.

■ Date/time

Procedure

```
SETTING          ▲▼
 6 TERMINAL
 7 DATE/TIME
 8 OPTIONAL
 9 REPORT
10 MESSAGE
PGM              01
```



```
DATE/TIME
DATE            01/01/11
TIME (24HR)    0000
PGM              01
```

1. In the SETTING window, select "7 DATE/TIME".
 - The DATE/TIME window will appear.

2. Set each item as follows:
 - **DATE (Use the numeric entry)**
Enter the month (2 digits), day (2 digits), and year (2 digits) in this sequence.
 - **TIME (24HR) (Use the numeric entry)**
Set the time (max. 4 digits) on the 24-hour system. For example, when the time is set to 2:30 AM, enter 0230; and when it is set to 2:30 PM, enter 1430. The time will be printed and displayed.

Optional Feature Selection

Use the following procedure to select any option included in the optional group:

Procedure

```

SETTING          ▲▼
 6 TERMINAL
 7 DATE/TIME
 8 OPTIONAL
 9 REPORT
10 MESSAGE
PGM              01
    
```



```

OPTIONAL        ▼
 1 BASIC SYSTEM
 2 FUNC.PROHIBIT
 3 FUNC.AUTHORITY
 4 FUNCTION SELECT
 5 PRINT SELECT
PGM              01
    
```

The screen continues.

1. In the SETTING window, select "8 OPTIONAL."
 - The OPTIONAL window will appear.

2. Select any option from the following options list.

1	BASIC SYSTEM	Basic system
2	FUNC.PROHIBIT	Function prohibited
3	FUNC.AUTHORITY	Function authority
4	FUNCTION SELECT	Function selection
5	PRINT SELECT	Print selection
6	UPC FUNCTION	UPC function

The following illustration shows those options included in this programming group.

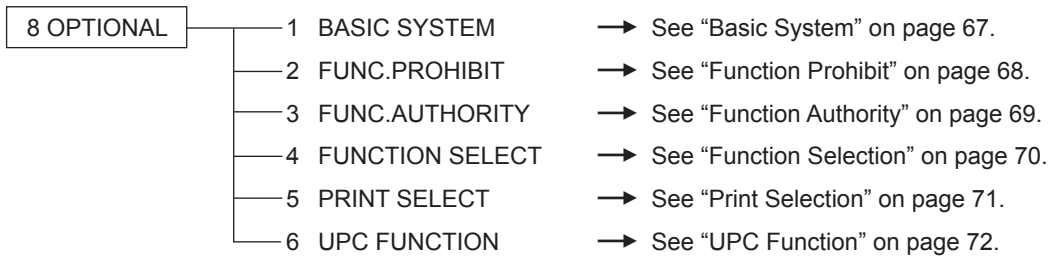

■ Basic System

Your register allows you to select various item of basic system.

Procedure

```
BASIC SYSTEM          ▼
DATE FORMAT          MDY
TIME FORMAT      12-HOUR
ERROR              LOCK ERROR
CURRENCY SYMBOL    $
TAB                2
DECIMAL QUANTITY  YES
PGM                01
```

The screen continues.

Program each item as follows:

• DATE FORMAT (Use the selective entry)

MDY: Display and print the month, day, and year in this order

DMY: Display and print the day, month and year in this order

YMD: Display and print the year, month, and day in this order

• TIME FORMAT (Use the selective entry)

12-HOUR: Display and print the time on 12-hour system

24-HOUR: Display and print the time on 24-hour system

• ERROR (Use the selective entry)

Response to an erroneous, invalid key operation

LOCK ERROR: Sound a short buzzer for 2 seconds, and display Error. To hide the Error display, press the **CL** key.

MISS OPE.: Sound a short buzzer

• CURRENCY SYMBOL (Use the character entry)

Enter the character (Max. 4 characters)

• TAB (Use the selective entry)

- | | | |
|---|---|--|
| 0 | } | Position of price delimiter can be set. Setting options are 0, 1, 2, and 3.
When setting to "2" for example, the entry of "100" is displayed as "1.00". |
| 1 | | |
| 2 | | |
| 3 | | |

• DECIMAL QUANTITY (Use the selective entry)

YES: Enables the decimal quantity

NO: Disables the decimal quantity

• DECIMAL ROUND (Use the selective entry)

ROUND: Round off the number

UP: Round up after the decimal point

DOWN: Round down after the decimal point.

• [00] KEY (Use the selective entry)

[00]: Display [00] by pressing the **00** key

[000]: Display [000] by pressing the **00** key

• PRT/DSP EDIT (Use the selective entry)

YES: All of printing and display are edited

NO: All of printing and display aren't edited

• ITEM DISPLAY (Use the selective entry)

2-LINE: The 1st line displays the quantity, price and amount. The 2nd line displays the text.

1-LINE: The quantity and text.

■ Function Prohibit

Your register allows you to select whether to enable or disable various functions.

Procedure

FUNC . PROHIBIT	▼
NON-ADD	ENABLE
NON-ADD + NS	ENABLE
MINUS DEPT	ENABLE
COPY RCPT	ENABLE
VOID MODE	ENABLE
SUBTOTAL<0	ENABLE
PGM	01

The screen continues.

Program each item as follows:

- **NON-ADD (Use the selective entry)**
 - ENABLE: Enable to enter Non-add code
 - DISABLE: Disable to enter Non-add code
- **NON-ADD + NS (Use the selective entry)**
 - ENABLE: Enable No sale after Non-add code entry
 - DISABLE: Disable No sale after Non-add code entry
- **MINUS DEPT (Use the selective entry)**
 - ENABLE: Enable to enter the minus department
 - DISABLE: Disable to enter the minus department
- **COPY RCPT (Use the selective entry)**
 - ENABLE: Enable the receipt copy function
 - DISABLE: Disable the receipt copy function
- **VOID MODE (Use the selective entry)**
 - ENABLE: Enable the void mode
 - DISABLE: Disable the void mode
- **SUBTOTAL<0 (Use the selective entry)**
 - ENABLE: Enable to go negative merchandise subtotal
 - DISABLE: Disable to go negative merchandise subtotal
- **TEND+DIRECT (Use the selective entry)**
 - ENABLE: Enable the direct non-tendering finalization after the previous tender entry
 - DISABLE: Disable the direct non-tendering finalization after the previous tender entry

■ Function Authority

Your register allows you to select whether to public or to limit function authority.

Procedure

```
FUNC . AUTHORITY
RA          PUBLIC
PO          PUBLIC
REFUND     PUBLIC
ITEM VD    PUBLIC
SBTL VD    PUBLIC
NO SALE    PUBLIC
PGM                01
```

The screen continues.

Program each item as follows:

- **RA (Use the selective entry)**

LIMITED: Allowed only in the Manager mode.

PUBLIC: Allowed in the REG mode and the Manager mode.

- **PO (Use the selective entry)**

LIMITED: Allowed only in the Manager mode.

PUBLIC: Allowed in the REG mode and the Manager mode.

- **REFUND (Use the selective entry)**

LIMITED: Allowed only in the Manager mode.

PUBLIC: Allowed in the REG mode and the Manager mode.

- **ITEM VD (Use the selective entry)**

LIMITED: Allowed only in the Manager mode.

PUBLIC: Allowed in the REG mode and the Manager mode.

- **SBTL VD (Use the selective entry)**

LIMITED: Allowed only in the Manager mode.

PUBLIC: Allowed in the REG mode and the Manager mode.

- **NO SALE (Use the selective entry)**

LIMITED: Allowed only in the Manager mode.

PUBLIC: Allowed in the REG mode and the Manager mode.

- **TAX DELETE (Use the selective entry)**

LIMITED: Allowed only in the Manager mode.

PUBLIC: Allowed in the REG mode and the Manager mode.

- **MANUAL TAX (Use the selective entry)**

LIMITED: Allowed only in the Manager mode.

PUBLIC: Allowed in the REG mode and the Manager mode.

■ Function Selection

Your register enables you to select various functional selections.

Procedure

```
FUNCTION SELECT  ▾
SPLIT ENTRY  DISABLE
SPLIT COUNT  QUANTITY
VD MODE TO HOURLY NO
ST BEFORE DIRECT NOT
ST BEFORE TEND  NOT
NS RECEIPT      PRINT
PGM              01
```

The screen continues.

Program each item as follows:

- **SPLIT ENTRY (Use the selective entry)**
 - ENABLE: Enable the split pricing entry
 - DISABLE: Disable the split pricing entry
- **SPLIT COUNT (Use the selective entry)**
 - Count method of split pricing entry.
 - PACKAGE: Unit of the package
 - QUANTITY: Quantity
- **VD MODE TO HOURLY (Use the selective entry)**
 - YES: Enable to add to the hourly total in void mode.
 - NO: Disable to add to the hourly total in void mode.
- **ST BEFORE DIRECT (Use the selective entry)**
 - Subtotal entry before direct non-tendering finalization
 - NOT: Not to require entry of subtotal for the non-tendering finalization
 - MUST: Require entry of subtotal for the non-tendering finalization
- **ST BEFORE TEND (Use the selective entry)**
 - Subtotal entry before tender
 - NOT: Not to require entry of subtotal for the tendering finalization
 - MUST: Require entry of subtotal for the tendering finalization
- **NS RECEIPT (Use the selective entry)**
 - Printing the receipt at the time of No Sale
 - PRINT: Print the receipt
 - NOT: Not to print the receipt
- **AFTER TRANS. (Use the selective entry)**
 - TOTAL: Print the total only on the after transaction receipt
 - DETAIL: Print the details on the after transaction receipt

■ Print Selection

You can program various printing functions.

Procedure

```
PRINT SELECT          ▼
CONSECUTIVE NO.     YES
DATE                 YES
TIME                 YES
PURCHASE NO.        YES
TAX STATUS           YES
TAX                  1 to 4
PGM                  01
```

The screen continues.

Program each item as follows:

- **CONSECUTIVE NO. (Use the selective entry)**
 - YES: Print the consecutive No.
 - NO: Not to print the consecutive No.
- **DATE (Use the selective entry)**
 - YES: Print the date
 - NO: Not to print the date
- **TIME (Use the selective entry)**
 - YES: Print the time
 - NO: Not to print the time
- **PURCHASE NO. (Use the selective entry)**
 - YES: Print the number of the purchase No.
 - NO: Not to print the number of the purchase No.
- **TAX STATUS (Use the selective entry)**
 - YES: Print the tax status
 - NO: Not to print the tax status
- **TAX (Use the selective entry)**
 - Tax print format
 - 1 to 4: Print order tax1 to tax4
 - 4 to 1: Print order tax4 to tax1
 - TOTAL: Print total tax
- **TAX (TAXABLE=0) (Use the selective entry)**
 - YES: Print the tax amount (when the taxable amount is zero.)
 - NO: Not to print the tax amount (when the taxable amount is zero.)
- **TAX (TAX=0) (Use the selective entry)**
 - YES: Print the tax amount (when the tax amount is zero.)
 - NO: Not to print the tax amount (when the tax amount is zero.)
- **ST AT ST KEY (Use the selective entry)**
 - YES: Print the subtotal using the key
 - NO: Not to print the subtotal using the key
- **LOGO FORM (Use the selective entry)**
 - PATTERN 1: 3 line text header
 - PATTERN 2: Image logo header
 - PATTERN 3: Image logo header + 3 line text footer
 - PATTERN 4: 6 line text header
 - PATTERN 5: Image logo header + 3 line text header
 - PATTERN 6: 3 line text header + 3 line text footer

• **FOOTER (Use the selective entry)**

ALL: Print the footer in any media
BY MEDIA: Print the footer by media

• **0 AMT PLU (Use the selective entry)**

When the PLU unit price is 0, printing the amount is:
TEXT ONLY: Print the text only
NORMAL: Print the price and the text

• **ITEM JOURNAL (Use the selective entry)**

ALL: Print all items on journal
SELECT: Print the selected items other than "+"
dept./PLU/UPC on journal (summary journal)

• **LOGO ON JOURNAL (Use the selective entry)**

YES: Print the logo text on journal
NO: Not to print the logo text on journal

• **CONV. SHORT TEND (Use the selective entry)**

PRINT: Print subtotal after short tendering by currency conversion
NOT: Not to print subtotal after short tendering by currency conversion

• **GST VAT PRINT (Use the selective entry)**

YES: Print the tax when the GST is VAT
NO: Not to print the tax when the GST is VAT

■ UPC Function

Procedure

```
UPC FUNCTION
LEARNING      ENABLE
LOOKUP AT RF  YES
CODE PRINT    NO
C/D CHECK     NO
ISBN/ISSN PRICE CMP .
PGM           01
```

Program each item as follows:

• **LEARNING (Use the selective entry)**

ENABLE: Enables the UPC learning function
DISABLE: Disables the UPC learning function

• **LOOKUP AT RF (Use the selective entry)**

YES: Enables to look up the price at refund entry of PLUs/UPCs
NO: Disables to look up the price at refund entry of PLUs/UPCs

• **CODE PRINT (Use the selective entry)**

R&J: Print the UPC code on receipt and journal
J: Print the UPC code on journal
R: Print the UPC code on receipt
NO: Not to print the UPC code

• **C/D CHECK (Use the selective entry)**

YES: Check the check digit of UPC codes at entries
NO: Not to check the check digit

• **ISBN/ISSN (Use the selective entry)**

PRICE CMP.: Compulsory the price entry after ISBN or ISSN code
INHIBITED: Inhibited the price entry after ISBN or ISSN code

Report Programming

Use the following procedure to select any option included in the report group:

Procedure

```
SETTING ▲▼
6 TERMINAL
7 DATE/TIME
8 OPTIONAL
9 REPORT
10 MESSAGE
PGM ◊1
```



```
REPORT
1 0 SKIP
2 PRINT SELECT
3 Z COUNTER
4 Z1 GENERAL REPORT
5 JOURNAL
PGM ◊1
```

1. In the SETTING window, select "9 REPORT."
 - The REPORT window will appear.

2. Select any option from the following options list:

1	0 SKIP	Zero skip
2	PRINT SELECT	Print select
3	Z COUNTER	Z counter
4	Z1 GENERAL REPORT	Z1 General report
5	JOURNAL	Journal data

The following illustration shows those options included in this programming group.

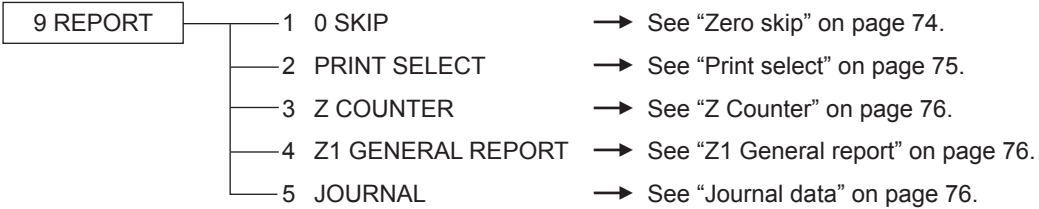

■ Zero skip

You can program whether or not to skip "0" in each report.

Procedure

0 SKIP	SKIP
DEPARTMENT	SKIP
TRANSACTION	SKIP
PLU	SKIP
CLERK	SKIP
HOURLY	SKIP
DAILY NET	SKIP
PGM	01

Program each item as follows:

- **DEPARTMENT (Use the selective entry)**
 - SKIP: Skips those data that are "0" in the department report.
 - NOT SKIP: Does not skip those data that are "0" in the department report.
- **TRANSACTION (Use the selective entry)**
 - SKIP: Skips those data that are "0" in the transaction report.
 - NOT SKIP: Does not skip those data that are "0" in the transaction report.
- **PLU (Use the selective entry)**
 - SKIP: Skips those data that are "0" in the PLU/UPC report.
 - NOT SKIP: Does not skip those data that are "0" in the PLU/UPC report.
- **CLERK (Use the selective entry)**
 - SKIP: Skips those data that are "0" in the clerk report.
 - NOT SKIP: Does not skip those data that are "0" in the clerk report.
- **HOURLY (Use the selective entry)**
 - SKIP: Skips those data that are "0" in the hourly report.
 - NOT SKIP: Does not skip those data that are "0" in the hourly report.
- **DAILY NET (Use the selective entry)**
 - SKIP: Skips those data that are "0" in the daily net report.
 - NOT SKIP: Does not skip those data that are "0" in the daily net report.

■ Print select

You can program whether or not to print the item on the report.

Procedure

```
PRINT SELECT          ▼
Z COUNTER             YES
GT1 ON Z              YES
GT2 ON Z              YES
GT3 ON Z              YES
TR GT ON Z           YES
VD MODE ON X1Z1      YES
PGM                   01
```

The screen continues.

Program each item as follows:

- **Z COUNTER (Use the selective entry)**
YES: Print the Z counter on the Z report.
NO: Not to print the Z counter on the Z report.
- **GT1 ON Z (Use the selective entry)**
YES: Print GT1 on the Z report.
NO: Not to print GT1 on the Z report.

- **GT2 ON Z (Use the selective entry)**
YES: Print GT2 on the Z report.
NO: Not to print GT2 on the Z report.
- **GT3 ON Z (Use the selective entry)**
YES: Print GT3 on the Z report.
NO: Not to print GT3 on the Z report.
- **TR GT ON Z (Use the selective entry)**
YES: Print the training GT on the Z report.
NO: Not to print the training GT on the Z report.
- **VD MODE ON X1Z1 (Use the selective entry)**
YES: Print total of VOID MODE on X1Z1 report
NO: Not to print total of VOID MODE on X1Z1 report
- **VD MODE ON X2Z2 (Use the selective entry)**
YES: Print total of VOID MODE on X2Z2 report
NO: Not to print total of VOID MODE on X2Z2 report
- **PLU/UPC DATA ON Z (Use the selective entry)**
YES: Print PLU/UPC data on the PLU/UPC Z report.
NO: Not to print PLU/UPC data on the PLU/UPC Z report.
- **JOURNAL SIZE (Use the selective entry)**
SMALL: Print journal in a small size.
NORMAL: Print journal in a normal size.
- **GST EXEMPT ON XZ (Use the selective entry)**
YES: Print GST EXEMPT data on X/Z report.
NO: Not to print GST EXEMPT data on X/Z report.

■ Z Counter

Procedure

```
Z COUNTER
GENERAL Z1      0000
GENERAL Z2      0000

PGM                                01
```

GENERAL Z1: Max.4 digits (0000 to 9999)

GENERAL Z2: Max.4 digits (0000 to 9999)

■ Z1 General report

Procedure

```
Z1 GENERAL REPORT
SD: SAVE SALES      IO
SD: SAVE ALL RAM    NO
RESET GT            NO

PGM                                01
```

• **SD: SAVE SALES (Use the selective entry)**

YES: Save the sales data in the SD card.

NO: Not to save the sales data in the SD card.

• **SD: SAVE ALL RAM (Use the selective entry)**

YES: Save the all RAM data in the SD card.

NO: Not to save the all RAM data in the SD card.

• **RESET GT (Use the selective entry)**

YES: Reset the GT

NO: Not to reset the GT

■ Journal data

Procedure

```
JOURNAL
TR DATA STORE     YES
X DATA STORE      HEADER

PGM                                01
```

• **TR DATA STORE (Use the selective entry)**

YES: Record the journal data in the training mode.

NO: Not to record the journal data in the training mode.

• **X DATA STORE (Use the selective entry)**

When the X report data in the journal is recorded:

HEADER: Record only the header of X report in the journal

DETAIL: Record the detail of X report in the journal

Message Programming

Use the following procedure to select any option included in the message group:

Procedure

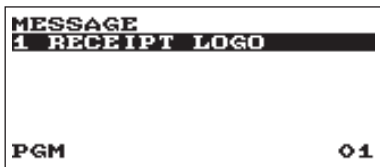

1. In the SETTING window, select "10 MESSAGE."
 - The MESSAGE window will appear.

2. Select any option from the following options list:

1 RECEIPT LOGO Receipt logo

The following illustration shows those options included in this programming group.



■ Receipt logo

Your register can print programmed messages for customers on every receipt. The logo text is printed in a centering form on the receipt.

Procedure

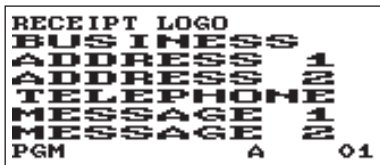

Program each item as follows:

- **RECEIPT LOGO (Use the character entry)**
 Logo text for the receipt (max. 30 characters x 6 lines)

NOTE

- The programmable number of lines for a message varies according to the following message types:
 - PATTERN 1: 3 line text header
 - PATTERN 2: Image logo header
 - PATTERN 3: Image logo header + 3 line text footer
 - PATTERN 4: 6 line text header
 - PATTERN 5: Image logo header + 3 line text header
 - PATTERN 6: 3 line text header + 3 line text footer
- For the footer printing, a series of "=" (character code: 061)" character (over 4 characters) will be replaced with a clerk name in present use.

Device Configuration Programming

Use the following procedure to select a device configuration programming:

Procedure



The screen continues.

1. In the SETTING window, select "11 DEVICE CONFIG."
 - The DEVICE CONFIG window will appear.

2. Select any option from the following options list:

1	KEYBOARD	Keyboard
2	DISPLAY	Display
3	PRINTER	Printer
4	EFT	EFT
5	RS PORT	RS port (COM1, COM2)
6	ONLINE	On-line
7	SCANNER	Scanner
(7)	SRM	SRM (Sales Recording Module))

The following illustration shows those options included in this programming group.

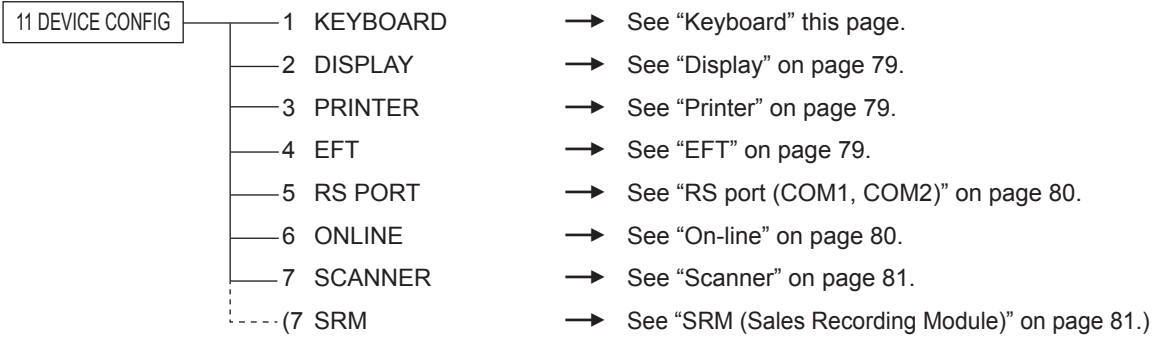

NOTE

- The EFT function is not appeared in the Quebec fiscal type.
- The SRM function is appeared in the Quebec fiscal type only.
- For enable/disable of the Quebec fiscal mode, please contact your authorized SHARP dealer.

Keyboard

Procedure



Program each item as follows:

- **BUFFERING (Use the selective entry)**
 YES: Enables the buffering keyboard.
 NO: Disables the buffering keyboard.
- **TOUCH SOUND (Use the selective entry)**
 YES: Set to sound
 NO: Not to sound

■ Display

Procedure

```
DISPLAY          02
POWER SAVE      YES
P.SAVE AT TM
PGM             01
```

Program each item as follows:

- **POWER SAVE (Use the numeric entry)**
Time of the power save (2 digits: 0,1 to 99 minutes 0:100 minutes)
- **P. SAVE AT TM (Use the selective entry)**
Power saving during time display:
YES: Enables power saving during time display
NO: Disables power saving during time display

■ Printer

Procedure

```
PRINTER
DENSITY          50
PGM             01
```

Program each item as follows:

- **DENSITY (Use the numeric entry)**
Select a density level (2 digits: 00 to 99)
00: 89% for standard
50: 100% for standard
99: 111% for standard

■ EFT

Procedure

```
EFT
CHARGE           NOT
TIME OUT1        010
TIME OUT2        099
TIME OUT3        0099
PGM             01
```

Program each item as follows:

- **CHARGE (Use the selective entry)**
USED: Credit/Debit
NOT: Not to assign for credit/debit.
- **TIME OUT1 (Use the numeric entry)**
Time out timer for ACK/NAK
(3 digits: 1 to 255 (sec))
- **TIME OUT2 (Use the numeric entry)**
Time out timer for response of authorization
(3 digits: 1 to 255 (sec))
- **TIME OUT3 (Use the numeric entry)**
Time out timer for batch close
(4 digits: 1 to 3000 (sec))

NOTE

- The EFT function is not appeared in the Quebec fiscal type.
- For enable/disable of the Quebec fiscal mode, please contact your authorized SHARP dealer.

■ RS port (COM1, COM2)

Procedure

```

RS PORT
PORT 1      SCANNER
PORT 2      ONLINE

PGM                                01
  
```

Program each item as follows:

• PORT 1 (Use the selective entry)

EFT: EFT
 ONLINE: On-line
 SCANNER: Scanner

• PORT 2 (Use the selective entry)

EFT: EFT
 ONLINE: On-line

NOTE For the Quebec fiscal type is as follows.

Procedure

```

RS PORT
PORT 1      SCANNER
PORT 2      ONLINE

PGM                                01
  
```

Program each item as follows:

• PORT 1 (Use the selective entry)

SRM: SRM (ECR → SRM → Printer)
 CONTINUOUS: Disconnection of the SRM (ECR → Printer)
 ONLINE: On-line
 SCANNER: Scanner

• PORT 2 (Use the selective entry)

SRM: SRM (ECR → SRM → Printer)
 CONTINUOUS: Disconnection of the SRM (ECR → Printer)
 ONLINE: On-line

■ On-line

Procedure

```

ONLINE
TERMINAL No. 000000
CI SIGNAL    NON
LINE FORM    FULL
BAUD RATE    19200
START CODE   002
END CODE     013
PGM          01
  
```

Program each item as follows:

• TERMINAL No. (Use the numeric entry)

Terminal number (6 digits: 0 to 999999).

• CI SIGNAL (Use the selective entry)

Sensing of the CI signal
 NON: Disables sensing of the CI signal
 SENSING: Enables sensing of the CI signal

The screen continues.

• LINE FORM (Use the selective entry)

Programming of the modem control
 FULL: Full duplex system
 HALF: Half duplex system

• BAUD RATE (Use the selective entry)

Transmission data rate
 38400 bps 19200 bps
 9600 bps 4800 bps

• START CODE (Use the numeric entry)

Start code (3 digits: 0 to 127)

• END CODE (Use the numeric entry)

End code (3 digits: 0 to 127)

• TIME OUT (Use the numeric entry)

Programming of the time-out time (3 digits: 1 to 255 sec.)

Scanner

Procedure

```

SCANNER
BAUD RATE      4800
DATA BIT       7 bits
PARITY         ODD
STOP BIT       1 bit
ITF14         W LENGTH
PGM           01
    
```

Program each item as follows:

- **BAUD RATE (Use the selective entry)**
Transmission data rate
19200 bps 9600 bps 4800 bps
- **DATA BIT (Use the selective entry)**
Selection of the data bit
7 bits 8 bits

- **PARITY (Use the selective entry)**
Selection of the parity bit
NON ODD EVEN
- **STOP BIT (Use the selective entry)**
Selection of the stop bit
1 bit 2 bits
- **ITF14 (Use the selective entry)**
W LENGTH: With length
W/O LENGTH: Without length

SRM (Sales Recording Module)

Procedure

```

SRM
PRINTER        T88(3)
AUTO CUT       NO
PGM           01
    
```

Program each item as follows:

- **PRINTER (Use the selective entry)**
T88(3)+LOGO
T88(3)
- **AUTO CUT (Use the selective entry)**
YES: The auto-cut function is used.
NO: The auto-cut function is not used.

NOTE

- The SRM function is appeared in the Quebec fiscal type only.
- For enable/disable of the Quebec fiscal mode, please contact your authorized SHARP dealer.

Tax Programming

Use the following procedure to select any option included in the tax group:

NOTE *The register is adapted to US and Canadian tax systems. If the Canadian tax system is required, the tax system must be changed (see page 83 for tax system selections), then program the tax rate or tax table and quantity for doughnut exempt which are described in this section.*

Prior to the entry of sales transactions, the tax programming must be performed in accordance with the laws of the state. The register is provided with programming four different tax rate. The one-tax system is sufficient to cover most areas. However, in some areas that has a separate local tax (such as a Parish tax) or a hospitality tax, the multi-tax system is useful.

If the taxable item is entered, the tax will be automatically added to merchandise subtotal according to the programmed tax status for the department. The tax can be also entered manually.

The register is provided with two types of tax programming methods. The % tax method is used for a straight percentage rate per dollar. The table tax method requires tax break information from the state or local tax offices. Use the method which is acceptable in the state. The necessary data of tax programming will be presented at local tax office.

Procedure

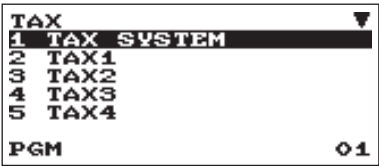

The screen continues.

1. In the SETTING window, select "12 TAX."
 • The TAX window will appear.

2. Select any option from the following options list:

- | | | |
|---|-----------------|-----------------|
| 1 | TAX SYSTEM | Tax system |
| 2 | TAX1 | Tax1 |
| 3 | TAX2 | Tax2 |
| 4 | TAX3 | Tax3 |
| 5 | TAX4 | Tax4 |
| 6 | DOUGHNUT EXEMPT | Doughnut exempt |

The following illustration shows those options included in this programming group.

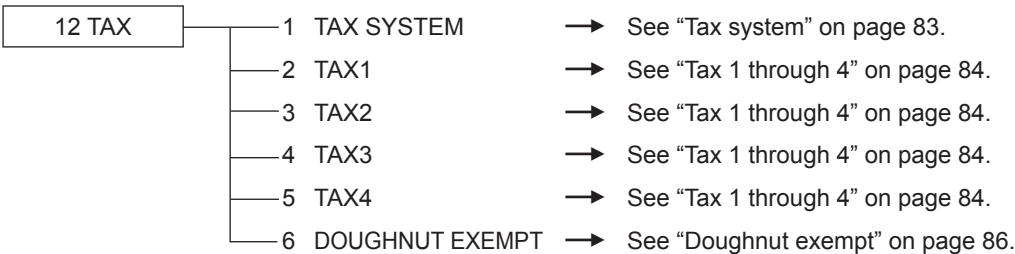

■ Tax system

Procedure

TAX SYSTEM	AUTO TAX
PGM	01

• Tax system (Use the selective entry)

Selection of the tax system

- AUTO TAX
- CANADA TAX 01
- CANADA TAX 02
- CANADA TAX 03
- CANADA TAX 04
- CANADA TAX 05
- CANADA TAX 06
- CANADA TAX 07
- CANADA TAX 08
- CANADA TAX 09
- CANADA TAX 10
- CANADA TAX 11

NOTE

Tax system:

- For US tax system, select "AUTO TAX".
- For Canadian tax, from the table below, specify a tax system suitable for your province (if necessary contact your local tax office for correct sales tax information) and for your type of retail business.

In the register, four kinds of tax can be programmed and each tax is arranged to match GST or PST as follows:

TAX1: PST, TAX2: PST, TAX3: PST or GST, TAX4: GST

(The most common type for Canada is type "CANADA TAX 06".)

	TAX1	TAX2	TAX3	TAX4
AUTO TAX	Add on tax	Add on tax	Add on tax	Add on tax
CANADA TAX 01	PST (Add on tax)*	PST (Add on tax)*	GST (VAT)	GST (VAT)
CANADA TAX 02	PST (Add on tax)	PST (Add on tax)	GST (VAT)	GST (VAT)
CANADA TAX 03	PST (Add on tax)*	PST (Add on tax)*	PST (Add on tax)*	GST (VAT)
CANADA TAX 04	PST (Add on tax)	PST (Add on tax)	PST (Add on tax)	GST (VAT)
CANADA TAX 05	PST (Add on tax)*	PST (Add on tax)*	PST (Add on tax)*	GST (Add on tax)
CANADA TAX 06	PST (Add on tax)	PST (Add on tax)	PST (Add on tax)	GST (Add on tax)
CANADA TAX 07	PST (Add on tax)*	PST (Add on tax)*	GST (VAT)	GST (Add on tax)
CANADA TAX 08	PST (Add on tax)	PST (Add on tax)	GST (VAT)	GST (Add on tax)
CANADA TAX 09	PST (Add on tax)*	PST (Add on tax)*	GST (Add on tax)	GST (Add on tax)
CANADA TAX 10	PST (Add on tax)	PST (Add on tax)	GST (Add on tax)	GST (Add on tax)
CANADA TAX 11	PST (Add on tax)*	PST (Add on tax)*	PST (VAT)	GST (VAT)

NOTE

* Tax on tax system: If the "PST taxable & GST (add on tax) taxable" item is entered, GST tax is imposed on PST tax.

■ Tax 1 through 4

Procedure

```
TAX1
1 TABLE TAX
2 %TAX

PGM                                01
```



(To the following table tax or % tax)

• Table tax

Procedure

```
TABLE TAX
1 INTERVAL LOW 0.99
2 INTERVAL OVR 1.00

PGM                                01
```



```
TABLE TAX
TAX RATE          0.0000
CYCLE              0.00
INITIAL TAX       0.00
LOWER TAX         0.00
BREAK POINT1     0.00
BREAK POINT2     0.00
PGM              01
```

The screen continues.

Selection of tax method

TABLE TAX: Programmed tax table is used.
% TAX: Programmed % tax rate is used.

Selection of the interval

• INTERVAL (Use the selective entry)

LOW 0.99: Less than 0.99 (max. 72 break points)
OVR 1.00: More than 1.00 (max. 36 break points)

Program each item as follows:

• TAX RATE (Use the numeric entry)

Tax rate (max. 7 digits: 0.0000 to 999.9999%).

• CYCLE (Use the numeric entry)

Tax table cycle (max. 4 digits: 0.01 to 99.99).

• INITIAL TAX (Use the numeric entry)

Initial tax (max. 3 digits: 0.01 to 9.99).

• LOWER TAX (Use the numeric entry)

Lowest taxable amount (max. 5 digits: 0.00 to 999.99).

• BREAK POINT1 through 72 (Use the numeric entry)

Break point amount (max. 5 digits: 0.01 to 999.99).

The programming data of tax table are as follows.

<Sample tax table>

Tax table: 6%

To program a tax table, first make a table like the right table shown below.

Taxes	Range of sales amount	
	Minimum breakpoint	Maximum breakpoint
.00	.01	to .10
.01 - T	.11 - Q	to .22
.02	.23	to .38
.03	.39	to .56
.04	.57	to .72
.05	.73	to .88
.06	.89	to 1.10
.07	.11 - M1	to 1.22
.08	1.23	to 1.38
.09	1.39	to 1.56
.10	1.57	to 1.72
.11	1.73	to 1.88
.12	1.89	to 2.10
.13	2.11 - M2	to 2.22

A: Difference between the minimum breakpoint and the next one (¢)	
-	B: Non-cyclic
10 (0.11 - 0.01)	
12 (0.23 - 0.11)	
16 (0.39 - 0.23)	
18 (0.57 - 0.39)	
16 (0.73 - 0.57)	C: Cyclic-1
16 (0.89 - 0.73)	
22 (1.11 - 0.89)	
12 (1.23 - 1.11)	
16 (1.39 - 1.23)	
18 (1.57 - 1.39)	
16 (1.73 - 1.57)	D: Cyclic-2
16 (1.89 - 1.73)	
22 (2.11 - 1.89)	

From the tax table, calculate the differences between a minimum breakpoint and the next one (A). Then, from the differences, find irregular cycles (B) and regular cycles (C and D). These cycles will show you the following items necessary to program the tax table:

- T:** The tax amount collected on the minimum taxable amount (Q) → **INITIAL TAX**
- Q:** The minimum taxable amount → **LOWER TAX**
- M1:** The maximum value of the minimum breakpoint on a regular cycle (C)
We call this point "MAX point."
- M2:** The maximum value of the minimum breakpoint on a regular cycle (D)
We call this point "MAX point."
- M:** Range of the minimum breakpoint on a regular cycle: difference between Q and M1 or between M1 and M2 → **CYCLE**

Example data of tax table (6%)

- TAX RATE:** 6.0000 (enter 6)
- CYCLE:** 1.00 (enter 100)
- INITIAL TAX:** 0.01 (enter 1)
- LOWER TAX:** 0.11 (enter 11)
- BREAK POINT1:** 0.23 (enter 23)
- BREAK POINT2:** 0.39 (enter 39)
- BREAK POINT3:** 0.57 (enter 57)
- BREAK POINT4:** 0.73 (enter 73)
- BREAK POINT5:** 0.89 (enter 89)
- BREAK POINT6:** 1.11 (enter 111)

NOTE *If the tax is not provided for every cent, modify the tax table by setting the tax for every cent in the following manner.*

When setting the tax, consider the minimum breakpoint corresponding to unprovided tax to be the same as the one corresponding to the tax provided on a large amount.

**Sample tax table
Example 8%**

Tax	Minimum breakpoint
.00	.01
.01	.11
.02	.26
.03	.47
.04	.68
.06	.89
.09	1.11
.10	1.26
.11	1.47
.12	1.68
.14	1.89
.17	2.11

Modification of the left tax table

Tax	Minimum breakpoint
.00	.01
.01 T	.11 Q
.02	.26
.03	.47
.04	.68
.05	.89
.06	.89
.07	1.11 M1
.08	1.11
.09	1.11
.10	1.26
.11	1.47
.12	1.68
.13	1.89
.14	1.89
.15	2.11 M2
.16	2.11
.17	2.11



Breakpoint difference (¢)	
1	
10 (0.11-0.01)	B: Non-cyclic
15 (0.26-0.11)	
21 (0.47-0.26)	
21 (0.68-0.47)	
21 (0.89-0.68)	
0 (0.89-0.89)	C: Cyclic-1
22 (1.11-0.89)	
0 (1.11-1.11)	
0 (1.11-1.11)	
15 (1.26-1.11)	
21 (1.47-1.26)	
21 (1.68-1.47)	
21 (1.89-1.68)	
0 (1.89-1.89)	D: Cyclic-2
22 (2.11-1.89)	
0 (2.11-2.11)	
0 (2.11-2.11)	

Example data of above tax table (8%)

- TAX RATE: 8.0000 (enter 8)
- CYCLE: 1.00 (enter 100)
- INITIAL TAX: 0.01 (enter 1)
- LOWER TAX: 0.11 (enter 11)
- BREAK POINT1: 0.26 (enter 26)
- BREAK POINT2: 0.47 (enter 47)
- BREAK POINT3: 0.68 (enter 68)
- BREAK POINT4: 0.89 (enter 89)
- BREAK POINT5: 0.89 (enter 89)
- BREAK POINT6: 1.11 (enter 111)
- BREAK POINT7: 1.11 (enter 111)
- BREAK POINT8: 1.11 (enter 111)

• % Tax

Procedure

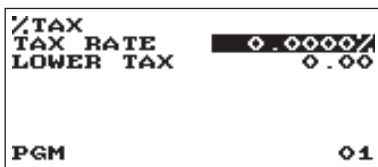

Program each item as follows:

- **TAX RATE (Use the numeric entry)**
Tax rate (max. 7 digits: 0.0000 to 999.9999%).
- **LOWER TAX (Use the numeric entry)**
Lowest taxable amount (max. 5 digits: 0.00 to 999.99).

■ Doughnut exempt

Procedure

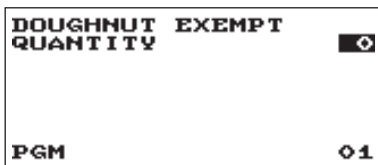

Program each item as follows:

- **QUANTITY (Use the numeric entry)**
Quantity for doughnut tax exempt (2 digits: 1 to 99/0).

NOTE The programming is effective for "taxable 1 & taxable 3" items on Canadian tax (CANADA TAX 01 or CANADA TAX 10).

Automatic Sequencing Key Programming

If you program frequently performed key operations for the **AUTO** key, you can enter those key operations simply by pressing the corresponding **AUTO** key in key operations.

■ Key Sequence

Procedure

```
SETTING ▲
 9 REPORT
10 MESSAGE
11 DEVICE CONFIG
12 TAX
13 AUTO KEY
PGM ◊1
```



```
AUTO KEY
PGM ◊1
```

1. In the SETTING window, select "13 AUTO KEY."
 - The AUTO KEY window will appear.
2. Enter the key operation sequence by any key except the **AUTO** key.

The register allows to program up to 25 keys for the **AUTO** key.
3. To terminate the procedure enter the **AUTO** key, the confirmation window will appear for sequence data saving. Select "SAVE" or "ABANDON" and enter the **CA/AT/NS** key.

Example

In case of the X1 General report printing.

```
AUTO KEY
 2 4 KEY
 3 CA/AT/NS
 4 2 KEY
 5 CA/AT/NS
 6 1 KEY
PGM ◊1
```

Key operation

- MODE**
- 4=(select X1/Z1 MODE)
- CA/AT/NS**
- 2=(select READING)
- CA/AT/NS**
- 1=(select GENERAL)
- AUTO CA/AT/NS**

Reading of Stored Programs

You can read programs stored in the PROGRAM mode.

■ Program reading sequence

To read those programs stored in the PROGRAM mode, use the following procedure:

1. Select the PROGRAM mode from the mode selection window.
2. Select "1 READING" from the PROGRAM mode to display the items list, and press the **CA/AT/NS** key. Select an item listed in the table shown later.

Item:	Description:
1 DEPARTMENT	Department (Full or specified range)
2 PLU/UPC	PLU/UPC (Full or specified range)
3 FUNCTIONS	Function
4 MEDIA	Media
5 FUNCTION TEXT	Function Text
6 CLERK	Clerk
7 MANAGER	Manager
8 MODE PASS CODE	Mode pass code
9 TRAINING CLK	Training clerk
10 OPTIONAL	Optional feature
11 REPORT	Report setting
12 MESSAGE	Message
13 DEVICE CONFIG	Device configuration
14 TAX	Tax
15 AUTO KEY	Auto key
16 ROM VERSION	ROM version

Sample printouts

Departments

Operating mode		*PGM*			
Report type	DEPARTMENT				Tax status
Dept. code	D01		0.00		Unit price
Description	DEPT. 01	T1	01		Function programming
Group no.	GO	COL999999.99			01 Amount entry type (0:Inhibit 1:Open 2:Preset 3:Open&Preset)
	D02		0.00		SICS (0:No 1:Yes)
	DEPT. 98				HALO limit
	GO B	COL999999.99			Bottle return item
	D99		0.00		
	DEPT. 99	T1	01		
	GO	COL999999.99			Commission group no.

PLU/UPC

Report type		*PGM*			
PLU code	P00001	(01)	2C0		Associated dept. code
Description	PLU00001		12.50		Amount entry type
	P00002	(01)	2C0		Commission group no.
	PLU00002		5.10		Unit price
	P00003	(01)	2C0		
	PLU00003		1.10		
UPC code	4901305920795#	(01)	C0		Unit price
Description	Notebook		2.30		Commission group no.
	5012345678900#	(01)	C0		
	Item-A		5.00		
	5045678912304#	(01)	C0		
	Item-C		3.60		
	5099887654302#	(05)	C0		
	DEPT. 05		2.60		

NOTE UPC code are printed out in the sequence shown below.

EAN-13
EAN-8
UPC-A
UPC-E
ITF-14

• Functions

PGM	
FUNCTIONS	
(-)	-0.00
IS	L999999.99
%1	-0.00%
S	L100.00%
%2	-0.00%
I	L100.00%
M-TAX	L999999.99
***RA	L999999.99
***PO	L999999.99
****CID	L999999.99
COM. SAL1	0.00%
COM. SAL2	0.00%

Report type
 Sign (plus/minus)
 Function text
 Type I=Item S=Subtotal
 Rate
 HALO limit
 Commission rate

• Media

PGM	
MEDIA	
CASH	L999999.99 00
CHECK	L999999.99 00
CHARGE	L999999.99 00
CHARGE-	
CHARGE2	L999999.99 00
CHARGE2-	
PRESET RATE	ENABLE
CONV 1	€ 0.000000 2
OPEN RATE	ENABLE
CONV 2	2

Report type
 HALO
 Programming data (00)
 Function text
 Entry of amount tendered
 (0:Non-Compulsory, 1:Compulsory)
 Programming data (00)
 Footer print on receipt
 (0:No, 1:Yes)
 Tab
 Entry of amount tendered
 (0:Inhibit, 1:Compulsory)
 Rate
 Footer print on receipt
 (0:No, 1:Yes)
 Foreign currency symbol
 (Printed if programmed)

• Function text

PGM		Report type
FUNCTION TEXT		Function
NET 1	NET 1	Text
TAX1 ST	TAX1 ST	
GRS TAX1	GRS TAX1	
RFD TAX1	RFD TAX1	
TAX1	TAX1	
TX1 EXPT	TX1 EXPT	
TAX2 ST	TAX2 ST	
GRS TAX2	GRS TAX2	
RFD TAX2	RFD TAX2	
TAX2	TAX2	
TX2 EXPT	TX2 EXPT	
TAX3 ST	TAX3 ST	
GRS TAX3	GRS TAX3	
RFD TAX3	RFD TAX3	
TAX3	TAX3	
TX3 EXPT	TX3 EXPT	
TAX4 ST	TAX4 ST	
GRS TAX4	GRS TAX4	
RFD TAX4	RFD TAX4	
TAX4	TAX4	
TX4 EXPT	TX4 EXPT	
GRS MTAX	GRS MTAX	
RFD MTAX	RFD MTAX	
TTL TAX	TTL TAX	
NET	NET	
NET2	NET2	
REFUND	REFUND	
VOID	VOID	
VOID	VOID	
MGR VOID	MGR VOID	
SBTL VOID	SBTL VOID	
NO SALE	NO SALE	
TRANS CT	TRANS CT	
NET3	NET3	
CA+CHK ID	CA+CHK ID	
CHK/CG	CHK/CG	

*DEPT TL	*DEPT TL
DEPT (-)	DEPT (-)
*BTTL TL	*BTTL TL
BTTL (-)	BTTL (-)
GROUP01	GROUP01
GROUP02	GROUP02
GROUP03	GROUP03
GROUP04	GROUP04
GROUP05	GROUP05
GROUP06	GROUP06
GROUP07	GROUP07
GROUP08	GROUP08
GROUP09	GROUP09
COM. AMT1	COM. AMT1
COM. AMT2	COM. AMT2
COM. TTL	COM. TTL
NON COM.	NON COM.
ITEMS	ITEMS
MDSE ST	MDSE ST
SUBTOTAL	SUBTOTAL
***TOTAL	***TOTAL
CHANGE	CHANGE
#	#
COPY	COPY
DUE	DUE
RCP SW.	RCP SW.
GST EXPT	GST EXPT
PST TTL	PST TTL
GST TTL	GST TTL
VAT EXPT	VAT EXPT
TOTAL TAX	TOTAL TAX

NOTE The text of "GST EXMPT", "PST TTL" and "GST TTL" appears only when Canadian tax is selected.

• Clerk

PGM		Report type
CLERK		Clerk code
CLK#01	CLERK01	Clerk name
	0 0000	Auto key operation/ Pass code
CLK#02	CLERK02	
	0 0000	(0: Enable 1: Disable)
CLK#39	CLERK39	
	0 0000	
CLK#40	CLERK40	
	0 0000	

• Manager

PGM		Report type
MANAGER		Pass code
PASS CODE	9999	

• Mode pass code

PGM		Report type
MODE PASS CODE		Mode
VOID MODE	0000	Pass code
OPXZ	0000	
VIEW REPORT	0000	
X1	0000	
Z1	0000	
X222	0000	
PROGRAM	0000	
SD CARD	0000	

• Training clerk

PGM		Report type
TRAINING CLK		Training clerk code
CODE	00	Training mode title text
TEXT	TRAINING	

• Optional feature

PGM		Report type
OPTIONAL		Item
BASIC SYSTEM		Setting
DATE FORMAT	MDY	
TIME FORMAT	12-HOUR	
ERROR	LOCK ERROR	
CURRENCY SYMBOL	\$	
TAB	2	
DECIMAL QUANTITY	YES	
DECIMAL ROUND	ROUND	
[00]KEY	[00]	
PRT/DSP EDIT	YES	
ITEM DISPLAY	2-LINE	
FUNC. PROHIBIT		
NON-ADD	ENABLE	
NON-ADD + NS	ENABLE	
MINUS DEPT	ENABLE	
COPY RCPT	ENABLE	
VOID MODE	ENABLE	
SUBTOTAL<0	ENABLE	
TEND+DIRECT	ENABLE	
FUNC. AUTHORITY		
RA	PUBLIC	
PO	PUBLIC	
REFUND	PUBLIC	
ITEM VD	PUBLIC	
SBTL VD	PUBLIC	
NO SALE	PUBLIC	
TAX DELETE	PUBLIC	
MANUAL TAX	PUBLIC	

FUNCTION SELECT		
SPLIT ENTRY	DISABLE	
SPLIT COUNT	QUANTITY	
VD MODE TO HOURLY	NO	
ST BEFORE DIRECT	NOT	
ST BEFORE TEND	NOT	
NS RECEIPT	PRINT	
AFTER TRANS.	DETAIL	
PRINT SELECT		
CONSECUTIVE NO.	YES	
DATE	YES	
TIME	YES	
PURCHASE NO.	YES	
TAX STATUS	YES	
TAX	1 to 4	
TAX(TAXABLE=0)	NO	
TAX(TAX=0)	NO	
ST AT ST KEY	NO	
LOGO FORM	PATTERN6	
FOOTER	ALL	
0 AMT PLU	TEXT ONLY	
ITEM JOURNAL	ALL	
LOGO ON JOURNAL	NO	
CONV. SHORT TEND	PRINT	
GST VAT PRINT	YES	
UPC FUNCTION		
LEARNING	ENABLE	
LOOKUP AT RF	YES	
CODE PRINT	NO	
C/D CHECK	NO	
ISBN/ISSN	PRICE CMP.	

• Report setting

PGM	
REPORT	
0 SKIP	
DEPARTMENT	SKIP
TRANSACTION	SKIP
PLU	SKIP
CLERK	SKIP
HOURLY	SKIP
DAILY NET	SKIP
PRINT SELECT	
Z COUNTER	YES
GT1 ON Z	YES
GT2 ON Z	YES
GT3 ON Z	YES
TR GT ON Z	YES
VD MODE ON X1Z1	YES
VD MODE ON X2Z2	YES
PLU/UPC DATA ON Z	YES
JOURNAL SIZE	SMALL
GST EXEMPT ON XZ	YES
Z COUNTER	
GENERAL Z1	0000
GENERAL Z2	0000
Z1 GENERAL REPORT	
SD: SAVE SALES	NO
SD: SAVE ALL RAM	NO
RESET GT	NO
JOURNAL	
TR DATA STORE	YES
X DATA STORE	HEADER

Report type

Setting

Item

• Message

PGM	
MESSAGE	
RECEIPT LOGO	
BUSINESS NAME	
ADDRESS 1	
ADDRESS 2	
TELEPHONE	
MESSAGE 1	
MESSAGE 2	

Report type

Receipt logo text

• Device configuration

(The Quebec fiscal type is as follows.)

PGM		Report type
DEVICE CONFIG		
KEYBOARD BUFFERING	YES	Setting
TOUCH SOUND	YES	
DISPLAY		Item
POWER SAVE	2	
P. SAVE AT TM	YES	
PRINTER DENSITY	50	
EFT CHARGE	NOT	
TIME OUT1	010	
TIME OUT2	099	
TIME OUT3	0099	
RS PORT		
PORT 1	SCANNER	
PORT 2	ONLINE	
ONLINE		
TERMINAL No.	000001	
CI SIGNAL	NON	
LINE FORM	FULL	
BAUD RATE	19200	
START CODE	002	
END CODE	013	
TIME OUT	007	
SCANNER		
BAUD RATE	4800	
DATA BIT	7 bits	
PARITY	ODD	
STOP BIT	1 bit	
ITF14	W LENGTH	

PGM		Report type
DEVICE CONFIG		
KEYBOARD BUFFERING	YES	Setting
TOUCH SOUND	YES	
DISPLAY		Item
POWER SAVE	2	
P. SAVE AT TM	YES	
PRINTER DENSITY	50	
RS PORT		
PORT 1	SRM	
PORT 2	CONTINUOUS	
ONLINE		
TERMINAL No.	000001	
CI SIGNAL	NON	
LINE FORM	FULL	
BAUD RATE	19200	
START CODE	002	
END CODE	013	
TIME OUT	007	
SCANNER		
BAUD RATE	4800	
DATA BIT	7 bits	
PARITY	ODD	
STOP BIT	1 bit	
ITF14	W LENGTH	
SRM		
PRINTER	T88(3)	
AUTO CUT	NO	

• Tax

PGM	
TAX	
TAX SYSTEM	AUTO TAX
TAX1	6.0000 %
	1.00
1	0.11
2	0.23
3	0.39
4	0.57
5	0.73
6	0.89
7	1.11
TAX2	8.0000 %
	0.12
TAX3	7.0000 %
	0.15
TAX4	10.0000 %
	0.20
DOUGHNUT EXEMPT	0

Report type
 Tax no.
 Tax system
 Tax table
 Tax rate
 Lower taxable amount

• AUTO key

PGM	
AUTO KEY	
	MODE
	4 KEY
	CA/AT/NS
	2 KEY
	CA/AT/NS
	1 KEY

Report type
 Key operation

• ROM version

PGM	
VERSION	
IPL Version	
	ER-A3X7 1.00
PROGRAM Version	
	ER-A347 V1.03
SYSTEM Version	
	System V1.00

Report type

EFT Test Function

The EFT Test function appears only when the RS port is programmed to “EFT” in “Device Configuration Programming”.

Use the following procedure to perform the EFT test function.

Procedure

```
PROGRAM MODE
1 READING
2 SETTING
3 EFT TEST
-----
PGM                               01
```



```
EFT TEST
1 EFT COMM TEST
-----
PGM                               01
```

1. Press the **MODE** key and select the “6 PROGRAM MODE” and press the **CA/AT/NS** key. In the “PROGRAM MODE” window, select “3 EFT TEST” and press the **CA/AT/NS** key. The EFT TEST window will appear.

2. Press the **CA/AT/NS** key to perform the test function.

NOTE

When the EFT terminal (CREDIT CARD terminal) is not connected, the EFT test function causes an error.

SD CARD Mode

You can exchange data through an SD memory card between your register and a PC when managing the data in your register by using the SHARP's PC software "PC-Link".

For "PC-Link", consult your dealer.

You can also save all necessary data in the register to an SD memory card for backup.

To use the SD memory card function, select the "7 SD CARD MODE" in the mode selection window and perform the following operations.

This instruction manual describes only those operations needed on the register. For details, please refer to the help section in the "PC-Link".

■ Inserting and removing an SD memory card

The SD card slot is located on the front side of your register.

Inserting an SD memory card

Insert an SD memory card into the SD card slot with the printed SD logo facing upwards. Push the card in steady with a finger until it clicks and release it slowly.

Removing the SD memory card

Push the card in gently with a finger and release it. The card will come out.

NOTE

- *This model supports SD cards only. Use of any other types of SD cards such as mini SD, micro SD, etc. with an adapter is not supported.*
- *When inserting or removing the SD memory card, be sure to release it slowly. Otherwise, the card may pop out and injure your finger.*
- *Never touch or remove the SD memory card while it is accessed, otherwise the data stored in it may be damaged.*
- *Formatting the SD memory card erases all the data in it.*

CAUTION: Never turn the power off, while the SD memory card is accessed.

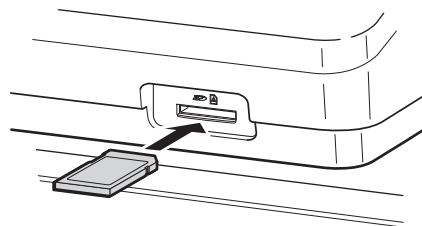

■ SD card formatting

When the SD card is not formatted yet, take the formatting operation.

Procedure

- (1) Select "4 FORMATTING" in the SD CARD mode and press the **CA/AT/NS** key, the confirmation window is displayed.
- (2) To perform the format operation, select OK and press the **CA/AT/NS** key.
To cancel the operation, select CANCEL and press the **CA/AT/NS** key.

■ Folder creating

A user folder can be created in the following location:

SHARP/ECRER3X7/nnnnnnnn (nnnnnnnn: user folder name)

Procedure

- (1) Select "3 FOLDER CONTROL" in the SD CARD mode and press the **CA/AT/NS** key.
- (2) Select "1 CREATE FOLDER" and press the **CA/AT/NS** key, the folder name entry window is displayed.
- (3) Enter the required folder name and press the **CA/AT/NS** key.
To cancel the operation, press the **ESC/CANCEL** key.

■ Folder name selecting

Procedure

- (1) Select “3 FOLDER CONTROL” in the SD CARD mode and press the **CA/AT/NS** key, the FOLDER CONTROL window is displayed.
- (2) Select “2 SELECT FOLDER” and press the **CA/AT/NS** key, the folder name list window is displayed.
- (3) Select the required folder name from the list, and press the **CA/AT/NS** key.
To cancel the operation, press the **ESC/CANCEL** key.

■ Data saving

The sales data or programming data can be saved to the SD card.

Procedure

- (1) Select “1 SAVING” in the SD CARD mode and press the **CA/AT/NS** key, the following data list window is displayed.

Item	Data list
SALES DATA	Sales data (CSV format)
IND. PROGRAM	Select the individual programming data: DEPARTMENT PLU/UPC CLERK GRAPHIC LOGO LOGO TEXT TAX
ALL PROGRAM	All programming data
ALL RAM DATA	All RAM data

- (2) Select the data menu from the list and press the **CA/AT/NS** key, the confirmation window is displayed.
To save the required data file, select OK and press the **CA/AT/NS** key.
To cancel the operation, select CANCEL and press the **CA/AT/NS** key.

■ Data loading

The programming data can be loaded from the SD card.

Procedure

- (1) Select “2 LOADING” in the SD CARD mode and press the **CA/AT/NS** key. The following selection window is displayed.

Item	Data list
IND. PROGRAM	Select the individual programming data: DEPARTMENT PLU/UPC CLERK GRAPHIC LOGO LOGO TEXT TAX
ALL PROGRAM	All programming data
ALL RAM DATA*	All RAM data

- (2) Select the data menu from the list and press the **CA/AT/NS** key, the confirmation window is displayed.
To load the programming data file, select OK and press the **CA/AT/NS** key.
To cancel the operation, select CANCEL and press the **CA/AT/NS** key.

* When “ALL RAM DATA” is selected, the register resets the program in the last save point after loading all the RAM data.

NOTE The loading operation must be circumspect in execution, the sales data and/or all programming data will be recovered with the back-up data.

Error message table of the SD card function

Error message (display)	Error status and action
CARD FULL	The SD memory card is full. Delete unnecessary data from the card on a PC or replace the card with a new one. When using a new SD memory card, be sure to format it in advance.
CARD PROTECT	The write-protect switch on the SD memory card is in the “PROTECTED” position. Set the switch on the “NOT PROTECTED” position.
FILE FAILED	The data stored in the SD memory card is incorrect. Write correct data into the SD memory card on a PC.
NO CARD	No SD memory card is found. Insert an SD memory card into the SD card slot or reinsert it correctly.
NO FILE	The designated file is not found.
NO FOLDER	The user folder is not found. (SHARP/ECRER3X7/user folder name)
OVER LIMIT.	The maximum allowable number of times of sales data writing is exceeded. Delete unnecessary data from the SD memory card on a PC or replace the card with a new one. When using a new SD memory card, be sure to format it in advance.
SD ACC POWER OFF	A power failure has occurred while the SD memory card is accessed. Perform the interrupted operation again from the beginning after power recovery.
SD ERROR	An error other than the above mentioned has occurred while the SD memory card is accessed. Perform the interrupted operation again from the beginning.

11

Universal Product Code (UPC) or European Article Number (EAN)

■ UPC or EAN code

Your register can transact the following codes:

- UPC-A (Number system character: 0, 2, 3, 4)
- UPC-E
- EAN-8
- EAN-13
- Internal code EAN-8/EAN-13
- ITF-14

UPC-A

- Number system character: 0 <used in the source marking>
- Number system character: 3 <used as NDC or HRI>

For entry, a full 12 digits number or 11 digits number (omitting the check digits) must be entered.

- Number system character: 4 <In-store marking PLU type>

For entry, a full 12 digits number, 11 digits number (omitting the check digit), or a leading zero plus 12 digits number must be entered.

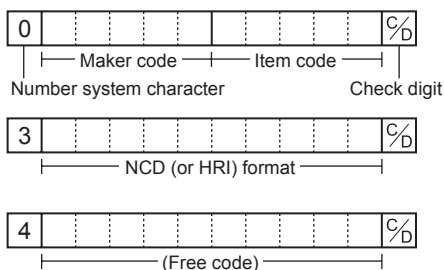

UPC-E

- UPC-E is a zero-suppressed version of UPC-A that conforms to the UPC-E Standards. This code is used for marking small package.

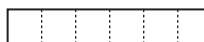

For entry, a 6 digits number or a leading zero plus 6 digits number must be entered.

EAN-8

- Ordinary EAN-8 code (flag: neither 0 nor 2) <used in the source marking>

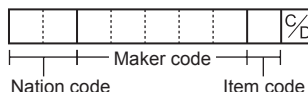

For entry, a full 8 digits number must be entered.

EAN-13

- Ordinary EAN-13 code (used in the source marking)

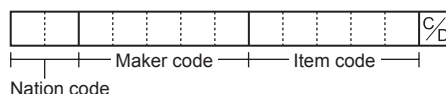

For entry, you must enter a full of 13 digits number.

In case of the leading code is "977", "978" or "979", the code is recognized as ISBN code or ISSN code. For the ISBN/ISSN code, the compulsive price entry can be programmed. Refer to the programming section "UPC Function" in "Optional Feature Selection".

ITF-14

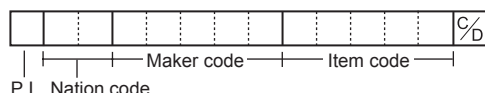

■ Add-on code

UPC-A and EAN-13 may be followed by a two digits number or a five digits number as add-on code, excepting UPC-A without a check digit plus two or five digits add-on code.

Therefore, the total number of digits enterable for sales entries are as shown below:

Code entry	No add-on code	2-digit add-on code	5-digit add-on code
UPC-A	12	15 ("0" + 14)	17
UPC-A w/leading zero	13	15	18
UPC-A w/o check digit	11	–	–
UPC-E	6	–	–
EAN-8	8	–	–
EAN-13	13	15	18

NOTE

Your register does not read automatically the encoded price of the press code and does not store the 2-digit and 5-digit Add-On code.

12

Operator Maintenance

In Case of Power Failure

When power is lost, the register retains its memory contents and all information on sales entries.

- When power failure is encountered in register idle state or during an entry, the register returns to the normal state of operation after power recovery.
- When power failure is encountered during a printing cycle, the register carries out the correct printing procedure after power recovery.

In Case of Printer Error

If the printer runs out of paper, the printer will stall, and “PAPER EMPTY” will appear on the display. Key entries will not be accepted. Referring to “Replacing the Paper Roll” in this chapter, install a new paper roll in the proper position, then press the (CL) key. The printer will print the power failure symbol and resume printing.

If the print roller arm comes up, the printer stalls, and “PAPER EMPTY” will appear on the display. Key entries will not be accepted. Push down the arm until it is securely locked, then press the (CL) key. The printer will print the power failure symbol and resume printing.

Cautions in Handling the Printer and Recording Paper

■ Cautions in handling the printer

- Avoid the following environments:
 - Dusty and humid places
 - Direct sunlight
 - Iron powder (A permanent magnet and electromagnet are used in this register.)
- Never pull the paper when the print roller arm is locked. First lift up the arm, and then remove the paper.
- Never touch the surface of the print head and print roller.

■ Cautions in handling the recording paper (thermal paper)

- Use only the paper specified by SHARP.
- Do not unpack the thermal paper until you are ready to use it.
- Avoid heat. The paper will color at around 70°C.
- Avoid dusty and humid places for storage. Avoid direct sunlight.
- The printed text on the paper can discolor under the following conditions:
 - Exposure to high humidity and temperature
 - Exposure to the direct sunlight
 - Contact with glue, thinner or a freshly copied blueprint.
 - Heat caused by friction from scratching or other such means.
 - Contact with a rubber eraser or adhesive tape.
- Be very careful when handling the thermal paper. If you want to keep a permanent record, copy the printed text with a photocopier.

Replacing the Paper Roll

■ Recording paper specifications

Be sure to use paper rolls specified by SHARP.
The use of any other paper rolls than specified could cause paper jamming, resulting in register malfunction.

Paper specification

- Paper width: 57.5 ± 0.5 mm
- Max. outside diameter: 80 mm
- Quality: High quality (0.06 to 0.08 mm thickness)

• Be sure to set a paper roll prior to using your register, otherwise it may cause a malfunction.

Install the paper roll in the printer. Be careful then to set the roll and cut the paper end correctly.

(How to set the paper roll)

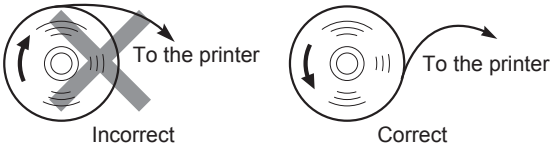

(How to cut the paper end)



■ Installing Paper Rolls

The register can print receipts and journals. For the printer, you must install the paper rolls (receipt and journal paper rolls) provided with the register.

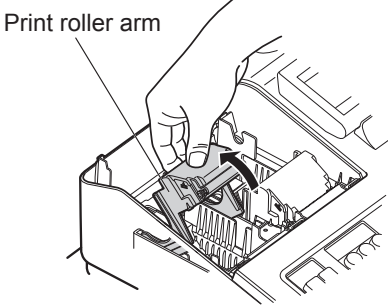

1. Remove the printer cover.
2. Lift up the print roller arm of the receipt side.

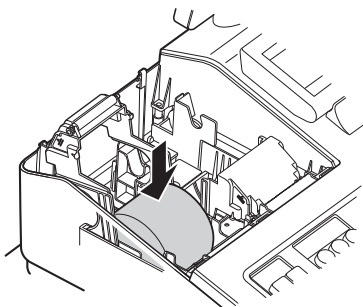

3. Set a paper roll in the paper roll cradle of the receipt side as per the diagram.



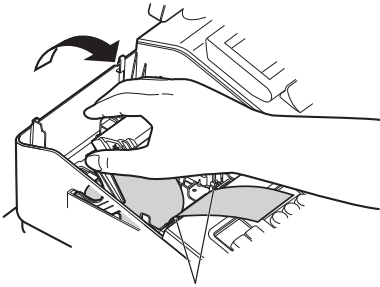

Paper positioning guides

4. Feed the end of the paper along with the paper positioning guides as per the diagram.
5. While holding down the paper, slowly close the print roller arm of the receipt side, and push down the arm until you hear a click locking the arm.

NOTE

If the print roller arm is not securely locked, printing is not done right. If this problem occurs, open the arm, and close the arm instructed above.

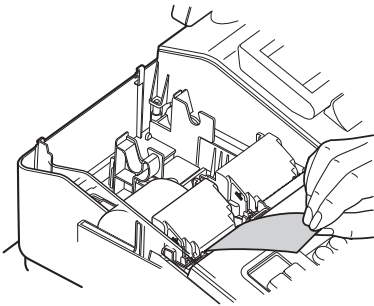

6. Cut off the excess paper.

Print roller arm

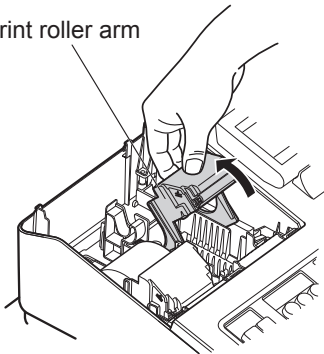

7. Lift up the print roller arm of the journal side.

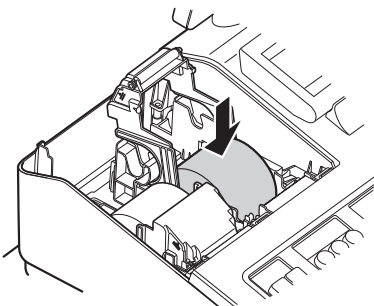

8. Set a paper roll in the paper roll cradle of the journal side as per the diagram.



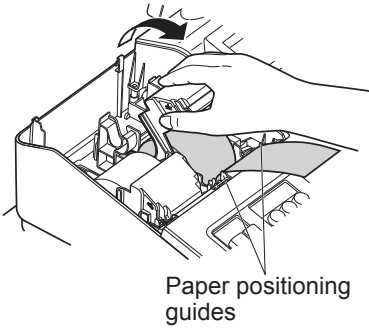

9. While holding down the paper, slowly close the print roller arm of the journal side, and push down the arm until you hear a click locking the arm.

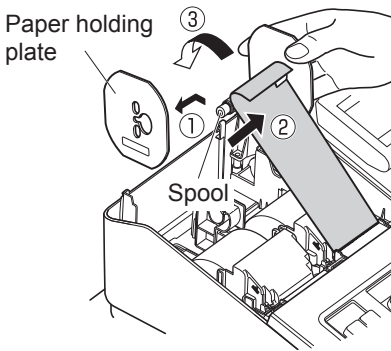

10. ① Remove the paper holding plate from the spool.
② Insert the end of the paper into the slit in the spool. (Press the journal paper feed key to feed more paper if required.)
③ Wind the paper two or three turns around the spool shaft.

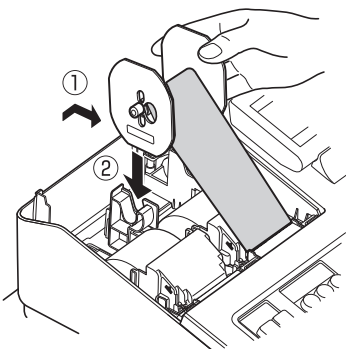

11. ① Mount the paper holding plate onto the take-up spool.
② Set the spool on the bearing, and press the journal paper feed key to take up excess slack in the paper.

12. Replace the printer cover.

13. For the receipt paper, press the  key to make sure the paper end comes out of the printer cover and clean paper appears.

NOTE

If the paper end does not come out, open the printer cover, and pass the paper end between the paper cutter and the paper guide of the printer cover, and replace the printer cover.

■ Replacing the paper roll

When colored dye appears on the edges of the paper roll, it is time to replace the paper roll. Use paper of 57.5 ± 0.5 mm in width. To prevent jamming be sure to use paper specified by SHARP.

Replacing the receipt paper roll:

1. Confirm that the REG mode has been selected.
2. Remove the printer cover.
3. Lift up the print roller arm of the receipt side.
4. Remove the paper roll from the paper roll cradle of the receipt side.

NOTE *Do not pull the paper through the printer.*

5. Install a new paper roll correctly by following the steps in "Installing Paper Rolls".

Replacing the journal paper roll:

1. Confirm that the REG mode has been selected.
2. Remove the printer cover.
3. Press the journal paper feed key to advance the journal paper until its printed part is out of the way.
4. Cut the paper and remove the take-up spool from the bearing.

NOTE *Do not pull the paper through the printer.*

5. Lift up the print roller arm of the journal side.
6. Remove the paper roll from the paper roll cradle of the journal side.
7. Remove the paper holding plate of the take-up spool.
8. Remove the printed journal roll from the take-up spool.
9. Install a new paper roll correctly by following the steps in "Installing Paper Rolls".

■ Removing a Paper Jam

CAUTION: The paper cutter is mounted on the printer cover. Be careful not to cut yourself. Never touch the printer head immediately after printing, as the head may still be hot.

1. Remove the printer cover.
2. Lift up the print roller arm.
3. Remove the paper jam. Check for and remove any shreds of paper that may remain in the printer.
4. Reset the paper roll correctly by following the steps in "Installing Paper Rolls".

Cleaning the Printer (Printer Head/Sensor/Roller)

When the printed text is getting dark or faint, paper dust may be stuck to the printer head, sensor and/or roller. Clean them as follows:

CAUTION: Never touch the printer head with a tool or anything hard as it may damage the head.
The paper cutter is mounted on the printer cover. Be careful not to cut yourself.

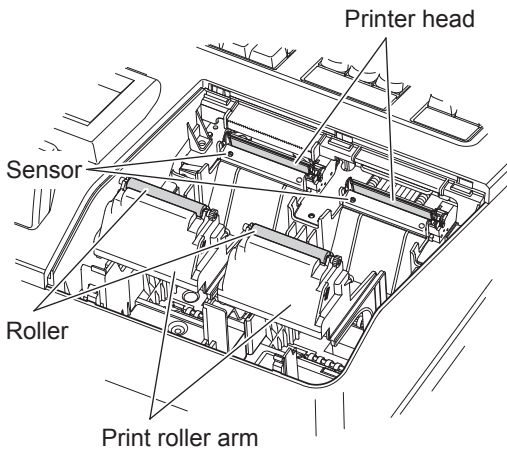

1. Select the OFF mode.
2. Remove the printer cover.
3. Lift up the print roller arm.
4. Remove the paper roll referring to the "Removing a Paper Jam" section.
5. Clean the printer head with a cotton swab or soft rag moistened with ethyl alcohol or isopropyl alcohol. Clean the roller and the sensor in the same manner.
6. Reset the paper roll correctly by following the steps in "Installing Paper Rolls".

Drawer and Drawer Lock Key

■ Removing the Till

The till in the register is detachable. After closing your business for the day, remove the till from the drawer and keep the drawer open. The coin case is also detachable from the till.

• For ER-A347

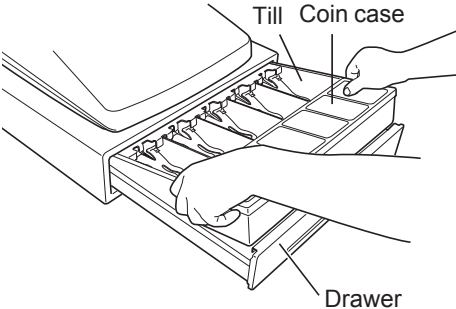

• For ER-A347A

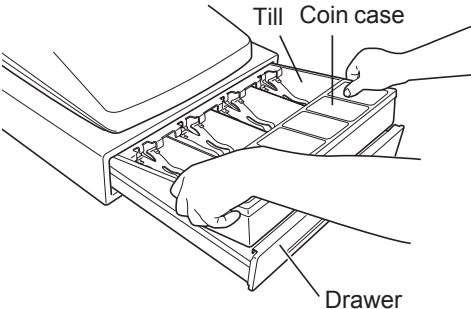

■ Opening the Drawer by Hand

The drawer automatically opens in the usual way. However, when power failure is encountered or the register becomes out of order, slide the lever located on the bottom of the register in the direction of the arrow. (See the figure below.) The drawer will not open, if it is locked with a drawer lock key.

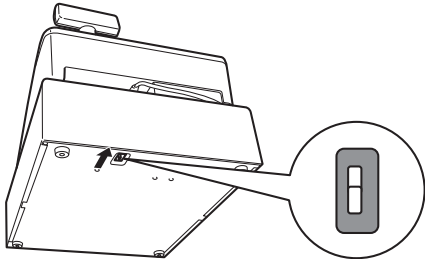

■ Drawer Lock Key

This key locks and unlocks the drawer.
To lock it, turn 90 degrees counterclockwise.
To unlock it, turn 90 degrees clockwise.

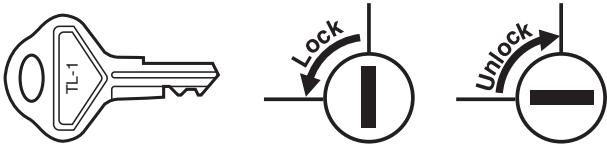



Before Calling for Service

If you encounter any of the following problems, please read below before calling for service.

Fault	Checking
<ul style="list-style-type: none"> The display does not illuminate. 	<ul style="list-style-type: none"> Is power supplied to the electric outlet? Is the power cord plug out or loosely connected to the electric outlet? Is the register in screen-save mode?
<ul style="list-style-type: none"> The display is illuminated, but the whole register refuses entries. 	<ul style="list-style-type: none"> Is a clerk code assigned to the register? Is the register in the REG mode?
<ul style="list-style-type: none"> No receipt is issued. 	<ul style="list-style-type: none"> Is the receipt paper roll properly installed? Is there a paper jam? Is the receipt function in the "OFF" status? Is the print roller arm securely locked?
<ul style="list-style-type: none"> No journal paper is taken up. 	<ul style="list-style-type: none"> Is the take-up spool installed on the bearing properly? Is there a paper jam?
<ul style="list-style-type: none"> Printing is unusual. 	<ul style="list-style-type: none"> Are the printer head/sensor/roller clean? Is the paper roll properly installed?

Error message table

Error message (display)	Error status and action
AMT. TEND ONLY	The amount tendering is compulsory.
COMM. ERROR	A communication error occurred.
DEPARTMENT IS INHIBITED	Operated department is programmed as "INHIBIT".
ENTRY INHIBITED NN**N	Perform the correct key operation.
ENTRY OVERFLOW PLEASE CHECK ENTERED DIGITS	The correct numeric data must be entered.
INVALID CODE ENTRY	The correct code data must be entered.
MISOPERATION INVALID KEY	Perform the correct key operation.
OPEN PRICE ENTRY INHIBITED	The open price entry is inhibited. (Only preset price entry)
OVER LIMIT.	Overflow limitation error
PAPER EMPTY	Install a new (receipt or journal) paper roll, and press the  key.
PLU IS SET TO INHIBIT	Operated PLU is programmed as "INHIBIT".
PRESET PRICE ENTRY INHIBITED	The preset price entry is inhibited. (Only open price entry)
PRINTER ERROR	The temperature/voltage of printer head is too high. Turn off the power, and repair the printer. Then turn on the power and press  key.
STACK OVER	Turn off the power, and consult a Sharp Authorized Servicer.
UNDEFINED CODE	Desired code is not programmed yet.
UPC CODE IS NOT EXISTING	Desired UPC/EAN code is not programmed yet.

13

Specifications

Model:	ER-A347 ER-A347A	
Dimensions:	16.7 (W) x 15.6 (D) x 12.6 (H) in. (425 (W) x 395 (D) x 320 (H) mm)	
Weight:	Approx. 24.3 lb (11 kg)	
Power Source:	120V AC, 60Hz	
Power Consumption:	Stand-by: 7.4 W Operating: 15.0 W (max.)	
Working Temperature:	32 to 104 °F (0 to 40 °C)	
Humidity:	20 % to 85 %	
Built-in battery:	Rechargeable batteries, memory holding time about 1 month (with fully charged built-in batteries, at room temperature)	
Display:	Operator display:	LCD display with Tilt mechanism 160 (W) x 64 (H) (dots)
	Customer display:	7-segment LED display
Printer:	Type:	Two-station thermal printer
	Printing speed:	Approx. 12 lines/second
	Printing capacity:	30 digits each for receipt/journal paper
	Other functions:	- Receipt (ON-OFF) function - Compression print for the journal - Receipt and journal independent paper feed function
Logo:	Graphic logo printing:	Size: 130 (H) x 360 (W) pixel Area of black must be less than 35% of all area.
	Logo message printing:	Logo message for the receipt (max. 30 characters x 6 lines)
Paper Roll:	Width: 2.25 ± 0.02 in (57.5 ± 0.5 mm) Max. diameter: 3.15 in (80 mm) Quality: High quality (0.06 to 0.08 mm thickness)	
Cash Drawer:	ER-A347: 5 slots for bills and 6 for coin denominations ER-A347A: 4 slots for bills and 6 for coin denominations	
Accessories:	Hardware Operation Manual:	1 copy
	Paper roll:	2
	Take-up spool:	1 (with paper holding plate)
	Drawer lock key:	2

*Specifications and appearance are subject to change without notice for improvement.

In U.S.A.:

WARRANTY DISCLAIMER

PLEASE BE SURE TO ASK ABOUT THE WARRANTY THAT AN AUTHORIZED DEALER EXTENDS TO YOU. In order to assure you, the end-user, of warranty protection, Sharp extends a limited warranty to each of its authorized dealers, and in turn requires each of its authorized dealers to extend its own warranty to you on terms that are no less favorable than those given to the dealer by Sharp. You should be aware, however, that Sharp does not itself extend any warranties, either express or implied, directly to you, the enduser, and no one is authorized to make any representations or warranties on behalf of Sharp. Specifically, SHARP DOES NOT EXTEND TO YOU, THE END-USER, ANY EXPRESS WARRANTY OR ANY IMPLIED WARRANTY OF MERCHANTABILITY, FITNESS FOR USE OR FITNESS FOR ANY PARTICULAR PURPOSE IN CONNECTION WITH THE HARDWARE, SOFTWARE, OR FIRMWARE EMBODIED IN OR USED IN CONJUNCTION WITH THIS PRODUCT.

Sharp is not responsible for any damages or loss, either direct, incidental or consequential, which you, the end-user, may experience as a result of your purchase or use of the hardware, software or firmware embodied in or used in conjunction with this product. Your sole remedy in the event that you encounter any difficulties with the product is against the authorized dealer from which you purchased the product. In the event that this authorized dealer does not honor its warranty commitments, please contact the Point of Sale Division, ISG, Sharp Electronics Corporation, Sharp Plaza, P.O. Box 650, Mahwah, NJ 07495-1163 so that Sharp can try to help you to assure complete satisfaction of all the warranty rights to which you are entitled from the authorized dealer.

In Canada:

WARRANTY DISCLAIMER

PLEASE BE SURE TO ASK ABOUT THE WARRANTY THAT AN AUTHORIZED DEALER EXTENDS TO YOU. In order to assure you, the end-user, of warranty protection, Sharp extends a limited warranty to each of its authorized dealers, and in turn requires each of its authorized dealers to extend its own warranty to you on terms that are no less favorable than those given to the dealer by Sharp. You should be aware, however, that Sharp does not itself extend any warranties, either express or implied, directly to you, the enduser, and no one is authorized to make any representations or warranties on behalf of Sharp. Specifically, SHARP DOES NOT EXTEND TO YOU, THE END-USER, ANY EXPRESS WARRANTY OR ANY IMPLIED WARRANTY OF MERCHANTABILITY, FITNESS FOR USE OR FITNESS FOR ANY PARTICULAR PURPOSE IN CONNECTION WITH THE HARDWARE, SOFTWARE, OR FIRMWARE EMBODIED IN OR USED IN CONJUNCTION WITH THIS PRODUCT.

Sharp is not responsible for any damages or loss, either direct, incidental or consequential, which you, the end-user, may experience as a result of your purchase or use of the hardware, software or firmware embodied in or used in conjunction with this product. Your sole remedy in the event that you encounter any difficulties with the product is against the authorized dealer from which you purchased the product.

In the event that this authorized dealer does not honor its warranty commitments, please contact the Retail Solutions, Business Solutions Division, Sharp Electronics of Canada Ltd., 335 Britannia Road East, Mississauga, Ontario L4Z 1W9 so that Sharp can try to help you to assure complete satisfaction of all the warranty rights to which you are entitled from the authorized dealer.

CLAUSE DE LIMITATION DE RESPONSABILITE

Assurez-vous de demander une garantie déivrée par un revendeur agréé. Afin de vous assurer, vous, les consommateurs, une garantie, la Société Sharp offre une garantie limitée à chacun de ses revendeurs agréés et en retour, requiert de chacun d'eux de vous offrir leur propre garantie dans des conditions pas plus favorables que celles données aux revendeurs par la Société Sharp. Cependant, vous devez être conscient que la Société Sharp n'offre aucune garantie, explicitement ou implicitement, directement aux consommateurs, et personne n'est autorisé à représenter ou à offrir une garantie au nom de la Société Sharp. Plus spécifiquement, LA SOCIETE SHARP N'OFFRE PAS AUX CONSOMMATEURS DE GARANTIE EXPLICITE OU IMPLICITE DE COMMERCIALISABILITE, DE CONFORMITE POUR UNE UTILISATION OU DE CONFORMITE POUR TOUT BUT PARTICULIER RELATIF A DES BRANCHEMENTS AVEC D'AUTRES MATERIELS, LOGICIELS, OU MICROPROGRAMMES INCORPORES DANS OU UTILISES AVEC CE PRODUIT. La Société Sharp n'est responsable d'aucun dégât ou perte, causé directement, accidentellement ou indirectement, que les consommateurs peuvent avoir suite à l'achat ou à l'utilisation d'un matériel, d'un logiciel ou d'un microprogramme incorporé dans ou utilisé avec ce produit. Votre unique moyen dans le cas où vous rencontreriez des difficultés avec ce produit est de vous retourner contre le revendeur agréé chez qui vous avez acheté le produit. Dans le cas où le revendeur agréé ne respecte pas les obligations de la garantie, contactez The Retail Solutions, Business Solutions Division, Sharp Electronics of Canada Ltd., 335 Britannia Road East, Mississauga, Ontario, L4Z 1W9. La Société Sharp peut essayer de vous aider afin de vous assurer une entière satisfaction concernant la garantie à laquelle vous avez droit vis-à-vis du revendeur agréé.

SHARP®

SHARP ELECTRONICS CORPORATION

Sharp Plaza, Mahwah, New Jersey 07495-1163

1-800-BE-SHARP

For additional information and product registration,
please visit www.sharpusa.com

SHARP ELECTRONICS OF CANADA LTD SHARP ÉLECTRONIQUE DU CANADA LTÉE

335 Britannia Road East, Mississauga, Ontario L4Z 1W9

<http://www.sharp.ca>

SHARP CORPORATION