

MODEL  
**FO-3150**

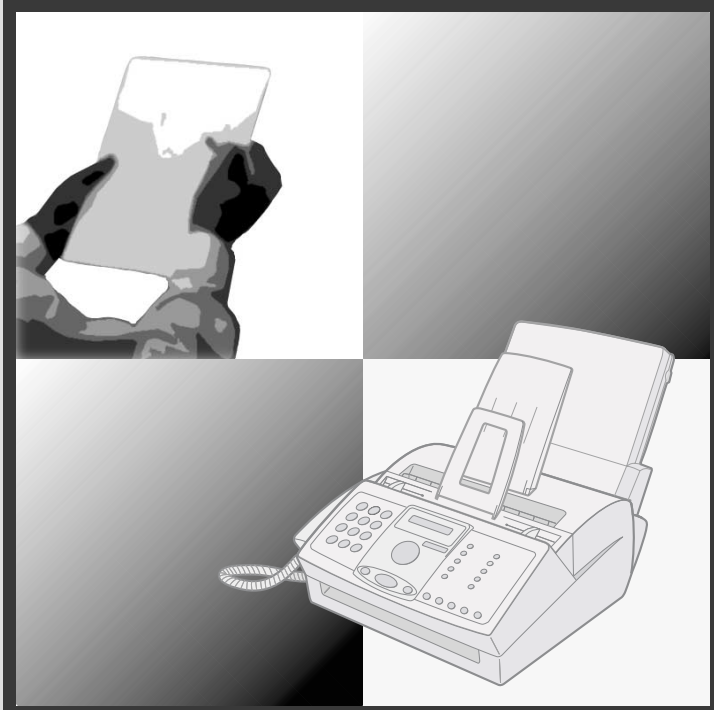

**FACSIMILE**  
OPERATION MANUAL

1. Installation
2. Sending Faxes
3. Receiving Faxes
4. Making Copies
5. Answering Machine Connection
6. Special Functions
7. Printing Lists
8. Maintenance
9. Troubleshooting

**SHARP**<sup>®</sup>

**WARNING** - FCC Regulations state that any unauthorized changes or modifications to this equipment not expressly approved by the manufacturer could void the user's authority to operate this equipment.

**Note:** This equipment has been tested and found to comply with the limits for a Class B digital device, pursuant to Part 15 of the FCC Rules. These limits are designed to provide reasonable protection against harmful interference in a residential installation. This equipment generates, uses and can radiate radio frequency energy and, if not installed and used in accordance with the instructions, may cause harmful interference to radio communications. However, there is no guarantee that interference will not occur in a particular installation. If this equipment does cause harmful interference to radio or television reception, which can be determined by turning the equipment off and on, the user is encouraged to try to correct the interference by one or more of the following measures:

- Reorient or relocate the receiving antenna.
- Increase the separation between the equipment and the receiver.
- Connect the equipment into an outlet on a circuit different from that to which the receiver is connected.
- Consult the dealer or an experienced radio/TV technician for help.

#### **ABOUT THE TELEPHONE CONSUMER PROTECTION ACT OF 1991**

"The Telephone Consumer Protection Act of 1991 makes it unlawful for any person to use a computer or other electronic device to send any message via a telephone facsimile machine unless such message clearly contains in a margin at the top or bottom of each transmitted page or on the first page of the transmission the following information:

- (1) The date and time of transmission.
- (2) Identification of either the business, business entity or individual sending the message.
- (3) Telephone number of either the sending machine, business, business entity or individual.

In order to program this information into your facsimile machine, please refer to the appropriate instructions in the operation manual."



As an ENERGY STAR® partner, SHARP has determined that this product meets the ENERGY STAR® guidelines for energy efficiency.

---

# Introduction

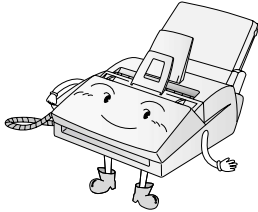

Welcome, and thank you for choosing a SHARP laser fax machine! The features and specifications of your laser fax are shown below..

<b>Automatic dialing</b>	<b>Rapid Key Dialing:</b> 10 numbers <b>Speed Dialing:</b> 99 numbers
<b>Memory size*</b>	1.8 MB (approx. 100 average pages)
<b>Modem speed</b>	14,400 bps with auto fallback to lower speeds.
<b>Transmission time*</b>	Approx. 6 seconds (only when ECM is on)
<b>Toner cartridge yield** (continuous printing, 4% page coverage, letter paper)</b>	<b>Initial starter cartridge</b> (included with fax machine): Approx. 1,800 pages <b>Replacement cartridge FO-29ND:</b> Approx. 3,700 pages
<b>Drum cartridge yield** (continuous printing, 4% page coverage, letter paper)</b>	<b>Initial starter cartridge</b> (included with fax machine): Approx. 20,000 pages <b>Replacement cartridge (FO-29DR):</b> Approx. 20,000 pages
<b>Scanning Resolution</b>	<b>Horizontal:</b> 203 lines/inch (8 lines/mm) <b>Vertical:</b> Standard: 98 lines/inch (3.85 lines/mm) Fine /Halftone: 196 lines/inch (7.7 lines/mm) Super fine: 391 lines/inch (15.4 lines/mm)
<b>Automatic document feeder</b>	Letter/A4: 20 pages max. (20-lb. paper) Legal: 5 pages max.
<b>Recording system</b>	Laser
<b>Compatibility</b>	ITU-T (CCITT) G3 mode

\*Based on Sharp Standard Chart at standard resolution, excluding time for protocol signals (i.e., ITU-T phase C time only).

\*\*The yields may vary depending on coverage and operating conditions.

<b>Paper tray capacity</b>	Letter: Approx. 200 sheets of 20-lb. (70 g/m <sup>2</sup> ) copier paper, or 180 sheets of 21.5-lb. (80 g/m <sup>2</sup> ) copier paper (at room temperature; maximum stack height should not be higher than the line on the tray) Legal: 100 sheets Recommended paper weight: 20-lb. Copy Bond
<b>Halftone (grayscale)</b>	64 levels
<b>Compression scheme</b>	MR, MH, MMR
<b>Input document size</b>	<b>Automatic feeding:</b> Width: 5.8 to 8.5" (148 to 216 mm) Length (20 pages): 5.5 to 11.7" (140 to 297 mm) Length (5 pages): 5.5 to 14" (140 to 356 mm) <b>Manual feeding:</b> Width: 5.8 to 8.5" (148 to 216 mm) Length: 5.5 to 23.6" (140 to 600 mm)
<b>Effective scanning width</b>	8.3" (210 mm) max.
<b>Effective printing width</b>	8.2" (208 mm) max.
<b>Contrast control</b>	Automatic/Dark selectable
<b>Reception modes</b>	TEL/FAX/AM
<b>Copy function</b>	Single/Multi/Sort (50 copies/page)
<b>Telephone function</b>	Yes (cannot be used if power fails)
<b>Applicable telephone line</b>	Public switched telephone network
<b>Display</b>	16-digit LCD display
<b>Power requirements</b>	120 V AC, 60 Hz
<b>Operating temperature</b>	50 - 86°F (10 - 30°C)
<b>Humidity</b>	20 - 85% RH
<b>Power consumption</b>	Standby: 6.0 W Maximum: 650 W

**Dimensions** (without attachments)

Width: 14.6" (372 mm)  
Depth: 10.2" (259 mm)  
Height: 8.0" (203 mm)

**Weight** (without attachments)

Approx. 11 lbs. (5.0 kg)

As a part of our policy of continuous improvement, SHARP reserves the right to make design and specification changes for product improvement without prior notice. The performance specification figures indicated are nominal values of production units. There may be some deviations from these values in individual units.

**Important:**

This fax machine is not designed for use on a line which has call waiting, call forwarding, or certain other special services offered by your telephone company. If you attempt to use the fax machine in conjunction with any of these services, you may experience errors during transmission and reception of facsimile messages.

The fax machine is not compatible with digital telephone systems.

## ***Important safety information***

Do not disassemble this machine or attempt any procedures not described in this manual. Refer all servicing to qualified service personnel.

Do not install or use the machine near water, or when you are wet. For example, do not use the machine near a bath tub, wash bowl, kitchen sink or laundry tub, in a wet basement, or near a swimming pool. Take care not to spill any liquids on the machine.

Unplug the machine from the power outlet and telephone jack and consult a qualified service representative if any of the following situations occur:

- Liquid has been spilled into the machine or the machine has been exposed to rain or water.
- The machine produces odors, smoke, or unusual noises.
- The power cord is frayed or damaged.
- The machine has been dropped or the housing damaged.

Do not allow anything to rest on the power cord, and do not install the machine where people may walk on the power cord.

This machine must only be connected to a 120 V, 60 Hz, grounded (3-prong) outlet. Connecting it to any other kind of outlet will damage the machine and invalidate the warranty.

Never insert objects of any kind into slots or openings on the machine. This could create a risk of fire or electric shock. If an object falls into the machine that you cannot remove, unplug the machine and consult a qualified service representative.

Do not place this machine on an unstable cart, stand or table. The machine could be seriously damaged if it falls.

Never install telephone wiring during a lightning storm.

Never install telephone jacks in wet locations unless the jack is specifically designed for wet locations.

Never touch bare telephone wires or terminals unless the telephone line has been disconnected at the network interface.

Use caution when installing or modifying telephone lines.

Avoid using a telephone (other than a cordless type) during an electrical storm. There may be a remote risk of electric shock from lightning.

Do not use a telephone to report a gas leak in the vicinity of the leak.

---

# ***Table of Contents***

<b>A Look at the Operation Panel</b>	<b>7</b>
<hr/>	
<b>1. Installation</b>	<b>9</b>
<hr/>	
Unpacking Checklist . . . . .	9
Connections . . . . .	10
Installing the Toner Cartridge . . . . .	15
Loading Printing Paper . . . . .	19
Entering Your Name and Fax Number . . . . .	22
Setting the Date and Time . . . . .	24
Setting the Reception Mode . . . . .	27
Volume Adjustment . . . . .	28
<b>2. Sending Faxes</b>	<b>31</b>
<hr/>	
Transmittable Documents . . . . .	31
Loading the Document . . . . .	32
Adjusting the Resolution and Contrast . . . . .	34
Sending a Fax by Normal Dialing . . . . .	37
Sending a Fax by Automatic Dialing . . . . .	38
Cover Sheet . . . . .	50
Batch Page Numbering . . . . .	52
Broadcasting (Sending a Fax to Multiple Destinations) . . . . .	53
<b>3. Receiving Faxes</b>	<b>58</b>
<hr/>	
Using FAX Mode . . . . .	58
Using TEL Mode . . . . .	59
Optional Reception Settings . . . . .	62
Substitute Reception to Memory . . . . .	65
<b>4. Making Copies</b>	<b>66</b>
<hr/>	
<b>5. Answering Machine Connection</b>	<b>68</b>
<hr/>	
Connecting an Answering Machine . . . . .	68
Using the Answering Machine Connection . . . . .	69

Table of Contents

Optional A.M. Mode Settings . . . . .	70
<b>6. Special Functions</b>	<b>74</b>
<hr/>	
Distinctive Ring (Requires Subscription to Service) . . . . .	74
Blocking Reception of Unwanted Faxes . . . . .	76
Polling (Requesting a Fax Transmission) . . . . .	78
<b>7. Printing Lists</b>	<b>85</b>
<hr/>	
<b>8. Maintenance</b>	<b>90</b>
<hr/>	
Scanning glass and rollers . . . . .	90
The housing . . . . .	91
Replacing the toner cartridge . . . . .	91
Replacing the drum cartridge . . . . .	92
Cleaning the drum cartridge. . . . .	95
<b>9. Troubleshooting</b>	<b>97</b>
<hr/>	
Problems and Solutions . . . . .	97
Messages and Signals . . . . .	102
Clearing Paper Jams . . . . .	105
FCC Regulatory Information . . . . .	109
<b>Quick Reference Guide</b>	<b>114</b>
<hr/>	
<b>Guía de referencia rápida</b>	<b>115</b>
<hr/>	
<b>Index</b>	<b>116</b>
<hr/>	



# A Look at the Operation Panel

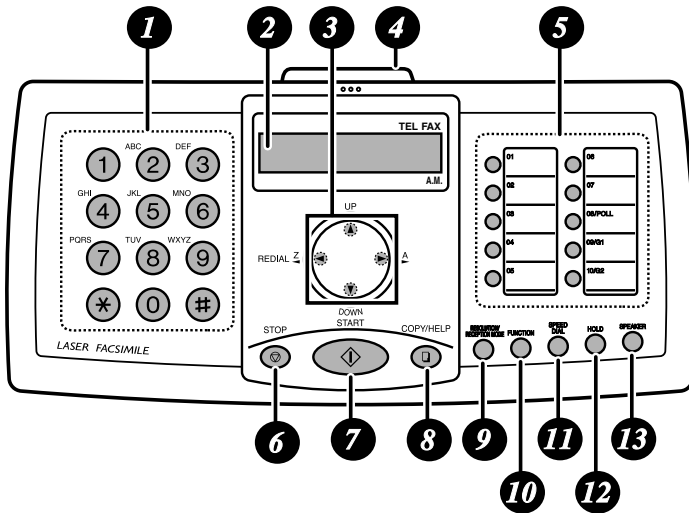

- 1 Number keys**  
Use these keys to dial numbers, and enter numbers and letters when storing auto-dial numbers.
- 2 Display**  
This displays messages and prompts to help you operate the machine.
- 3 Arrow keys**  
Use these keys to scroll through and select settings, and to search for auto-dial numbers. Press the left arrow key (**REDIAL**) to select the last number dialed.
- 4 PANEL RELEASE**  
Pull this release to open the operation panel.
- 5 Rapid Dial Keys**  
Press one of these keys to dial a fax number automatically.
- 6 STOP key**  
Press this key to cancel an operation before it is completed.
- 7 START key**  
Press this key after dialing to begin fax transmission. The key can also be pressed in the date and time display to show the percentage of memory currently used.

8

**COPY/HELP key**

When a document is in the feeder, press this key to make a copy of a document. At any other time, press this key to print out the Help List, a quick reference guide to the operation of your fax machine.

9

**RESOLUTION / RECEPTION MODE key**

When a document is in the feeder, press this key to adjust the resolution for faxing or copying. At any other time, press this key to select the reception mode (an arrow in the display will point to the currently selected reception mode).

10

**FUNCTION key**

Press this key followed by the arrow keys to select special functions and settings.

11

**SPEED DIAL key**

Press this key to dial a fax or voice number using an abbreviated 2-digit Speed Dial number.

12

**HOLD key**

Press this key to put the other party on hold during a phone conversation. When this is done, they cannot hear you. You can put the handset back in the cradle without breaking the connection. When you are ready to speak with the other party again, pick up the handset. If you did not put the handset back in the cradle, press the **HOLD** key again to resume conversation.

13

**SPEAKER key**

Press this key to listen to the line and fax tones through the speaker when faxing a document.

Note: **This is not a speakerphone.** You must pick up the handset to talk with the other party.

# 1. Installation

## Unpacking Checklist

Before setting up, make sure you have all of the following items.

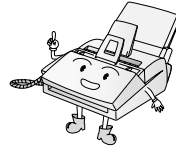

If any are missing, contact your dealer or retailer.

Original document support



Rapid Key labels



Handset



Received document tray



Handset cord



Operation manual



Toner cartridge

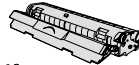

Telephone line cord



Drum cartridge (this is pre-installed in the machine)

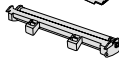

Paper tray



Paper tray cover



### Points to keep in mind when setting up

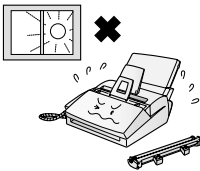

Do not place the machine in direct sunlight.

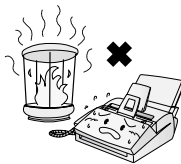

Do not place the machine near heaters or air conditioners.



Keep dust away from the machine.

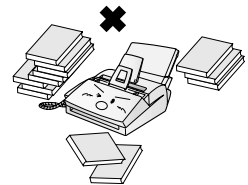

Keep the area around the machine clear.

#### About condensation

If the machine is moved from a cold to a warm place, it is possible that condensation may form on the scanning glass, preventing proper scanning of documents for transmission. To remove the condensation, turn on the power and wait approximately two hours before using the machine.

## Connections

### Connecting the handset

Connect the handset as shown and place it on the handset rest.

- ◆ The ends of the handset cord are identical, so they will go into either socket.

Make sure the handset cord goes into the jack marked with a handset symbol on the side of the machine!

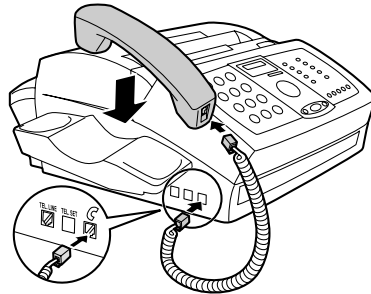
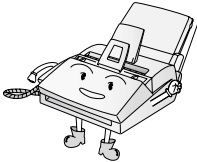

Use the handset to make ordinary phone calls, or to transmit and receive faxes manually.

### Connecting the power cord

Plug the power cord into a 120 V, 60 Hz, grounded AC (3-prong) outlet.

- ◆ Do not plug the power cord into any other kind of outlet. This will damage the machine and is not covered under the warranty.

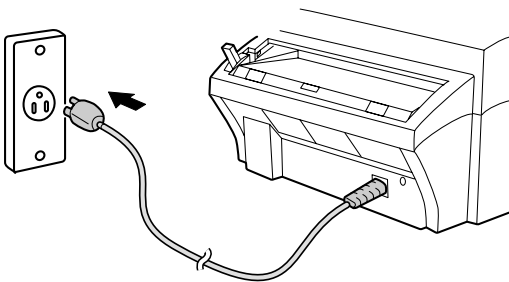

The machine does not have a power on/off switch, so the power is turned on and off by simply plugging in or unplugging the power cord.



## Connecting the telephone line cord

Insert one end of the line cord into the socket on the back of the machine marked **TEL. LINE**. Insert the other end into a wall telephone socket.

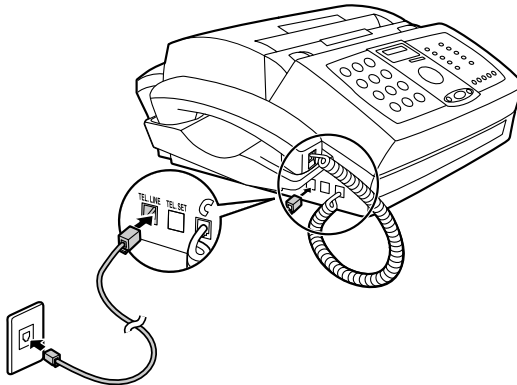

Make sure that the line cord is inserted into the **TEL. LINE** jack. Do not insert it into the **TEL. SET** jack!

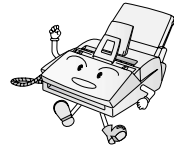

### Setting the dial mode:

The fax machine is set for tone dialling. If you are on a pulse dial line, you must set the fax machine for pulse dialling. Press the keys on the operation panel as follows:

**1** Press **FUNCTION**  once and  3 times.

Display:

OPTION SETTING 

**2** Press  once and  6 times.

DIAL MODE 

**3** Press  once.

1=TONE, 2=PULSE

**4** Select the dial mode:

TONE:  PULSE: 

The display briefly shows your selection, then:

QUIET TIME 

**5** Press **STOP**  to exit.

**Comments:**

- ◆ The fax machine is not designed for use on a line which has call waiting, call forwarding, or certain other special services offered by your telephone company. If you attempt to use the fax machine in conjunction with any of these services, you may experience errors during transmission and reception of facsimile messages.
- ◆ The fax machine is not compatible with digital telephone systems.
- ◆ If your area experiences a high incidence of lightning or power surges, we recommend that you install surge protectors for the power and telephone lines. Surge protectors can be purchased from your dealer or at most telephone specialty stores.

***Attaching the paper trays***

Attach the paper tray

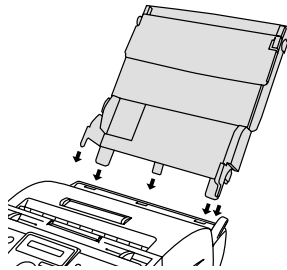

Attach the paper tray cover

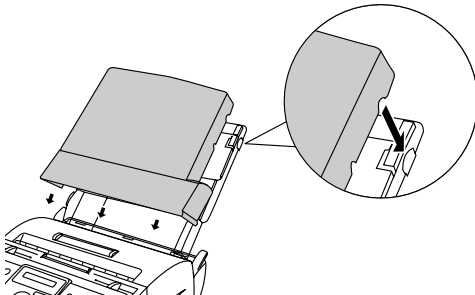

If you will be loading legal paper, flip up the paper tray extension and extend the cover before attaching the cover

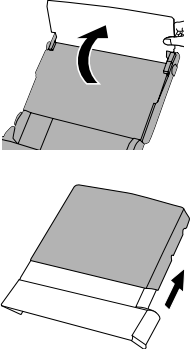

Attach the received document tray

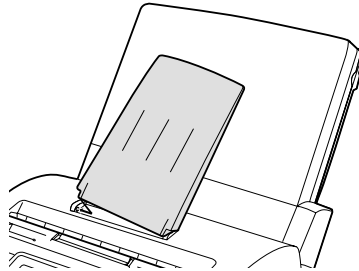
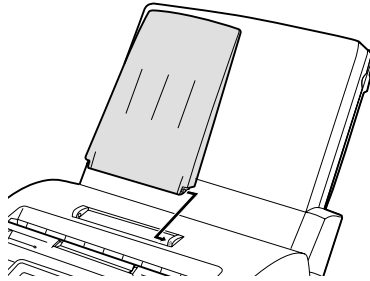

Attach the original document support

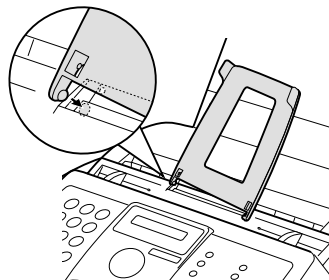
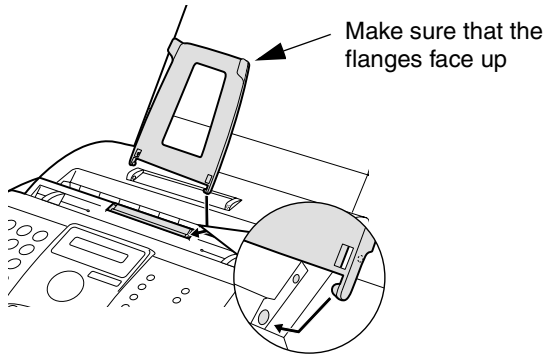

## Extension phone (optional)

If desired, you can connect an extension phone to the **TEL. SET** jack on the machine.

- ◆ To connect an answering machine to the machine, see page 68.

- 1** Remove the seal covering the **TEL. SET** socket.

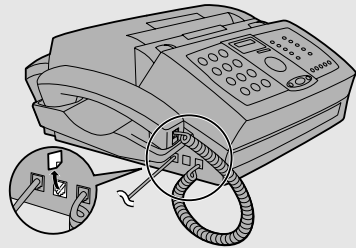

- 2** Connect the extension phone line to the **TEL. SET** socket.

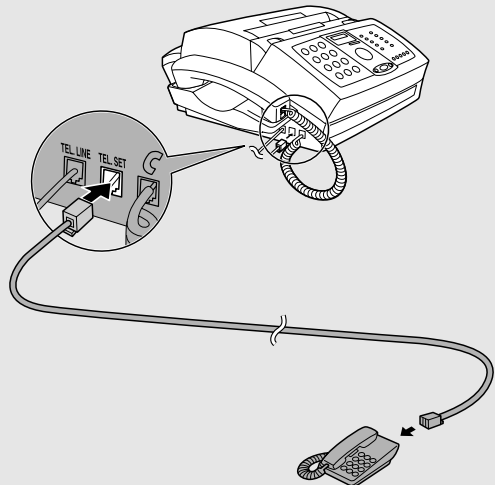



## Installing the Toner Cartridge

The laser printer in your fax machine uses a toner cartridge and a drum cartridge. The drum cartridge comes pre-installed, and the toner cartridge must be installed.

The starter toner cartridge included with your fax can print approximately 1,800 letter-size pages at 4% page coverage.

When replacing the toner cartridge, use a Sharp FO-29ND toner cartridge. One cartridge can print about 3,700 letter-size pages at 4% coverage.

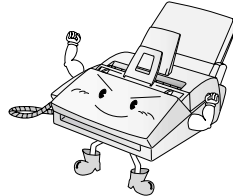

- ◆ The drum cartridge can print approximately 20,000 letter-size pages. When replacing the drum cartridge, use a Sharp FO-29DR drum cartridge.

Follow the steps below to install the toner cartridge and prepare the drum cartridge.

- 1 Grasp the print compartment cover at both sides as shown, and pull up to open the cover.**

- **Caution!**

The fusing unit inside the print compartment becomes very hot during operation. Do not touch the inside of the compartment or the paper guide on the underside of the print compartment cover.

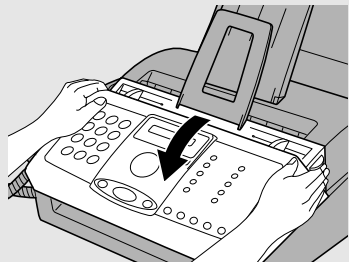

**2** The drum cartridge has been installed at the factory. Grasp the tabs on the drum cartridge handle with both hands and gently pull the cartridge out of the machine. Remove the sheet of protective paper from the cartridge and then insert it back into the machine.

- When removing the drum cartridge, be careful not to tear the paper or leave any pieces of paper in the machine.

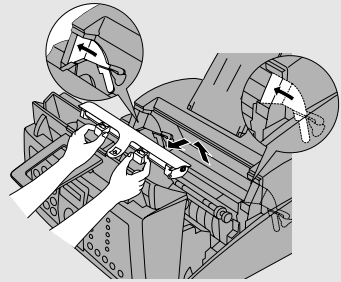

**3** Remove the new toner cartridge from its packaging. Shake the cartridge side to side four or five times to distribute the toner evenly within the cartridge.

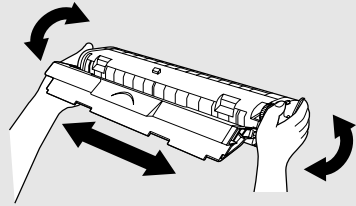

**4** Hold the toner cartridge by the handle with the stamped markings on the cartridge facing upwards, and insert the cartridge into the print compartment.

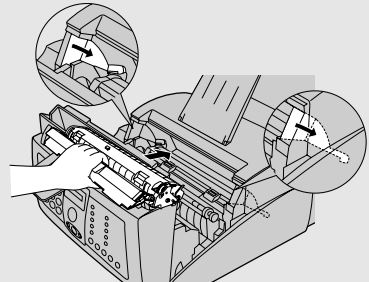

**5** Place your thumb on the center of the handle where it is marked PUSH, and push the handle down and in so that the cartridge fits into place.

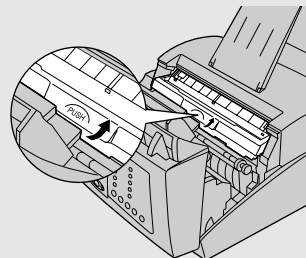

- 6** Close the print compartment cover, pressing down firmly on each side to make sure it is completely closed.

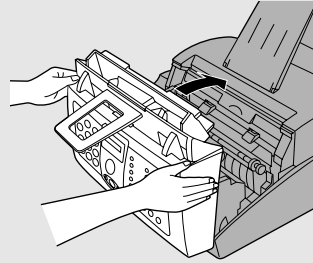

- 7** Reset the toner counter and the drum counter as explained below and on the following page.

### Resetting the toner counter

Each time you install a new toner cartridge, follow the steps below to reset the toner counter to zero. (The machine uses the toner counter to inform you when the toner cartridge needs to be replaced.)

- 1** Press **FUNCTION** once and **DOWN** four times.

Display:

PRINT SET-UP

- 2** Press **RIGHT** once and **UP** twice.

CLR TONER CNT.

- 3** Press **RIGHT** once.

PRESS START KEY











- 4** Press **START**.

CLR DRUM COUNT

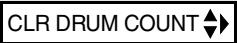
- 5** Press **STOP** to exit.

## ***Resetting the drum counter***

Each time you install a new drum cartridge, follow the steps below to reset the drum counter to zero.

<b>1</b> Press  once and  four times.	Display: 
<b>2</b> Press  once and  once.	
<b>3</b> Press  once.	
<b>4</b> Press  .	
<b>5</b> Press  to exit.	

## Loading Printing Paper

You can load up letter, A4 or legal paper in the paper tray.

- ◆ Up to 200 sheets of 20 lb. (70 g/m<sup>2</sup>) paper can be loaded.
- ◆ Up to 180 sheets of 21.5 lb. (80 g/m<sup>2</sup>) paper can be loaded.

### Caution!

Do not use the blank side of paper that has already been printed on.

- 1** Remove the paper tray cover.

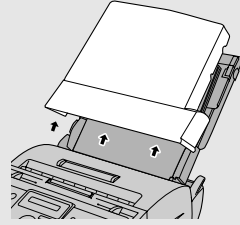

- 2** If you are going to load legal size paper, flip up the paper tray extension and extend the paper tray cover.

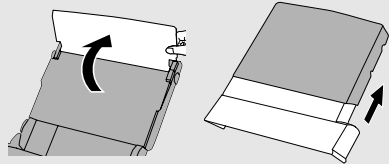

- 3** Fan the paper, and then tap the edge against a flat surface to even the stack.

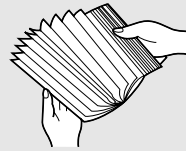

- 4** Pull the paper release lever toward you.

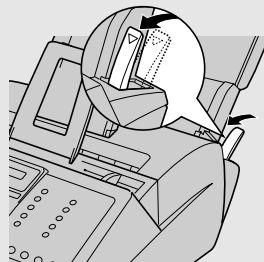

**5 Insert the stack of paper firmly into the tray, print side up.**

- Make sure that the stack is not higher than the marked line. Loading too much paper may cause paper jams and misfeeds.
- If paper remains in the tray, take it out and combine it into a single stack with the new paper before adding the new paper.

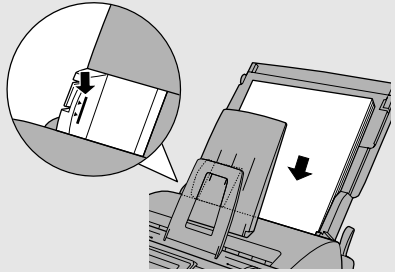

**Important:**

Be sure to load the paper so that printing takes place on the **print** side of the paper. Printing on the reverse side may result in poor print quality.

**6 Make sure the stack of paper is aligned against the right paper guide, and then gently move the left paper guide to the 8 1/2 position for letter or legal paper, or the A4 position for A4 paper.**

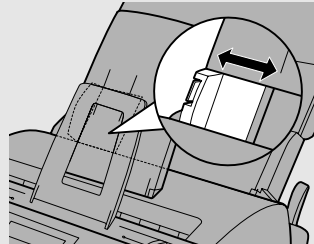

**7 Push the paper release lever back down.**

- **Note:** If the paper does not feed correctly, remove the entire stack from the tray and repeat the loading procedure from the beginning.



**8 Replace the paper tray cover.**

- If you loaded other than letter size paper (or you changed the paper size), change the paper size setting as explained on the following page.

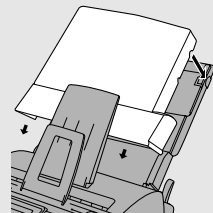



## Setting the paper size

The fax has been set at the factory to scale received faxes to letter size paper. If you loaded legal or A4 size paper, you must change the paper size setting to LEGAL or A4.

**1** Press <sup>FUNCTION</sup>  once and  four times.

Display:

PRINT SET-UP 

**2** Press  once and  once.

PAPER SIZE SET 

**3** Press  once.

1:LETTER

**4** Select the paper size:

LETTER: 

LEGAL: 

A4: 

The display briefly shows your selection, then:

COPY CUT-OFF 

**5** Press <sup>STOP</sup>  to return to the date and time display.

## Entering Your Name and Fax Number

Before you can begin sending faxes, you must enter your name and fax (telephone) number. You also need to set the date and time.



Once you enter this information, it will automatically appear at the top of each fax page you send.

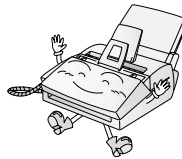

### Important!

FCC regulations require that your name, telephone/fax number, and the date and time appear on each fax message you send. Enter your name and fax number here and set the date and time as explained in the following section to have the fax machine include this information automatically at the top of your fax messages.

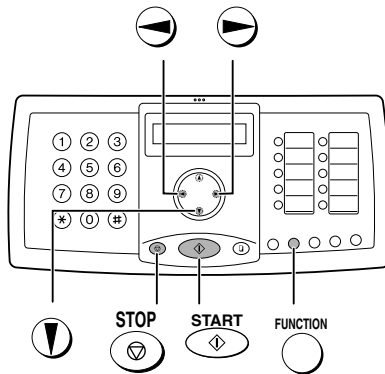

**1** Press **FUNCTION** once and **STOP** twice.

Display:

ENTRY MODE

**2** Press **START** once.



OWN NUMBER SET

**3** Press **START** once.

ENTER FAX #





























































**4 Enter your fax number by pressing the number keys (max. 20 digits).**



- To insert a space between digits, press .
- To clear a mistake, press .



**5 Press .**

**6 Enter your name by pressing number keys for each letter as shown in the chart below. Up to 24 characters can be entered.**

Example: SHARP = 7777 44 2 777  7

SPACE = 	G = 	N =  	U =  
A = 	H =  	O =   	V =   
B =  	I =   	P = 	W = 
C =   	J = 	Q =  	X =  
D = 	K =  	R =   	Y =   
E =  	L =   	S =    	Z =    
F =   	M = 	T = 	

- ◆ To enter two letters in succession that require the same key, press  after entering the first letter. To clear a mistake, press .

- ◆ To enter a lower case letter, continue pressing the key for the letter until the lower case letter appears. To enter one of the following symbols, press  or  repeatedly: . / ! " # \$ % & ' ( ) \* + , - : ; < = > ? @ [ ¥ ] ^ \_ ' { | } → ←

**7 Press .**

Display:

SECURITY 

**8 Press  to return to the date and time display.**

## Setting the Date and Time

The date and time appear in the display and are printed at the top of every page you fax. Set the date and time as shown below.

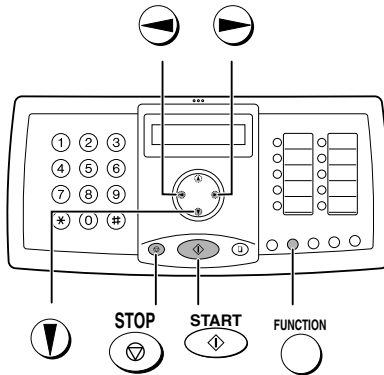
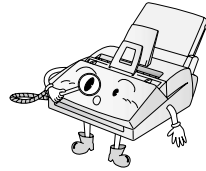

**1** Press **FUNCTION** once and **▼** twice.

Display:

ENTRY MODE **↕**

**2** Press **▶** once and **▼** 3 times.

DATE&TIME SET **↕**

**3** Press **▶**. The currently set date appears (example):

DATE 08-15-2003



**4** Enter a two-digit number for the month ("01" for January, "02" for February, "12" for December, etc.).

Example: January **0** **1**

→ DATE 01-15-2003

- To correct a mistake, press **◀** to move the cursor back to the mistake and then enter the correct number.

**5** Enter a two-digit number for the day (“01” to “31”).

Example: the 5<sup>th</sup>   →



**6** Enter the year (four digits).

Example: 2003    

**7** Enter a two-digit number for the hour (“01” to “12”) and a two-digit number for the minute (“00” to “59”).

Example: 9:25     →

**8** Press  to select A.M. or  to select P.M.

**9** Press  to start the clock. →  

**10** Press  to return to the date and time display.



## Daylight Saving Time



If desired, you can set the clock to move forward and backward automatically at the beginning and end of Daylight Saving Time. Follow these steps:

**1** Press <sup>FUNCTION</sup>  once and  3 times.

Display:



OPTION SETTING  

**2** Press  once and  twice.

DAY LIGHT SAVE  

**3** Press  once.

1=YES, 2=NO

**4** Press  to select YES, or  to select NO.

BEEP LENGTH  

**5** Press <sup>STOP</sup>  to return to the date and time display.

## Setting the Reception Mode

Your fax machine has three modes for receiving incoming faxes:

### FAX mode:

Select this mode when you only want to receive faxes on your line. The fax machine will automatically answer all calls on four rings and receive incoming faxes.

### TEL mode:

Select this mode when you want to receive both phone calls and faxes on the line connected to the fax machine. **All calls, including faxes, must be answered by picking up the fax machine's handset** or an extension phone connected to the same line.

### A.M. mode:

Use this mode only if you have connected an answering machine to the fax machine (see Chapter 5). Select this mode when you go out to receive voice messages in your answering machine and faxes on your fax machine.

## Setting the reception mode

Make sure a document *is not loaded in the document feeder*, and then

press  until the arrow in the display points to the desired mode.

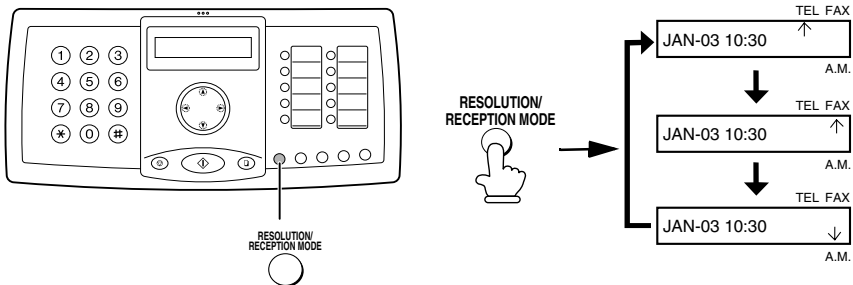

For more information on receiving faxes in FAX and TEL modes, see Chapter 3, *Receiving Faxes*. For more information on using A.M. mode, see Chapter 5.

## Volume Adjustment

You can adjust the volume of the speaker, handset, and ringer using the up and down arrow keys.

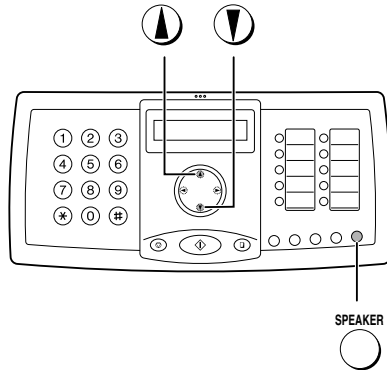

### Speaker

**1** Press .



**2** Press  or  to select the desired volume level.

- Press  again to turn off the speaker.

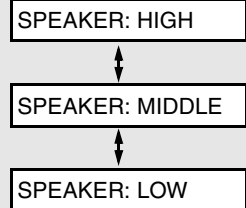
Display:



## Handset

**1** When talking through the handset, press  or  to select the desired volume level.

- **Note:** The volume reverts to MIDDLE each time you replace the handset.

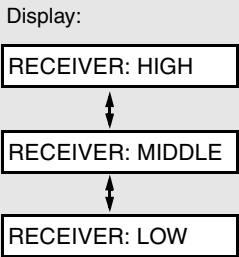



## Ringer

**1** Press  or  to select the desired volume level.

(Make sure  has not been pressed, the handset is not lifted, and a document is not loaded in the feeder.)

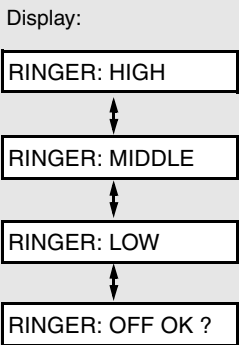
- The ringer will ring once at the selected level.



**2** If you selected RINGER: OFF OK ? to turn off the ringer, press .



## Beep length

Your fax machine normally signals the end of transmission, reception, or copying with a 3-second beep. If desired, you can change the duration of the beep to 1 second or turn the beep off.

**1** Press <sup>FUNCTION</sup>  once and  3 times.

Display:



OPTION SETTING 

**2** Press  once and  once.

BEEP LENGTH 

**3** Press  once.

1=3SEC, 2=1SEC

**4** Press  to select 3 seconds,  to select 1 second, or  to select NO BEEP.

The display briefly shows your selection, then:

FINE PRIORITY 

**5** Press <sup>STOP</sup>  to return to the date and time display.



## 2. Sending Faxes

### Transmittable Documents

#### Size and weight

##### Minimum document size:

Minimum size

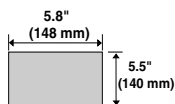

Minimum weight

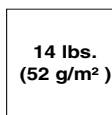

##### Maximum document size:

The maximum size and weight of documents that you can load in the document feeder depend on how many pages you load.

##### 20 pages at once:

**Size:** Letter

(8.5" x 11", 216 x 279 mm)

**Weight:** 21.5 lbs. (80 g/m<sup>2</sup>)

##### 1 page at a time (manual feeding):

**Size:** 8.5" x 23.6" (216 x 600 mm)

**Weight:** 42 lbs. (157 g/m<sup>2</sup>)

##### 5 pages at once:

**Size:** Legal

(8.5" x 14", 216 x 356 mm)

**Weight:** 21.5 lbs. (80 g/m<sup>2</sup>)

Letters or graphics on the edges of a document will not be scanned. (The margin at each side of the document is 0.12" (3 mm) and the margin at the top and bottom is 0.16" (4mm).)

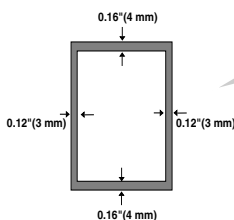

Letters in the shaded area will not be scanned.

## ***Other restrictions***

- ◆ The scanner cannot recognize yellow, greenish yellow, or light blue ink.
- ◆ Ink, glue, and correcting fluid on documents must be dry before they pass through the document feeder.
- ◆ All clips, staples, and pins must be removed from documents before loading in the feeder. If these are not removed, they may damage the machine.
- ◆ Documents which are patched, taped, torn, smaller than the minimum size, carbon backed, easily smudged, or have a slick coated surface should be photocopied, and the copy loaded in the feeder.

## ***Loading the Document***

Up to 20 letter-size pages, or 5 legal-size pages, can be placed in the feeder at once. The pages will automatically feed into the machine starting from the bottom page.

- ◆ If you need to send or copy more than the maximum number of pages, place the additional pages gently and carefully in the feeder just before the last page is scanned. Do not try to force them in, as this may cause double-feeding or jamming.
- ◆ If your document consists of several large or thick pages which must be loaded one at a time, insert each page into the feeder as the previous page is being scanned. Insert gently to prevent double-feeding.

- 
- 1** Adjust the document guides to the width of your document.

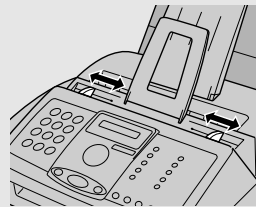

- 
- 2** Insert the document face down in the document feeder. The top edge of the document should enter the feeder first.

- READY TO SEND will appear in the display.

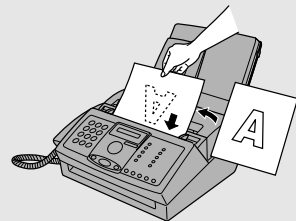

- 3 Adjust the resolution and/or contrast settings as explained on page 34, then dial the receiving machine as explained on page 37.

## Removing a document from the feeder

If you need to remove a document from the feeder, open the operation panel.

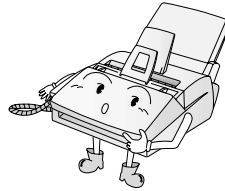

### Important!

Do not try to remove a document without opening the operation panel. This may damage the feeder mechanism.

- 1 Open the operation panel.

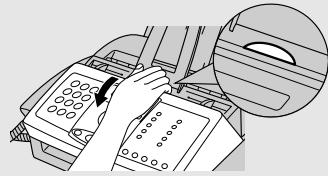

- 2 Remove the document.

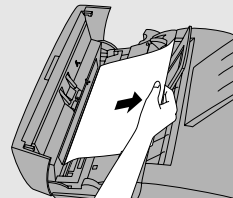

- 3 Close the operation panel, pressing down firmly on both front corners to make sure it clicks into place.

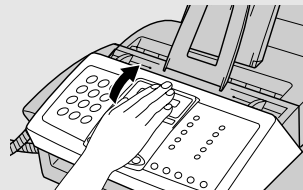

## ***Adjusting the Resolution and Contrast***

If desired, you can adjust the resolution and contrast before sending a document.

The default resolution setting is STANDARD and the default contrast setting is AUTO.



You must adjust the settings each time you don't want to use the default settings.

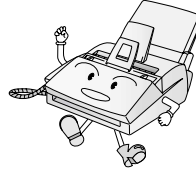

**Note:** The resolution and contrast settings are only effective for sending a document. They are not effective for receiving a document.

### ***Resolution settings***

STANDARD	Use STANDARD for ordinary documents. This setting gives you the fastest and most economical transmission.
FINE	Use FINE for documents containing small letters or fine drawings.
SUPER FINE	Use SUPER FINE for documents containing very small letters or very fine drawings.
HALF TONE	Use HALF TONE for photographs and illustrations. The original will be reproduced in 64 shades of gray.

### ***Contrast settings***

AUTO	Use AUTO for normal documents.
DARK	Use DARK for faint documents.

## 1 Load the document(s).

- The document must be loaded before the resolution and contrast can be adjusted.

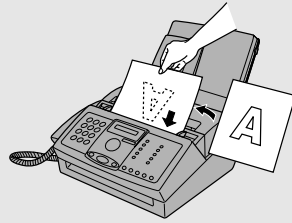

## 2 Press one or more times until the desired resolution and contrast settings appear in the display.

- The first time you move through the list of resolution settings, the contrast setting AUTO will appear next to each resolution setting. The second time you move through the list, the contrast setting DARK will appear.

Display:

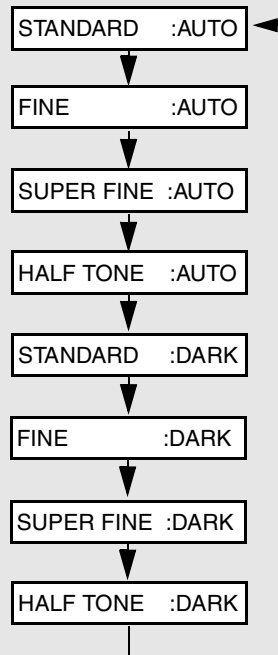

**Note:** In order to transmit in SUPER FINE resolution, the receiving fax machine must also have that resolution. If it doesn't, your machine will automatically step down to the next best available setting.

## Changing the default resolution

If desired, you can change the default resolution for faxing documents to FINE. Follow the steps below.

**1** Press <sup>FUNCTION</sup>  once and  3 times.



Display: OPTION SETTING 

**2** Press  once.

FINE PRIORITY 

**3** Press  once.

1=YES, 2=NO

**4** Press  to set the default resolution to FINE, or  to set it to STANDARD.

The display briefly shows your selection, then:

NUMBER OF RING 

**5** Press <sup>STOP</sup>  to return to the date and time display.

## Sending a Fax by Normal Dialing

With Normal Dialing, you pick up the handset (or press ) and dial by pressing the number keys.

◆ If a person answers, you can talk with them through the handset before sending the fax. (If you pressed , you must pick up the handset to talk.)

◆ Normal Dialing allows you to listen to the line and make sure the other fax machine is responding.

### 1 Load the document(s).

- If desired, press  to set the resolution and/or contrast.

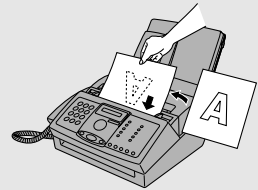

READY TO SEND

### 2 Pick up the handset or press . Listen for the dial tone.

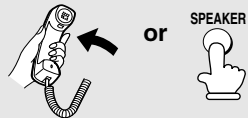

### 3 Dial the number of the receiving machine by pressing the number keys.



### 4 Wait for the connection. Depending on the setting of the receiving machine, you will either hear a fax tone or the other person will answer.

- If the other party answers, ask them to press their Start key (if you pressed , pick up the handset to speak with them). This causes the receiving machine to issue a fax tone.

**5** When you hear the fax tone, press . Replace the handset.

- If the transmission is completed successfully, the machine will beep once.
- If an error occurs, the machine will beep three times and print a Transaction Report to inform you of the problem (see page 87).

## ***Sending a Fax by Automatic Dialing***

You can dial a fax or phone number by simply pressing a Rapid Key, or by

pressing  and entering a two-digit number.

- ◆ To use Automatic Dialing, you must first store the full fax or phone number in your fax machine.
- ◆ When you store a fax or phone number, you select a two-digit Speed Dial number for it. Ninety-nine Speed Dial numbers are available.

Speed Dial numbers 01 through 10 are for Rapid Key (one-touch) Dialing.

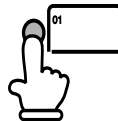

Speed Dial numbers 11 through 99 are for

dialing with  .

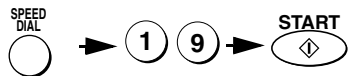



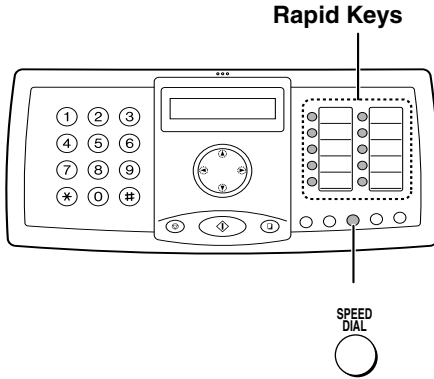

Attach the Rapid Key labels above the Rapid Keys.

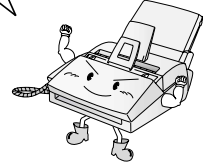



When you store a number in a Rapid Key, write the name of the party on the label.

### Storing fax and phone numbers for automatic dialing

**1** Press **FUNCTION**  once and  once.

Display:

<NEW NUMBER> 

**2** If you know the Speed Dial number that you want to use, enter that number (for example, press   for Speed Dial 01).

ENTER FAX #

Otherwise, press  once (the machine will suggest an available Speed Dial number at the end of the storing procedure).

Speed Dial numbers 01 to 10 can be used for Rapid Key Dialing. Speed Dial numbers 11 to 99 are only for Speed Dialing.

**3** Enter the fax or phone number by pressing the number keys. (Note: A space cannot be entered.)

























































- To clear a mistake, press **SPEAKER** .



- If a pause is required between any of the digits to access a special service or an outside line, press **FUNCTION** . The pause appears as a hyphen (two seconds per pause). Several pauses can be entered in a row.

**4** Press .

**5** Enter a name by pressing number keys for each letter as shown in the chart below. Up to 20 characters can be entered. (If you do not wish to enter a name, go directly to Step 6.)

Example: SHARP = 7777 44 2 777  7

SPACE = 	G = 	N =  	U =  
A = 	H =  	O =   	V =   
B =  	I =   	P = 	W = 
C =   	J = 	Q =  	X =  
D = 	K =  	R =   	Y =   
E =  	L =   	S =    	Z =    
F =   	M = 	T = 	

- ◆ To enter two letters in succession that require the same key, press  after entering the first letter.
- ◆ To enter a lower case letter, continue pressing the key for the letter until the lower case letter appears.
- ◆ To enter one of the following symbols, press  or  repeatedly:  
 . / ! " # \$ % & ' ( ) \* + , - : ; < = > ? @ [ \ ] ^ \_ ' { | } → ←

**6** Press .

If you selected a Speed Dial number in Step 2, the display will briefly show STORED, and then <NEW NUMBER>. Go to Step 7.

If you did not select a Speed Dial number in Step 2, the display will show the next available Speed Dial number. If that number is acceptable,

press  and go to Step 7. If not, enter the desired two digit number,

press , and go to Step 7.

- 7** Return to Step 2 to store another number, or press  to return to the date and time display.





## Editing and clearing auto-dial numbers

If you need to make changes to a previously stored auto-dial number, or clear a number, follow these steps:

- 1** Press  once and  once.

Display:

<NEW NUMBER> 

- 2** Enter the 2-digit Speed Dial number that you wish to edit or clear (for example, press  ), or press  or  until the number appears in the display.



- 3** Press .

1=EDIT, 2=CLEAR

- 4** Press  for EDIT or  for CLEAR.

- If you selected CLEAR, go to Step 8.

- 5** If you selected EDIT, make the desired changes to the number.



- Press  or  to move the cursor to the digit or digits you wish to change, and then enter the new digit. The new digit will replace the old digit.
- If you do not wish to change the number, go directly to Step 6.

---

**6** Press  .

---

**7** Make the desired changes to the name.

- Press  or  to move the cursor to the letter or letters you wish to change, and then press the appropriate number key repeatedly until the desired letter appears (see Step 5 on page 40). The new letter will replace the old letter.
- If you do not wish to change the name, go directly to Step 8.

---

**8** Press  .

---

**9** Return to Step 2 to edit or clear another number, or press  to return to the date and time display.

## Rapid Key Dialing

If the number you want to dial has been stored as a Speed Dial number from 01 to 10, you can dial it by pressing the corresponding Rapid Key.

### 1 Load the document(s).

- If desired, press  to set the resolution and/or contrast.

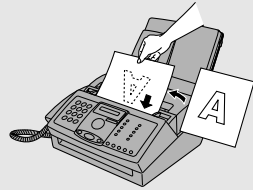

READY TO SEND

### 2 Press the Rapid Key corresponding to the desired Speed Dial number.

- The name of the receiving party will appear in the display. If no name was stored, the fax number will appear. (If the name or number is incorrect, press

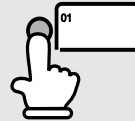

Example: To dial Speed Dial number 01, press Rapid Key 01.

- The document will be automatically transmitted once the connection is established.
- If the transmission is completed successfully, the machine will beep once.
- If an error occurs, the machine will beep three times and print a Transaction Report to inform you of the problem (see page 87).

#### Using a Rapid Key for a voice call

To use a Rapid Key for a voice call, simply lift the handset and then press the Rapid Key.

## Speed Dialing

Speed Dialing can be used to dial any number that has been stored as a Speed Dial number.

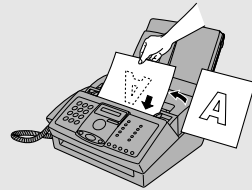

### 1 Load the document(s).

- If desired, press  to set the resolution and/or contrast.



READY TO SEND

### 2 Press and then enter the 2-digit Speed Dial number.

- For example, to enter Speed Dial number 19, press  .

### 3 Check the display. If the name or number shown is correct, press

. (If not, press  and repeat Step 2.)

- If the transmission is completed successfully, the machine will beep once.
- If an error occurs, the machine will beep three times and print a Transaction Report to inform you of the problem (see page 87).

#### Using a Speed Dial number for a voice call

To use a Speed Dial number for a voice call, lift the handset, press , and enter the Speed Dial number.

## Searching for an auto-dial number



If you don't remember the Rapid Key or Speed Dial number in which you have stored a full fax or phone number, follow these steps to search for the number.

**1** If you are sending a fax, load the document(s).

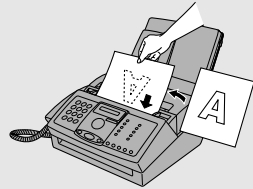
- If desired, press  to set the resolution and/or contrast.



READY TO SEND

**2** Press  **A** (or **REDIAL**  **Z**) until the name of the other party appears in the display (if no name was stored, the number will appear).

**3** If you are sending a fax, press  **START**. Dialing and transmission begins.

- If the transmission is completed successfully, the machine will beep once.
- If an error occurs, the machine will beep three times and print a Transaction Report to inform you of the problem (see page 87).

If you are making a phone call, lift the handset. Dialing begins. (If you lifted the handset before searching for the number, press  **START** to begin dialing.)

## ***Sending a fax by Direct Keypad Dialing***

You can also enter a full number with the number keys and then press the  key to begin dialing. You can use this method to dial a full number when you don't need to speak to the other party before faxing.

### **1 Load the document(s).**

- If desired, press  to set the resolution and/or contrast.

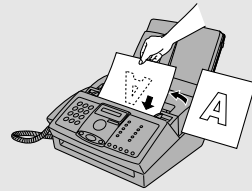

### **2 Enter the number of the receiving machine by pressing the number keys.**

- If a pause is required between any of the digits to access a special service or an outside line, press . The pause will appear as a hyphen (two seconds per pause). Several pauses can be entered in a row.

### **3 Check the display. If the number of the receiving machine shown is correct, press .**

- If the number is not correct, press  to backspace and clear one digit at a time, and then re-enter the correct digit(s).



## Redial

You can automatically redial the last number dialed on the fax machine. This procedure can be used to send a fax or make a phone call.

### 1 If you are sending a fax, load the document(s).

- If desired, press  to set the resolution and/or contrast.

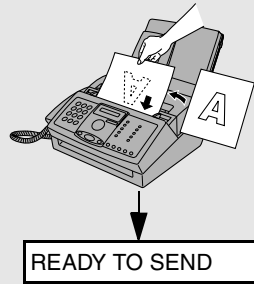

### 2 Press **REDIAL** once. **<REDIAL>** appears in the display, followed by the last number dialed. Make sure the number that appears is the number you wish to dial.

### 3 If you are sending a fax, press **START** . Dialing begins.

If you are making a phone call, lift the handset. Dialing begins.











## Automatic redialing

If you use automatic dialing (including Direct Keypad Dialing) to send a fax and the line is busy, the fax machine will automatically redial the number. The fax machine will make two redial attempts at intervals of five minutes. During this time, **RECALLING** will appear in the display, followed by a two-digit number assigned to the fax job. You will not be able to dial any other locations while the message appears.

- ◆ You can press **STOP**  to clear the message and stop automatic redialing.
- ◆ Under certain conditions (for example if a person answers the call on a telephone), automatic redialing may stop before the set number of redial attempts are made.







## ***Recall interval for automatic redialing***

If desired, you can change the interval at which the fax machine makes automatic redialing attempts.



<b>1</b> Press <sup>FUNCTION</sup>  once and  3 times.	Display: OPTION SETTING 
<b>2</b> Press  once and  2 times.	RECALL INTERV. 
<b>3</b> Press  once.	ENTER (01-15) 05
<b>4</b> Press the numeric keys to enter the desired interval in minutes (any 2-digit number from 01 to 15). Example: 1 minute  	The display briefly shows your selection, then: RECALL TIMES 
<b>5</b> Press <sup>STOP</sup>  to exit.	

## ***Recall times for automatic redialing***

If desired, you can change the maximum number of automatic redialing attempts made when the line is busy.

<b>1</b> Press <sup>FUNCTION</sup>  once and  3 times.	Display: OPTION SETTING 
<b>2</b> Press  once and  3 times.	RECALL TIMES 
<b>3</b> Press  once.	ENTER (00-10) 02

**4** Press the numeric keys to enter the desired number of recall attempts (any 2-digit number from 00 to 10).

Example: 5 attempts  

The display briefly shows your selection, then:

FAX REMOTE # 

**5** Press  to exit.

### Error Correction Mode



The fax machine is set to automatically correct any distortions in a transmission due to noise on the telephone line before printing at the receiving end. This function is called Error Correction Mode (ECM). ECM is effective for both transmissions and receptions, and is only effective when the other fax machine has ECM as well.

When there is considerable noise on the line, you may find that transmission with ECM turned on takes longer than normal. If you prefer a faster transmission time, you can try turning ECM off.

**1** Press  once and  3 times.

Display:



OPTION SETTING 

**2** Press  once and  3 times.

ECM MODE 

**3** Press  once.

1=YES, 2=NO

**4** Press  to select YES, or  to select NO.

The display briefly shows your selection, then:

DAY LIGHT SAVE 

**5** Press  to return to the date and time display.

## Cover Sheet

You can have the fax machine generate a cover sheet and send it as the last page of your fax transmission. The cover sheet includes the date and time, the receiver's name and number if a Rapid Key or Speed Dial number is used, the sender's name and number, and the total number of pages.

- ◆ Your name and number must be programmed in order for them to appear on the cover sheet (see page 22).
- ◆ To have the recipient's name appear, you must dial using a Rapid Key or Speed Dial number with the name programmed.

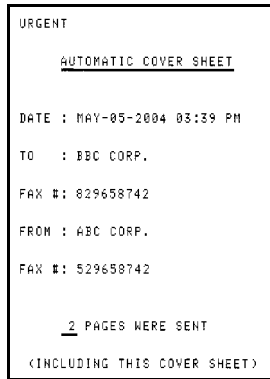



(Example)

Follow the steps below to turn on the cover sheet function. A cover sheets is automatically added to each fax transmission while the function is turned on. (To stop adding a cover sheet to your faxes, turn the function off.)

**1** Press **FUNCTION**  once and  **3 times.**

Display:

OPTION SETTING 

**2** Press  once and  **5 times.**

COVER SHEET 

**3** Press  **once.**

1=YES, 2=NO

**4** Press **1** to select YES, or **2** to select NO.

The display briefly shows your selection, then:

AUTO PRINT OUT 

- 5** Press  to return to the date and time display.

## Header message

You can select one of four messages to add as a header to a cover sheet. The message is selected at the time of transmission and is effective for one transmission only.

- ◆ To select a message, the cover sheet function must be turned on.
- ◆ The following messages can be selected:  
URGENT, IMPORTANT, CONFIDENTIAL, PLS. DISTRIBUTE

### 1 Load the document(s).

- If desired, press  to set the resolution and/or contrast.

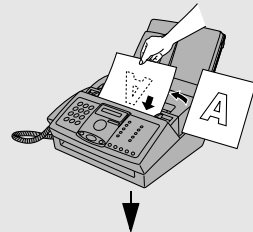

READY TO SEND

- 2** Press  once and  twice.

HEADER MESSAGE 

- 3** Press .

### 4 Press a number key to select a message:

**1** : URGENT

**2** : IMPORTANT

**3** : CONFIDENTIAL

**4** : PLS. DISTRIBUTE

- 5** Dial the receiving fax machine and send the fax.

## Batch Page Numbering

You can change the page numbering of the transmitted document from simple numbering ("P.01", "P.02", etc.) to batch numbering, which means that a slash and the total number of pages being sent are added after each page number (for example, "P. 01/05", "P.02/05", etc.). This allows the recipient to check for missing pages.

### 1 Load the document(s).

- If desired, press  to set the resolution and/or contrast.

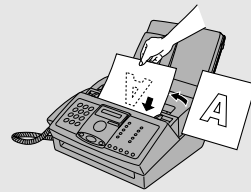

READY TO SEND

### 2 Press once and once.

Display:

PAGE COUNTER 

### 3 Press once.

ENTER # (01 - 99)

### 4 Enter the total number of pages ("01" to "99") by pressing the numeric keys.

Example: 5 pages  

### 5 Dial the receiving machine and send the fax.

- ◆ If you need to cancel a batch number entry, remove the document from the

feeder or press .

- ◆ If the number of pages actually transmitted does not coincide with the batch number entered, the alarm will sound and PAGE COUNT ERROR will appear in the display. PAGE E. will also appear in the NOTE column of the Transaction Report if printed.

## Broadcasting (Sending a Fax to Multiple Destinations)

This function allows you to send the same fax to as many as 20 different destinations in just one operation.



- ◆ When sending to multiple destinations, only auto-dial numbers can be used to dial the numbers of the receiving machines.

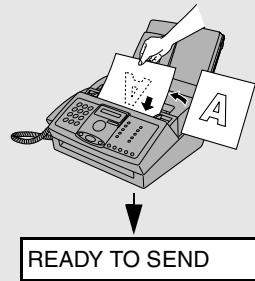

### 1 Load the document(s).

- If desired, press  to set the resolution and/or contrast.





### 2 Select a destination using one of the methods below.

**IMPORTANT:** The first destination that you select must be specified using the arrow key method below (press  or ). Do not press a Rapid Key or enter a Speed Dial number for the first destination.

- Press  or  until the name of the destination appears in the display (if no name was stored, the number will appear).
- Press a Rapid Key (if other than the first destination).
- Press  and enter a 2-digit Speed Dial number (if other than the first destination).

### 3 Press to store the destination.

**4 Repeat Steps 2 and 3 for each of the other destinations to which you wish to send the fax (maximum of 20).**

- To check your selected destinations, press  to scroll through them. To delete a destination, scroll to the destination and then press .

**6 When you are ready to begin transmission, press .**

- A Transaction Report is automatically printed out after Broadcasting is completed. Check the "Note" column of the report to see if any of the destinations are marked "Busy" or have a communication error code. If so, send the document to those destinations again.

## ***Broadcasting using a Group Key***

If the fax machines to which you want to broadcast have all been programmed into one Group Key (see *Storing numbers in Group Keys* which follows), you can perform the broadcasting operation using the following simplified procedure:

**1 Load the document(s).**

- If desired, press  to set the resolution and/or contrast.

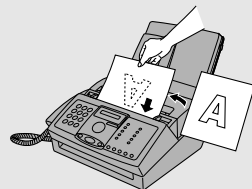

READY TO SEND

**2 Press the appropriate Group Key. Transmission will begin.**















## Storing numbers in Group Keys

Group Keys allow you to send a fax to a group of fax machines by simply pressing the appropriate Group Key once. To store a group of numbers in a Group Key, follow the steps below.

- ◆ Rapid Keys 09/G1 and 10/G2 can be used as Group Keys. A key cannot be simultaneously programmed as both a Group Key and a Rapid Key.
- ◆ Up to 20 numbers can be stored in one Group Key.



Only Rapid Key and Speed Dial numbers can be stored in a Group Key. Full numbers cannot be stored.

<p><b>1</b> Press <small>FUNCTION</small>  once and  twice.</p>	<p>Display: ENTRY MODE </p>
<p><b>2</b> Press  once and  once.</p>	<p>GROUP ENTRY </p>
<p><b>3</b> Press .</p>	<p>1=SET, 2=CLEAR</p>
<p><b>4</b> Press  to program a Group Key. (Press  to clear a Group Key.)</p>	<p>GROUP SET ↑ ↓ PRESS GROUP KEY</p>
<p><b>5</b> Press the Group Key that you wish to program (Rapid Key 09/G1 or 10/G2).  (If you are clearing a Group Key, press the Group Key that you wish to clear and go to Step 9.)</p>	<p>(Example) </p>

**6** Select a destination using one of the following methods:

Press a Rapid Key.

Press  and enter a 2-digit Speed Dial number.

Press  (or ) until the name of the destination appears in the display (if no name was stored, the number will appear).

**7** Press  to store the destination.

**8** Repeat Steps 6 and 7 for each of the other destinations that you want to store in the Group Key (maximum of 20).

- To check your selected destinations, press  to scroll through them. To

delete a destination, scroll to the destination and then press .

**9** When you have finished storing the destinations, press .

**10** Press  to return to the date and time display.

### ***If the memory becomes full...***

If the memory becomes full while the document is being scanned, MEMORY IS FULL will appear in the display.

- ◆ Press  if you want to transmit the pages which have been stored up to that point in memory. The remaining pages will be ejected from the feeder. After transmission, the memory will be cleared and you can transmit the remaining pages. You will also need to transmit the page which was being scanned when the memory filled up.

- ◆ Press  if you want to cancel the entire transmission.

# 3. Receiving Faxes

## Using FAX Mode

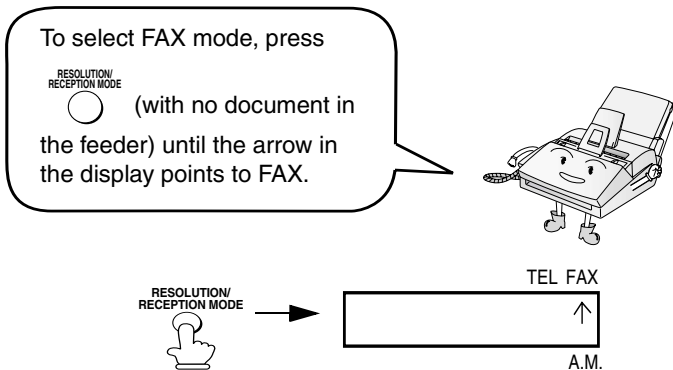

When the reception mode is set to FAX, the fax machine will automatically answer all calls on four rings and receive incoming faxes.

- ◆ If you pick up the handset before the machine answers, you can talk to the other party and/or receive a fax as explained in *Using TEL Mode* on page 59.

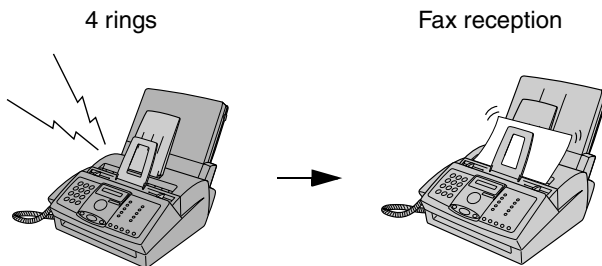



## Changing the number of rings

If desired, you can change the number of rings on which the fax machine answers incoming calls in FAX mode. Any number from 2 to 5 can be selected.

**1** Press **FUNCTION** ○ once and ▼ 3 times.

Display:

OPTION SETTING ⇄

**2** Press  once and  once.

NUMBER OF RING  

**3** Press  once.

ENTER (1-5) (4)

**4** Enter the desired number of rings (any number from 1 to 5).

The display briefly shows your selection, then:

Example: 3 rings 

RECALL INTERV. 

**5** Press  to return to the date and time display.

**Note:** If you are using Distinctive Ring, the fax machine will answer calls after two rings regardless of the above setting.

**Important:**

Do not let more than 50 pages accumulate in the received document tray. Too many pages in the tray will cause paper jams.

## Using TEL Mode



RESOLUTION/  
RECEPTION MODE



To select TEL mode, press  (with no document in the feeder) until the arrow in the display points to TEL.

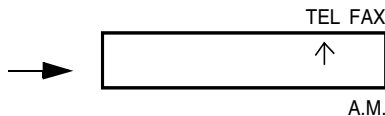

When the reception mode is set to TEL, you must answer all calls (even fax calls) by picking up the fax machine's handset or an extension phone connected to the same line.

## Answering with the fax's handset

- 1 When the fax machine rings, pick up the handset.

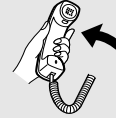

- 2 If you hear a fax tone, wait until the display shows RECEIVING and then replace the handset.



RECEIVING

**Note:** If you have set the Fax Signal Receive setting to NO, press  to begin reception.

- 3 If the other party first speaks with you and then wants to send a fax, press  after speaking. (Press before the sender presses their Start key.)



RECEIVING



- When RECEIVING appears in the display, hang up.

## Answering on an extension phone connected to the same line

- 1 Answer the extension phone when it rings.



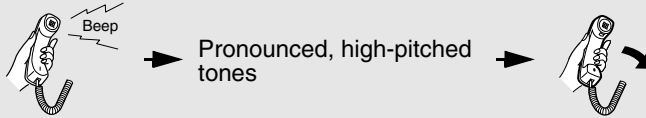

- 2** If you hear a soft fax tone, wait until your fax responds (you will hear pronounced, high-pitched tones), then hang up.



- 3** If the fax doesn't respond, or if the other party first talks to you and then wants to send a fax, press **5** once and **\*** twice on the extension phone (only on a tone dial phone). This signals the fax to begin reception. Hang up.

- The above step is necessary if you have set the Fax Signal Receive setting to NO.
- Your fax will not accept the signal to begin reception (**5** **\*** **\***) if a document is loaded in its feeder.

## Putting a call on hold

To put the other party on hold during a phone conversation, press **HOLD** . When this is done, they cannot hear you. You can put the handset back in the cradle without breaking the connection. When you are ready to speak with the other party again, pick up the handset. If you did not put the handset back in the cradle, press **HOLD**  again to resume conversation.

## Optional Reception Settings



### Fax Signal Receive

Your fax will automatically begin reception if you hear a soft fax tone after answering a call on your fax or an extension phone. If you use a computer fax modem to send documents on the same line, you must turn this function off in order to prevent your fax from mistakenly attempting to receive documents from the computer fax modem. Follow the steps below to change the setting.

**1** Press  **once** and  **3 times.**

Display:



OPTION SETTING 

**2** Press  **once** and  **7 times.**

FAX SIGNAL RX 

**3** Press  **once.**

1=YES, 2=NO

**4** Press  **to turn on the function, or**  
 **to turn it off.**

The display briefly shows your selection, then:

POLLING 

**5** Press  **to return to the date and time display.**



## Changing the number for remote fax activation

If desired, you can use a number other than **5** to activate fax reception from an extension telephone. You can select any number from **0** to **9**.

**1** Press  once and  3 times.

Display:

OPTION SETTING 

**2** Press  once and  four times.

FAX REMOTE # 

**3** Press  once.

ENTER (0-9) (5)

**4** Enter the desired number (any number from 0 to 9).

The display briefly shows your selection, then:

Example: 



TRANSACTION 

**5** Press  to return to the date and time display.

## Reception Ratio

The fax has been set at the factory to automatically reduce the size of received documents to fit the size of the printing paper. This ensures that data on the edges of the document are not cut off. If desired, you can turn this function off and have received documents printed at full size.

- ◆ If a document is too long to fit on the printing paper, the remainder will be printed on a second page. In this case, the cut-off point may occur in the middle of a line.
- ◆ Automatic reduction may not be possible if the received document is too large, contains too many fine graphics or images, or is sent at high resolution. In this case, the remainder of the document will be printed on a second page.

**1** Press <sup>FUNCTION</sup>  once and  four times.

Display:



PRINT SET-UP 

**2** Press  once.

RECEIVE RATIO 

**3** Press  once.

1=AUTO, 2=100%

**4** Press  to select AUTO, or  to select 100%.

The display briefly shows your selection, then:

PAPER SIZE SET 

**5** Press <sup>STOP</sup>  to return to the date and time display.

## ***Substitute Reception to Memory***

In situations where printing is not possible, such as when your fax runs out of paper, the print cartridge needs replacement, or the paper jams, incoming faxes will be received to memory.

When you have received a document in memory, FAX RX IN MEMORY will appear in the display, alternating with ADD PAPER & PRESS START KEY, COVER OPEN, PAPER JAMMED, REPLACE TONER, or PRINTER ERROR.

When you add paper (and press , or clear the jam, or replace the print cartridge, the stored documents will automatically print out.

- ◆ If you received documents in memory because the fax ran out of paper, be sure to add paper which is the same size as the paper previously used. If not, the document print-out size may not match the size of the printing paper.

### **Caution!**

- ◆ When documents are stored in memory, do not turn the power off. This will erase all of the contents.
- ◆ If documents received in memory are lost due to a power failure or other interruption in the power supply, a CLEAR REPORT will be printed out when the power is restored. This gives information about the receptions lost, including the fax numbers of the transmitting machines if they are available.

# 4. Making Copies



Your fax machine can also be used to make copies. Single and multiple copies (up to 50 per original) can be made, enabling your fax to double as a convenience office copier.

## 1 Load the document(s) face down. (Maximum of 20 letter pages or 5 legal pages.)

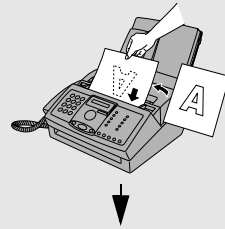
- If desired, press  to set the resolution and/or contrast. (The default resolution setting for copying is FINE.)



## 2 Select any of the following copy settings as needed:

- **Enlarge/reduce:** Press  or  until the desired setting appears in the display. Settings are 100%, 125%, 150%, 200%, 50%, 73%, 88%, 94%, and AUTO (automatic adjustment to match the size of the paper). The default setting is 100%.

Example: Press  twice → COPY RATIO: 125%

- **Number of copies per original:** Press the number keys to enter a number from 1 to 50. The default setting is 1.

Example: Press  for two copies → 2

- **Sorted copies:** To sort the copies as shown below under “Sorted”, first set the number of copies per original (at least “2” copies must be set), and then

press  → 2 [SORT]

Example of two copies each of three originals

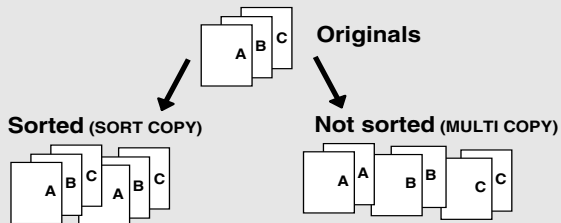

**3** When you are ready to begin copying, press  .

**If MEMORY IS FULL appears...**



If you place a large number of originals in the feeder, the memory may become full before all pages can be scanned (the display will show MEMORY

IS FULL). If this happens, press  to copy the pages that have been scanned, and then repeat the copy procedure for the remaining pages, including the page that was being scanned when the memory became full.



**Copy Cut-off**

When making a copy of a document that is longer than the printing paper, use the copy cut-off setting to select whether the remaining part of the document will be cut off or printed on a second page. The initial setting is YES (cut off the remainder). To change the setting, follow the steps below.

**1** Press  once and  four times. Display: PRINT SET-UP 

**2** Press  once and  twice. COPY CUT-OFF 

**3** Press  once. 1=YES, 2=NO

**4** Press  to set copy cut-off to YES (the remaining part of the document will not be printed), or  to set copy cut-off to NO (the remaining part will be printed on a second page). The display briefly shows your selection, then: LIFE COUNTER 

**5** Press  to return to the date and time display.

---

## 5. Answering Machine Connection

### Connecting an Answering Machine

If desired, you can connect an answering machine to your fax machine's **TEL. SET** jack. This will allow you to receive both voice messages and faxes when you are out.

- ◆ **Important:** If the answering machine is not connected to the **TEL. SET** jack on the fax as shown, the setup will not operate properly.

- 
- 1** Remove the seal covering the **TEL. SET** jack.

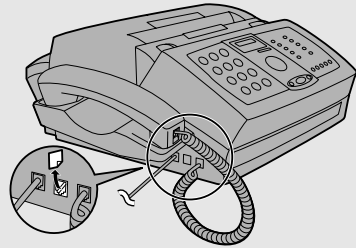

- 2** Connect the answering machine's telephone line jack to the **TEL. SET** jack.

- If desired, you can connect an extension phone to your answering machine's extension phone jack.

Make sure the **TEL. LINE** jack is connected to the wall jack.

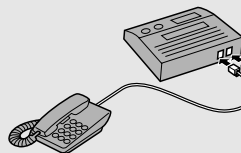
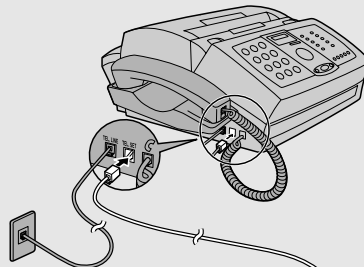

To answering machine's telephone line jack.

## Changing the outgoing message

The outgoing message (OGM) of your answering machine should be changed to inform callers who want to send a fax to press their Start key. For example, your message might go as follows:

"Hello. You've reached the ABC company. No one is available to take your call right now. Please leave a message after the beep or press your facsimile Start key to send a fax. Thank you for calling."

- ◆ It is advisable to keep the length of the message under 10 seconds. If it is too long, you may have difficulty receiving faxes sent by automatic dialing.
- ◆ If your outgoing message must be longer than 10 seconds, leave a pause of about four seconds at the beginning of the message. This will give your fax a chance to detect fax tones sent when automatic dialing is used.

## Using the Answering Machine Connection

When you go out, activate the answering machine connection as follows:

### 1 Set the reception mode to A.M.

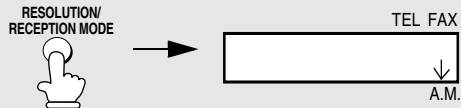

### 2 Set your answering machine to auto answer.

- ◆ Your answering machine must be set to answer on a maximum of two rings. If not, you may not be able to receive faxes sent by automatic dialing.
- ◆ If your answering machine has a toll saver function, make sure that it will answer by the fourth ring.

**Note:** If your answering machine has a remote retrieval function, make sure the code used to activate remote retrieval is different from the code used to activate fax reception with an extension telephone (see page 63). If they are the same, entering the code from an outside telephone to retrieve messages will cause the fax machine to be activated.

### ***How answering machine mode operates***

While you are out, all of your incoming calls will be answered by your answering machine and its outgoing message will play. Voice callers can leave a message. During this time, your fax will quietly monitor the line. If your fax detects a fax tone or a duration of silence greater than four seconds, it will take over the line and begin reception.

- ◆ If the connection is not good or there is noise on the line, the answering machine and/or fax machine may not respond properly.
- ◆ The call counter on your answering machine may indicate that voice messages were received, when only fax messages were received.
- ◆ To prevent the fax from taking over the line and beginning reception if you call in from an external phone or answer on an extension phone, press any three keys (other than the code to activate fax reception, "5", "✳", and "✳") on the dial pad of the phone. This can only be performed from a phone capable of tone dialling.

When you return and turn off your answering machine, be sure to change the reception mode back to FAX or TEL!

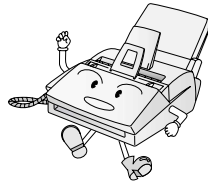

## ***Optional A.M. Mode Settings***

If necessary, you can use the following settings to improve the response of the answering machine connection to incoming calls.

### ***Quiet Detect Time***

This function causes the fax machine to take over the line and begin reception if a certain duration of silence is detected after the answering machine answers.













Time selections for the period of silence are 1 to 10 seconds. Quiet Detect Time has been set to 4 seconds at the factory. This gives the best performance with most answering machines; however, you may need to adjust this setting depending on the disconnect time of your answering machine.

Some answering machines may have unusually fast disconnect times (equal to or very slightly less than 4 seconds), which means that the answering machine may disconnect the line before fax reception can begin. In this case, try a Quiet Detect Time setting of about 3 seconds.

If the fax machine is interrupting callers before they can leave a message, try a longer Quiet Detect Time setting. If your outgoing message includes a period of silence, make sure that the setting is longer than that period of silence, or re-record your outgoing message to shorten the silence.

**Note:** Quiet Detect Time can be turned off by entering "00" for the time. Note, however, that the fax machine will not be able to receive faxes sent manually by Normal Dialing.

To change the setting, follow the steps below.

<p><b>1</b> Press  <b>once and</b>  <b>3 times.</b></p>	<p>Display: OPTION SETTING </p>
<p><b>2</b> Press  <b>once and</b>  <b>7 times.</b></p>	<p>QUIET TIME </p>
<p><b>3</b> Press  <b>once.</b></p>	<p>ENTER (00-10) 04</p>
<p><b>4</b> Enter a number from 01 to 10, or enter 00 to turn off the function.</p> <p>Example: 3 seconds  </p>	<p>The display briefly shows your selection, then: QUIET START </p>
<p><b>5</b> Press  <b>to return to the date and time display.</b></p>	

## Quiet Detect Start Time



This setting can be used to delay the start of the Quiet Detect Time function. For example, if you want to insert a pause at the beginning of your answering machine's outgoing message to ensure clear detection of fax signals, you can use this setting to delay the start of silence detection so that the pause will not cause the fax to take over the line.

Quiet Detect Start Timing has been set to five seconds at the factory. You can change this setting by entering a 2-digit number equal to the desired number of seconds of the delay, or turn the function off by entering **00**. As general guide, the delay time should be slightly longer than the pause before the outgoing message.

**1** Press  once and  3 times.

Display:

OPTION SETTING 

**2** Press  once and  8 times.

QUIET START 

**3** Press  once.

ENTER (00-15) 05

**4** Enter a 2-digit number (from 01 to 15) for the number of seconds of the delay, or enter 00 to turn off the function.

The display briefly shows your selection, then:

ON TAD FAILURE 

Example: 3 seconds  

**5** Press  to return to the date and time display.









## On TAD Failure

When this function is turned on, your fax will answer the call after 5 rings if the answering machine for some reason fails to answer before that time. This ensures that you will receive fax messages even if the answering machine's tape fills up or the answering machine is not turned on.

This function has been turned off at the factory. If you want to turn it on, follow the steps below:

### Note:

When this function is turned on, make sure that the answering machine is set to answer on 4 rings or less. If it isn't, the fax will always answer first, preventing callers from leaving voice messages.

<b>1</b> Press  once and  3 times.	Display: <input type="text" value="OPTION SETTING"/>
<b>2</b> Press  once and  9 times.	<input type="text" value="ON TAD FAILURE"/>
<b>3</b> Press  once.	<input type="text" value="1=YES, 2=NO"/>
<b>4</b> Press  to turn on the function, or   to turn it off.	The display briefly shows your selection, then: <input type="text" value="DISTINCTIVE"/>
<b>5</b> Press  to return to the date and time display.	

---

## 6. Special Functions

### ***Distinctive Ring (Requires Subscription to Service)***

**Important:**

- ◆ **To use distinctive ring, you must subscribe to a distinctive ring service from your local phone company.**
- ◆ Note that your fax machine may not be compatible with some distinctive ring services.

Distinctive ring is a service offered by some local telephone companies whereby they assign an additional second number to your regular single line. The second number rings differently from your normal number.

If you subscribe to a distinctive ring service, you can set the fax machine to automatically answer when your second number is called. This allows you to use the second number as an exclusive fax number. To have your fax automatically answer when your second number is called, follow the steps below:



---

**1** Press  **once and**  **3 times.**

Display:

OPTION SETTING 

---

**2** Press  **once and**  **8 times.**

DISTINCTIVE 

---

**3** Press  **once.**

**4** Press a number from 1 to 3 to select the ring pattern below that matches your second number's ring pattern. Press 4 to have your fax automatically answer your normal telephone number. Press 5 to turn off the distinctive ring function.

- ① : RING PATTERN 1      Two short rings
- ② : RING PATTERN 2      One short, one long, and one short ring
- ③ : RING PATTERN 3      Two short rings and one long ring
- ④ : STANDARD RING      Your standard (normal) ring pattern
- ⑤ : OFF SETTING          Turn distinctive ring off

The display briefly shows your selection, then:



**5** Press  to return to the date and time display.

**6** Set the reception mode to FAX.

RESOLUTION/  
RECEPTION MODE

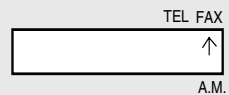

- ◆ When using distinctive ring, you must set the reception mode of your fax machine to FAX. When your designated fax number is dialed, your fax will automatically answer and begin reception after two rings. Note that other devices on the same line will also ring until your fax answers. If one of your other numbers is dialed, the fax will ring; however, it will not answer.



## Blocking Reception of Unwanted Faxes

The Anti Junk Fax function allows you to block reception of faxes from parties that you specify. This saves paper by not printing out unwanted "junk" faxes. To use this function, follow the steps below to enter the fax numbers from which you do not wish to receive faxes. Up to five fax numbers can be entered.

**1** Press  once and  twice.

Display:

ENTRY MODE 

**2** Press  once and  twice.

ANTI JUNK # 

**3** Press  once.

<NEW JUNK #> 

**4** Press  .

ENTER FAX #

**5** Enter the fax number (maximum of 20 digits).

**6** Press  .

<NEW JUNK #> 

**7** Return to Step 3 to store another number, or press  to return to the date and time display.



## Editing and clearing anti junk numbers

If you need to make changes to a previously stored anti junk number, or clear a number, follow these steps:

**1** Press  once and  twice.

Display:



ENTRY MODE 

**2** Press  once and  twice.

ANTI JUNK # 

**3** Press .

<NEW JUNK #> 

**4** Press  or  until the number you want to edit or clear appears in the display.



**5** Press .

1=EDIT, 2=CLEAR

**6** Press  for EDIT or  for CLEAR.

- If you selected CLEAR, go to Step 8.

**7** If you selected EDIT, make the desired changes to the number.

- Press  or  to move the cursor to the digit or digits you wish to change, and then enter the new digit. The new digit will replace the old digit.

**8** Press .

<NEW JUNK #> 









**9** Return to Step 4 to edit or clear another number, or press  to return to the date and time display.

## ***Polling (Requesting a Fax Transmission)***

Polling allows you to call another fax machine and have it send a document (previously loaded in its feeder) to your machine without operator assistance. In other words, the receiving fax machine, not the transmitting fax machine, initiates the transmission.

To use the polling function, you must first set Rapid Key 08/POLL for use as a polling key.



- ◆ When Rapid Key 08/POLL is set as a polling key, it cannot be used for Rapid Key dialing.

- |   |   |
|---|---|
| <b>1</b> Press  <b>once and</b>  <b>3 times.</b>  | Display:<br><input type="text" value="OPTION SETTING"/>                                     |
| <b>2</b> Press  <b>once and</b>  <b>6 times.</b>  | <input type="text" value="POLLING"/>  |
| <b>3</b> Press  <b>once.</b>   | <input type="text" value="1=YES, 2=NO"/>  |
| <b>4</b> Press  <b>to use Rapid Key 08/POLL as a polling key.</b><br><b>(To turn off the polling function, press</b><br> <b>.)</b> | The display briefly shows your selection, then:<br><input type="text" value="COVER SHEET"/> |
| <b>5</b> Press  <b>to return to the date and time display.</b>   |   |



## Requesting transmission

### 1 Dial the fax machine you want to poll using one of the following methods:

- Pick up the handset (or press ) and dial the full number. Wait for the fax answerback tone.
- Pick up the handset (or press ) and press a Rapid Key. Wait for the fax answerback tone.
- Press  and enter a 2-digit Speed Dial number.
- Enter the full number using the numeric keys.

### 2 Press .

- If you used the handset, replace it when POLLING appears in the display. Reception will begin.

## Being polled (Memory polling)

To let another fax machine poll your fax machine, you must first store the document(s) in memory using the following procedure. Transmission will take place when the other fax machine calls your fax machine and activates polling. You can choose whether to allow polling only once, or an unlimited number of times. In the latter case, your fax machine can be used as an electronic "bulletin board".

- ◆ If you allow polling only once, the document(s) will be automatically cleared from memory after polling. If you allow polling an unlimited number of times, the document will remain in memory until you clear it as explained in the following section, *Clearing a memory polling document*.

## Polling (Requesting a Fax Transmission)

### 1 Load the document.

- If desired, press  to set the resolution and/or contrast.

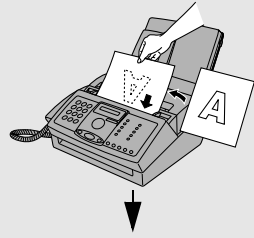

READY TO SEND

### 2 Press once and 3 times.

MEMORY POLLED 

### 3 Press .

1=SET, 2=CLEAR

### 4 Press to select SET.

1=ONCE, 2=REPEAT

### 5 Press to allow polling only once, or to allow polling an unlimited number of times.



### 6 Press .

- The document will be scanned into memory, and your fax will go on polling standby.

### 7 Set the reception mode to FAX (press until the arrow in the display points to FAX).

## ***Clearing a memory polling document***

To clear a memory polling document from memory, follow these steps:

**1** Press  once and  3 times.

MEMORY POLLED 

**2** Press .

1=SET, 2=CLEAR











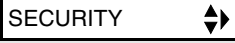

**3** Press  to select CLEAR.

**4** Press  to clear the document.

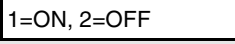
## Polling security













Polling Security allows you to prevent unauthorized polling of your machine. When this function is turned on, polling will only take place when the fax number of the polling fax machine has been entered in your machine's list of permitted fax numbers (called "passcode numbers"). The number of the polling fax must also be correctly programmed into itself for identification.

To use Polling Security, follow the steps below to turn the function on, and then enter permitted numbers as explained on the following page.

<b>1</b> Press  once and  twice.	Display: 
<b>2</b> Press  once and  once.	
<b>3</b> Press  .	
<b>4</b> Press  to turn on polling security. (Press  to turn off polling security.)	
<b>7</b> Press  .	The display briefly shows your selection, then: 
<b>8</b> Press  to return to the date and time display.	

## Storing fax numbers for polling permission

You can store up to 10 fax numbers in your machine's list of permitted numbers.

<b>1</b> Press  once and  twice.	Display: ENTRY MODE 
<b>2</b> Press  once and  twice.	PASSCODE MODE 
<b>3</b> Press  .	<NEW CODE> 
<b>4</b> Press  .	ENTER FAX #
<b>5</b> Enter the fax number (maximum of 20 digits).	
<b>6</b> Press  .	<NEW CODE> 
<b>7</b> Return to Step 3 to store another number, or press  to return to the date and time display.	



## Editing and clearing polling permission numbers

If you need to make changes to a previously stored polling permission number, or clear a number, follow these steps:

**1** Press  **once and**  **twice.**

Display:



ENTRY MODE 

**2** Press  **once and**  **twice.**

PASSCODE MODE 

**3** Press .

<NEW CODE> 

**4** Press  **or**  **until the number you want to edit or clear appears in the display.**



**5** Press .

1=EDIT, 2=CLEAR

**6** Press  **for EDIT or**  **for CLEAR.**

- If you selected CLEAR, go to Step 8.

**7** **If you selected EDIT, make the desired changes to the number.**

- Press  **or**  **to move the cursor to the digit or digits you wish to change, and then enter the new digit. The new digit will replace the old digit.**











**8** Press .

<NEW CODE> 

**9** **Return to Step 4 to edit or clear another number, or press**  **to return to the date and time display.**

## 7. Printing Lists

You can print lists showing settings and information entered in the fax machine, and a report showing recent fax transactions. The lists and report are described below. To print a list or report, follow these steps.

<b>1</b> Press  once and  once.	Display: 
<b>2</b> Press  once.	
<b>3</b> Press  or  until the desired list appears in the display.	
<b>4</b> Press  once.	
<b>5</b> Press  to print the list.	

### Activity Report

This report shows information on your most recent 30 fax transactions. The report is divided into two parts: the TRANSMISSIONS ACTIVITY REPORT, which shows information on fax transmissions, and the RECEPTIONS ACTIVITY REPORT, which shows information on fax receptions.

- ◆ All information is erased after a report is printed out. If information on 30 fax transactions accumulates, the information on the oldest transaction will be deleted each time a new transaction takes place.
- ◆ You can have the Activity Report printed out automatically each time information on 30 fax transactions accumulates. See page 89.
- ◆ The Activity Report contains the same headings as the Transaction Report. See page 87 for an explanation of the headings.

## Telephone Number List

This list shows the fax and phone numbers that have been stored for automatic dialing.

## Group List

This list shows the fax numbers that have been stored in each Group Key.

## Setup List

This list shows your current selections for the **FUNCTION** key settings. The list also shows your name and fax/telephone number as entered in the machine, and a sample of the header printed at the top of every page you transmit (**HEADER PRINT**).

```

                                SETUP LIST                                AUG-04-2004 04:20 PM
-----
FOR:
***ENTRY MODE***
POLLING MODE                                SECURITY OFF
PASSCODE #
ANTI JUNK #
SENDER'S NAME
SENDER'S TELEPHONE #
HEADER PRINT                                P.01
AUG-04-2004 04:20 PM
-----
***OPTION SETTING***
FINE PRIORITY                                NO
NUMBER OF RINGS IN AUTO ANSWER MODE        4 RINGS
RECALL INTERVAL                             05 MINUTES
RECALL TIMES                                02 TIMES
TEL/FAX REMOTE #                             151**
TRANSACTION PRINT SELECT                     ERROR ONLY
DIAL MODE                                    TONE
QUIET DETECT TIME                            04S
QUIET DETECT START TIMING                    05S
FAX ANSWER WHEN TAD FAILS                   NO
DISTINCTIVE RINGING                          OFF
FAX SIGNAL RECEIVE                           YES
POLLING                                       NO
COVER SHEET                                  NO
AUTO PRINT OUT                               NO
ECM MODE                                     YES
DAY LIGHT SAVING TIME                        NO
BEEP LENGTH                                  3S
-----
***PRINT SET-UP***
RECEPTION RATIO                              AUTO
PAPER SIZE SET                               LETTER
COPY CUT OFF                                 YES
-----
```



## Transaction Report

This report is printed out automatically after an operation is completed to allow you to check the result. Your fax machine is set at the factory to print out the report only when an error occurs.

- ◆ The Transaction report cannot be printed on demand.

### Headings in the Transaction Report

**SENDER/RECEIVER** The name or fax number of the other machine involved in the transaction. If that machine does not have an ID function, the communication mode will appear (for example, "G3").

**START** The time at which transmission/reception started.

**TX/RX TIME** Total time taken for transmission/reception.

**PAGES** Number of pages transmitted/received.

**NOTE** (One of the following notes will appear under **NOTE** in the report to indicate whether the transaction was successful, and if not, the reason for the failure.)

**OK** - Transmission/reception was successful.

**P.FAIL** - A power failure prevented the transaction.

**JAM** - The printing paper or document jammed, preventing the transaction.

**BUSY** - The fax was not sent because the line was busy.

**COM.E-X** - (Where "X" is a number.) A telephone line error prevented the transaction. See *Line error* on page 97.

**CANCEL** - The transaction was cancelled because the **STOP** key was pressed, no document was in the feeder, or the other machine requested transmission using a function which your fax machine does not have. If you were attempting to fax, make sure a document is in the feeder. If you were receiving, contact the faxing party to see how they are trying to send to you.



## Transaction Report print condition

You can change the condition under which a Transaction Report is printed out. Follow the steps below.

**1** Press  once and  3 times.

Display:

OPTION SETTING 

**2** Press  once and  5 times.





TRANSACTION 

**3** Press  once.

1:ALWAYS PRINT

(Selections appear alternately)

**4** Press a number from  to  to select the condition for printing.

- |   |  |
|---|--|
|  ALWAYS PRINT  | A report will be printed after each transmission, reception, or error. |
|  ERROR/MEMORY  | A report will be printed after an error or a memory operation.         |
|  SEND ONLY     | A report will be printed after each transmission.                      |
|  ERROR ONLY   | A report will be printed only when an error occurs.                    |
|  NEVER PRINT | A report will never be printed.  |











The display briefly shows your selection, then:

DIAL MODE 

**5** Press  to return to the date and time display.

## Auto print-out of Activity Report

You can set the Activity Report to print automatically whenever information on 30 fax transactions has accumulated. (A report can still be printed on demand at any time.) Follow these steps:

<p><b>1</b> Press <sup>FUNCTION</sup>  once and  3 times.</p>	<p>Display: OPTION SETTING </p>
<p><b>2</b> Press  once and  4 times.</p>	<p>AUTO PRINT OUT </p>
<p><b>3</b> Press  once.</p>	<p>1=YES, 2=NO</p>
<p><b>4</b> Press  to turn on auto print out, or  to turn it off.</p>	<p>The display briefly shows your selection, then: ECM MODE </p>
<p><b>5</b> Press <sup>STOP</sup>  to return to the date and time display.</p>	

---

## 8. Maintenance

### Scanning glass and rollers

Clean the scanning glass and rollers frequently to ensure that your transmitted images and copies are of the highest quality.

Open the operation panel (grasp the panel release and pull up), and wipe the scanning glass, rollers and white backplate with a soft cloth.

- ◆ Make sure that all dirt and stains (such as correcting fluid) are removed, as dirt and stains will cause vertical lines on transmitted images and copies.

- 
- 1 Squeeze the panel release and open the operation panel.**

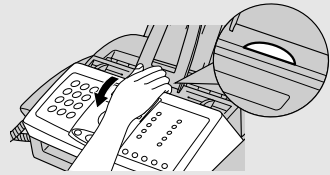

- 2 Wipe the scanning glass (under the white roller) and rollers with a cotton swab.**

- Make sure that all dirt and stains (such as correcting fluid) are removed. Dirt and stains will cause vertical lines on transmitted images and copies.

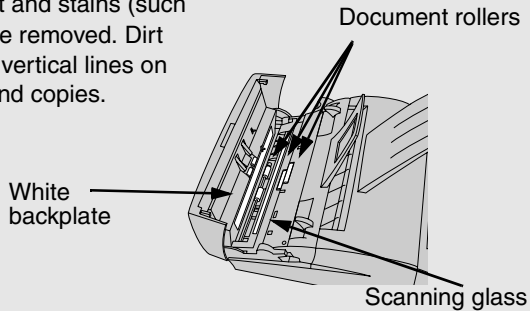

**If the scanning glass is difficult to clean**

If you find it difficult to remove dirt from the scanning glass, you can try moistening the swab with isopropyl alcohol or denatured alcohol. Take care that no alcohol gets on the rollers.

- 
- 3 Close the operation panel.**

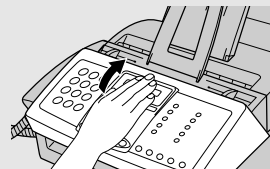

## The housing

Wipe the external parts and surface of the machine with a dry cloth.

### Caution!

- ◆ Do not use benzene or thinner. These solvents may damage or discolor the machine.

## Replacing the toner cartridge

When the toner cartridge nears empty (about 100 pages can still be printed), TONER NEAR EMPTY will appear in the display. When the toner cartridge is empty, TONER EMPTY, REPLACE TONER, and CLR TONER COUNT will appear alternately in the display. Printing will no longer be possible.

Replace the toner cartridge with the following cartridge:

### Sharp FO-29ND toner cartridge

- 1 Grasp the print compartment cover at both sides as shown, and pull up to open the cover.**

- **Caution!**

The fusing unit inside the print compartment becomes very hot during operation. Do not touch the inside of the compartment or the paper guide on the underside of the print compartment cover.

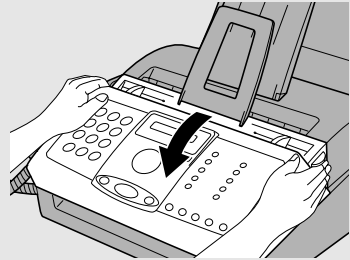

- 2 Grasp the finger hold on the toner cartridge handle where it is marked PUSH, and pull the handle out. Rehold the handle and pull the toner cartridge out of the compartment.**

- Dispose of the old toner cartridge according to local regulations. If in doubt, contact your local waste disposal agency.

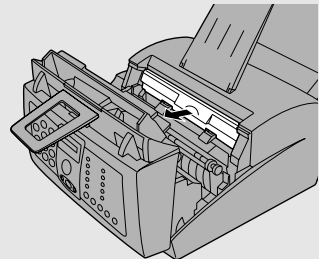

- 3** Install the new toner cartridge and reset the toner counter (see page 15).

## ***Replacing the drum cartridge***



### ***Viewing the total number of pages printed***

To maintain excellent printing quality, we recommend that you replace the drum cartridge after 20,000 pages have been printed. Follow these steps to view the total number of pages printed:

- 1** Press  once and  four times.

Display:

PRINT SET-UP 

- 2** Press  once and  three times.

LIFE COUNTER 

- 3** Press  once. The count will appear in the display.

- 4** When you are finished, press  to exit.

## ***Replacing the drum cartridge***

When 20,000 pages have been printed, DRUM LIFE OVER will appear in the display. Replace the drum cartridge with the following cartridge:

**Sharp FO-29DR drum cartridge**

- 1 Grasp the print compartment cover at both sides as shown, and pull up to open the cover.**

- **Caution!**

The fusing unit inside the print compartment becomes very hot during operation. Do not touch the inside of the compartment or the paper guide on the underside of the print compartment cover.

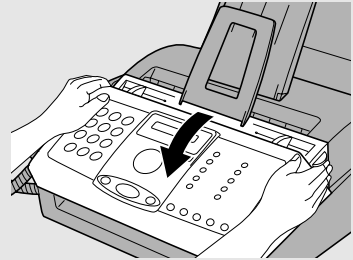

- 2 Grasp the finger hold on the toner cartridge handle where it is marked PUSH, and pull the handle out. Rehold the handle and pull the toner cartridge out of the compartment.**

- Place the toner cartridge on a sheet of paper on a level surface.

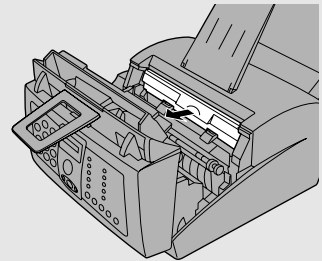

- 3 Grasp the tabs on the drum cartridge handle with both hands and gently pull the cartridge out of the machine.**

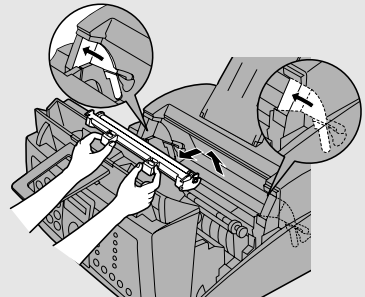

- 4 Remove the new drum cartridge from its packaging, and then remove the sheet of protective paper from the drum cartridge.**

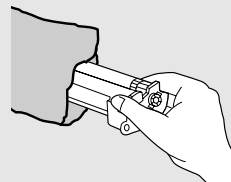

**5** Insert the drum cartridge into the print compartment, holding the tabs on the drum cartridge handle with both hands.

- To insert the cartridge, align the guides on the cartridge with the runners on the sides of the compartment.

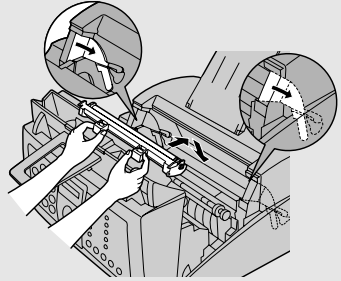

**6** Replace the toner cartridge and close the print compartment cover (see page 15). When finished, reset the drum cartridge counter as explained on page 18.



## Cleaning the drum cartridge

If you find that characters or parts of an image are missing from your printed pages, the drum in the drum cartridge may need cleaning. Follow the steps below to clean the drum.

- 1** Grasp the print compartment cover at both sides as shown, and pull up to open the cover.

- **Caution!** The fusing unit inside the print compartment becomes very hot during operation. Do not touch the inside of the compartment or the paper guide on the underside of the print compartment cover.

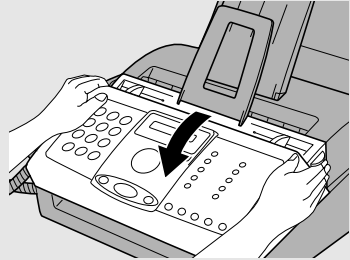

- 2** Grasp the finger hold on the toner cartridge handle where it is marked **PUSH**, and pull the handle out. Rehold the handle and pull the toner cartridge out of the compartment.

- Place the toner cartridge on a sheet of paper on a level surface.

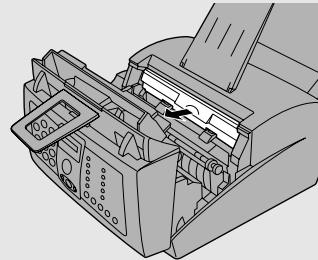

- 3** Grasp the tabs on the drum cartridge handle with both hands and gently pull the cartridge out of the machine.

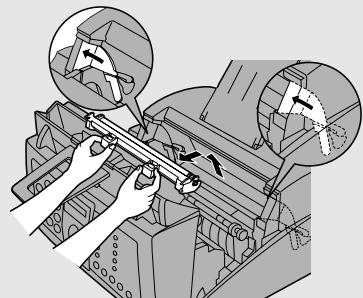

**4** Take a sheet of clean paper and roll it into a tube. Roll it tightly so that the diameter of the holes at each end is less than the thickness of your little finger.

**5** Gently wipe the surface of the drum with the rolled-up paper to remove any particles of toner caked on the drum.

- Do not let the drum surface come into contact with anything other than the rolled-up paper. Fingerprints, water, alcohol, and other solvents will damage the drum surface.
- Do not touch the drum surface with the edges of the rolled-up paper.

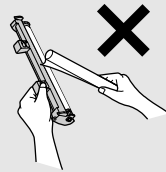
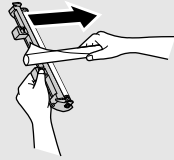

**6** Replace the drum cartridge, holding the tabs on the drum cartridge handle with both hands.

- To insert the cartridge, align the guides on the cartridge with the runners on the sides of the compartment.

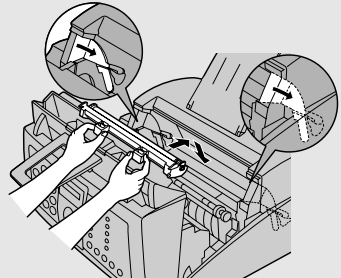

**7** Replace the toner cartridge and close the print compartment cover (see page 15).

---

# 9. Troubleshooting

## Problems and Solutions

If you have any problems with your fax, first refer to the following troubleshooting guide.

### Line error

Problem	Solution
LINE ERROR appears in the display.	<p>A line error occurs when your fax machine cannot communicate correctly with the other fax machine. The error is usually due to a problem on the phone line.</p> <p>Try the transaction again. If the error persists, check the following:</p> <ul style="list-style-type: none"><li>• Check the connection. The cord from the <b>TEL. LINE</b> jack to the wall jack should be no longer than six feet.</li><li>• Make sure there are no modem devices sharing the same telephone line.</li><li>• Check with the other party to make sure their fax machine is functioning properly.</li><li>• Have your telephone line checked for line noise.</li><li>• Try connecting the fax machine to a different telephone line.</li><li>• If the problem still occurs, your fax machine may need service.</li></ul>

### ***Dialing and transmission problems***

<b>Problem</b>	<b>Solution</b>
<p>No dial tone when you pick up the handset or press the <b>SPEAKER</b> key.</p>	<ul style="list-style-type: none"> <li>• Make sure the handset cord is connected to the correct jack. See <i>Connecting the handset</i> on page 10.</li> <li>• Make sure that the telephone line is properly connected to both the <b>TEL. LINE</b> jack and the wall jack (see page 11).</li> <li>• Make sure that the telephone line is good.</li> </ul>
<p>Dialing is not possible.</p>	<ul style="list-style-type: none"> <li>• Make sure the power cord is properly plugged into a power outlet.</li> <li>• Make sure that the telephone line is properly connected to both the <b>TEL. LINE</b> jack and the wall jack (see page 11).</li> <li>• Make sure that the fax machine is set to the correct dialing mode for your telephone line. See <i>Dial mode</i> on page 11.</li> </ul>
<p>The power is on, but no transmission takes place.</p>	<ul style="list-style-type: none"> <li>• Make sure that the receiving machine has paper.</li> <li>• Make sure that the telephone line cord is plugged into the <b>TEL. LINE</b> jack, and not the <b>TEL. SET</b> jack.</li> <li>• If the receiving machine is in manual mode with no attendant, reception will not be possible.</li> <li>• Check the display for error messages.</li> <li>• Pick up the handset and check for a dial tone. Dial the receiving machine manually and make sure that it is responding (you should hear a fax tone).</li> </ul>
<p>Nothing is printed at the receiving end.</p>	<ul style="list-style-type: none"> <li>• Make sure that the document for transmission is placed face down in the feeder.</li> </ul>

<p>A distorted image is received at the other end.</p>	<ul style="list-style-type: none"> <li>• Noise on the telephone line may cause distortion. Try sending the document again.</li> <li>• ECM mode (see page 48) will help prevent distortions due to line noise. Note that ECM mode must be turned on in the other machine as well.</li> <li>• Make a copy of the document on your fax machine. If the copy is also distorted, your fax machine may need service.</li> </ul>
--	---

### ***Reception and copying problems***

<b>Problem</b>	<b>Solution</b>
<p>The fax machine doesn't receive documents automatically.</p>	<ul style="list-style-type: none"> <li>• Make sure that the reception mode is set to FAX. If you subscribe to a distinctive ring service, make sure that the Distinctive Ring function is set to the correct ring pattern. If you do not subscribe to a distinctive ring service, make sure that Distinctive Ring is set to OFF SETTING. (See <i>Distinctive Ring</i> on page 74.)</li> </ul>
<p>The printing paper comes out blank when you try to receive a document.</p>	<ul style="list-style-type: none"> <li>• Make sure that the document is loaded properly in the feeder of the transmitting machine. Make a copy or print a report to confirm the printing ability of your machine.</li> </ul>
<p>The received document is faint.</p>	<ul style="list-style-type: none"> <li>• Ask the other party to send higher contrast documents. If the contrast is still too low, your fax machine may need service. Make a copy or print a report to check your machine's printing ability.</li> <li>• The toner cartridge may need replacement.</li> </ul>
<p>Dots appear at regular intervals on received documents and copies.</p>	<ul style="list-style-type: none"> <li>• The drum cartridge may be damaged. Replace the drum cartridge.</li> </ul>

<p>Received images are distorted.</p>	<ul style="list-style-type: none"> <li>• Noise on the telephone line may cause distortion. Have the other party try sending the document again.</li> <li>• ECM mode (see page 48) will help prevent distortions due to line noise. Note that ECM mode must be turned on in the other machine as well.</li> <li>• Make a copy or print a report on your fax machine. If the copy or report is also distorted, your fax machine may need service.</li> </ul>
<p>The quality of copies is poor and/or dark vertical lines appear.</p>	<ul style="list-style-type: none"> <li>• Any dirt or material on the scanning glass will cause spots to appear on copies and transmitted faxes. Clean the scanning glass as explained on page 90.</li> </ul>
<p>The power is on, but no reception takes place.</p>	<ul style="list-style-type: none"> <li>• Make sure that the telephone line cord is plugged into the <b>TEL. LINE</b> jack, and not the <b>TEL. SET</b> jack.</li> </ul>

**General problems**

<p><b>Problem</b></p>	<p><b>Solution</b></p>
<p>Nothing appears in the display.</p>	<ul style="list-style-type: none"> <li>• Make sure the power cord is properly plugged into a power outlet.</li> <li>• Connect another electrical appliance to the outlet to see if it has power.</li> </ul>
<p>The machine does not respond when you press any of its keys.</p>	<ul style="list-style-type: none"> <li>• If a beep sound is not made when you press the keys, unplug the power cord and then plug it in again several seconds later.</li> </ul>
<p>Automatic document feeding does not work for transmission or copying.</p>	<ul style="list-style-type: none"> <li>• Check the size and weight of the document (see <i>Transmittable Documents</i> on page 31).</li> </ul>
<p>Voice calls taken on an extension phone are interrupted by the fax.</p>	<ul style="list-style-type: none"> <li>• The fax may interrupt during a voice call if the reception mode is set to A.M. To prevent interruption on a tone dial extension phone, press any three keys on the extension phone after answering. (Note: Do not enter the code to activate fax reception.)</li> </ul>

<p>No reception occurs when polling is attempted.</p>	<ul style="list-style-type: none"> <li>• Make sure you have not run out of paper.</li> <li>• Make sure the transmitting machine is in automatic reception mode.</li> <li>• If the transmitting machine has polling security, make sure that your fax number has been entered both in your machine and in the transmitting machine.</li> </ul>
---	---

### ***Answering machine connection***

<b>Problem</b>	<b>Solution</b>
<p>The answering machine connection does not operate properly.</p>	<ul style="list-style-type: none"> <li>• Make sure your machine's reception mode is set to AM.</li> <li>• Make sure your machine's <b>TEL. LINE</b> jack is connected to the wall jack. Make sure your machine's <b>TEL. SET</b> jack is connected to your answering machine's telephone line jack (not the answering machine's extension phone jack).</li> <li>• Make sure your answering machine's outgoing message is under 10 seconds.</li> <li>• Make sure that the Quiet Detect Time setting is set to three or four seconds (see page 70).</li> <li>• Make sure that the Distinctive Ring function is set to OFF SETTING (see page 74).</li> <li>• If you have checked all of the above and the connection still doesn't operate properly, your machine may need service.</li> </ul>

# Messages and Signals

## Display messages

<p>ADD PAPER &amp; / PRESS START KEY (alternating messages)</p>	<p>Check the printing paper. If the tray is empty, add paper and then press the <b>START</b> key. If there is paper in the tray, make sure it is inserted correctly (take out the stack, align the edges evenly, and then reinsert it in the tray) and then press the <b>START</b> key.</p>
<p>COVER OPEN</p>	<p>The print compartment cover is open. Close it.</p>
<p>DIAL WAITING</p>	<p>Dialing is not possible because the fax machine is sending or receiving a fax, the handset is being used, or an extension phone is being used.</p>
<p>DOCUMENT JAMMED</p>	<p>The original document is jammed. See the following section, <i>Clearing Paper Jams</i>. Document jams will occur if you load more than 20 pages at once or load documents that are too thick (see page 31). The document may also jam if the receiving machine doesn't respond properly when you attempt to send a fax.</p>
<p>DRUM LIFE OVER</p>	<p>This appears when the drum cartridge needs replacement.</p>
<p>FAX RX IN MEMORY</p>	<p>A fax has been received in memory because the toner cartridge needs replacement, you have run out of printing paper, or the paper is jammed. The fax will print out automatically when the problem is fixed.</p>
<p>FUNCTION MODE</p>	<p>The <b>FUNCTION</b> key has been pressed.</p>
<p>GROUP SPACE FULL</p>	<p>This appears if you attempt to program a Group Key when all Group Keys have already been programmed.</p>
<p>HEATER HIGH/ HEATER LOW/ HEATER ERROR</p>	<p>If one of these messages appears, unplug the power cord and then plug it back in. If the message still appears, call for service.</p>



HOLD	The <b>HOLD</b> key has been pressed to put the other party on hold during a phone conversation. Press the <b>HOLD</b> again to take the other party off hold.
LINE ERROR	Transmission or reception was not successful. Press the <b>STOP</b> key to clear the message and then try again. If the error persists, see <i>Line error</i> on page 97.
LINE IS IN USE	An extension phone connected to the fax is being used. Do not lift the fax's handset or attempt transmission at this time, as this will interrupt the conversation on the extension phone.
MEMORY IS FULL	If faxes have been received to memory because printing is not possible (an additional message will indicate the problem), resolve the problem so that printing can continue (see <i>Substitute Reception to Memory</i> on page 65). If you are attempting to transmit from memory, see <i>If the memory becomes full</i> on page 57. If you are copying, see <i>If MEMORY IS FULL appears</i> on page 67.
MEMORY PRINTING	The fax is preparing to or printing out a document from memory.
NO # STORED	This appears if you attempt to search for an auto-dial number when none have been stored.
OFF HOOK	This appears if you forgot to replace the handset after using it to dial and send a fax. Replace the handset or press the <b>STOP</b> key to clear the message.
ON HOOK DIAL	The <b>SPEAKER</b> key has been pressed and the fax machine is waiting for you to dial.
PAPER JAMMED	The printing paper is jammed. See page 106.
POLYGON ERROR	If this message appears, unplug the power cord and then plug it back in. If the message still appears, call for service.

## Messages and Signals

PRINTER ERROR	A printer error has occurred. Open the printer compartment cover, make sure the toner cartridge is installed correctly, and then close the cover.
READY TO SEND	A document has been loaded and the fax machine is waiting for you to begin faxing or copying.
RECALLING	This appears if you attempt to send a fax by automatic dialing and the line is busy or the receiving fax machine does not answer. Your fax machine will automatically reattempt the call. (See <i>Automatic redialing</i> on page 47.)
TONER EMPTY/ REPLACE TONER/ CLR TONER COUNT (alternating messages)	The toner cartridge must be replaced. Printing is not possible until the toner cartridge is replaced.
TONER NEAR EMPTY	The toner cartridge is almost out of toner (approximately 100 pages can be printed).
TOTAL PAGE(S) 01	Number of pages transmitted, received, or copied.

### ***Audible signals***

Continuous tone	3 seconds	Indicates the end of transmission, reception, or copying.
Intermittent tone (3 beeps)	5 seconds (1 second on, 1 second off)	Indicates incomplete transmission, reception, or copying.
Rapid intermittent tone	35 seconds (0.7 seconds on, 0.3 seconds off)	Indicates that the handset is off hook.

# Clearing Paper Jams

## Clearing a jammed document

If the original document doesn't feed properly during transmission or copying, or DOCUMENT JAMMED appears in the display, first try pressing the **START** key. If the document doesn't feed out, open the operation panel and remove it.

**Important:**

Do not try to remove a document without opening the operation panel. This may damage the feeder mechanism.

- 1** Open the operation panel by grasping the panel release and pulling up.

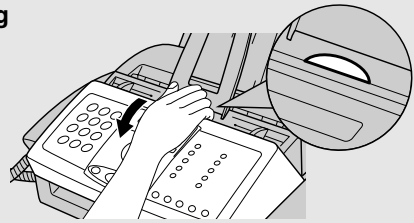

- 2** Remove the document.

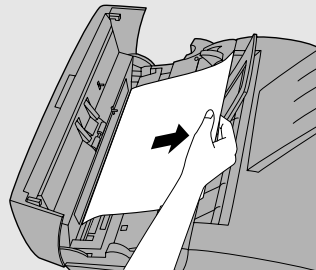

- 3** Close the operation panel, making sure it clicks into place.

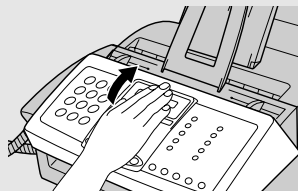

## Clearing jammed printing paper

- 1** If most of the jammed page is protruding from the back of the fax, remove the paper tray cover, pull the paper release lever toward you, and try pulling the page out.

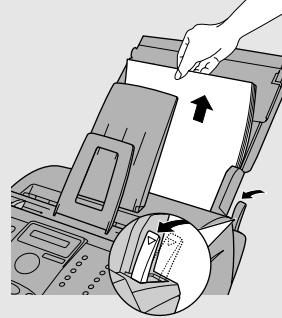

- 2** If the jammed page comes out, take out the rest of the paper in the tray, straighten the stack, put it back in the paper tray, and push down the paper release lever. Replace the paper tray cover.

- If you are unable to clear the jam in this way, continue with the following steps.

- 3** Grasp the print compartment cover at both sides as shown, and pull up to open the cover.

- **Caution!**  
The fusing unit inside the print compartment becomes very hot during operation. Be careful not to touch the inside of the compartment.

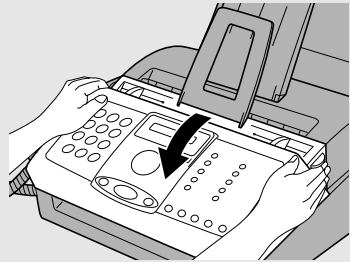

- 4** Grasp the finger hold on the toner cartridge handle where it is marked **PUSH**, and pull the handle out. Rehold the handle and pull the toner cartridge out of the compartment.

- Place the toner cartridge on a sheet of paper on a level surface.

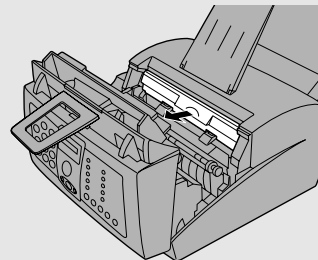

- 5** Grasp the tabs on the drum cartridge handle with both hands and gently pull the cartridge out of the machine.

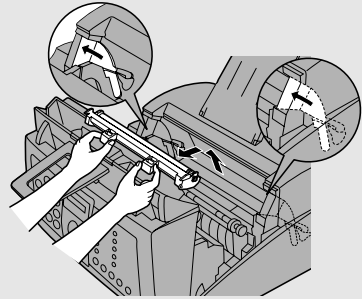

- 6** Wrap the drum cartridge in a large sheet of paper as shown at right so that the green drum section is shielded from light, and place it gently on a level surface.

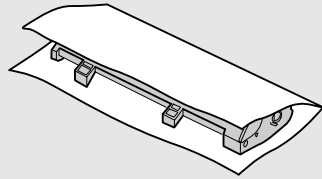

- Do not touch the green drum in the drum cartridge. This will damage the drum surface.
- Do not expose the drum to direct light. This will damage the drum.

- 7** Gently pull the jammed paper out of the machine.

- If needed, turn the wheel on the right side of the fusing unit to eject the paper from the machine.
- **Caution!**  
Do not use excessive force to pull the jammed paper out. If the paper tears and a piece remains inside the machine, a service call may be necessary to remove the remaining piece.

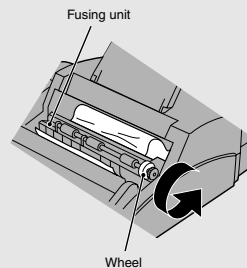
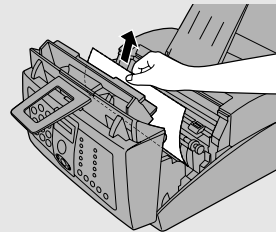

**8** Replace the drum cartridge, holding the tabs on the drum cartridge handle with both hands.

- To insert the cartridge, align the guides on the cartridge with the runners on the sides of the compartment.

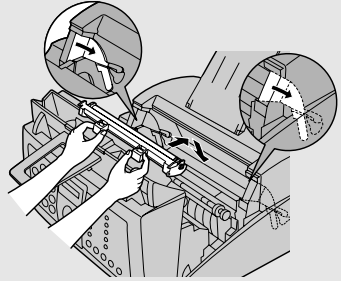

**9** Replace the toner cartridge and close the print compartment cover (see page 15).

## ***FCC Regulatory Information***

This equipment complies with Part 68 of the FCC rules and the requirements adopted by the ACTA. On the rear of this equipment is a label that contains, among other information, a product identifier in the format US:AAAEQ##TXXXX. If requested, this number must be provided to the telephone company.

A plug and jack used to connect this equipment to the premises wiring and telephone network must comply with the applicable FCC Part 68 rules and requirements adopted by the ACTA. A compliant telephone cord and modular plug is provided with this product. It is designed to be connected to a compatible modular jack that is also compliant. See installation instructions for details. This equipment connects to the telephone network through a standard USOC RJ-11C network interface jack.

The REN is used to determine the number of devices that may be connected to a telephone line. Excessive RENs on a telephone line may result in the devices not ringing in response to an incoming call. In most but not all areas, the sum of RENs should not exceed five (5.0). To be certain of the number of devices that may be connected to a line, as determined by the total RENs, contact the local telephone company. For products approved after July 23, 2001, the REN for this product is part of the product identifier that has the format US:AAAEQ##TXXXX. The digits represented by ## are the REN without a decimal point (e.g., 03 is a REN of 0.3). For earlier products, the REN is separately shown on the label.

If this equipment causes harm to the telephone network, the telephone company will notify you in advance that temporary discontinuance of service may be required. But if advance notice isn't practical, the telephone company will notify the customer as soon as possible. Also, you will be advised of your right to file a complaint with the FCC if you believe it is necessary.

The telephone company may make changes in its facilities, equipment, operations or procedures that could affect the operation of the equipment. If this happens the telephone company will provide advance notice in order for you to make necessary modifications to maintain uninterrupted service.

If trouble is experienced with this equipment, or for repair or warranty information, please contact your authorized Sharp dealer. If the equipment is causing harm to the telephone network, the telephone company may request that you disconnect the equipment until the problem is resolved.

This equipment may not be used on coin service provided by the telephone company. Connection to party line service is subject to state tariffs. Contact the state public utility commission, public service commission or corporation commission for information.

If your home has specially wired alarm equipment connected to the telephone line, ensure the installation of this equipment does not disable your alarm equipment. If you have questions about what will disable alarm equipment, consult your telephone company or a qualified installer.

This equipment is hearing-aid compatible.

When programming and/or making test calls to emergency numbers:

- ◆ Remain on the line and briefly explain to the dispatcher the reason for the call.
- ◆ Perform such activities in the off-peak hours, such as early morning or late evening.

# S H A R P

Date Revised : Apr. 9, 2003

Date Issued : July. 16. 1999

## MATERIAL SAFETY DATA SHEET (1/4)

MSDS No. P-00102

### 1. PRODUCT AND COMPANY IDENTIFICATION

**Product Name:** FO-29ND / FO-29DC / FO-29DCCN (Black Toner)**Supplier Identification:** Sharp Corporation

22-22 Nagaike-cho, Abeno-ku, Osaka, Japan

Local suppliers are listed below. Please contact the nearest supplier for additional information.

(Country)	(Name and Telephone Number)
U.S.A	Sharp Electronics Corporation Sharp Plaza, Mahwah, NJ Telephone number for information : 1-800-237-4277 Emergency telephone number : 1-800-255-3924
Canada	Sharp Electronics of Canada Ltd. Telephone number for information : 905-890-2100 Emergency telephone number : 1-800-255-3924

### 2. COMPOSITION/INFORMATION ON INGREDIENTS

Substance[]	Preparation[X]					
Ingredients	CAS No.	Proportion	OSHA PEL	ACGIH TLV	Other Limits	Other Limits
Styrene-Acrylate copolymer	27136-15-8	>90%	Not listed	Not listed	Not listed	Not listed
Carbon black	1333-86-4	< 5%	3.5mg/m <sup>3</sup>	3.5mg/m <sup>3</sup>	Not listed	3.5mg/m <sup>3</sup>
Iron oxide	1317-61-9	< 2%	Not listed	Not listed	Not listed	Not listed
Silica	68909-20-6	< 2%	0.8mg/m <sup>3</sup>	10mg/m <sup>3</sup>	Not listed	Not listed
Metal Complex dye*	109125-51-1 84179-66-8	< 1%	0.5mg/m <sup>3</sup>	0.5mg/m <sup>3</sup>	Not listed	Not listed

\* EC NO. : 400-110-2, Symbol letter : F, R Phrase : R11

### 3. HAZARDS IDENTIFICATION

#### Most Important Hazards and Effects of the Products

**Human Health Effects :** There are no anticipated carcinogenic effects from exposure based on animal tests performed using toner. When used as intended according to instructions, studies do not indicate any symptoms of fibrosis will occur.**Environmental Effects :** No data are available.**Specific Hazards:** : Dust explosion (like most finely divided organic powders)**Directive 1999/45/EC(Europe):** : Not classified as dangerous

### 4. FIRST-AID MEASURES

Route(s) of Entry	: Inhalation?	Skin?	Ingestion?
	Yes	No	Possible but very unusual.
<b>Inhalation</b>	: Remove to fresh air. If symptoms occur, consult medical personnel.		
<b>Skin Contact</b>	: Wash with soap and water for 15 minutes or until particle is removed. If irritation does occur, consult medical personnel.		
<b>Eye Contact</b>	: flush eyes immediately with water for 15 minutes. If irritation does occur, consult medical personnel.		
<b>Ingestion</b>	: Rinse with water and drink several glasses of water . If irritation or discomfort does occur, consult medical personnel.		



# S H A R P

Date Revised : Apr. 9, 2003

Date Issued : July. 16. 1999

## MATERIAL SAFETY DATA SHEET (2/4)

MSDS No. P-00102

### 5. FIRE -FIGHTING MEASURES

**Extinguishing Media** : water , CO2, foam and dry chemicals  
**Special Fire fighting Procedures** : None  
**Fire and Explosion Hazards** : Toner material, like most finely divided organic powders, may form an explosive mixture.

### 6. ACCIDENTAL RELEASE MEASURES

**Personal Precautions** : None  
**Environmental Precautions** : None  
**Methods for Cleaning Up** : Wipe off with paper or cloth. Do not use vacuum cleaner when a large amount is released. It, like most finely divided organic powders, is capable of creating a dust explosion.

### 7. HANDLING AND STORAGE

**Handling**  
Technical Measures : None  
Precautions : None  
Safe Handling Advice : Use of a dust mask is recommended when handling a large quantity of toner or during long term exposure, as with any non-toxic dust. Try not to disperse the particles.  
**Storage**  
Technical Measures : None  
Storage Conditions : Keep container closed and Store in a cool and dry place.  
Keep out of the reach of children.  
Incompatible Products : None

### 8. EXPOSURE CONTROLS/PERSONAL PROTECTION

**Engineering Measures**  
Ventilation : Not required under intended use.  
**Exposure limit values**  
OSHA-PEL(USA) : 15mg/m<sup>3</sup>(Total Dust) , 5mg/m<sup>3</sup>(Respirable Dust)  
ACGIH-TLV(USA) : 10mg/m<sup>3</sup>(Total Dust) , 3mg/m<sup>3</sup>(Respirable Dust)  
**Personal Protective Equipment**  
Respiratory Protection : Not required under intended use .  
Hand Protection : Not required under intended use .  
Eye Protection : Not required under intended use .  
Skin Protection : Not required under intended use .  
Other Protective equipment : Use of a dust mask and goggles are recommended when handling a large quantity of toner or during long term exposure, as with any non-toxic dust.

### 9. PHYSICAL AND CHEMICAL PROPERTIES

**Appearance**  
Physical State : Solid      Form: Powder      Color: Black      Odor: odorless  
**Ph** : Not applicable  
**Boiling/Melting Point** : Not applicable  
**Softening Point(°C )** : No data  
**Flash Point(°C )** : Not applicable  
**Ignition Point(°C )** : No data  
**Explosion Properties** : No data  
**Density(g/cm<sup>3</sup>)** : 1.1  
**Solubility in water** : Negligible

# S H A R P

Date Revised : Apr. 9, 2003

Date Issued : July. 16. 1999

## MATERIAL SAFETY DATA SHEET (3/4)

MSDS No. P-00102

### 10. STABILITY AND REACTIVITY

Stability	: Stable
Hazardous Reactions	: Dust explosion, like most finely divided organic powders.
Conditions to avoid	: Electric discharge, throwing into fire.
Materials to avoid	: Oxidizing Materials
Hazardous Decomposition Products	: CO, CO <sub>2</sub> and NO <sub>x</sub>
Further Information	: None

### 11. TOXICOLOGICAL INFORMATION

<b>Acute Toxicity</b>	
Ingestion(oral)	: LD <sub>50</sub> >2000mg/kg(Rats)
Dermal	: LD <sub>50</sub> >2000mg/kg(Rats)
Inhalation	: No data
Eye irritation	: Not an irritant
Skin irritation	: Not an irritant
Skin sensitizer	: No sensitization
<b>Mutagenicity</b>	: Negative(Ames Test)
<b>Carcinogenicity</b>	: In 1996 the IARC reevaluated carbon black as a Group 2B carcinogen (possible human carcinogen). This classification is given to chemicals for which there is inadequate human evidence, but sufficient animal evidence on which to base an opinion of carcinogenicity. The classification is based upon the development of lung tumors in rats receiving chronic inhalation exposures to free carbon black at levels that induce particle overload of the lung. Studies performed in animal models other than rats did not show any association between carbon black and lung tumors. Moreover, a two-year cancer bioassay using a typical toner preparation containing carbon black demonstrated no association between toner exposure and tumor development in rats.
<b>Chronic Effect</b>	: In a study in rats of chronic inhalation exposure to a typical toner, a mild to moderate degree of lung fibrosis was observed in 92% of the rats in the high concentration (16mg/m <sup>3</sup> ) exposure group, and a minimal to mild degree of fibrosis was noted in 22% of the animals in the middle (4mg/m <sup>3</sup> ) exposure group, but no pulmonary change was reported in the lowest (1mg/m <sup>3</sup> ) exposure group, the most relevant level to potential human exposures.

### 12. ECOLOGICAL INFORMATION

No data are available.

### 13. DISPOSAL CONSIDERATIONS

<b>Waste from residues</b>	: Waste material may be dumped or incinerated under conditions which meet all federal, state and local environmental regulations.
<b>Contaminated Packaging</b>	: Waste may be disposed or incinerated under conditions which meet all federal, state and local environmental regulations.

### 14. TRANSPORT INFORMATION

UN Classification	: None
Not classified as hazardous for transport.	

# S H A R P

Date Revised : Apr. 9, 2003

Date Issued : July. 16. 1999

## MATERIAL SAFETY DATA SHEET (4/4)

MSDS No. P-00102

### 15. REGULATORY INFORMATION

#### US Information

TSCA(Toxic Substances Control Act) :

All chemical substances in this product comply with all applicable rules or order under TSCA.

SARA(Superfund Amendments and Reauthorization Act) Title III

302 Extreme Hazardous Substance : None

311/312 Hazard Classification : None

#### EU Information

1999/45/EC and 67/548/EEC

Symbol & Indication : Not required

R-Phrase : Not required

76/769/EEC : All chemical substances in this product comply with all applicable rules or order under 76/769/EEC.

### 16. OTHER INFORMATION

NFPA Rating (USA) : Health=1 Flammability=1 Reactivity=0

WHMIS Legislation (Canada) : This product is not a controlled product.

List of R phrases : R11 : Highly flammable

#### References

IARC(1996) : IARC monographs on the Evaluation of the Carcinogenic Risk of Chemicals to Humans, Vol. 65, Printing Process And Printing Inks, Carbon Black and Some Nitro Compounds, Lyon, pp.149-261

H.Muhle, B.Bellmann, O.Creutzenberg, C.Dasenbrock, H.Ernst, R.Kilpper, J.C.MacKenzie, P.Morrow, U.Mohr, S.Takenaka, and R.Mermelstein(1991) Pulmonary Response to Toner upon Chronic Inhalation Exposure in Rats. Fundamental and Applied Toxicology 17, pp.280-299.

The information on this data sheet represents our current data and best opinion as to the proper use in handling of this product under normal conditions. However, all materials may present unknown hazards and should be used with caution. Although certain hazards are described herein, we do not guarantee that these are the only hazards which exist.



# Quick Reference Guide

## Sending Faxes

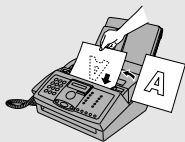
Place your document (up to 20 pages) face down in the document feeder.



### Normal Dialing

1. Lift the handset or press .
2. Dial the fax number.
3. Wait for the reception tone (if a person answers, ask them to press their Start key).
4. Press .



### Rapid Key Dialing

Press the appropriate Rapid Key. Transmission will begin automatically.

### Speed Dialing

1. Press .
2. Enter the 2-digit Speed Dial number.
3. Press .

### Search Dialing

1. Press  or  until the desired destination appears in the display.
2. Press .

### Direct Keypad Dialing

1. Dial the fax number.
2. Press .

## Receiving Faxes

Press  until the arrow in the display points to the desired reception mode.

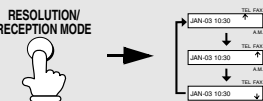





**FAX mode:** The fax machine automatically answers and receives faxes.

**TEL mode:** Answer all calls (even faxes) by picking up the handset. To begin fax

reception, press .

**AM mode:** Select this mode when you want to use an answering machine that is connected to the fax.

## Storing Auto Dial Numbers

1. Press  once and  once.
2. Enter a 2-digit Speed Dial number (01 to 99; 01 to 10 for Rapid Key Dialing).
3. Enter the fax number and press .
4. Enter a name by pressing number keys. (To enter two letters in succession that require the same key, press  after entering the first letter.)

SPACE = 1	G = 4	N = 6 8	U = 8 8
A = 2	H = 4 4	O = 6 6 6	V = 8 8 8
B = 2 2	I = 4 4 4	P = 7	W = 9
C = 2 2 2	J = 5	Q = 7 7	X = 9 9
D = 3	K = 5 5	R = 7 7 7	Y = 9 9 9
E = 3 3	L = 5 5 5	S = 7 7 7 7	Z = 9 9 9 9
F = 3 3 3	M = 6	T = 8	

5. Press  and then .



# Guía de referencia rápida

## Transmisión de documentos

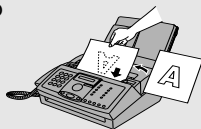
Coloque el documento (hasta 20 páginas) mirando hacia abajo en el alimentador.





### Marcación normal

1. Levante el auricular o pulse  .
2. Marque el número de telefax.
3. Espere a escuchar el tono de recepción (si alguien contesta el teléfono, pídale que pulse su tecla Inicio).
4. Pulse  .



### Marcación por tecla rápida

Pulse la Tecla rápida apropiada. La transmisión comenzará automáticamente.

### Marcación abreviada

1. Pulse  .
2. Introduzca el número de 2 dígitos de marcación abreviada.
3. Pulse  .

### Marcación por búsqueda

1. Pulse  o  hasta que aparezca el número deseado en el display.
2. Pulse  .

### Marcación directa por teclado

1. Marque el número de telefax.
2. Pulse  .

## Recepción de documentos

Pulse  hasta que la flecha del display señale el modo de recepción deseado.

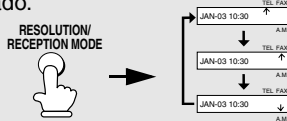





**Modo FAX:** El aparato de telefax contestará y recibirá documentos automáticamente.



**Modo TEL:** Contesta todas las llamadas (incluso las de telefax) levantando el auricular. Para que comience la recepción del documento, pulse  .

**Modo AM:** Seleccione este modo si desea utilizar un contestador automático conectado al aparato de telefax.

## Programación de números de marcación automática

1. Pulse  una vez y  dos veces.
2. Introduzca un número de 2 dígitos de Marcación abreviada (01 a 99; 01 a 10 para una Marcación por tecla rápida).
3. Introduzca el número de telefax y pulse  .
4. Introduzca un nombre pulsando las teclas numéricas. (Para introducir dos letras sucesivas que requieran la misma tecla, pulse  después de introducir la primera letra).

SPACE = 1	G = 4	N = 6 6	U = 8 8
A = 2	H = 4 4	O = 6 6 6	V = 8 8 8
B = 2 2	I = 4 4 4	P = 7	W = 9
C = 2 2 2	J = 5	Q = 7 7	X = 9 9
D = 3	K = 5 5	R = 7 7 7	Y = 9 9 9
E = 3 3	L = 5 5 5	S = 7 7 7 7	Z = 9 9 9 9
F = 3 3 3	M = 6	T = 8	

5. Pulse  y, a continuación,  .

---

# Index

## A

- Activity Report, 85
- Activity Report, Auto Print Out, 89
- AM reception mode, 27, 69
- Answering machine connection
  - Activating, 69
  - Connecting, 68
  - On TAD Failure, 73
  - Quiet Detect Start Time, 72
  - Quiet Detect Time, 70
  - Troubleshooting, 101
- Anti Junk Fax, 76
- Audible signals, 104
- Auto-dial numbers
  - Searching for, 45
  - Storing, 39

## B

- Batch page numbering, 52
- Beep length, 30
- Broadcasting, 53-54

## C

- Contrast, 34
- Copies, 66
- Copy cut-off setting, 67
- Cover Sheet, 50

## D

- Date, setting, 24-25
- Daylight Saving Time, 26
- Dial mode, 11
- Dialing
  - Direct Keypad, 46
  - Normal, 37
  - Rapid Key, 43
  - Searching, 45
  - Speed, 44
- Direct Keypad Dialing, 46
- Display messages, 102

- Distinctive ring, 74
- Document feeder, 32
- Document guides, 32
- Document restrictions, 32
- Document sizes, 31
- Document, maximum scanning size, 31
- Drum cartridge
  - Cleaning, 95
  - Preparing, 16
  - Replacing, 92

## E

- ECM (Error Correction Mode), 49
- Extension telephone
  - Connecting, 14
  - Using, 60

## F

- FAX reception mode, 27, 58
- Fax Signal Receive, 62
- Fine resolution priority, 36

## G

- Group Keys, 55
- Group List, 86

## H

- Halftone setting, 34
- Handset, 10
- Handset receiver volume, 29
- Header message, 51
- Hold, 61
- Housing, cleaning, 91

## J

- Jams, clearing, 105-108

## L

- Letters, entering, 23, 40

Line error, 97

Loading printing paper, 19

Loading the document, 32

## M

Memory, substitute reception to, 65

## N

Normal dialing, 37

Number of rings in FAX reception mode,  
58

## P

Page numbering, batch, 52

Paper jams, clearing, 105-108

Paper size setting, 21

Paper, loading, 19

Polling, 78

Power cord, 10

## R

Rapid Key Dialing, 43

Recall interval, 48

Recall times, 48

Reception mode

AM mode, 27, 69

FAX mode, 27, 58

TEL mode, 27, 59

Reception Ratio setting, 64

Redialing, 47

Removing original document, 33

Resolution, 34

Ringer volume, 29

## S

Scanning glass, cleaning, 90

Sender's name and number, entering,  
22-23

Setup List, 86

Speaker volume, 28

Speed Dialing, 44

## T

TEL reception mode, 27, 59

TEL. LINE jack, 11

TEL. SET jack, 14, 68

Tel/Fax Remote Number, 63

Telephone line cord, 11

Telephone Number List, 86

Time, setting, 24-25

Toner cartridge

Installing, 15

Replacing, 91

Transaction Report, 87

Setting print condition, 88

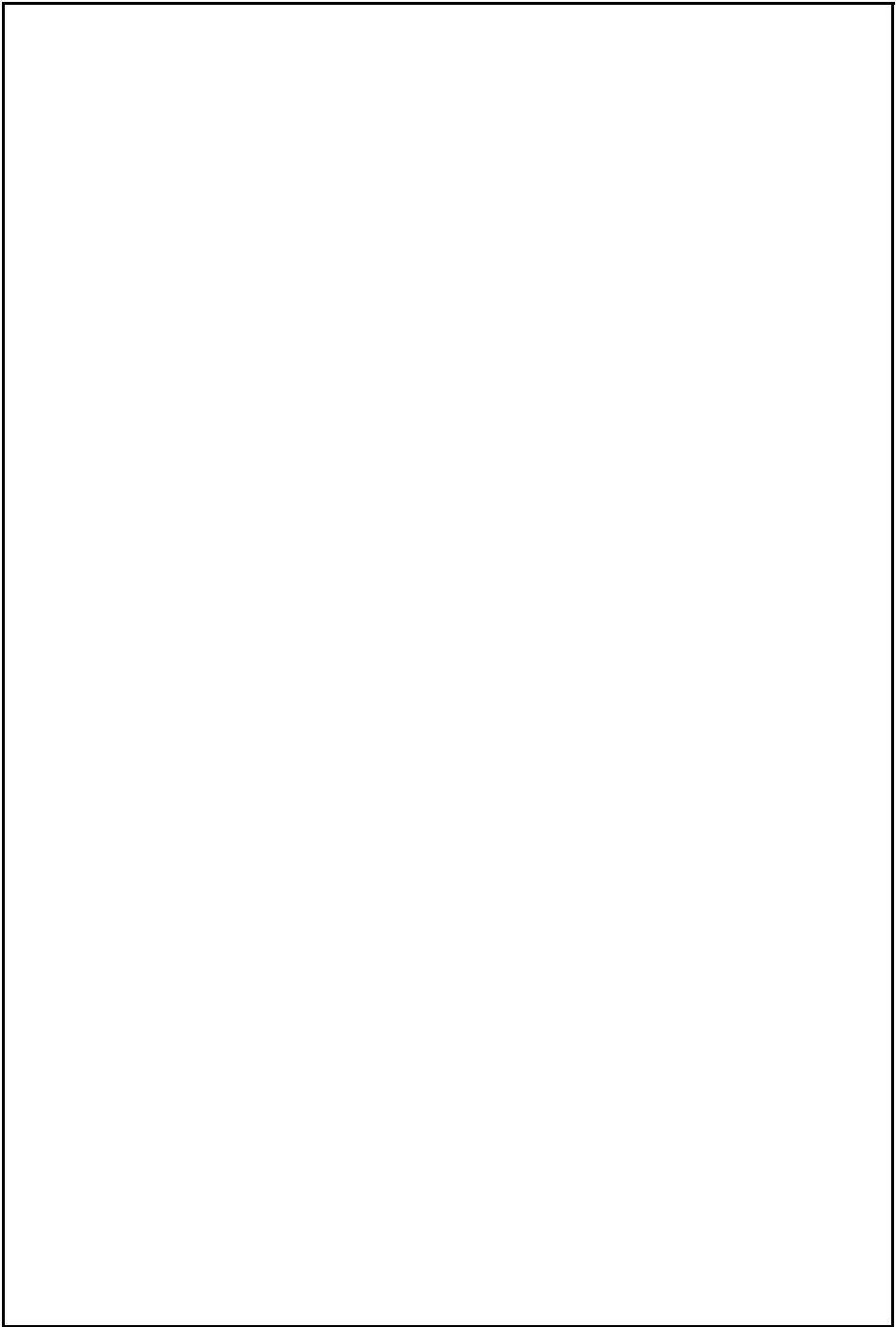



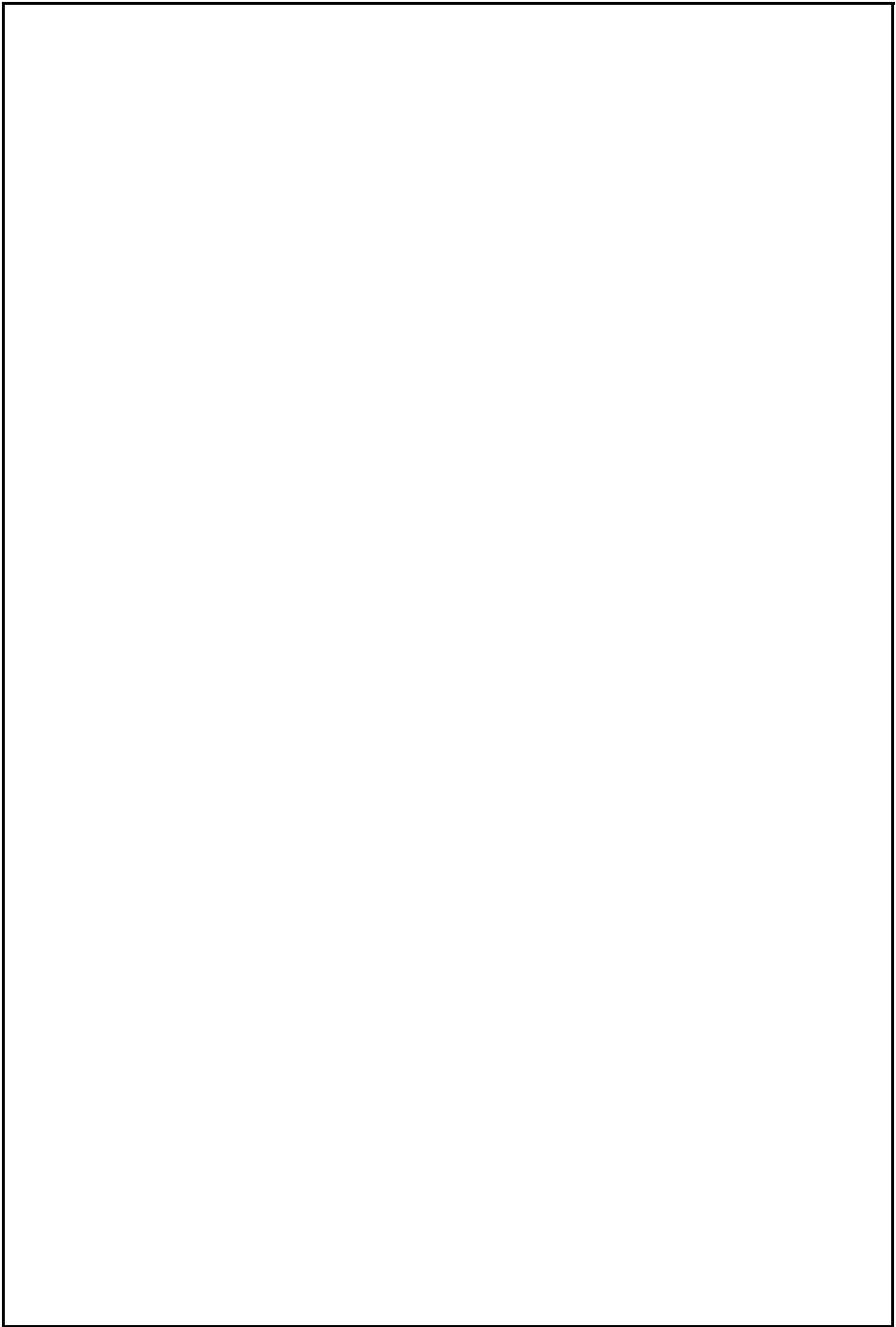

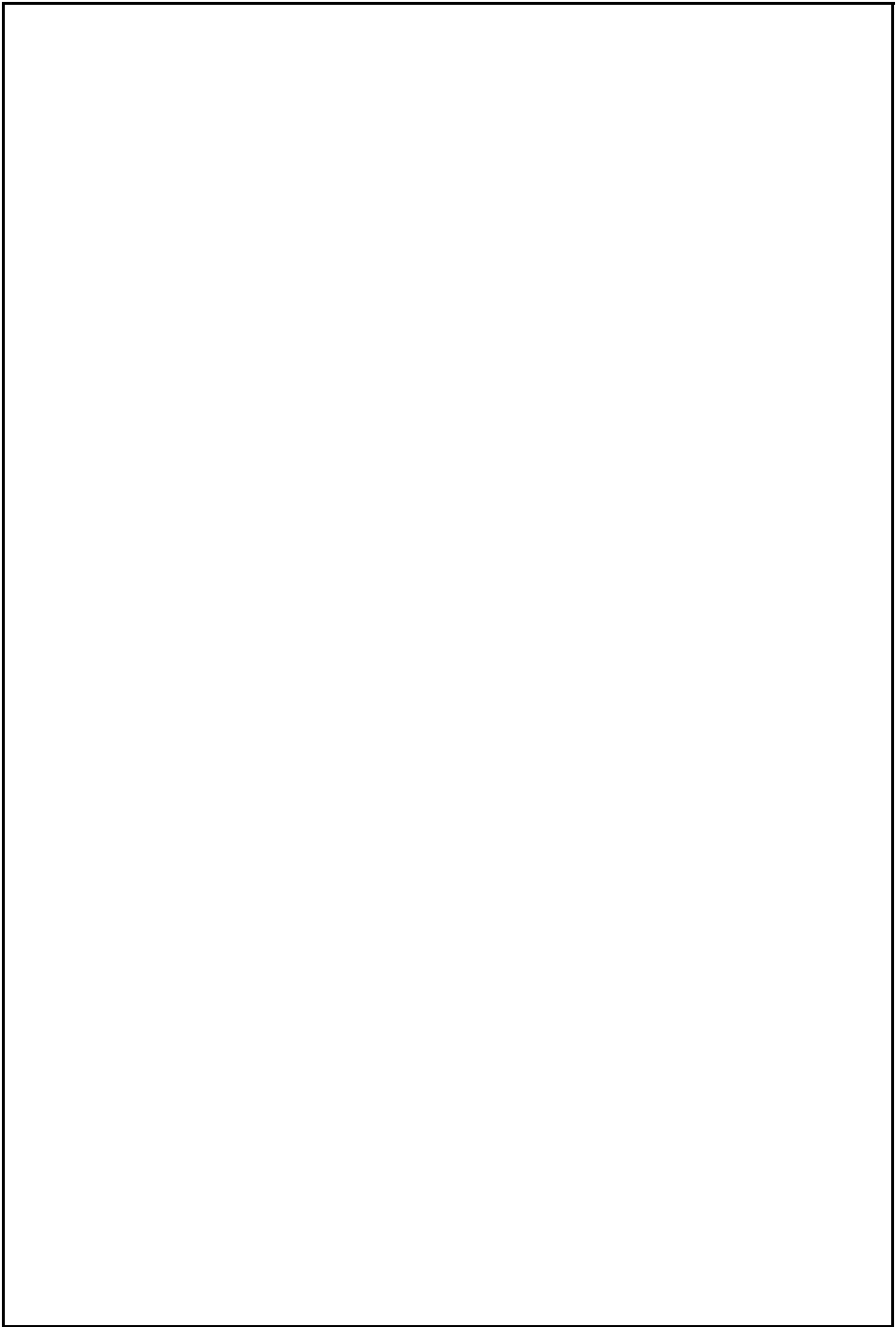

## NOTICE

BE SURE TO ASK YOUR AUTHORIZED SHARP DEALER ABOUT THE WARRANTY THAT YOUR SELLING DEALER EXTENDS TO YOU. In order to assure you, the end-user, of warranty protection, Sharp extends a limited warranty to each of its authorized dealers and, in turn, requires each of its authorized dealers to extend its own warranty to you on terms that are no less favorable than those given to the dealer by Sharp. You should be aware, however, that Sharp does not itself extend any warranties, either express or implied, directly to you, the end-user, and no one is authorized to make any representations or warranties on behalf of Sharp. Specifically, SHARP DOES NOT EXTEND TO YOU, THE END-USER, ANY EXPRESS WARRANTY OR ANY IMPLIED WARRANTY OF MERCHANTABILITY, FITNESS FOR USE OR FITNESS FOR ANY PARTICULAR PURPOSE IN CONNECTION WITH THE HARDWARE, SOFTWARE OR FIRMWARE EMBODIED IN, OR USED IN CONJUNCTION WITH THIS PRODUCT. Sharp is not responsible for any damages or loss, either direct, incidental or consequential, which you, the end-user, may experience as a result of your purchase or use of the hardware, software or firmware embodied in or used in conjunction with this Product. Your sole remedy, in the event that you encounter any difficulties with the Product, is against the authorized dealer from which you purchased the Product. In the event that this authorized dealer does not honor its warranty commitments, please contact the Vice President, Sharp Electronics Corporation, Sharp Plaza, Mahwah, NJ 07430-1163, so that Sharp can try to help assure complete satisfaction of all the warranty rights to which you are entitled from the authorized dealer.

# SHARP®

**SHARP ELECTRONICS CORPORATION**

**Sharp Plaza, Mahwah, New Jersey 07430-1163**

**1-800-BE-SHARP**

**<http://www.sharpusa.com>**

## SHARP CORPORATION

### FOR YOUR RECORDS

Please record the model number and serial number below, for easy reference, in case of loss or theft. These numbers are located on the rear side of the unit. Space is also provided for other relevant information.

Model Number      FO-3150

Serial Number      \_\_\_\_\_

Date of Purchase      \_\_\_\_\_

Place of Purchase      \_\_\_\_\_

PRINTED IN THAILAND

(TINSE4357XHTZ)