

LC-20SH21U

LIQUID CRYSTAL TELEVISION

ENGLISH



OPERATION MANUAL

IMPORTANT:

To aid reporting in case of loss or theft, please record the TV's model and serial numbers in the space provided. The numbers are located at the rear of the TV.

Model No.:	
Serial No.:	

IMPORTANT INFORMATION

WARNING: TO REDUCE THE RISK OF FIRE OR ELECTRIC SHOCK, DO NOT EXPOSE THIS PRODUCT TO RAIN OR MOISTURE.

	<p>CAUTION</p> <p>RISK OF ELECTRIC SHOCK DO NOT OPEN</p>	
---	---	---

CAUTION: TO REDUCE THE RISK OF ELECTRIC SHOCK, DO NOT REMOVE COVER (OR BACK). NO USER-SERVICEABLE PARTS INSIDE. REFER SERVICING TO QUALIFIED SERVICE PERSONNEL.



The lightning flash with arrow-head symbol, within an equilateral triangle, is intended to alert the user to the presence of uninsulated "dangerous voltage" within the product's enclosure that may be of sufficient magnitude to constitute a risk of electric shock to persons.



The exclamation point within a triangle is intended to alert the user to the presence of important operating and maintenance (servicing) instructions in the literature accompanying the product.

IMPORTANT INFORMATION (Continued)

CAUTION: TO PREVENT ELECTRIC SHOCK, MATCH WIDE BLADE OF PLUG TO WIDE SLOT, FULLY INSERT.

CAUTION:

DO NOT PLACE THIS PRODUCT ON AN UNSTABLE CART, STAND, TRIPOD, BRACKET, OR TABLE. THE PRODUCT MAY FALL CAUSING SERIOUS PERSONAL INJURY AND SERIOUS DAMAGE TO THE PRODUCT. USE ONLY WITH A CART, STAND, TRIPOD, BRACKET, OR TABLE RECOMMENDED BY THE MANUFACTURER OR SOLD WITH THE PRODUCT. FOLLOW THE MANUFACTURER'S INSTRUCTIONS WHEN INSTALLING THE PRODUCT AND USE MOUNTING ACCESSORIES RECOMMENDED BY THE MANUFACTURER. A PRODUCT AND CART COMBINATION SHOULD BE MOVED WITH CARE. QUICK STOPS, EXCESSIVE FORCE, AND UNEVEN SURFACES MAY CAUSE THE PRODUCT AND CART COMBINATION TO OVERTURN.



WARNING: FCC Regulations state that any unauthorized changes or modifications to this equipment not expressly approved by the manufacturer could void the user's authority to operate this equipment.

U.S.A. ONLY

DECLARATION OF CONFORMITY

SHARP LIQUID CRYSTAL TELEVISION, MODEL LC-20SH21U.

This device complies with Part 15 of the FCC Rules. Operation is subject to the following two conditions:

(1) This device may not cause harmful interference, and (2) this device must accept any interference received, including interference that may cause undesired operation.

RESPONSIBLE PARTY:

SHARP ELECTRONICS CORPORATION
Sharp Plaza, Mahwah, New Jersey 07430-2135
TEL: 1-800-BE-SHARP

For Business Customers: URL <http://www.sharppusa.com>

U.S.A. ONLY

INFORMATION:

This equipment has been tested and found to comply with the limits for a Class B digital device, pursuant to Part 15 of the FCC Rules. These limits are designed to provide reasonable protection against harmful interference in a residential installation. This equipment generates, uses and can radiate radio frequency energy and, if not installed and used in accordance with the instructions, may cause harmful interference to radio communications. However, there is no guarantee that interference will not occur in a particular installation. If this equipment does cause harmful interference to radio or television reception, which can be determined by turning the equipment off and on, the user is encouraged to try to correct the interference by one or more of the following measures:

- Reorient or relocate the receiving antenna.
- Increase the separation between the equipment and receiver.
- Connect the equipment into an outlet on a circuit different from that to which the receiver is connected.
- Consult the dealer or an experienced radio/TV technician for help.

U.S.A. ONLY

Note to CATV system installer: This reminder is provided to call the CATV system installer's attention to Article 820-40 of the National Electrical Code that provides guidelines for proper grounding and, in particular, specifies that the cable ground shall be connected to the grounding system of the building, as close to the point of cable entry as practical.

U.S.A. ONLY

This product utilizes tin-lead solder, and fluorescent lamp containing a small amount of mercury. Disposal of these materials may be regulated due to environmental considerations. For disposal or recycling information, please contact your local authorities or the Electronic Industries Alliance: www.eia.org

Trademark

HDMI, the HDMI logo and High-Definition Multimedia Interface are trademarks or registered trademarks of HDMI Licensing LLC.

Products that have earned the ENERGY STAR® are designed to protect the environment through superior energy efficiency.

DEAR SHARP CUSTOMER

Thank you for your purchase of the Sharp Liquid Crystal Television. To ensure safety and many years of trouble-free operation of your product, please read the Important Safety Precautions carefully before using this product.

IMPORTANT SAFETY PRECAUTIONS

Electricity is used to perform many useful functions, but it can also cause personal injuries and property damage if improperly handled. This product has been engineered and manufactured with the highest priority on safety. However, improper use can result in electric shock and/or fire. In order to prevent potential danger, please observe the following instructions when installing, operating and cleaning the product. To ensure your safety and prolong the service life of your LCD color TV product, please read the following precautions carefully before using the product.

- ◆ Read instructions—All operating instructions must be read and understood before the product is operated.
- ◆ Keep this manual in a safe place—These safety and operating instructions must be kept in a safe place for future reference.
- ◆ Observe warnings—All warnings on the product and in the instructions must be observed closely.
- ◆ Follow instructions—All operating instructions must be followed.
- ◆ Attachments—Do not use attachments not recommended by the manufacturer. Use of inadequate attachments can result in accidents.
- ◆ Power source—This product must operate on a power source specified on the specification label. If you are not sure of the type of power supply used in your home, consult your dealer or local power company. For units designed to operate on batteries or another power source, refer to the operating instructions.
- ◆ AC cord protection—The AC cord must be routed properly to prevent people from stepping on it or objects from resting on it. Check the cord at the plugs and product.
- ◆ Overloading—Do not overload AC outlets or extension cords. Overloading can cause fire or electric shock.
- ◆ Entering of objects and liquids—Never insert an object into the product through vents or openings. High voltage flows in the product, and inserting an object can cause electric shock and/or short internal parts. For the same reason, do not spill water or liquid on the product.
- ◆ Servicing—Do not attempt to service the product yourself. Removing covers can expose you to high voltage and other dangerous conditions. Request a qualified service person to perform servicing.
- ◆ Repair—If any of the following conditions occurs, unplug the AC cord from the AC outlet, and request a qualified service person to perform repairs.
 - a. When the AC cord or plug is damaged.
 - b. When a liquid was spilled on the product or when objects have fallen into the product.
 - c. When the product has been exposed to rain or water.
 - d. When the product does not operate properly as described in the operating instructions.

Do not touch the controls other than those described in the operating instructions. Improper adjustment of controls not described in the instructions can cause damage, which often requires extensive adjustment work by a qualified technician.
 - e. When the product has been dropped or damaged.
 - f. When the product displays an abnormal condition. Any noticeable abnormality in the product indicates that the product needs servicing.
- ◆ Replacement parts—In case the product needs replacement parts, make sure that the service person uses replacement parts specified by the manufacturer, or those with the same characteristics and performance as the original parts. Use of unauthorized parts can result in fire, electric shock and/or other danger.
- ◆ Safety checks—Upon completion of service or repair work, request the service technician to perform safety checks to ensure that the product is in proper operating condition.
- ◆ Wall or ceiling mounting—When mounting the product on a wall or ceiling, be sure to install the product according to the method recommended by the manufacturer.
- ◆ Polarization—This AC cord may be equipped with a polarized alternating current line plug (a plug having one blade wider than the other). This plug will fit into the power outlet only one way. This is a safety feature. If you are unable to insert the plug fully into the outlet, try reversing the plug. If the plug should still fail to fit, contact your electrician to replace your obsolete outlet.

Do not defeat the safety purpose of the polarized plug.

IMPORTANT SAFETY PRECAUTIONS (Continued)

- ◆ Cleaning—Unplug the AC cord from the AC outlet before cleaning the product. Use a damp cloth to clean the product. Do not use liquid cleaners or aerosol cleaners.

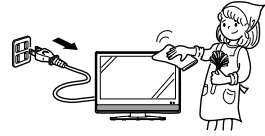

- ◆ Water and moisture—Do not use the product near water, such as bathtub, washbasin, kitchen sink and laundry tub, swimming pool and in a wet basement.



- ◆ Stand—Do not place the product on an unstable cart, stand, tripod or table. Placing the product on an unstable base can cause the product to fall, resulting in serious personal injuries as well as damage to the product. Use only a cart, stand, tripod, bracket or table recommended by the manufacturer or sold with the product. When mounting the product on a wall, be sure to follow the manufacturer's instructions. Use only the mounting hardware recommended by the manufacturer.



- ◆ When relocating the product placed on a cart, it must be moved with utmost care. Sudden stops, excessive force and uneven floor surface can cause the product to fall from the cart.



- ◆ Ventilation—The vents and other openings in the cabinet are designed for ventilation. Do not cover or block these vents and openings since insufficient ventilation can cause overheating and/or shorten the life of the product. Do not place the product on a bed, sofa, rug or other similar surface, since they can block ventilation openings. This product is not designed for built-in installation; do not place the product in an enclosed place such as a bookcase or rack, unless proper ventilation is provided or the manufacturer's instructions are followed.

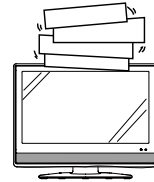

- ◆ The Liquid Crystal panel used in this product is made of glass. Therefore, it can break when the product is dropped or applied with impact. Be careful not to be injured by broken glass pieces in case the Liquid Crystal panel breaks.



- ◆ Heat sources—Keep the product away from heat sources such as radiators, heaters, stoves and other heat-generating products (including amplifiers).

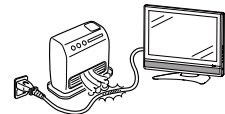

- ◆ The Liquid Crystal panel is a very high technology product with 3,147,264 thin film transistors, giving you fine picture details. Occasionally, a few non-active pixels may appear on the screen as a fixed point of blue, green or red. Please note that this does not affect the performance of your product.

IMPORTANT SAFETY PRECAUTIONS (Continued)

- ◆ If an outside antenna is connected to the television equipment, be sure the antenna system is grounded so as to provide some protection against voltage surges and built-up static charges. Section 810 of the National Electrical Code provides information with respect to proper grounding of the mast and supporting structure, grounding of the lead-in wire to an antenna discharge unit, size of grounding conductors, location of antenna-discharge unit, connection to grounding electrodes, and requirements for the grounding electrode.

EXAMPLE OF ANTENNA GROUNDING AS PER NATIONAL ELECTRICAL CODE

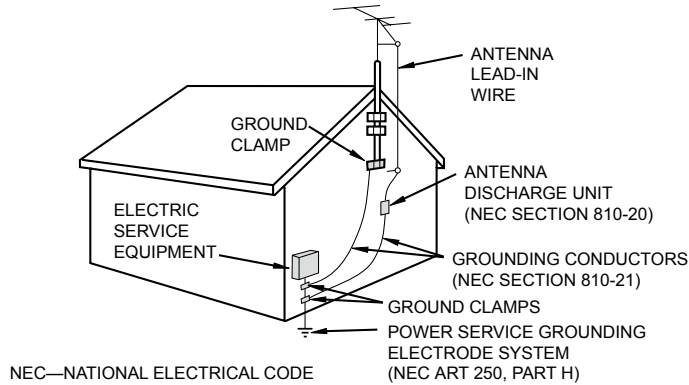

- ◆ Lightning – For added protection for this television equipment during a lightning storm, or when it is left unattended and unused for a long period of time, unplug it from the wall outlet and disconnect the antenna. This will prevent damage to the equipment due to lightning and power-line surges.

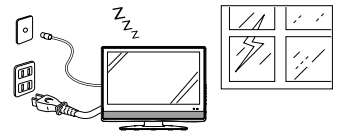

- ◆ Power Lines – An outside antenna system should not be located in the vicinity of overhead power lines or other electric light or power circuits, or where it can fall into such power lines or circuits. When installing an outside antenna system, extreme care should be taken to keep from touching such power lines or circuits as contact with them might be fatal.

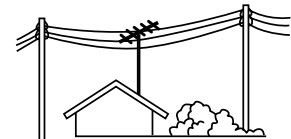

- ◆ To prevent fire, never place any type of candle or flames on the top or near the TV set.

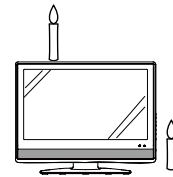

- ◆ To prevent fire or shock hazard, do not expose this product to dripping or splashing. No objects filled with liquids, such as vases, should be placed on the product.



- ◆ To prevent fire or shock hazard, do not place the AC cord under the TV set or other heavy items.

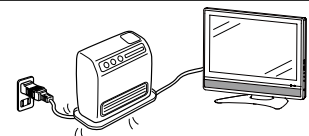

- ◆ Do not display a still picture for a long time, as this could cause an afterimage to remain.



- ◆ Install the product on the place where the AC cord can be unplugged easily from the AC outlet, or from the AC INPUT terminal on the rear of the product.

Contents

IMPORTANT INFORMATION	1	Connecting a PC	31
Trademark	2	Viewing an Image from a PC	31
DEAR SHARP CUSTOMER	3	Displaying an Image from a PC.....	31
IMPORTANT SAFETY PRECAUTIONS	3	Troubleshooting	32
Supplied Accessories	6	Specifications	34
Before Using the LCD TV Set	7	Calling for Service	35
Preparation	8	LIMITED WARRANTY	35
Installing Batteries in the Remote Control.....	8		
Using the Remote Control	8	Dimensional Drawings	
Antenna Connection.....	9	• The dimensional drawings for the LCD TV set are	
Power Connection	10	shown on the inside back cover.	
Part Names of the Main Unit	11		
Controls	11		
Terminals.....	12		
Part Names of the Remote Control	13		
Connecting with External Devices	14		
Outputting Audio	14		
SETUP	15		
Basic Operation	16		
Turning On and Off the Main Power.....	16		
Switching the Input Modes			
(INPUT1/INPUT2/INPUT3/INPUT4/INPUT5(PC)/TV).....	16		
Sound Volume.....	16		
Changing Channels	17		
Selecting Menu Items.....	18		
Menu setting screens.....	18		
Basic Adjustment Settings	19		
Picture	19		
Audio	21		
Channels	23		
Settings	24		
Locks	27		
Guide.....	30		

Supplied Accessories

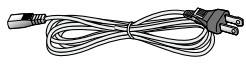
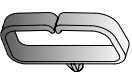
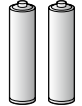
Make sure the following accessories are provided with the LCD TV set.

Remote control unit	AC cord	Cable clamp
		
"AA" size battery (x2)		Operation manual
		

Before Using the LCD TV Set

To use your LCD TV set, perform steps below.

1 Check the supplied accessories. (See P. 6)

2 Insert two “AA” size batteries into the remote control. (See P. 8)

- Open the battery cover, and then insert batteries with their terminals corresponding to the (+) and (-) indications in the battery compartment.

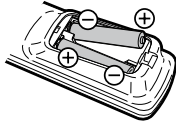

3 Connect the antenna cable. (See P. 9)



4 Connect with external devices. (See P. 14)

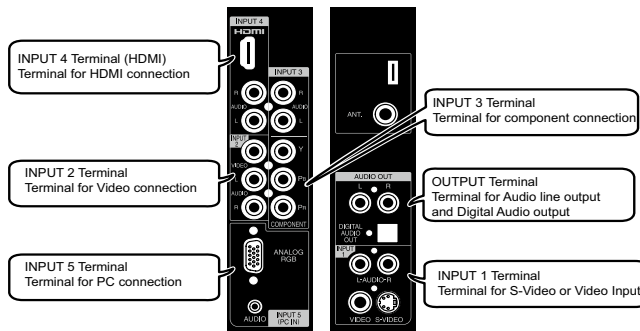

5 Connect the AC cord to the AC INPUT terminal of the LCD TV set and plug in the AC cord to the wall outlet. (See P. 10)

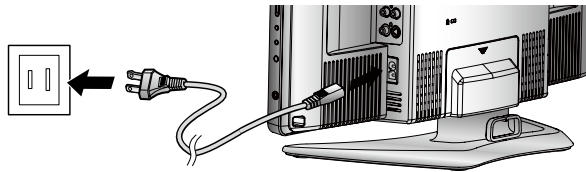

6 Turn on the main power. (See P. 16)

- ① Press **POWER** on the right hand side of the main unit.
- ② The POWER indicator located on the front of the main unit turns on to blue.

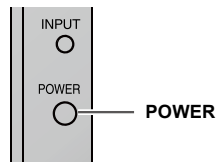

7 Start SETUP. (See P. 15)

Preparation

Installing Batteries in the Remote Control

Before using the LCD TV set for the first time, install the two supplied "AA" size batteries in the remote control. When the batteries become depleted or the remote control fails to operate, replace the batteries with new "AA" size batteries.

1 Open the battery cover.

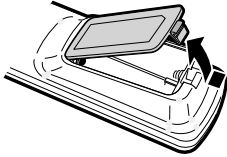

2 Insert two "AA" size batteries (supplied with the product).

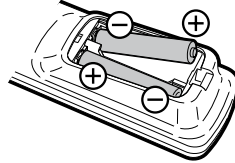

3 Close the battery cover.

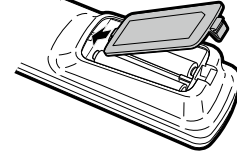

◆ Place the batteries with their terminals corresponding to the (+) and (-) indications in the battery compartment.

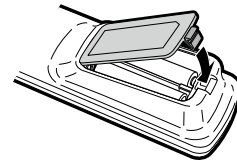

⚠ Caution!

Precautions regarding batteries

- ◆ Improper use of batteries can result in a leakage of chemicals and/or explosion. Be sure to follow the instructions below.
 - Place batteries with their terminals corresponding to the (+) and (-) indications.
 - Different types of batteries have different characteristics. Do not mix batteries of different types.
 - Do not mix old and new batteries. Mixing old and new batteries can shorten the life of new batteries and/or cause old batteries to leak chemicals.
 - Remove batteries as soon as they are depleted. Chemicals that leak from batteries can cause a rash. If chemical leakage is found, wipe it off with a cloth.
 - The batteries supplied with the LCD TV set may have a shorter operating time due to storage conditions.
 - If the remote control is not to be used for a long period of time, remove the batteries from the remote control.

Using the Remote Control

- ◆ Use the remote control by pointing it towards the remote sensor window of the main unit. Objects between the remote control and Remote sensor may prevent proper operation.

Cautions regarding use of the remote control

- ◆ Do not apply shock to the remote control. In addition, do not expose the remote control to liquids, and do not place it in an area with high humidity.
- ◆ Do not install or place the remote control in direct sunlight. The heat may cause deformation of the unit.
- ◆ The remote control may not work properly if the remote sensor window is in direct sunlight or strong lighting. In such a case, change the angle of the lighting or main unit, or operate the remote control closer to the remote sensor.

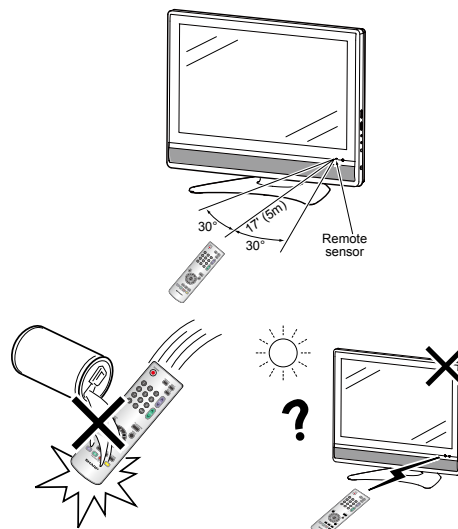

Antenna Connection

ANTENNAS

- The antenna requirements for good color television reception are more important than those for black & white television reception. For this reason, a good quality outdoor antenna is strongly recommended. The following is a brief explanation of the type of connections that are provided with the various antenna systems.

1. A 75-ohm system is generally a round cable with F-type connector that can easily be attached to a terminal without tools (not supplied).

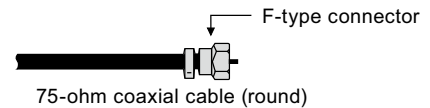

2. A 300-ohm system is a flat "twin-lead" cable that can be attached to a 75-ohm terminal through a 300/75-ohm adapter (not supplied).

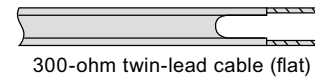

OUTDOOR ANTENNA CONNECTION

- Use one of the following two diagrams if you connect an outdoor antenna.
 - A: Using a VHF/UHF combination outdoor antenna
 - B: Using separate VHF and/or UHF outdoor antennas
- Connect the outdoor antenna cable lead-in to ANT. (Antenna terminal) on the rear of the main unit.

A. Combination VHF/UHF antenna

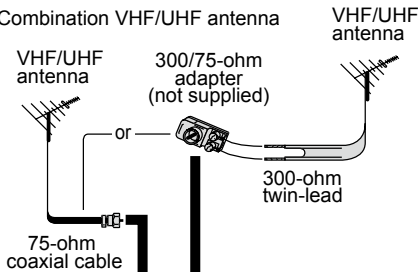

B. Separate VHF and/or UHF antennas

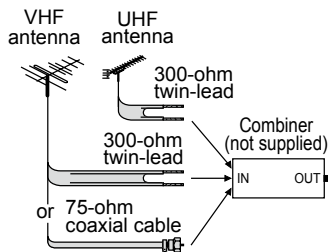

Antenna Cable (commercially available)

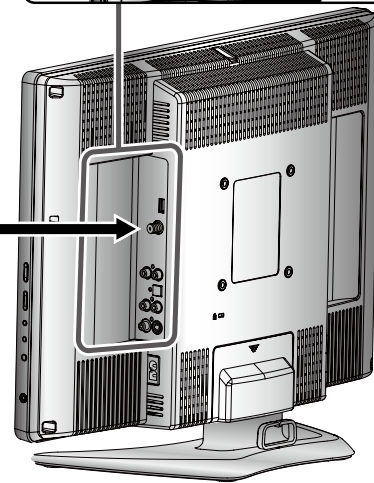

NOTICE

F-type connector

F-type connector should be finger-tightened only.

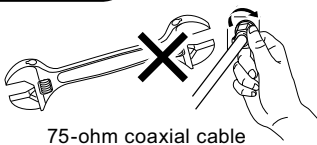

When connecting the RF cable to the LCD TV set, do not tighten F-type connector with tools. If tools are used, it may cause damage to your LCD TV set. (breaking of internal circuit, etc.)

Preparation (Continued)

Antenna Connection (Continued)

CABLE TV (CATV) CONNECTION

- A 75-ohm coaxial cable connector is built into the LCD TV set for easy hookup. When connecting the 75-ohm coaxial cable to the LCD TV set, screw the 75-ohm cable to the ANT. terminal.
- Some cable TV companies offer "premium pay channels". Since the signals of these premium pay channels are scrambled, a cable TV converter/descrambler is generally provided to the subscriber by the cable TV company. This converter/descrambler is necessary for normal viewing of the scrambled channels. (Set your TV to channel 3 or 4, typically one of these channels is used. If this is unknown, consult your cable TV company.) For more specific instructions on installing cable TV, consult your cable TV company. One possible method of utilizing the converter/descrambler provided by your cable TV company is explained below.
Please note: An RF switch (not supplied) with two inputs (A and B) is required.

"A" position on the RF switch (not supplied): You can view all unscrambled channels by using the TV's channel keys.

"B" position on the RF switch (not supplied): You can view the scrambled channels via the converter/descrambler by using the converter's channel keys.

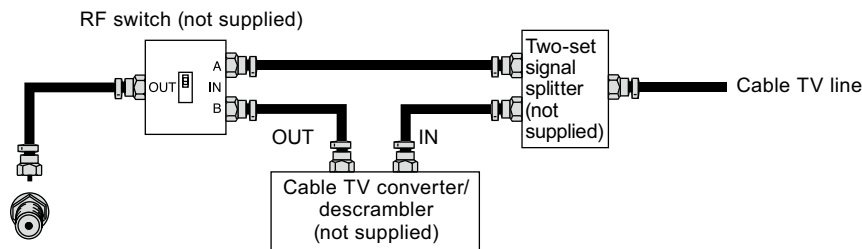

NOTE

- Consult your SHARP Dealer or Service Center for the type of splitter, RF switch or combiner that might be required.

Power Connection

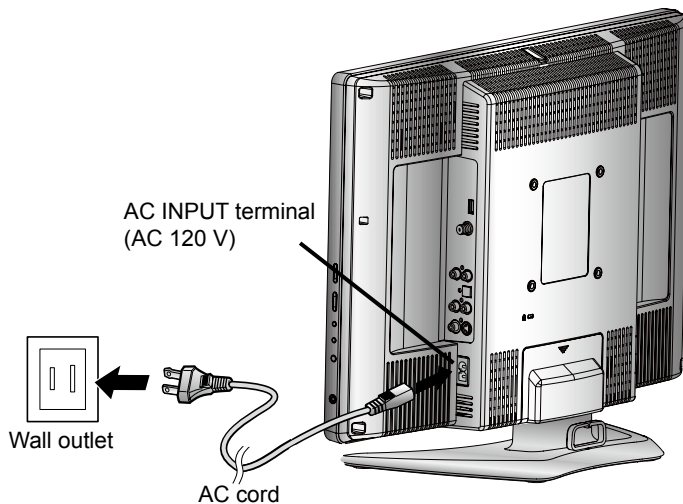

NOTE

- Unplug the AC cord from the LCD TV set and wall outlet when LCD TV set is not to be used for a long period of time.

Part Names of the Main Unit

Controls

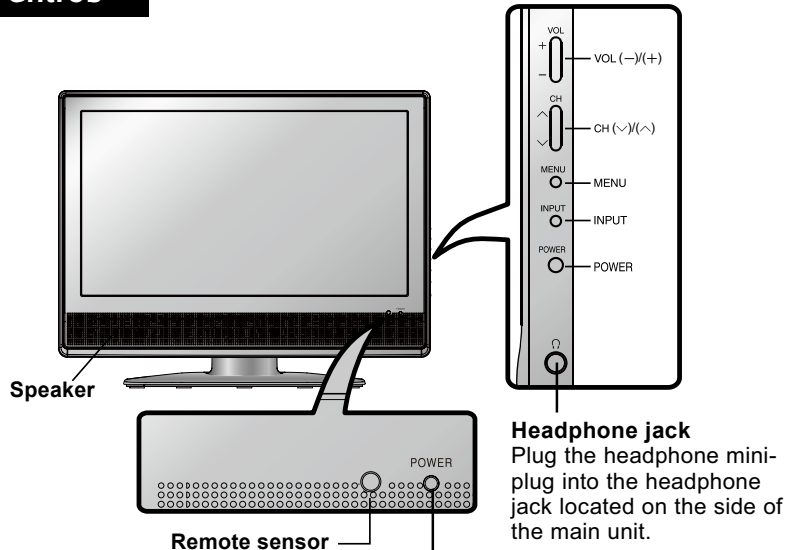

■ Tilt the angle

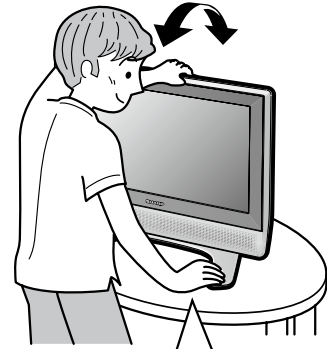

Tit the angle onto the range that is comfortable for watching.

To change the vertical angle of the LCD TV set, tilt the screen up to 2.5 degrees forward or 10 degrees backward. Please adjust the angle so that the LCD TV set can be watched most comfortably.

POWER Indicator	
Power ON	Lighting (Blue)
Power OFF / Standby	Light Off
No Signal Power OFF (Except TV mode)	Lighting (Amber)

NOTE

- INPUT, CH (V/^), VOL (+/-) and MENU on the main unit have the same functions as the same buttons on the remote control. Fundamentally, this operation manual provides a description based on operation using the remote control.

Listening with Headphones

- ◆ Plug the headphone mini-plug into the headphone jack located on the front of the main unit.

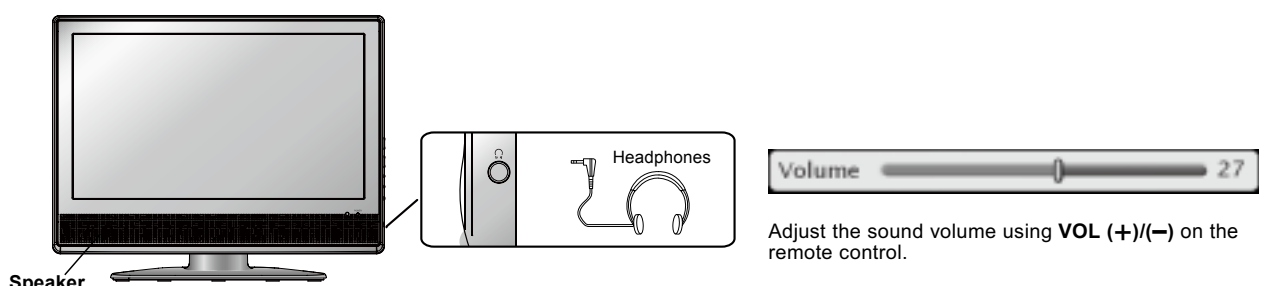

NOTE

- Headphones are not included in the supplied accessories.
- No sound is heard from the main unit speakers when a headphone mini-plug is connected to the headphone jack.
- Do not set the volume at a high level. Hearing experts advise against extended listening at high volume levels.

Terminology

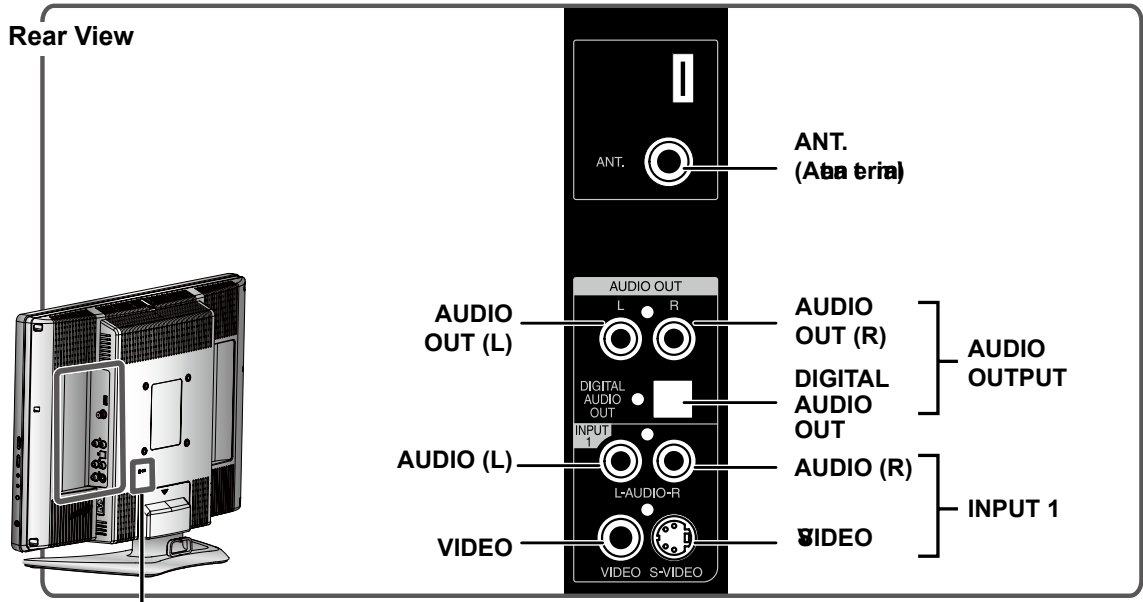

Robo Key Slot

This LCD TV set has a Kensington Security Standard slot for use with a Kensington MicroSaver Security System. Refer to the information that came with the system for instructions on how to use it to secure the LCD TV set.

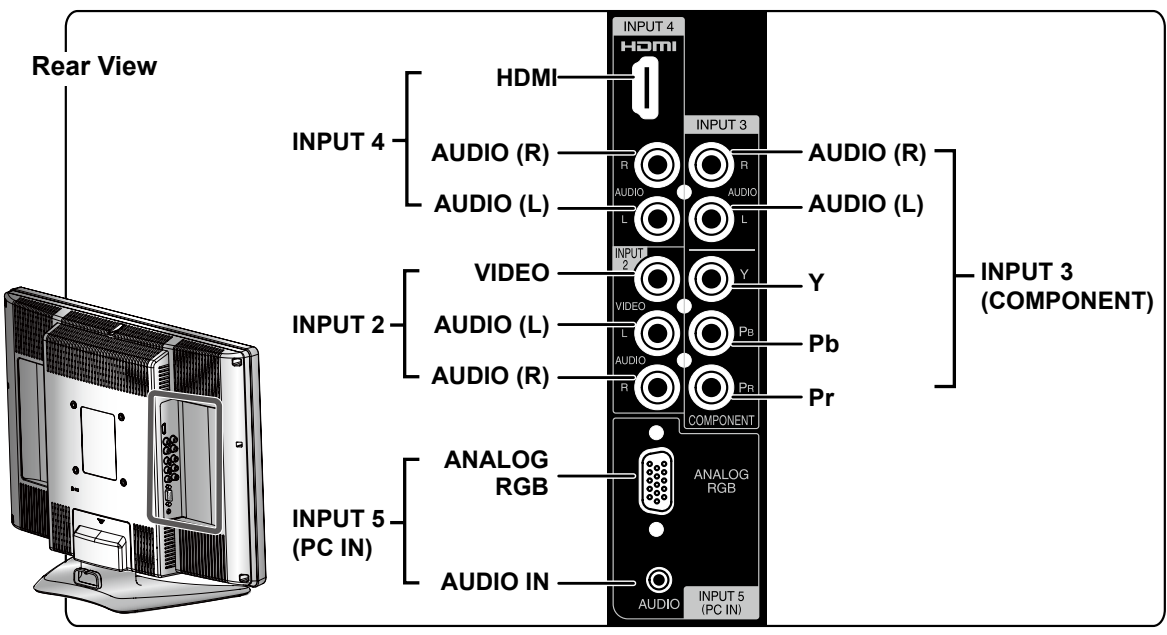

Part Names of the Remote Control

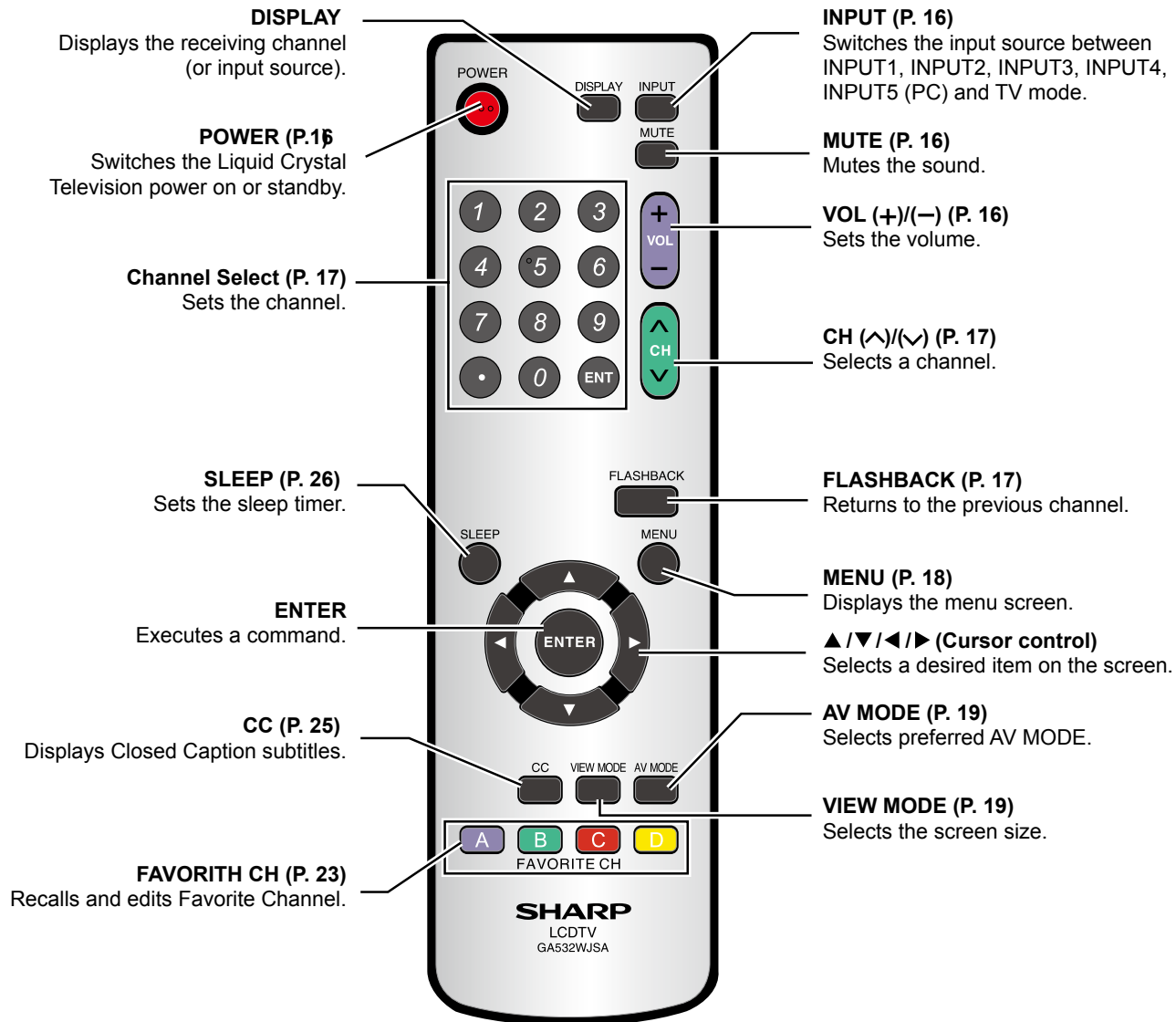

Connecting with External Devices

You can enjoy picture and sound by connecting a VCR or a home video game system to the terminals located on the rear of the LCD TV set.

When connecting an external device, turn off the power of the LCD TV set first to prevent any possible damage.

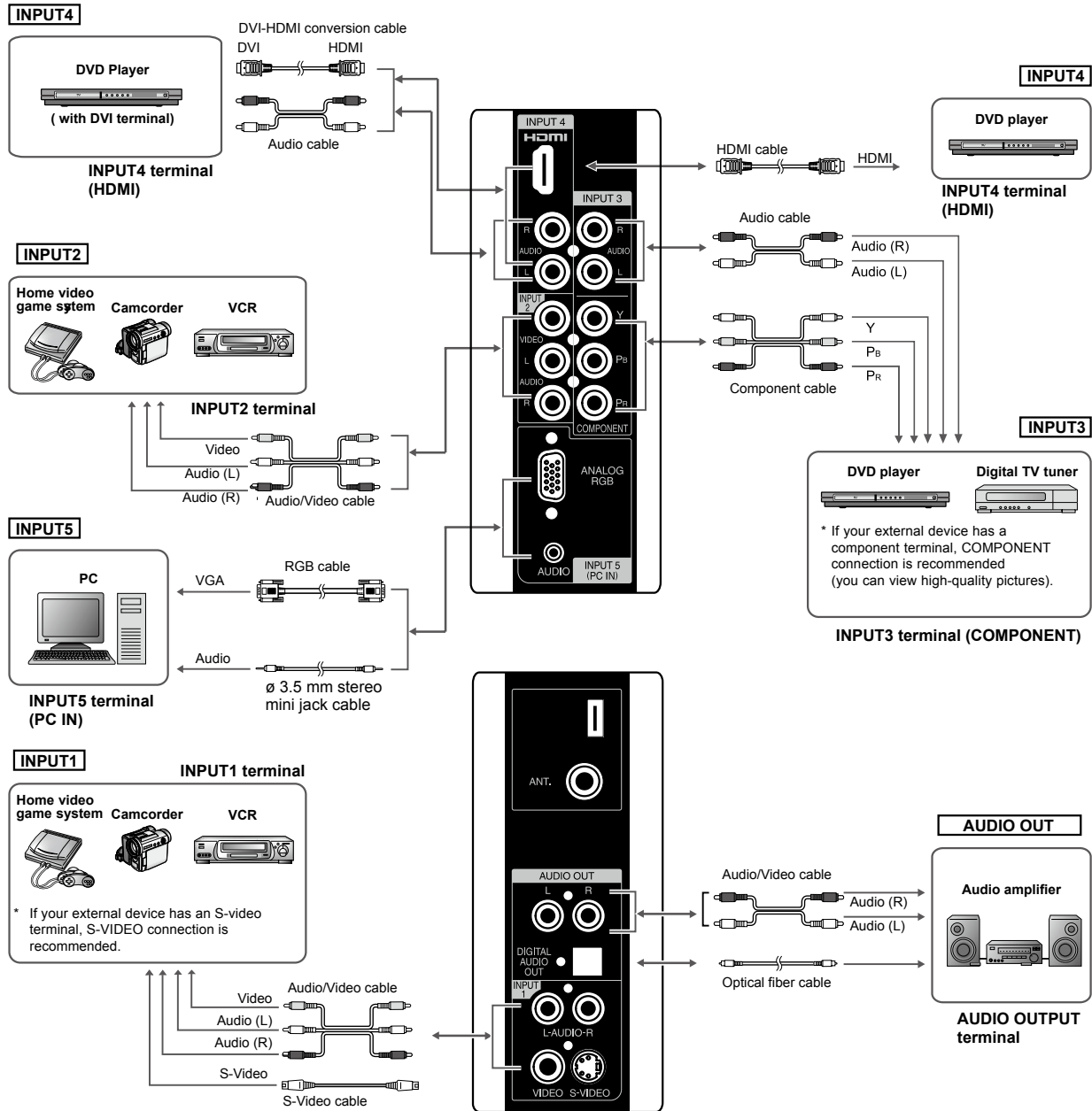

NOTE

- For the cable, use a commercially available audio/video cable.
- For more information about external device connections, see the operation manuals of your external devices.
- Make sure that the corresponding cables are connected to each terminal. Connecting other cables may result in a malfunction.
- INPUT1 has two video input terminals, VIDEO and S-VIDEO terminals. If your external device has an S-VIDEO terminal, S-VIDEO connection is recommended. S-Video provides a finer, more detailed picture. If both terminals are connected, S-VIDEO terminal takes a priority.
- For the INPUT3 mode, picture can be displayed only when 480I, 480P, 720P or 1080I signal is received.
- For the INPUT4 mode, picture can be displayed only when 640×480, 480P, 720P or 1080I signal is received.
- When you connect to the HDMI terminal with the DVI-HDMI conversion cable, it may not be possible to display the picture correctly.
- This TV does not support DTS audio format. You may not hear proper audio output from TV speakers if choosing DTS audio format.

Outputting Audio

You can output audio signals from the LCD TV set through the ANALOG AUDIO OUT terminals and the DIGITAL AUDIO OUT terminal.

SETUP

Initial Setup

When you turn on the LCD TV set for the first time, it will automatically memorize the broadcasting channels and clock.

Please perform the following instructions before you press **POWER**.

- (1) Insert the batteries into the remote control. (See page 8.)
- (2) Connect the antenna cable to the LCD TV set. (See page 9.)
- (3) Connect the AC cord to the AC INPUT terminal of the LCD TV set and plug in the AC cord to the wall outlet. (See page 10.)

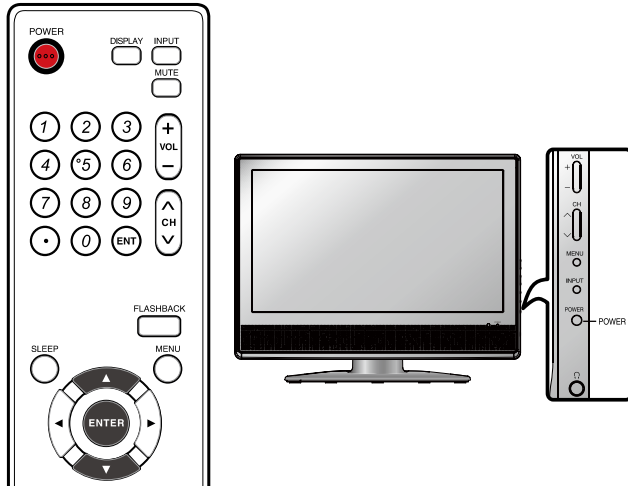

- 1 Press **POWER** on the right side of the main unit to turn on the TV. The SELECT LANGUAGE screen will be displayed. Press ▲/▼ to select “English”, “Français” (French) or “Español” (Spanish).

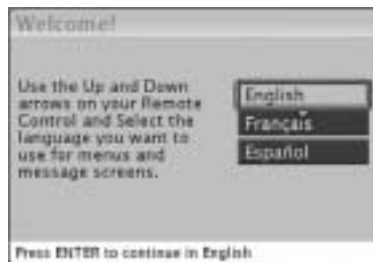

- 2 Press **ENTER** to access Time Zone mode. Press ▲/▼ to select on your time zone.



- 3 Press **ENTER** to access Daylight Saving screen. Press ▲/▼ to select “Yes” or “No”, when you observe daylight saving.

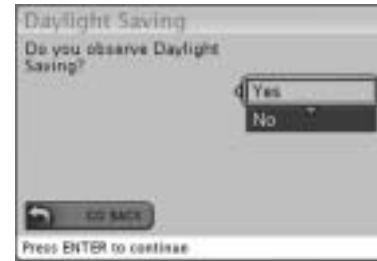

- 4 Press **ENTER** to access RF Input Source screen. Press ▲/▼ to select the source for your TV signal.

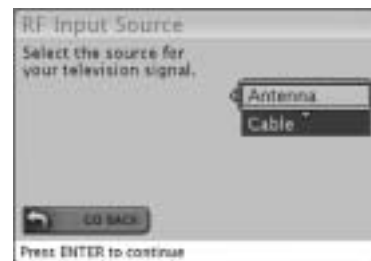

NOTE

- Select STD(Standard) for majority of cable systems.

Basic Operation

Turning On and Off the Power

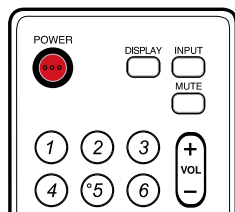
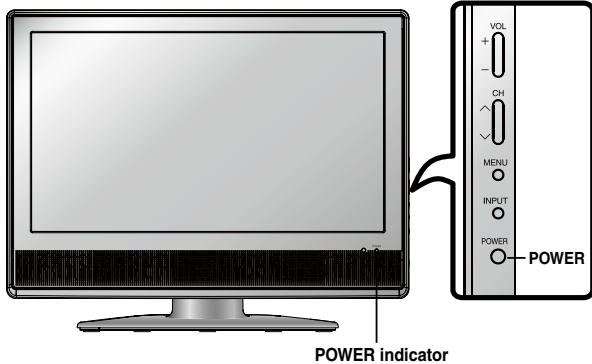

POWER indicator	
Power ON	Lighting (Blue)
Power OFF / Standby	Light Off
No Signal Power OFF (Except TV mode)	Lighting (Amber)

◆ Turning On the Power

Press **POWER** on the TV or **POWER** on the remote control.

- **POWER indicator (Blue):** The TV is on. ("Please wait.." Please wait will appear for a few seconds on the screen.)

◆ Turning Off the Power

Press **POWER** on the TV or **POWER** on the remote control.

- The TV enters standby mode and the image on the screen disappears.
- The **POWER indicator** on the TV turns off.

NOTE

- If you are not going to use this TV for a long time, be sure to remove the AC cord from the wall outlet.
- Small amount of electric power is still consumed even when the power is turned off.

Switching the Input Modes (INPUT1/ INPUT2/INPUT3/INPUT4/INPUT5(PC)/TV)

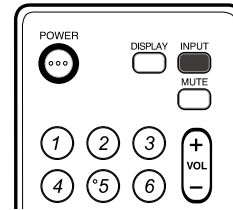

1 Turn on the power of the connected video equipment.

2 Press **INPUT** to select the applicable input source. The screen changes in order of INPUT1, INPUT2, INPUT3, INPUT4, INPUT5 (PC) and TV each time **INPUT** is pressed.

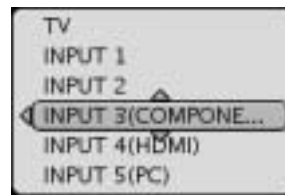

Sound Volume

◆ To adjust the volume

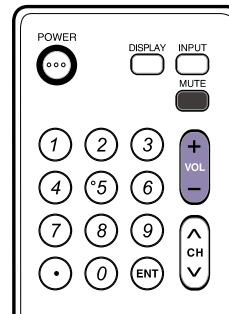

- Press **VOL (+)** to increase the sound volume. The bar indicator shifts right.



- Press **VOL (-)** to decrease the sound volume. The bar indicator shifts left.



◆ To mute the sound

- Press **MUTE** to temporarily turn off the sound.



- Press **MUTE** or **VOL (+)/(-)** to turn the sound back to the previous level.

The mute function is automatically turned off when any of the following buttons are pressed: **POWER**, **MUTE**, **VOL(+)/(-)**.



Changing Channels

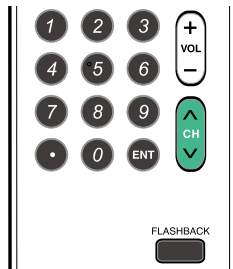

You can select channels using **Channel Select** (0-9, • (DOT), ENT) or **CH** (▲)/(▼).

• This LCD TV set allows you to select up to 125 channels (1 to 125). To select a channel, enter a 2- or 3-digit number.

◆ Using Channel Select (0-9, • (DOT), ENT)

When selecting the channel using **Channel Select**, complete input of the channel number by holding down the button for the last digit for a moment.

To select a 1- or 2-digit channel number (e.g., Channel 5):
Complete the following procedure within 4 seconds.

1 Press the **0** button.

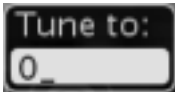

2 Press the **5** button.

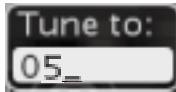

3 Press the **ENT** button.

To select a 3-digit channel number (e.g. Channel 115):
Complete the following procedure within 4 seconds.

1 Press the **1** button.

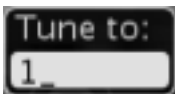

2 Press the **1** button.

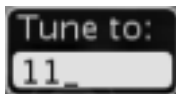

3 Press the **5** button.

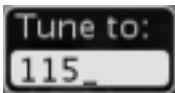

4 Press the **ENT** button.

To select a digit channel number (e.g. Channel 5.1):
Complete the following procedure within 4 seconds.

1 Press the **5** button.

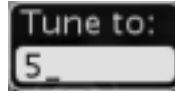

2 Press the **.** button.

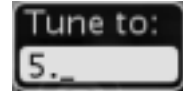

3 Press the **1** button.

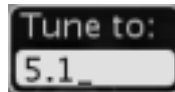

4 Press the **ENT** button.

◆ Using FLASHBACK

- ◆ Press **FLASHBACK** to switch the currently tuned channel to the previously tuned channel.
- ◆ Press **FLASHBACK** again to switch back to the currently tuned channel.

Basic Operation (Continued)

Selecting Menu Items

The menus can be used to adjust the various settings of the LCD TV set. Select the desired menu item by following the steps below.

NOTE

- The items displayed differ depending on the setting conditions.
- The item selected is displayed in blue.
- Last setting will be saved in memory.

Using the remote control

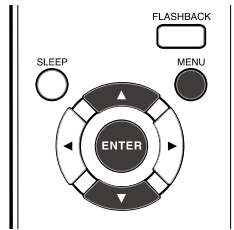

- 1 Press **MENU** on the remote control to display the Menu screen.
- 2 Press **▲/▼** to select the desired menu item.
- 3 Press **MENU** to select the menu item.
- 4 Press **ENTER** to exit.

Using the control panel of the main unit

You can also operate the menu with the control panel of the main unit. Button operations on the control panel correspond to the ones on the remote control as shown below.

Control panel of the main unit

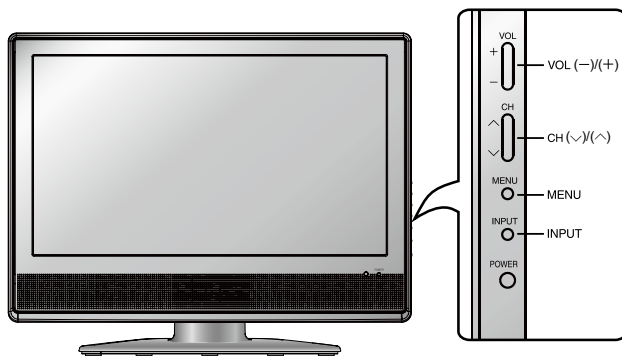

- VOL (-)/(+)**: Cursor **◀/▶** on the remote control
CH (v)/(^): Cursor **▼/▲** on the remote control
MENU: **MENU** on the remote control
INPUT: **ENTER** on the remote control

Menu Setting screens

For details of each menu item, refer to the page number indicated below.

NOTE

- The illustrations and on-screen displays in this manual are for explanation purposes and may vary slightly from the actual appearance.
- Depending on the setting condition, such as an input mode, it may not be possible to adjust or set some items.

Picture

	Page
Picture Settings	19
Aspect Ratio	19
Color Temp	20
Cinemotion	20
3D Comb Filter	20
Deinterlaced	20
Noise Reduction	20
ADC Settings	21
Reset Picture	21

Audio

	Page
Bass, Treble & Balance	21
Optical Out (SPDIF)	21
Analog Preference	22
Digital Preference	22
Audio Track	22
TV Speaker	22
Audio Out	22
Reset Audio	22

Channels

	Page
Master List	23
Favorites	23
Scan Channels	23
Find Channels	24
Channel Name Edit	24

Settings

	Page
Menu Language	24
Closed Captions	25
Sleep Time	26
Input Labels	26
Daylight Saving	26
System Info	26
Reset All	26

Locks

	Page
Rating Locks	27
Channel Locks	30
Change PIN	30
Reset Locks	30

Guide

	Page
Guide	30

Basic Adjustment Settings

Picture

You can adjust the picture to your preference with the following picture settings.

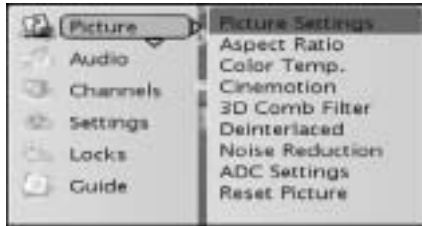

- 1 Press **MENU** on the remote control to display the menu screen.
- 2 Press **▲/▼** to select the "Picture" menu.
- 3 Press **ENTER** to enter the Picture menu list.
- 4 Press **▲/▼** to select the desired menu item.
- 5 Press **ENTER** to select the menu item.
- 6 Press **MENU** to exit after finish adjustment.

Picture Settings:

Press **▲/▼/◀/▶** to select or adjust your favorite picture settings, select Done button then press **ENTER** to close Picture Setting menu.



Preset (AV MODE):

- Select the Preset and press **ENTER**.
- Then, select the desired AV MODE.
- * You can also use **AV MODE** on your remote control for this function.

Selected item	Description
Standard	Changing image settings to standard values.
Dynamic	For a clear-cut image emphasizing high contrast for sports viewing.
Movie	Controlling the contrast to enable easier viewing of dark images.
Game	Controlling the brightness of video games and other images for easier viewing.
Custom	Allows the user to customize settings as desired. You can set the mode for each input source.

Selected item	◀ button	▶ button
Brightness	For less brightness	For more brightness
Contrast	For less contrast	For more contrast
Color	For less color intensity	For more color intensity
TINT	Skin tones become purplish	Skin tones become greenish
Sharpness	For less sharpness	For more sharpness
Backlight	The screen dims	The screen brightens

Aspect Ratio (VIEW MODE):

You can adjust the picture to your preferred display size.
* You can also use **VIEW MODE** on your remote control for this function.

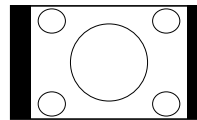
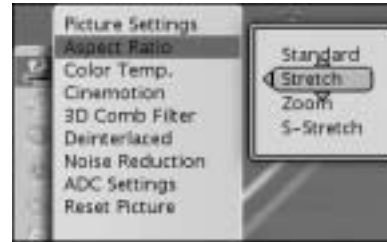

Standard:
Keep the original aspect ratio in a full screen display.

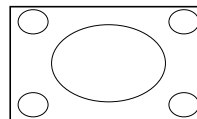

Stretch:
Suitable for viewing wide-screen 1.78:1 aspect ratio programs.
When viewing 1.85:1 programs, stretch mode will still show very thin black bands at the top and bottom of the screen.

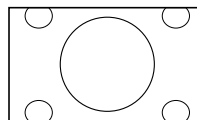

ZOOM:
Suitable for viewing wide-screen 2.35:1 aspect ratio programs in full screen.

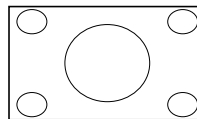

S-Stretch (Smart stretch):
Suitable for stretching 4:3 programs to fill the screen.

Aspect Ratio (VIEW MODE) for INPUT 5(PC):

You can select the picture display size for INPUT 5(PC).

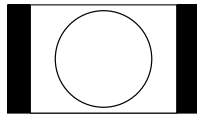

Standard:
Keep the original aspect ratio in a full screen display.

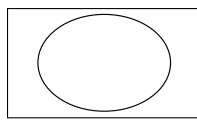

Stretch, Zoom, S-Stretch:
An image fully fills the screen.

NOTE

- Connect the PC before making adjustments. (See page 14.)

Basic Adjustment Settings (Continued)

Picture (continued)

Color Temp.:

Adjust Color Temp. of your TV (High, Middle, Low, User).

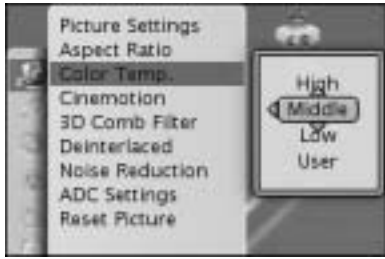

Selected item	Description
High	White with bluish tone
Middle	↑ ↓
Low	White with reddish tone
User	Adjust the color to your preference

* When you select "USER", the following items are adjustable.

Selected item	◀ button	▶ button
Red	Weaker red	Stronger red
Green	Weaker green	Stronger green
Blue	Weaker blue	Stronger blue

NOTE

- When resetting the items in the "USER" setting to factory preset values, perform the "Reset Picture" procedure.

Cinemotion:

Detect a film-based source (originally encoded at 24 frames/second) and then recreate each still film frame to cinematic picture quality (ON, OFF).

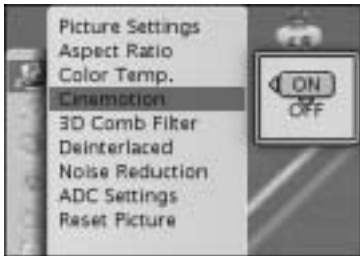

Selected item	Description
ON	Set Cinemotion to ON
OFF	Set Cinemotion to OFF

3D Comb Filter:

Separate the TV signal luminance and chrominance (Off, Low, Medium, High).

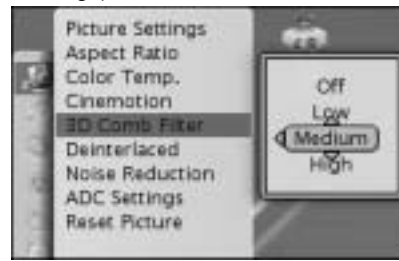

Selected item	Description
Off	Set 3D Comb Filter to Off
Low	Set 3D Comb Filter to Low level
Medium	Set 3D Comb Filter to Medium level
High	Set 3D Comb Filter to High level

Deinterlaced:

Select image display mode to Progressive or Interlace (ON, OFF)

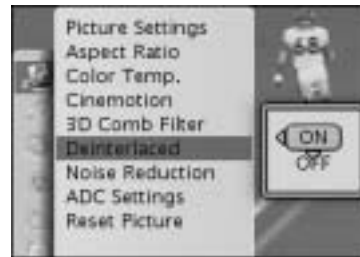

Selected item	Description
ON	Display image in Progressive mode
OFF	Display image in Interlace mode

Noise Reduction:

Reduce Noise from TV screen (Off, Low, Medium, High).

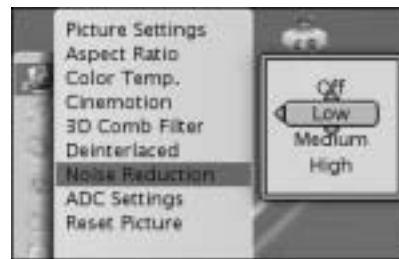

Selected item	Description
Off	Set Noise Reduction to OFF
Low	Set Noise Reduction to Low level
Medium	Set Noise Reduction to Medium level
High	Set Noise Reduction to High level

Basic Adjustment Settings (Continued)

ADC Settings:

Adjust ADC Settings of your TV (Horizontal, Vertical, Phase, Auto Sync).

NOTE

- Make sure to select the input signal from the following PC Compatibility Chart before connecting a PC.

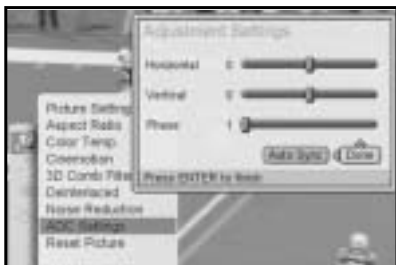

Selected item	◀ button	▶ button
Horizontal	Move the image Horizontal position to the left.	Move the image Horizontal position to the right.
Vertical	Move the image Vertical position down.	Move the image Vertical position up.
Phase	Adjust image clarity	

Selected item	Description
Auto Sync	Automatically adjust the settings for the current input signal

NOTE

- ADC Settings is only available when selecting INPUT 3(Component) or INPUT 5(PC).

PC Compatibility Chart

PC/MAC	Resolution	Horizontal Frequency (kHz)	Vertical Frequency (Hz)	
PC	VGA	720 × 400	31.5	70
		640 × 480	31.5	60
			37.9	72
			37.5	75
	SVGA	800 × 600	35.1	56
			37.9	60
			48.1	72
			46.9	75
	XGA	1,024 × 768	48.4	60
	WXGA	1,280 × 720	45.0	60
1360 × 768		47.368	60	
MAC 13"	VGA	640 × 480	34.9	67

NOTE

- The numerical values of resolutions and frequencies mentioned above are standard. They may differ from the values when actually displayed.

Reset Picture:

Reset picture settings to factory preset values.



Audio

You can adjust the audio to your preference with the following audio settings.

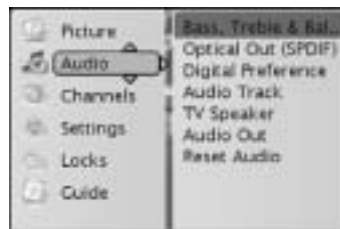

- 1 Press **MENU** on the remote control to display the menu screen.
- 2 Press **▲/▼** to select the "Audio" menu.
- 3 Press **ENTER** to enter the Audio menu list.
- 4 Press **▲/▼** to select the desired menu item.
- 5 Press **ENTER** to select the menu item.
- 6 Press **MENU** to exit after finish adjustment.

Bass, Treble & Balance

Use **▲/▼/◀/▶** to select or adjust your favorite bass, treble and balance settings.



Selected item	◀ button	▶ button
Bass	For weaker bass	For stronger bass
Treble	For weaker treble	For stronger treble
Balance	Decrease audio from the left speaker	Decrease audio from the right speaker

Optical Out (SPDIF)

Select the audio format for Optical Out (AC3, PCM).



Selected item	Description
AC3	Select surround audio format
PCM	Select stereo audio format

NOTE

- Optical Out (SPDIF) is only available when receiving digital broadcasting.

Basic Adjustment Settings (Continued)

Audio (countinued)

Analog Preference

Select the analog audio preference (Mono, Stereo, SAP).

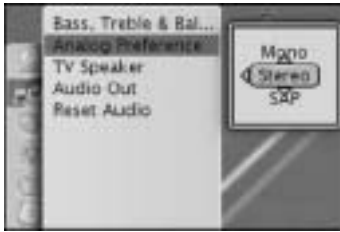

Selected item	Description
Mono	Set preferred audio format to Mono
Stereo	Set preferred audio format to Stereo
SAP	Set preferred audio format to Secondary Audio Program

NOTE

- Analog Preference is only available when receiving the analog broadcasting.

Digital Preference

Select the digital Broadcasting preferred language (English, French, Spanish).

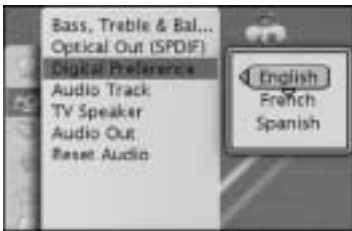

Selected item	Description
English	Set Digital Broadcasting preferred language to English
French	Set Digital Broadcasting preferred language to French
Spanish	Set Digital Broadcasting preferred language to Spanish

NOTE

- Digital Preference is only available when receiving the digital broadcasting.

Audio Track

Select the audio tracks available in digital broadcasting.

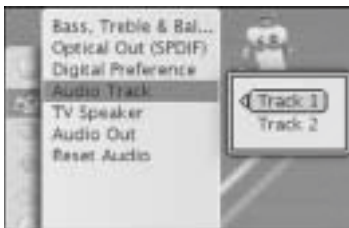

NOTE

- Audio Track is only available when receiving digital broadcasting.
- Selectable number of tracks in OSD screen is varied depending on the number of tracks available in the digital broadcasting received.

TV Speaker

Select the audio output speaker (Internal, External, Both).



Selected item	Description
Internal	Audio from internal speaker only
External	Audio from external speaker if your TV is connected to a home theater or stereo
Both	Audio from both internal and external speakers

Audio Out

Select the analog audio out value (Fix, Variable).



Selected item	Description
Fix	Analog audio output volume is fixed
Variable	Analog audio output volume is adjustable

Reset Audio:

Reset audio settings to factory preset values.

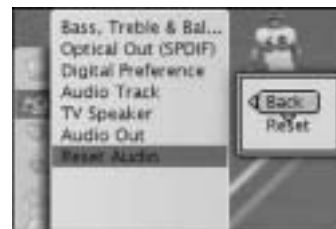

Channels

You can adjust the channel settings to your preference with the following items.

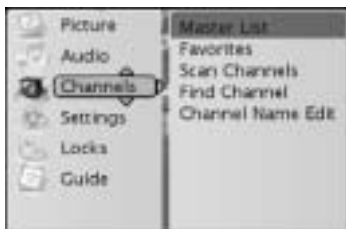

- 1 Press **MENU** on the remote control to display the menu screen.
- 2 Press **▲/▼** to select the "Channels" menu.
- 3 Press **ENTER** to enter the Channels menu list.
- 4 Press **▲/▼** to select the desired menu item.
- 5 Press **ENTER** to select the menu item.
- 6 Press **MENU** to exit after finish adjustment.

Master List

Displays the Master Channel List of all scanned channels, you can also edit the list.



Selected item	Description
Mark All	Select all channels from Master Channel List
Unmark All	Unselect all channels from Master Channel List
Analog Only	Select all analog channels from Master Channel List
Digital Only	Select all digital channels from Master Channel List

Favorites: (FAVORITE CH)

This function allows you to program channels in 4 different lists (FAV A~D). By setting the favorite channels in advance, you can select your favorite channels easily.

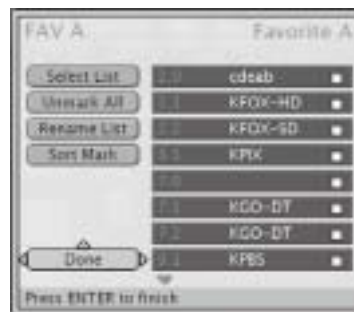

Selected item	Description
Select List	Select which favorite channel list you want to edit
Unmark All	Remove all channels from current favorite channel list
Rename List	Rename the favorite channel list
Sort Mark/Undo Sort	Sort or unsort marked channel in the list

<<Example:>> How to add channels to the list.

1. Select the Select List and Press **ENTER**.
 2. Press **▲/▼** to select the desired list (FAV A~D) and press **ENTER**.
 3. Press **▲/▼** to select channel and press **ENTER** to add channel to the favorite channel list.
- * You can also use **FAVORITE CH A~D** on your remote control to add or remove the current channel from the favorite channel list.

Scan Channels:

Automatically search and add the broadcasting channels to the Master Channel List.

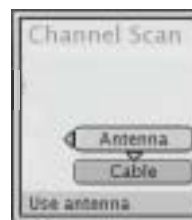

Selected item	Description
Antenna	Scan channels from Antenna Signal
Cable	Scan channels from Cable Signal (Automatic, STD, IRC, HRC)

<<Example:>> How to perform Scan Channels.

1. Select the Scan Channels and press **ENTER**.
2. Press **▲/▼** to select Antenna or Cable and press **ENTER**.
3. Select Scan and press **ENTER** to start Channel Scan.
4. All searched channels will be added to the Master Channel List.

NOTE

- Depends on the setting, you may be requested to enter PIN number to select Scan Channels.

Basic Adjustment Settings (Continued)

Channels (countinued)

Find Channel:

Manually search and add the broadcasting channels to the Master Channel List.



<<Example:>> How to perform Find Channel

1. Select the Find Channel and press **ENTER**.
2. Enter the channel number and then press **ENTER**.
3. If the channel is available, it will be added to the Master Channel List.

NOTE

- Depends on the setting, you may be requested to enter PIN number to select Find Channels.

Channel Name Edit:

This function allows you to edit channel name in channel list.



<<Example:>> How to perform Channel Name Edit.

1. Select the Channel Name Edit and Press **ENTER**.
2. Press **▲/▼** to select the desired channel and press **ENTER**.
3. Select "Done" and press **ENTER** after finish Channel Name Edit.

NOTE

- Channel Name is limited to 7 characters.

Settings

You can adjust the system settings to your preference with the following items.

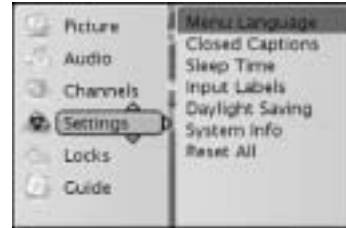

- 1 Press **MENU** on the remote control to display the menu screen.
- 2 Press **▲/▼** to select the "Settings" menu.
- 3 Press **ENTER** to enter the Settings menu list.
- 4 Press **▲/▼** to select the desired menu item.
- 5 Press **ENTER** to select the menu item.
- 6 Press **MENU** to exit after finish adjustment.

Menu Language

Select the language for menu (English, French, Spanish).



Selected item	Description
English	Set Menu Language to English
French	Set Menu Language to French
Spanish	Set Menu Language to Spanish

Settings (continued)

Closed Captions:

- This LCD TV set is equipped with an internal Closed Caption decoder. "Closed Caption" is a system which allows conversations, narration, and sound effects in TV programs and home videos to be viewed as captions on the TV screen (see the illustration).
- Not all programs and videos will offer closed captioning. Please look for the "CC" symbol to ensure that captions will be shown.
- The Closed Caption broadcasts can be viewed in two modes: CAPTION and TEXT. For each mode, four channels are available: CH1, CH2, CH3 and CH4. The CAPTION mode shows subtitles of dialogs and commentaries of TV dramas and news programs while allowing a clear view of the picture. The TEXT mode displays various information over the picture (such as TV program schedules and weather forecasts, etc.) that is independent of the TV programs.

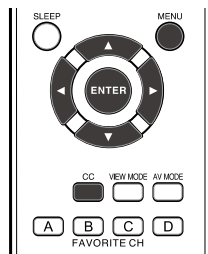

Selected item	Description
Activation	Activate Closed Caption
Caption Selection	Select type of Closed Caption
Advanced Appearance	Adjust Closed Caption appearance
Reset CC	Reset Closed Caption Settings

• Activation (CC)

Activate Closed Caption.

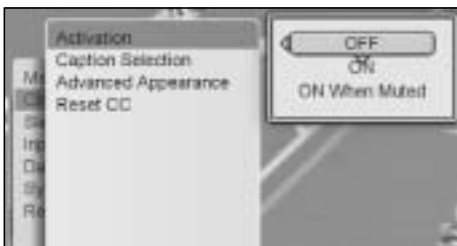

Selected item	Description
OFF	Set Closed Caption to OFF
ON	Set Closed Caption to ON
ON When Muted	Set Closed Caption to ON when Audio Volume is set to MUTE

* You can also use **CC** on your remote control for this function.

• Caption Selection

Select Type of Closed Caption (CC1, CC2, CC3, CC4, Text 1, Text 2, Text 3, Text 4, CS1, CS2, CS3, CS4, CS5, CS6).

* Analog Broadcasting

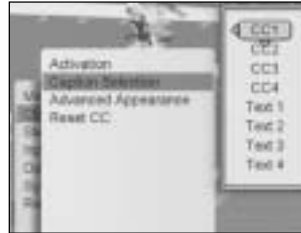

* Digital Broadcasting

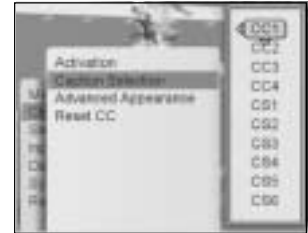

Selected item	Description
CC1	Closed Caption mode for CH1 data
CC2	Closed Caption mode for CH2 data
CC3	Closed Caption mode for CH3 data
CC4	Closed Caption mode for CH4 data
Text 1	Text mode for CH1 data
Text 2	Text mode for CH2 data
Text 3	Text mode for CH3 data
Text 4	Text mode for CH4 data
CS1	Caption Service mode for CH1 data
CS2	Caption Service mode for CH2 data
CS3	Caption Service mode for CH3 data
CS4	Caption Service mode for CH4 data
CS5	Caption Service mode for CH5 data
CS6	Caption Service mode for CH6 data

NOTE

- Text 1~4 are only available when receiving Analog Broadcasting.
- CS 1~6 are only available when receiving Digital Broadcasting.

• Advanced Appearance

Adjust Closed Caption appearance to your preference with the following settings.

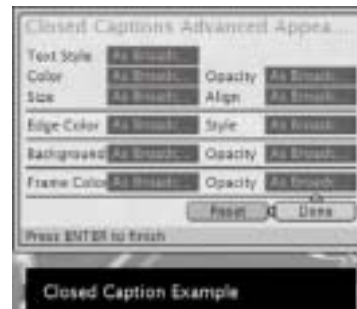

Basic Adjustment Settings (Continued)

Settings (continued)

- **Reset CC**
Reset Closed Caption settings to factory preset values.

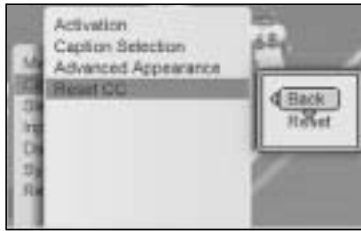

Sleep Time: (SLEEP)

This function allows you to set the sleep time to automatically turn off the TV (Leave TV on, 15 minutes, 30 minutes, 45 minutes, 60 minutes, 90 minutes).



Selected item	Description
Leave TV on	Set Sleep Time to off
15 minutes	Automatically turn off the TV after 15 minutes
30 minutes	Automatically turn off the TV after 30 minutes
45 minutes	Automatically turn off the TV after 45 minutes
60 minutes	Automatically turn off the TV after 60 minutes
90 minutes	Automatically turn off the TV after 90 minutes

* You can also use SLEEP on your remote control for this function.

Input Labels:

This function allows you to edit Input Labels.

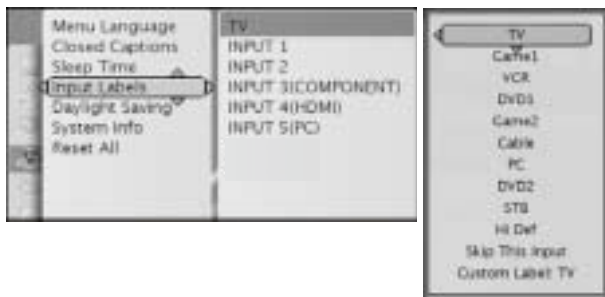

<<Example:>> How to edit Input Labels.

1. Select the Input Labels and press **ENTER**.
2. Press **▲/▼** to select the desired Input Label and press **ENTER**.
3. Press **▲/▼** to select the desired Input name and press **ENTER** to complete the edit.

NOTE

- Custom label is limited to 8 characters.

Daylight Saving:

The Daylight Saving-Time changes as shown below. Set the Daylight Saving to "Yes" to forward the clock by 1 hour. To rewind the clock by 1 hour, set the Daylight Saving to "No".



(Spring)

On the first Sunday in April Daylight Saving-Time starts.

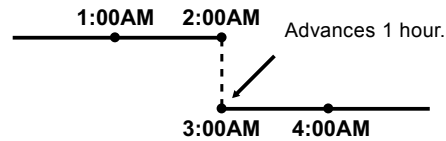

(Autumn)

On the last Sunday in October Daylight Saving-Time finishes.

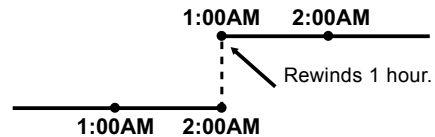

System Info:

Display the system information on the screen.



Reset All:

Reset all settings to factory preset values.



NOTE

- You must start SETUP (see page 15) after performing ResetAll.

Locks

You can adjust the Locks settings to your preference with the following items.

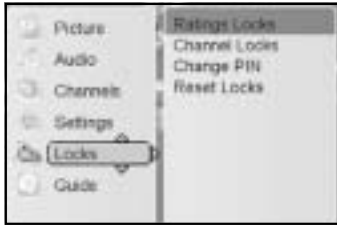

- 1 Press **MENU** on the remote control to display the locks menu screen.
- 2 Press **▲/▼** to select the "Locks" menu and press **ENTER**.
- 3 Enter 4-digit PIN number to enter "Locks" menu.
- 4 Press **▲/▼** to select the desired menu item.
- 5 Press **ENTER** to select the menu item.
- 6 Press **MENU** to exit after finish adjustment.

NOTE

- You must enter 4-digit PIN number to enter "Locks" menu.
- The factory preset value for PIN number is 0000.

Selected item	Description
Rating Locks	Set restriction of TV programs with Rating Locks
Channel Locks	Set restriction of TV programs with Channel Locks
Change PIN	Edit PIN number
Reset Locks	Reset Locks settings

Rating Locks (V-CHIP Settings)

- 1 Enter Locks menu.
- 2 Press **▲/▼** to select Ratings Locks.



- 3 Press **▲/▼** to select the desired item, and press **ENTER**.

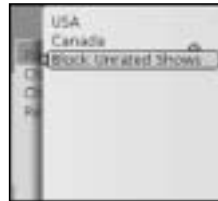
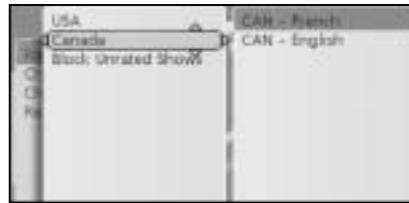
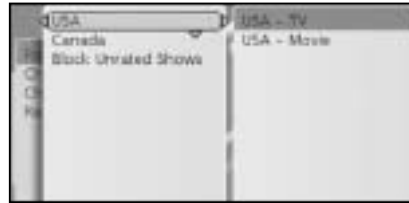

- 4 Press **▲/▼/◀/▶** to select the desired item, press **ENTER** to select Lock.



Canada - English

Canada - French



Block Unrated Shows

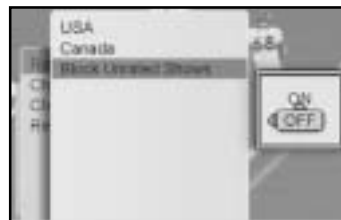

- 5 Press **MENU** to exit after finish adjustment.

Basic Adjustment Settings (Continued)

Rating Locks (V-CHIP Settings) (Continued)

- This function allows TV programs to be restricted and TV usage to be controlled based on FCC data. It prevents children from watching violent or sexual scenes that may be harmful.
- Restriction of TV programs includes two ratings that contain information about the program: the MPAA (Motion Picture Association of America) rating and the TV Parental Guidelines. The MPAA rating is restricted by age. TV Parental Guidelines are restricted by age and content.
- Since a TV program may use either the MPAA rating or the TV Guidelines, both should be adjusted for complete control.

USA TV (USA Parental Guide)

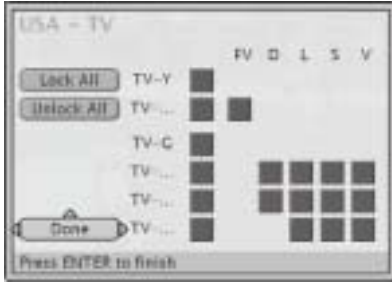

Rating	Lock	⇐ content-based ⇒					
		FV (Fantasy Violence)	D (Sexually Suggestive Dialog)	L (Adult Language)	S (Sexual Situation)	V (Violence)	
↑↑ age- based ↓↓	TV-Y (All children)	<input type="checkbox"/>	X	X	X	X	X
	TV-Y7 (Direct to Older Children)	<input type="checkbox"/>	<input checked="" type="checkbox"/>	X	X	X	X
	TV-G (General Audience)	<input type="checkbox"/>	X	X	X	X	X
	TV-PG (Parental Guidance Suggested)	<input type="checkbox"/>	X	<input checked="" type="checkbox"/>	<input checked="" type="checkbox"/>	<input checked="" type="checkbox"/>	<input checked="" type="checkbox"/>
	TV-14 (Parents Strongly Cautioned)	<input type="checkbox"/>	X	<input checked="" type="checkbox"/>	<input checked="" type="checkbox"/>	<input checked="" type="checkbox"/>	<input checked="" type="checkbox"/>
	TV-MA (Mature Audience Only)	<input type="checkbox"/>	X	X	<input checked="" type="checkbox"/>	<input checked="" type="checkbox"/>	<input checked="" type="checkbox"/>

: Select to block rating or undesired content.

: The content will be blocked if Lock is selected. You can manually set content to be unblocked.

X: The content will be blocked if Lock is selected. You can not manually set content to be unblocked.

NOTE

- Age-based ratings can be modified by the content-based ratings, but only in the combinations indicated by red locks in the table above.
- Choosing a lower age-based rating blocks the higher age-based ratings regardless of content rating settings.
- If you set TV-Y or TV-Y7 to BLOCK, BLOCK CONTENT will display all items.

USA Movie (MPAA rating)



Rating	Description
↑↑ age- based ↓↓	G GENERAL AUDIENCES. All ages admitted.
	PG PARENTAL GUIDANCE SUGGESTED. Some material may not be suitable for children.
	PG-13 PARENTS STRONGLY CAUTIONED. Some material may be inappropriate for children under 13.
	R RESTRICTED. Under 17 requires accompanying parent or adult guardian.
	NC-17 NO ONE 17 AND UNDER ADMITTED.
	X X is an older rating that is unified with NC-17 but may be encoded in the data of older movies.

NOTE

- The MPAA rating is only age-based.

Basic Adjustment Settings (Continued)

Canadian Rating Systems

- The TV rating systems in Canada are based on the Canadian Radio-Television and Telecommunications Commission (CRTC) policy on violence in television programming.
- While violence is the most important content element to be rated, the structure developed takes into consideration other program content like language, nudity, sexuality and mature themes.
- When setting the V-CHIP on the Canadian system you can choose either the Canadian English ratings or the Canadian French ratings.

Canada-French (Canadian French ratings)



Rating		Description
↑ age-based ↓	G	General: All ages and children, contains minimal direct violence, but may be integrated into the plot in a humorous or unrealistic manner.
	8 ans +	General but inadvisable for young children: May be viewed by a wide public audience, but could contain scenes disturbing to children under 8 who cannot distinguish between imaginary and real situations. Recommended for viewing with parent.
	13 ans +	Over 13 years: Could contain scenes of frequent violent scenes and therefore recommended for viewing with parent.
	16 ans +	Over 16 years: Could contain frequent violent scenes and intense violence.
	18 ans +	Over 18 years: Only for adult viewing. Could contain frequent violent scenes and extreme violence.

Canada-English (Canadian English ratings)



Rating		Description
↑ age-based ↓	C	Children: Intended for younger children under the age of 8 years. Pays careful attention to themes that could threaten their sense of security and well-being.
	C8 +	Children over 8 years old: Contains no portrayal of violence as the preferred, acceptable, or only way to resolve conflict; nor encourage children to imitate dangerous acts which they may see on the screen.
	G	General: Considered acceptable for all age groups. Appropriate viewing for the entire family, contains very little violence, physical, verbal or emotional.
	PG	Parental Guidance: Intended for a general audience, but may not be suitable for younger children (under the age of 8) because it could contain controversial themes or issues.
	14 +	Over 14 Years: Could contain themes where violence is one of the dominant elements of the storyline, but it must be integral to the development of plot or character. Language usage could be profane and nudity present within the context of the theme.
	18 +	Adults: Intended for viewers 18 years and older and might contain depictions of violence, which while related to the development of plot, character or themes, are intended for adult viewing. Could contain graphic language and portrayals of sex and nudity.

Basic Adjustment Settings (Continued)

Locks (Continued)

Block Unrated Shows

This function allows you to set restriction to block unrated TV programs.



Selected item	Description
ON	Block all unrated TV programs
OFF	No TV program will be blocked

Channel Locks

- 1 Enter Locks menu.
- 2 Press ▲/▼ to select Channel Locks and press **ENTER**.
- 3 Press ▲/▼ to select the desired channel, and press **ENTER** to block the channel.



- 4 Press **MENU** to exit when finish.

Change PIN

Edit PIN to the desired 4-digit number.



NOTE

- The factory preset value for PIN number is 0000.

Reset Locks

Reset locks settings to factory preset values.



Guide

Display TV channel and TV program information on screen.

<<Example:>>

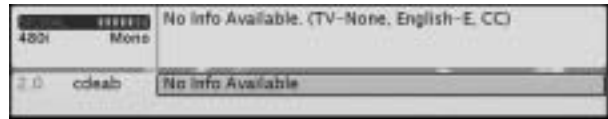

- 1 Press **MENU** on the remote control to display the menu screen.
- 2 Press ▲/▼ to select the "Guide" menu and press **ENTER**. TV Channel Information window will appear on screen.
- 3 Press **ENTER** again. TV Program Information window will appear on screen.
- 4 Press **ENTER** again. The information windows will disappear.

Connecting a PC

Viewing an Image from a PC

Use the INPUT 5 (PC) terminal to connect a PC.

NOTE

- The PC input terminals are DDC1/2B-compatible.
- Refer to P. 21 for a list of PC signals compatible with the System.
- Make sure to select the same signal values for the output signal of a PC and the input signal of the LCD TV set before connecting with the PC. (See P. 21)
- Depending on the PC being used, images may not be shown without converting the output signals into external output. Please refer to your PC's manuals regarding converting to external output.

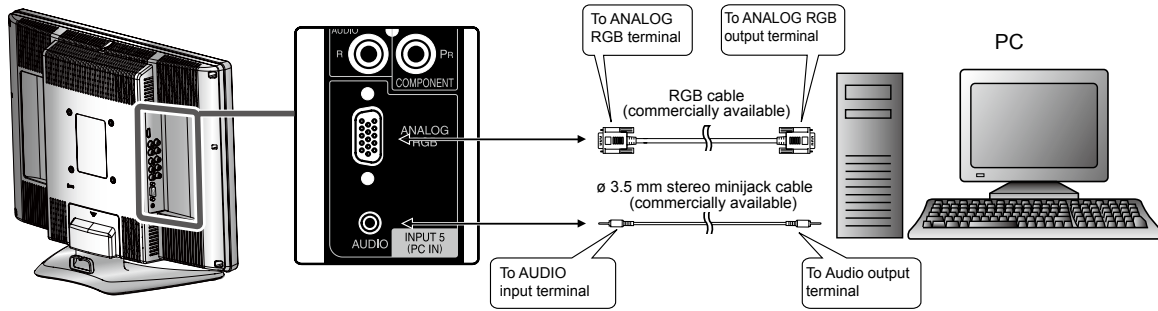

Connecting the RGB cable

- Connect the RGB cable making sure that it fits correctly into the terminal. Then, firmly secure the connectors by tightening the screws on both sides of the plug.

Signal names for 15-pin mini D-sub connector

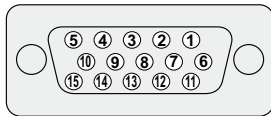

Pin	Signal	Pin	Signal	Pin	Signal
①	R	⑥	GND (Ground)	⑪	Not connected
②	G	⑦	GND (Ground)	⑫	SDA
③	B	⑧	GND (Ground)	⑬	HD
④	Not connected	⑨	+5V	⑭	VD
⑤	CSYNC	⑩	GND (Ground)	⑮	SCL

NOTE

- Pin No. 5 is not used for inputting the signal.
- Pin No. 9 is not connected with the supplied RGB cable.

Displaying an Image from a PC

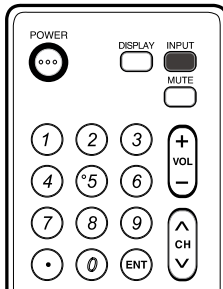





To view an image from a PC, perform the following procedure.

- ① Select the INPUT5 mode using **INPUT** on the remote control or the LCD TV set. (See P. 16)
- ② Select the PC input signal. (See P. 21)
- ③ Adjust the "Auto SYNC." items if the PC image does not come in clearly. (See P. 21)

Troubleshooting

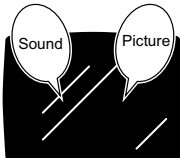
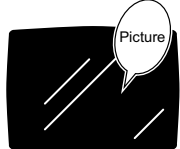
◆ Before calling for repair services, make the following checks for possible remedies to the encountered symptoms.

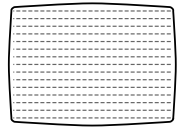
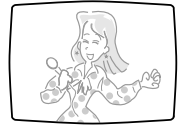
LCD TV set

Problem	Check item	Reference page
 <p>There is no picture or sound.</p>	<ul style="list-style-type: none"> • Make sure the AC cord is properly inserted in the power outlet. • Reception other than those of broadcasting stations can be considered. • Make sure the input mode is set to TV. • Make sure the POWER switch of the main unit is on. 	<p>10</p> <p>–</p> <p>16</p> <p>16</p>
 <p>There is no picture. There is no picture from INPUT1/2/3/4.</p>	<ul style="list-style-type: none"> • Make sure the Brightness is properly adjusted. • Fluorescent lamp may have reached the end of service life. 	<p>19</p> <p>34</p>
 <p>There is no sound.</p>	<ul style="list-style-type: none"> • Make sure the volume is not set to minimum. • Make sure the sound is not set to mute. • Make sure that headphones are not connected. 	<p>16</p> <p>16</p> <p>11</p>
 <p>There is no picture or sound, just noise.</p>	<ul style="list-style-type: none"> • Make sure the antenna cable is properly connected. • Bad reception could be the problem. 	<p>9, 10</p> <p>–</p>
 <p>Picture is not clear.</p>	<ul style="list-style-type: none"> • Make sure the antenna cable is properly connected. • Bad reception could be the problem. 	<p>9, 10</p> <p>–</p>
 <p>Picture is light or improperly tinted.</p>	<ul style="list-style-type: none"> • Check Color Settings. 	<p>19</p>
 <p>The picture is too dark.</p>	<ul style="list-style-type: none"> • Check Brightness, Contrast and Backlight Settings. • Fluorescent lamp may have reached the end of service life. 	<p>19</p> <p>34</p>
<p>Remote control does not work.</p>	<ul style="list-style-type: none"> • Check the batteries of the remote control. • Make sure the remote sensor window is not in strong lighting. 	<p>8</p> <p>8</p>
<p>Unit cannot be operated.</p>	<ul style="list-style-type: none"> • External influences such as lightning, static electricity, etc., may cause improper operation. In this case, operate the unit after first turning the power off, or unplugging the AC cord and re-plugging it in 1 or 2 minutes. 	<p>–</p>

Troubleshooting (Continued)

◆ Before calling for repair services, make the following checks for possible remedies to the encountered symptoms.

Antenna

Problem	Check item
The picture is not sharp.(NTSC) The picture moves.(NTSC) The picture have block noise. (ATSC) The audio sound is discontinuous.	<ul style="list-style-type: none"> • The reception may be weak. • The quality of the broadcast may also be bad. • Make sure the antenna is facing the right direction. • Make sure the outside antenna is connected.
The picture is doubled or tripled.	<ul style="list-style-type: none"> • Make sure the antenna is facing the right direction. • There may be reflected electric waves from mountains or buildings.
The picture is spotted.	<ul style="list-style-type: none"> • There may be interference from automobiles, trains, high voltage lines, neon lights, etc. • There may be interference between the antenna cable and AC cord. Try positioning them further apart.
There are stripes on the screen or colors fade.	<ul style="list-style-type: none"> • Is the unit receiving interference from other devices? Transmission antennas of radio broadcasting stations, transmission antennas of amateur radios and cellular phones may also cause interference. • Use the unit as far apart as possible from devices that may cause possible interference.

PC

Problem	Check item	Reference page
There is no image.	• Make sure the RGB cable is properly connected.	31
	• Make sure the output signal of the PC and the input signal setting of the LCD TV set are matched.	31
	• Some software prohibit video playback on an external display when playing back a video with a notebook PC. This is not attributable to a problem with the LCD TV set.	–
There is no sound.	<ul style="list-style-type: none"> • Make sure the PC audio cable is properly connected. • Check if the mute function activates, or if the volume is set to minimum. 	31 16
The text is blurred.	• Adjust “Phase” using the Auto Sync menu.	21
The image is not displayed in the center of the screen.	• Adjust “Horizontal position” and “Vertical position” using the Auto Sync menu.	21

◆ Cautions regarding use in high and low temperature environments

- When the unit is used in a low temperature space (e.g. room, office), the picture may leave trails or appear slightly delayed. This is not a malfunction, and the unit will recover when the temperature returns to normal.
- Do not leave the unit in a hot or cold location. Also, do not leave the unit in a location exposed to direct sunlight or near a heater, as this may cause the cabinet to deform and the LCD panel to malfunction.
Storage temperature: –4°F to +140°F (–20°C to +60°C)

Specifications

Items	Model	LC-20SH21U
LCD panel		20" BLACK TFT LCD TN
Number of dots		3,147,264 dots WXGA
Video color systems		N358 only
TV function	TV Standard (CCIR)	NTSC-M, ATSC, clear-QAM
	TV Tuning System	PLL 181 ch.
	STEREO	MTS+SAP
	CATV	125 ch.
Y/C FILTER		3D adaptive comb FILTER
Lamp life (Fluorescent lamp)		50,000 hours*
Audio amplifier		2.5 W × 2
Speakers		2 ⁴ / ₆₄ × 2 ⁵ / ₆₄ in. (ø5 cm), 2 pcs.
Terminals	INPUT1	AUDIO-IN, VIDEO-IN, S-VIDEO-IN
	INPUT2	AUDIO-IN, VIDEO-IN
	INPUT3	AUDIO-IN, COMPONENT-IN
	INPUT4	HDMI-IN with HDCP (640 × 480, 480P, 720P, 1080I), AUDIO IN
	INPUT5	PC Connector: 15-pin mini D-sub PC AUDIO: Mini-jack for stereo (ø3.5 mm)
	ANALOG AUDIO OUT	AUDIO-OUT
	DIGITAL AUDIO OUT	OPTICAL AUDIO-OUT
	Antenna	F-Type
	Headphone	Mini-jack for stereo (ø3.5 mm)
OSD language		English/Spanish/French
Power supply		AC 120V, 60Hz
Power consumption		70 W (0.5 W standby): AC 120V
Weight	Display only	12.10 lbs./5.5 kg
	Display with stand	14.10 lbs./6.4 kg
Operating temperature		+32°F to +104°F (0°C to +40°C)

* Typical time for power output decrease of about one-half assuming continuous use in a room with normal lighting, normal brightness and temperature at 77°F/25°C

Dimensional Drawings

- The dimensional drawings are shown on the inside back cover.

◆ As a part of policy of continuous improvement, SHARP reserves the right to make design and specification changes for the LCD TV set improvement without prior notice. The performance specification figures indicated are nominal values of production units. There may be some deviations from these values in individual units.

Calling for Service

For location of the nearest Sharp Authorized Service, or to obtain product literature, accessories, supplies, or customer assistance, please call 1-800-BE-SHARP.

LIMITED WARRANTY

CONSUMER LIMITED WARRANTY

SHARP ELECTRONICS CORPORATION warrants to the first consumer purchaser that this Sharp brand product (the "Product"), when shipped in its original container, will be free from defective workmanship and materials, and agrees that it will, at its option, either repair the defect or replace the defective Product or part thereof with a new or remanufactured equivalent at no charge to the purchaser for parts or labor for the period(s) set forth below.

This warranty does not apply to any appearance items of the Product nor to the additional excluded item(s) set forth below nor to any Product the exterior of which has been damaged or defaced, which has been subjected to improper voltage or other misuse, abnormal service or handling, or which has been altered or modified in design or construction.

In order to enforce the rights under this limited warranty, the purchaser should follow the steps set forth below and provide proof of purchase to the servicer.

The limited warranty described herein is in addition to whatever implied warranties may be granted to purchasers by law. ALL IMPLIED WARRANTIES INCLUDING THE WARRANTIES OF MERCHANTABILITY AND FITNESS FOR USE ARE LIMITED TO THE PERIOD(S) FROM THE DATE OF PURCHASE SET FORTH BELOW. Some states do not allow limitations on how long an implied warranty lasts, so the above limitation may not apply to you.

Neither the sales personnel of the seller nor any other person is authorized to make any warranties other than those described herein, or to extend the duration of any warranties beyond the time period described herein on behalf of Sharp.

The warranties described herein shall be the sole and exclusive warranties granted by Sharp and shall be the sole and exclusive remedy available to the purchaser. Correction of defects, in the manner and for the period of time described herein, shall constitute complete fulfillment of all liabilities and responsibilities of Sharp to the purchaser with respect to the Product, and shall constitute full satisfaction of all claims, whether based on contract, negligence, strict liability or otherwise. In no event shall Sharp be liable, or in any way responsible, for any damages or defects in the Product which were caused by repairs or attempted repairs performed by anyone other than an authorized servicer. Nor shall Sharp be liable or in any way responsible for any incidental or consequential economic or property damage. Some states do not allow the exclusion of incidental or consequential damages, so the above exclusion may not apply to you.

THIS WARRANTY GIVES YOU SPECIFIC LEGAL RIGHTS. YOU MAY ALSO HAVE OTHER RIGHTS WHICH VARY FROM STATE TO STATE.

Model Specific Section

Your Product Model Number & Description:

LC-20SH21U LCD Color Television

(Be sure to have this information available when you need service for your Product.)

Warranty Period for this Product:

One (1) year parts and ninety (90) days labor from the date of purchase.

Additional Item(s) Excluded from Warranty Coverage (if any):

Non-rechargeable batteries.

Where to Obtain Service:

From a Sharp Authorized Servicer located in the United States. To find the location of the nearest Sharp Authorized Servicer, call Sharp toll free at 1-800-BE-SHARP.

What to do to Obtain Service:

Ship prepaid or carry in your Product to a Sharp Authorized Servicer. Be sure to have **Proof of Purchase** available. If you ship the Product, be sure it is insured and packaged securely.

TO OBTAIN PRODUCT INFORMATION, CALL 1-800-BE-SHARP OR VISIT www.sharppusa.com

SHARP®

SHARP ELECTRONICS CORPORATION

Sharp Plaza, Mahwah, New Jersey 07430-2135

SHARP CORPORATION

SHARP®

LIMITED WARRANTY

Consumer Electronics Products

Congratulations on your purchase!

Sharp Electronics of Canada Ltd. (hereinafter called "Sharp") gives the following express warranty to the first consumer purchaser for this Sharp brand product, when shipped in its original container and sold or distributed in Canada by Sharp or by an Authorized Sharp Dealer:

Sharp warrants that this product is free, under normal use and maintenance, from any defects in material and workmanship. If any such defects should be found in this product within the applicable warranty period, Sharp shall, at its option, repair or replace the product as specified herein.

This warranty shall not apply to:

- (a) Any defects caused or repairs required as a result of abusive operation, negligence, accident, improper installation or inappropriate use as outlined in the owner's manual.
- (b) Any Sharp product tampered with, modified, adjusted or repaired by any party other than Sharp, Sharp's Authorized Service Centres or Sharp's Authorized Servicing Dealers.
- (c) Damage caused or repairs required as a result of the use with items not specified or approved by Sharp, including but not limited to head cleaning tapes and chemical cleaning agents.
- (d) Any replacement of accessories, glassware, consumable or peripheral items required through normal use of the product including but not limited to earphones, remote controls, AC adapters, batteries, temperature probe, stylus, trays, filters, belts, ribbons, cables and paper.
- (e) Any cosmetic damage to the surface or exterior that has been defaced or caused by normal wear and tear.
- (f) Any damage caused by external or environmental conditions, including but not limited to transmission line/power line voltage or liquid spillage.
- (g) Any product received without appropriate model, serial number and CSA/cUL markings.
- (h) Any products used for rental or commercial purposes.
- (i) Any installation, setup and/or programming charges.

Should this Sharp product fail to operate during the warranty period, warranty service may be obtained upon delivery of the Sharp product together with proof of purchase and a copy of this LIMITED WARRANTY statement to an Authorized Sharp Service Centre or an Authorized Sharp Servicing Dealer. In home warranty service may be provided at Sharp's discretion on any Sharp television with the screen size of 27" or larger and on any Sharp Over-the-Range Microwave Oven.

This warranty constitutes the entire express warranty granted by Sharp and no other dealer, service centre or their agent or employee is authorized to extend, enlarge or transfer this warranty on behalf of Sharp. To the extent the law permits, Sharp disclaims any and all liability for direct or indirect damages or losses or for any incidental, special or consequential damages or loss of profits resulting from a defect in material or workmanship relating to the product, including damages for the loss of time or use of this Sharp product or the loss of information. The purchaser will be responsible for any removal, reinstallation, transportation and insurance costs incurred. Correction of defects, in the manner and period of time described herein, constitute complete fulfillment of all obligations and responsibilities of Sharp to the purchaser with respect to the product and shall constitute full satisfaction of all claims, whether based on contract, negligence, strict liability or otherwise.

WARRANTY PERIODS:

	Parts & Labour (exceptions noted)
Audio Products	1 year
Camcorder	1 year
DVD Products	1 year
Projector	1 year (lamp 90 days)
LCD & Plasma Display TV	1 year
Microwave Oven	1 year (magnetron component-4 additional years)
Television Products	1 year (picture tube component-1 additional year)
VCR Products	1 year
Vacuum Cleaner	1 year

To obtain the name and address of the nearest Authorized Sharp Service Centre or Dealer, please contact:
SHARP ELECTRONICS OF CANADA LTD. 335 Britannia Road East, Mississauga, Ontario L4Z 1W9

For more information on this Warranty, Sharp Extended Warranty Offers, Sharp Canada Products, Accessory Sales, Dealer or Service Locations, please call (905) 568-7140
Visit our Web site: www.sharp.ca

