

SHARP®

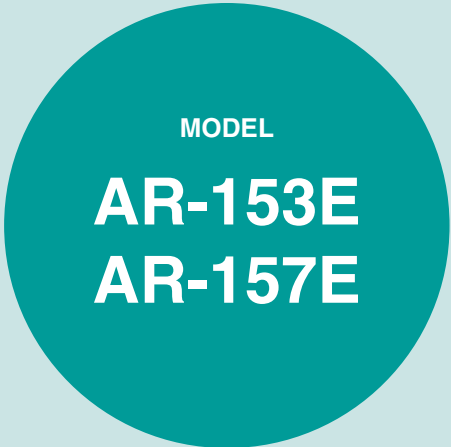

DIGITAL LASER COPIER/PRINTER

OPERATION MANUAL

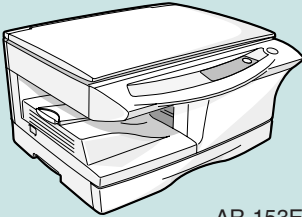

AR-153E

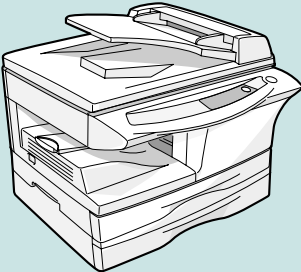

AR-157E

	Page
INTRODUCTION	4
LOADING PAPER	7
MAKING COPIES	12
SPECIAL FUNCTIONS	20
MAINTENANCE	25
TROUBLESHOOTING THE UNIT	30
OPTIONAL EQUIPMENT	38
INSTALLING THE SOFTWARE	40
APPENDIX	69

FOR YOUR RECORDS ...

To protect against loss theft, record and retain for reference the copier's serial number located on the back of the unit.

Model Number _____

Serial Number _____



Date of Purchase _____

Authorized Sharp Copier

Service Department Number _____

CAUTIONS

Caution label on the unit

The label ( ) in the fusing area of the unit indicates the following:

 : Caution, risk of danger

 : Caution, hot surface

Cautions on using

Follow the cautions below when using this unit.

Warning:

- The fusing area is hot. Exercise care in this area when removing misfed paper.
- Do not look directly at the light source. Doing so may damage your eyes.
- Do not switch the unit rapidly on and off. After turning the unit off, wait 10 to 15 seconds before turning it back on.
- Unit power must be turned off before installing any supplies.

Caution:

- Place the unit on a firm, level surface.
- Do not install the unit in a humid or dusty location.
- When the unit is not used for a long time, for example for consecutive holidays, turn the power switch off and remove the power cord from the outlet.
- When moving the unit, be sure to turn the power switch off and remove the power cord from the outlet.
- Do not cover the unit with a dust cover, cloth or plastic film while the power is on. Doing so may prevent heat radiation, damaging the unit.
- Use of controls or adjustments or performance of procedures other than those specified herein may result in hazardous radiation exposure.
- The socket-outlet shall be installed near the unit and shall be easily accessible.

Important points when selecting an installation site

Do not install your unit in areas that are:

- damp, humid, or very dusty
- exposed to direct sunlight
- poorly ventilated
- subject to extreme temperature or humidity changes, e.g., near an air conditioner or heater.

Be sure to connect the power cord only to a power outlet that meets the specified voltage and current requirements. Also make certain the outlet is properly grounded.



Note

Connect the unit to a power outlet which is not used for other electric appliances. If a lighting fixture is connected to the same outlet, the light may flicker.

Be sure to allow the required space around the machine for servicing and proper ventilation.

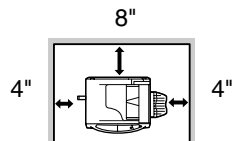

Cautions on handling

Be careful in handling the unit as follows to maintain the performance of this unit.

Do not drop the unit, subject it to shock or strike it against any object.

Store spare toner cartridges in a cool dry place without removing from the package before use.

- If they are exposed to direct sunlight or excessive heat, poor copies may result.

Do not touch the photoconductive drum (green portion).

- Scratches or smudges on the drum will cause dirty copies.

Proper storage for supplies

Store the supplies (paper and toner cartridges) in a location that is:

- clean and dry
- at a stable temperature
- not exposed to direct sunlight

Store paper in the wrapper and lying flat.

- Paper stored out of the wrapper or in packages standing on end may curl or get damp, resulting in paper misfeeds.

Trademark acknowledgements

- Microsoft and Windows are trademarks of Microsoft Corporation in the U.S.A. and other countries.
- IBM and PC/AT are trademarks of International Business Machines Corporation.
- Adobe and Acrobat are trademarks of Adobe Systems Incorporated.
- All other trademarks and copyrights are the property of their respective owners.



As an ENERGY STAR® Partner, SHARP has determined that this product meets the ENERGY STAR® guidelines for energy efficiency.

Safety precautions:

This Digital Copier is rated Class 1 and complies with 21 CFR 1040.10 and 1040.11 of the CDRH standards. This means that the unit does not produce hazardous laser radiation. For your safety, observe the precautions below.

- Do not remove the cabinet, operation panel or any other covers.
- The unit's exterior covers contain several safety interlock switches. Do not bypass any safety interlock by inserting wedges or other items into switch slots.

A small amount of ozone is produced within the unit during operation. The emission level is insufficient to cause any health hazard.

Note:

The present recommended long term exposure limit for ozone is 0.1ppm (0.2mg/m³) calculated as an 8hr. time-weighted average concentration. However, since the small amount that is emitted may have an objectionable odor, it is advisable to place the unit in a ventilated area.

CONTENTS

1

2

3

4

5

6

7

8

9

1 INTRODUCTION

USING THE MANUAL	4
PART NAMES	5
OPERATION PANEL	6

2 LOADING PAPER

PAPER	7
LOADING THE PAPER TRAY	8
BYPASS FEED (including special paper)	10

3 MAKING COPIES

COPY FLOW	12
POWER ON	13
ORIGINAL PLACEMENT	14
SET THE COPY QUANTITY	16
EXPOSURE ADJUSTMENT/ PHOTO COPYING	16
REDUCTION/ENLARGEMENT/ ZOOM	18
SELECTING THE TRAY	19

4 SPECIAL FUNCTIONS

ABOUT THE SPECIAL FUNCTIONS OF AR-157E	20
DESCRIPTION OF SPECIAL FUNCTIONS	22
TONER SAVE MODE	22
USER PROGRAMS	23
DISPLAYING TOTAL NUMBER OF COPIES	24

5 MAINTENANCE

TONER CARTRIDGE REPLACEMENT	25
CLEANING THE UNIT	28

6 TROUBLESHOOTING THE UNIT

TROUBLESHOOTING	30
STATUS INDICATORS	31
MISFEED REMOVAL	32
DEVELOPER REQUIRED	37
MAINTENANCE REQUIRED	37

7 OPTIONAL EQUIPMENT

SYSTEM CONFIGURATION	38
PRINTER/SCANNER EXPANSION KIT (AR-PG2)	38
SINGLE PASS FEEDER (AR-SP5)	38
250-SHEET PAPER FEED UNIT (AR-D16)	39

8 INSTALLING THE SOFTWARE

SOFTWARE FOR THE SHARP PERSONAL MFP SERIES	40
HARDWARE AND SOFTWARE REQUIREMENTS	41
BEFORE INSTALLATION	41
INSTALLING THE SOFTWARE	43
INDICATORS ON THE OPERATION PANEL	53
USING THE PRINTER MODE	54
USING THE SCANNER MODE	56
HOW TO USE THE ONLINE MANUAL	64
USING OTHER INSTALLED DRIVERS	66
CONNECTING THE INTERFACE CABLE	67

9 APPENDIX

SPECIFICATIONS	69
INDEX	72
SOFTWARE LICENSE	75

This chapter provides basic information for using the unit.

USING THE MANUAL

The operation manual contains explanations of how to operate the unit, important considerations, and maintenance procedures. To get the most out of the unit, please read the operation manual. Please keep the operation manuals in a suitable location that will allow for convenient future reference.

Conventions used in the manual

This operation manual explains the operation of the AR-153E and AR-157E models. In cases where the operation is the same, AR-157E is used. The differences between AR-153E and AR-157E are shown below.

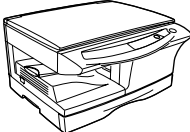
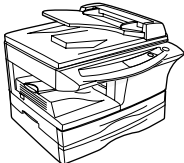
AR-153E	AR-157E
<div style="border: 1px solid black; padding: 2px; text-align: center;">Copier</div> <div style="border: 1px dashed black; padding: 2px; margin-top: 5px;">Printer *1 (AR-PG2)</div> <div style="border: 1px dashed black; padding: 2px; margin-top: 5px;">Scanner *1 (AR-PG2)</div> <div style="border: 1px dashed black; padding: 2px; margin-top: 5px;">SPF *2 (AR-SP5)</div> <div style="border: 1px dashed black; padding: 2px; margin-top: 5px;">250-sheet paper feed unit *3 (AR-D16)</div> 	<div style="border: 1px solid black; padding: 2px; text-align: center;">Copier</div> <div style="border: 1px solid black; padding: 2px; margin-top: 5px; text-align: center;">RSPF</div> <div style="border: 1px solid black; padding: 2px; margin-top: 5px; text-align: center;">2 trays</div> <div style="border: 1px dashed black; padding: 2px; margin-top: 5px;">Printer *1 (AR-PG2)</div> <div style="border: 1px dashed black; padding: 2px; margin-top: 5px;">Scanner *1 (AR-PG2)</div> 

 : Standard functions and equipment

 : Optional functions and equipment

*1 Can be used when the optional Printer/Scanner Expansion Kit (AR-PG2) is installed.

*2 The optional single pass feeder (AR-SP5) can be installed.

*3 The optional 250-sheet paper feed unit (AR-D16) can be installed.

- This operation manual refers to the Reverse Single Pass Feeder as the "RSPF" and Single Pass Feeder as the "SPF".
- In this manual, the following icons are used to provide the user with information pertinent to the use of the unit.



Warning

Warns the user that injury may result if the contents of the warning are not properly followed.



Caution

Cautions the user that damage to the unit or one of its components may result if the contents of the caution are not properly followed.



Note

Notes provide information relevant to the unit regarding specifications, functions, performance, operation and such, that may be useful to the user.



Indicates a letter displayed in the display.

PART NAMES

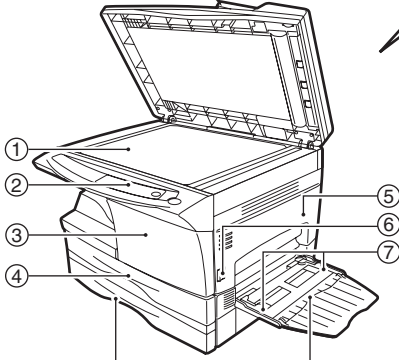
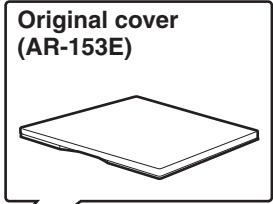
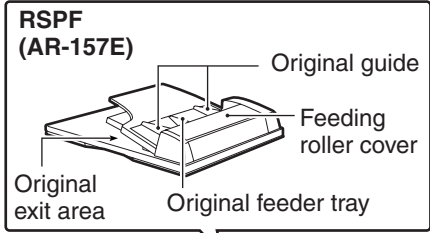

Paper tray 2

Multi-bypass tray

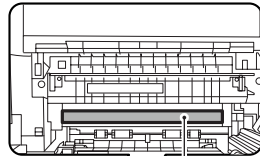
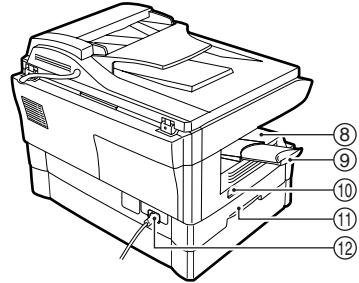

Photoconductive drum

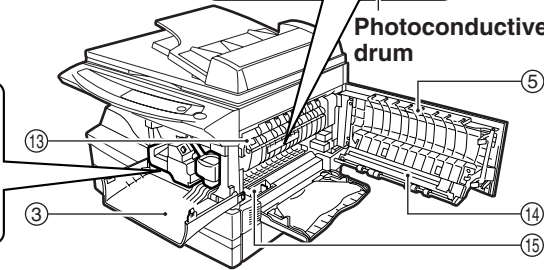
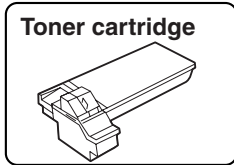

- ① Original table
- ② Operation panel
- ③ Front cover
- ④ Paper tray
- ⑤ Side cover
- ⑥ Side cover open button
- ⑦ Bypass paper guides
- ⑧ Paper output tray
- ⑨ Paper output tray extension

- ⑩ Power switch
- ⑪ Handle
- ⑫ Power cord
- ⑬ Fusing unit release lever
- ⑭ Transfer charger
- ⑮ Charger cleaner

OPERATION PANEL

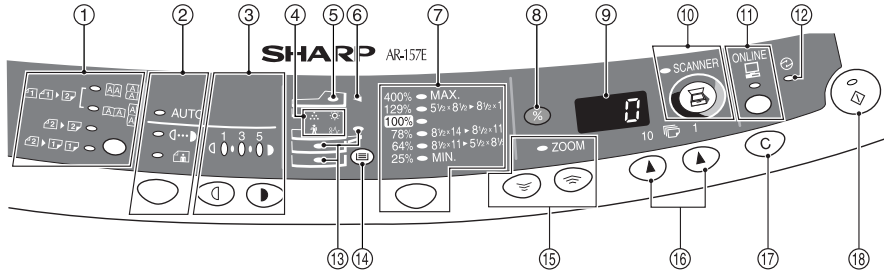

① Original to copy key and indicators (AR-157E)

- Two-sided copies from one-sided originals. Turn on Long Edge or Turn on Short Edge can be selected.
- Two-sided copies from two-sided originals. (Can be selected only when the RSPF is used.)
- Single-sided copies from two-sided originals. (Can be selected only when the RSPF is used.)

② Exposure mode selector key and indicators

Use to sequentially select the exposure modes: AUTO, MANUAL or PHOTO. Selected mode is shown by a lit indicator. (p.16)

③ Light and dark keys and indicators

Use to adjust the MANUAL or PHOTO exposure level. Selected exposure level is shown by a lit indicator. (p.16) Use to start and terminate user program setting. (p.23)

④ Alarm indicators

- ☼ Developer replacement required indicator (p.37)
- ⚡ Misfeed indicator (p.32)
- ⋯ Toner cartridge replacement required indicator (p.25)
- ✋ Maintenance indicator (p.37)

⑤ RSPF/SPF indicator (p.15)

Can be used only when your unit has the RSPF/SPF.

⑥ RSPF/SPF misfeed indicator (p.35)

Can be used only when your unit has the RSPF/SPF.

⑦ Copy ratio selector key and indicators

Use to sequentially select preset reduction/enlargement copy ratios. Selected copy ratio is shown by a lit indicator. (p.18)

⑧ Copy ratio display (%) key (p.18)

⑨ Display

Displays the specified copy quantity, zoom copy ratio, user program code, and error code.

⑩ SCANNER key and indicator (p.53, p.60)

Can be used when the Printer/Scanner Expansion Kit (AR-PG2) is installed.

⑪ ONLINE key and indicator (p.53)

Can be used when the Printer/Scanner Expansion Kit (AR-PG2) is installed.

⑫ Power save indicator

Lights up when the unit is in a power save mode. (p.22, p.23)

⑬ Paper feed location indicators

Light up to show the selected paper feed station.

⑭ Tray select key

Use to select a paper feed station (paper tray 1, paper tray 2 or multi-bypass tray) (p.19)

⑮ ZOOM keys and indicator

Use to select any reduction or enlargement copy ratio from 25% to 400% in 1% increments. (p.18)

⑯ Copy quantity keys

- Use to select the desired copy quantity (1 to 99). (p.16)
- Use to make user program entries. (p.23)

⑰ Clear key

- Press to clear the display, or press during a copy run to terminate copying. (p.16)
- Press and hold down during standby to display the total number of copies made to date. (p.24)

⑱ Start key and indicator

- Copying is possible when the indicator is on.
- Press to start copying.
- Use to set a user program. (p.23)

Follow the steps below to load paper into the tray.

PAPER

For best results, use only paper recommended by SHARP.

Type of paper feeding	Type of media		Size	Weight
Paper tray	Standard paper		Letter (8-1/2" x 11") Legal (8-1/2" x 14") Invoice (5-1/2" x 8-1/2")	15 lbs. to 21 lbs.
Multi-bypass tray	Standard paper and thick paper		Letter (8-1/2" x 11") Legal (8-1/2" x 14") Invoice (5-1/2" x 8-1/2")	14 lbs. to 34.5 lbs.**
	Special media	Transparency film	Letter (8-1/2" x 11")	
		Envelope*	Commercial 10 (4-1/8" x 9-1/2") Monarch (3-7/8" x 7-1/2")	

* Do not use non-standard envelopes, and envelopes that have metal clasps, plastic snappers, string closures, windows, linings, self-adhesive, patches or synthetic materials. Do not use envelopes that are filled with air or envelopes that have labels or stamps attached. These will cause physical damage to the unit.

** For paper weighing from 28 lbs. to 34.5lbs, 8-1/2" x 11" is the maximum size that can be fed through the multi-bypass tray.

- Special papers such as transparency film, labels and envelopes must be fed one sheet at a time through the multi-bypass tray.

LOADING THE PAPER TRAY

- 1** Raise the handle of the paper tray and pull the paper tray out until it stops.

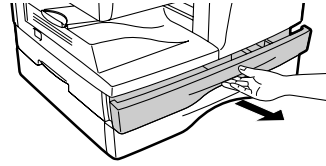

- 2** Adjust the paper guides on the paper tray to the copy paper width and length. Squeeze the lever of paper guide (A) and slide the guide to match with the width of the paper. Move paper guide (B) to the appropriate slot as marked on the tray.

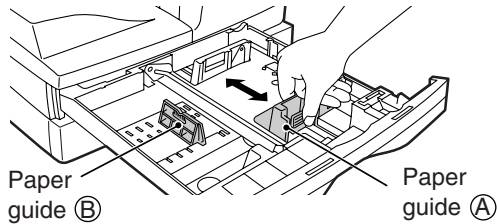

- 3** Fan the paper and insert it into the tray. Make sure the edges go under the corner hooks.



Note

Do not load paper above the maximum height line (). Exceeding the line will cause a paper misfeed.

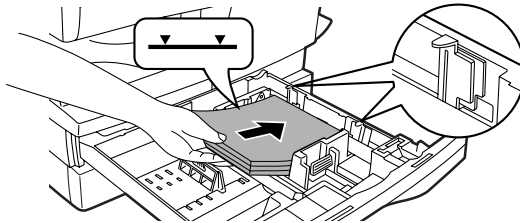



Note

- After loading paper, to cancel the blinking **P** without restarting copying, press the clear (C) key. The **P** in the display will go out and the start (S) indicator will light up.
- Be sure that paper is free of rips, dust, wrinkles, and curled or bent edges.
- Make sure all the paper in the stack is the same size and type.
- When loading paper, ensure there is no space between the paper and the guide, and check if the guide is not set too narrow causing the paper to bend. Loading paper in these ways will result in document skew or a paper jam.
- When not using the unit for an extended period, remove all paper from the paper tray and store it in a dry place. If paper is left in the unit for an extended period, the paper will absorb moisture from the air, resulting in paper jams.
- When adding new paper to the paper tray, remove the old paper already contained in the tray. Placing new paper on top of the paper already contained in the tray may result in feeding two sheets at one time.

BYPASS FEED (including special paper)

The multi-bypass tray can be used to feed standard paper, transparency film, labels, envelopes and other special purpose paper. Paper measuring from 3-1/2" x 5-1/2" to 8-1/2" x 14" and in the weight range of 14 lbs. to 34.5 lbs. can be used in this tray. (For paper weighing from 28 lbs. to 34.5 lbs., 8-1/2" x 11" is the maximum size.)



- The multi-bypass tray can hold maximum of 50 sheets of paper. (Capacity will vary depending on the type of paper loaded.)
- The original image must be smaller than the paper or media for copying. If the original image is bigger than the paper or media, this may cause smudges on the edges of the copies.

1 Open the multi-bypass tray and extend the tray.

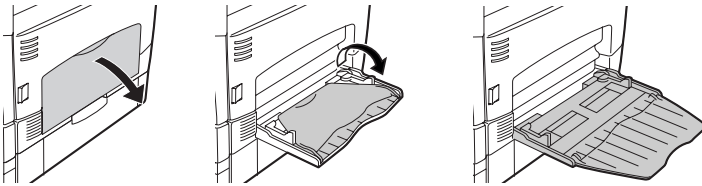

To close the multi-bypass tray, perform step 1 and then step 2 in the illustration and push the round projections at the right of the tray until they click.

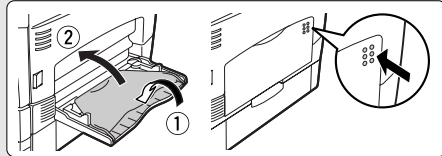

2 Set the paper guides to the paper width. Insert the paper (print face down) all the way into the multi-bypass tray.

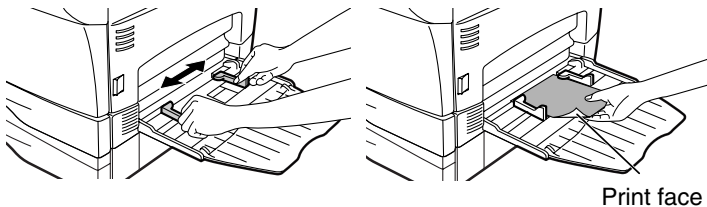



Note

- *Paper must be fed narrow side into the feed slot.*
- *Special papers such as transparency film and labels must be fed one sheet at a time through the multi-bypass tray.*
- *When copying onto transparency film, remove each copy promptly. Do not let copies stack up.*

3 Press the tray select (⊞) key to select the multi-bypass tray.

Note for loading envelopes

- Envelopes must be fed narrow side into the feed slot one at a time.
- Do not use non-standard envelopes, and envelopes that have metal clasps, plastic snappers, string closures, windows, linings, self-adhesive, patches or synthetic materials. Do not use envelopes that are filled with air or envelopes that have labels or stamps attached.
- Envelopes of which the surface is not flat because of embossing may cause the copies/prints to become smudged.
- Under high humidity and temperature conditions the glue flaps on some envelopes may become sticky and be sealed closed when copied/printed.
- Use only envelopes which are flat and crisply folded. Curled or poorly formed envelopes may be poorly copied/printed or may cause misfeeds.
- It is recommended that you perform a test copy before performing the actual copied/printed job.
- Be sure to select either Com 10, DL, C5 or Monarch on the paper size setting of the printer driver. (For detailed information on printer driver, refer to the online manual.)

3

MAKING COPIES

This chapter explains basic and other copying functions.

The unit is equipped with a one-page memory buffer. This memory allows the unit to scan an original once only and make up to 99 copies. This feature improves workflow, reduces operation noise from the copier, and provides higher reliability by reducing wear and tear on the scanning mechanism.



Note

If the unit does not function properly during use, or if a function cannot be used, see "TROUBLESHOOTING THE UNIT" (p.30).

COPY FLOW

- 1 Make sure that paper has been loaded in the paper tray (p.8) or multi-bypass tray (p.10), and check the paper size (p.7).**

If paper is not loaded, see page 8.

- 2 Turn on the unit (p.13).**

- 3 Place the original.**

If you are using the original table, see "Using the original table" (p.14).

If you are using the RSPF/SPF, see "Using the RSPF/SPF" (p.15).

When copying onto paper larger than 8-1/2" x 11" size, pull out the paper output tray extension.



- 4 Select the copy settings.**

If you wish to copy using the initial settings (p.13), proceed to the next step.

To set the number of copies, see page 16.

To adjust the resolution and contrast settings, see page 16.

To enlarge or reduce the copy, see page 18.

To change the tray, see page 19.

To print on both sides of paper, see page 20. (AR-157E)

- 5 Start copying.**

Press the start (⏻) key.



POWER ON

Turn the power switch on the left side of the unit to the "ON" position. The start (⏻) indicator will light up.

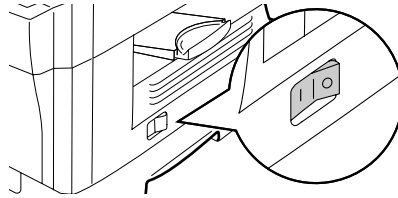

Note

- The unit will enter a power save mode once the set time has elapsed without any unit operation. The settings of the power save modes can be modified. See "USER PROGRAMS" (p.23).
- The unit will return to the initial settings a preset amount of time after the end of copy or scanner job. The preset amount of time (auto clear time) can be changed. See "USER PROGRAMS" (p.23).

3

About the scan head

The scan head lamp remains on constantly when the unit is in the ready condition (when the start (⏻) indicator is illuminated).

The unit adjusts the scan head lamp periodically to maintain copying quality. At this time, the scan head moves automatically. This is normal and does not indicate unit trouble.

Initial settings of operation panel

When the unit power is on, the operation panel will revert to the initial settings when the time set with the "Auto clear time" setting (p.22) elapses after a copy or scanner job is finished, or when the clear (Ⓢ) key is pressed twice.

The initial settings of the operation panel are shown below.

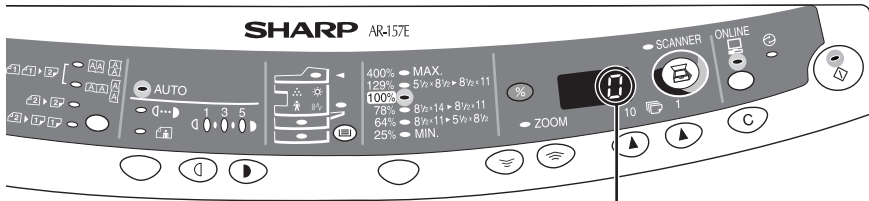

"0" is displayed in the display.

When copying is begun in this state, the settings in the following table are used.

Copy quantity	1 copy
Exposure adjustment	AUTO
Zoom	100%
Tray	Paper tray 1
Original to copy (AR-157E)	The "Original to copy" indicator does not illuminate. (One-sided copying only)

Power off methods

If not used for a certain period of time, the unit will automatically enter auto power shut-off mode (p.22) in order to minimize power consumption. In cases where the machine will not be used for a long time, turn off the power switch and remove the power cord from the outlet.

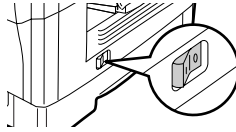

ORIGINAL PLACEMENT

Using the original table



Note

- The original table can read up to 8-1/2" x 14" original.
- Image loss 5/32" can occur at the leading and trailing edges of the copies. Also image loss 11/64" in total can occur along the other edges of the copies.
- When copying a book or an original which has been folded or a crumpled original, press down the original cover lightly. If the original cover is not securely closed, the copies may be striped or blurred.

1 Open the original cover/RSPF/SPF, and place the original.

2 Place an original face down on the original table. Align it with the original scale and the centering (▶) mark. Gently close the original cover/RSPF/SPF.

Original scale

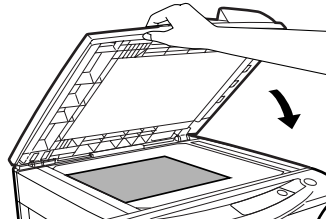
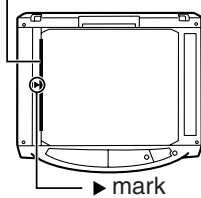

Setting a large original (AR-153E)

The original cover can be removed to allow copying of bulky objects.

1 Simply lift the original cover straight up.

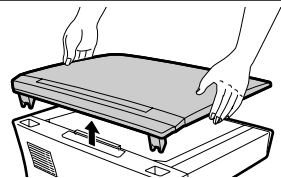

2 To reattach the original cover, reverse the above procedure.

Using the RSPF/SPF

The RSPF/SPF is designed to hold up to 30 originals measuring from 5-1/2" x 8-1/2" to 8-1/2" x 14" and weighting from 14 lbs. to 23.9 lbs.



Note

- Before feeding originals in the original feeder tray, be sure to remove any staples or paper clips from them.
- Before placing curled or wavy originals into the original feeder tray, be sure to flatten them. If not, original misfeeds may result.
- The RSPF/SPF (○) indicator on the operation panel will light up. If this indicator does not light up, the originals are not properly set or the RSPF/SPF is not properly closed.
- Badly damaged originals may misfeed in the RSPF/SPF. It is recommended that such originals be copied from the original table.
- Special originals such as transparency film should not be fed through the RSPF/SPF, but should be placed directly on the original table.
- Image loss (max. 5/32") can occur at the leading and trailing edges of the copies. Also image loss (max. 11/64" in total) can occur along the other edges of the copies. It can be 15/64" (max.) at the trailing edge of the second copy of two-sided copying.
- To stop continuous copying using the RSPF/SPF, press the clear (Ⓢ) key.
- Copying using one-sided to one-sided mode (AR-157E):
Ensure that no indicator is lit among the original to copy indicators.

1 Make sure that no original is left on the original table.

2 Adjust the original guides to the size of originals.

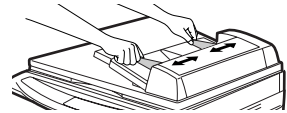

3 Set the originals face up in the original feeder tray.

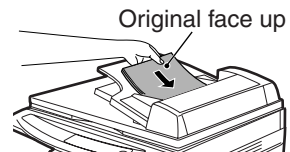

Stream feeding mode

The stream feeding mode allows easy operation of continuous copying from the RSPF/SPF. If the stream feeding mode has been enabled using user program No.4, the RSPF/SPF (○) indicator will blink approximately 5 seconds after the last original has been fed by the RSPF/SPF. While this indicator is blinking, any new originals placed in the original feeder tray will be fed and copied automatically. If the stream feeding mode has been disabled, the start (Ⓢ) key must be pressed each time the originals are set even immediately after completion of a copy run from the RSPF/SPF. The default setting of the stream feeding mode is "ON". See "USER PROGRAMS" (p.23).

SET THE COPY QUANTITY

Set the number of copies using the two copy quantity (\odot , \odot) keys when copying from the original table or copying from RSPF/SPF.



Note

- Press the clear (\odot) key to clear an entry if a mistake is made.
- A single copy can be made with the initial setting, i.e., when "0" is displayed.

- Press the right copy quantity key to set the unit digit from 0 to 9. This key will not change the tens digit.
- Press the left copy quantity key to set the tens digit from 1 to 9.

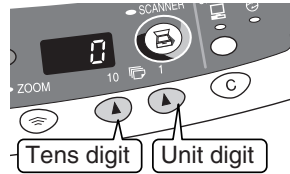

EXPOSURE ADJUSTMENT/PHOTO COPYING

Exposure adjustment

Copy density adjustment is not required for most originals in the automatic exposure mode. To adjust the copy density manually or to copy photographs, the exposure level can be adjusted in five steps manually.



Note

The copy resolution used for AUTO and MANUAL ($\odot \dots \odot$) mode can be changed. (p.23)

1

Press the exposure mode selector key to select the **MANUAL** ($\odot \dots \odot$) mode or **PHOTO** (\odot) mode.

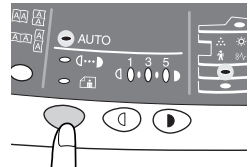

2

Use the light (\odot) and dark (\odot) keys to adjust the exposure level. If exposure level 2 is selected, the two left-handmost indicators for that level will light up simultaneously. Also, if level 4 is selected, the two right-handmost indicators for that level will light up simultaneously.

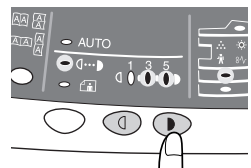

Automatic exposure adjustment



This automatic exposure level will remain in effect until you change it again by this procedure.

The automatic exposure level can be adjusted to suit your copying needs. This level is set for copying from the original table and copying from the RSPF/SPF respectively.

- 1** When adjusting the automatic exposure level for copying from the RSPF/SPF, place an original in the original feeder tray and make sure that the RSPF/SPF (○) indicator lights up. When adjusting the level for copying from the original table, make sure that no original is left in the original feeder tray.

- 2** Press the exposure mode selector key to select the PHOTO (📷) mode.

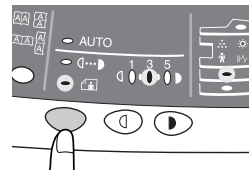

- 3** Press and hold down the exposure mode selector key for approximately 5 seconds. The PHOTO (📷) indicator will go out and the AUTO indicator will begin to blink. One or two light and dark indicators corresponding to the automatic exposure level which has been selected will light up.

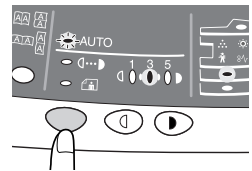

- 4** Press the light (◀) or dark (▶) key to lighten or darken the automatic exposure level as desired. If exposure level 2 is selected, the two left-handmost indicators for that level will light up simultaneously. Also, if level 4 is selected, the two right-handmost indicators for that level will light up simultaneously.

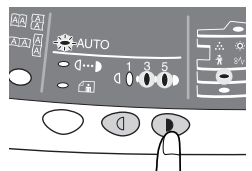

- 5** Press the exposure selector key. The AUTO indicator will stop blinking and light up steadily.

3

REDUCTION/ENLARGEMENT/ZOOM

Three preset reduction ratios and two enlargement ratios can be selected. The zoom function enables copy ratio selection from 25% to 400% in 1% increments.

1 Set the original and check the paper size.

2 Use the copy ratio selector key and/or ZOOM (,) keys to select the desired copy ratio.





Note

- To verify a zoom setting without changing the zoom ratio, press and hold down the copy ratio display (%) key. When the key is released, the display will return to the copy quantity display.
- To reset the ratio to 100%, press the copy ratio selector key repeatedly until the 100% indicator lights up.

3 Set the reduction/enlargement ratio.



Note



To decrease or increase the zoom ratio rapidly, press and hold down the ZOOM () or () key. However the value will stop at the preset reduction or enlargement ratios. To move beyond these ratios, release the key and then press and hold it down again.

To select a preset copy ratio:

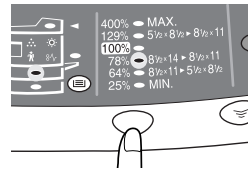
Preset reduction and enlargement ratios are: 25%, 64%, 78%, 129% and 400%.



To select a zoom ratio:

When a ZOOM ( or ) key is pressed, the ZOOM indicator will light up and the zoom ratio will be displayed in the display.

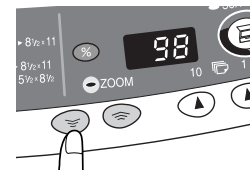

SELECTING THE TRAY



Note

- Paper sizes that can be used in the duplex copy mode are letter, legal, and invoice. When copying from the original table in the duplex copy mode, only letter size paper can be used. (AR-157E)
- The multi-bypass tray cannot be used in the duplex copy mode.

Press the tray select (☰) key.

Each time you press the tray select (☰) key, the location indicated by the paper feed location indicator changes in the following order: paper tray 1, paper tray 2, multi-bypass tray.

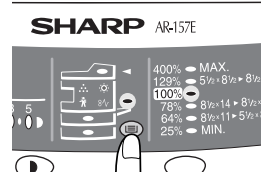

This chapter describes the special functions of this unit. Use these functions as needed.

ABOUT THE SPECIAL FUNCTIONS OF AR-157E

Two sided copying

When copying from the RSPF, two-side originals can be copied automatically without having to manually turn them over. Automatic two-sided copying can also be performed without using the RSPF. When copying from one-sided originals to two-sided copies, copying orientation can be selected between Turn on Long Edge and Turn on Short Edge.



Note

- When making two-sided copies from the original table, the paper size must be letter. When making two-sided copies from the RSPF, letter, legal, and invoice sizes can be used. Non-standard size paper cannot be used.
- When making two-sided copies, the multi-bypass tray cannot be used.
- When using two-sided invoice size originals from the RSPF, be sure to place them in the landscape orientation. Otherwise, an original misfeed will occur.

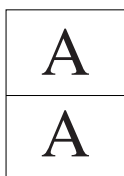
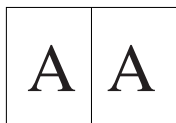

Turn on Long Edge



Turn on Short Edge

Making two-sided copies

1 Place the original(s) on the original table or in the RSPF. (see "ORIGINAL PLACEMENT" (p.14).

2 Select two-sided copy mode.

A: When copying in a one-sided to two-sided mode:

Use the original to copy key to select the desired one-sided to two-sided copying mode (Turn on Long Edge or Turn on Short Edge). See the illustrations on page 20.

B: When copying in the two-sided to two-sided mode:

Use the original to copy key to select the two-sided to two-sided copying mode. The originals must be set in the RSPF before this mode can be set in step 3 on page 15.

C: When copying in the two-sided to one-sided mode:

Use the original to copy key to select the two-sided to one-sided copying mode. The originals must have been set in the RSPF in step 3 on page 15.

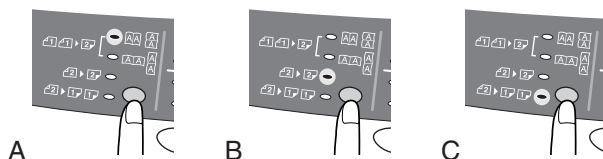

3 Select the copy settings. See "SET THE COPY QUANTITY" (p.16), "EXPOSURE ADJUSTMENT/PHOTO COPYING" (p.16), and "REDUCTION/ENLARGEMENT/ZOOM" (p.18).

Using the original table

If you are using the original table, copying is only possible in one sided to two-sided mode ("A" above).

1 Press the start (⏻) key.

The original is scanned into the unit's memory and the number of the copy quantity blinks in the display.

2 Place the original that you wish to copy onto the rear side of the paper, and press the start (⏻) key again.

Copying begins.

Using the RSPF

Press the start (⏻) key. Copying begins in the selected two-sided copy mode.

DESCRIPTION OF SPECIAL FUNCTIONS

Toner save mode (page 22)

Reduces toner consumption by approximately 10%.

Power save modes (page 23)

The unit has two power save modes of operation: preheat mode and auto power shut-off mode.

Preheat mode

When the unit enters the preheat mode, the power save (☺) indicator will light up and other indicators will remain on or off as before. In this condition, the fuser in the unit is maintained at a lower heat level, thereby saving power. To copy from the preheat mode, make desired copier selections and press the start (⊞) key using the normal copying procedure.

Auto power shut-off mode

When the unit enters the auto power shut-off mode, the power save (☺) indicator will light up and other indicators except the ONLINE indicator will go out. The auto power shut-off mode saves more power than the preheat mode but requires a longer time before starting copying. To copy from the auto power shut-off mode, press the start (⊞) key. Then make desired copier selections and press the start (⊞) key using the normal copying procedure.

Auto clear (page 23)

The unit returns to the initial settings a preset amount of time after the end of copy, or scanner job. This preset amount of time (auto clear time) can be changed.

Stream feeding mode (page 23)

For description of the stream feeding mode, see "Stream feeding mode" (p.15).

Resolution of AUTO & MANUAL mode (page 23)

You can set the copy resolution used for AUTO and MANUAL (Ⓛ⋯Ⓜ) exposure mode.

TONER SAVE MODE

- 1 Press the exposure mode selector key to select the MANUAL (Ⓛ⋯Ⓜ) mode.

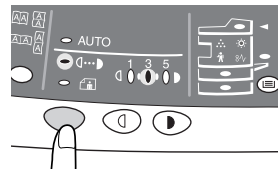

- 2** Press and hold down the exposure mode selector key for approximately 5 seconds. The MANUAL (◀⋯▶) indicator will go out and the PHOTO (📷) indicator will begin to blink. The light and dark indicator marked "5" will light up, indicating the standard toner mode is active.

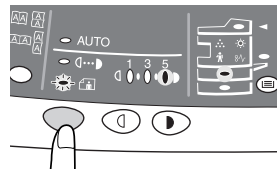

- 3** To enter the toner save mode, press the light (◀) key. The light and dark indicator marked "1" will light up, indicating the toner save mode is selected.

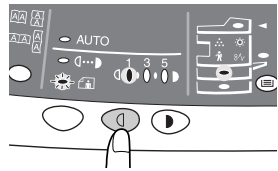

- 4** Press the exposure mode selector key. The PHOTO (📷) indicator will stop blinking and light up steadily. The light and dark indicator marked "3" will light up. The toner save mode is now active.



Note

To return to the standard mode, repeat the procedure but use the dark (▶) key to select exposure level "5" in step 3.

4

USER PROGRAMS

The user programs allow the parameters of certain functions to be set, changed, or cancelled as desired.

Setting the power save modes, auto clear time, stream feeding mode and resolution of AUTO & MANUAL mode

- 1** Press and hold down the light (◀) and dark (▶) keys simultaneously for more than 5 seconds until all the alarm indicators (⊙, ⚡, ⚡, ⚡) blink and " -- " appears in the display.
- 2** Use the left copy quantity (◀) key to select a user program number (1: auto clear time, 2: preheat mode, 3: auto power shut-off timer, 4: stream feeding mode, 5: auto power shut-off mode 6: resolution of AUTO & MANUAL mode). The selected number will blink in the left side of the display.
- 3** Press the start (⊙) key. The entered program number will be steadily lit and the currently selected parameter number for the program will blink on the right side of the display.
- 4** Select the desired parameter using the right copy quantity (▶) key. The entered parameter number will blink on the right of the display.

Program No.	Mode	Parameters
1	Auto clear time	0 → OFF, 1 → 10sec., 2 → 30sec. *3 → 60sec., 4 → 90sec., 5 → 120sec.
2	Preheat mode	*0 → 30sec., 1 → 60sec., 2 → 90sec.
3	Auto power shut-off timer	0 → 2min., *1 → 5min., 2 → 15min., 3 → 30min., 4 → 60 min., 5 → 120min.
4	Stream feeding mode	0 → OFF, *1 → ON
5	Auto power shut-off mode	0 → OFF, *1 → ON
6	Resolution of AUTO & MANUAL mode	*0 → 300dpi, 1 → 600dpi

* Factory default settings are indicated with an asterisk (*).



Note

Program No. 4 can be used when your unit has the RSPF/SPF.

- 5** Press the start () key. The right-hand number in the display will be steadily lit and the entered value will be stored.



Note

To change the setting or to set another mode, press the clear () key. The unit will return to step 2.

- 6** Press the light () or dark () key to return to the normal copy mode.

DISPLAYING TOTAL NUMBER OF COPIES

Use the following procedure to display the total number of copies.

- 1** Press the clear () key to reset the display to zero.

- 2** Press and hold down the clear () key for approximately 5 seconds. The total number of copies will appear in two steps, each with three digits.

Example: Total number of copies is 1,234.



5

MAINTENANCE

This chapter describes how to replace the toner cartridge and how to clean the unit.



Note

Be sure to use only genuine SHARP parts and supplies.



For best copying results, be sure to use only SHARP Genuine Supplies which are designed, engineered, and tested to maximize the life and performance of SHARP copiers. Look for the Genuine Supplies label on the toner package.

TONER CARTRIDGE REPLACEMENT

When the toner cartridge replacement required (∴) indicator lights up, replacement of the toner cartridge will be needed soon. Obtain a new cartridge. When the toner cartridge replacement required (∴) indicator blinks, the toner cartridge must be replaced before copying can be resumed. Replace the toner cartridge by following the procedure below.



Note

During long copy run of a dark original, the start (Ⓞ) indicator may blink, the indicator light up, and the unit stop, even though toner is left. The unit will feed toner up to 2 minutes and then the start (Ⓞ) indicator will light up. Press the start (Ⓞ) key to restart copying.

- 1** Open the multi-bypass tray, and then open the side cover while pressing the side cover open button.

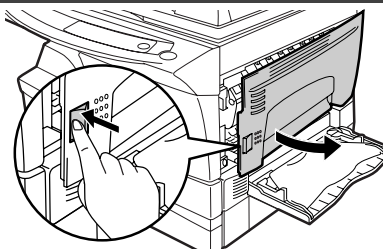

- 2** Push gently on both sides of the front cover to open the cover.

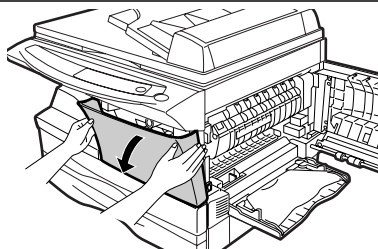

3 Gently pull the toner cartridge out while pressing the lock release lever.

Toner cartridge lock release lever

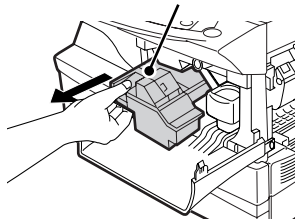

Note

- After removing the toner cartridge, do not shake it or tap on it. Doing so may cause toner to leak from the cartridge. Put the old cartridge immediately in the bag contained in the box of the new cartridge.
- Dispose of the old toner cartridge in accordance with local regulations.

4 Remove the toner cartridge from the bag. Grasp the cartridge on both sides and shake it horizontally four or five times. After shaking the cartridge, remove the toner seal.

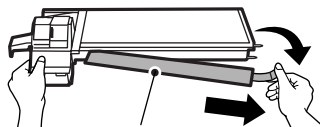
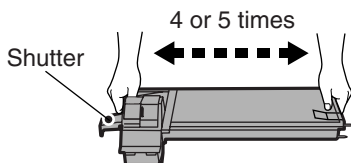

Toner seal



Note

Grasp the toner cartridge as shown in the illustration. Do not hold the cartridge by the shutter. Be sure to only shake the cartridge before the toner seal is removed.

5 Gently insert the toner cartridge along the guides until it locks in place while pushing the lock release lever. Remove the tape from the shutter. Pull the shutter out of the toner cartridge as shown in the illustration. Discard the shutter.

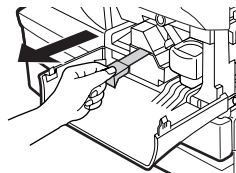
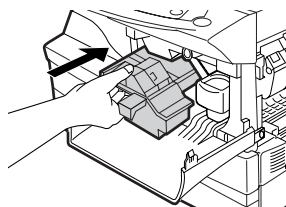

6 Close the front cover and then the side cover by pressing the round projections near the side cover open button. The indicator will go out and the start (⊕) indicator will light up.



Caution

When closing the covers, be sure to close the front cover securely and then close the side cover. If the covers are closed in the wrong order, the covers may be damaged.

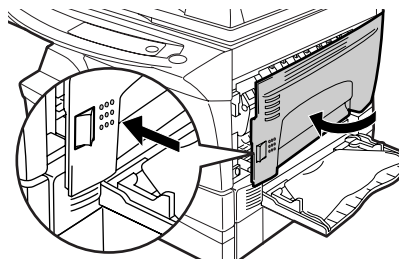
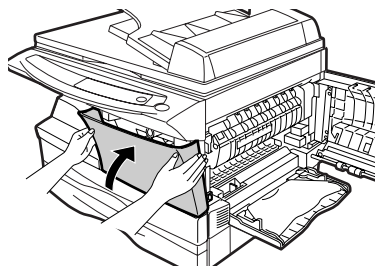

Note

Even after a new toner cartridge is installed, the start (⊕) indicator may not light up, indicating copying cannot be restarted (toner is not sufficiently fed). In this case, open and close the side cover. The copier will feed toner again approximately 2 minutes and then copying can be restarted.

CLEANING THE UNIT

Proper care is essential in order to get clean, sharp copies. Be sure to take a few minutes to regularly clean the unit.



Caution

- *Before cleaning, be sure to turn the power switch off and remove the power cord from the outlet.*
- *Do not use thinner, benzene or other volatile cleaning agents. Doing so may cause deformation, discoloration, deterioration or malfunction.*

Cabinet

Wipe the cabinet with a soft, clean cloth.

Original table and the back side of the original cover/RSPF/SPF

Stains on the glass, RSPF/SPF scanning window, cover or RSPF/SPF roller will also be copied. Wipe the glass, RSPF/SPF scanning window, cover and RSPF/SPF roller with a soft, clean cloth. If necessary, dampen the cloth with a glass cleaner.

Original table/scanning window



Original cover/RSPF/SPF

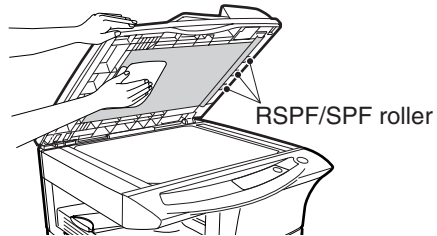

Transfer charger

If copies start becoming streaky or blotchy, the transfer charger may be dirty. Clean the charger using the following procedure.

1 Turn the power switch off. (p.14)

2 Ensure that the multi-bypass tray is open and then open the side cover while pressing the side cover open button.

3 Take the charger cleaner out by holding the tab. Set the charger cleaner onto the right end of the transfer charger, gently slide the cleaner to the left end, and then remove it. Repeat this operation two or three times.



Note

Slide the charger cleaner from the right end to the left end along the groove of the transfer charger. If the cleaner is stopped on the way, smudges on copies may occur.

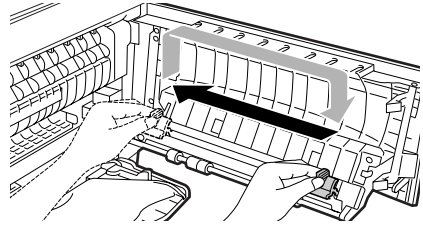
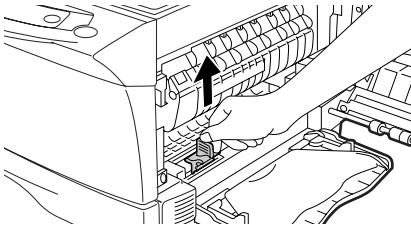

4 Return the charger cleaner to its original position. Close the side cover by pressing the round projections near the side cover open button.

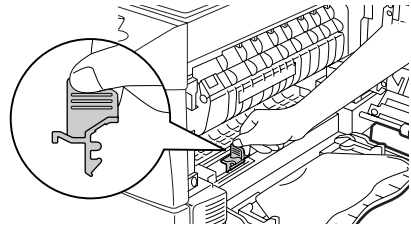

5 Turn the power switch on. (p.13)

6

TROUBLESHOOTING THE UNIT

This chapter describes misfeed removal and troubleshooting.

TROUBLESHOOTING

If any problem occurs, check the list below before contacting the SHARP service center.

Problem	Possible cause	Solution	Page
Unit does not operate.	Unit plugged in?	Plug the unit into a grounded outlet.	–
	Power switch on?	Turn the power switch on.	13
	Side cover closed securely?	Gently close the side cover.	27
	Front cover closed?	Gently close the front cover and then close the side cover.	27
Blank copies	Is the original placed face down on the original table or face up in the RSPF/SPF?	Place the original face down on the original table or face up in the RSPF/SPF.	14, 15
Copies are too dark or too light.	Is original image too dark or too light?	Adjust the exposure manually.	16
	Is the unit in the automatic exposure mode?	Adjust the automatic exposure level.	17
	Is the unit in the photo exposure mode?	Cancel the photo exposure mode.	16
Dust, dirt, smudges appear on copies.	Original table or original cover dirty?	Clean regularly.	28
	Original smudged or blotchy?	Use a clean original.	–
Striped copies	Is transfer charger clean?	Clean the transfer charger.	29
Paper misfeeds frequently.	Non-standard paper used?	Use standard paper. If using special papers, feed the paper through the multi-bypass tray.	7
	Paper curled or damp?	Store paper flat in the wrapper in a dry location.	–
	Pieces of paper inside unit?	Remove all pieces of misfed paper.	32
	Paper guides in the paper tray not set properly?	Set the guides properly depending on the paper size.	8
	Too much paper in the paper tray or multi-bypass tray?	Remove excessive paper from the tray.	8
Images rub off the copy easily.	Is the paper too heavy?	Use paper within the specified range.	7
	Paper damp?	Replace with dry paper. If the unit is not used for long time, remove the paper from the paper tray and store it in its wrapper in a dry location.	2

STATUS INDICATORS

When the following indicators light up or blink on the operation panel or the following alphanumeric codes appear in the display, solve the problem immediately referring to both the table below and the relevant page.



Be sure to use only genuine SHARP parts and supplies.

Indication			Cause and remedy	Page
	Developer replacement required indicator	Steadily lit	Developer is required. Contact your SHARP service center as soon as possible.	37
	Toner cartridge replacement required indicator	Steadily lit	Replacement of toner cartridge will be needed soon. Prepare a new cartridge.	25
		Blinking	Toner cartridge must be replaced. Replace it with a new one.	25
	Misfeed indicator	Blinking	A misfeed has occurred. Remove the misfed paper referring to the description of "MISFEED REMOVAL".	32
			The lower side cover may be open. If so, close it.	35
	Maintenance indicator	Steadily lit	Service by an authorized SHARP service technician is required.	37
	RSPF/SPF misfeed indicator	Blinking	An original misfeed has occurred in the RSPF/SPF. Remove the misfed originals referring to the description of "E: Misfeed in the RSPF/SPF".	35
	Power save indicator is steadily lit.		The unit is in the preheat mode. Press any key to cancel the preheat mode.	22
			The unit is in the auto power shut-off mode. Press the start (⏻) key to cancel the auto power shut-off mode.	22
	The paper tray indicator is blinking.		The paper tray is not installed properly. Push the tray into the unit securely.	8
	"CH" is blinking in the display.		A toner cartridge is not installed. Installed a toner cartridge. If "CH" is blinking even if a cartridge is installed properly, contact SHARP service center.	25
	"CH" is steadily lit in the display.		Side cover is open. Close the side cover securely by pressing the round projections near the side cover open button.	-
	"P" is blinking in the display.		The paper tray or multi-bypass tray is empty. Load paper.	8, 10
			A misfeed has occurred in the paper tray, multi-bypass tray. Remove the misfed paper.	32
	A letter and a number appear alternately.		The unit will not function. Turn the power switch off, remove the power cord from the outlet, and contact your SHARP service center.	-

MISFEED REMOVAL

When the misfeed (⌘) indicator blinks or **P** blinks in the display, the unit will stop because of a misfeed. If a misfeed occurs when using the RSPF/SPF, a number may appear in the display after a minus sign. This indicates the number of the originals that must be returned to the original feeder tray after a misfeed. Return the required number of originals. Then this number will disappear when copying is resumed or the clear (Ⓢ) key is pressed. When the RSPF/SPF misfeeds an original sheet, the unit will stop and the RSPF/SPF misfeed (◁) indicator will blink, while the misfeed (⌘) indicator will remain off. For a misfeed of originals in the RSPF/SPF, see "E: Misfeed in the RSPF/SPF" (p.35).



Note

If the unit is turned on with the lower side cover open, the misfeed (⌘) indicator will blink. In this case, close the lower side cover. The misfeed (⌘) indicator will go out.

1 Open the multi-bypass tray, and side cover, in that order.

To open the multi-bypass tray, see "BYPASS FEED (including special paper)" (p.10). To open the side cover, see "TONER CARTRIDGE REPLACEMENT" (p.25).

2 Check the misfeed location. Remove the misfed paper following the instructions for each location in the illustration below. If the misfeed (⌘) indicator blinks, proceed to "A: Misfeed in the paper feed area" (p.33).

If the misfed paper is seen from this side, proceed to "C: Misfeed in the transport area". (p.34)

If paper is misfed here, proceed to "B: Misfeed in the fusing area". (p.33)

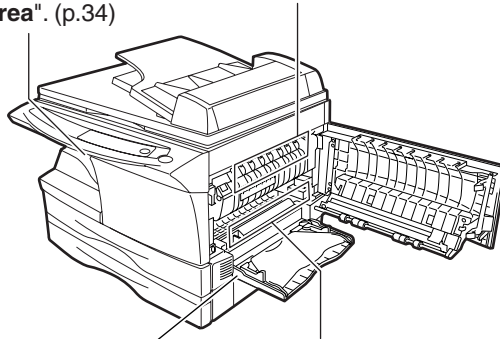

If paper is misfed here, proceed to "D: Misfeed in the lower paper feed area". (p.35)

If paper is misfed here, proceed to "A: Misfeed in the paper feed area". (p.33)

A: Misfeed in the paper feed area

- 1** Gently remove the misfed paper from the paper feed area as shown in the illustration. When the misfeed (⊘) indicator blinks and the misfed paper is not seen from the paper feed area, pull out the paper tray and remove the misfed paper. If the paper cannot be removed, proceed to "B: Misfeed in the fusing area".



Warning

The fusing unit is hot. Do not touch the fusing unit when removing misfed paper. Doing so may cause a burn or other injury.



Caution

- Do not touch the photoconductive drum (green portion) when removing the misfed paper. Doing so may cause smudges on copies.
- If the paper has been fed through the multi-bypass tray, do not remove the misfed paper through the multi-bypass tray. Toner on the paper may stain the paper transport area, resulting in smudges on copies.

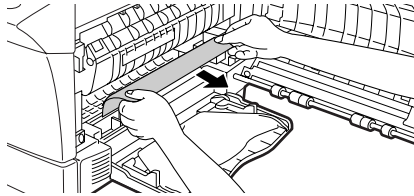

- 2** Close the side cover by pressing the round projections near the side cover open button. The misfeed (⊘) indicator will go out and the start (⊙) indicator will light up.

B: Misfeed in the fusing area

- 1** Lower the fusing unit release lever.

Fusing unit release lever

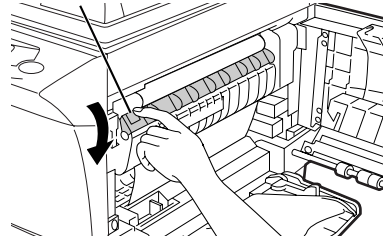

- 2 Gently remove the misfed paper from under the fusing unit as shown in the illustration. If the paper cannot be removed, proceed to "C: Misfeed in the transport area".**

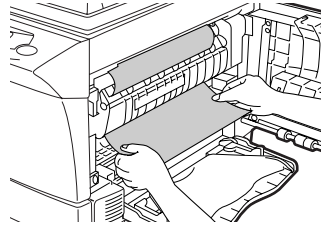

Warning

The fusing unit is hot. Do not touch the fusing unit when removing misfed paper. Doing so may cause a burn or other injury.



Caution

- *Do not touch the photoconductive drum (green portion) when removing the misfed paper. Doing so may cause smudges on copies.*
- *Do not remove the misfed paper from above the fusing unit. Unfixed toner on the paper may stain the paper transport area, resulting in smudges on copies.*

- 3 Raise the fusing unit release lever and then close the side cover by pressing the round projections near the side cover open button. The misfeed (8_v) indicator will go out and the start (⊕) indicator will light up.**

C: Misfeed in the transport area

- 1 Lower the fusing unit release lever.**

See "B: Misfeed in the fusing area" (p.33).

- 2 Open the front cover.**

To open the front cover, see "TONER CARTRIDGE REPLACEMENT" (p.25).

- 3 Rotate the feeding roller in the direction of the arrow and gently remove the misfed paper from the exit area.**

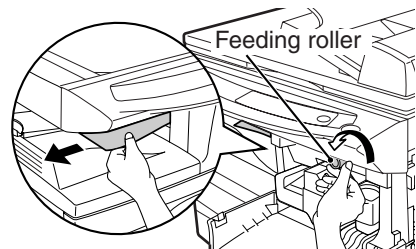

- 4 **Raise the fusing unit release lever, close the front cover and then close the side cover by pressing the round projections near the side cover open button. The misfeed (⌘) indicator will go out and the start (⊕) indicator will light up.**



Caution

When closing the covers, be sure to close the front cover securely and then close the side cover. If the covers are closed in the wrong order, the covers may be damaged.

D: Misfeed in the lower paper feed area

- 1 **Open the lower side cover (under the multi-bypass tray) and remove the misfed paper. If the misfeed (⌘) indicator blinks and the misfed paper is not seen from the area of the lower side cover, pull out the lower paper tray and remove the misfed paper. Then close the lower paper tray.**

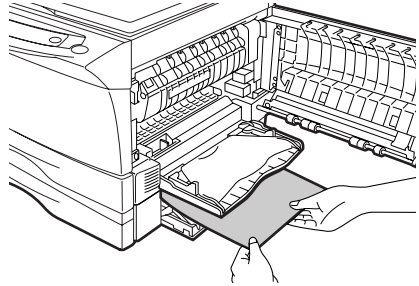

- 2 **Close the lower side cover.**

- 3 **Close the side cover by pressing the round projections near the side cover open button. The misfeed (⌘) indicator will go out and the start (⊕) indicator will light up.**

E: Misfeed in the RSPF/SPF

An original misfeed may occur at one of three locations: if the misfed original is seen from the original feeder tray, (A) in the original feeder tray; if the misfed original is not seen from the original feeder tray, (B) in the exit area or (C) under the feeding roller. Remove the misfed original following the instructions for each location.

- (A) **Open the feeding roller cover and pull the original gently to the left and out from the original feeder tray. Close the feeding roller cover. Open and close the RSPF/SPF to clear the RSPF/SPF misfeed (◁) indicator. If the misfed original cannot be easily removed, proceed to (C).**

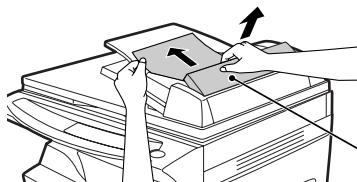

Feeding roller cover

(B) Open the RSPF/SPF and rotate the roller rotating knob to remove the misfed original from the exit area. If the misfed original cannot be easily removed, proceed to (C).

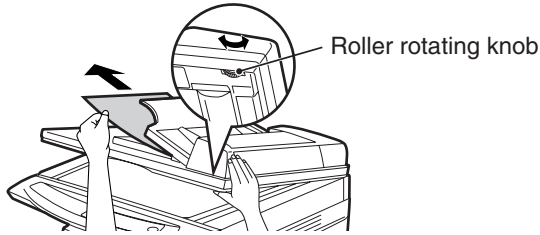

(AR-157E)

With the RSPF, pull out the reversing tray to remove the misfed original.



Note

With the RSPF, after removing the misfed original from the exit area, be sure to insert the reversing tray into the exit area until it locks in place.

Reversing tray

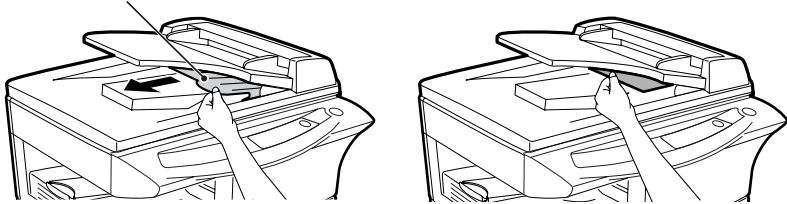

(C) If the original does not move easily into the exit area, remove it in the direction of the arrow while rotating the knob.

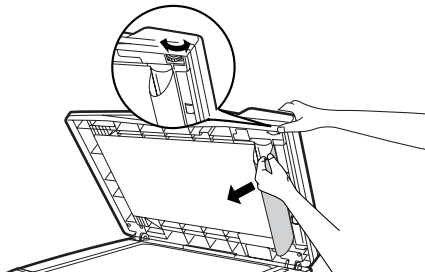

Note

A number may appear in the display after a minus sign, indicating the number of the originals that must be returned to the original feeder tray. Open and close the RSPF/SPF to clear the RSPF/SPF misfeed (<) indicator, and then return the required number of originals. Then press the start () key to resume copying.

DEVELOPER REQUIRED

When the developer replacement required () indicator lights up, the developer should be replaced. DEVELOPER REPLACEMENT SHOULD ONLY BE DONE BY AN AUTHORIZED SHARP SERVICE TECHNICIAN. Contact your service center as soon as possible.

MAINTENANCE REQUIRED

When maintenance () indicator lights up, service by an authorized SHARP service technician is required. Contact your service center as soon as possible.

SYSTEM CONFIGURATION

A number of options are available for the unit which allow you to configure a system to meet your particular needs. The options include the following.

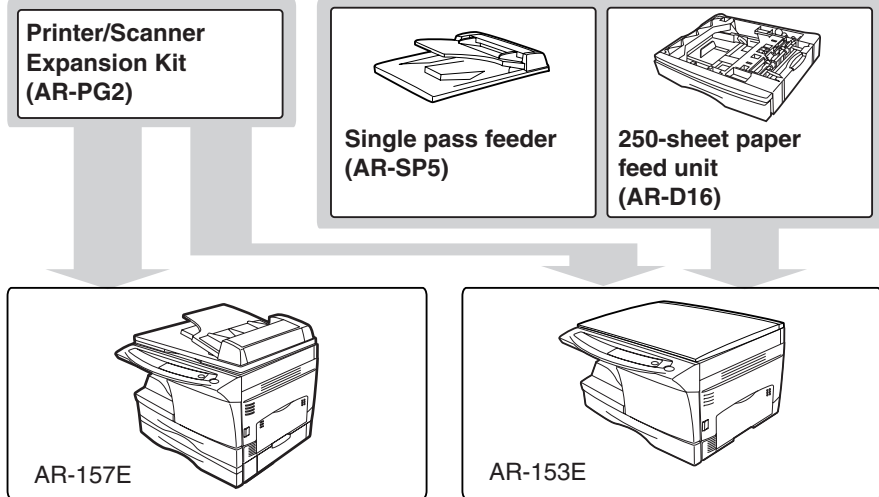

PRINTER/SCANNER EXPANSION KIT (AR-PG2)

A printer function and scanner function can be added to the unit by installing the AR-PG2. For information on installing the software for these functions, see "INSTALLING THE SOFTWARE" (p.40).

SINGLE PASS FEEDER (AR-SP5)

The single pass feeder (SPF) holds up to 30 originals for automatic feeding.

The procedures for placing originals in the SPF, cleaning the SPF, and removing a misfeed are the same as for the RSPF. See "Using the RSPF/SPF" (p.15), "CLEANING THE UNIT" (p.28) and "E: Misfeed in the RSPF/SPF" (p.35).

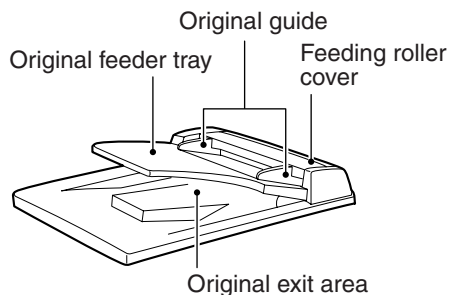

250-SHEET PAPER FEED UNIT (AR-D16)

The paper feed unit provide the convenience of increased paper capacity for the unit and a greater choice of paper size readily available for copying.

The procedures for loading paper in the paper tray of paper feed unit, changing the paper size, and selecting the paper tray are same as for the paper tray in the unit. See "LOADING THE PAPER TRAY" (p.8) and "SELECTING THE TRAY" (p.19).

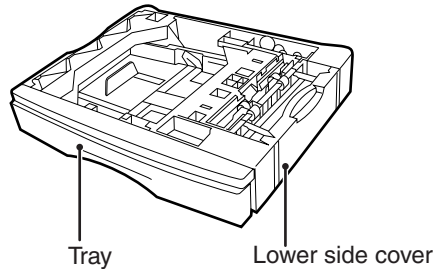

Using the paper feed unit with the printer function (when the AR-PG2 is installed)

When the printer/scanner expansion kit is installed on the unit, the AR-D16 can also be used with the printer function. To use the AR-D16 with the printer function, follow these steps to adjust the settings in the printer driver.



Note

The printer driver cannot be set for use with the AR-D16 when opened from the application.

- 1 Click the "start" button.**
- 2 Click "Control Panel", select "Printer and Other Hardware", and then click "Printer and Faxes".**
On Windows 95/98/Me/NT 4.0/2000, select "Setting" and click "Printers".
- 3 Click the "SHARP AR-153E" printer driver icon and from the "File" menu select "Properties".**
On Windows 95/98/Me, click the "SHARP AR-153E" printer driver icon, select "Properties" from the "File" menu, and then click the "Setup" tab.
- 4 Click the "Utility" tab.**
- 5 Select "Two trays" for "Input tray option", and click "OK".**
The printer driver closes. This completes the settings needed to use the AR-D16.

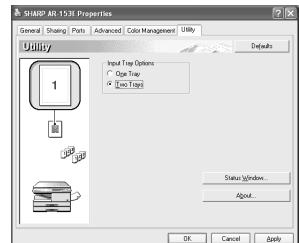

7

8

INSTALLING THE SOFTWARE

The procedure for installing the software for the optional AR-PG2 Printer/Scanner Expansion Kit and the operation of the printer/scanner is explained here. Information on how to use the online manual is also provided.

Illustrations of driver screens and other computer screens show the screens that appear in Windows XP Home Edition. Some of the names that appear in these illustrations may differ slightly from the screens that appear in other operating systems.

The following term is used in this chapter.

CD-ROM

Means the supplied CD-ROM with the SHARP Personal MFP series software.

SOFTWARE FOR THE SHARP PERSONAL MFP SERIES

The supplied CD-ROM includes software for this unit.

MFP driver

Scanner driver

Permits you to operate scanning function of this unit with TWAIN-compliant and WIA-compliant application.

Printer driver

Enables you to use the printer function of this unit with your computer.

Print Status Window

The print state and information on current printing are displayed on the status monitor window.

Sharpdesk

An integrated software environment that makes it easy to manage document and image files and launch applications.

Button Manager

Button Manager enabling the SCANNER () key located on the unit.



Note

The scanning feature is only available with Windows 98/Me/2000/XP using a USB connection. For users running Windows 95/NT 4.0 or using a parallel connection, only printing is available.

HARDWARE AND SOFTWARE REQUIREMENTS

Check the following hardware and software requirements in order to install the software.

Computer type	IBM PC/AT or compatible computer equipped with a USB1.1* ¹ or bi-directional parallel interface (IEEE 1284)
Operating system* ²	Windows 95, Windows 98, Windows Me, Windows NT Workstation 4.0 (ServicePack 5 or later)* ³ , Windows 2000 Professional* ³ , Windows XP Professional* ³ , Windows XP Home Edition* ³
Display	800 x 600dots (SVGA) display with 256 colors (or better)
Hard disk free space	150MB or more
Other requirement for hardware	An environment on which any of the operating systems listed above can fully operate

*¹ Compatible with Windows 98, Windows Me, Windows 2000 Professional, Windows XP Professional or Windows XP Home Edition preinstalled model with USB interface equipped as standard.

*² Printing is unavailable in MS-DOS mode.

*³ The administrator's authorization is required to install this software using this installer.

BEFORE INSTALLATION

The following table shows the drivers and software that can be installed for each version of Windows and interface connection method.

	MFP Driver		Button Manager	Sharpdesk
	Printer driver/ Print Status Window	Scanner driver		
Users of Windows 98/Me/2000/XP who will use the USB interface connection	Available* ¹	Available	Available	Available
Users of Windows 98/Me/2000/XP who will use the parallel interface connection		Not Available	Not Available	Available* ²
Windows 95/NT 4.0 users				

*¹ When the unit is connected through the parallel port, the Print Status Window can only be used when the parallel port is set to ECP mode. To set the parallel port mode, refer to your computer manual or ask the manufacturer of your computer.

*² Sharpdesk can be installed when using a parallel interface connection, however, the unit's scanner function cannot be used.



Caution

Is there another GDI printer driver or a Windows Printing System printer driver already installed? If installed, change the printer port setting. For the change of the printer port setting, see "USING OTHER INSTALLED DRIVERS" (p.66).

Flow of installation

Refer to the following table and then begin installation.

Operating system	Interface	Reference pages for how to install
Windows XP	USB/ Parallel	Installing onto Windows XP (USB/parallel interface) (p.43)
Windows 98	USB	Installing onto Windows 98/Me/2000 (USB interface) (p.47)
	Parallel	Installing onto Windows 95/98/Me/NT4.0/2000 (Parallel interface) (p.50)
Windows Me	USB	Installing onto Windows 98/Me/2000 (USB interface) (p.47)
	Parallel	Installing onto Windows 95/98/Me/NT4.0/2000 (Parallel interface) (p.50)
Windows 2000	USB	Installing onto Windows 98/Me/2000 (USB interface) (p.47)
	Parallel	Installing onto Windows 95/98/Me/NT4.0/2000 (Parallel interface) (p.50)
Windows 95/ NT 4.0	Parallel	Installing onto Windows 95/98/Me/NT4.0/2000 (Parallel interface) (p.50)

INSTALLING THE SOFTWARE

The following term is used in this section.

MFP

Means the unit as a printer and scanner.



Note

- For this description, it is assumed that the mouse is configured for right hand operation.
- To print or scan, the MFP must be in the online state.
- The scanner feature only works when using a USB interface cable.
- If any error message appears, solve the problem following the instructions on the screen. After your problem is solved, the installing procedure will be continued. Depending on your problem, you may have to exit the installer. In this case, click the "Cancel" button to exit the installer. After solving your problem, reinstall the software from the beginning.

Installing onto Windows XP (USB/parallel interface)

Before starting the installation, make sure the USB or parallel interface cable is not connected to the MFP.

1 Insert the supplied CD-ROM into your CD-ROM drive.

2 Click the "start" button, click "My Computer" (), and then double-click the CD-ROM () icon.



Note

When any of "Found New Hardware Wizard" messages appear during the software installation, be sure to click the "Cancel" button.

3 Double-click the "setup" () icon.



Note

If the language selection screen appears after you double click the "setup" icon, select the language you wish to use and click the "Next" button. (Normally, the correct language is selected automatically.)

4 Select the software packages to be installed, and then click the "Next" button.

The software packages with checkmark () on the list on the screen will be installed.

Click the "Display README" button to show the information on the selected package.





Note

- If you are using the parallel interface connection, do not select the Button Manager checkbox because this feature is not supported with the parallel interface.
- If the following screen appears, click the "OK" button. Review the contents in "BEFORE INSTALLATION" (p.41), and then select only appropriate the software packages to be installed.



5 Review the software packages to be installed on the screen, and then click the "Start" button.

The software packages to be installed will be displayed on the screen. If inappropriate packages are displayed, click the "Back" button to select appropriate packages again.

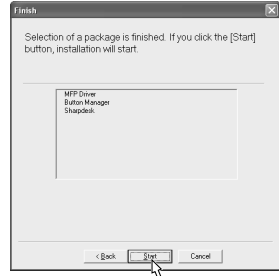

6 Copying files for MFP driver installation (This step will start if it was selected in step 4).

- 1 After confirming the message in the "Welcome" window, click the "Next" button.
- 2 A dialog box appears asking you to verify that the USB or parallel interface cable is not connected to the MFP. Make sure that the interface cable is not connected and click the "Next" button.
- 3 Click the "Next" button in the dialog box to install the MFP driver or Cancel to quit the installation.

The setup program will start to copy the files. If the following screen appears while the files are being copied (the message may appear more than once), click "Continue Anyway".

- 4 When the "The MFP driver installation is complete." dialog box appears, click the "OK" button.

The Button Manager installer will start.



7 Begin installation of the Button Manager (This step will start if it was selected in step 4).

- 1 After confirming the message in the "Welcome" window, click the "Next" button.
- 2 Read the message in the "Please read the following information." window, and then click the "Next" button.
- 3 When a message appears that lets you specify the location for the software to be installed, click the "Next" button.
- 4 If the program displays "Do you want the Button Manager added to Windows Startup?", check "Yes" and click the "OK" button.
The setup program will start to copy the files.
- 5 Click the "Finish" button when the message informs you that setup is successful.
The Sharpdesk installer will start.

8 Begin installation of the Sharpdesk (This step will start if it was selected in step 4).

- 1 After confirming the message in the "Welcome to Sharpdesk installation" window, click the "Next" button.
- 2 Read the message in the "Information" window, and then click the "Next" button.
- 3 When the "Choose Destination Location" window appears, click the "Next" button.
- 4 When the "Select Program Folder" window appears, click the "Next" button.
The setup program will start to copy the files.
- 5 Click the "Finish" button when the message informs you that Setup is complete.

9 Click the "Close" button when the message informs you that "Setup has finished". When the "Now connect the MFP interface cable to the PC" dialog box appears, click the "OK" button.



Note

After the installation, a message to restart your computer may be displayed. In this case, click the "Yes" button to restart your computer.



10 **Connect the USB interface cable or parallel interface cable. (p.67)**

Windows will detect the MFP and the Plug and Play screen will appear. If you are using Windows XP with the parallel interface, go to step 12.

11 **Begin installation of the scanner driver.**

- 1** "SHARP AR-xxxx" (where xxxx is the model name of your MFP) will appear in the "Found New Hardware Wizard" dialog box. Select "Install the software automatically (Recommended)" and click the "Next" button.
- 2** The "Install hardware" dialog box will appear. Click the "Continue Anyway" button.
- 3** When installation of the driver is completed, click the "Finish" button to finish the scanner driver installation.

12 **Begin installation of the printer driver.**



- 1** "SHARP AR-xxxx" (where xxxx is the model name of your MFP) will appear in the "Found New Hardware Wizard" dialog box. Select "Install the software automatically (Recommended)" and click the "Next" button.
- 2** The "Hardware Installation" dialog box will appear. Click the "Continue Anyway" button.
- 3** When installation of the driver is completed, click the "Finish" button to finish the printer driver installation.

You have completed the installation of all the software.

Installing onto Windows 98/Me/2000 (USB interface)

Before starting the installation, make sure the USB interface cable is not connected to the MFP.

1 Insert the supplied CD-ROM into your CD-ROM drive.

2 Double-click "My Computer" (), and then double-click the CD-ROM () icon.



Note

When any of "Hardware Found", or "Found New Hardware Wizard" messages appear during the software installation, be sure to click the "Cancel" button.

3 Double-click the "setup" () icon.



Note

If the language selection screen appears after you double click the "setup" icon, select the language you wish to use and click the "Next" button. (Normally, the correct language is selected automatically.)

4 Select the software packages to be installed, and then click the "Next" button.

The software packages with checkmark () on the list on the screen will be installed. Click the "Display README" button to show the information on the selected package.

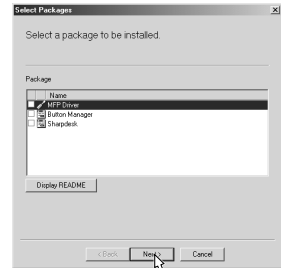

Note

If the following screen appears, click the "OK" button. Review the contents in "BEFORE INSTALLATION" (p.41), and then select the appropriate driver software packages to be installed.

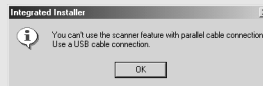

5 Review the software packages to be installed on the screen, and then click the "Start" button.

The software packages to be installed will be displayed on the screen. If inappropriate packages are displayed, click the "Back" button to select appropriate packages again.

6 Copying files for MFP driver installation.

- 1 After confirming the message in the "Welcome" window, click the "Next" button.
- 2 A dialog box appears asking you to verify that the interface cable is not connected to the MFP. Make sure that the interface cable is not connected and click the "Next" button.
- 3 Click the "Next" button in the dialog box showing the files to be copied for installation of the MFP driver.

The setup program will start to copy the files. In Windows 2000, if the following screen appears while the files are being copied (the message may appear more than once), click "Yes" in Windows 2000.



- 4 The following screen appears when all of the files for the USB interface connection have been copied. If you are not using a parallel interface cable for connection to the MFP, please click the "No" button.

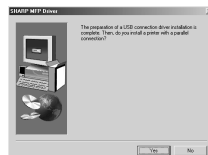

- 5 When the "The MFP driver installation is complete." dialog box appears, click the "OK" button. The Button Manager installer will start.

7 Begin installation of the Button Manager (This step will start if it was selected in step 4).

- 1 After confirming the message in the "Welcome" window, click the "Next" button.
- 2 Read the message in the "Please read the following information." window, and then click the "Next" button.
- 3 When a message appears that lets you specify the location for the software to be installed, click the "Next" button.
- 4 If the program displays "Do you want to add Button Manager to Startup program?", check "Yes" and click the "OK" button. The setup program will start to copy the files.
- 5 Click the "Finish" button when the message to inform you of the completion of the installation appears. The Sharpdesk installer will start.

8 Begin installation of the Sharpdesk (This step will start if it was selected in step 4).

- 1 After confirming the message in the "Welcome to Sharpdesk installation" window, click the "Next" button.
- 2 Read the message in the "Information" window, and then click the "Next" button.
- 3 When the "Choose Destination Location" window appears, click the "Next" button.
- 4 When the "Select Program Folder" window appears, click the "Next" button.

The setup program will start to copy the files.

If the dialog box asking "If you have TIF files saved using Photoshop or Imaging for Windows you should hit Skip" appears, answer the question to continue the Sharpdesk installation.



- 5 Click the "Finish" button when the message to inform you of the completion of the installation appears.

9 Click the "Close" button when the message to inform you of the completion of the installation appears. When the "Now connect the MFP interface cable to the PC. This will finalize the drivers installation and settings." dialog box appears, click the "OK" button.



Note

After the installation, a message to restart your computer may be displayed. In this case, click the "Yes" button to restart your computer.

10 Connect the USB interface cable. (p.67)

Windows will detect the MFP and the Plug and Play screen will appear.



11 Follow the instructions in the Plug and Play screen that appears in your version of Windows to begin the installation.

You have completed the installation of the software.

Installing onto Windows 95/98/Me/NT4.0/2000 (Parallel interface)

Before starting the installation, make sure the USB or parallel interface cable is not connected to the MFP.

1 Insert the supplied CD-ROM into your CD-ROM drive.

2 Double-click "My Computer" (), and then double-click the CD-ROM () icon.



Note

When any of "Hardware Found", or "Found New Hardware Wizard" messages appear during the software installation, be sure to click the "Cancel" button.

3 Double-click the "setup" () icon.



Note

If the language selection screen appears after you double click the "setup" icon, select the language you wish to use and click the "Next" button. (Normally, the correct language is selected automatically.)

4 Select the software packages to be installed, and then click the "Next" button.

The software packages with checkmark () on the list on the screen will be installed.

Click the "Display README" button to show the information on the selected package.

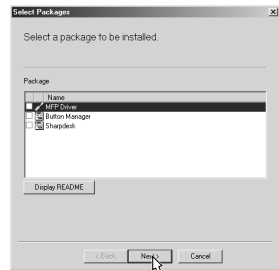

Note

In Windows 95/NT 4.0, "Button Manager" does not appear. In Windows 98/Me/2000, do not select the "Button Manager" checkbox, because this is not supported when using the parallel interface.

5 The next screen appears. Make sure that the parallel interface cable is not connected, and click "OK".

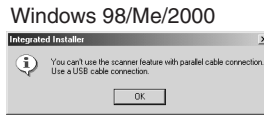
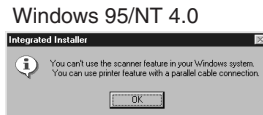

6 Check the contents of the package on the screen, and then click the "Start" button.

The software packages to be installed will be displayed on the screen. If inappropriate packages are displayed, click the "Back" button to select only appropriate software packages.

7 Copying files for MFP driver installation and parallel interface setup (This step will start if it was selected in step 4).

- 1 After confirming the message in the "Welcome" window, click the "Next" button.
- 2 A dialog box appears asking you to verify that the USB or parallel interface cable is not connected to the MFP. Make sure that the interface cable is not connected and click the "Next" button.
- 3 Click the "Next" button in the dialog box to install the MFP driver or Cancel to quit the installation.

The setup program will start to copy the files. In Windows 2000, if the following screen appears while the files are being copied (the message may appear more than once), click "Yes" in Windows 2000.



- 4 The following screen appears. Click the "Yes" button, and then the Model screen will appear. Select the model number that is the same as the model name of your MFP and click the "Next" button.

Be sure to select the displayed model number that is the same as the MFP's model name. If they are not the same, the driver will not be installed correctly.

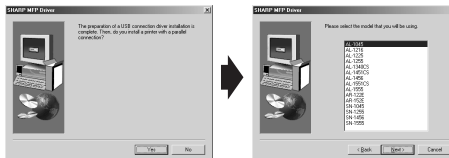

- 5 Establish the printer settings and click the "Next" button.

Select "LPT1" for the port to be used. If "LPT1" does not appear, it is likely that another printer or peripheral device is using "LPT1". Check your other printers and peripheral devices, and change the port setting as needed so no device is using "LPT1". If you wish the MFP to be your default printer, select "Yes". If not, select "No".



- 6 When the "Setup has completed gathering all necessary installation information" dialog box appears, click the "Yes" button.

The parallel interface driver is installed.

- 7 When the "The MFP driver installation is complete." dialog box appears, click the "OK" button.

The Sharpdesk installer will start.

8 Begin installation of the Sharpdesk (This step will start if it was selected in step 4).

- 1 After confirming the message in the "Welcome to Sharpdesk installation" window, click the "Next" button.
- 2 Read the message in the "Information" window, and then click the "Next" button.
- 3 When the "Choose Destination Location" window appears, click the "Next" button.
- 4 When the "Select Program Folder" window appears, click the "Next" button.

The setup program will start to copy the files.

If the dialog box asking "If you have TIF files saved using Photoshop or Imaging for Windows you should hit Skip" appears, answer the question to continue the Sharpdesk installation.



- 5 Click the "Finish" button when the message to inform you of the completion of the installation appears.

9 Click the "Close" button when the message to inform you of the completion of the installation appears.



Note

After the installation, a message to restart your computer may be displayed. In this case, click the "Yes" button to restart your computer.

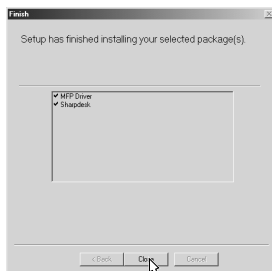

10 Connect the parallel interface cable.

You have completed the installation of all the software.

INDICATORS ON THE OPERATION PANEL

The ONLINE indicator and the start (⏻) indicator indicate the state of the printer or scanner.

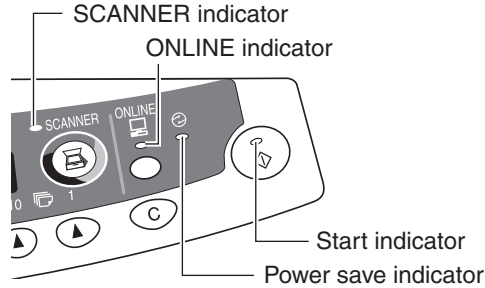

Start indicator

On: Indicates the unit is ready for copying or scanning is being performed.

Blinking: The indicator blinks in the following situations:

- When a print job is interrupted.
- During initialization of the unit. (the cover has been opened and closed or the power turned off and on.)
- When reserving a copy job.
- When toner is being replenished during a copy or print job.

Off: The indicator is off in the following situations:

- During copying or scanning.
- The unit is in the auto power shut-off mode.
- When a misfeed or error has occurred.

ONLINE indicator

The ONLINE key is pressed and on line and off line are changed.

On: Indicates the unit is ready for printing or scanning is being performed. (On line)

Blinking: Printing or data is being received from a computer.

Off: Copying is being performed. (Off line)

Power save indicator

On: Indicates the unit is in a power save mode.

Scanner indicator

On: The SCANNER (Ⓜ) key has been pressed and the unit is in scanner mode.

Blinking: A scan job is being executed from the computer, or scan data is stored in the unit's memory.

Off: The unit is in the copy mode.

USING THE PRINTER MODE



For problems with the printer function, see the online manual or the help file for the driver.

Opening the printer driver from the start menu

Open the printer driver setup screen by the method shown below.

1 Click the "start" button.

2 Click "Control Panel", select "Printers and Other Hardware", and then click "Printers and Faxes".

On Windows 95/98/Me/NT4.0/2000, select "Settings" and click "Printers".

3 Click the "SHARP AR-xxxx" (where xxxx is the model name of your unit) printer driver icon and from the "File" menu select "Properties".



On windows NT 4.0, select "Document Defaults" to open the printer driver setup screen.

4 Click "Printing Preferences" button in the "General" tab.

On Windows 95/98/Me, click the "Setup" tab.
The printer driver setup screen will appear.



Refer to the Windows manual or help file for more information on the "General" tab, "Details" tab, "Color Management" tab and "Sharing" tab.

How to print

1 Make sure that the paper of the desired size and type is loaded in the tray.

The procedure for loading paper is the same as for loading copy paper. See "LOADING PAPER" (p.7).

2 Open the document you intend to print, and select "Print" from the application's "File" menu.

3 Make sure that "SHARP AR-xxxx" (where xxxx is the model name of your unit) is selected as the current printer. If you intend to change any print setting, click the "Preferences" button to open the setting dialog.

On Windows 95/98/Me/NT 4.0, click the "Properties" button.

On Windows 2000, the "Properties" button does not appear. Set your preferences by switching the tab in the "Print" dialog box.

4 Specify the print settings including the number of copies, media type, and print quality, and then click the "Print" button to start printing.

On Windows 95/98/Me/NT 4.0, click the "OK" button to start printing. For details on print settings, see the online manual or the help file for the printer driver.



Note

- If copying is being performed when printing is started, copying will continue. After copying is complete, printing will be executed when the clear (C) key is pressed twice, the ONLINE key is pressed to switch the unit to the online state or approximately 60 seconds (auto clear time)* elapse.
* The auto clear time varies with a user program setting. See "USER PROGRAMS" (p.23).
- Preheat mode and auto power shut-off mode will be canceled when printing is started.
- If the paper size specified from the software application is larger than the paper size in the printer, part of the image that is not transferred to the paper may remain on the surface of the drum. In this case, the backside of the paper may become dirty. If this occurs, change to the correct size paper and print two or three pages to clean the image.
- If you start a print job while a scan job is in progress, the print data will be stored in the unit's memory. When the scan job is completed, printing will begin.

About interrupt copying

If you press the start (S) key to begin a copy job while a print job using the paper tray or multi-bypass tray is in progress, the copy job will begin automatically after the print data in the unit's memory is printed (interrupt copying). When this is done, the print data remaining in the computer is not sent to the unit. When the copy job ends, press the clear (C) key twice, or press the ONLINE key once to change the unit to the online state (p.53), or wait until the set auto clear time (p.22) elapses. The remaining print data will be sent to the unit and printing will resume.

USING THE SCANNER MODE



Note

For problems with the scanner function, see the online manual or the help file for the driver.

Using the Button Manager

Setting up the Button Manager

The scanner driver for this unit includes an STI (Still image) driver and WIA (Windows Image Acquisition) driver. You can install software that supports the STI driver and WIA driver to enable scanning using only the operation panel of the unit. The Button Manager accessory software supports the STI driver and WIA driver. Setup that is required in Windows to use the Button Manager is explained in the following.

Windows XP

- 1 Click the "start" button, select "Control Panel" and click "Printers and Other Hardware", and then click "Scanners and Cameras" in the start menu. Right click the "SHARP AR-xxxx" (where xxxx is the model name of your unit) icon and click "Properties" in the menu that appears.

- 2 In the "Properties" screen, click the "Events" tab.



- 3 Click the "Select an event" button and select "ScanMenu SC1" from the pull-down menu. Select "Button Manager (SHARP Personal MFP series)" in "Start this program" and click "Apply".

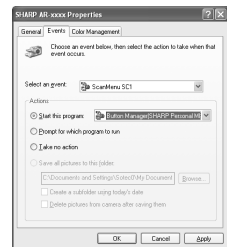

- 4 Repeat Step3 to set "ScanMenu SC2" through "ScanMenu SC6" . Click the "Select an event" button and select "ScanMenu SC2" from the pull-down menu. Select "Button Manager (SHARP Personal MFP series)" in "Start this program" and click "Apply". Do the same for each ScanMenu through "ScanMenu SC6".

When the settings have been completed, click the "OK" button to close the screen. When the settings have been completed in Windows, start the Button Manager. Adjust detailed settings and then scan an image from the unit. For the procedures for starting Button Manager and adjusting settings, see "Scan Button Destination Setting Dialog Box" (p.58).

Windows 98/Me/2000

To scan directly into an application using the Button Manager on Windows 98, Windows Me and Windows 2000. Set the Event Manager properties to send only to Button Manager as shown below.

- 1 Click the "Start" button, select "Control Panel" from "Settings", and open "Scanners and Cameras" in start menu.**



Note

In Windows Me, it occasionally happens that the "Scanners and Cameras" icon does not appear immediately after installation of the MFP driver is completed. If the icon does not appear, click "View all Control Panel options" in the Control Panel and display the "Scanner and Cameras" icon.

- 2 Select "AR-xxxx" (where "xxxx" is the model name of your unit), and click the "Properties" button.**

In Windows Me, right click "AR-xxxx" (where "xxxx" is model name of your unit) and click "Properties" in the menu that appears.

- 3 In the "Properties" screen, click the "Events" tab.**

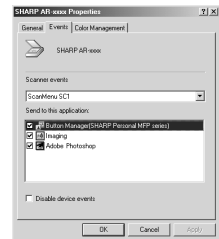

- 4 Click the "Scanner events" button and select "ScanMenu SC1" from the pull-down menu. Select "Button Manager (SHARP Personal MFP series)" in "Send to this application" and click "Apply".**



Note

If other application are shown, deselect the checkboxes for the other applications and leave only the Button Manager checkbox selected.

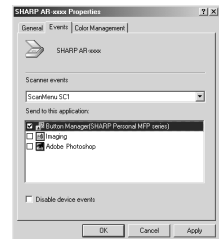

- 5 Repeat Step4 to set "ScanMenu SC2" through "ScanMenu SC6".**

Click the "Scanner events" and select "ScanMenu SC2" from the pull-down menu. Select "Button Manager (SHARP Personal MFP series)" in "Start this program" and click "Apply". Do the same for each ScanMenu through "ScanMenu SC6".

When the settings have been completed, click the "OK" button to close the screen. When the settings have been completed in Windows, start the Button Manager. Adjust detailed settings and then scan an image from the unit. For the procedures for starting Button Manager and adjusting settings, see "Scan Button Destination Setting Dialog Box" (Next page).

Scan Button Destination Setting Dialog Box

After you have completed the Button Manager settings in Windows, configure the scan settings in Button Manager. To configure the scan settings in Button Manager, right click the () icon in the Taskbar and select "Setting" from the menu that appears.

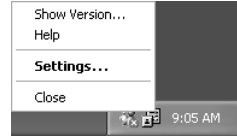

For details on configuring the scan settings in Button Manager, see the online manual or the help file.

This is the corresponding setting in the Button Manager to automatically send multiple images from the RSPF/SPF in full color at 75 dpi to Sharpdesk using the operation panel "SC1" SCANNER () key selection.

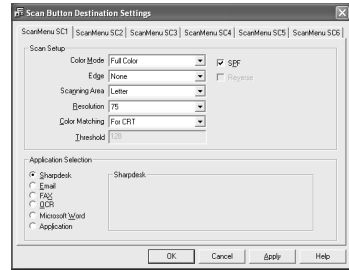

Note

This dialog shows the SC1 event set to go directly to Button Manager. With the Button Manager set to send the image to Sharpdesk. (factory default setting) Sharpdesk will open after acquiring the image automatically.

Flow of the Button Manager setting

The Button Manager can directly handle a AR-xxxx (where xxxx is the model name of your unit) series device event and start your selected application according to the scan setting made on the AR-xxxx (where xxxx is the model name of your unit) operation panel (SC1, SC2, SC3, SC4, SC5, SC6).

This will scan directly into your application from the device.

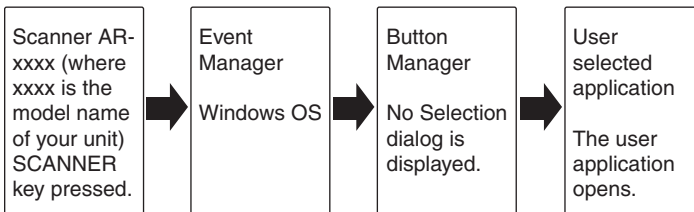

The settings for the Windows Event Manager for the SHARP AR-xxxx (where xxxx is the model name of your unit) device allow the user to take advantage of the Sharp Button Manager to take control of events from Windows and send scanned images to any of six different applications according to the Button Manager setting.

This can be done with the Windows OS showing the Event Manager selection dialog or directly into a selected application if the Button Manager is the only allowed handler for device events from the SHARP AR-xxxx (where xxxx is the model name of your unit).

This is done by changing the Windows device settings for the AR-xxxx (where xxxx is the model name of your unit) in the Scanner and Camera device settings in the Control Panel.

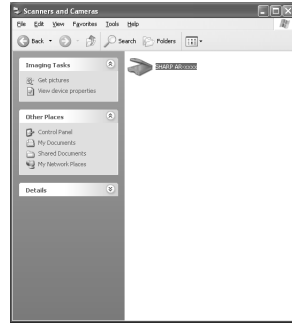

This is the Control Panel Properties dialog for "Scanners and Cameras".

All About The Windows Event Manager and scanner events in Windows 98, Windows Me, Windows 2000 and Windows XP.

Windows Platforms provide a mechanism for software to handle external events for a scanner device like the SHARP AR-xxxx (where xxxx is the model name of your unit) series products. This mechanism is controlled by the device manager on a device basis. Applications that can handle events from a scanner/camera device register with the Windows Event Manager and shown as available in the registered applications. The path an event takes to get to the user's selected application depends upon the event settings for the device.

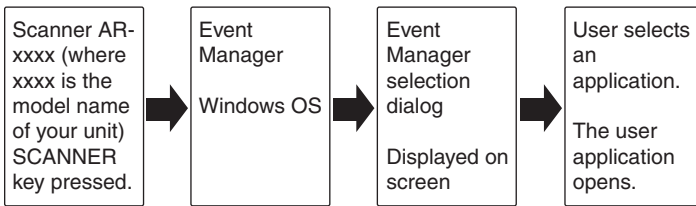

This is the Windows Event Manager Selection Dialog. Shown are two applications registered to handle the scanner event from the AR-xxxx (where xxxx is the model name of your unit) device.

Using the SCANNER key to begin scanning



Note

- Scanning is not possible during a copy job.
- If the unit is used to begin a scan job during a print job, the scan job will be stored and scanning will begin when the print job is completed.
- When scanning an original that has been placed in the RSPF/SPF, only one original can be placed unless you are using Sharpdesk.

1 Press the SCANNER (E) key.

The unit enters scan mode.

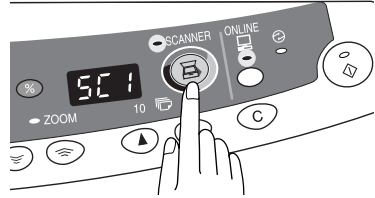

2 Place the original you wish to scan on the original table/RSPF/SPF.

For the procedure for placing the original, see "ORIGINAL PLACEMENT" (p.14).

3 Press the right copy quantity key to display the number of the application that you wish to use for scanning.

The application numbers are initially as follows.

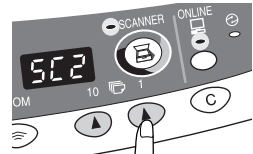

Application number	Application launched
SC1	Sharpdesk (if installed)
SC2	E-mail (your standard e-mail program in the Windows OS you are using)
SC3	Fax (if a fax program is installed)
SC4	OCR (if an OCR program is installed)
SC5	Microsoft Word (if installed)
SC6	Any application set in Button Manager

4 Press the start () key.

The selected application launches and scanning begins.

If the following screen appears, select Button Manager and click "OK". Button Manager starts and the application associated with Button Manager starts. If you want only Button Manager to start in this case, set up Button Manager for use in Windows as explained in "Setting up the Button Manager" (p.56).



Opening the scanner driver and scanning from your computer

Follow the steps below to open the scanner driver setup screen. As an example, this instruction is given using Sharpdesk as an image capture application.



Note

- Scanning is not possible during a copy and print job.
- The method for starting the scanner driver differs depending on the type of application. Refer to the manual or the help file of your application.
- When using the scanner driver to scan an original that has been placed in the RSPF/SPF. If you perform a pre-scan (see the online manual or the help file for the scanner driver), the original in the RSPF/SPF will be output to the exit area after scanning. To scan the original after the pre-scan, place the original in the RSPF/SPF once again.

Using the SHARP TWAIN

1 Place the original(s) you wish to scan on the original table/RSPF/SPF.

For the procedure for placing the original, see "ORIGINAL PLACEMENT" (p.14).

2 After starting Sharpdesk, click the "File" menu and select "Select Scanner".

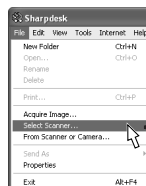

Click here

- 3** Select "SHARP Personal MFP series", and click the "Select" button.

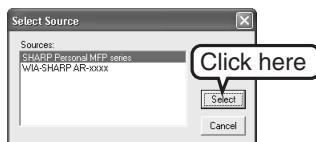

Note

If you use more than one scanning device, select the scanner you want to use through the application. The method for accessing the "Select Scanner" option, depends upon the application. For more information, see the online manual or the help file of your application.

- 4** Select "Acquire Image" from the "File" menu, or click the "Acquire" button ().

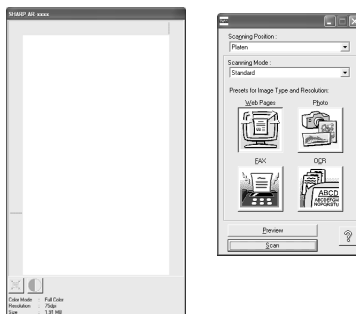

- 5** Set the configuration for scanning (refer to the online manual and help file), and click the "Scan" button.
Scan is started.

Scanning with the "Scanner and Camera Wizard" in Windows XP

Windows XP includes as a standard feature an image scanning function. The procedure for scanning with the "Scanner and Camera Wizard" is explained here.



Note

To cancel scanning, click the "Cancel" button in the screen that is displayed.

1 Place the original you wish to scan on the original table/RSPF/SPF.

For the procedure for placing the original, see "ORIGINAL PLACEMENT" (p.14).

2 Click the "start" button, select "Control Panel", and click "Printers and Other Hardware", and then click "Scanners and Cameras" in the start menu. Click the "SHARP AR-xxxx" (where xxxx is the model name of your unit) icon and click "Get picture" in "Imaging Tasks".

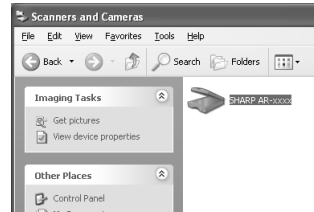

3 The "Scanner and Camera Wizard" appears. Click "Next" and establish the basic settings for scanning.

For information on the settings, see the Windows XP help file. After completing each setting, click "Next".

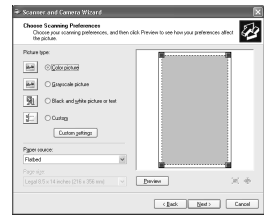

4 Select a name, format, and folder for the scanned image.

For information on the image name, file format, and folder, see the Windows XP help file.

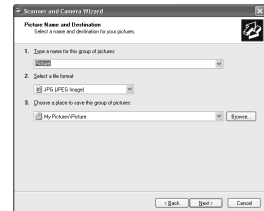

5 Scanning begins. When scanning ends, select the next task you wish to perform.

For information on each selection, see the Windows XP help file. To quit the "Scanner and Camera Wizard", select "Nothing, I'm finished working with these pictures." and click "Next".

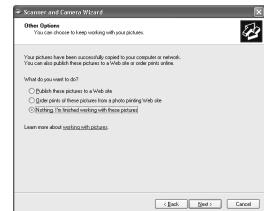

6 Click "Finish" in the screen that appears.

The "Scanner and Camera Wizard" closes and the scanned image is saved.

HOW TO USE THE ONLINE MANUAL

The online manual provides detailed instructions for operating the unit as the printer or scanner and a list of methods for dealing with printing or scanner problems. To access the online manual, your computer must have Acrobat Reader 5.0 or a later version. If it is not installed, refer to "Installing Acrobat Reader" (Next page).

Contents of the online manual

The contents of the online manual are as follows. Check the online manual when you use this unit after all the initial setup is completed.

How to use the online manual

Explains how to use the online manual.

Print

Provides information on how to print a document.

Scan

Explains how to scan using the scanner driver and how to adjust the settings for the Button Manager.



Troubleshooting

Provides instructions on how to solve driver or software problems.

1 Turn on your computer.

2 Insert the supplied CD-ROM into your CD-ROM drive.

3 Click the "start" button, click "My Computer" (), and then double-click the CD-ROM () icon.

On Windows 95/98/Me/NT 4.0/2000, double-click "My Computer" (), and then double-click the CD-ROM () icon.

4 Double-click the "Manual" folder, double-click the "EnglishA" folder, and then double-click the "AR_153E_157E.pdf" icon.

The following window will appear.

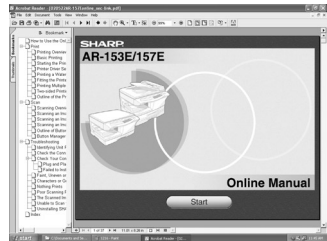

5 Click the  to read the online manual.

To close the online manual, click the (X) button located at the top-right of the window.



Note



- *The online manual can be printed out using Acrobat Reader. SHARP recommends printing out the sections which you refer to regularly.*
- *Refer to "Help" of Acrobat Reader for more details on the operation and function of Acrobat Reader.*

Installing Acrobat Reader

1 Turn on your computer.

2 Insert the CD-ROM into the CD-ROM drive.

3 Click the "start" button, click "My Computer" () , and then double-click the CD-ROM () icon.

Windows95/98/Me/NT4.0/2000, double-click "My Computer" () , and then double-click the CD-ROM () icon.

4 Double-click the "Acrobat" folder, and then double-click the "ar500enu.exe" icon.

Follow the on-screen instructions to install Acrobat Reader.

USING OTHER INSTALLED DRIVERS

If you use another GDI printer or a Windows Printing System printer, interference between printers may occur and printing may not be performed properly. To use another GDI printer or a Windows Printing System printer, you must change the port setting of the printer driver using the following procedure.



Note

If another printer does not operate properly when the SHARP Personal MFP series printer driver is set to "FILE" as described below, uninstall the SHARP Personal MFP series printer driver. To uninstall the printer driver, see the online manual.

1 Click the "start" button.

2 Click "Control Panel", click "Printer and Other Hardware" and then click "Printer and Faxes".

On Windows 95/98/Me/NT4.0/2000, select "Settings" and then click "Printers".

3 Right-click the "SHARP AR-xxxx" (where xxxx is the model name of your unit) icon in the printer dialog box and then click "Properties".

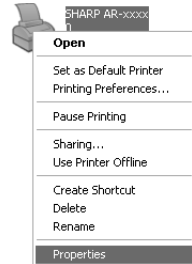

4 Click the "Port" tab ("Details" tab - on Windows 95/98/Me) in the "Properties" dialog box, select "FILE": in the "Print to the following port" list box, and click the "OK".

5 Right-click the icon of the printer to be used and click "Properties".

6 Click the "Port" tab ("Details" tab - on Windows 95/98/Me) in the "Properties" window, select "LPT1" (or the currently used port), and click the "OK" button.



Note

To use the SHARP Personal MFP series again, perform the same procedure but select the port to be used (for example, LPT1) in step 4.

CONNECTING THE INTERFACE CABLE

This unit includes both USB and parallel interface connectors. Interface cables for connecting the unit to your computer are not included with this unit. Please purchase the appropriate cable for your computer.

Interface cable

Parallel interface cable

IEEE 1284-Shielded type bi-directional parallel interface cable (6 feet Max.)

USB interface cable

Shielded twisted pair cable, high-speed transmission equivalent (6 feet Max.)



- *If you intend to use the unit as a scanner, it must be connected to your computer with a USB interface cable. The scanner function cannot be used if the unit is connected with a parallel cable.*
- *USB is available with a PC/AT compatible computer that was originally equipped with USB and had Windows 98, Windows Me, Windows 2000 Professional, Windows XP Professional or Windows XP Home Edition preinstalled.*
- *Do not connect the interface cable before installing the MFP driver. The interface cable should be connected during installation of the MFP driver. (p.43)*

Connecting the USB interface cable

1 Obtain a shielded USB interface cable.

2 Insert the cable into the USB interface connector located on the rear of the unit.

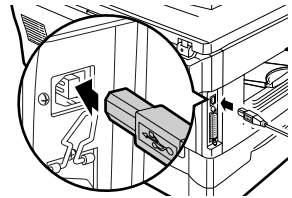

3 Insert the other end of the cable into the interface connector of your computer, or the USB hub connected to your computer.

Connecting the parallel interface cable

1 Obtain an IEEE1284 shielded parallel interface cable.

2 Ensure that your computer and unit are turned off.

3 Insert the cable into the parallel interface connector located on the rear of the unit, and fasten with clasps.

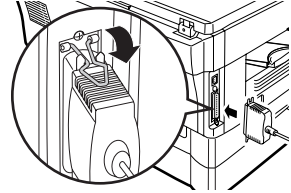

4 Insert the other end of the cable into the interface connector of your computer.

SPECIFICATIONS

Model		AR-153E	AR-157E
Type		Digital laser copier/printer, desk-top type	
Copy system		Dry, electrostatic transfer	
Originals		Sheets, bound documents	
Paper tray		250 sheets	
Multi-bypass tray		50 sheets	
Paper output tray		100 sheets	
RSPF		—	RSPF
Original sizes	Original table/ RSPF	Max. 8-1/2" x 14"	
Original feed	Original table	1 sheet	
	RSPF	—	Up to 30 sheets
Copy size		3-1/2" x 5-1/2" to 8-1/2" x 14" ^{*1}	
Image loss		Max. 5/32" ^{*2} Max. 11/64" ^{*3} Max. 15/64" ^{*4}	
Copy speed		15 pages/min.	
Continuous copying		Max. 99 pages subtractive counter	
First-copy time (Approximately)		9.6 seconds (paper:A4, exposure mode:AUTO, copy ratio:100%)	
Copy ratio		Variable:25% to 400% in 1% increments (total 376 steps) Fixed: 25%, 64% 78%, 100%, 129%, 400%	
Exposure system	Original table	Moving optical source, slit exposure (stationary platen) with automatic exposure	
	RSPF	—	Moving original
Fusing system		Heat rollers	
Development system		Magnetic brush development	
Light source		Cold cathode fluorescent lamp	
Resolution		600 x 300dpi (Auto/Manual mode) 600 x 600dpi (Photo mode)	
Gradation		2 levels	
Bit depth		1 bit or 8 bit/pixel	
Sensor		Color CCD	
Memory		8 MB	16 MB
Power supply		AC 120V (±10%), 60 Hz (±2%)	
Power consumption		1000 W	
Overall dimensions	Width	31.9"	31.9"
	Depth	19.4"	19.4"
Weight (Approximately) ^{*5}		35.3 lbs.	50.7 lbs.

Model		AR-153E	AR-157E
Unit dimensions	Width	20.4"	20.4"
	Depth	19.4"	19.4"
	Height	11.6"	18.3"
Operating conditions		Temperature: 50°F to 86°F Humidity: 20% to 85%	
Noise level		Sound Power Level L _{WA} (1B=10dB) Copying: 6.0 [B], Standby: 3.7 [B] Sound Pressure Level L _{pA} (bystander positions) Copying: 46 [dB (A)], Standby: 23 [dB (A)] Noise emission measurement in accordance with ISO 7779.	
Emission concentration (measurement according to RAL-UZ 62)		Ozone: less than 0.02 mg/m ³ Dust: less than 0.075 mg/m ³ Styrene: less than 0.07 mg/m ³	
Optional equipment		Printer/Scanner Expansion Kit (AR-PG2) 250-sheet paper feed unit (AR-D16) Single pass feeder (AR-SP5)	

*1 Feed paper lengthwise only.

*2 Leading and trailing edges.

*3 Along the other edges in totals.

*4 The trailing edge of the second (Two-side copy mode).

*5 Not includes Toner cartridge.

Optional equipment

Printer/Scanner Expansion Kit (AR-PG2)

Printing system	Dry, electrostatic transfer	
Printing size	3-1/2" x 5-1/2" to 8-1/2" x 14" * ¹	
Print speed	Max. 12 pages/min. (Letter or A4)	
Continuous printing	Max. 99 pages subtractive counter	
First-print time (Approximately)	9.6 seconds (Paper: A4) * ²	
Resolution	Printer	600 dpi
	Scanner	600 x 1200 dpi
Emulation	SHARP GDI	
Page orientation	Portrait or landscape	
Interface port	USB interface (USB1.1 Standard) / IEEE1284-compliant bi-directional parallel interface (Only for printer)	

*¹ Feed paper lengthwise only.

*² Data transmission time is not included.

Single pass feeder (AR-SP5)

Acceptable originals	Weight: 14lbs. to 23.9 lbs. Size: 5-1/2" x 8-1/2" to 8-1/2" x 14" Capacity: Up to 30 sheets
Power supply	Drawn from the unit.
Weight	Approx.6.6 lbs.
Dimensions	19.6" (W) x15.0" (D) x 4.3" (H)

250-sheet paper feed unit (AR-D16)

Paper size	5-1/2" x 8-1/2" to 8-1/2" x 14"
Paper weight	15 lbs. to 21 lbs.
Paper capacity	One paper tray with capacity for 250 sheets of 21 lbs. bond paper
Weight	6.6 lbs.
Dimensions	19.6" (W) x 15.6" (D) x 3.5" (H)
Power supply	Drawn from the unit



Note

As a part of our policy of continuous improvement, SHARP reserves the right to make design and specification changes for product improvement without prior notice. The performance specification figures indicated are nominal values of production units. There may be some deviations from these values in individual units.

INDEX

2

250-Sheet paper feed unit 39

A

Acrobat Reader 65

Alarm indicator

- Developer replacement required indicator 6, 31, 37
- Maintenance indicator 6, 31, 37
- Misfeed indicator 6, 31, 32
- Toner cartridge replacement required indicator 6, 25, 31

Appendix 69

Auto clear time 23

Auto power shut-off mode 23

Automatic exposure adjustment 17

B

Before installation 41

Button Manager 40, 56

Bypass feed 10

Bypass paper guides 5, 10

C

Cautions

- Handling 2
- Label 1
- Using 1

Charger cleaner 5, 29

Cleaning the unit

- Cabinet 28
- Original cover 28
- Original table 28
- RSPF/SPF 28
- RSPF/SPF Scanning widow 28
- Transfer charger 29

Clear key 6, 16, 24

Connecting the interface cable

- parallel interface cable 68
- USB interface cable 67

Conventions used in the manual 4

Copy flow 12

Copy quantity 16

Copy quantity key 6, 16, 23

Copy ratio display key 6, 18

Copy ratio selector indicator 6, 18

Copy ratio selector key 6, 18

D

Dark key 6, 16

Developer replacement required

indicator 6, 31, 37

Developer required 37

Display 6

Displaying total number of copies 24

E

Exposure adjustment 16

Exposure mode indicator 6, 16

Exposure mode selector key 6, 16

F

Flow of installation 42

Front cover 5

Fusing unit release lever 5

H

Handle 5

Hardware and software

requirements 41

How to print 54

How to use the online manual 64

I

Indicators on the operation panel 53

Initial settings of operation panel 13

Installing the software 40, 43

Interface

- Parallel interface 68
- USB interface 67

Interrupt copying 55

Introduction 4

L

Light and dark indicator 6, 16

Light key 6, 16

Loading paper 7

Loading the paper tray 8

M		
Maintenance indicator	6, 31, 37	
Making copies	12	
MFP driver		
- Print Status Window	40	
- Printer driver	40	
- Scanner driver	40	
Misfeed indicator	6, 31, 32	
Misfeed removal		
- Fusing area	33	
- Lower paper feed area	35	
- Paper feed area	33	
- RSPF/SPF	35	
- Transport area	34	
Multi-bypass tray	10	
N		
Name		
- Operation panel	6	
- Part names	5	
O		
ONLINE indicator	6, 53	
ONLINE key	6, 53	
Online manual	64	
Opening the printer driver	54	
Opening the scanner driver	61	
Operation panel	5, 6	
Optional equipment	38	
Original placement		
- Original table	14	
- RSPF/SPF	15	
Original table	5, 14	
Original to copy indicator	6	
Original to copy key	6, 21	
P		
Paper	7	
Paper feed location indicator	6	
Paper output tray	5	
Paper output tray extension	5, 12	
Paper tray	5, 8	
Parallel interface cable	67, 68	
Photo copying	16	
Photoconductive drum	5, 33, 34	
Power cord	5	
Power off	14	
Power on	13	
Power save indicator	6, 53	
Power switch	5, 13	
Preheat mode	23	
Printer driver	40	
Proper storage for supplies	2	
R		
Reduction/enlargement/zoom	18	
RSPF/SPF	15	
RSPF/SPF indicator	6, 15	
RSPF/SPF misfeed indicator	6, 35	
S		
Scanner driver	40	
Scanner indicator	6, 53	
SCANNER key	6, 60	
Scanning from your computer	61	
Scanning with the "Scanner and Camera Wizard"	63	
Sharpdesk	40	
Side cover	5	
Side cover open button	5	
Software for the SHARP Personal MFP series	40	
Specifications	69	
Start indicator	6, 53	
Start key	6, 12, 24	
Status indicators	31	
Stream feeding mode	15, 22, 23	
System configuration	38	
T		
Toner cartridge	5, 25	
Toner cartridge replacement	25	
Toner cartridge replacement required indicator	6, 25, 31	
Transfer charger	5, 29	
Tray select key	6, 19	
Troubleshooting	30	
Troubleshooting the unit	30	
U		
USB interface cable	67	
Using other installed drivers	66	
Using the manual	4	
Using the printer mode	54	
Using the scanner mode	56	
Using the SHARP TWAIN	61	

Z

ZOOM indicator	6, 18
ZOOM key	6, 18

INDEX BY PURPOSE

Cleaning the unit		Removing paper jams	
- Cabinet	28	- Fusing area	33
- Original cover	28	- Lower paper feed area	35
- Original table	28	- Paper feed area.....	33
- RSPF/SPF.....	28	- RSPF/SPF.....	35
- Transfer changer	29	- Transport area.....	34
Connecting the interface cable		Replacing the toner cartridge	25
- Parallel interface cable.....	68	Scanning	
- USB interface cable.....	67	- Button Manager.....	56
Copying	12	- Scanner and Camera Wizard.....	63
Displaying total number of copies.....	24	- SHARP TWAIN	61
Enlarging/reducing copies	18	Selecting the tray.....	19
Installing the software		Setting the copy quality	
- Acrobat	65	- AUTO	17
- Button Manager.....	40	- MANUAL	16
- MFP driver.....	40	- PHOTO.....	16
- Sharpdesk	40	Setting the copy quantity	16
Loading paper		Setting the toner save mode	22
- Multi-bypass tray	10	Setting the user program.....	23
- Paper tray.....	8	Setting up the Button Manager.....	56
Loading the original		Storing the supplies.....	2
- Original table	14	Using other installed drivers.....	66
- RSPF/SPF.....	15	Using the online manual.....	64
Opening the printer driver.....	54		
Power off	14		
Power on	13		
Printing	54		

SOFTWARE LICENSE

PLEASE READ THIS LICENSE CAREFULLY BEFORE USING THE SOFTWARE. BY USING THE SOFTWARE, YOU ARE AGREEING TO BE BOUND BY THE TERMS OF THIS LICENSE.

1. License.

The application, demonstration, system and other software accompanying this License, whether on disk, in read only memory, or on any other media (the "Software") and related documentation are licensed to you by SHARP. You own the disk on which the Software is recorded but SHARP and/or SHARP'S Licensors retain title to the Software and related documentation. This License allows you to use the Software on one or more computers connected to a single printer and make one copy of the Software in machine-readable form for backup purposes only. You must reproduce on such copy the SHARP copyright notice, the copyright notice of SHARP'S Licensors and any other proprietary legends of SHARP and/or its Licensors that were on the original copy of the Software. You may also transfer all your license rights in the software, the backup copy of the Software, the related documentation and a copy of this License to another party, provided the other party reads and agrees to the terms and conditions of this License.

2. Restrictions.

The Software contains copyrighted material, trade secrets and other proprietary material which is owned by SHARP and/or its Licensors and in order to protect them you may not decompile, reverse engineer, disassemble or otherwise reduce the Software to a human-perceivable form. You may not modify, network, rent, lease, loan, distribute or create derivative works based upon the Software in whole or in part. You may not electronically transmit the Software from one computer to another or over a network.

3. Termination.

This license is effective until terminated. You may terminate this License at any time by destroying the Software and related documentation and all copies thereof. This License will terminate immediately without notice from SHARP and/or SHARP'S Licensors if you fail to comply with any provision of this License. Upon termination you must destroy the Software and related documentation and all copies thereof.

4. Export Law Assurances.

You agree and certify that neither the Software nor any other technical data received from SHARP, nor the direct product thereof, will be exported outside the United States except as authorized and as permitted by the laws and regulations of the United States. If the Software has been rightfully obtained by you outside of the United States, you agree that you will not re-export the Software nor any other technical data received from SHARP, nor the direct product thereof, except as permitted by the laws and regulations of the United States and the laws and the regulation of the jurisdiction in which you obtained the Software.

5. Government End Users.

If you are acquiring the Software on behalf of any unit or agency of the United States Government, the following provisions apply. The Government agrees:

- (i) if the Software is supplied to the Department of Defense (DoD), the Software is classified as "Commercial Computer Software" and the Government is acquiring only "restricted rights" in the Software and its documentation as that term is defined in Clause 252.227-7013 (c)(1) of the DFARS; and
- (ii) if the Software is supplied to any unit or agency of the United States Government other than DoD, the Government's rights in the Software and its documentation will be as defined in Clause 52.227-19 (c)(2) of the FAR or, in the case of NASA, in Clause 18-52.227-86 (d) of the NASA Supplement to the FAR.

6. Limited Warranty on Media.

SHARP warrants the disks on which the Software is recorded to be free from defects in materials and workmanship under normal use for a period of ninety (90) days from the date of purchase as evidenced by a copy of the receipt. The entire liability of SHARP and/or its Licensors and your exclusive remedy will be replacement of the disk which fails to meet the limited warranty provided by this Clause 6. A disk will be replaced when it is returned to SHARP or a SHARP authorized representative with a copy of the receipt. SHARP will have no responsibility to replace a disk damaged by accident, abuse or misapplication.

ANY IMPLIED WARRANTIES ON THE DISKS, INCLUDING THE IMPLIED WARRANTIES OF MERCHANTABILITY AND FITNESS FOR A PARTICULAR PURPOSE, ARE LIMITED IN DURATION TO NINETY (90) DAYS FROM THE DATE OF DELIVERY. THIS WARRANTY GIVES YOU SPECIFIC LEGAL RIGHTS, AND YOU MAY ALSO HAVE OTHER RIGHTS WHICH VARY FROM JURISDICTION TO JURISDICTION.

7. Disclaimer of Warranty on Software.

You expressly acknowledge and agree that use of the Software is at your sole risk. The software and related documentation are provided "AS IS" and without warranty of any kind and SHARP and SHARP'S Licensor(s) (for the purpose of provisions 7 and 8, SHARP and SHARP'S Licensor(s) shall be collectively referred to as "SHARP") EXPRESSLY DISCLAIM ALL WARRANTIES, EXPRESS OR IMPLIED, INCLUDING, BUT NOT LIMITED TO, THE IMPLIED WARRANTIES OF MERCHANTABILITY AND FITNESS FOR A PARTICULAR PURPOSE. SHARP DOES NOT WARRANT THAT THE FUNCTIONS CONTAINED IN THE SOFTWARE WILL MEET YOUR REQUIREMENTS, OR THAT THE OPERATION OF THE SOFTWARE WILL BE UNINTERRUPTED OR ERROR-FREE, OR THAT DEFECTS IN THE SOFTWARE WILL BE CORRECTED. FURTHERMORE, SHARP DOES NOT WARRANT OR MAKE ANY REPRESENTATIONS REGARDING THE USE OR THE RESULTS OF THE USE OF THE SOFTWARE OR RELATED DOCUMENTATION IN TERMS OF THEIR CORRECTNESS, ACCURACY, RELIABILITY, OR OTHERWISE. NO ORAL OR WRITTEN INFORMATION OR ADVICE GIVEN BY SHARP OR A SHARP AUTHORIZED REPRESENTATIVE SHALL CREATE A WARRANTY OR IN ANY WAY INCREASE THE SCOPE OF THIS WARRANTY. SHOULD THE SOFTWARE PROVE DEFECTIVE, YOU (AND NOT SHARP OR A SHARP AUTHORIZED REPRESENTATIVE) ASSUME THE ENTIRE COST OF ALL NECESSARY SERVICING, REPAIR OR CORRECTION, SOME JURISDICTIONS DO NOT ALLOW THE EXCLUSION OF IMPLIED WARRANTIES, SO THE ABOVE EXCLUSION MAY NOT APPLY TO YOU.

8. Limitation of Liability.

UNDER NO CIRCUMSTANCES INCLUDING NEGLIGENCE, SHALL SHARP BE LIABLE FOR ANY INCIDENTAL, SPECIAL OR CONSEQUENTIAL DAMAGES THAT RESULT FROM THE USE OR INABILITY TO USE THE SOFTWARE OR RELATED DOCUMENTATION, EVEN IF SHARP OR A SHARP AUTHORIZED REPRESENTATIVE HAS BEEN ADVISED OF THE POSSIBILITY OF SUCH DAMAGES. SOME JURISDICTIONS DO NOT ALLOW THE LIMITATION OR EXCLUSION OF LIABILITY FOR INCIDENTAL OR CONSEQUENTIAL DAMAGES SO THE ABOVE LIMITATION OR EXCLUSION MAY NOT APPLY TO YOU.

In no event shall SHARP'S total liability to you for all damages, losses, and causes of action (whether in contract, tort (including negligence) or otherwise) exceed the amount paid by you for the Software.

9. Controlling Law and Severability.

For a portion of the Software related with Apple Macintosh and Microsoft Windows, this license shall be governed by and construed in accordance with the laws of the state of California and Washington, respectively. If for any reason a court of competent jurisdiction finds any provision of this License, or portion thereof, to be unenforceable, that provision of the License shall be enforced to the maximum extent permissible so as to effect the intent of the parties, and the remainder of this License shall continue in full force and effect.

10. Complete Agreement.

This License constitutes the entire agreement between the parties with respect to the use of the Software and related documentation, and supersedes all prior or contemporaneous understandings or agreements, written or oral, regarding such subject matter. No amendment to or modification of this License will be binding unless in writing and signed by a duly authorized representative of SHARP.

MATERIAL SAFETY DATA SHEET

MSDS No. F-01001

Section 1. Product Identification

Product:

AR-152NT/T/FT/ST (Black Toner)

Section 2. Supplier's Name and Address

Sharp Corporation

22-22 Nagaïke-cho, Abeno-ku, Osaka, Japan

Local suppliers are listed below. Please contact the nearest supplier for additional information.

(Country)	(Name and Telephone Number)
U.S.A.	Sharp Electronics Corporation Telephone number for information: 1-800-237-4277 Emergency telephone number: 1-800-255-3924
Canada	Sharp Electronics of Canada Ltd. Telephone number for information: 905-890-2100 Emergency telephone number: 1-800-255-3924
United Kingdom	Sharp Electronics (U.K.) Ltd. Telephone number for information: 01923-474013

Section 3. Ingredients

Ingredients	CAS No.	Proportion	OSHA PEL	ACGIH TLV	Other Limits
Styrene-Acrylate copolymer	29497-14-1	> 88 %	Not listed	Not listed	None
Carbon black	1333-86-4	< 6.0%	3.5mg/m ³	3.5mg/m ³	None
Iron oxide	1309-38-2	< 4.5%	Not listed	Not listed	None
Metal Complex dye	109125-51-1	< 1.5%	0.5mg/m ³	0.5mg/m ³	None
	109125-50-0				
	84179-66-8				

Section 4. Hazardous Identification (Emergency Overview)

Toner is a fine, black powder possessing no immediate hazard. There are no anticipated carcinogenic effects from exposure based on animal tests performed using toner. When used as intended according to instructions, studies do not indicate any symptoms of fibrosis will occur.

Section 5. Health Hazard Data

Route(s) of Entry:	Inhalation?	Skin?	Ingestion?
	Yes	No	Possible but very unusual.
Health Hazards:	Acute oral toxicity ----- LDLo of this toner is over 2,000mg/kg.		
	Mutagenicity ----- The result of Ames test is negative.		
Carcinogenicity:	In 1996 the IARC reevaluated carbon black as a Group 2B carcinogen (possible human carcinogen). This classification is given to chemicals for which there is inadequate human evidence, but sufficient animal evidence on which to base an opinion of carcinogenicity. The classification is based upon the development of lung tumors in rats receiving chronic inhalation exposures to free carbon black at levels that induce particle overload of the lung. Studies performed in animal models other than rats did not show any association between carbon black and lung tumors. Moreover, a two-year cancer bioassay using a typical toner preparation containing carbon black demonstrated no association between toner exposure and tumor development in rats.		
Chronic Effect:	In a study in rats of chronic inhalation exposure to a typical toner, a mild to moderate degree of lung fibrosis was observed in 92% of the rats in the high concentration (16mg/m ³) exposure group, and a minimal to mild degree of fibrosis was noted in 22% of the animals in the middle (4mg/m ³) exposure group, but no pulmonary change was reported in the lowest (1mg/m ³) exposure group, the most relevant level to potential human exposures.		
Signs and Symptoms of Exposure:	Minimal irritation to respiratory tract may occur as with exposure to any non-toxic dust.		
Medical Conditions Generally Aggravated by Exposure:	None		
Emergency and First Aid Procedures:			
	Inhalation;	Remove to fresh air. If effects occur, consult medical personnel.	
	Eye;	In case of contact, immediately flush eyes with water for 15 minutes.	

Section 6. Physical Chemical Characteristics

Boiling / Melting Point:	Not applicable	Specific Gravity:	1.1
Vapor Pressure:	Not applicable	Solubility in Water:	Negligible
Vapor Density:	Not applicable	PH:	Not applicable
Evaporation Rate:	Not applicable	Viscosity:	Not applicable
Appearance:	Fine powder	Color:	Black
Odor:	Odorless		

Section 7. Fire and Explosion Data

Flash Point (Method Used):	Not applicable
Ignition Temperature:	>350°C
Flammable Limits:	(LEL); Not applicable (UEL); Not applicable
Extinguishing Media:	CO ₂ , dry chemical, foam or water
Special Fire Fighting Procedure:	None
Unusual Fire and Explosion Hazard:	This material has no unusual fire or explosion hazards.
Sensitivity to Mechanical Impact:	None
Sensitivity to Static Charge:	None

Section 8. Reactivity Data

Stability:	Stable
Incompatibility (Material to Avoid):	None
Hazardous Decomposition:	CO and NO _x
Hazardous Polymerization:	Will not occur.

Section 9. Precautions for Safe Handling and Use

Personal Protection Information (Respiratory, Eye Protection and Protective Glove):

Use of a dust mask is recommended when handling a large quantity of toner or during long term exposure, as with any non-toxic dust.

Engineering Control / Ventilation:	Not required.
Work / Hygienic Practice:	Inhalation should be minimized as with any non-toxic dust.
Steps to be taken in case of Spill or Leak:	Sweep up or clean up with vacuum cleaner.
Waste Disposal Method:	Waste material may be dumped or incinerated under conditions which meet all federal, state and local environmental regulations.

Section 10. Regulatory Information

NFPA Rating (U.S.A.):	Health = 1	Flammability = 1	Reactivity = 0
WHMIS Legislation (Canada):	This product is not a controlled product.		
Transport Information:	This product is not a hazardous material.		
UN No.:	None allocated.		

Section 11. Other Information

References: IARC (1996) IARC Monographs on the Evaluation of the Carcinogenic Risk of Chemicals to Humans, Vol. 65, Printing Process and Printing inks, Carbon Black and Some Nitro Compounds, Lyon, pp-149-261
H. Muhle, B. Bellmann, O. Creutzenberg, C. Dasenbrock, H. Ernst, R. Kilpper, J. C. MacKenzie, P. Morrow, U. Mohr, S. Takenaka, and R. Mermelstein (1991) Pulmonary Response to Toner upon Chronic Inhalation Exposure in Rats. Fundamental and Applied Toxicology 17, pp. 280-299

MATERIAL SAFETY DATA SHEET

MSDS No. F-31001

Section 1. Product Identification

Product

AR-152ND/DV/SD (Black Developer)

Section 2. Supplier's Name and Address

Sharp Corporation

22-22 Nagaïke-cho, Abeno-ku, Osaka, Japan

Local suppliers are listed below. Please contact the nearest supplier for additional information.

(Country)	(Name and Telephone Number)
U.S.A.	Sharp Electronics Corporation Telephone number for information: 1-800-237-4277 Emergency telephone number: 1-800-255-3924
Canada	Sharp Electronics of Canada Ltd. Telephone number for information: 905-890-2100 Emergency telephone number: 1-800-255-3924
United Kingdom	Sharp Electronics (U.K.) Ltd. Telephone number for information: 01923-474013

Section 3. Ingredients

Ingredients	CAS No.	Proportion	OSHA PEL	ACGIH TLV	Other Limits
Iron powder	7439-89-6	> 92.5%	Not listed	Not listed	None
Styrene-Acrylate copolymer	29497-14-1	< 7.0%	Not listed	Not listed	None
Carbon black	1333-86-4	< 0.5%	3.5mg/m ³	3.5mg/m ³	None

Section 4. Hazardous Identification (Emergency Overview)

Developer is a black powder containing small amounts of toner, and possessing no immediate hazard. There are no anticipated carcinogenic effects from exposure based on animal tests performed using toner.

Section 5. Health Hazard Data

Route(s) of Entry:	<u>Inhalation?</u>	<u>Skin?</u>	<u>Ingestion?</u>
	No	No	Possible but very unusual.
Health Hazards:	Acute oral toxicity -----	LDLo of this toner which is included in this developer is over 2,000mg/kg.	
	Mutagenicity -----	The toner, which is included in this developer, has been tested on Ames test. The result is negative.	
Carcinogenicity:	In 1996 the IARC reevaluated carbon black as a Group 2B carcinogen (possible human carcinogen). This classification is given to chemicals for which there is inadequate human evidence, but sufficient animal evidence on which to base an opinion of carcinogenicity. The classification is based upon the development of lung tumors in rats receiving chronic inhalation exposures to free carbon black at levels that induce particle overload of the lung. Studies performed in animal models other than rats did not show any association between carbon black and lung tumors. While there have been no studies to date using developer, a two-year cancer bioassay using a typical toner preparation containing carbon black (a small amount of toner is included in the developer mixture) demonstrated no association between toner exposure and tumor development in rats.		
Signs and Symptoms of Exposure:	Minimal irritation to respiratory tract may occur as with exposure to any non-toxic dust.		
Medical Conditions Generally Aggravated by Exposure:	None		
Emergency and First Aid Procedures:			
	Inhalation;	Remove to fresh air. If effects occur, consult medical personnel.	
	Eye;	In case of contact, immediately flush eyes with water for 15 minutes.	

Section 6. Physical Chemical Characteristics

Boiling / Melting Point:	Not applicable	Specific Gravity:	about 7.3
Vapor Pressure:	Not applicable	Solubility in Water:	Negligible
Vapor Density:	Not applicable	PH:	Not applicable
Evaporation Rate:	Not applicable	Viscosity:	Not applicable
Appearance:	Fine powder	Color:	Black
Odor:	Odorless		

Section 7. Fire and Explosion Data

Flash Point (Method Used):	Not applicable
Ignition Temperature:	>350°C
Flammable Limits:	(LEL); Not applicable (UEL); Not applicable
Extinguishing Media:	CO ₂ , dry chemical, foam or water
Special Fire Fighting Procedure:	None
Unusual Fire and Explosion Hazard:	This material has no unusual fire or explosion hazards.
Sensitivity to Mechanical Impact:	None
Sensitivity to Static Charge:	None

Section 8. Reactivity Data

Stability:	Stable
Incompatibility (Material to Avoid):	None
Hazardous Decomposition:	CO and NO _x
Hazardous Polymerization:	Will not occur.

Section 9. Precautions for Safe Handling and Use

Personal Protection Information (Respiratory, Eye Protection and Protective Glove):	None required under normal use.
Engineering Control / Ventilation:	Not required.
Work / Hygienic Practice:	Not required.
Steps to be taken in case of Spill or Leak:	Sweep up or clean up with vacuum cleaner.
Waste Disposal Method:	Waste material may be dumped or incinerated under conditions which meet all federal, state and local environmental regulations.

Section 10. Regulatory Information

NFPA Rating (U.S.A.):	Health = 1	Flammability = 1	Reactivity = 0
WHMIS Legislation (Canada):	This product is not a controlled product.		
Transport Information:	This product is not a hazardous material.		
UN No.:	None allocated.		

Section 11. Other Information

References: IARC (1996) IARC Monographs on the Evaluation of the Carcinogenic Risk of Chemicals to Humans, Vol. 65, Printing Process and Printing inks, Carbon Black and Some Nitro Compounds, Lyon, pp-149-261
H. Muhle, B. Bellmann, O. Creutzenberg, C. Dasenbrock, H. Ernst, R. Kilpper, J. C. MacKenzie, P. Morrow, U. Mohr, S. Takenaka, and R. Mermelstein (1991) Pulmonary Response to Toner upon Chronic Inhalation Exposure in Rats. Fundamental and Applied Toxicology 17, pp. 280-299

For users in the USA

This device complies with Part 15 of the FCC rules. Operation is subject to the following two conditions: (1) This device may not cause harmful interference, and (2) this device must accept any interference received, including interference that may cause undesired operation.

WARNING:

FCC Regulations state that any unauthorized changes or modifications to this equipment not expressly approved by the manufacturer could void the user's authority to operate this equipment.

Note:

This equipment has been tested and found to comply with the limits for a Class B digital device, pursuant to Part 15 of the FCC Rules. These limits are designed to provide reasonable protection against harmful interference in a residential installation. This equipment generates, uses and can radiate radio frequency energy and, if not installed and used in accordance with the instructions, may cause harmful interference to radio communications.

However, there is no guarantee that interference will not occur in a particular installation. If this equipment does cause harmful interference to radio or television reception, which can be determined by turning the equipment off and on, the user is encouraged to try to correct the interference by one or more of the following measures:

- Reorient or relocate the receiving antenna.
- Increase the separation between the equipment and receiver.
- Connect the equipment into an outlet on a circuit different from that to which the receiver is connected.
- Consult the dealer or an experienced radio/TV technician for help.

NOTICE

BE SURE TO ASK YOUR AUTHORIZED SHARP DEALER ABOUT THE WARRANTY THAT YOUR SELLING DEALER EXTENDS TO YOU. In order to assure you, the end-user, of warranty protection, Sharp extends a limited warranty to each of its authorized dealers and, in turn, requires each of its authorized dealers to extend its own warranty to you on terms that are no less favorable than those given to the dealer by Sharp. You should be aware, however, that Sharp does not itself extend any warranties, either express or implied, directly to you, the end-user, and no one is authorized to make any representations or warranties on behalf of Sharp. Specifically, SHARP DOES NOT EXTEND TO YOU, THE END-USER, ANY EXPRESS WARRANTY OR ANY IMPLIED WARRANTY OF MERCHANTABILITY, FITNESS FOR USE OR FITNESS FOR ANY PARTICULAR PURPOSE IN CONNECTION WITH THE HARDWARE, SOFTWARE OR FIRMWARE EMBODIED IN, OR USED IN CONJUNCTION WITH THIS PRODUCT. Sharp is not responsible for any damages or loss, either direct, incidental or consequential, which you, the end-user, may experience as a result of your purchase or use of the hardware, software or firmware embodied in or used in conjunction with this Product. Your sole remedy, in the event that you encounter any difficulties with this Product, is against the authorized dealer from which you purchased the Product.

AR-153E Digital Laser Copier/Printer
AR-157E Digital Laser Copier/Printer

In the event that this authorized dealer does not honor its warranty commitments, please contact the General Manager, Business Products Group, Sharp Electronics Corporation, Sharp Plaza, Mahwah, NJ07430-2135, so that Sharp can try to help assure complete satisfaction of the warranty rights to which you are entitled from the authorized dealer.

This product utilizes tin-lead solder, and a fluorescent lamp containing a small amount of mercury.

Disposal of these materials may be regulated due to environmental considerations.

For disposal or recycling information, please contact your local authorities or the Electronics Industries Alliance: www.eia.org

SHARP®

SHARP ELECTRONICS CORPORATION

Sharp Plaza, Mahwah, New Jersey 07430-2135.

www.sharp-usa.com

SHARP®

AR-153E/157E

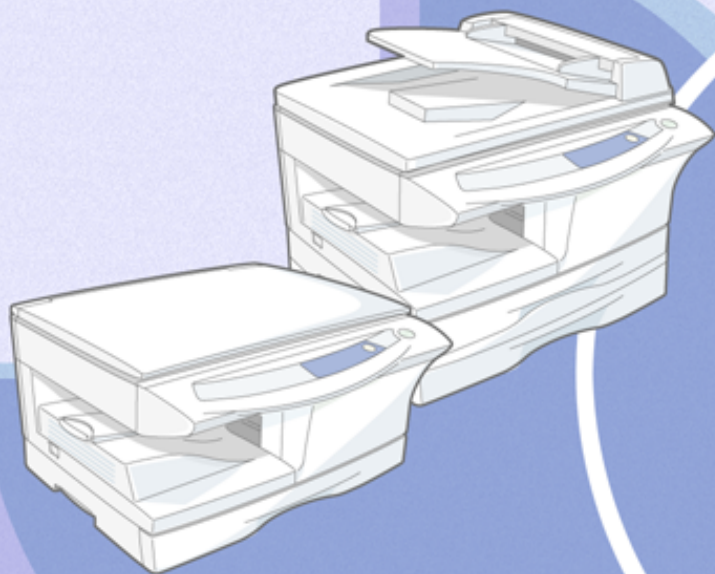

Online Manual

Start

Contents

1 How to Use the Online Manual

How to Use the Online Manual	1
------------------------------	---

2 Print

Printing Overview	2
Basic Printing	3
Starting the Printer Driver Using the "Start" Button	4
Printer Driver Settings	5
Printing a Watermark	6
Fitting the Printed Image to the Paper	7
Printing Multiple Pages on One Page	8
Two-sided Printing (AR-157E only)	9
Outline of the Print Status Window	10

3 Scan

Scanning Overview	11
Scanning an Image from a TWAIN-Compliant Application	12
Scanning an Image from a WIA-Compliant Application (Windows XP)	16
Scanning an Image from the "Scanner and Camera Wizard" (Windows XP)	18
Outline of Button Manager	21
Button Manager Settings	22

4 Troubleshooting

Identifying Unit Problems	23
Check the Connection between the Unit and Computer	24
Check Your Computer	25
Plug and Play Screen does not Appear (when the USB is connected)	26
Failed to Install the MFP Driver (Windows 2000/XP)	27
Faint, Uneven or Smearred Print Output	28
Characters or Graphics are not Printed in Correct Position	29
Nothing Prints	30
Poor Scanning Result	31
The Scanned Image is Incorrectly Positioned	32
Unable to Scan the Image	33
Uninstalling SHARP Personal MFP Series Software	34

5 Index

1 How to Use the Online Manual

This Online Manual provides instruction for the operation of your new unit. Please read the following explanation of how to use the Online Manual, and then search for the information that you need.

For more information about computers, operating systems and Acrobat Reader, please refer to the relevant manual or help file.

How to Control the Online Manual

Click this button to display the Table of Contents of the Online Manual. From the Table of Contents you can jump to various pages.

Click this button to display the Index of the Online Manual. From the Index you can jump to various pages.





Takes you back page by page. To return to the previous link, click the (◀) button on the menu bar of the Acrobat Reader.

Takes you forward page by page.

Following links

Links can connect parts of a document to other parts for further information. In this document, green colored letters are linked areas.

To follow a link, select a hand tool () , a zoom tool or a selection tool. Position the pointer over the linked area on the page until the pointer changes to a hand with a pointing finger (). Then click the link.

Using Bookmarks

This online manual has Bookmarks on the main pages of each section. You can move to the desired pages by simply clicking its bookmark.

How to Print Out the Online Manual

In order to print out a hard copy of the Online Manual for your reference, go to Acrobat Reader, click the "File" menu, and select "Print". After specifying the printer setting, click the "Print" ("OK" on Windows 95/98/Me/NT 4.0) button to print.



Note

- In this online manual, screen images and operating procedures are mainly for Windows XP. With other versions of Windows, some screen images may be different from those in this manual.
- The screen illustrations shown in this online manual are mainly screens of AR-157E.

CONTENTS

INDEX

1

2 Printing Overview

The flow chart shown below provides printing overview.

Reference: For more information on printing, see [Basic Printing](#).



Caution

- *When the paper source is the paper tray or multi-bypass tray, verify that the paper has been loaded before starting printing.*
- *Ensure printing has been completed before turning the power off. Do not remove the power cord before turning the unit off.*

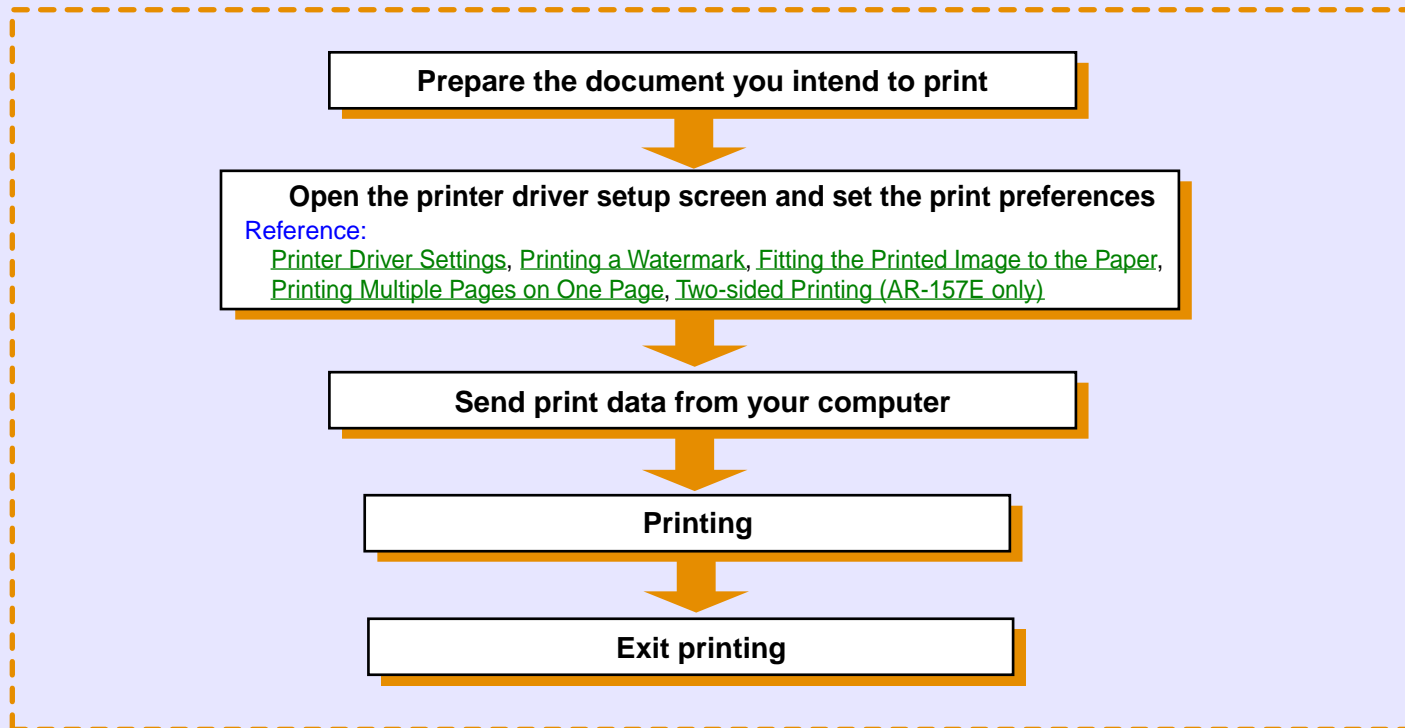

2 Basic Printing

This is a printing example using WordPad to print a document onto letter size paper.

1 Start WordPad, make a new file, and enter the text you intend to print.

2 Select "Print" from the application's "File" menu.

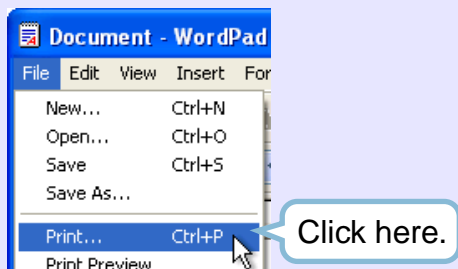

3 Make sure that "SHARP AR-XXXX" (where XXXX is the model name of your unit) is selected as the current printer. If you intend to change any print setting, click the "Preferences" button to open the printer driver setup screen.

On Windows 95/98/Me/NT 4.0, click the "Properties" button.

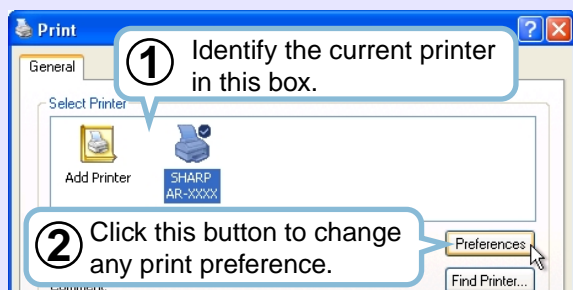

Reference: [Printer Driver Settings](#), [Printing a Watermark](#), [Fitting the Printed Image to the Paper](#), [Printing Multiple Pages on One Page](#), [Two-sided Printing \(AR-157E only\)](#)

4 Click the "Print" button in the "Print" dialog box. On Windows 95/98/Me/NT 4.0, click the "OK" button.

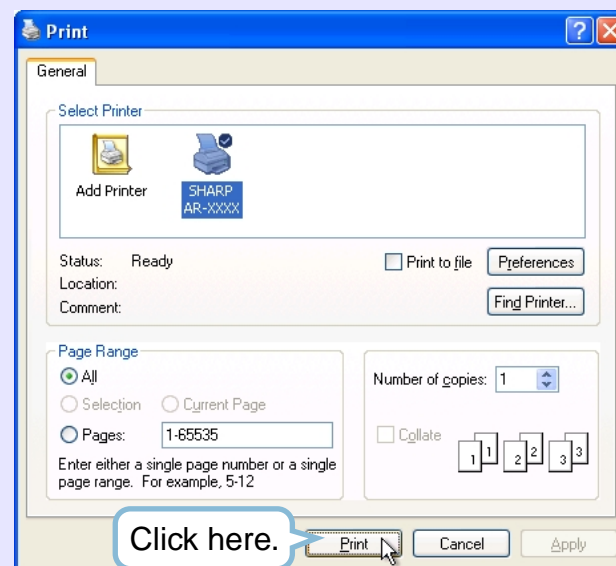

Printing starts according to your preferences.



Windows 2000 does not have the "Preferences" button on this dialog box. Switch to the desired tab by clicking it to specify printer settings.

CONTENTS

INDEX

3

2 Starting the Printer Driver Using the "Start" Button

You can open the printer driver and change the printer driver settings from the Windows "start" button. Settings adjusted in this way will be the initial settings when you print from an application. (If you change the settings from the printer driver setup screen at the time of printing, the settings will revert to the initial settings when you quit the application.)

Reference: [Basic Printing](#)

Windows 2000/XP

- 1 Click the "start" button, and then click "Control Panel".

On Windows 2000, click the "Start" button and select "Settings".

- 2 Click "Printers and Other Hardware", and then click "Printers and Faxes".

On Windows 2000, click "Printers".

- 3 Click the "SHARP AR-XXXX" (where XXXX is the model name of your unit) printer driver icon and select "Properties" from the "File" menu.

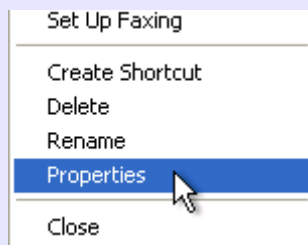

- 4 Click the "Printing Preferences" button in the "General" tab.

The printer driver setup screen will appear.

Reference: [Printer Driver Settings](#)

Windows 95/98/Me/NT 4.0

- 1 Click the "Start" button, select "Settings" and then click "Printers".

- 2 Click the "SHARP AR-XXXX" (where XXXX is the model name of your unit) printer driver icon and select "Properties" from the "File" menu.

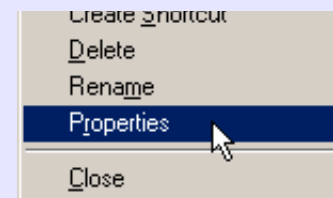

Note

On Windows NT 4.0, select "Document Defaults" to open the printer driver setup screen.

- 3 On Windows 95/98/Me, click the "Setup" tab.

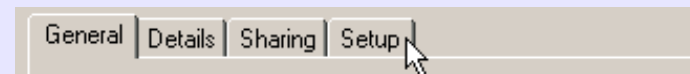

The printer driver setup screen will appear.

Reference: [Printer Driver Settings](#)

CONTENTS

INDEX

4

2 Printer Driver Settings

To view Help for a setting, click the (?) button in the upper right-hand corner of the window and then click the setting.



Note

The AR-157E printer driver setup screen is shown below. The settings and the image of the unit will vary depending on the model.

Tab

Index which allows you to switch between the various setup screens.

The settings you made at "N-Up Printing", "Document Style" (AR-157E only), "Fit To Paper Size", "Image Orientation" and "Watermark" are shown in this image.

Check button

Allows you to select one item from a list of options.

The tray selected in "Paper Selection" in the "Paper" tab appears in blue. You can also click on a tray to select it.

"OK" button

Click this button to save your settings, and exit the dialog box.

"Cancel" button

Click this button to exit the dialog box without making any changes to the settings.

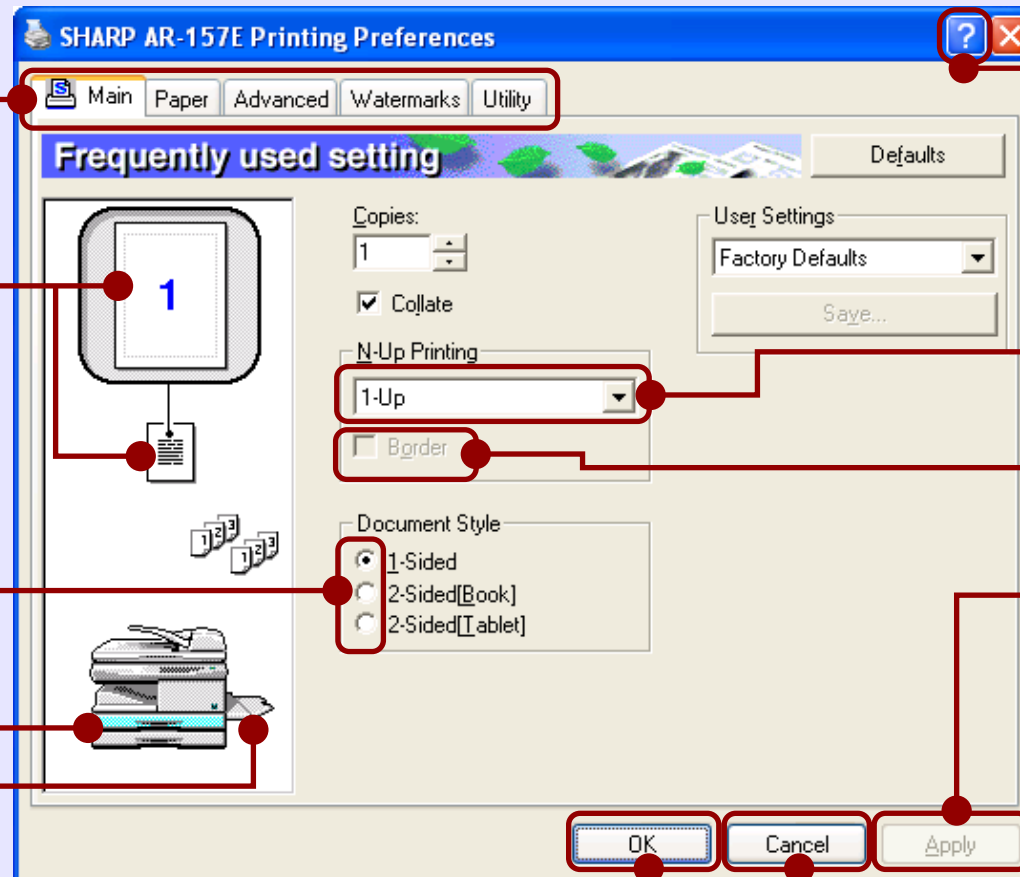

(?) button

Click this button and then click a setting to view Help for the setting.



Note

You can also view Help by right-clicking the setting with the mouse.

Drop-down list

Allows you to make one selection from a list of choices.

Check box

Click this option to activate/deactivate each function.

"Apply" button

Click to save your settings without closing the dialog box.



Note

- Windows NT 4.0 does not have the "Apply" button on each screen.
- The "Apply" button does not appear when you open this window from an application.

CONTENTS

INDEX

5

2 Printing a Watermark

To print a watermark, for example "CONFIDENTIAL", on your document, refer to the following steps. Open the printer driver and click the "Watermarks" tab.

Reference: See [Basic Printing](#) for details on how to open the printer driver.

How to Print a Watermark

From the "Watermark" drop-down list, select the watermark, for example "CONFIDENTIAL", you wish to print on your document, and start printing.

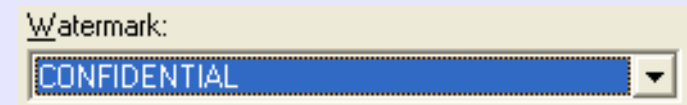
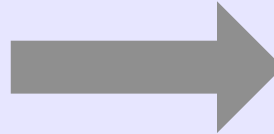
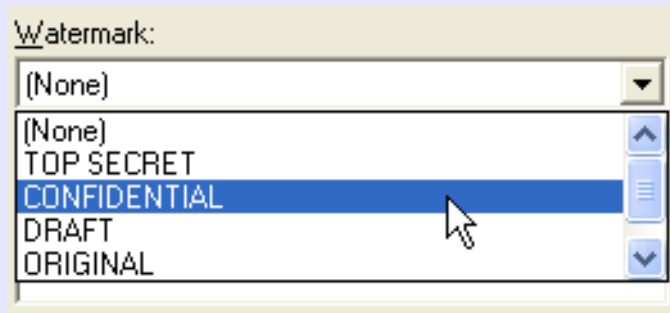

Print sample

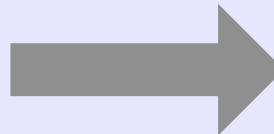

For details on watermark settings, view printer driver Help.

Reference: [Printer Driver Settings](#)

2 Fitting the Printed Image to the Paper

This printer driver can adjust the zoom ratio for printing according to the paper loaded in the unit. Follow the steps shown below to use this function. The instruction below assumes that you intend to print a Letter size document onto an Invoice size paper.



Note

The "Fit To Paper Size" setting is not available when "N-Up Printing" is selected.
Reference: [Printing Multiple Pages on One Page](#)

1 Click the "Paper" tab in the printer driver setup screen.

2 Select the paper size for the print data from "Paper Size".

3 Check the "Fit To Page" box.

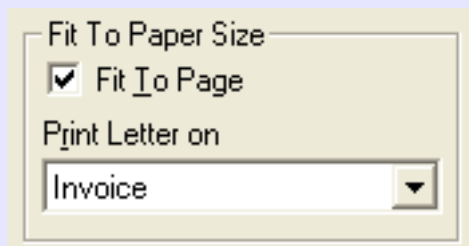

4 Select the paper size for "Fit To Paper Size", which corresponds to the size of paper in the unit.

Now, the printed image will automatically fit the paper set in the unit.

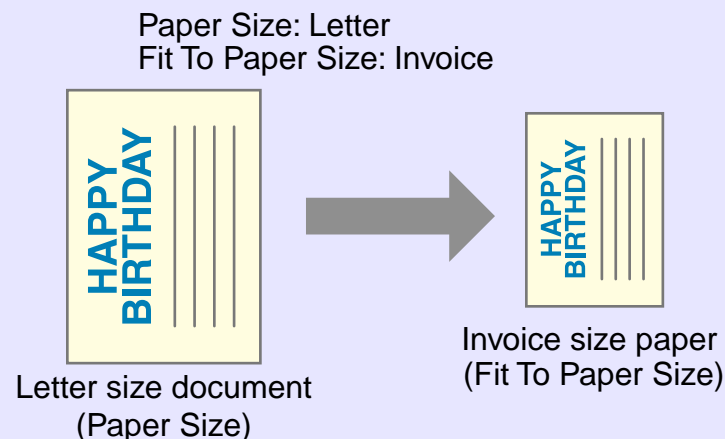

CONTENTS

INDEX

7

2 Printing Multiple Pages on One Page

This feature allows you to print two or four document pages onto a single page.

To use this function, open the printer driver setup screen, select "2-Up" or "4-Up" for "N-Up Printing" on the "Main" tab.



Note

The "N-Up Printing" setting is not available when "Fit To Paper Size" is selected.

Reference: [Fitting the Printed Image to the Paper](#)

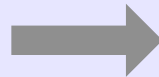
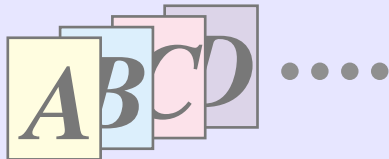
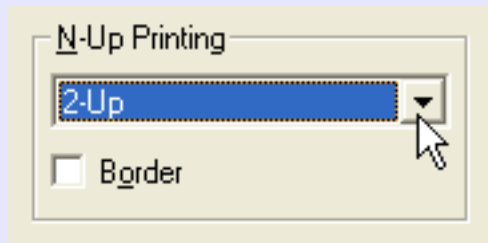

N-Up	<input type="checkbox"/> Border	<input checked="" type="checkbox"/> Border
"2-Up"		
"4-Up"		

If you select the "Border" checkbox, border lines will be printed on each page.

2 Two-sided Printing (AR-157E only)

You can print on both sides of the paper.

To use this function, open the printer driver setup screen and select "2-Sided (Book)" or "2-Sided (Tablet)" from "Document Style" in the "Main" tab.



Note

When using two-sided printing, select "Tray 1" or "Tray 2" for the "Paper Source" in the "Paper" tab.

The following example shows the result when portrait data is printed on both sides of the paper.

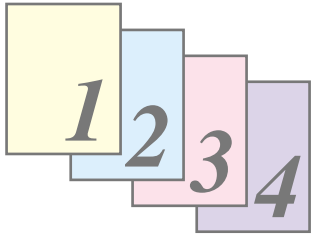
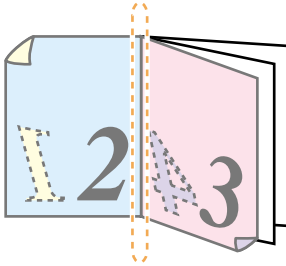
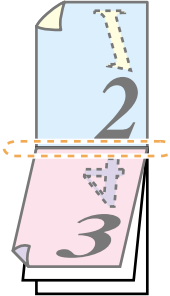
Print data	Printing result	
	2-Sided (Book)	2-Sided (Tablet)
	 <p>The pages are printed so that they can be bound at the side.</p>	 <p>The pages are printed so that they can be bound at the top.</p>

2 Outline of the Print Status Window

When printing begins, the Print Status Window activates and appears on the screen.

The Print Status Window is a program designed to show the current printer status including the document name being printed and error messages.

Status icon

This icon informs you of the print status.

Tab

Index which allows you to switch between the two setup screens.

"Close" button

Click this button to close the Print Status Window.

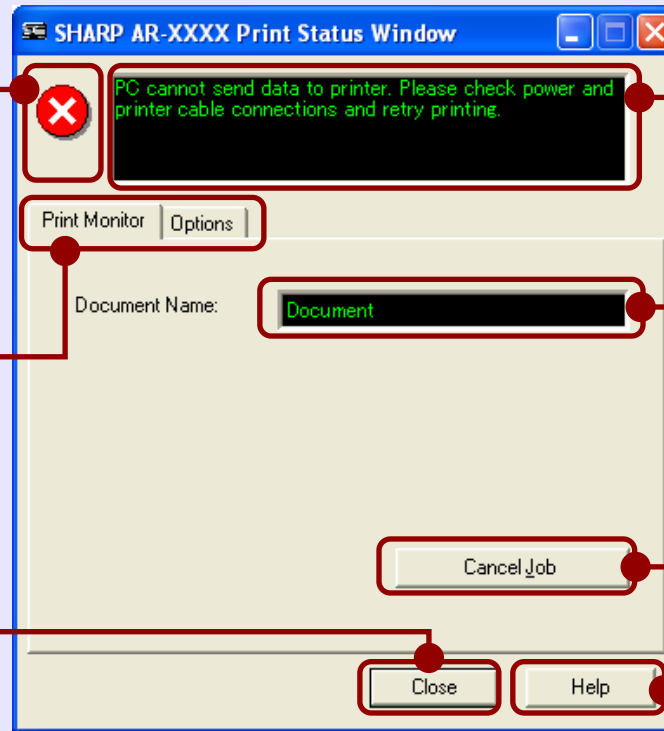

Status window

Provides details on the current status of the print job.

Document Name

Displays the name of the active print job.

"Cancel Job" button

Click this button during printing to cancel the job that is currently being executed.

"Help" button

Click this button to display help file for the Print Status Window.

3 Scanning Overview

The flow chart shown below provides scanning overview.



The environment in which the unit's scanning function can be used is subject to certain limitations. For details, see "BEFORE INSTALLATION" in the Operation Manual.

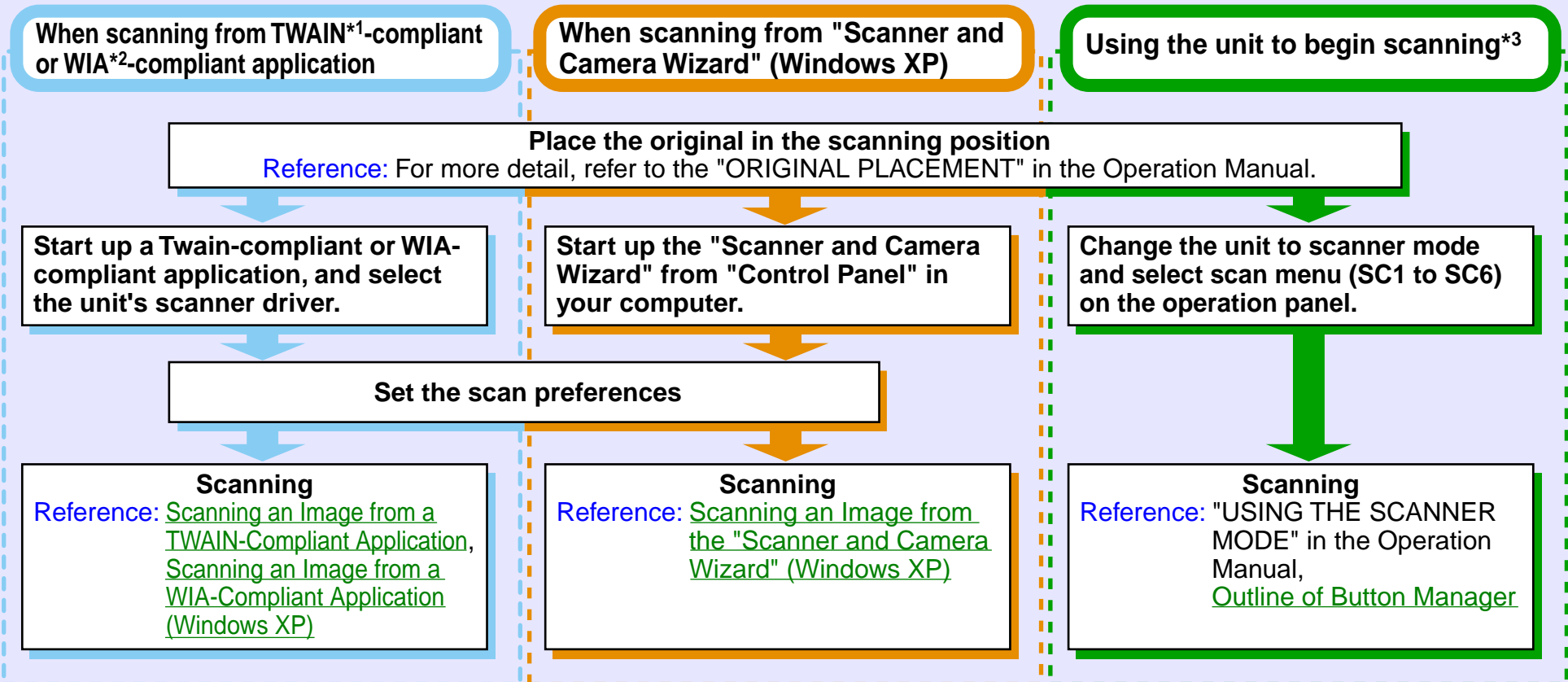

*1: TWAIN is an industry standard for interface of image data processing devices including scanners. By installing a TWAIN driver onto your computer, you can scan and work with images using a variety of TWAIN-compliant applications.

*2: WIA (Windows Imaging Acquisition) is a Windows function that allows a scanner, digital camera or other imaging device to communicate with an image processing application. The WIA driver for this unit can only be used in Windows XP.

*3: To scan using the unit's operation panel, you must first install Button Manager and establish the appropriate settings in the Control Panel. For details, see "USING THE SCANNER MODE" in the Operation Manual.

Note that not all scanner functions are available using Button Manager.

3 Scanning an Image from a TWAIN-Compliant Application (part 1)

The SHARP scanner driver conforms to TWAIN, the industry standard, making it compatible with a variety of TWAIN-compliant applications. Below is a step-by-step guide for acquiring a scanned image to the Sharpdesk desktop screen using Sharpdesk.

1 Place the original you wish to scan on the original table/RSPF/SPF.

Reference: For information on setting an original for scanning, refer to "ORIGINAL PLACEMENT" in the Operation Manual.

2 After starting Sharpdesk, click the "File" menu and select "Select Scanner".

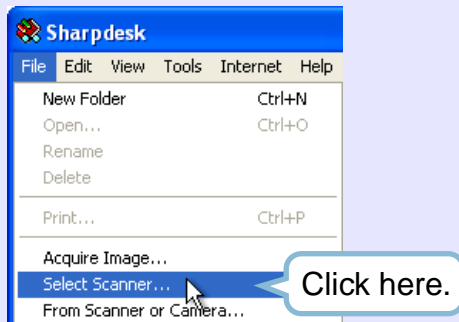

3 Select "SHARP Personal MFP series", and click the "Select" button.

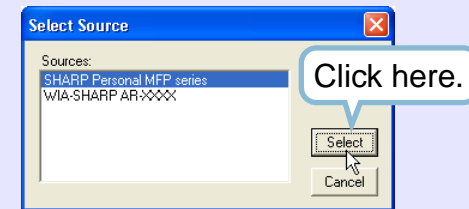

Note

- If you are using Windows XP, you can also select "WIA-SHARP AR-XXXX" (where XXXX is the model name of your unit) to scan using the WIA driver.

Reference: [Scanning an Image from a WIA-Compliant Application](#)

- Depending on your system, "SHARP Personal MFP series 1.0 (32-32)" and "WIA-SHARP AR-XXXX 1.0 (32-32)" (where XXXX is the model name of your unit) may appear in the "Select Source" screen.
- The method for accessing the "Select Scanner" option, depends upon the application. For more information, refer to the manual or the help file of your application.

3 Scanning an Image from a TWAIN-Compliant Application (part 2)

4 Select "Acquire Image" from the "File" menu, or click the "Acquire" button ().

The scanner driver setup screen will appear.

Reference: [Scanner Driver Settings](#)

5 In the "Scanning Position" menu, select the position in which you placed the original in Step 1 ("Platen" or "SPF").
Select "SPF" when you placed the original in the RSPF/SPF.

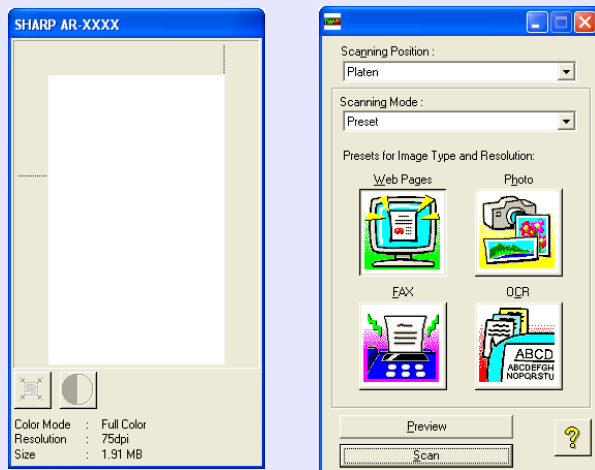

6 Click the "Preview" button.
The preview image will appear.



Note

- If the rotation or angle of the image is different, reset the original, and click the "Preview" button again.
- If you set multiple pages in the RSPF/SPF, the unit previews only the page placed on the top of the originals, and then sends it to the original exit area. Return the previewed page to the RSPF/SPF before starting the scanning job.

7 Specify the scanning area, and set the scan preferences.

For information on specifying the scan area and setting the scan preferences, see scanner driver Help.

Reference: [Scanner Driver Settings](#)



Caution

Setting a large area with full color together with a high resolution setting, makes the data size large, resulting in extended scanning times. It is recommended to set the scanning preferences depending on the type of the original to be scanned, i.e., Text, Text/Graphics, Photograph, Color, Black & White.

8 Click the "Scan" button after setting your preferences.
To cancel your scanning job after clicking the "Scan" button, press the [Esc] key on your keyboard.

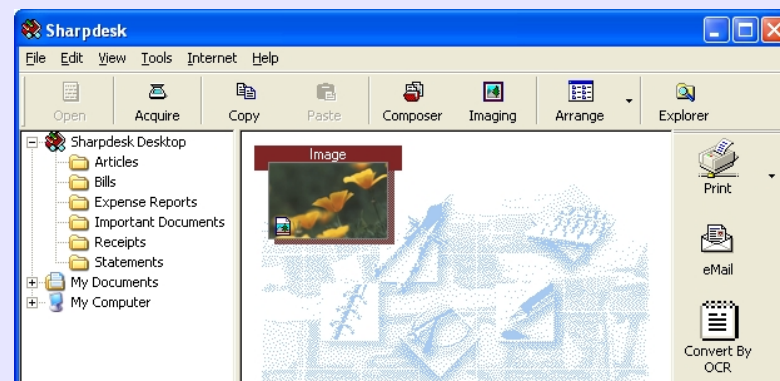

When you close the scanner driver after scanning, the image data will appear as a new file in Sharpdesk.

CONTENTS

INDEX

13

3 Scanning an Image from a TWAIN-Compliant Application (part 3)

Scanner Driver Settings

The scanner driver setup screen consists of the "Set-up screen", which lets you select scan settings, and the "Preview screen", which shows the scanned image. For details on the scan settings, click the "Help" button to display Help.

Set-up screen

"Scanning Position" menu

Select the desired scanning position from "Platen" (original table) or "SPF".



Note

Select "SPF" when you placed the original in the RSPF/SPF. On the unit without RSPF/SPF, this setting is fixed to "Platen".

"Scan" button

Click to scan an original or image according to your preferences. Before clicking the "Scan" button, check if your preferences are set correctly.



Note

To cancel your scanning job after clicking the "Scan" button, press the [Esc] key on your keyboard or the clear (Ⓢ) key on the unit.

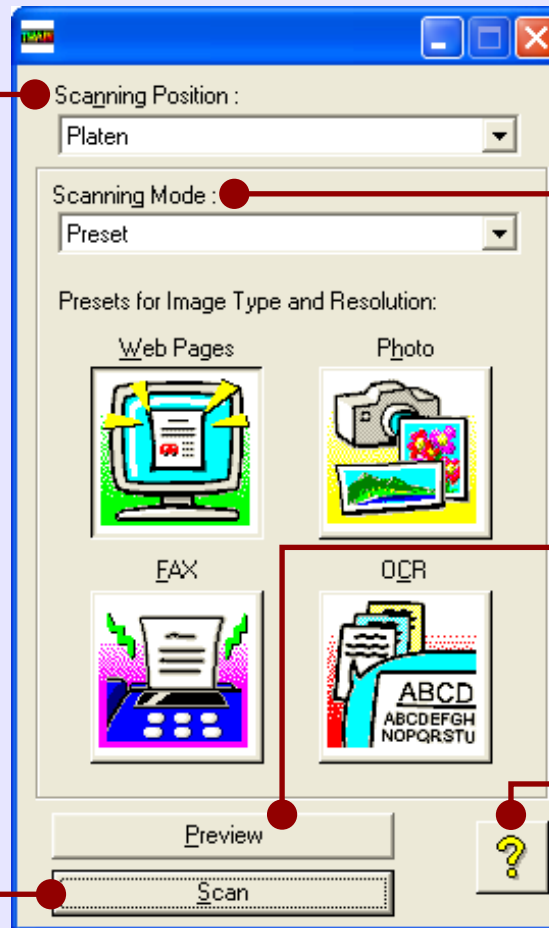

"Scanning Mode" menu

Switch the scanning mode between the "Preset" and "Custom Settings" screen. For details on each of these settings, click the "Help" button to display Help.

"Preview" button

Previews the document.



Note

If "Preview" is canceled by immediately pressing the [Esc] key on your keyboard or the clear (Ⓢ) key on the unit, there may be no images displayed on the preview screen.

"Help" button

Click to display the help file for the scanner driver.

CONTENTS

INDEX

14

3 Scanning an Image from a TWAIN-Compliant Application (part 4)

Preview screen

"Auto Scan Area Adjustment" button

Click when the preview screen is displayed to automatically set the scanning area.

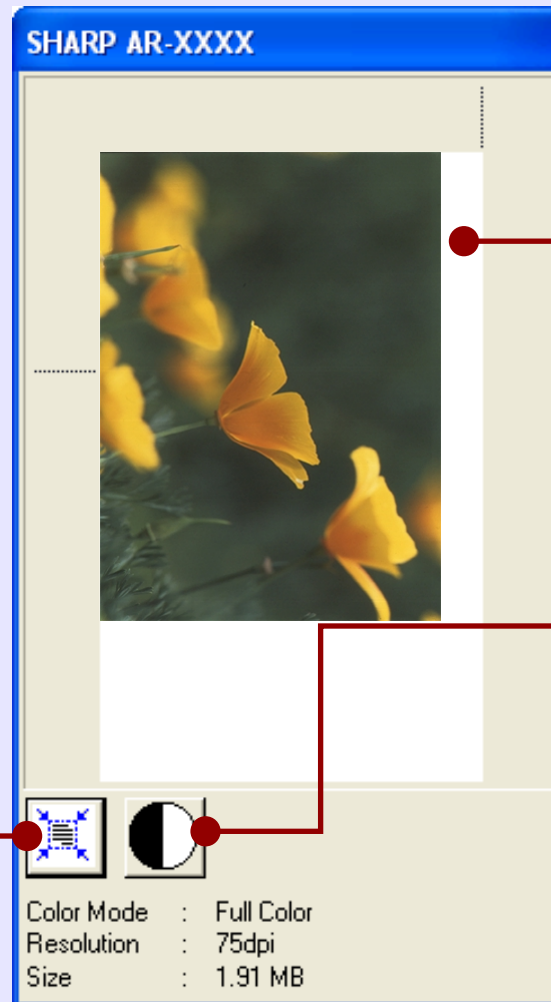

Preview window

Click the "Preview" button in the Set-up screen to display the scanned image. You can specify the scanning area by dragging the mouse inside the window.

"Brightness/Contrast" button

Click to change to the "Brightness/Contrast" screen and adjust the brightness and contrast settings for scanning.

3 Scanning an Image from a WIA-Compliant Application (Windows XP) (part 1)

If you are using Windows XP, you can use the WIA driver to scan from Sharpdesk, Paint and other WIA-compliant applications. The procedure for scanning using Paint is explained in the following.

1 Place the original you wish to scan on the original table/RSPF/SPF.

Reference: For information on setting an original for scanning, refer to "ORIGINAL PLACEMENT" in the Operation Manual.

2 After starting Paint, click the "File" menu and select "From Scanner or Camera".

The scan screen of the WIA driver will appear.

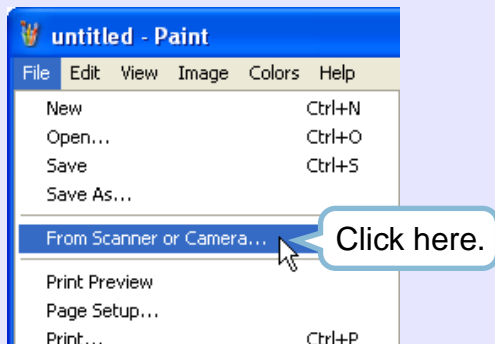

Note

If you have WIA drivers for other devices installed in your computer, the "Select Device" screen will open. Select "SHARP AR-XXXX" (where XXXX is the model name of your unit) and click the "OK" button.

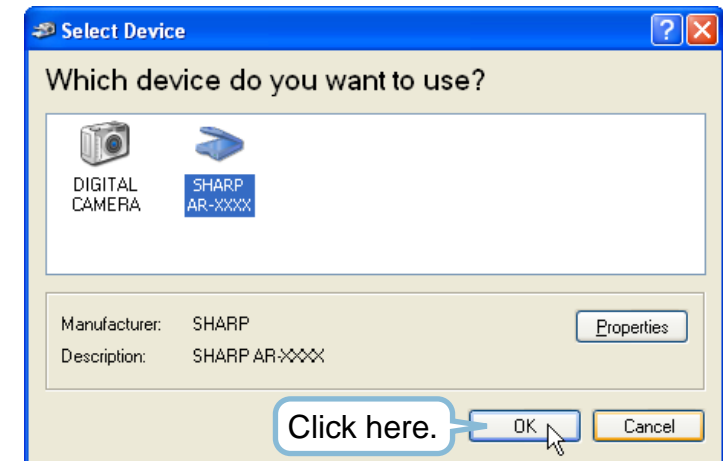

CONTENTS

INDEX

16

3 Select the paper source and picture type, and click the "Preview" button.

The preview image will appear.

If you placed the original on the original table, select "Flatbed" for the "Paper source".

If you placed the original in the RSPF/SPF, select "Document Feeder" for the "Paper source" and specify the original size in "Page size".

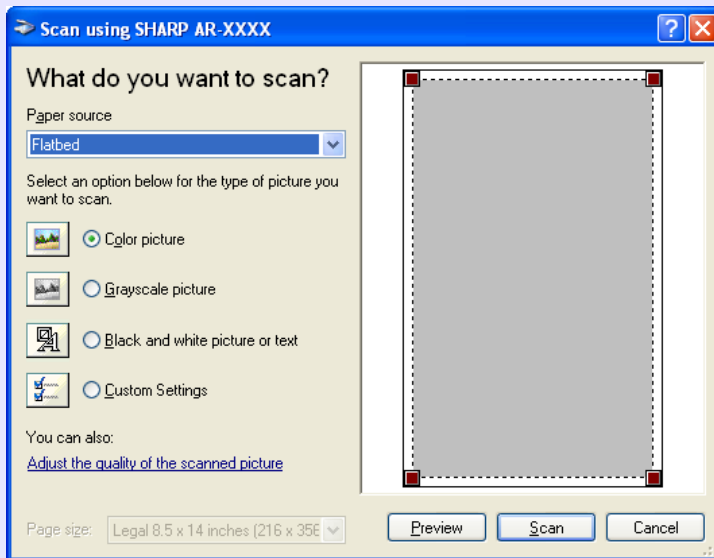

Note

- If you select "Document Feeder" for the "Paper source" and click the "Preview" button, the top original in the RSPF/SPF is previewed. The previewed original is sent to the original exit area, so you will need to return it to the RSPF/SPF before starting the scanning job.
- To view Help for a setting, click the (?) button in the upper right-hand corner of the window and then click the setting.

4 Click the "Scan" button.

Scanning begins and the image is acquired into Paint. Use "Save" in your application to select a file name and folder for the scanned image, and save the image. To cancel your scanning job after clicking the "Scan" button, click the "Cancel" button.

3 Scanning an Image from the "Scanner and Camera Wizard" (Windows XP) (part 1)

The procedure for scanning with the "Scanner and Camera Wizard" in Windows XP is explained here. The "Scanner and Camera Wizard" lets you scan an image without using a WIA-compliant application.

1 Place the original you wish to scan on the original table/RSPF/SPF.

Reference: For information on setting an original for scanning, refer to "ORIGINAL PLACEMENT" in the Operation Manual.

2 Click the "start" button, click "Control Panel", click "Printers and Other Hardware", and then click "Scanners and Cameras".

3 Click the "SHARP AR-XXXX" (where XXXX is the model name of your unit) icon and then click "Get pictures" in "Imaging Tasks".

The "Scanner and Camera Wizard" will appear.

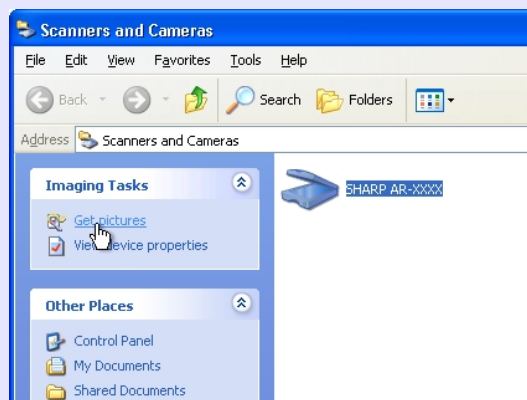

4 Click the "Next" button.



5 Select the "Picture type" and "Paper source", and click the "Next" button.

If you placed the original on the original table, select "Flatbed" for the "Paper source".

If you placed the original in the RSPF/SPF, select "Document Feeder" for the "Paper source" and specify the original size in "Page size".

You can click the "Preview" button to display the preview image.

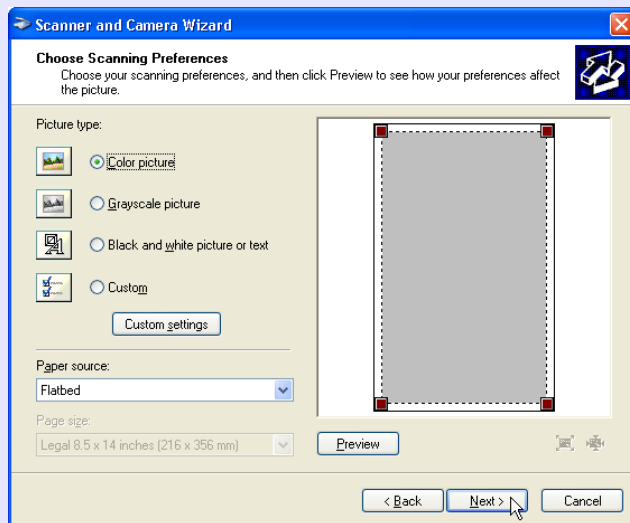

Note

- If you select "Document Feeder" for the "Paper source" and click the "Preview" button, the top original in the RSPF/SPF is previewed. The previewed original is sent to the original exit area, so you will need to return it to the RSPF/SPF before starting the scanning job.
- To adjust the resolution, picture type, brightness and contrast settings, click the "Custom settings" button.

6 Specify a group name, format and folder for saving the image, and then click the "Next" button.

JPG, BMP, TIF or PNG can be selected for the format. To begin scanning, click the "Next" button.

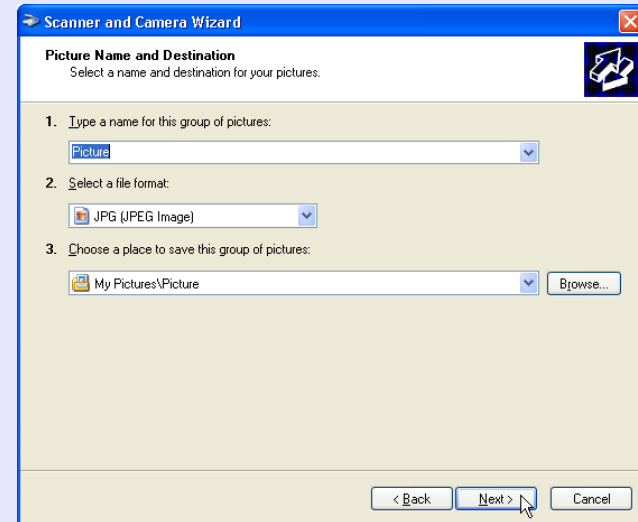

7 When scanning ends, the following screen will appear. Select the next task you wish to perform, and then click the "Next" button.

If you are ready to end the session, click "Nothing. I'm finished working with these pictures".

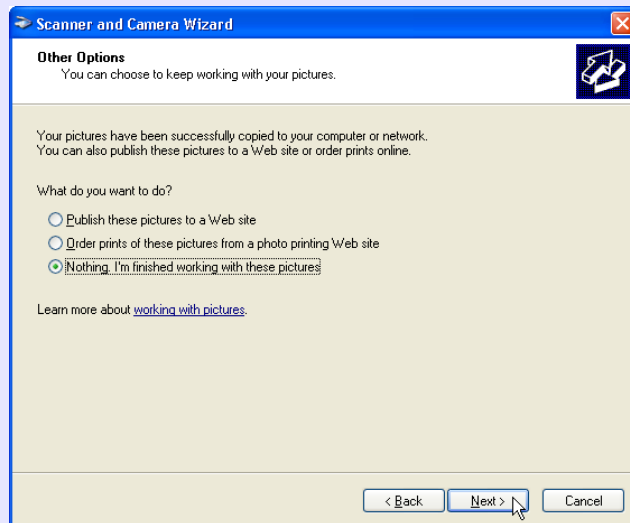

8 Click the "Finish" button. The "Scanner and Camera Wizard" closes and the scanned image is saved in the specified folder.



3 Outline of Button Manager

Button Manager is a utility software to link scanning functions to the SCANNER key on the unit. This software enables you to set scanning functions to six different scan menus, which will be linked the SCANNER key on the unit.

Reference: To begin scanning using the unit's operation panel, settings must be established in the Control Panel after the Button Manager is installed. For information on installing the Button Manager, establishing the Control Panel settings, and scanning using the unit's operation panel, see "USING THE SCANNER MODE" in the Operation Manual.

The functions of Button Manager are shown below.

The screenshot shows the "Scan Button Destination Settings" dialog box. It has a tabbed interface with six tabs labeled "ScanMenu SC1" through "ScanMenu SC6". The "ScanMenu SC1" tab is selected. The dialog is divided into two main sections: "Scan Setup" and "Application Selection".

- Tab:** A red line points to the "ScanMenu SC1" tab with the text: "Click to set scan menu options."
- "Scan Setup" area:** A red box encloses the "Scan Setup" section. A red line points to it with the text: "Set the scan conditions." This section includes:
 - Color Mode: Full Color (dropdown)
 - Edge: None (dropdown)
 - Scanning Area: Letter (dropdown)
 - Resolution: 75 (dropdown)
 - Color Matching: For CRT (dropdown)
 - Threshold: 128 (text input)
 - SPF: (checkbox)
 - Reverse: (checkbox)
- "Application Selection" area:** A red box encloses the "Application Selection" section. A red line points to it with the text: "Select the start-up application here." This section includes:
 - Radio buttons for: Sharpdesk (selected), Email, FAX, OCR, Microsoft Word, and Application.
 - A text input field containing "Sharpdesk".
- "OK" button:** A red line points to the "OK" button with the text: "Click to save your settings, and exit the dialog box."
- "Cancel" button:** A red line points to the "Cancel" button with the text: "Click this button to exit the dialog box without making any changes to the settings."
- "Apply" button:** A red line points to the "Apply" button with the text: "Click to save your settings without closing the dialog box."
- "Help" button:** A red line points to the "Help" button with the text: "Click this button to display the help file for Button Manager."

Note: Some applications may limit your choice of settings.

You can specify and change your six scan menu options from six functions. Refer to [Button Manager Settings](#) to specify and change the scan menu options.



Note

Close the source application before using the SCANNER key on the unit.

CONTENTS

INDEX

21

3 Button Manager Settings

After being installed, Button Manager normally keeps active under the Windows operating system. Follow the steps shown below to set scan options as you like.

For details on the settings in the setting screen of Button Manager, see Button Manager Help.

- 1** Right-click the Button Manager icon () on the task bar.



Note

If the Button Manager icon does not appear on the task bar, click the "start" button, select "All Programs" ("Programs" on Windows 98/Me/2000), select "SHARP Personal MFP series", and then click "Button Manager" to start Button Manager.

- 2** Select "Settings" from the displayed pop-up menu. The setting screen of Button Manager will open.

Reference: [Outline of Button Manager](#)

- 3** Click the tab of the scan menu you want to set up.

ScanMenu SC1 | ScanMenu SC2 | ScanMenu SC3 | ScanMenu SC4 | ScanMenu SC5 | ScanMenu SC6

- 4** Set up the start-up application in the "Application Selection" area.

Reference: [Outline of Button Manager](#)

- 5** Set up the "Color Mode", "Edge" and other scan settings in the "Scan Setup" area.



Note

When "SPF" is selected in the ScanMenu, only the original loaded in the RSPF/SPF can be scanned. If an application other than "Sharpdesk" is selected in the "Application Selection" area, only one original can normally be scanned. If "Sharpdesk" is selected, multiple originals can be scanned.

Reference: [Outline of Button Manager](#)

- 6** Click the "OK" button. You have completed the settings.

CONTENTS

INDEX

22

4 Identifying Unit Problems

When any trouble has occurred in the unit, first, verify whether you can make a copy or not with the unit. Check the items shown below when the unit does not work properly but it can make a copy.

Reference: If any copier trouble occurs, refer to "TROUBLESHOOTING" in the Operation Manual.

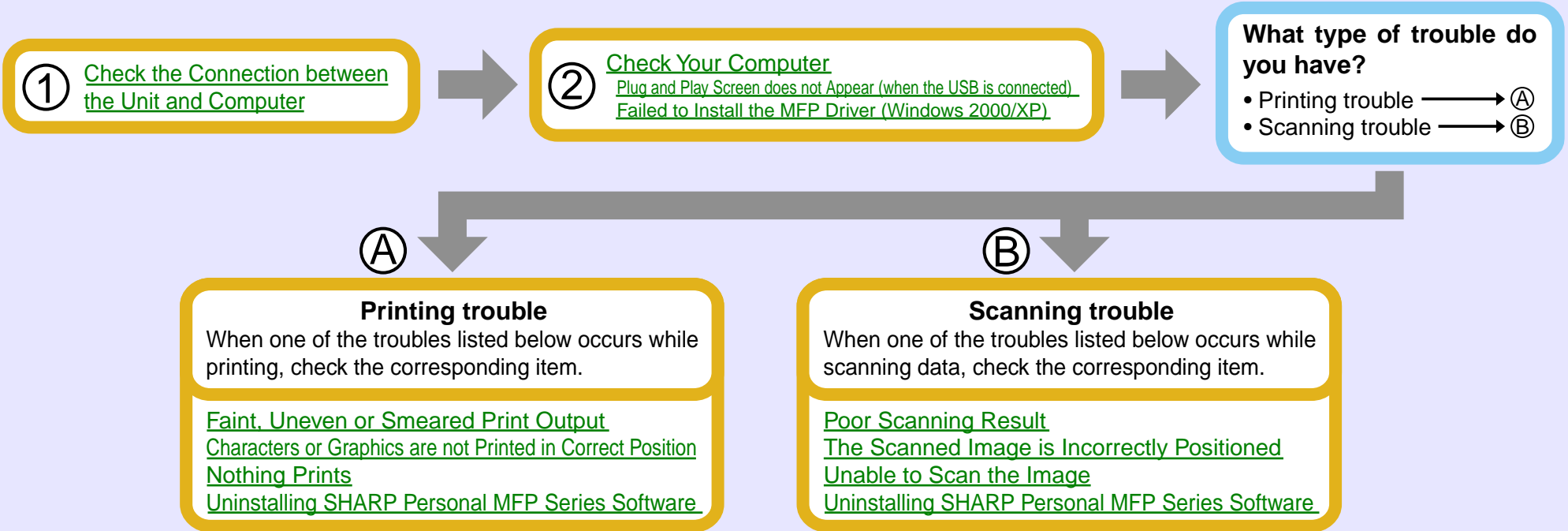

Note

Make sure that the unit is not working. You cannot print from your computer or scan from the unit while the unit is making copies.



Caution

The unit's scanning function can only be used if the unit is connected to your computer with a USB cable.

If you fail to solve the problem after verifying all the items listed above, please contact your authorized SHARP service center.

CONTENTS

INDEX

23

4

Check the Connection between the Unit and Computer

CHECK1 Is the interface cable compatible with the unit and computer?

Interface cables compatible with this unit are USB and parallel cables. Check which type of cable is supported by your computer, and then purchase one of the following cables accordingly:

USB cable

Shielded twisted pair cable (6 feet Max.: high-speed transmission equivalent)

Parallel interface cable

IEEE 1284 - Shielded type bi-directional parallel interface cable (6 feet Max.)



Caution

The unit's scanning function can only be used if the unit is connected to your computer with a USB cable.

CHECK2 Is the interface cable connected securely?

Check if the interface cable is securely plugged into the connectors of the unit and computer. It is also advisable to ensure that the connector pins are not bent.

Reference: See "CONNECTING THE INTERFACE CABLE" in the Operation Manual for more details on interface connection.

CHECK3 Are any other USB peripherals being connected along with the unit?

If other USB peripherals are connected through the same hub, disconnect them to see if the problem still exists.

If the USB cable becomes disconnected

If the USB cable becomes disconnected, even only once during the unit's operation, then printing and scanning may be disrupted.

If this occurs, check the USB cable and ensure that it is securely connected, then restart the computer.

4

Check Your Computer

Reference: [Plug and Play Screen does not Appear \(when the USB is connected\)](#)

CHECK1 Is there enough computer memory or hard disk space?

To use this unit, you must have an adequate amount of hard disk space. If there is insufficient hard disk space, delete unnecessary files to increase the free space of the hard disk. If there is insufficient memory, close unnecessary applications to increase memory available for printing or scanning. If you are still unable to print or scan, install more memory into your computer.

CHECK2 Is your hard disk fragmented?

When data is frequently stored/deleted, the hard disk may become fragmented causing a reduction in printing or scanning speed. In this case it is recommended to defragment your hard disk. You may use the Windows tools or a commercially available hard disk defragmenting tool.

CHECK3 If your computer is connected to the unit through the parallel port, is the parallel port (LPT) mode set to other than EPP mode?

The unit may not operate correctly if the parallel port mode is set to EPP mode. To set the parallel port mode to a mode other than EPP mode, refer to your computer manual or ask the manufacturer of the computer. ECP mode is recommended to obtain the best performance from the unit. Note that some computers may use different names for the modes.



Caution

If you are using Windows XP, the "Found New Hardware Wizard" may appear after you change the port setting. In this case, click the "Cancel" button to close the wizard, and then reinstall the printer driver as explained in "INSTALLING THE SOFTWARE" in the Operation Manual.

4 Plug and Play Screen does not Appear (when the USB is connected)

If the Plug and Play screen does not appear after you connect the unit to your computer with a USB cable and turn on the power of both devices, follow the steps below to verify that the USB port is available.

- 1** Click the "start" button, click "Control Panel", and then click "Performance and Maintenance".
On Windows 98/Me/2000, click the "Start" button, select "Settings", and then click "Control Panel".

- 2** Click "System", click the "Hardware" tab, and click the "Device Manager" button.
"Universal Serial Bus controllers" will appear in the list of devices.

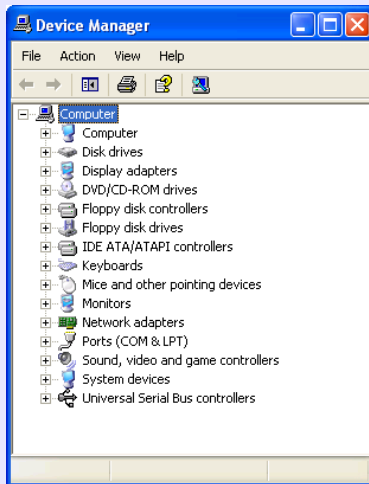

- 3** Click the (+) icon beside the "Universal Serial Bus controllers".

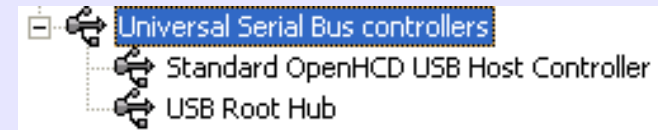

Two items will display, your Controller chipset type and Root Hub. If these items appear, you can use the USB port. If the "Universal Serial Bus controllers" shows a yellow exclamation point or does not appear, you must check your computer manual for USB troubleshooting or contact your computer manufacturer.

- 4** When you make sure that the USB port is enabled, install the software, referring to "INSTALLING THE SOFTWARE" in the Operation Manual.



Note

- If the "System" icon does not appear on Windows Me, click "view all Control Panel options" to view it.
- On Windows 98/Me, double-click the "System" icon and click the "Device Manager" tab.
- On Windows 2000, double-click the "System" icon, click the "Hardware" tab, and click the "Device Manager" button.

CONTENTS

INDEX

26

4 Failed to Install the MFP Driver (Windows 2000/XP)

If the MFP driver cannot be installed under Windows 2000/XP, check your computer's settings according to the following procedure.

1 Click the "start" button, and then click "Control Panel".

On Windows 2000, click the "Start" button, select "Settings", and then click "Control Panel".

2 Click "Performance and Maintenance", and then click "System".

On Windows 2000, double-click the "System" icon.

3 Click the "Hardware" tab, and then click the "Driver Signing" button.

The following dialog box will open.



4 Check the "What action do you want Windows to take?" ("File signature verification" on Windows 2000).

What action do you want Windows to take?

- Ignore - Install the software anyway and don't ask for my approval
- Warn - Prompt me each time to choose an action
- Block - Never install unsigned driver software

If the option "Block" has been selected for your computer, then the MFP driver will not be installable. Select the option "Warn" and then install the MFP driver as explained in "INSTALLING THE SOFTWARE" in the Operation Manual.

4 Faint, Uneven or Smearred Print Output

If print output is faint, uneven or smeared, follow the steps listed below.

CHECK1 Has the printer driver been specified to suit both paper and the print job?

You can select "Draft", "Normal" or "Photo" for the print quality in the "Advanced" tab of the printer driver setup screen. When "Photo" is selected, you can click the "Image Adjustment" button and adjust the brightness and contrast in the dialog box that appears. Adjust these settings appropriately for your print data and try printing again.

Reference: [Printer Driver Settings](#)

CHECK2 Is the paper curled?

If the paper is curled, straighten it up and set it in the unit again.

CHECK3 Is the paper too thick or too thin?

Only paper weighing from 15 lbs. To 21 lbs. can be used in the paper tray. Only paper weighing from 14 lbs. To 34.5 lbs. can be used in the multi-bypass tray.

CHECK4 Is the developer replacement required indicator lit?

When the developer replacement required (⦿) indicator lights up, the developer should be replaced. DEVELOPER REPLACEMENT SHOULD ONLY BE DONE BY AN AUTHORIZED SHARP SERVICE TECHNICIAN. Contact your service center as soon as possible.

CHECK5 Is it near time to replace the toner cartridge?

When it is near time to replace the toner cartridge, the toner cartridge replacement required (⦿) indicator will light up on the unit operation panel. When it is time to replace the cartridge, the indicator will blink. Replace the cartridge and try printing again.

Reference: See "TONER CARTRIDGE REPLACEMENT" in the Operation Manual.

CHECK6 Is the maintenance indicator lit?

When the maintenance (⦿) indicator lights up, service by an authorized SHARP service technician is required. Contact your service center as soon as possible.

CHECK7 Did you set sufficient margins in the paper settings of your application?

If the margins are set outside of the quality guaranteed area, smudges or smears may appear at the upper and lower edges of the paper. When selecting the paper settings in the application, set the margins from the top, bottom, left and right edges of the paper to 5/32".

4

Characters or Graphics are not Printed in Correct Position

If a document is printed skewed or partly off the paper, follow the steps listed below.

CHECK1 Is the paper size loaded in the tray the same as that specified in the printer driver?

Check if the "Paper Size" options suit the size of the paper loaded in the tray.

If the "Fit To Page" setting is activated, make sure that the paper size selected from the drop-down list of the "Fit To Paper Size" option is the same as the size of the loaded paper.

CHECK2 Is the orientation of document setting correct?

Click the "Paper" tab in the printer driver setup screen, and verify if the "Image Orientation" option is set to your requirements.

CHECK3 Is the paper loaded correctly?

If a document is physically damaged when it is output or the image is skewed on the paper, discard the damaged sheet, reinsert the paper supply and print again. Insert the paper so that there is no visible space between the paper and the paper guides.

Reference: See "LOADING PAPER" in the Operation Manual for more details on inserting paper.

CHECK4 Did you correctly specify the margins for the application in use?

Check the layout of the document margins and the paper size settings for the application you are using. Also check if the print settings are specified correctly to suit the paper size.

Reference: [Faint, Uneven or Smeared Print Output](#)

4 Nothing Prints

If nothing prints even when the unit is turned on, please wait a few moments. The unit needs a longer time to process intricate data. If the unit still does not print, refer to the check list below.

CHECK1 Has a paper jam occurred?

When the misfeed (⌘) indicator blinks or (P) blinks in the display, the unit will stop because of a misfeed.

Remove the jammed paper as explained in "MISFEED REMOVAL" in the Operation Manual.

CHECK2 Is the ONLINE indicator off?

The ONLINE indicator on the operation panel turns off while the unit is used for copying. Printing is not possible at this time. When copying is finished, the ONLINE indicator will turn on after the set auto clear time elapses, and the unit will be ready for printing. You can also press the clear (C) key twice or press the ONLINE key to make the unit ready for printing.

CHECK3 Is your unit selected correctly in the current application for the print job?

When choosing "Print" from the "File" menu located in applications, be sure you have selected "SHARP AR-XXXX" (where XXXX is the model name of your unit) printer displayed in the "Print" dialog box.

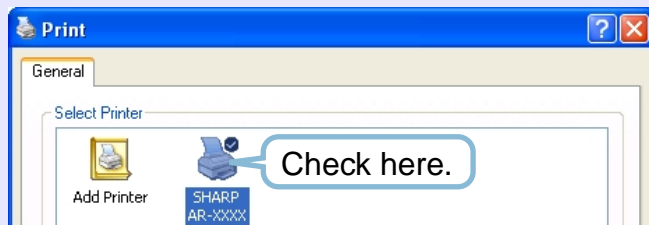

CHECK4 Has the printer driver been installed properly?

Check if the printer driver has been installed, following the steps listed below.

1 Click the "start" button, click "Control Panel", click "Printers and Other Hardware", and then click "Printers and Faxes".

On Windows 95/98/Me/NT 4.0/2000, click the "Start" button, select "Settings" and then click "Printers".

2 Check if the "SHARP AR-XXXX" (where XXXX is the model name of your unit) printer driver icon is shown.

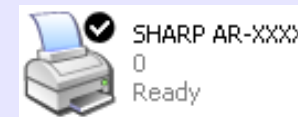

If you still cannot print after confirming the "SHARP AR-XXXX" (where XXXX is the model name of your unit) printer driver icon, the printer driver may not have been installed correctly. In this case, delete SHARP Personal MFP series software and then reinstall it.

Reference: [Uninstalling SHARP Personal MFP Series Software](#)

4 Poor Scanning Result

If you get poor quality as a result of a scanning job, and you cannot improve the quality by changing preferences, refer to the check list shown below.

CHECK1 Is the original clean?

Check your original before scanning. If any dust sticks to the original, you cannot obtain a clean result. In addition, make sure that the original table is also clean.

CHECK2 Have you specified a suitable resolution?

Make sure that the value for the "Resolution" setting in the scanner driver satisfies the requirement of the set original.

Reference: [Scanning an Image from a TWAIN-Compliant Application](#),
[Scanning an Image from a WIA-Compliant Application \(Windows XP\)](#),
[Scanning an Image from the "Scanner and Camera Wizard" \(Windows XP\)](#).

CHECK3 Have you specified a suitable value for the "B/W Threshold" setting?

If you are scanning with a TWAIN-compliant application and are using "Mono 2 gradation (no Green)", "Mono 2 gradation (no Red)" or "Mono 2 gradation (no Blue)" mode, make sure that a suitable value is specified for the "B/W Threshold" setting. A larger threshold value makes your output darker, whilst a small threshold value makes it lighter. To adjust the threshold automatically, click the "Auto Threshold" button on the "Image" tab of the "Custom Settings" screen.

Reference: [Scanning an Image from a TWAIN-Compliant Application](#)

CHECK4 Have you adjusted the brightness and contrast suitably?

If you are scanning with a TWAIN-compliant application and the resulting image has unsuitable brightness or contrast (for example it is too bright), activate the "Auto Brightness/Contrast Adjustment" setting on the "Main" tab of the ["Custom Settings" screen](#). Click the ["Brightness/Contrast" button](#) to adjust the brightness and the contrast viewing the scanned output image on the screen.

If you are scanning with a WIA-compliant application or the "Scanner and Camera Wizard", click ["Adjust the quality of the scanned picture"](#) or the ["Custom settings" button](#), and adjust the brightness and contrast in the screen that appears.

If part of the image from the back side of the original appears in the preview scan.

If you are using a TWAIN-compliant application and the back side of the original appears faintly in the preview image, try adjusting the Brightness and Contrast settings. Click the ["Brightness/Contrast" button](#) in the Preview screen to change to the Brightness/Contrast screen, and adjust the "Brightness" and "Contrast" values. A preview of the image using the new values appears under "After". When the image of the back side disappears and you can get only the needed image, click the "Apply" button to apply the new settings, and then click the "Scan" button to scan the image.

4 The Scanned Image is Incorrectly Positioned

If the scanned image is incorrectly positioned, refer to the check list shown below.

CHECK1 Have you placed the original straight?

Place the original straight on the original table.

Reference: Refer to "ORIGINAL PLACEMENT" in the Operation Manual for the detail on how to set the original.

CHECK2 Have you set the original correctly on the original table?

Place the original on the original table in the direction as shown in the illustration below.

Align the center of the original with (▶) mark.

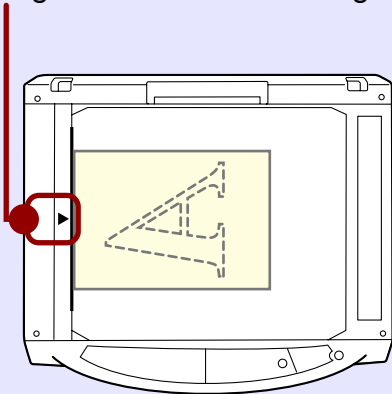

CHECK3 Have you set the original correctly on the RSPF/SPF?

To scan from the RSPF/SPF, align the guide to the original as shown in the illustration below.

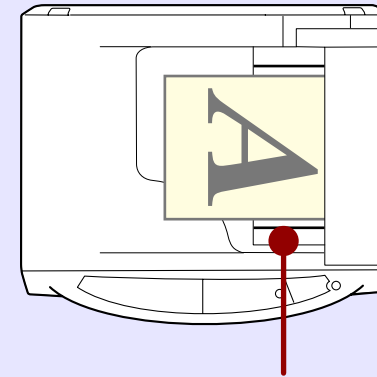

Align the guide to the original.

4 Unable to Scan the Image

If you cannot scan the image, turn off your computer. Press the power switch on the unit to turn it off, unplug the unit from the power source, and then plug it back in. Restart your computer. Try scanning again. If scanning is still not possible, refer to the check list below.

CHECK1 Is your application compliant to TWAIN?

If you are using Windows 98/Me/2000 and your application is not TWAIN compliant, the application cannot acquire images. Use an application that is TWAIN compliant, such as the included Sharpdesk.

CHECK2 Have you selected the scanner driver of this unit on your application?

Make sure that the "SHARP Personal MFP series" or "WIA-SHARP AR-XXXX" (where XXXX is the model name of your unit) is selected on your application.

Reference: [Scanning an Image from a TWAIN-Compliant Application](#)

CHECK3 Have you specified all scanning preferences appropriately?

Setting a large area with full color together with a high resolution setting, makes the data size large, resulting in extended scanning times. It is recommended to set the scanning preferences depending on the type of original to be scanned, i.e., Text, Text/Graphics, Photograph, Color, Black & White.

CHECK4 Is there enough computer memory?

Your computer may not have enough available memory to hold the document you want to scan. Lower the scan resolution.

CHECK5 Has the specified period of program timeout already elapsed?

Neither printing nor scanning jobs can be sent to the unit from your computer during the specified period of program timeout after copying.

To send a scanning job immediately, press the clear (Ⓞ) key twice, ONLINE key or SCANNER key on the unit.

Reference: For more detail, refer to "USER PROGRAMS" in the Operation Manual.

CHECK6 Are you trying to scan multiple originals in the RSPF/SPF at once?

When multiple originals are loaded in the RSPF/SPF, it depends on your application whether only one original can be scanned in a single operation, or whether multiple originals can be scanned. Check which is possible in your application. (Sharpdesk allows multiple originals to be scanned in a single operation.)

CHECK7 Does your computer's operating system support the scanner driver?

The operating systems that support the unit's scanner driver are Windows 98/Me/2000/XP.

CHECK8 Are you using an appropriate interface?

Only the USB interface can be used for the unit's scanning function. Make sure the unit is connected to your computer with a USB cable. If the unit was connected to your computer with a parallel cable when you installed the SHARP Personal MFP series software, uninstall the SHARP Personal MFP series software. Refer to "INSTALLING THE SOFTWARE" in the Operation Manual for the order of installation of the SHARP Personal MFP series software and connection of the USB cable, and reinstall the SHARP Personal MFP series software.

Reference: [Uninstalling SHARP Personal MFP Series Software](#)

CHECK9 Have the scanner driver and Button Manager been installed properly?

If normal scanning still cannot be performed even after confirming the items on the above check list, delete SHARP Personal MFP series software and then reinstall it.

Reference: [Uninstalling SHARP Personal MFP Series Software](#)

CONTENTS

INDEX

33

4 Uninstalling SHARP Personal MFP Series Software

If printing or scanning is not possible, or Button Manager does not function correctly, check the items in "[Nothing Prints](#)" or "[Unable to Scan the Image](#)". If you still cannot solve the problem, follow the steps below to uninstall SHARP Personal MFP series software (MFP driver (printer driver/scanner driver), Button Manager), and then reinstall it.



Caution

Before uninstalling SHARP Personal MFP series software, close all applications.

1 Click the "start" button, and then click "Control Panel".

On Windows 95/98/Me/NT 4.0/2000, click the "Start" button, select "Settings", and then click "Control Panel".

2 Click "Add or Remove Programs".

On Windows 95/98/Me/NT 4.0/2000, double-click the "Add/Remove Programs" icon. The following dialog box will open.

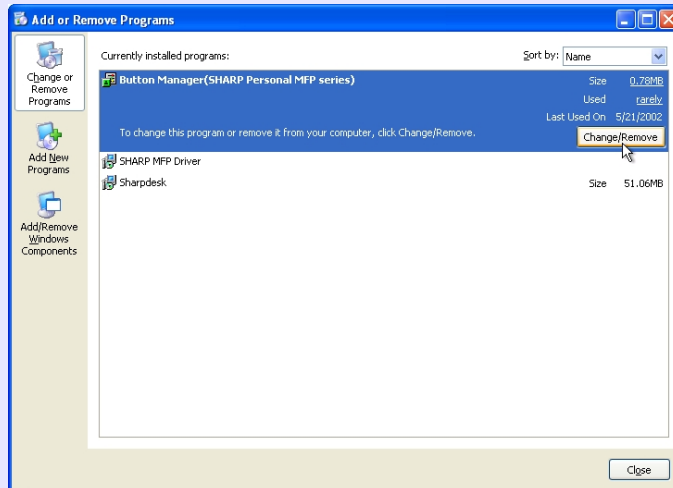

Delete the "SHARP MFP driver" and the "Button Manager (SHARP Personal MFP series)" from the list of applications. For more information, refer to your operating manual or to the help files for your operating system.

3 Restart your computer.

The deletion of the MFP driver and Button Manager is completed when you restart your computer. If you wish to reinstall, follow the instructions in "INSTALLING THE SOFTWARE" in the Operation Manual.

[CONTENTS](#)

[INDEX](#)

34

5 Index

A	Application Selection	21	N	N-up printing	8	Scanning Mode	14
	"Auto Scan Area Adjustment" button	15		Nothing Prints	30	Scanning Overview	11
B	Basic Printing	3	O	Outline of Button Manager	21	Scanning Position	13
	Border	8		Outline of the Print Status Window	10	Select Device	16
	"Brightness/Contrast" button	15		Overview		Set-up Screen	14
	Button Manager	21		Print	2	Settings	
	Button Manager Settings	22		Scan	11	Button Manager	22
D	Document Style	9	P	Paper Size	7	Printer driver	5
F	Fit To Page	7		"Preview" button		Scanner driver	
	Fit To Paper Size	7		Scanner and Camera Wizard	19	Scanner and Camera Wizard	19
H	Help			TWAIN driver	14	TWAIN driver	14
	Button Manager	21		WIA driver	17	WIA driver	17
	Print Status Window	10		Preview Screen	15	Starting	
	Printer driver	5		Print	2	Button Manager	22
	Scanner driver			Print Status Window	10	Printer driver	4
	TWAIN driver	14		Printer Driver Settings	5	T	Troubleshooting
	WIA driver	17		Printing a Watermark	6		TWAIN
	How to Use the Online Manual	1		Printing Overview	2		Two-sided Printing
I	Interface	24	S	Scan	11	U	Unable to Scan the Image
M	Main	5		"Scan" button			Uninstalling
	Margin	28		TWAIN driver	14		Button Manager
	MFP driver	27		WIA driver	17		MFP driver
				Scan Setup	21	W	Watermark
				Scanner and Camera Wizard	11		WIA
				Scanning an Image			
				Scanner and Camera Wizard	18		
				TWAIN driver	12		
				WIA driver	16		