

SHARP

SOUND BAR SYSTEM

MODEL

HT-SB200

OPERATION MANUAL

SRS (●)
WOW HD

SRS (●)
WOW HD

is a trademark of SRS Labs, Inc.

WOW HD technology is incorporated under license from SRS Labs, Inc.

Note:

This product is recommended for flat panel TV (LCD and plasma).

Thank you for purchasing this SHARP product.
To obtain the best performance from this product, please read this manual carefully. It will guide you in operating your SHARP product.

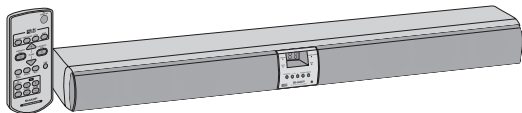

Special notes

WARNINGS













- When the ON/STAND-BY button is set at STAND-BY position, main voltage is still present inside the speaker. When the ON/STAND-BY button is set at STAND-BY position, the speaker may be brought into operation by the remote control.
- This speaker contains no user serviceable parts. Never remove covers unless qualified to do so. This speaker contains dangerous voltages, always remove mains plug from the socket before any service operation and when not in use for a long period.
- The supplied AC/DC adaptor contains no user serviceable parts. Never remove covers unless qualified to do so. It contains dangerous voltages, always remove mains plug from the main outlet socket before any service operation or when not in use for a long period.
- The AC/DC adaptor supplied with the HT-SB200 must not be used with other equipment.
- Never use an AC/DC adaptor other than the one specified. Otherwise, problems or serious hazards may be created.
- To prevent fire or shock hazard, do not expose this appliance to dripping or splashing. No objects filled with liquids, such as vases, shall be placed on the apparatus.
- Do not turn the volume on to full at switch on. Listen to music at moderate levels.

Features

SRS WOW improves the dynamic audio performance of compressed and uncompressed audio by expanding the size of the audio image and creating a deep, rich bass response.

Accessories

Please confirm that only the following accessories are included.

 Remote control x 1	 RCA cable (2 pins - 2 pins) x 1	 Spike x 4 (Length : 25 mm)
 AC/DC adaptor x 1	 AC power lead x 1	 AC power lead x 1 (for Australia only)
 AC power lead x 1 (for United Kingdom and Eire only)	 Wall mount angle x 2	 Foot cushion x 4
 Pattern paper x 1	 (Spike + Nut) x 4 (Length : 30 mm)	 Plug adaptor x 1 (for Philipines only)

Note:

The AC/DC adaptor may be different from the one in the drawing.

Contents

HT-SB200

	Page
■ General Information	
Precautions	4
Controls and indicators	5 - 7
■ Preparation for Use	
Speaker preparation	8 - 10
Placing the speaker	11
Falling prevention	11
Speaker connections to TVs	12
AC power connection	13
Remote control	13 - 14
■ Basic Operation	
General control	14 - 15
■ References	
Troubleshooting chart	16
Maintenance	17
Error indicators and warnings	17
Specifications	18

Precautions

■ General

- Please ensure that the equipment is positioned in a well-ventilated area and ensure that there is at least 10 cm (4") of free space along the sides and top of the equipment.

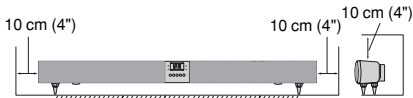

- Use the speaker on a firm, level surface free from vibration.
- Keep the speaker away from direct sunlight, strong magnetic fields, excessive dust, humidity and electronic/electrical equipment (home computers, facsimiles, etc.) which generate electrical noise.
- Do not place anything on top of the speaker.
- Do not expose the speaker to moisture, to temperatures higher than 60°C (140°F) or to extremely low temperatures.
- If your system does not work properly, disconnect the AC power lead from the wall socket. Plug the AC power lead back in, and then turn on your system.
- In case of an electrical storm, unplug the speaker for safety.
- Do not use an external power supply other than the 12V DC supplied with this speaker as it may be damaged.
- SHARP is not responsible for damage due to improper use. Refer all servicing to a SHARP authorised service centre.
- Hold the AC power plug by the head when removing it from the wall socket, as pulling the lead can damage internal wires.
- The AC power plug is used as a disconnect device and shall always remain readily operable.

- **Do not remove the outer cover, as this may result in electric shock. Refer internal service to your local SHARP service facility.**

- The ventilation should not be impeded by covering the ventilation openings with items, such as newspapers, tablecloths, curtains, etc.
- No naked flame sources, such as lighted candles, should be placed on the apparatus.
- Attention should be drawn to the environmental aspects of battery disposal.
- This speaker should only be used within the range of 5°C - 35°C (41°F - 95°F).
- The apparatus is designed for use in moderate climates.

Warning:

The voltage used must be the same as that specified on this speaker. Using this product with a higher voltage other than that which is specified is dangerous and may result in a fire or other type of accident causing damage. SHARP will not be held responsible for any damage resulting from use of this speaker with a voltage other than that which is specified.

■ Volume control

The sound level at a given volume setting depends on speaker efficiency, location, and various other factors. It is advisable to avoid exposure to high volume levels. Do not turn the volume on to full at switch on. Listen to music at moderate levels.

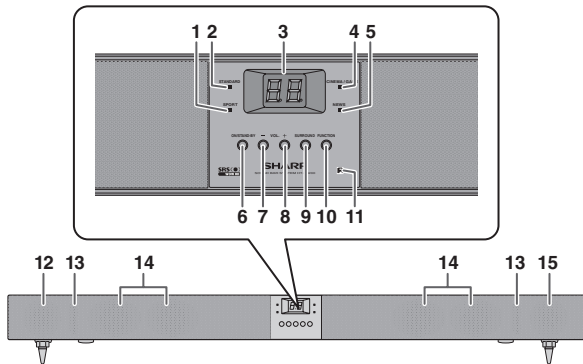

■ Front Panel

	Reference page		Reference page
1. Sport Indicator	15	9. Surround Button	15
2. Standard Indicator	15	10. Function Button	15
3. Information Display	14	11. Remote Sensor	14
4. Cinema/Game Indicator	15	12. Left Front Speaker	
5. News Indicator	15	13. Bass Reflex Duct	
6. On/Stand-by Button	14	14. Subwoofers	
7. Volume Down Button	14	15. Right Front Speaker	
8. Volume Up Button	14		

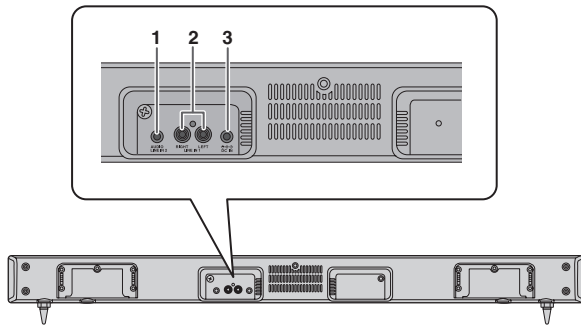

■ Rear Panel

Reference page

1. Audio Line In 2 (3.5 mm stereo/headphone) Socket 12
2. Line In 1 (RCA/cinch) Sockets 12
3. DC Input Socket 13

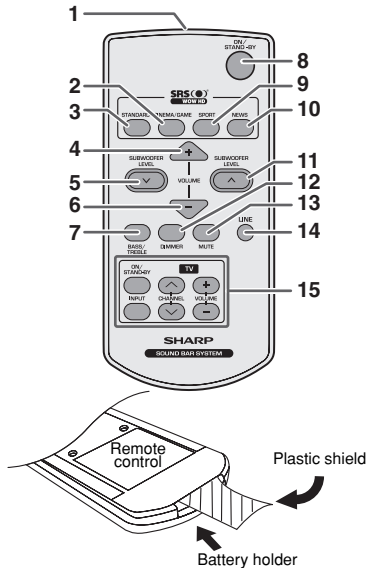





Note:
Before using remote control, please remove plastic shield at battery holder.

Remote Control

Reference page

1. Remote Control Transmitter 14
2. Cinema/Game Button..... 15
3. Standard Button 15
4. Volume Up Button 14
5. Subwoofer Level Down Button 15
6. Volume Down Button 14
7. Bass/Treble Button..... 15
8. On/Stand-by Button 14
9. Sport Button 15
10. News Button 15
11. Subwoofer Level Up Button 15
12. Dimmer Button 14
13. Mute Button 15
14. Line Button 15
15. TV Operation Buttons 7

TV Operation Buttons (Only SHARP TV):

On/Stand-by Button 	Sets the TV power to "ON" or "STAND-BY".	Input Select Button (TV) 	Press the button to switch the input source.
Volume Up and Down Buttons 	Turn up/down the TV volume.	Channel Up and Down Buttons 	Switch up/down the TV channels.

Notes:

- Some models of SHARP TV may not be operable.
- SHARP TV remote will not work with HT-SB200 system.

Speaker preparation

Make sure to unplug the AC power lead before installing the speaker or changing the position.

Select from three installation methods according to the preferred position.

Using spikes

You may choose from the two different spike lengths provided: 25 mm and 30 mm.
Nuts (secured on 30 mm spikes) must be used when installing either the 25 mm or 30 mm spikes.
The speaker can be leveled by adjusting the spikes and nuts.

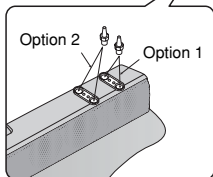

Tighten all spikes as shown

Notes:

- Option 1 or option 2 indicates spike positions based on LCD TV stand.
- When attaching the spikes, place the speaker on a cushion or soft cloth to avoid damage.

Caution:

When using these spikes on glossy or slippery table such as on glass top, stick foot cushions at the bottom of the spikes to avoid slippage.

Using foot cushions

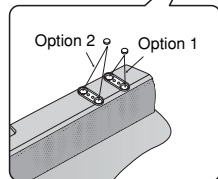

Attach foot cushions as shown

Note:

Option 1 or option 2 foot cushion positions based on LCD TV stand.

To mount the speaker on the wall

Caution:

- Be very careful to prevent the speaker [1.75 kg (3.86 lbs.)] from falling when mounting on the wall.
- Before mounting, check the wall strength. (Do not put on the veneer plaster or whitewashed wall. The speaker may fall.) If unsure, consult a qualified service technician.
- Mounting screws are not supplied. Use appropriate ones.
- Check all wall mount angle screws for looseness.
- Select a good location. If not, accidents may occur or the speaker may get damaged.
- **SHARP is not responsible for accidents resulting from improper installation.**

■ Driving screws

SHARP designed the speakers so you may hang them on the wall. Use proper screws (not supplied). See below for size and type.

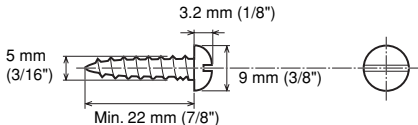

■ Wall mount angle fixed to the wall (Horizontal position)

- 1 Fix the pattern paper to the wall in horizontal position as below.

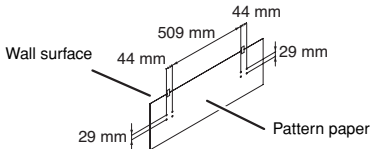

- 2 Make a hole on the wall following the screw point marks on the pattern paper by using a drill.

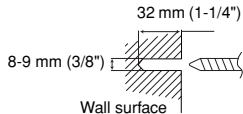

- 3 Fix a wall mount plug into the hole using a hammer, until it is flush with the wall surface.

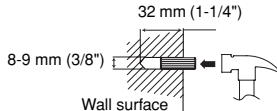

Continued to the next page

Speaker preparation (continued)

- 4** Screw the wall mount angle to the wall as shown in the illustration. (Total screw is 8 pieces)

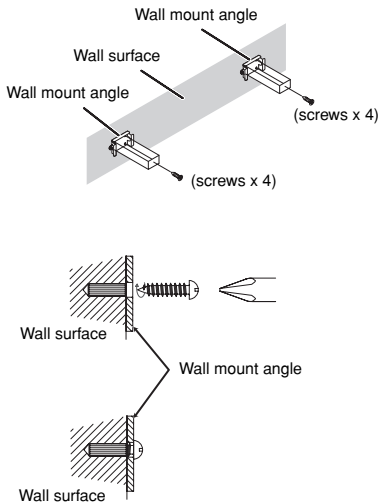

Note:

Make sure all screws are fully tightened. (screws are not supplied)

■ Installing the speaker

- 1** Align the wall mount slot at the speaker to the wall mount angle.
- 2** Slot the speaker into the wall mount angle.
- 3** Fix them securely.

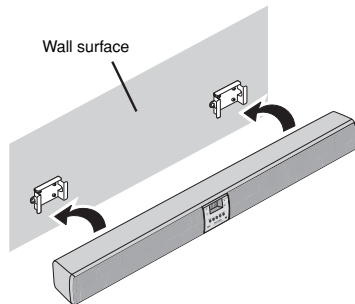

Placing the speaker

Installation image:

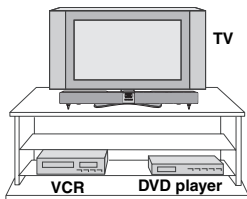

Place the speaker as shown.

Notes:

- As the sound from the speaker is omni-directional, you can place the speaker anywhere you like. However, it is recommended to place it as close to the TV as possible.
- The front panel of the speaker is not removable.

Caution:

- Do not change the installation direction when the speaker is turned on.
- Do not stand or sit on the speaker as you may be injured.

Falling prevention

Safety wires (not supplied) are useful to prevent the speaker from falling off the table.

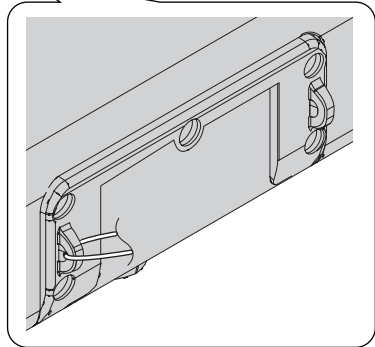
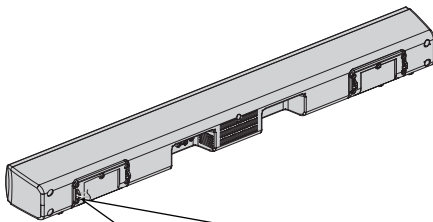

Loop the safety wires (not supplied) into each hole as shown and tie the safety wires to the LCD TV stand.

Speaker connections to TVs

Caution:

Turn off all other equipment before making any connections.

Tuner receiving for other audio system

- Placing the aerial near the speaker AC power lead may cause noise pick up. Place the aerial away from the speaker for better reception.

Notes:

- To connect to TV, use either LINE IN 1 sockets or AUDIO LINE IN 2 socket only.
- Refer the operation manual of the equipment to be connected.
- Fully insert the plugs to avoid fuzzy pictures or noises.

■ Connecting to a TV

If the TV/monitor has an audio output, connect it to the LINE IN 1 sockets on the rear of the speaker.

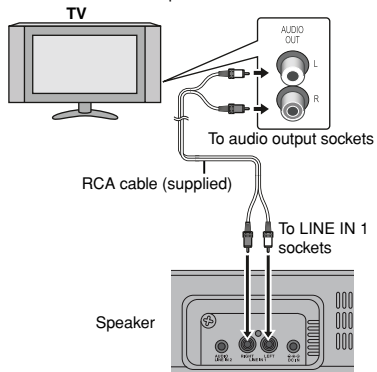

■ Connecting to a TV (with Headphone socket)

If the TV/monitor has headphone socket, connect it to the AUDIO LINE IN 2 socket on the rear of the speaker.

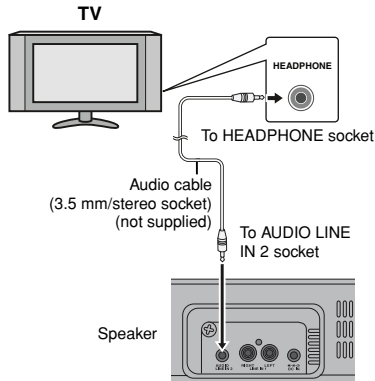

Notes:

- If the TV volume is continuously in low level, the speaker will automatically power off. Increase the TV output volume to enjoy the sound from the speaker.
- If the speaker volume is continuously in very high level, the speaker will mute and recover after 3 seconds.

AC power connection

After checking all the connections have been made correctly, connect the AC power lead to the AC power input socket, then to the wall socket.

■ Using with the AC/DC adaptor

- 1 Plug the AC power lead into the AC/DC adaptor.
- 2 Plug the AC/DC adaptor cable into the DC IN socket on the speaker.
- 3 Plug the AC power lead into a wall socket. The STAND-BY indicator will turn RED when AC power is applied. The power indicator will turn GREEN when the system in "ON".

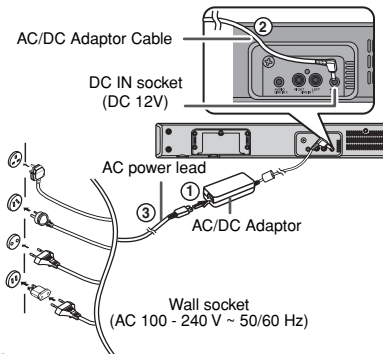

Notes:

- Unplug the AC/DC adaptor from the wall socket if the speaker will not be used for a long period of time.
- Use only the supplied AC/DC adaptor. Using other AC/DC adaptor may cause an electric shock or fire.

Remote control

HT-SB200

■ Battery installation

- 1 Insert pin into the hole as shown and pull to open the battery holder.

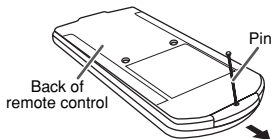

- 2 Remove the old battery from the battery holder, insert the new battery and then slide the battery holder back into the remote control.

Battery holder

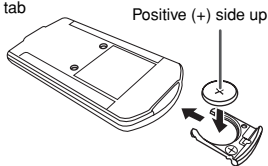
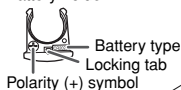

Precautions for battery use:

- Remove the battery if the speaker will not be used for a long period of time. This will prevent potential damage due to battery leakage.

Remote control (continued)

Caution:

- Do not use rechargeable battery (nickel-cadmium battery, etc.).
- Danger of explosion if battery is incorrectly replaced.
- Replace only with the same or equivalent type.
- Batteries (battery pack or batteries installed) shall not be exposed to excessive heat such as sunshine, fire or the like.
- Installing the battery incorrectly may cause the speaker to malfunction.

Notes concerning use:

- Replace the battery if the operating distance is reduced or if the operation becomes erratic. Purchase "CR 2025", coin lithium battery.
- Periodically clean the transmitter on the remote control and the sensor on the speaker with a soft cloth.
- Exposing the sensor on the speaker to strong light may interfere with operation. Change the lighting or the direction of the speaker if this occurs.
- Keep the remote control away from moisture, heat, shock, and vibrations.

■ Test of the remote control

Point the remote control directly at the remote sensor on the speaker.

The remote control can be used within the range shown below:

Press the ON/STAND-BY button. Does the power turn on? Now, you can enjoy your system.

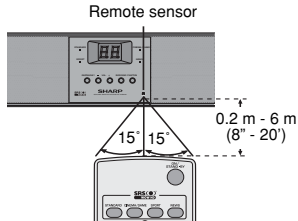

General control

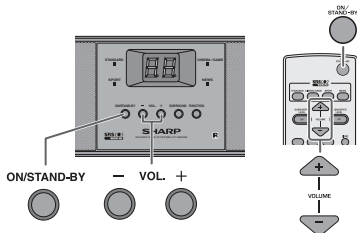

■ To turn the power on

Press the ON/STAND-BY button.

- The power indicator turns green. If the power does not turn on, check whether the power lead is plugged in properly.

To set the speaker to stand-by mode:

- Press the ON/STAND-BY button again. The STAND-BY indicator turns red.

■ Display brightness control

Press the DIMMER button to adjust the brightness of the display and sound mode indicator.

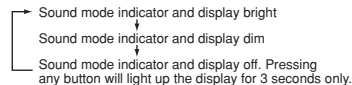

■ Volume auto fade-in

If you turn off and on the speaker with the volume set to 40 or higher, the volume starts at 20 and fades in to the last set level.

■ Volume control

Speaker operation:

Press volume up (VOL. +) to increase the volume and press volume down (VOL. -) to decrease the volume.

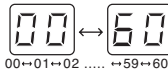

Remote control operation:

Press the VOL + button to increase the volume and the VOL - button to decrease the volume.

Muting

The volume is muted temporarily when pressing the MUTE button on the remote control. Press again to restore the volume.

**Preset sound mode****Main unit operation:**

When the SURROUND button is pressed, the current mode setting will light up. To change to a different mode, press the SURROUND button repeatedly until the desired sound mode lights up.

Remote control operation:

Press a desired sound mode on the remote control.

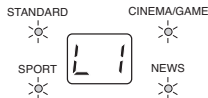

STANDARD	WOW HD off
↓	
CINEMA/GAME	WOW HD on for cinema/game sound effect
↓	
SPORT	WOW HD on for sport broadcasting
↓	
NEWS	WOW HD on for news

Subwoofer level control

The speaker level can be adjusted.

To increase the level, press the SUBWOOFER LEVEL \wedge button.

To decrease the level, press the SUBWOOFER LEVEL \vee button.

**Note:**

When sound from the speaker is distorted, decrease the subwoofer level.

Bass control

1. Press the BASS/TREBLE button to select "BASS".
2. Within 5 seconds, press the VOLUME (+ or -) button to adjust the bass.

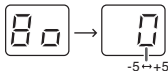
**Treble control**

1. Press the BASS/TREBLE button to select "TREBLE".
2. Within 5 seconds, press the VOLUME (+ or -) button to adjust the treble.

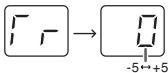
**Function**

When the FUNCTION button on speaker or LINE button on the remote control is pressed, the input source will change. Press the FUNCTION button on speaker or LINE button on the remote control repeatedly to select desired input source.

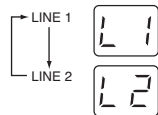
**Note:**

The backup function will protect the memorised function mode for a few hours should there be a power failure or the AC power lead becomes disconnected.

Auto power on function:

When you press the LINE button on the remote control, the speaker will turn on at last function.

Auto power off and auto detect signal:

- If no signal is detected for 1 minute during power on, the speaker will automatically go to stand-by mode. The STAND-BY indicator turns orange.
- The speaker will automatically power ON if it detects audio signal from connected equipment.

Troubleshooting chart

Many potential problems can be resolved by the owner without calling a service technician.

If something is wrong with this product, check the following before calling your authorised SHARP dealer or service centre.

■ General

Symptom	Possible cause
No sound is heard.	<ul style="list-style-type: none"> ● Is the input signal (selection) set properly? ● Is the volume level set to "0"?
Noise is heard during playback.	<ul style="list-style-type: none"> ● Move the speaker away from any computers or mobile phones.
When a button is pressed, the speaker does not respond.	<ul style="list-style-type: none"> ● Set this speaker to the stand-by mode and then turn it back on.
The power is not turned on.	<ul style="list-style-type: none"> ● Is the speaker unplugged? (Refer to page 13) ● The protection circuit may be activated. Unplug and plug in the power lead again after 5 minutes or more.

■ Remote control

Symptom	Possible cause
The remote control does not operate properly.	<ul style="list-style-type: none"> ● Is the battery polarity correct? ● Is the battery dead? ● Is the distance or angle incorrect? ● Are there any obstructions in front of the speaker? ● Is there a strong light shining on the remote sensor? ● Is the remote control for another equipment used simultaneously?

Symptom	Possible cause
The speaker cannot be turned on with the remote control.	<ul style="list-style-type: none"> ● Is the AC power lead of the speaker plugged in? ● Is the battery inserted?
TV cannot be operated with the remote control.	<ul style="list-style-type: none"> ● Depending on the model, some or all functions may not be operable using the remote control of this speaker. In this case, use the remote control supplied with the TV.

■ Condensation

Sudden temperature changes, storage or operation in an extremely humid environment may cause condensation inside the cabinet or on the transmitter on the remote control. Condensation can cause the speaker to malfunction. If this happens, leave the power on until normal operation is possible (about 1 hour). Wipe off any condensation on the transmitter with a soft cloth before operating the speaker.

■ If problem occurs

When this product is subjected to strong external interference (mechanical shock, excessive static electricity, abnormal supply voltage due to lightning, etc.) or if it is operated incorrectly, it may malfunction.

If such a problem occurs, do the following:

1. Set the speaker to the stand-by mode and turn the power on again.
2. If the speaker is not restored in the previous operation, unplug and plug in the speaker, and then turn the power on.

Maintenance

■ Cleaning the cabinet

Periodically wipe the cabinet with a soft cloth.

Caution:

- Do not use chemicals for cleaning (petrol, paint thinner, etc.). It may damage the cabinet finish.
- Do not apply oil to the inside of each component. It may cause malfunctions.

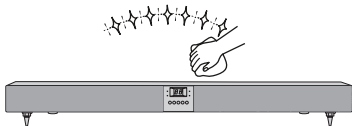

Error indicators and warnings

HT-SB200

When you fail to perform operations properly, the following messages are displayed on the speaker.

Display	Meaning
E1 or E2 or E3	● Malfunction of the surround circuit. Place the speaker away from noise source and plug the AC power lead into another wall socket. (*)
 Power indicator (blinks red)	● When the protection circuit of the amplifier is activated.

(*): Should the same message appear even if the speaker is unplugged and plugged in or is set to the stand-by mode and on again, contact your local dealer where you purchased the speaker.

Specifications

As part of our policy of continuous improvement, SHARP reserves the right to make design and specification changes for product improvement without prior notice. The performance specification figures indicated are nominal values of production speaker. There may be some deviations from these values in individual speaker.

■ General

Power source	DC IN 12V $\overline{\text{---}}$ 4A: AC/DC adaptor (AC 100 - 240 V ~ 50/60 Hz)
Power consumption	Power on: 10 W Power stand-by: 0.6 W (*)
Output power	Front speaker: RMS: 12 W (6 W + 6 W) (10% T.H.D.) RMS: 9.6 W (4.8 W + 4.8 W) (0.9% T.H.D.) Subwoofer: RMS: 20 W (10% T.H.D.) RMS: 13 W (0.9% T.H.D.)
Speaker	2.1-way Speaker System Front Speakers: 38 mm (1-1/2") Full Range Subwoofer: 57 mm (2-1/4") Woofer (x4)
Audio output terminals	Speakers: 12 ohms/channel Subwoofer: 3 ohms (12 ohms x 4 parallel connection)

Input terminals	Analogue input (LINE 1): RCA type x 1pair (L/R) 500 mV / 47 kohms Analogue input (LINE 2): Stereo mini socket \varnothing 3.5 mm 100 mV / 47 kohms
Dimensions	Width: 800 mm (31-1/2") Height: 96 mm (3-3/4") Depth: 70 mm (2-3/4")
Weight	1.75 kg (3.86 lbs.)

(*) This power consumption value is obtained when in the power stand-by mode.

MEMO

SHARP

SHARP CORPORATION



TINSEA290AWZZ

09A R AS ②