

SHARP®

POS TERMINAL

MODEL

UP-700

INSTRUCTION MANUAL

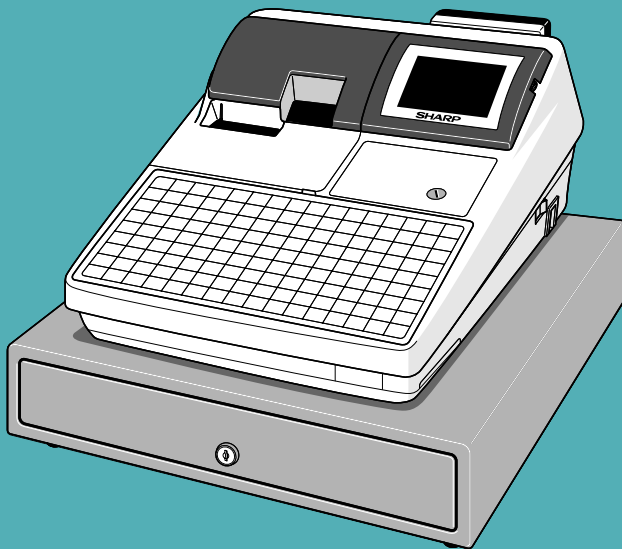

WARNING

FCC Regulations state that any unauthorized changes or modifications to this equipment not expressly approved by the manufacturer could void the user's authority to operate this equipment.

Note: This equipment has been tested and found to comply with the limits for a Class A digital device, pursuant to Part 15 of the FCC Rules. These limits are designed to provide reasonable protection against harmful interference when the equipment is operated in a commercial environment.

This equipment generates, uses, and can radiate radio frequency energy and, if not installed and used in accordance with the instruction manual, may cause harmful interference to radio communications. Operation of this equipment in a residential area is likely to cause harmful interference, in which case the user will be required to correct the interference at his own expense.

CAUTION

The socket-outlet should be installed near the equipment and should be easily accessible.

FOR YOUR RECORDS

Please record below the model number and serial number for easy reference in case of loss or theft. These numbers are located on the right side of the unit. Space is provided for further pertinent data.

Model Number _____

Serial Number _____

Date of Purchase _____

Place of Purchase _____

INTRODUCTION

Thank you very much for your purchase of the SHARP POS Terminal Model UP-700. Please read this Manual carefully before operating your machine in order to gain full understanding of functions and features. Please keep this manual for future reference. It will help you if you encounter any operational problems.

IMPORTANT

- **Install your POS terminal in a location that is not subject to direct sunlight, unusual temperature changes, high humidity or exposure to water sources and keep away from heat and magnetic sources.**
Installation in such locations could cause damage to the cabinet and the electrical components.
- **The POS terminal should not be operated by an individual with wet hands.**
The water could seep into the interior of the POS terminal and cause component failure.
- **Do not apply excessive pressure to the display.**
Do not use a sharp-pointed object on the display, or the LCD may become damaged.
- **When cleaning your POS terminal, use a dry, soft cloth. Never use solvents, such as benzine and/or thinner.**
The use of such chemicals will lead to discoloration or deterioration of the cabinet.
- **The POS terminal plugs into any standard wall outlet (120V \pm 10% AC) with a dedicated earth-ground.**
Other electrical devices on the same electrical circuit could cause the POS terminal to malfunction.
- **If the POS terminal malfunctions, call your authorized SHARP dealer for service - do not try to repair the POS terminal yourself.**
- **For a complete electrical disconnection, remove the AC power cord from the wall outlet.**

PRECAUTION

This POS terminal has a built-in memory protection circuit which is operated by a rechargeable battery pack. It should be known that all batteries will, in time, dissipate their charge even if not used. Therefore to insure an adequate initial charge in the protection circuit and to prevent any possible loss of memory upon installation, it is recommended that each unit be allowed to be charged for a period of 24 to 48 hours prior to use by the customer.

In order to charge the battery pack, the machine must be plugged in and its power switch must be set to the "ON" position. This charging precaution can prevent unnecessary initial service calls.

BATTERY DISPOSAL

Contains Nickel Metal Hydride Battery. Must be Disposed of Properly.

Contact Local Environmental Officials for Disposal Instructions.

CONTENTS

INTRODUCTION	1
IMPORTANT	1
PRECAUTION	1
1. Part Names and Functions	8
External View	8
Front view	8
Rear view	8
Printer	9
Keyboard	10
Inserting the keyboard sheet	10
Standard keyboard layout	10
Optional keys	11
Keys and Switches	13
Mode switch and mode keys	13
Drawer lock key	13
Printer cover lock key	13
Display	14
Operator display	14
Customer display	15
Screen save mode	15
2. Before Operating the POS Terminal	16
Display Adjustment	16
3. Time Display and Automatic Updating of the Date	17
4. Prior to Entries	18
Preparations for Entries	18
Error Warning	18
Sample Receipt	18
5. Entries	19
Server Code Entries	19
Item Selection from the Function Menu Windows	19
Item Entries	22
Single item entries	22
Repeat entries	23
Multiplication entries	24
Split-pricing entries	25
Successive multiplication entries	26
Scale entries	27
Single item cash sale (SICS) entries	29
Age verification (Birthday entry)	29
Link PLU/UPC entries	29
Mix-and-match function	30
Combo meal entries	30
Condiment entries (for PLU)	31
Repeat round entries	31
Price inquiry (view) function (for PLU/UPC)	32
UPC learning function	32
Price change function (for UPCs)	33
PLU level shift (for direct PLUs)	34
PLU/UPC price level shift	35
Display of Subtotals	36

Merchandise subtotal	36
Taxable subtotal	36
Including-tax subtotal	36
Tray subtotal	36
Eat-in subtotal	36
Food stamp-eligible subtotal	36
Group discountable subtotal	37
Gasoline discount subtotal	37
Finalization of Transaction	38
Cash or check tendering	38
Mixed tendering (check + cash)	38
Cash or check sale that does not need any tender entry	38
Charge (credit) sale	38
Mixed-tender sale (cash or check tendering + charge tendering)	38
Food stamp tendering	39
Food stamp status shift	39
Tax Calculations	40
Automatic tax	40
Manual tax	40
Tax deletion	40
Tax status shift	40
Guest Check (GLU/PBLU)	41
GLU/PBLU system	41
Deposit entries	43
Transferring guest checks out or in (Transfer-out/in)	43
Bill totalizing/bill transfer	44
Bill separating	45
Bill printing	45
Auxiliary Entries	46
Percent calculations (premium or discount)	46
Discount entries	46
Refund entries	46
Return entries	46
Printing of non-add code numbers	46
Refund sales mode	47
Group discount entries	47
Remote printer send function	48
Gratuity	48
Payment Treatment	48
Tip-in entries	48
Tip editing	49
Tip paid entries	49
Currency conversion	49
Received-on-account entries	50
Paid-out entries	50
No-sale (exchange)	51
Cashing a check	51
Customer management	52
WASTE mode	53
6. Correction	54
Correction of the Last Entry (Direct Void)	54
Correction of the Next-to-Last or Earlier Entries (Indirect Void)	55
Subtotal Void	56
Correction of Incorrect Entries Not Handled by the Direct or Indirect Void Function	56
7. Special Printing Functions	57
Printing Message Text for Remote Printer or Chit Receipts	57
Copy Receipt Printing	57

Validation Printing Function	58
Server Arrival/Departure Time Printing	58
8. Manager Mode	59
Override Entries	59
9. Correction after Finalizing a Transaction	60
10. Reading (X) and Resetting (Z) of Sales Totals	61
How to take a X1/Z1 or X2/Z2 reports	61
Flash report	61
Daily Sales Totals	64
Transaction report	64
Department report	67
Individual group total report on departments	68
Full group total report on departments	68
Department markdown report	68
PLU/UPC report by designated range	69
PLU/UPC pick up report	70
PLU/UPC report by associated department	71
Individual group total report on PLUs/UPCs	72
Full group total report on PLUs/UPCs	72
PLU/UPC stock report by designated range	72
PLU/UPC stock pick up report	72
PLU/UPC zero sales report (full)	73
PLU/UPC zero sales (by dept.) report	73
PLU/UPC minimum stock report	73
PLU/UPC price category report	74
Cash in drawer report	74
Positive check report	74
Dynamic UPC report by designated range	75
Dynamic UPC pick up report	75
Dynamic UPC report by associated department	76
Tax report	77
Key capture report	77
Individual server report	78
Full server report	79
Hourly report	80
GLU/PBLU report	81
GLU/PBLU report by server	81
Closed GLU/PBLU report	82
Closed GLU/PBLU report by server	83
X1/Z1 stacked reports	83
Periodic Consolidation	84
Transaction report	84
Daily net report	85
Customer sales report 1 and 2	86
Customer sales report by sales range	87
Customer charge account report	87
X2/Z2 stacked report	87
11. Non-accessed UPC and Customer Deletion	88
Non-accessed UPC report	89
Non-accessed customer report	89
Customer delete report	90
Dynamic UPC clear	90
12. How to Use the Programming Keyboard Sheet	91
Programming Keyboard Layout	91
How to Program Alphanumeric Characters	92

Using character keys on the keyboard	92
Entering character codes	93
13. Programming	94
Basic Instructions	94
Programming example	94
Article Programming	96
Department	97
PLU/UPC	99
Dynamic UPC	102
PLU range	102
PLU/UPC stock	103
Link PLU table (for PLU/UPC)	104
Condiment table	105
Mix & Match table	106
Combo meal table	107
Scale table	108
UPC Non-PLU code format	109
UPC delete	110
Direct Key Programming	111
Direct PLU/COMBO/Dept. key	111
PLU Menu Key Programming	113
PLU menu key	113
Functional Programming	114
Discount key (⊖1 thru ⊖5)	115
Percent key (%1 thru %5)	116
Group discount key (GDSC %1 thru GDSC %3)	117
Gas discount	118
Gratuity	119
Tip	119
RA	120
PO	121
Manual tax	121
Tax delete	122
No-sale	122
Void	123
Refund	123
Media Key Programming	124
Cash keys	125
Check keys	129
Charge keys	133
Food stamp tender key	137
Currency conversion keys	139
Eat-in keys	139
Service key	140
Final key	142
Cash in drawer	144
Check change	144
Check cashing	145
Text Programming	147
Function text	148
Department group text	150
PLU group text	150
Server group text	151
Message text	151
Personnel Programming	152
Server	152
Terminal Programming	153
Machine number	154

Consecutive number	154
Interval timer	154
Default menu level	155
Available GLU code	155
Bill number	155
Date/Time Setting	156
Date/time	156
Optional Feature Selection	157
Function prohibition	158
Function selection 1	160
Function selection 2	161
Printing selection	162
Secret Code Programming	163
Z1 reports	164
PGM2-mode operations	164
System Z1 reports	165
System PGM2-mode operations	165
Initial down-loading (with clearing of memory)	166
Maintenance down-loading (without clearing of memory)	166
Report Programming	167
Zero skip	168
Hourly report	168
Stacked report	169
Logo Text Programming	172
Receipt logo	173
Validation printing text	173
Bill logo	174
Device Configuration Programming	175
R/J printer (Built-in printer)	176
Bill (slip) printer	176
Report printer	177
Validation printer	177
Remote printer (KP#1 thru KP#9)	178
BCR (SCANNER)	179
GLU Code Programming	180
Customer Programming	181
Customer code	182
Customer programming	182
Negative Code File Programming	183
Negative code/Override status	183
Positive Code File Programming	184
Positive code	184
Macro Key Programming	185
Mode position/Auto key no.	185
Function Menu Key Programming	186
Function menu key	186
Capture Key Programming	187
Capture key data	187
Key Data Entry Job Table Programming	188
Capture job number	188
Tax Programming	189
Table tax	190
Rate (%) tax	192
Doughnut tax exempt (for the Canadian tax system)	192
TRAINING Mode Selection	193
TRAINING mode	193
Backup Data Send Programming	194
Backup data send	194
Backup Data Receive Programming	195
Backup data receive	195

PLU Updating (in the PGM1 Mode)	196
Automatic Sequencing Key Programming	197
Loading Dynamic UPC to the Main UPC File	198
Reading of Stored Programs	199
Program reading sequence	199
Sample printouts	200
Data Clear	212
14. Universal Product Code (UPC) or European Article Number (EAN)	213
UPC or EAN code	213
Add-on code	214
UPC file	214
15. Operator Maintenance	215
In Case of Power Failure	215
In Case of Printer Error	215
Thermal Printing	215
Cautions in handling the printer	215
Cautions in handling the recording paper	216
Installing and Removing the Paper Roll	217
Recording paper specifications	217
Installing the paper roll	217
Removing the paper roll	218
Removing the paper jam	220
Cleaning the Print Head	221
Removing the Till and the Drawer	222
Operating the Drawer by Hand	222
Before Calling for Service	223
16. Options	223
List of Options	223
17. Specifications	224

1

Part Names and Functions

This chapter describes the part names and functions of this POS terminal.

External View

■ Front view

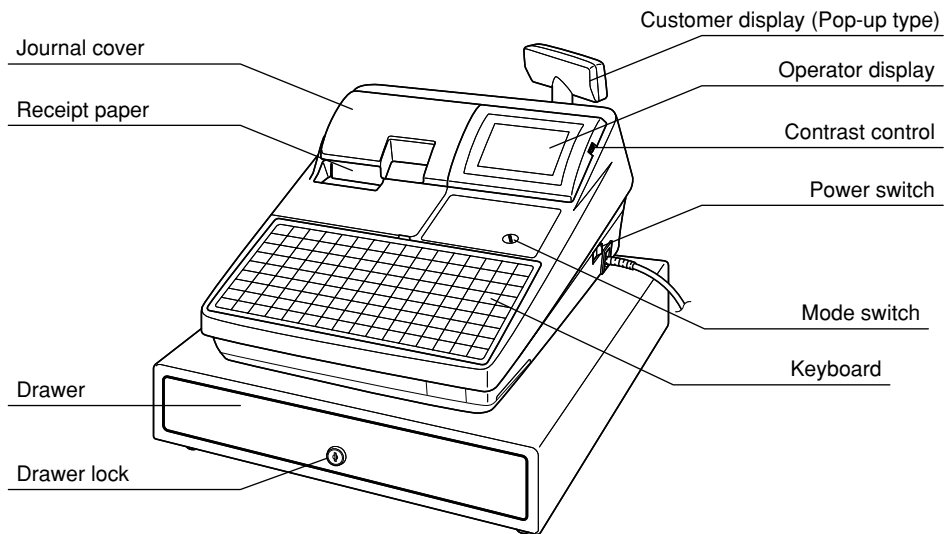

■ Rear view

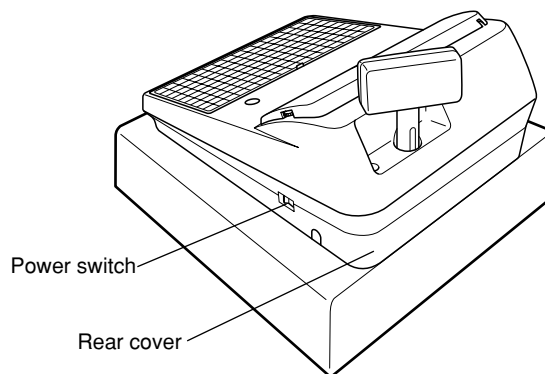

Printer

The printer is a receipt/journal dual station type thermal printer, and therefore it does not require any type of ink ribbon or cartridge. The average life of the printer is approximately 5 million lines.

When opening the printer cover, unlock the printer cover using the printer cover lock key, and lift up the cover as shown on the right sketch.

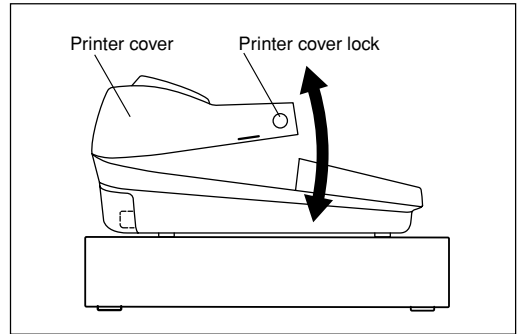

Your register is shipped with the print head release lever held by a white retainer in the lifted up position. Be sure to remove this retainer (see the figure at the right) and push down the print head release lever before you use the POS terminal.

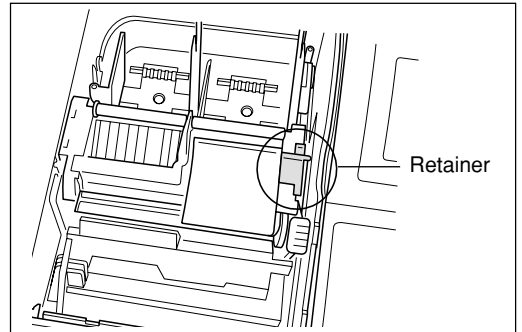

Print head release lever

The print head can be lifted by the green lever on the right side of the printer. The release lever is a 2 position lever which allows you to proceed with the removal of paper.

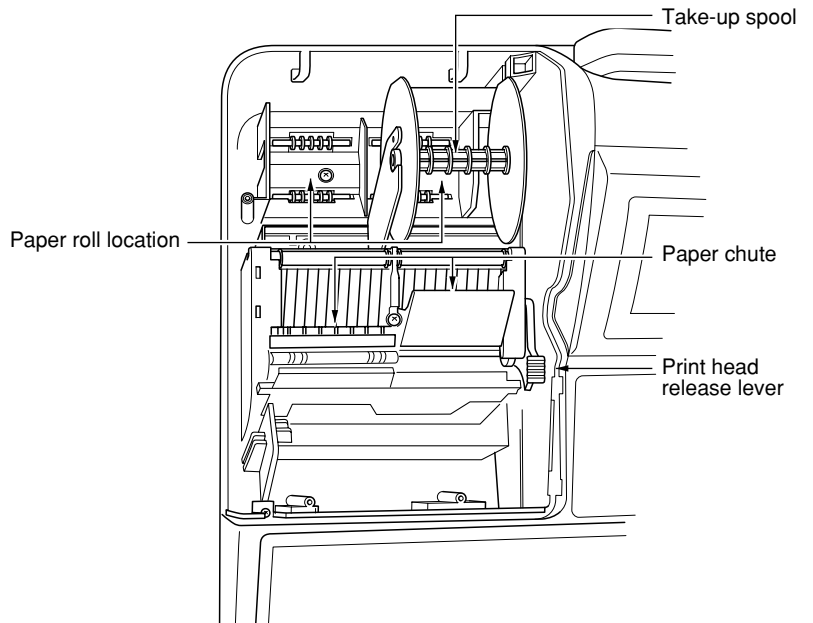

NOTE

Do not attempt to remove the paper roll with the head in the down position. This may result in damage to the printer and/or print head.

Keyboard

■ Inserting the keyboard sheet

Insert the keyboard sheet between the keyboard cover and the cabinet as illustrated below, then push the tabs at the top of the keyboard cover into the slots in the cabinet.

NOTE

- Do not spread the keyboard cover too far as it might tear the tabs.
- Replace the keyboard sheet with a new one if by chance it gets wet. Use of a wet keyboard sheet may cause problems.
- Be sure to use only SHARP-supplied keyboard sheets. Thick or hard sheets make key operations difficult.
- Place the keyboard sheet evenly under the keyboard cover.
- If you require a new keyboard sheet, please contact your dealer.
- The keyboard cover will eventually wear out. If your keyboard cover is dirty or broken, replace the cover with a new one. For details, contact your authorized SHARP dealer.

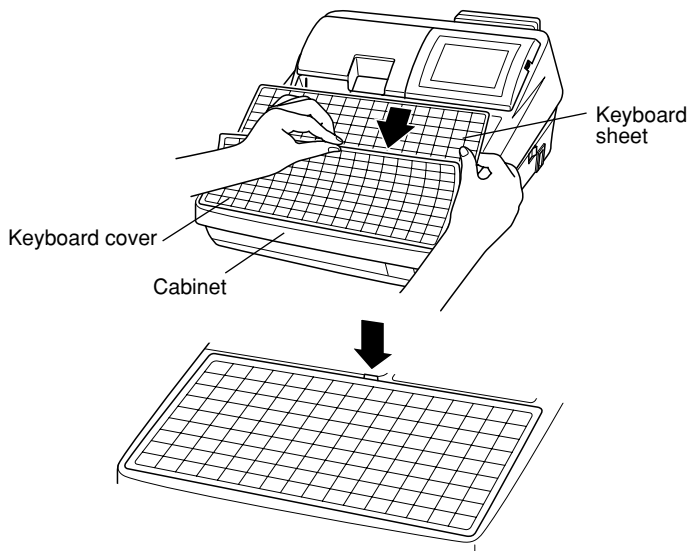

■ Standard keyboard layout

↑ RECEIPT	↑ JOURNAL	87	88	89	90	91	92	93	94	95	96	97	98	99	100
71	72	73	74	75	76	77	78	79	80	81	82	83	84	85	86
58	59	60	61	62	63	64	65	66	67	68	69	70	MISC FUNC	AUTO 1	NC
48	49	50	51	52	53	54	55	56	57	RCPT	VOID	RFND	CANCEL	LEVEL #	CONV #
38	39	40	41	42	43	44	45	46	47	SERV #	@/ FOR	•	CL	P-SHIFT #	TAX SHIFT
28	29	30	31	32	33	34	35	36	37	PAGE UP	7	8	9	PLU/ SUB	GLU
18	19	20	21	22	23	24	25	26	27	PAGE DOWN	4	5	6	CHK #	SRVC
9	10	11	12	13	14	15	16	17	↑	ENTER	1	2	3	CH #	FINAL
1	2	3	4	5	6	7	8	←	↓	→	0	00	000	SBTL	CA/AT

NOTE

- All the keys but the receipt paper feed and journal paper feed keys can be re-positioned. If you want to change the layout, contact your authorized SHARP dealer.
- Keyboard layout is subject to change without notice.

	Receipt paper feed key		Service key
	Journal paper feed key		Final key
~	Numeric keys		Guest lookup key
~			Server code entry key
	Decimal point key		Automatic sequencing 1 key
	Clear key		Miscellaneous function menu key
	Multiplication key		Currency conversion menu key
	Receipt print key		Price shift menu key
	Tax 1 shift key		Charge menu key
	Refund key		Check menu key
	Void key		Subtotal key
	Price lookup/subdepartment/ UPC key		Cash/amount tendered key
~	Direct price lookup keys		Page up/down keys
	PLU level shift menu key		Cursor (up/down/right/left arrow) keys
	Enter key		
	New check key		Cancel key

NOTE

The following optional keys can optionally be mounted in place of those shown in the figure of the standard keyboard layout. For details, please consult your authorized SHARP dealer.

Optional keys

	Dept. number key	~	Check 1 thru 5 keys
~	Direct price lookup keys		Transfer out key
~	Department keys		Transfer in key
%1 key"/> ~ %5 key"/>	Percent 1 thru 5 keys		Cash tip key
~	Discount 1 thru 5 keys		Charge tip key
~	Charge 1 thru 9 keys		Tip paid key
~	Cash 2 thru 5 keys	~	Eat in 1 thru 3 keys
~	Conversion 1 thru 4 keys	~	Tax 2 thru 4 shift keys
	Received-on-account 1 and 2 keys		Deposit key
	Paid-out 1 and 2 keys		Deposit refund key
~	Automatic sequencing 2 thru 25 keys		Manual tax key

BACK SPACE	Backspace key	RP SEND	Remote printer send key
DELETE	Delete key	GRT EX	Gratuity exempt key
NEXT \$	Next higher dollar key	OPEN TARE	Tare entry key
MDSE SBTL	Merchandise subtotal key	BAL	Balance key
TRAY SUBTL	Tray subtotal key	REPEAT	Repeat entry key
RTN	Return key	IND. PAYMENT	Individual payment key
GAS SBTL	Gasoline sales subtotal key	AMT	Amount entry key
#/TM	Non-add code/Date & time display key	INQ	Inquiry key
NS	No-sale key	CUST	Customer code entry key
SCALE	Scale entry key	PRICE CHANGE	UPC price change key
LEVEL 1 ~ LEVEL 5	PLU level shift 1 thru 5 keys	BIRTH	Birthday entry key
P-SHIFT 1 ~ P-SHIFT 6	Price level shift 1 thru 6 keys	TABLE #	Table no. (seat no.) entry key
FS SHIFT	Food stamp shift key	VOID MENU	Void menu key
GD1 SHIFT ~ GD3 SHIFT	Group discount shift 1 thru 3 keys	RFND SALE	Refund sale key
PRINT	Validation print key	RCP SW	Receipt ON/OFF key
BILL	Bill print key	WASTE	Waste mode key
PAST VOID	Past void key	C NEXT	Condiment next key
SBTL VOID	Subtotal void key	EDIT TIP	Edit tip key
GDSC %1 ~ GDSC %3	Group discount %1 thru 3 keys	RP ROUND	Repeat round key
COVER CNT	Cover count entry key	GLU RECALL	Table# recall key
BS	Bill separation key	MSG 1 ~ MSG 5	Message 1 thru 5 keys
BT	Bill totalize/Bill transfer key (CHECK-ADD)	MSG MENU	Message menu key
FS TEND	Food stamp tender key	PLU MENU1 ~ PLU MENU50	PLU menu 1 thru 50 keys
CASH MENU	Cash menu key	MACRO 1 ~ MACRO 4	Macro 1 thru 4 keys
FUNC. MENU	Function menu key	UPSIZE	Upsize key
		CAP.1 ~ CAP.10	Data capture 1 thru 10 key

Keys and Switches

■ Mode switch and mode keys

The mode switch can be operated by inserting one of the three supplied mode keys - manager (MA), submanager (SM), and operator (OP) keys. These keys can be inserted or removed only when the switch is in the “REG” or “OFF” position.

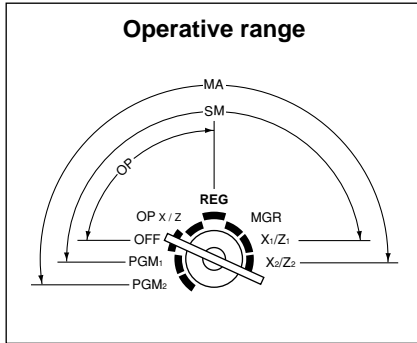

• Manager key (MA)

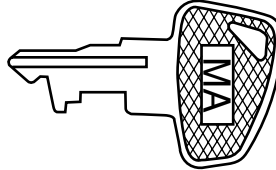

• Submanager key (SM)

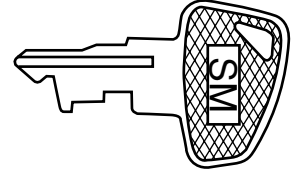

• Operator key (OP)

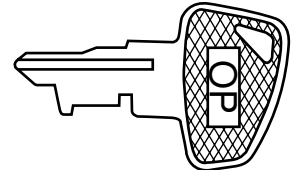

The mode switch has these settings:

OFF: This mode locks all register operations. No change occurs to existing data.

OP X/Z: This setting allows cashiers/servers to take X or Z reports for their sales information. (This setting may be used only when your register has been programmed for “OP X/Z mode available” in the PGM2 mode.)

REG: For entering sales

PGM1: To program those items that need to be changed often: e.g., unit prices of departments, PLUs or UPCs, and percentages

PGM2: To program all PGM1 items and those items that do not require frequent changes: e.g., date, time.

MGR: For manager's and submanager's entries

The manager can use this mode to make entries that are not permitted to be made by cashiers/servers - for example, after-transaction voiding and override entries.

X1/Z1: To take the X/Z report for various daily totals

X2/Z2: To take the X/Z report for various periodic (weekly or monthly) consolidation of totals.

■ Drawer lock key

This key locks and unlocks the drawer. To lock it, turn 90 degrees counterclockwise. To unlock it, turn 90 degrees clockwise.

This same key is also used to open the cash drawer.

(Please refer to “15. Operator Maintenance — Operating the Drawer by Hand”).)

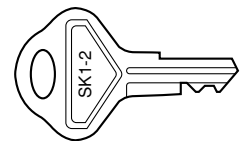

■ Printer cover lock key

This key locks and unlocks the printer cover. To lock it, turn 90 degrees counterclockwise. To unlock, turn 90 degrees clockwise.

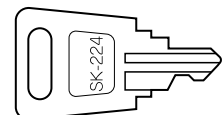

Display

■ Operator display

- Screen example 1 (REG mode)

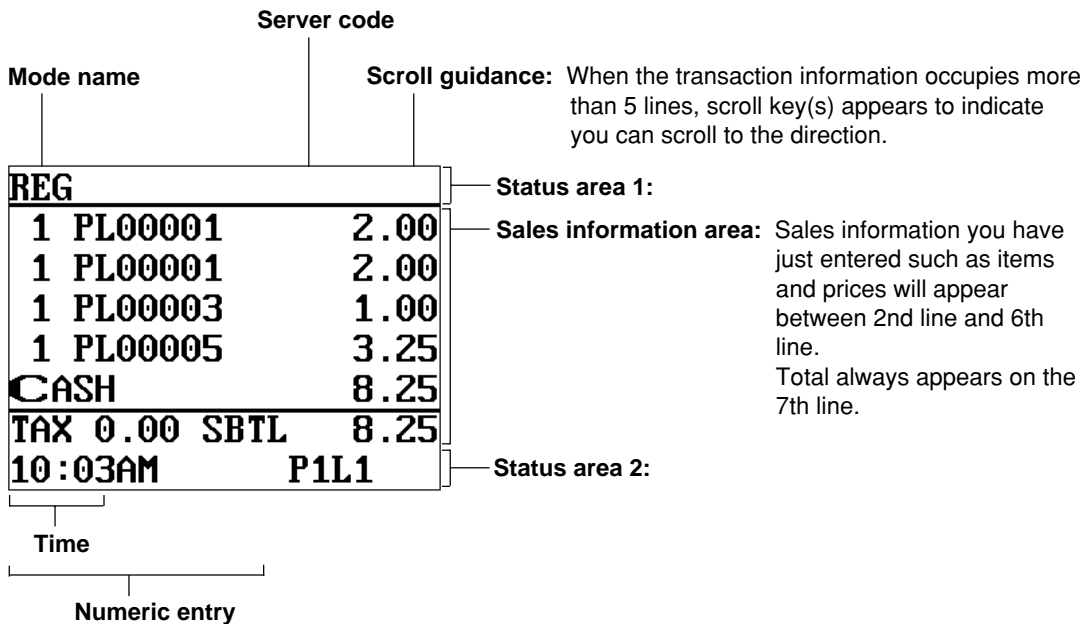

Price level shift indicator (P1-P6)

: Shows the PLU/UPC price level currently selected.

PLU level shift indicator (L1-L5)

: Shows the PLU level currently selected.

Receipt shift indicator (r)

: Shows the receipt shift status.

T-Log near full indicator (■)

: Appears (○) when the used memory is 80%.

: Appears (◐) when the used memory is 90%.

: Appears (◑) when the used memory is 95%.

Stock alarm indicator (!)

: Appears when the stock of the PLU which you entered is zero, negative or reaches the minimum stock.

Receipt ON/OFF status indicator (R)

: Appears when the receipt ON-OFF function signs OFF.

Sentinel mark (X)

: Appears in the lower right corner of the screen when the cash in drawer exceeds a programmed sentinel amount. The sentinel check is performed for the total cash in drawer.

• Screen example 2 (PGM mode)

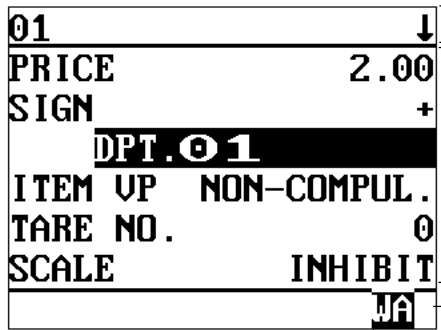

Programming item information area

Programming area:
Programmable items are listed.

Caps lock indicator (A/a):

The upper-case letter "A" appears when caps lock is on, and the lower-case letter "a" appears when the caps lock is off during text programming.

Double-size character mode indicator (W):

Appears when the double-size character mode is selected during text programming.

■ Customer display (Pop-up type)



■ Screen save mode

When you want to save the electrical power or the display's life, your POS terminal is provided with the screen save function. This function can turn the LCD backlight off when servers do not operate the POS terminal for an extended period of time. You can program the time for which your POS terminal should keep the normal status (in which the backlight is "ON") before it goes into the screen save mode. To exit the screen save mode, press any key.

2

Before Operating the POS Terminal

This chapter describes those steps required prior to using the POS terminal for the first time.

Display Adjustment (operator display)

You can adjust the contrast of the display by using the contrast control. To further the operator's view, the display may be tilted forward using the LCD display tilt tab.

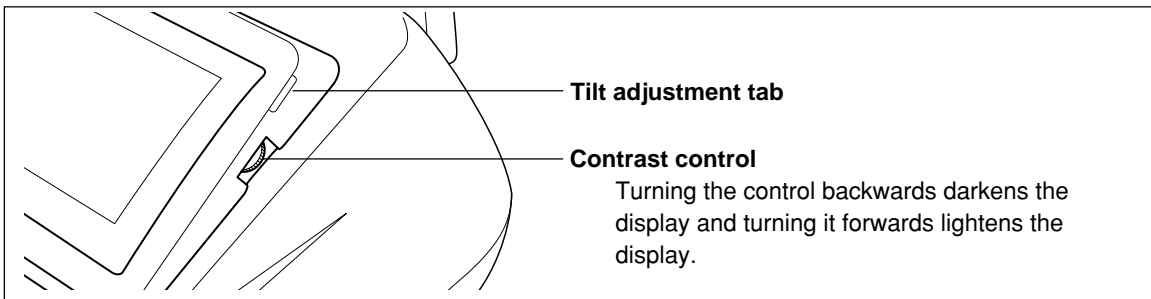

The backlight in the display is a consumable part. When the LCD display may no longer be adjusted and becomes darker, you should change the backlight. Consult your authorized SHARP dealer for further details.

3

Time Display and Automatic Updating of the Date

Time display

When you need the time displayed, press the **#/TM** key while the POS terminal is in the REG or MGR mode. The time display disappears as soon as you press the **CL** key in the REG or MGR mode or begin a subsequent entry.

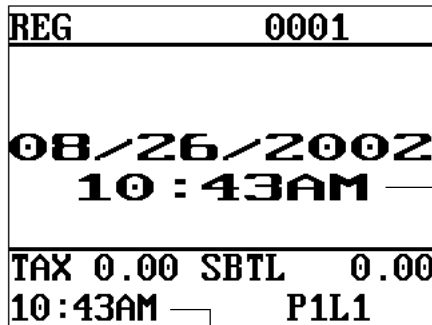

Date } This display appears by pressing
Time } the **#/TM** key.

Time (This display is held, even if the **CL** key is pressed.)

Automatic updating of the date

Once the internal clock unit is started at the desired time, it continues to run as long as the battery pack is charged and will also update the date based on the calendar year.

4

Prior to Entries

REG MODE

Preparations for Entries

■ Receipt and journal paper rolls

If the receipt and journal paper rolls are not set in the machine or the existing rolls are low in supply, install new ones according to section "Installing and Removing the Paper Roll" under "Operator Maintenance."

■ Receipt ON/OFF function

You can disable receipt printing in the REG mode to save paper using the receipt function. To disable receipt printing, press the **MISC FUNC** key and select RCP S.W. from the menu and turn the receipt OFF by press the **⏏** key. When the function is in the OFF status, the receipt off indicator "R" is highlighted.

NOTE Your register will print reports regardless of the receipt state. This means that the receipt roll should be installed even when the receipt state is "OFF".

Error Warning

In the following examples, your POS terminal will go into an error state accompanied with a warning beep and the error message on the display. Clear the error state by pressing the **CL** key and take the proper action to remedy the problem.

- When you exceed a 32-digit number (entry limit overflow):
Cancel the entry and re-enter a correct number.
- When you make an error in key operation:
Clear the error and try the entry again.
- When you make an entry beyond a programmed amount entry limit:
Check to see if the entered amount is correct. If it is correct, it may be possible to enter it in the MGR mode. Please contact your manager.
- When an including-tax subtotal exceeds eight digits:
Clear the error display by pressing the **CL** key and press a media key to finalize the transaction.

Sample Receipt

The print format will vary depending on the printer you use.

YOUR RECEIPT THANK YOU				
Date	08/27/2002	123456	Machine no.	
Consecutive no.	#1054	10:27AM	JACK0001	Server name/server code
Item entry	PLO0002	\$2.50		Time
	PLO0005	\$7.20		
	PLO0003	\$5.70		
	MDSE ST	\$15.40		
	TAX1	\$0.93		
	***TOTAL	\$16.33	Sales total	
	CASH	\$20.00	Cash amount tendered	
	CHANGE	\$3.67	Change due	

Server Code Entries

Prior to an item entry, the server will be compelled to enter his or her assigned server code. However, this may not be necessary when the POS terminal has been programmed for “stay-down server mode.”

Procedure

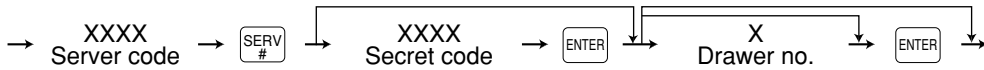

NOTE

- When the server entry system is programmed for “stay-down server mode,” no other server can sign on unless the server who has signed on is signed off.
- When the server entry system is programmed for “automatic server sign-off mode,” a server must sign on prior to each sales transaction.

The sign-off operation can be performed by using the following procedure in the REG or MGR mode.

To sign off a server: →

- Depending upon how your POS terminal has been preset, if the item entry is made when the server is signed off, the server entry will be prompted on the window and the server entry will be compelled.

REG	
SERVER NOT ASSIGNED	
TAX 0.00	SBTL 0.00
P1L1	

Item Selection from the Function Menu Windows

Your POS terminal allows you to select functions from specified function menu windows depending upon the terminal set up. For example, if you want to finalize a check 1 sale, select the option “CHECK1” from the “CHK.MN” Menu instead of pressing the key.

Each menu can be opened as follows:

• Miscellaneous function menu window

MISC FUNC	→	M.FUNC ↓
01	RCP S.W.	
02	***RA	
03	***RA2	
04	***PO	
05	***PO2	
TAX 0.00 SBTL		0.00
		P1L1

• Check menu window

CHK #	→	CHK.MN
1	CHECK1	
2	CHECK2	
3	CHECK3	
4	CHECK4	
5	CHECK5	
TAX 0.00 SBTL		1.50
		P1L1

• Cash menu window

CASH MENU	→	CA.MN
1	CASH	
2	CASH2	
3	CASH3	
4	CASH4	
5	CASH5	
TAX 0.00 SBTL		1.50
		P1L1

• Void menu window

VOID MENU	→	UD.MN
1	DIR UD	
2	PAST UD	
3	SBTL UD	
TAX 0.00 SBTL		1.50
		P1L1

• Message menu window

MSG MENU	→	REG 0001
1	MESSAGE 1	
2	MESSAGE 2	
3	MESSAGE 3	
4	MESSAGE 4	
5	MESSAGE 5	
TAX 0.00 SBTL		1.50
		P1L1

• Charge menu window

CH #	→	CHG.MN ↓
1	CHARGE1	
2	CHARGE2	
3	CHARGE3	
4	CHARGE4	
5	CHARGE5	
TAX 0.00 SBTL		1.50
		P1L1

• Conversion menu window

CONV #	→	CONV.MN
1	CONV 1	
2	CONV 2	
3	CONV 3	
4	CONV 4	
TAX 0.00 SBTL		1.50
		P1L1

• Function menu window

FUNC MENU	→	FNC.MN ↓
01	%1	
02	%2	
03	%3	
04	%4	
05	%5	
TAX 0.00 SBTL		0.00
		P1L1

Example

Selling the PLU no.1 item and finalizing through check 1

REG	0001
1 PL00001	2.50
TAX 0.15 SBTL 2.65	
P1L1	

1. Press the key.

CHK.MN	
1 CHECK1	
2 CHECK2	
3 CHECK3	
4 CHECK4	
5 CHECK5	
TAX 0.15 SBTL 2.65	
P1L1	

2. Press the key.

- The CHECK menu window will appear.

3. Select "CHECK1."

REG	0001
1 PL00001	2.50
ENTER AMOUNT	2.65
TAX 0.15 SBTL 2.65	
P1L1	

4. Enter the amount.

Item Entries

■ Single item entries

Department entries (direct department entries)

Enter a unit price and press the department key.

If you use a programmed unit price, press the department key only.

Procedure

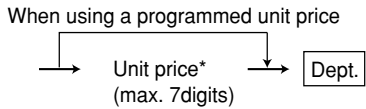

*Less than the programmed upper limit amount

NOTE

When those departments where the unit price has been programmed as zero (0) are entered, only the sales quantity is added.

Department entries (indirect department entries)

Procedure

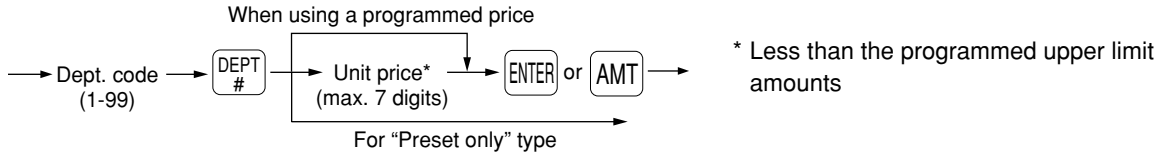

PLU entries (indirect PLU entries)

Enter a PLU code and press the key.

Procedure

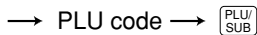

NOTE

When those PLUs for which the unit price has been programmed as zero (0) are entered, only the sales quantity is added.

Subdepartment (open PLU) entries

Procedure

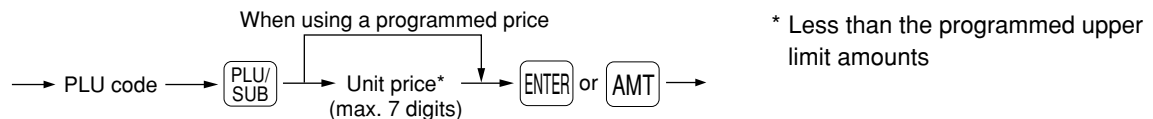

PLU entries (direct PLU entries)

Procedure

When using a programmed price

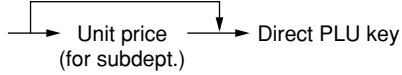

PLU menu-based entries (PLU entries and subdepartment entries)

Follow this procedure:

Procedure

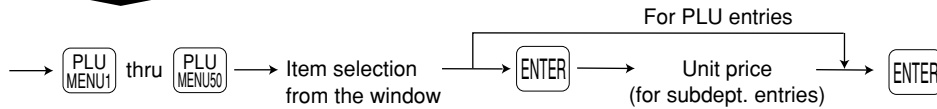

UPC entries

Procedure

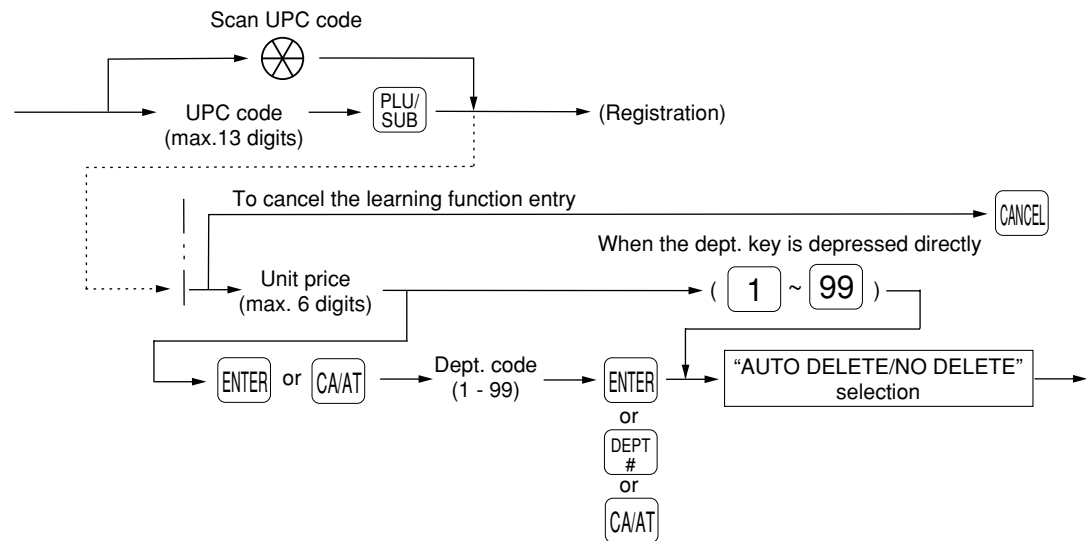

Repeat entries

You can use this function for repetitive entries of the same items. Simply press the repeat function key after valid item entries.

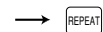

■ Multiplication entries

Use this feature when you need to enter two or more of the same items.

This feature helps you when you sell large quantities of items or need to enter quantities that contain decimals.

Procedure

FF method (for quick multiplication of direct PLUs)

Q'ty → Direct PLU PLU entry (direct)

- The FF (fast food) method cannot be used for a COUPON-LIKE PLU entry.

Normal method

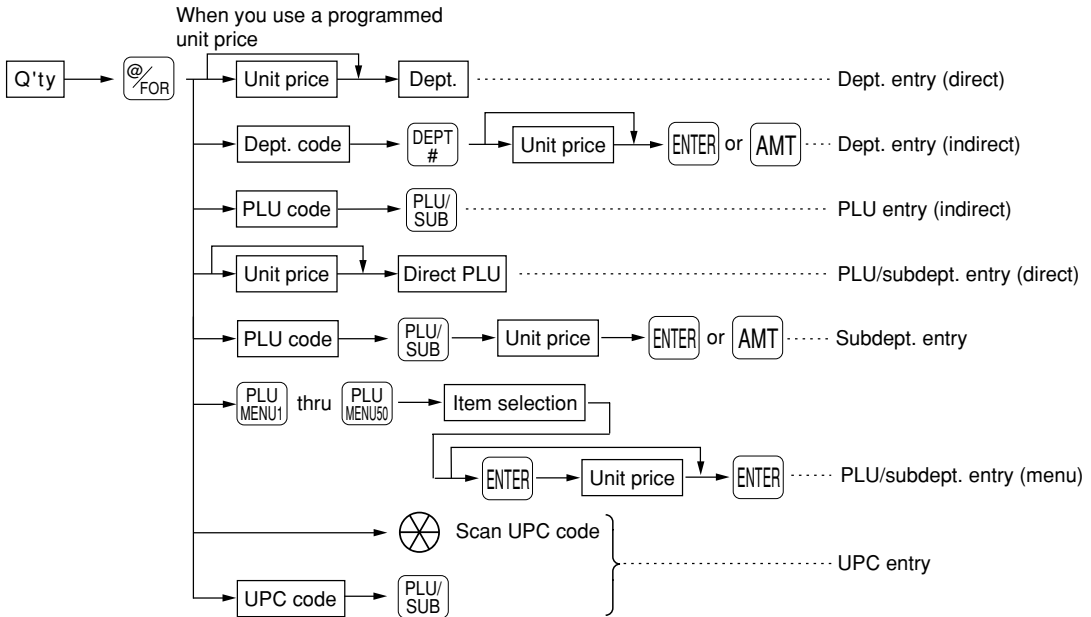

- With the learning UPC function, after scanning a UPC code or pressing the **PLU/SUB** key, you may be required to enter a unit price with the display "UNDEFINED CODE". Enter the unit price and department code that the UPC is to be associated to.
- Q'ty: Up to four digits integer + three digits decimal
- Unit price: Less than the programmed upper limit
- Q'ty x unit price: Up to seven digits

■ Split-pricing entries

You will use this function when your customer wants to purchase items normally sold in bulk.

Procedure

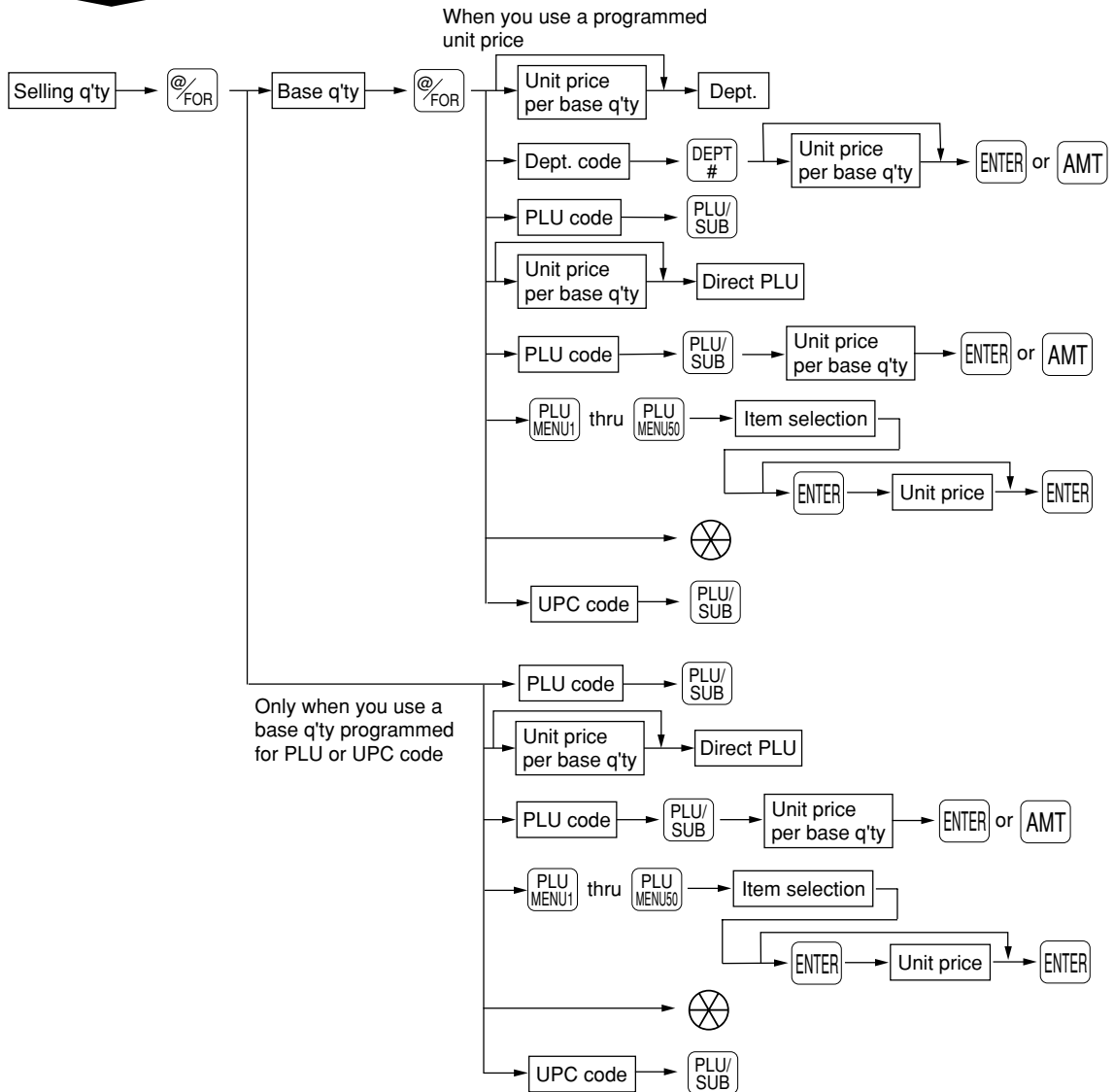

- With the learning UPC function, after scanning a UPC code or pressing the $\frac{\text{PLU}}{\text{SUB}}$ key, you may be required to enter a unit price with the display “UNDEFINED CODE”. Enter the unit price and department code that the UPC is to be associated to.
- Selling quantity: Up to four digits integer + three digits decimal
- Base quantity: Up to two digits (integer)

NOTE For actual use of this function, please consult your dealer.

■ Successive multiplication entries

This function is practical for such entries as a sale of an item sold by area (square foot).

Procedure

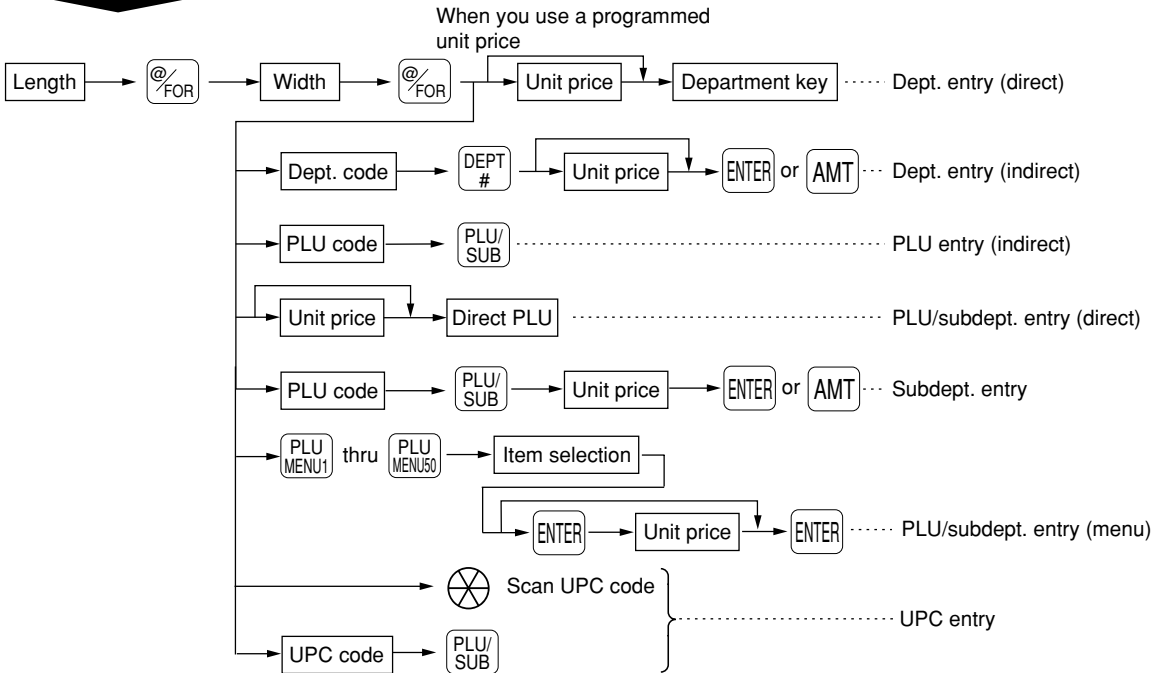

- With the learning UPC function, after scanning a UPC code or pressing the **PLU/SUB** key, you may be required to enter a unit price with the display "UNDEFINED CODE". Enter the unit price and department code that the UPC is to be associated to.
- Length or width: up to seven digits (4-digit integer + 3-digit decimal)
- Unit price: less than the programmed upper limit
- Length x Width x Unit price: up to seven digits

NOTE For actual use of this function, please consult your dealer.

■ Scale entries

For making entries for weighed items, a scale must be connected where by the weight is automatically read from the scale. To make refund entries, the weight is entered manually while the scale platter is empty and reads zero.

i) Auto scale entries

Procedure

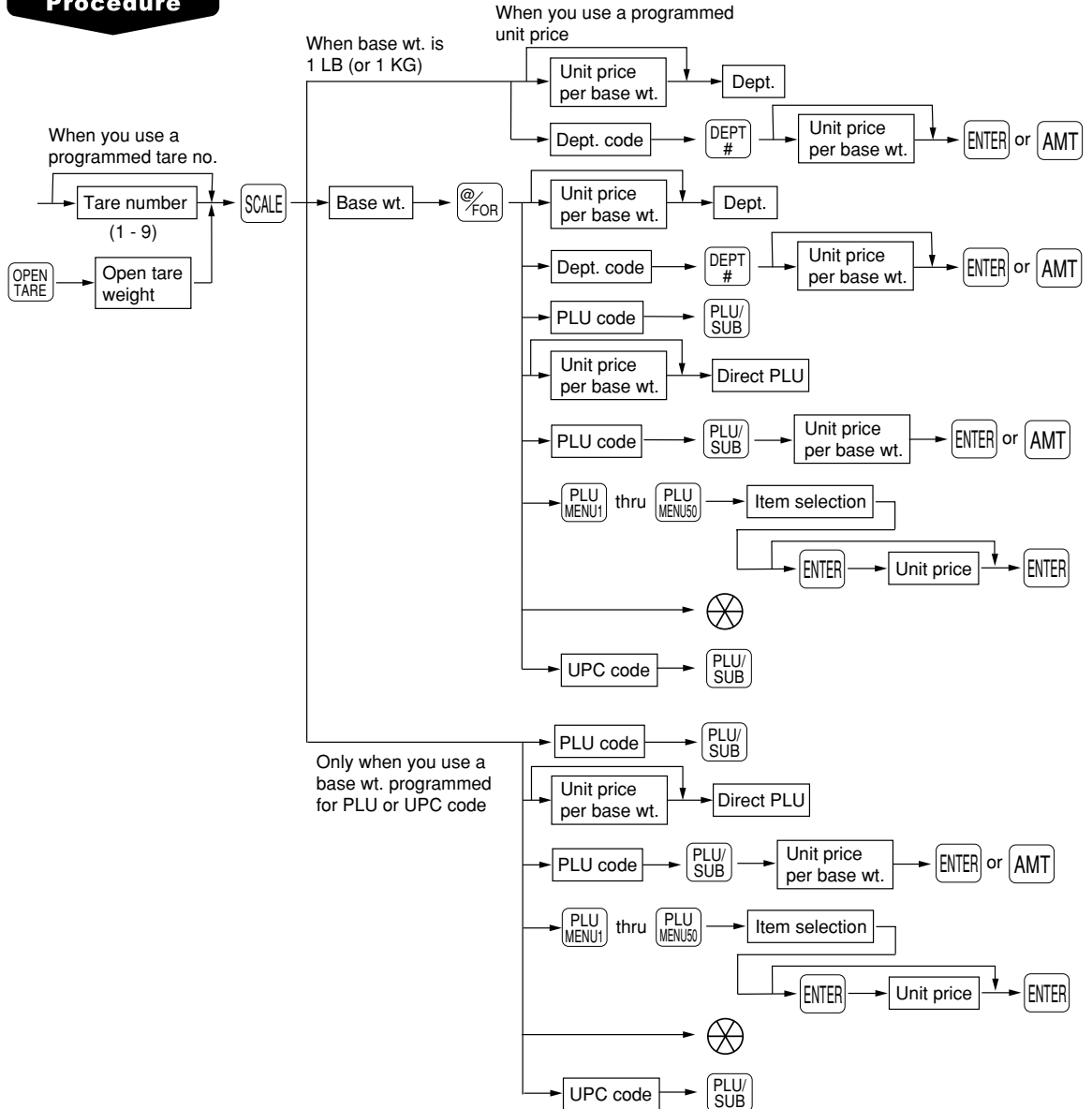

- Open tare weight: Up to 5 digits (integer + decimal)
- Net weight: Up to 5 digits (integer + decimal)
- Base weight: Up to 2 digits (integer)

NOTE

- The register can be programmed with up to nine tare tables and allows different tares to be assigned to them.
- When the **SCALE** key is pressed, the weight is automatically read from the connected scale (option) and the net weight appears in the register display.
- When the item is programmed for "Scale compulsory", it is not necessary to press the **SCALE** key.

ii) Manual scale entries for refunds only

Procedure

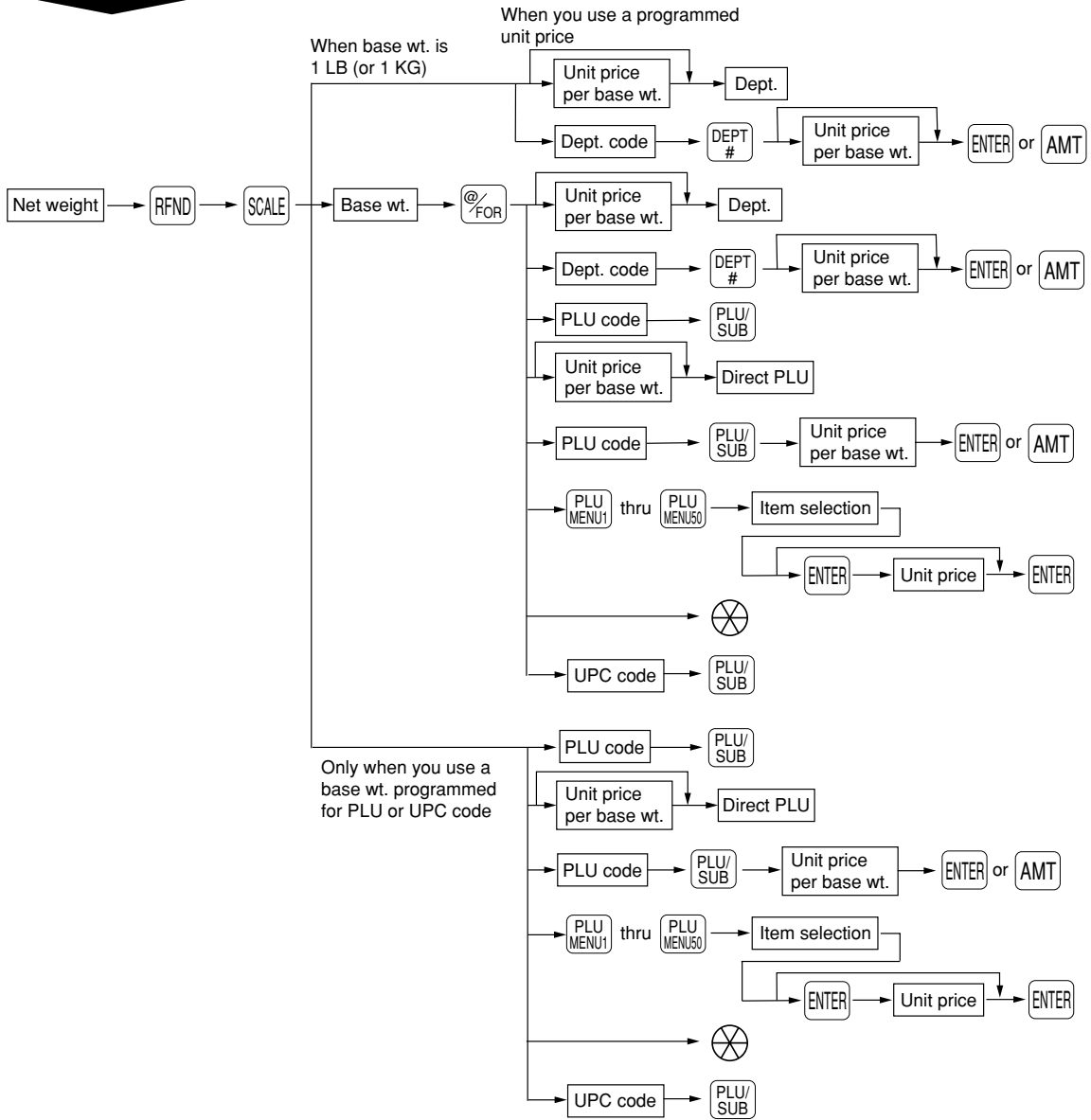

- Net weight: Up to 5 digits (integer + decimal) which is from the customer's receipt.
- Base weight: Up to 2 digits (integer)

■ Single item cash sale (SICS) entries

SICS entries

- This function is useful when a sale is for only one item and is for cash; such as a pack of cigarettes. This function is applicable only to those departments that have been set for SICS or to their associated PLUs, subdepartments or UPCs.
- The transaction is finalized and the drawer opens as soon as you press the department key, **AMT** key, **PLU/SUB** key or the direct PLU key.

NOTE *If entries to a department, PLU/subdepartment or UPC set for SICS follows entries to departments, PLUs/subdepartments or UPC not set for SICS, it does not finalize and results in a normal sale.*

SIF entries

- If entries to a department, PLU/subdepartment or UPC set for SIF follows entries to departments, PLUs/subdepartments or UPC not set for SIF, the transaction is finalized immediately as a cash sale.
- Like the SICS function, this function is available for single-item cash settlement.

■ Age verification (Birthday entry)

The age verification function is used for prohibiting the selling of goods (departments, PLUs, or UPCs) for certain aged persons based on a registered birthday.

When a department/PLU/UPC for which a figure other than zero (01 to 99) has been programmed as the age limitation is entered (in years), a birthday entry must be completed.

Procedure

→ XXXXXX → **BIRTH**

Birthday (five or six digits)

- NOTE**
- A birthday entry can be performed two or more times at any point during a transaction, however the last entered birthday remains in effect.
 - You can enter the date as far back as 98 years.
*[Ex.] When the current year is 1998 : you can enter the year 1900-1998.
When the current year is 2001 : you can enter the year 1903-2001.*

■ Link PLU/UPC entries

The operation is the same as normal PLU's/UPC's. When this PLU/UPC is entered, the linked PLU's amount is included and the linked PLU's label is printed automatically. Only the 1st PLU is affected by the status shift keys (**TAX1 SHIFT**, **TAX2 SHIFT**, **TAX3 SHIFT**, **TAX4 SHIFT** or **FS SHIFT** keys). The percent calculation is in effect for the amount of the 1st linked PLU.

■ Mix-and-match function

This function is convenient for matching several PLU/UPC items and selling them in together (e.g. bundle sale, multi-packed sale, etc.). The base q'ty and unit price are assigned to a mix-and-match table. All items that are programmed into the same table are treated as if they belong to one group.

■ Combo meal entries

The operation is the same as a for normal PLU entry.

When a combo meal is entered with the Combo function keys, the labels of those PLUs linked to the Combo key can be printed automatically. The sum of all adjusted prices (of those PLUs linked to the Combo key) becomes the "combo meal" price that is registered.

NOTE

- *When combo meal is registered, the q'ty totalizer of the combo key and amount totalizer of each PLU are updated.*
- *When the  key is pressed under the cursor pointing a combo meal, the combo meal entry of 1st price level is voided and the new combo meal of 2nd price level is registered.*

■ Condiment entries (for PLU)

Your POS terminal may be programmed for prompting condiment and preparatory instructions for a menu-item PLU.

Example:





When you enter a menu-item PLU, a prompting message such as “HOWCOOK?” and a list of the “Following PLUs” will appear. You must specify one of the “Following PLUs” such as “without mustard” to meet a special order of the guest. In an example of the condiment table shown below, it is assumed that the condiment table no.1 is assigned to PLU code 21 (programmed text “STEAK”) and table no. 4 is assigned to table no. 1 as the next table no. When you enter the PLU code 21, the message “HOWCOOK?” will appear to prompt you to specify one of “RARE,” “MED.RARE,” and “WELLDONE.” If the guest chooses “RARE,” select it from the list. Then the next message “POTATO?” will appear to prompt you to specify one of “P.CHIPS,” “MASHED.P,” and “BAKED.P.” If the guest chooses “MASHED.P,” select it. Then press the  key to end this entry.

Here is an example of how to perform a condiment entry when your condiment table is as shown below.

Table number	PLU codes for condiment entry (programmed text, price)				Next table no.
1	(HOWCOOK?)	23 (RARE 0.00)	25 (MED.RARE 0.00)	27 (WELLDONE 0.00)	4
4	(POTATO?)	33 (P. CHIPS 0.60)	37 (MASHED.P 0.60)	38 (BAKED.P 0.50)	_____



Menu-item PLUs
Message text
PLUs

NOTE



- Your POS terminal will continue to prompt for the condiment entry until you finish the entire condiment entry programmed for the PLU. During the condiment entry, if you enter a normal PLU, which is not in the condiment table, an error message will appear.
- When the  key is pressed, the entry skips to the next table which is programmed.
- When the  key is pressed, its condiment entry is canceled in the programmed mode (REG/MGR or MGR).
- When you enter a PLU priced at “0.00,” only the text may be printed on the receipt.
- No refund entry is possible for any condiment entries. When you perform a refund entry with a menu-item PLU the condiment PLUs assigned to the menu-item PLU are automatically registered as a refund entry.
- You may omit the compulsory condiment entry by pressing the  key.
- The cursor void entry is allowed for those PLUs that are entered as condiments (menu and condiment).
- The multiplication entry can be made for each condiment item independently. However, the sum of the entered quantity per condiment table have to be same or below a menu PLU registration. When no multiplication entry is made, the quantity is decided automatically to reach the number of the menu PLU registration.
- You can press the  key to shift a price level during the condiment PLU entry.

■ Repeat round entries

This function can be used for reorder entries of PLU items (single PLU item and condiment PLU) simply by depressing the  key. To use this function, the PLU must be preset as “yes” for repeat entries.

At the first depression of the  key, those items that were previously registered in a transaction are subjected for reordered items, and at the second depression of the  key, those items that are registered after the previous depression of the  including the items of first reordered items are subjected for reorder items.

NOTE

When the  key is pressed just after the depression of the  key, all items subjected to the repeat round entry are voided.

■ Price inquiry (view) function (for PLU/UPC)

You can use this function when you want to know the unit price of the PLU/UPC item during transaction in the REG/MGR mode.

Procedure

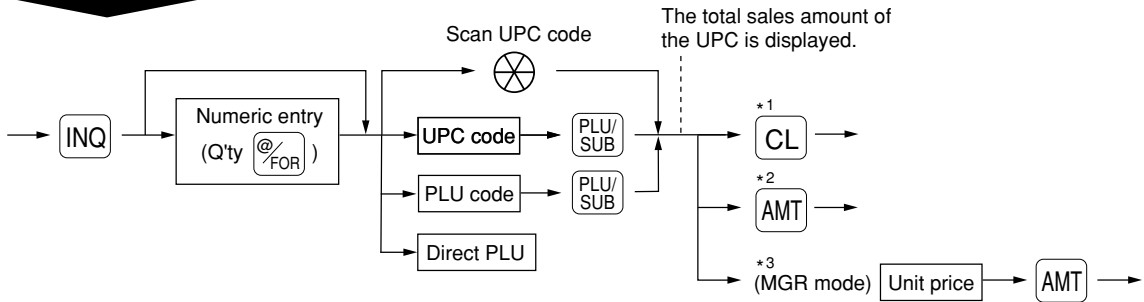

*1: Press the **CL** key to cancel the the inquiring (view) mode.

*2: Press the **AMT** key when you want to register the unit price of the PLU/UPC displayed.

*3: You can change the unit price temporarily in the MGR mode. The unit price which is programmed in PGM mode is not changed (This is considered a price override entry).

NOTE For the repeat entry, use the **REPEAT** key.

■ UPC learning function

When you enter or scan an undefined code, you are required to enter its unit price and the associated department. The UPC code, associated department and unit price entered are stored in the UPC file and used for future UPC sales entries.

- NOTE**
- When there is no capacity remaining in the file, the data is not stored in the file.
 - The text of its associated department is applied to the entered UPC code.
 - You can use the UPC learning function in the training mode. This may be convenient to practice when installing a scanning system.

Procedure

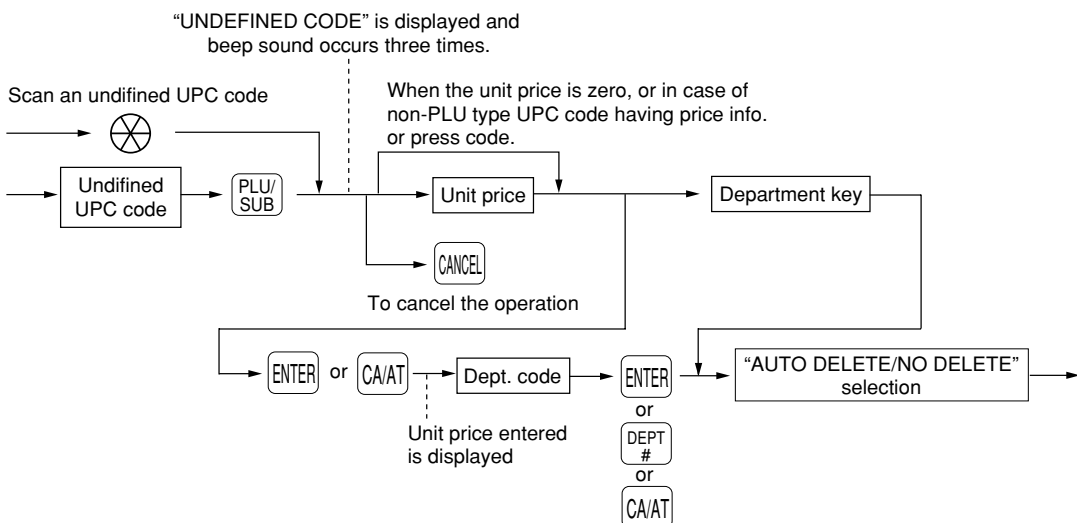

NOTE For the repeat entry, use the **REPEAT** key.

■ Price change function (for UPCs)

You can use this function when you need to change the unit price or associated department of a UPC item in REG/MGR mode.

There are two methods for the price change function:

1. Price change mode

You can change the preset price and/or the associated department of a UPC item without entering PGM mode.

2. Changing the price during a transaction

When a wrong UPC price and/or associated department is found during a transaction, you can correct them at the time of transaction. With the entry of a new price and/or associated department, the preset price and/or associated department is automatically changed to the new price and/or associated department.

NOTE For the Non-PLU type price embedded UPC-A codes and press codes, the prices in the codes have the priority over the preset prices. So, for these codes, a changed price is valid only when the price change is executed.

Procedure

Price change mode

"PRICE CHANGE" is displayed.

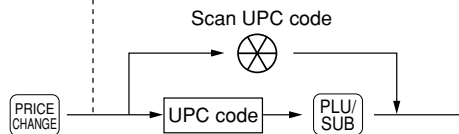

Changing price during a transaction

Scan UPC code

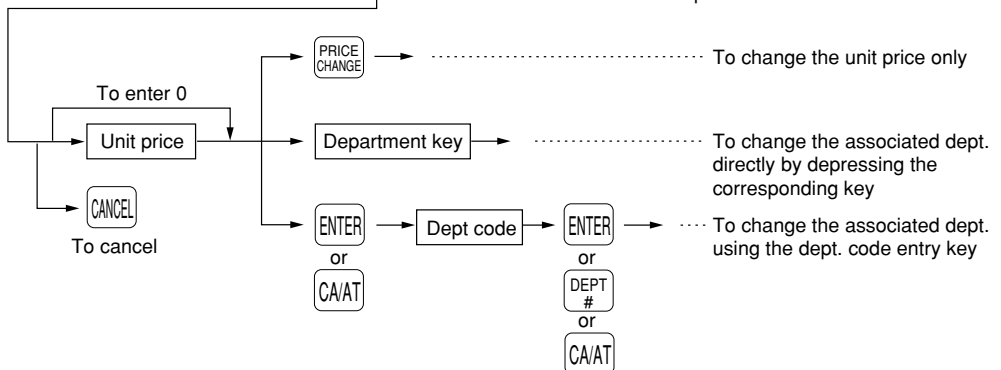
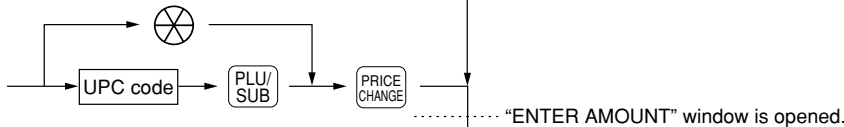

NOTE

- When an undefined code is entered in the price change mode, the register goes to an error status.
- When you press the **PRICE CHANGE** key during a transaction, the UPC entry is overridden upon the 1st depression of the **PRICE CHANGE** key, then you are allowed to enter a correct price and/or associated department.
- When an associated department is changed, the item label for the department will also be changed automatically to the item label of new associated department.
- For the repeat entry, use the **REPEAT** key.

■ PLU level shift (for direct PLUs)

This shift can add to the number of direct PLUs on your POS terminal without adding additional direct PLU keys. You can use direct PLUs in five levels by utilizing the PLU level shift keys **LEVEL 1** thru **LEVEL 5**. The level key shifts the PLU level from the other four to the required level. (The normal level is level 1.) You must program your machine in the PGM2 mode to select one of the two PLU level shift modes — automatic return mode* or lock shift mode** — and decide whether to allow the PLU level shift in both the REG and MGR modes or in the MGR mode only.

* The automatic return mode automatically shifts the PLU level back to the level programmed after pressing a direct PLU key or finalizing each transaction.

** The lock shift mode holds the current PLU level until another PLU level shift key is pressed.

Automatic return mode (for PLU levels)

If your terminal has been programmed for the PLU level in the automatic return mode, press a desired PLU level shift key before a numeric type entry.

Procedure

(Returning every item entry)

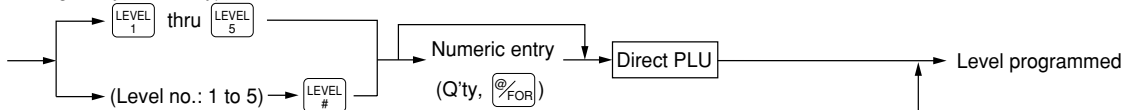

(Returning every transaction)

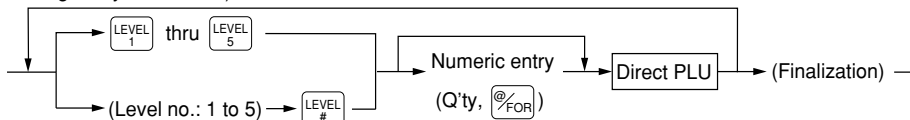

NOTE

When you use the FF method (PLU), you do not press the **%FOR** key on numeric entry.

Lock shift mode (for PLU levels)

If your terminal has been programmed for the PLU level in the lock shift mode, press a desired PLU level shift key before a numeric type entry.

Procedure

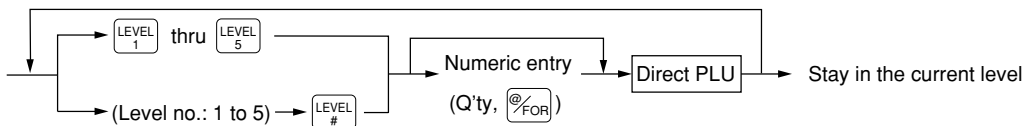

NOTE

• When you use the FF method (PLU), you do not press the **%FOR** key on numeric entry.

■ PLU/UPC price level shift







NOTE

To use this function, please contact your authorized SHARP dealer.

Six different price levels can be programmed for each PLU or UPC.

The price levels can be changed for PLU or UPC registrations.

These keys have the following functions:

-  : Shifts the PLU/UPC price level from level 2, 3, 4, 5, or 6 to level 1 (base level).
-  : Shifts the PLU/UPC price level from level 1, 3, 4, 5, or 6 to level 2. When you press this key, the price level shift indicator will turn to "P2."
-  : Shifts the PLU/UPC price level from level 1, 2, 4, 5, or 6 to level 3. When you press this key, the price level shift indicator will turn to "P3."
-  : Shifts the PLU/UPC price level from level 1, 2, 3, 5, or 6 to level 4. When you press this key, the price level shift indicator will turn to "P4."
-  : Shifts the PLU/UPC price level from level 1, 2, 3, 4, or 6 to level 5. When you press this key, the price level shift indicator will turn to "P5."
-  : Shifts the PLU/UPC price level from level 1, 2, 3, 4, or 5 to level 6. When you press this key, the price level shift indicator will turn to "P6."

* The automatic return mode shifts the PLU price level back to level 1 after a PLU entry automatically. You can select whether the PLU/UPC price level should return each time you enter one item or each time you finalize one transaction.

** The lock shift mode holds the current PLU/UPC price level until pressing a price level shift key.

Automatic return mode (for price shifts)

If your terminal has been programmed for PLU/UPC price level in the automatic return mode, press a desired price level shift key before a numeric type entry.

Procedure

(each item)

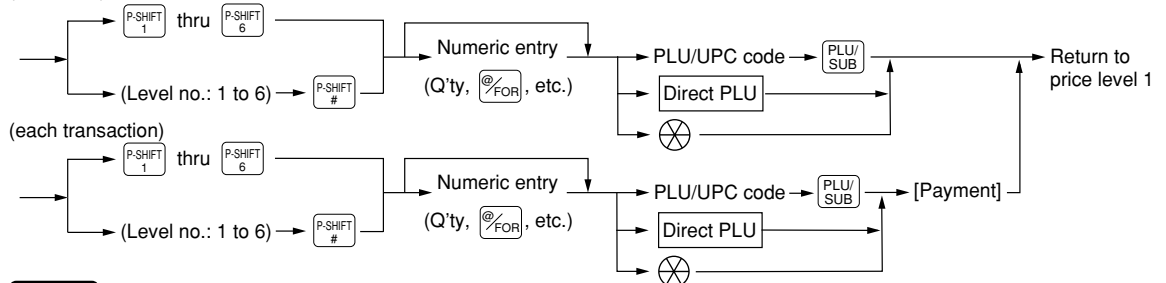

NOTE

When you use the FF method (PLU), you do not press the  key on numeric entry.



Lock shift mode (for price shifts)

If your terminal has been programmed for PLU/UPC price level in the lock shift mode, press the desired price level shift key before a numeric entry.

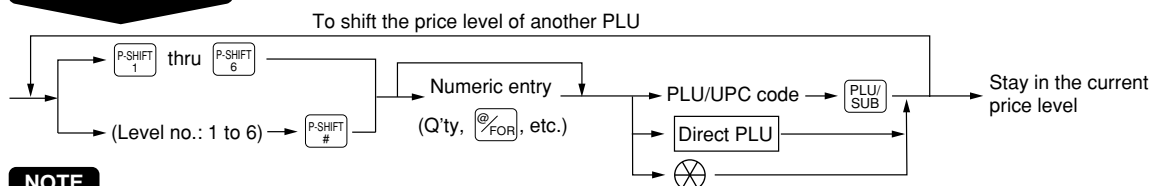
Procedure



NOTE

- If you select the automatic return mode, it is not necessary to use the  key on the keyboard. If you select the lock shift mode, it is necessary to use the  key.
- When you use the FF method (PLU), you do not press the  key on numeric entry.

Display of Subtotals

Your POS terminal provides these five types of subtotals:



■ Merchandise subtotal

You may press the  key at any point during a transaction.



The net sales subtotal - not including tax - and the symbol "MDSE ST" will appear in the display.

■ Taxable subtotal



Taxable 1 subtotal

Press the  and  keys in this order at any point during a transaction. The sales subtotal of taxable 1 items will appear in the window and the caption "TAX1" and the tax 1 amount will appear.



Taxable 2 subtotal

Press the  and  keys in this order at any point during a transaction. The sales subtotal of taxable 2 items will appear in the window and the caption "TAX2" and the tax 2 amount will appear.

Taxable 3 subtotal

Press the  and  keys in this order at any point during a transaction. The sales subtotal of taxable 3 items will appear in the window and the caption "TAX3" and the tax 3 amount will appear.

Taxable 4 subtotal

Press the  and  keys in this order at any point during a transaction. The sales subtotal of taxable 4 items will appear in the window and the caption "TAX4" and the tax 4 amount will appear.

■ Including-tax subtotal (full subtotal)

You may press the  key at any point during a transaction. The sales subtotal including tax and the symbol "SUBTOTAL" will appear in the display.

■ Tray subtotal

You may press the  key during a transaction in the REG or MGR mode.

The contents of the tray total itemizer which includes tax are printed and displayed.

■ Eat-in subtotal

You may press an eat-in key prior to entering a payment. Your POS terminal will calculate a subtotal according to the programmed tax exemption status and display the subtotal, the symbol "EAT IN," and a corresponding caption ("EAT IN 1," "EAT IN 2," or "EAT IN 3") will be displayed.



For the transaction with the eat-in subtotal, you must finalize the transaction by making a payment entry. Just after pressing the eat-in key, however, you can cancel the entry of that key by pressing the  key or another eat-in function key.

■ Food stamp-eligible subtotal



You may press the  key at any point during a transaction. The sale subtotal of items eligible for food stamp payment will appear in the display.

■ Group discountable subtotal



Group 1 discountable subtotal

You may press the  and  keys in this order at any point during a transaction.

Group 2 discountable subtotal

You may press the  and  keys in this order at any point during a transaction.

Group 3 discountable subtotal

You may press the  and  keys in this order at any point during a transaction.

■ Gasoline discount subtotal

You may press the  key and select the payment media at any point during a transaction. The gasoline discount subtotal will appear in the display.

Finalization of Transaction

■ Cash or Check tendering

Press the **SBTL** key to get the including-tax subtotal, enter the amount tendered by your customer, then press the **CA/AT** thru **CAS** key if it is a cash tender or press the **CHK 1** thru **CHK 5** key if it is a check tender. When the amount tendered is greater than the amount of the sale, your POS terminal will show the change due amount and the symbol "CHANGE." Otherwise your POS terminal will show the symbol "DUE" and a deficit. To settle the deficit amount, another tender amount exceeding the amount due must be entered.

NOTE

- You can also enter a check or cash tender from the check or cash menu window. Press the **CHK #** or **CASH #** key and select the desired check or cash media key and enter the amount.

■ Mixed tendering (check + cash)

Mixed tendering of check and cash is available. After pressing **SBTL** key, enter the amount tendered by your customer in check or cash, and press the corresponding key, then again enter the amount tendered in cash or check, and press the corresponding key.

■ Cash or check sale that does not need any tender entry

Enter items and press the **CA/AT** thru **CAS** key if it is a cash sale or press the **CHK 1** thru **CHK 5** keys if it is a check sale. Your POS terminal will display the total sales amount.

■ Charge (credit) sale

Enter items and press the corresponding charge keys (**CH 1** thru **CH 9**).

NOTE

- Amount tendering operations (i.e. change calculations) can be achieved by the **CH 1** thru **CH 9** key when PGM2-mode programming has been preset for amount tender compulsory.
- When charge tendering is performed with CAT compulsory, the corresponding card authorization sequence is initiated.
- You can also enter a charge tender from the charge menu window. Press the **CH #** key and select the desired charge media key and enter the amount.

■ Mixed-tender sale (cash or check tendering + charge tendering)

In case of mixed tendering of cash and charge tendering, press the **SBTL** key to get an including-tax subtotal, enter the amount tendered in cash by your customer, and press the **CA/AT** thru **CAS** key. Then press a pertinent charge key to settle the payment of a deficit.

In case of mixed tendering of check and charge tendering, press the **CHK 1** thru **CHK 5** keys in place of the **CA/AT** thru **CAS** key.

■ Food stamp tendering

If your customer makes payment (or tendering) in food stamps, obtain the food stamp-eligible subtotal* by pressing the  key and make a food stamp tender entry before entering a cash or check tender.

* Note: The food stamp-eligible subtotal depends upon how your register is programmed about the food stamp-eligibility of the automatic tax on a sale of items eligible for food stamp payment, or whether your register is programmed to allow the automatic tax to be paid with food stamps or not or to exempt taxation. The example below presupposes that your register has been programmed to exempt taxation.

① When the amount tendered in food stamps is greater than the food stamp-eligible subtotal:



Your register shows two change due amounts in its display. The food stamp change due appears at the left of the display in dollars and the cash change at the right in cents.

② When the food stamp tender is smaller than the food stamp-eligible subtotal:

- Accept the remainder in food stamps or in cash or check.

However, if your register is programmed to exempt taxation, it cannot accept additional food stamp tender.

■ Food stamp status shift

Your machine allows you to shift the programmed food-stamp status of each department,  thru , percent key, the UPC or the PLU key by pressing the  key prior to those keys. After each entry is completed, the programmed food stamp status is resumed.

Tax Calculations

■ Automatic tax

When your POS terminal is programmed with a tax table (or tax rate) and the tax status of an individual department or PLU is set for taxable, it computes the tax automatically on any item that is entered into the department directly or indirectly via a related PLU.

■ Manual tax

Your POS terminal allows you to enter tax manually after item entries.
After items entry, enter tax amount and press the **TAX** key.

■ Tax deletion

You can delete the automatic tax on the taxable 1, taxable 2, taxable 3, or taxable 4 subtotal of each transaction by pressing the corresponding TAX SHIFT key followed by the subtotal, then the **TAX** key after the subtotal is displayed.

NOTE

If any of the media keys (i.e. cash, check 1 thru check 4, or charge 1 thru charge 8) is programmed for tax delete in the PGM2 mode, the tax can be deleted without using the procedures above. In this case pressing a corresponding media key that has been programmed will always cause the selected tax to be deleted.

■ Tax status shift

Your POS terminal allows you to shift the programmed tax status of each department, discount, or percent key or of the PLU key by pressing the **TAX1 SHIFT**, **TAX2 SHIFT**, **TAX3 SHIFT** and/or **TAX4 SHIFT** keys before those keys are pressed. After each entry is completed, the programmed tax status of each key is resumed.

NOTE

The entry of a multi-taxable item for PST or GST will be prohibited as follows (for Canada):

In case of; Tax 1: PST, Tax 2: PST,
Tax 3: PST, Tax 4: GST

Taxable 1 and 2 item	prohibited
Taxable 1 and 3 item	prohibited
Taxable 2 and 3 item	prohibited
Taxable 1 and 4 item	allowed
Taxable 2 and 4 item	allowed
Taxable 3 and 4 item	allowed

In case of; Tax 1: PST, Tax 2: PST,
Tax 3: GST, TAX 4: GST

Taxable 1 and 2 item	prohibited
Taxable 1 and 3 item	allowed
Taxable 2 and 3 item	allowed
Taxable 1 and 4 item	allowed
Taxable 2 and 4 item	allowed
Taxable 3 and 4 item	prohibited

*4 These are the optional functions (Temporary finalization).

You can temporarily finalize a guest check by pressing the **SRVC** or **FINAL** key. It is recommended to use the **SRVC** key to temporarily finalize a guest check when printing is not desired and to use the **FINAL** key when printing the current balance including tax is desired. The guest check, however, is still "open". This means you can still make addition orders to it.

GLU recall

Each server can recall his or her GLUs for reorder entry or settlement by pressing the **GLU RECALL** key. On the display, the list of GLU that are still open are displayed. Then select the desired GLU and press the **ENTER** key, or enter the desired GLU and press the **GLU** key while the recall window is shown on the display. When programmed, the recall window will be displayed automatically.

GLU RC	
#1	9.30
#2	9.12
#3	27.87
TAX 0.00 SBTL 0.00	
P1L1	

An example of GLU recall window

Reorder entries

For making additional guest check entries;

Procedure

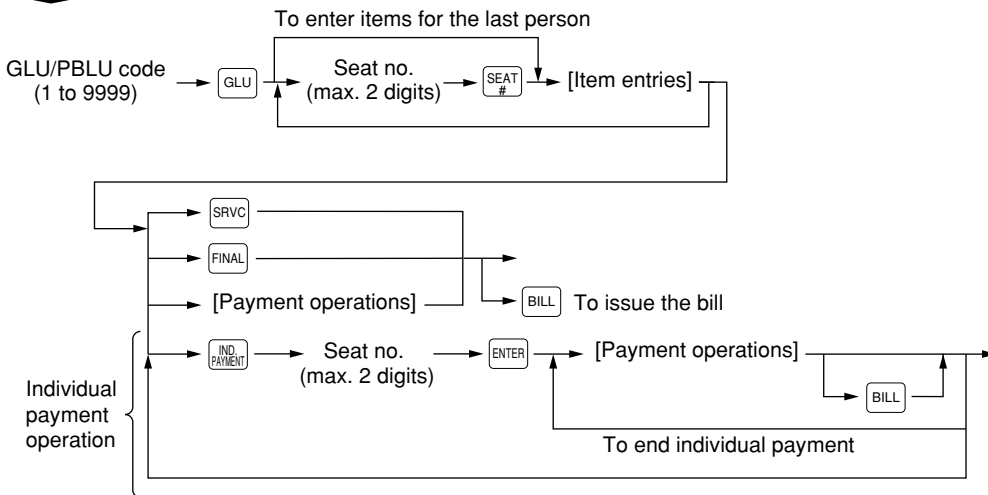

Settlement

Use the following procedure:

Procedure

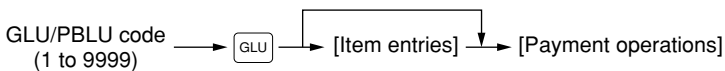

NOTE

You can make a tip-in entry before a tender entry. If a tip-in entry is made, the tip amount must be tendered by using the associated media key e.g. CH1 thru CH9 for the charge tip and CASH 1 thru CASH 5 for the cash tip.

■ Deposit entries

Deposit refers to a prepayment on a guest check. It can be received in cash check or charge tenders. You can make a deposit entry only when entering a guest check. It cannot be done during handling of a tendered amount.

A received deposit can be refunded by pressing the  key. You cannot attempt to refund an amount larger than the deposit balance.

Procedure

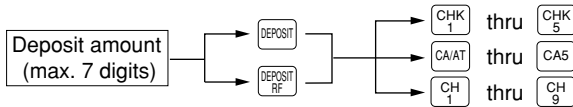

■ Transferring guest checks out or in (Transfer-out/in)

Transferring guest checks out

At the end of a server shift or whenever a server is relieved, one or more open guest checks can be transferred from the server to the open check file until the responsibility for the check(s) is assigned to another server.

Procedure

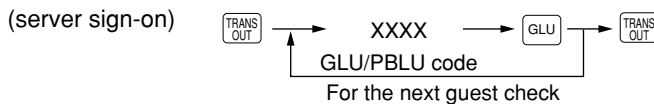

Transferring guest checks in

When the second server is assigned to be responsible for guest checks that have been transferred out:

Procedure

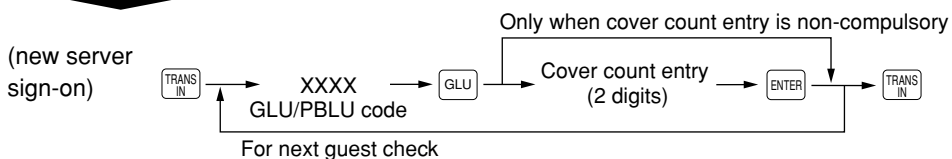

■ Bill totalizing/bill transfer

Bill totalizing

The bill totalizing function is used to totalize multiple bills when, for example, a particular guest pays not only his or her bill, but also the bills of other guests (Adding guest checks).

Procedure

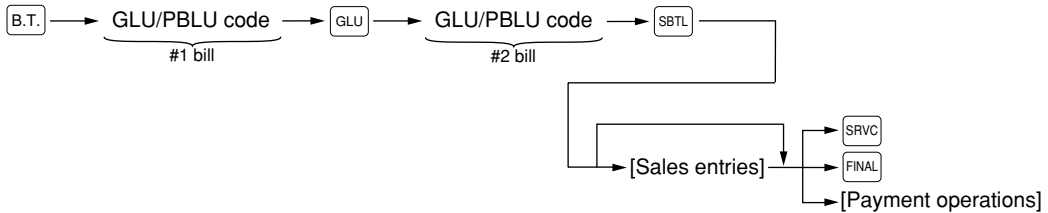

NOTE

- All #1 bills are added to a #2 bill. A maximum of 5 bills may be added to a #2 bill.
- The GLU/PBLU code of #1 must be in use. If the guest check(s) of #1 or #2 has already been handled by another server, the guest check(s) must have been made "Transferring out."
- After the bill totalizing operation, the individual payment function is not allowed.

Bill transfer

This function is used to change the GLU/PBLU code of a particular bill.

Procedure

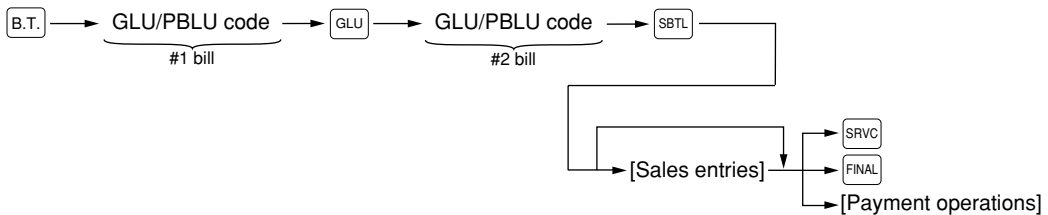

NOTE

- This function requires that the current GLU/PBLU code be entered for #1 and a new GLU/PBLU code be entered for #2.
- A #1 bill is transferred to a #2 bill. The #1 bill is then cleared and set free.

■ Bill separating

The function is used when each guest of a group pays his or her own order. With this function, you can select some items from a guest check and make an entry for the payment. Also, you can transfer the items you have selected to other guest checks. This function is available only in the GLU system.

Procedure

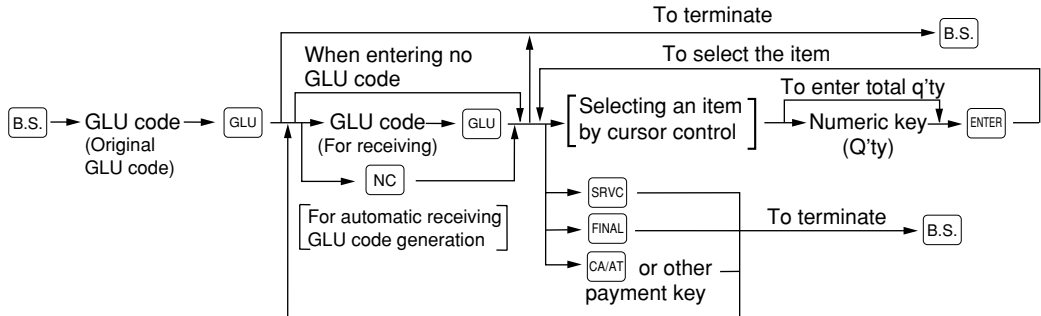

NOTE

- If the receiving GLU code is not entered during the bill separating operation, it is considered that the payment function has been made by pressing **CA/AT** key or other payment key.
- If a particular receiving GLU code is already in use, a lock error occurs when that number is entered.
- You cannot specify the quantity of an item for selection when the stored quantity has a decimal fraction.

■ Bill printing

This function is used for issuing the bill to the guest. Your POS terminal can print the bill (normal bill or cumulated bill) on the slip, roll, receipt, or journal printer. For selecting these printers, contact your authorized SHARP dealer.

Procedure

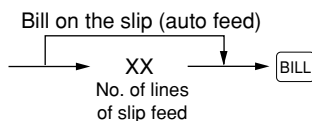

NOTE

- This function is available immediately after the finalization of transaction (including after pressing the **SRVC** or the **FINAL** key).
- If the copy function is allowed, you can print the bill copy on the slip and receipt only once. If you need the bill copy, contact your authorized SHARP dealer.

Auxiliary Entries

■ Percent calculations (premium or discount)

- Your POS terminal provides percent calculations for a merchandise subtotal or each item entry. You need to specify in advance for each merchandise subtotal or each item entry your POS terminal should perform a percent calculation.
- For percent calculations (premium, discount, merchandise subtotal or individual), you may use the **%1** thru **%5** key.
- Percentage: 0.01 to 99.99%

NOTE

- *For the ST % (merchandise subtotal) entry:
The % entry will be allowed only when all PLUs which is associated to the % key have been entered.*
- *For the Item % entry:
The % entry will be allowed only for a PLU which is associated to the % key.*

■ Discount entries

For discount or coupon tenderings, you may use the **⊖1** thru **⊖5** keys when it is allowed in programming. If the discount or tendered coupon is the one applicable to sales, use the vendor coupon; and if it is applicable to each item entry, use the store coupon.

NOTE

Discount entries can be overridden in MGR mode when it is not allowed in REG mode.

NOTE

- *For the vendor coupon entry:
The coupon entry will be allowed only when all PLUs which is associated to the (-) key have been entered.*
- *For the store coupon entry:
The coupon entry will be allowed only for a PLU which is associated to the (-) key.*

■ Refund entries

If a refunded item is to be entered into a department, enter the amount of the refund, then press the **RFND** key and a corresponding department key in this order; and if an item entered into a PLU (or UPC) is returned, enter a corresponding PLU code (or UPC code), then press the **RFND** and **PLU/SUB** keys, or press the **RFND** and direct PLU keys without entry of PLU code, in this order.

If a refunded item is to be entered into an open PLU, enter a corresponding PLU code, press the **RFND** and **PLU/SUB** keys, then enter price and press the **ENTER**.

■ Return entries

If a returned item is the one entered into a department, enter the amount of the return, then press the **RTN** key and a corresponding department key in this order; and if an item entered into a PLU (or UPC) is returned, enter a corresponding PLU code (or UPC code), then press the **RTN** and **PLU/SUB** keys, or press the **RTN** and direct PLU keys without entry of PLU code, in this order.

If a returned item is to be entered into an open PLU, enter a corresponding PLU code, press the **RTN** and **PLU/SUB** keys, then enter price and press the **ENTER**.

■ Printing of non-add code numbers

Enter a non-add code number such as a customer reference number within a maximum of 16 digits and press the **#** key at any point during the entry of a sale.

■ Refund sales mode

This function can be used only for those item return entries relating to departments and PLUs/UPCs. Pressing the  key at the beginning of a transaction causes the register to enter the REFUND SALES mode.

All of the REFUND SALES mode entries are automatically handled as refund entries. This mode cannot be finalized by the check payment entry.



■ Group discount entries

- Your register provides the percent (discount/premium) calculation for three types of group.
- Percentage: 0.01 to 100.00%

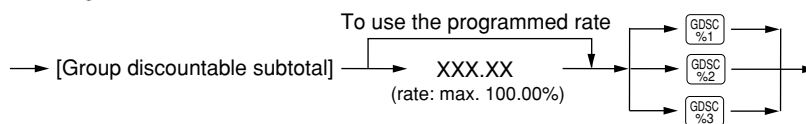
Procedure



● Group discount status shift

Your register allows you to shift the programmed group discount status of each dept., PLU, UPC, ⊖1 thru ⊖5, percent by pressing the , , and/or  keys before those keys. After each entry is completed, the programmed group discount status of each key is resumed.

■ Remote printer send function

This function enables a partial order to be sent to the kitchen for preparation while the remaining order is still being placed.

Procedure

Item entry →  → Data transfer to the remote printer

Remaining items will be sent to the remote printer when the transaction is finalized.

When this function is used, the subtotal void operation is not allowed.

■ Gratuity

Calculation

When the payment operation is made for sales registrations, the gratuity amount is always calculated and printed.

You can program a percent rate for calculating the gratuity.

If the percent rate is programmed as 0%, the POS terminal does not print any gratuity.

You can program a tax status (taxable 1/taxable 2/taxable 3/taxable 4/non-taxable) for gratuity.

Exemption

Your POS terminal allows you to exempt a customer from the gratuity by pressing the  key prior to a payment operation.

Payment Treatment

■ Tip-in entries

Your POS terminal allows the entry of tips that your guests give to servers in cash or by credit card.

A tip entry should be done before a payment entry.

You must use the corresponding media key e.g. CH1 thru CH9 for the charge tip and CASH 1 thru CASH 5 for the cash tip.

Two different tip-in entry systems are available: the tip amount entry system and the tip percent rate entry system. It depends on how your POS terminal has been programmed which of these systems is used.

Procedure

Tip amount entry system:

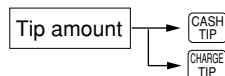

Tip percent rate entry system:

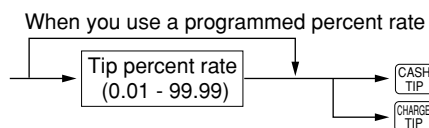

■ Tip editing

This function is used for entering tip amounts after finalizing a guest check transaction. This function is available when the guest check transaction is finalized in a charge tender, and also when the tip is to be paid in charge tender. The bill number which is issued when the **SRVC** or **FINAL** key is pressed in guest check entry must be used in order to identify the guest to edit or add tip amount. For the operation, press the **EDIT TIP** key. When the display prompt appears, enter the bill number and tip amount.

YOUR RECEIPT		
THANK YOU		
08/27/2002	123456	BILL#0020
#1097	11:37AM	JACK0001
		TBL# 1
COVER CT	2	
***PBAL		\$0.00
PL00001		\$10.00
BAL FWD		\$10.00
SERVICE		\$10.00

Bill number

■ Tip paid entries

This operation is used when tips that guests have paid by using credit card are paid to respective servers in cash. To perform a tip paid entry, enter the server code, then press the **TIP PAID** key.

You can prohibit the tip paid operation in the REG mode by the PGM2 programming.

NOTE When the tip amount remains unchanged in Individual Server Resetting, the tip paid function is automatically executed and tip receipt is issued to the report printer prior to report printing.

■ Currency conversion

Your POS terminal allows payment entries in foreign currency. Pressing the **CONV1** thru **CONV4** keys creates a subtotal in foreign currency. Cash alone can be handled after currency conversion.

Procedure

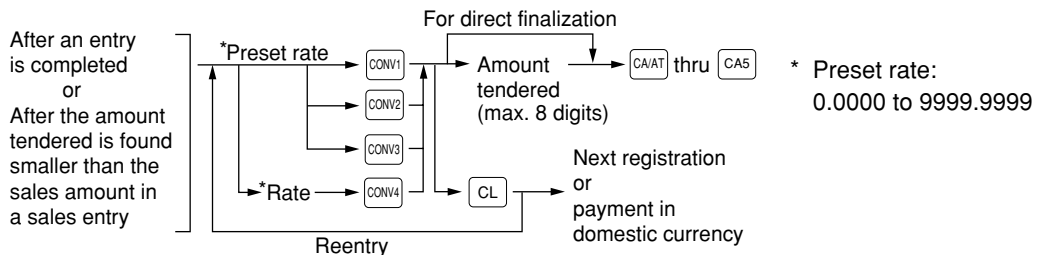

NOTE

- When the amount tendered is short, its equivalent in deficit is shown in domestic currency.
- You can also enter a currency conversion tender from the conversion menu window. Press the **CONV** key and select a pertinent conversion number.
- Change amount will be displayed and printed in domestic currency.

■ Received-on-account entries

Procedure

Direct key entries

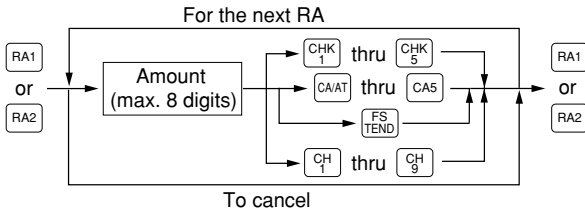

Menu-based entries

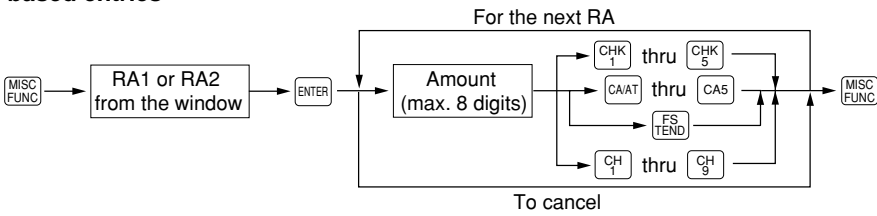

NOTE

You may also choose the RA procedure instead of the above procedure only for cash payment. Contact your authorized SHARP dealer to change the procedure.

Procedure

Direct key entries

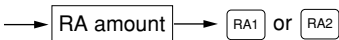

Menu-based entries

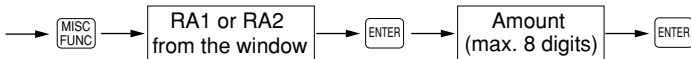

■ Paid-out entries

Procedure

Direct key entries

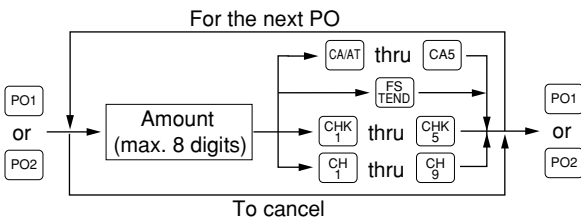

Menu-based entries

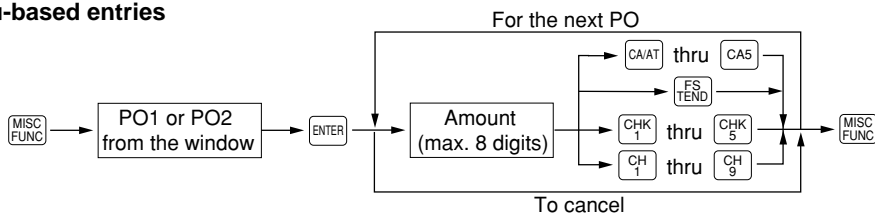

NOTE

You may also choose the PO procedure instead of the above procedure only for cash payment. Contact your authorized SHARP dealer to change the procedure.

Procedure

Direct key entries

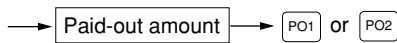

Menu-based entries



■ No-sale (exchange)

Simply press the **NS** key without any entry. The drawer will open and the printer will print a receipt indicating the "NO SALE." If your POS terminal is programmed to allow a non-add code entry and you enter a non-add code number before pressing the **NS** key, a no-sale entry will be achieved with a non-add code number printed.

NOTE

You can also enter "No-sale" from the miscellaneous menu window. Press the **MISC FUNC** key and select "11 NO SALE" from the window.

■ Cashing a check

Enter the check amount, then press the **CHK 1** thru **CHK 5** keys.

Procedure

Direct key entries

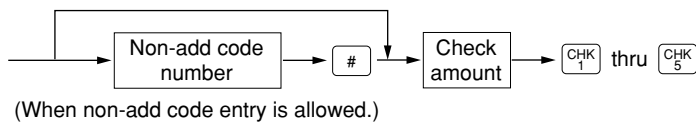

Menu-based entries

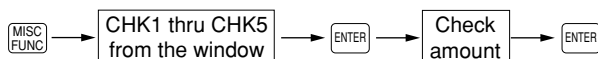

■ Customer management

Your POS terminal can provide the customer management function.

To enable the customer management function, enter the customer code assigned to a customer. You can enter the customer code at any point during a transaction.

Normally customer information (name, code and address) are previously set by the programming.

However, you can enter a new customer information during transaction. When an undefined customer code is entered, the message, "UNDEFINED CODE" is displayed, then you can enter the customer's name and address, which are saved in the customer file.

For the customer registered, you can allow to defer his/her payment. Take the tentative finalization using the **CH** key. The sales amount is accumulated to the charge amount of each customer. When the customer settles his/her charge account take the received-on account entry.

Procedure

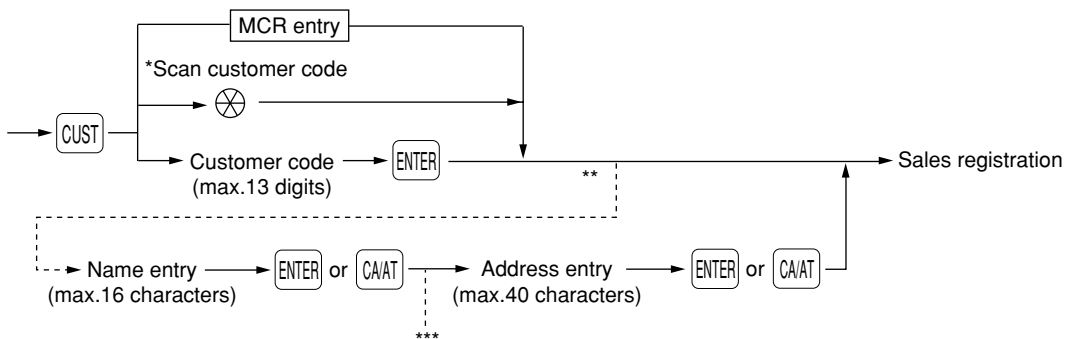

*: Scanning the customer code on a Customer Card provided to the customer, or EAN-13 format bar code. Additionally the customer code can be read by the optional magnet card reader.

** : When a code entered for the customer entry does not exist in the customer file, "UNDEFINED CODE" is displayed for a moment with beep sounds. Then the NAME entry window is displayed to prompt to operator to enter a customer's name.

***: The ADDRESS entry window is displayed.

NOTE

- The customer code entry is inhibited after the payment operation.
- When the wrong code is registered, take the following procedure to cancel it.
If no item has been entered, press the **NS** key.
If the item entry has been made, perform the subtotal void operation.

WASTE mode

This mode is used to throw away an article which has already been prepared and is no longer serviceable.

Procedure

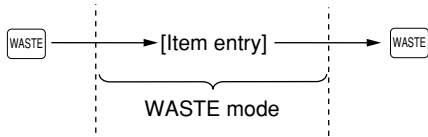

NOTE

- *PLU entries are only allowed in the WASTE mode, and direct and indirect void operations are also allowed in this mode.*
- *When a WASTE-mode transaction is finalized, the drawer does not open.*
- *The consecutive number is incremented every WASTE-mode transaction.*
- *When the WASTE mode is activated by pressing the  key, the mode caption "WASTE" is displayed.*

6

Correction

REG MODE

MGR MODE

Correction of the Last Entry (Direct Void)

If you make an incorrect entry relating to a department, PLU/subdepartment, UPC, percentage (Ⓜ1 thru Ⓜ5), discount (Ⓜ1 thru Ⓜ5), manual tax, or tip, you can void this entry by pressing the **VOID** key immediately.

Example

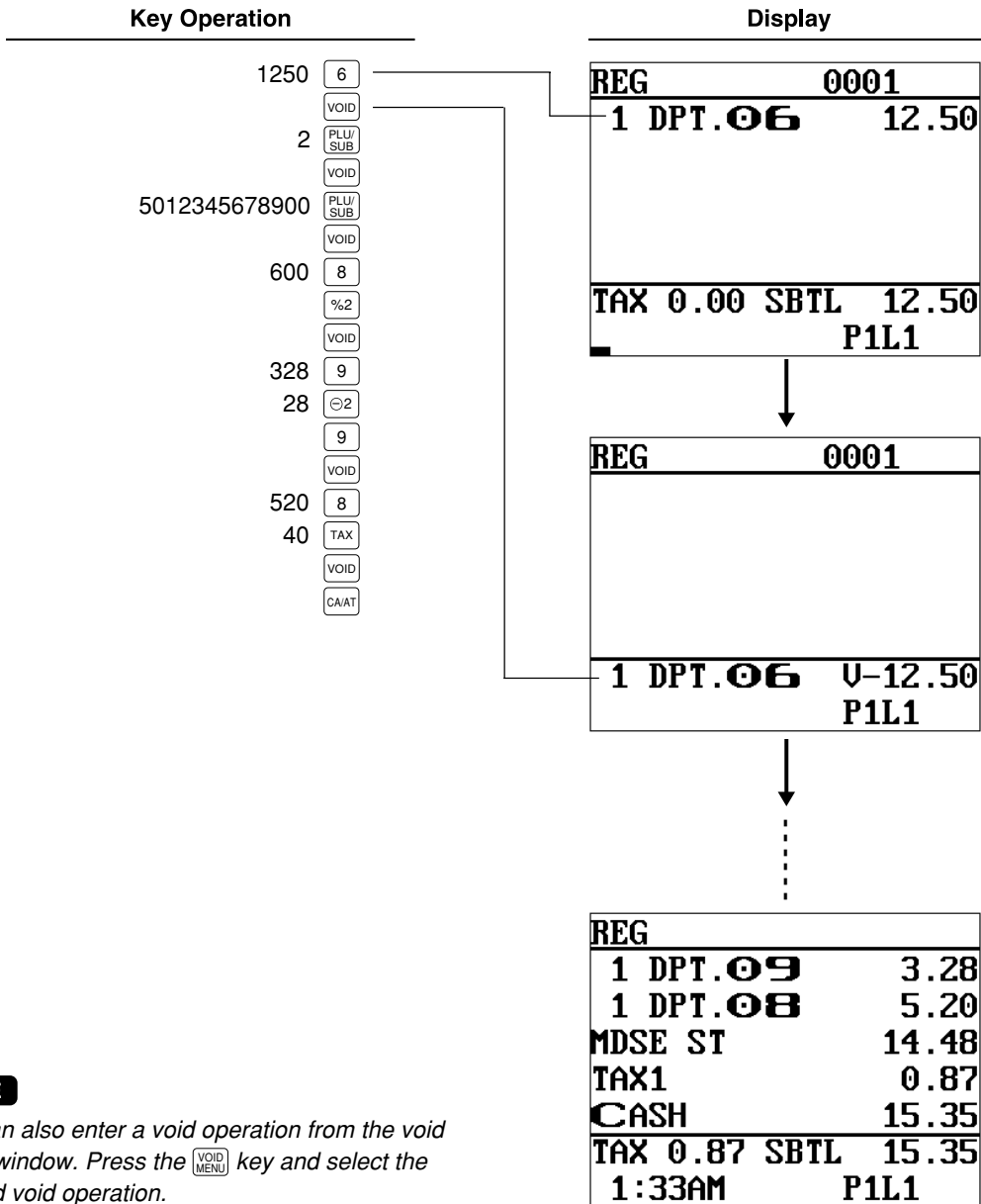

NOTE

You can also enter a void operation from the void menu window. Press the **VOID MENU** key and select the desired void operation.

Correction of the Next-to-Last or Earlier Entries (Indirect Void)

With the **PAST VOID** key you can void any incorrect department, PLU/subdepartment, UPC or item refund entry made during a transaction if you find it before finalizing the transaction (e.g. before pressing the **CA/AT** key). This function is applicable to department and PLU/subdepartment, UPC and item refund entries only.

Example

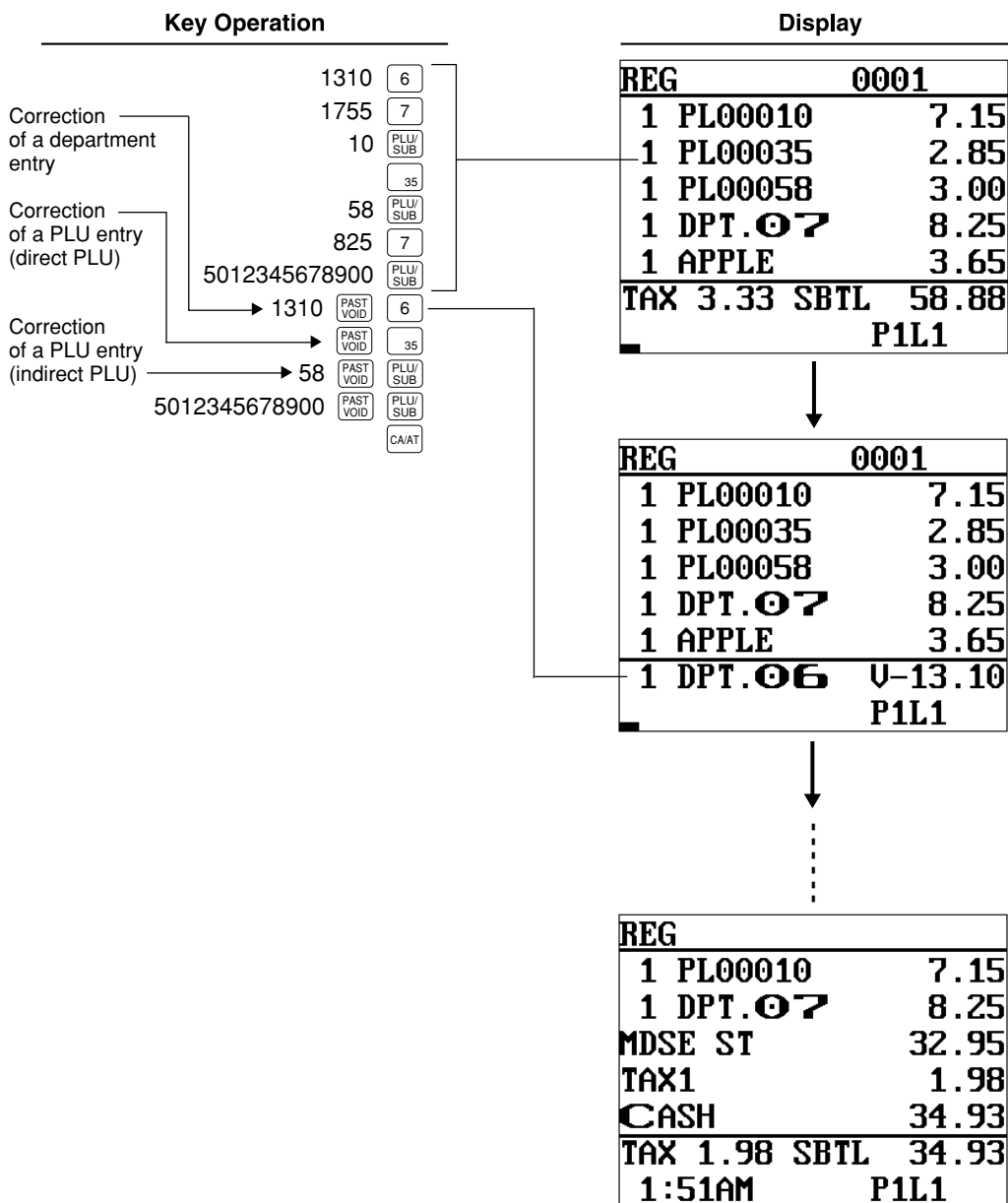







NOTE

- To void entries that include a tax status shift, press the **TAX1 SHIFT**, **TAX2 SHIFT**, **TAX3 SHIFT**, and/or **TAX4 SHIFT** keys prior to the **PAST VOID** key.
- You can also enter a void operation from the void menu window. Press the **VOID MENU** key and select the desired void operation.

Subtotal Void

With the  key you can void an entire transaction. Once the subtotal void is executed, the transaction is canceled and the POS terminal issues a receipt.

Example

Key Operation	Display
1310 	REG
1755 	1 PL00010 7.15
10 	1 PL00035 2.85
35 	MDSE ST 40.65
	SBTL VD -40.65
	***TOTAL 0.00
	TAX 0.00 SBTL 0.00
	1:55AM P1L1

NOTE

You can also enter a void operation from the void menu window. Press the  key and select the desired void operation.

Correction of Incorrect Entries Not Handled by the Direct or Indirect Void Function

Any errors found after the entry of a transaction has been completed or during an amount tendered entry, cannot be voided. These errors must be handled by the manager.

The following steps should be taken.

1. If you are making an amount tendered entry, finalize the transaction.
2. Hand the incorrect receipt to your manager for recording purposes.

7

Special Printing Functions

REG MODE

Printing Message Text for Remote Printer or Chit Receipts

You can print a message to remote printers or the chit receipt when programmed. Press the **MSG#** key and select pertinent message number, or press a **MSG 1** thru **MSG 5** keys while item entries. The message will be printed in double sized characters together with items.

NOTE

You can not finalize the transaction under the state that a message only is entered. When multiple messages are entered, the last message only is printed.

Copy Receipt Printing

If your customer wants a receipt after you have finalized a transaction with the receipt ON-OFF function in the "OFF" status (no receipting), press the **RCPT** key. This will make a copy receipt. Your POS terminal can also print a copy receipt when the receipt ON-OFF function is in the "ON" status.

NOTE

To toggle the receipt ON-OFF status, use one of the following procedures:

- Select "01 RCP S.W." from the window which is opened by pressing the **MISC FUNC** key.
- Press the **RCP SW** key to open the "RCP S.W." window.

Example

Printing a copy receipt after making the entries shown below with the receipt ON-OFF function "OFF" status

Key Operation	Print																																
<div style="display: flex; align-items: center; gap: 10px;"> <div style="border: 1px solid black; padding: 2px 5px;">2</div> <div style="border: 1px solid black; padding: 2px 5px;">3</div> <div style="border: 1px solid black; padding: 2px 5px;">CA/AT</div> </div>	Print on the journal																																
For receipting → <div style="border: 1px solid black; padding: 2px 5px;">RCPT</div>																																	
	<table border="0" style="width: 100%;"> <tr> <td style="width: 20%;">08/27/2002</td> <td style="width: 20%;">123456</td> <td style="width: 20%;"></td> <td style="width: 40%;"></td> </tr> <tr> <td>#1077</td> <td>11:02AM</td> <td>JACK0001</td> <td></td> </tr> <tr> <td>PL00002</td> <td></td> <td>\$2.50</td> <td></td> </tr> <tr> <td></td> <td>3 @</td> <td>\$5.70</td> <td></td> </tr> <tr> <td>PL00003</td> <td></td> <td>\$17.10</td> <td></td> </tr> <tr> <td>MDSE ST</td> <td></td> <td>\$19.60</td> <td></td> </tr> <tr> <td>TAX1</td> <td></td> <td>\$1.18</td> <td></td> </tr> <tr> <td>CASH</td> <td></td> <td>\$20.78</td> <td></td> </tr> </table>	08/27/2002	123456			#1077	11:02AM	JACK0001		PL00002		\$2.50			3 @	\$5.70		PL00003		\$17.10		MDSE ST		\$19.60		TAX1		\$1.18		CASH		\$20.78	
08/27/2002	123456																																
#1077	11:02AM	JACK0001																															
PL00002		\$2.50																															
	3 @	\$5.70																															
PL00003		\$17.10																															
MDSE ST		\$19.60																															
TAX1		\$1.18																															
CASH		\$20.78																															
	<table border="0" style="width: 100%;"> <tr> <td style="width: 20%;">08/27/2002</td> <td style="width: 20%;">123456</td> <td style="width: 20%;"></td> <td style="width: 40%;"></td> </tr> <tr> <td>#1077</td> <td>11:02AM</td> <td>JACK0001</td> <td></td> </tr> <tr> <td>PL00002</td> <td></td> <td>\$2.50</td> <td></td> </tr> <tr> <td></td> <td>3 @</td> <td>\$5.70</td> <td></td> </tr> <tr> <td>PL00003</td> <td></td> <td>\$17.10</td> <td></td> </tr> <tr> <td>MDSE ST</td> <td></td> <td>\$19.60</td> <td></td> </tr> <tr> <td>TAX1</td> <td></td> <td>\$1.18</td> <td></td> </tr> <tr> <td>CASH</td> <td></td> <td>\$20.78</td> <td></td> </tr> </table>	08/27/2002	123456			#1077	11:02AM	JACK0001		PL00002		\$2.50			3 @	\$5.70		PL00003		\$17.10		MDSE ST		\$19.60		TAX1		\$1.18		CASH		\$20.78	
08/27/2002	123456																																
#1077	11:02AM	JACK0001																															
PL00002		\$2.50																															
	3 @	\$5.70																															
PL00003		\$17.10																															
MDSE ST		\$19.60																															
TAX1		\$1.18																															
CASH		\$20.78																															
	Print on the receipt																																

The "COPY" symbol is printed on the copy receipt.

08/27/2002	123456
#1077	11:02AM
	JACK0001
COPY	
PL00002	\$2.50
	3 @ \$5.70
PL00003	\$17.10
MDSE ST	\$19.60
TAX1	\$1.18
CASH	\$20.78

Validation Printing Function

The POS terminal can perform validation printing when it is connected with the slip printer. For the details of slip printer, contact your authorized SHARP dealer.

1. Set a validation slip to the slip printer.
2. Press the  key. The validation printing will start.

NOTE *Programmed compulsory validation printing can be overridden by performing the following operation. If you need this function, contact your authorized SHARP dealer.*

1. Move the mode key to MGR position.

2.    



Server Arrival/Departure Time Printing

The POS terminal will allow server's arrival and departure time printing when it is connected with the slip printer. For the details of the slip printer, contact your authorized SHARP dealer. For printing, you must be in the REG mode.

Printing of arrival time

 1  

Printing of departure time

 2  

9

Correction after Finalizing a Transaction

MGR MODE

When you need to void incorrect entries that servers or cashiers cannot correct (incorrect entries that are found after finalizing a transaction or cannot be corrected by direct or indirect void), follow this procedure in the MGR mode.

1. Turn the mode switch to the MGR position.
2. Press the **VOID** key to put your POS terminal in the VOID mode. (Note the indication on the display.)
3. Repeat the entries that are recorded on an incorrect receipt. (All data in the incorrect receipt is removed from POS terminal memory; the voided amounts are added to the void mode totalizer.)

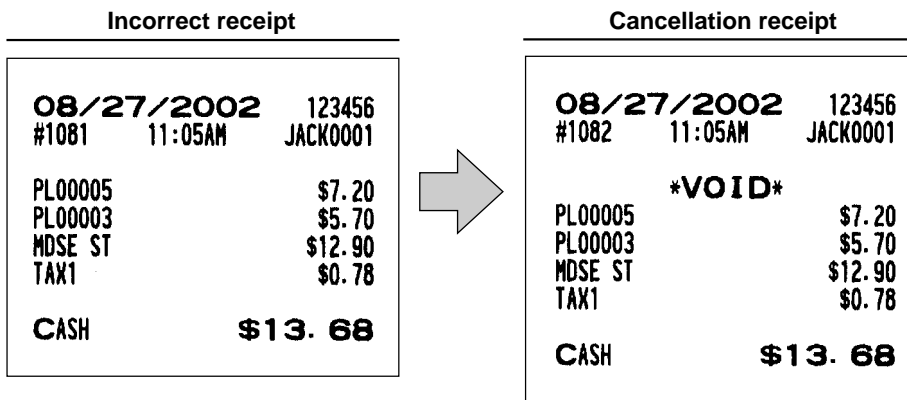

NOTE

Your POS terminal leaves the VOID mode when a transaction is completed (i.e. finalized in the VOID mode). To void additional transactions, repeat steps **2.** and **3.** above.

10

Reading (X) and Resetting (Z) of Sales Totals

X1 / Z1 MODE

X2 / Z2 MODE

OPXZ MODE

- Use the reading function (X) when you need to take the reading of sales information entered after the last resetting. You can take this reading any number of times. It does not affect the POS terminal's memory.
- Use the resetting function (Z) when you need to clear the POS terminal's memory. Resetting prints all sales information and clears the entire memory except for GT1 through GT3, reset count, and the consecutive number.
- X1 and Z1 reports show daily sales information. You can take these reports in the X1/Z1 mode.
- X2 and Z2 reports show periodic (monthly) consolidation information. You can take these reports in the X2/Z2 mode.
- If you want to stop the printing of a report, press the key. Even if the printing is stopped, the consecutive number (and Z counter if you are printing a Z report) is increased by one.

■ How to take a X1/Z1 or X2/Z2 reports

[To take a X1 or X2 report:]

1. Place the MA or SM mode key to OP X/Z, X1/Z1, or X2/Z2 position.
2. Select "1 READING" to display the report lists.
3. Select a report title listed in the table shown later. When you select an item with parentheses on the opening screen, you can jump to the associated report title(s).
4. If needed, enter the corresponding values described in the "Data to be entered" column on the table shown later.

[To take a Z1 or Z2 report:]

1. Place the MA or SM mode key to OP X/Z, X1/Z1, or X2/Z2 position.
2. Select "2 RESETTING" to display the report lists.
3. Select a report title listed in the table shown later.
4. If needed, enter the corresponding values described in the "Data to be entered" column on the table shown later.
5. After the report has been taken, the message "ARE YOU SURE ?" will appear. Select one of the following actions:
 - Select "YES" to reset the sales information.
 - Select "NO" to cancel the report procedure.

■ Flash report

You can take flash reports (display only) in the X1 mode for department sales, cash in drawer (CID) and sales total for a fast view of sales revenue.

1. Place the MA or SM mode key to X1/Z1 position.
2. Select "3 FLASH MODE" to display the flash report menu.
3. Select "DEPT SALES" to take a flash report of department sales, "CID" to take a flash report of cash in drawer, or "SALES TOTAL" to take a flash report of sales total.

Report title	Description	Available report type in each mode		Data to be entered
		X1/Z1	X2/Z2	
1 DEPARTMENT	Department by group	X1, Z1	X2, Z2	Start/end department codes
2 DEPT.IND. GROUP	Individual group total of departments	X1	X2	Department group no.
3 DEPT.GR. TOTAL	Full group total of departments	X1	X2	
4 M-DOWN DEPT.	Department markdown	X1	X2	
5 PLU/UPC	PLU/UPC by designated range	X1, Z1	X2, Z2	Start/end PLU/UPC codes
6 PLU PICK UP	PLU/UPC pick up report	X1, Z1	X2, Z2	*1
7 PLU BY DEPT	PLU/UPC by associated dept.	X1, Z1	X2, Z2	Department code
8 PLU IND. GROUP	Individual group of PLU/UPC	X1	X2	PLU/UPC group no.
9 PLU GR. TOTAL	Full group total of PLU/UPC	X1	X2	
10 PLU STOCK	PLU stock by designated range	X1, Z1		Start/end PLU/UPC codes
11 PLU STOCK PICK UP	PLU/UPC stock pick up report	X1		*1
12 PLU ZERO SALES	PLU/UPC zero sales	X1	X2	All
	PLU/UPC zero sales by department	X1	X2	Department code
13 PLU MIN. STOCK	PLU/UPC minimum stock	X1		Start/end PLU/UPC codes
14 PLU CATEGORY	PLU/UPC by price category	X1	X2	Price
15 DYNAMIC UPC	Dynamic UPC by designated range	X1, Z1	X2, Z2	Start/end UPC codes
16 D-UPC PICK UP	Dynamic UPC pick up report	X1, Z1	X2, Z2	*1
17 D-UPC BY DEPT	Dynamic UPC by associated dept.	X1, Z1	X2, Z2	Department code
18 TRANSACTION	Transaction	X1, Z1	X2, Z2	
19 CID	Cash in drawer	X1	X2	
20 POSITIVE CHECK	Positive check	X1, Z1		
21 KEY CAPTURE	Key capture report	X1		
22 TAX	Tax	X1	X2	
23 ALL SERVER	Full server	X1, Z1	X2, Z2	
24 IND. SERVER	Individual server	X1, Z1	X2, Z2	
		(OP X/Z mode)	X, Z	

Report title	Description	Available report type in each mode		Data to be entered
		X1/Z1	X2/Z2	
25 HOURLY	Hourly (full)	X1, Z1		Start/end time
	Hourly (by range)	X1		
26 DAILY NET	Daily net		X2, Z2	
27 GLU	GLU	X1, Z1		Start/end GLU code
28 GLU BY SERVER	GLU by server	X1, Z1		
29 CLOSE GLU	Closed GLU	X1, Z1		Start/end GLU code
30 CL-GLU BY SERVER	Closed GLU by server	X1, Z1		
31 CUSTOM SALES1	Customer sales 1		X2, Z2	Start/end customer codes
32 CUSTOM SALES2	Customer sales 2		X2, Z2	Start/end customer codes
33 CUSTOM BY AMT	Customer by designated sales range		X2	Amount
34 CHARGE ACCOUNT	Customer charge account		X2	
35 STACKED REPORT	Stacked report 1	X1, Z1	X2, Z2	
	Stacked report 2	X1, Z1	X2, Z2	

NOTE 1: You can pick up PLU/UPC codes for issuing the report. You can pick up new PLU/UPC codes or the codes that were picked up the last time. To pick up new codes, select "1 NEW PICK UP", and follow the procedure show below to pick up new codes. To pick up the codes that were picked up last time, select "2 LAST PICK UP".

Follow the below procedure for picking up PLU/UPC codes.

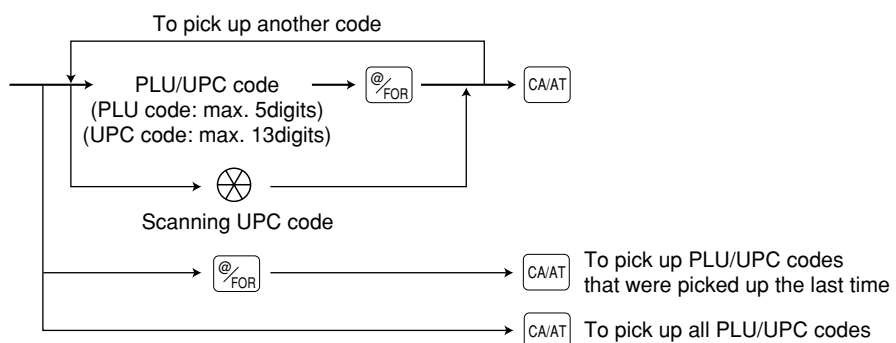

* The following reports relating to PLU/UPC is issued in the following sequence.
 PLU, PLU BY DEPT, PLU IND. GROUP, PLU ZERO SALES, PLU STOCK, PLU MIN. STOCK and PLU CATEGORY

Also the UPC codes are printed in the sequence shown below.

UPC-A
UPC-E
EAN-13
EAN-8

Daily Sales Totals

Transaction report

• Sample X report

08/26/2002 123456		
#1622	9:20PM	JACK0001
Job code		
#0130 *X1*		Read symbol
TRANSACTION		Report title
TR	\$00000001225.40	Grand total of training-mode registrations
(-) 1	5Q -5.60	(-)1 counter and total (Subtotal(-))
(-) 2	5Q -6.00	
ST (-) TL	10Q -11.60	Total for subtotal(-)
%1	1Q -1.82	%1 counter and total (Subtotal %)
%2	1Q -1.61	
ST % TL	2Q -3.43	Total for subtotal %
GDISC%1	2Q -0.63	
GDISC%2	2Q -2.30	
GDISC%3	2Q -3.88	
GDISC%TL	6Q -6.81	Total for group discount %
GAS (-)1	3Q -147.60	

• Sample Z report

08/26/2002 123456		
#1815	11:01PM	JACK0001
Job code		
#0130 *Z1*		Read symbol
TRANSACTION		Report title
TRANS. Z1	0009	Reset counter
GT1	\$00000076837.52	Net grand total (GT2-GT3)
GT2	\$00000077368.86	Grand total of plus registration
GT3	-00000000531.34	Grand total of minus registration
TR	\$00000001353.84	Grand total of training-mode registrations

The subsequent printout occurs in the same format as in the sample X report.

GAS (-)19	0Q \$0.00	
GASDISTL	3Q -147.60	Total for gasoline discount
NET 1	\$21993.93	Net sales total
TAX1 ST	\$73.25	Net taxable 1 total
GRS TAX1	\$4.71	Gross tax 1 total
RFD TAX1	-0.30	Refund tax 1 total
TAX1	\$4.41	Net tax 1 total
TX1 EXPT	\$5.00	Taxable 1 exempt total
TAX2 ST	\$56.15	
GRS TAX2	\$2.61	
RFD TAX2	-0.36	
TAX2	\$2.25	
TX2 EXPT	\$9.20	
TAX3 ST	\$87.09	
GRS TAX3	\$4.86	
RFD TAX3	-0.70	
TAX3	\$4.16	
TX3 EXPT	\$10.52	
TAX4 ST	\$49.05	
GRS TAX4	\$3.32	
RFD TAX4	-0.62	
TAX4	\$2.70	
TX4 EXPT	\$7.98	Gross manual tax total
GRS MTAX	\$1.47	Refund manual tax total
RFD MTAX	-0.58	Net manual tax total
M-TAX	\$0.89	
TTL TAX	\$14.41	Tax total
NET	\$21990.04	Sales total without tax
NET2	\$22004.45	Sales total
COMBO1	2Q \$12.20	Combo 1 counter and total

(When the Canadian tax system is selected)

TAX1 ST	\$39.45	
GRS TAX1	\$2.53	
RFD TAX1	-0.15	
TAX1	\$2.38	Tax 1
TX1 EXPT	\$5.00	
TAX2 ST	\$47.00	
GRS TAX2	\$2.06	
RFD TAX2	-0.18	
TAX2	\$1.88	

TAX4 ST	\$39.29	
GRS TAX4	\$2.59	
RFD TAX4	-0.47	
TAX4	\$2.12	Tax 4
TX4 EXPT	\$7.98	
GRS MTAX	\$1.47	
RFD MTAX	-0.38	
M-TAX	\$1.09	Manual tax
GST EXPT	\$20276.17	Exempt total from GST
PST TTL	\$6.03	PST total
GST TTL	\$2.12	GST total

To be continued on the next page

COMBO20	0Q	\$0.00	
(-) 3	3Q	-4.53	(-)3 counter and total (Item(-))
(-) 4	3Q	-5.19	
(-) 5	3Q	-4.08	
(-) TL	9Q	-13.80	Total for item(-)
%3	2Q	-0.38	%3 counter and total (Item %)
%4	3Q	-0.84	
%5	2Q	-1.24	
% TL	7Q	-2.46	Total for item %
CP PLU	4Q	-5.96	Coupon-like PLU counter and total
V. CP UPC	0Q	\$0.00	Vender coupon UPC counter and total
EAT IN 1	5Q	\$15.20	Eat-in 1 counter and total
EAT IN 2	5Q	\$28.24	
EAT IN 3	4Q	\$29.03	
DIR VD	5Q	\$13.10	Direct void counter and total
PAST VD	9Q	\$18.10	Indirect void counter and total
SBTL VD	2Q	\$15.95	Subtotal void counter and total
MGR VD	9Q	\$18.07	Manager item void counter and total
VOID	3Q	\$18.06	Void-mode transaction counter and total
REFUND	63Q	\$125.95	Refund counter and total
RETURN	3Q	\$6.65	Return counter and total
HASH VD	2Q	\$4.25	Hash item void counter and total
HA P. VD	1Q	\$1.20	Hash item indirect void
HASH RF	1Q	\$3.20	Hash item refund counter and total
HASH RT	1Q	\$5.12	Hash item return counter and total
NO SALE	5Q		No-sale (exchange) counter
VP CNT	0Q		Validation print counter
BILL CNT	0Q		Bill print counter
DRW CNT	146Q		Till timer counter
TRAY CNT	8Q		Tray subtotal print counter
***PBAL	22Q		GLU/PBLU counter
SERVICE	19Q		Service counter (for GLU/PBLU)
COVER CT	623Q		Cover counter
TRAN. OUT	1Q	\$23.05	Transfer-out counter and total
TRAN. IN	1Q	\$23.05	Transfer-in counter and total
TRANS CT	597Q		Transaction counter
AVE SALE		\$35.32	
GRATUITY		\$48.89	Gratuity total
NET3		\$22235.96	Sales total (including hash dept. total)
HASH TTL	9Q	\$32.04	Hash counter and total
WASTE TL	14Q	-29.10	Waste counter and total
CASH	515Q	\$21155.37	Cash counter and total
CASH2	2Q	\$35.74	Cash 2 counter and total
CASH3	2Q	\$40.72	
CASH4	3Q	\$56.96	
CASH5	2Q	\$45.57	
CASH TL	524Q	\$21334.36	Total for cash

To be continued on the next page

***RA	1Q	\$82.00	Received-on-account counter and total
***RA2	1Q	\$75.00	
RA TL	2Q	\$157.00	Total for received-on-account
***PO	1Q	\$20.00	Paid-out counter and total
***PO2	1Q	\$50.00	
PO TL	2Q	\$70.00	Total for paid-out
CA/CHK1	3Q	\$135.00	Check cashing 1 counter and total
CA/CHK2	2Q	\$44.00	
CA/CHK3	3Q	\$47.00	
CA/CHK4	2Q	\$75.00	
CA/CHK5	2Q	\$110.00	
CA/CK TL	12Q	\$411.00	Total for check cashing
CHK/CG		\$11.80	Cash change total for check and charge 1-9 tendering
CONV 1		30.00	Currency conversion 1 total (by programmed rate)
CONV 2		40.00	
CONV 3		35.00	
CONV 4		33.00	Currency conversion 4 total (by manual rate)
CONV TL		138.00	Total for conversion
CHARGE1	10Q	\$150.35	Gross charge 1 counter and total
CHARGE1-	1Q	-3.75	Refund charge 1 counter and total
CHARGE2	6Q	\$77.04	
CHARGE2-	1Q	-8.34	
CHARGE3	3Q	\$37.48	
CHARGE3-	1Q	-11.49	
CHARGE4	3Q	\$34.68	
CHARGE4-	1Q	-4.88	
CHARGE5	4Q	\$28.14	
CHARGE5-	1Q	-6.40	
CHARGE6	7Q	\$138.31	
CHARGE6-	1Q	-10.64	
CHARGE7	4Q	\$41.56	
CHARGE7-	1Q	-11.49	
CHARGE8	5Q	\$75.38	
CHARGE8-	1Q	-15.49	
CHARGE9	5Q	\$47.18	
CHARGE9-	1Q	-8.63	
CHR TL	56Q	\$549.01	Total for charge
CHECK1	3Q	\$162.50	Check 1 sale counter and tendering counter
CHECK2	3Q	\$65.05	
CHECK3	4Q	\$110.20	
CHECK4	4Q	\$120.65	
CHECK5	3Q	\$162.39	
CHECK TL	17Q	\$620.79	Total for check
CA+CH ID		\$21519.07	Cash+check in drawer
****CID		\$20898.28	Cash in drawer
DEPOSIT	1Q	\$50.00	Deposit counter and total
DPST RF	1Q	-30.00	Deposit refund counter and total
TIP PAID	1Q	\$19.00	Tip-paid counter and total
CA TIP	2Q	\$7.00	Cash tip-in counter and total
CH TIP	1Q	\$12.00	Charge tip-in counter and total

Department report

• Sample X report

08/26/2002		123456
#1625	9:33PM	JACK0001
#0110 *X1*		
DEPARTMENT		
D01	7692Q	82.08%
DPT. 01		\$18008.35

Dept. code
Sales q'ty
Dept. label
Sales amount

• Sample Z report

08/26/2002		123456
#1816	11:03PM	JACK0001
#0110 *Z1*		
DEPARTMENT		
DEPARTMENT Z1		0006

Reset counter

↓
The subsequent printout occurs in the same format as in the sample X report.

D03	19Q	0.18%	Ratio of dept. 3 sales amount to "+ real dept. total
DPT. 03		\$40.46	
*DEPT TL	10826Q	\$21940.67	"+ real dept. counter and total
		100.00%	
D06	5Q	-1.30	"- real dept. counter and total
DPT. 06		-1.30	
DEPT (-)	5Q	-1.30	
D07	6Q	\$36.12	"+ hash dept. counter and total
DPT. 07		\$36.12	
*HASH TL	6Q	\$36.12	
D08	3Q	-4.08	"- hash dept. counter and total
DPT. 08		-4.08	
HASH (-)	3Q	-4.08	
D09	7Q	\$8.40	"+ bottle return dept. counter and total
DPT. 09		\$8.40	
*BTTL TL	7Q	\$8.40	
D10	5Q	-4.30	"- bottle return dept. counter and total
DPT. 10		-4.30	
BTTL (-)	5Q	-4.30	
D04	11Q	186	"+ gasoline dept. counter/gasoline q'ty/total
DPT. 04		\$224.70	
*GAS TL	11Q	186	
		\$224.70	
D05	6Q	-6	"- gasoline dept. counter/gasoline q'ty/total
DPT. 05		-4.80	
GAS (-)	6Q	-6	
		-4.80	

■ Individual group total report on departments

08/26/2002		123456
#1628	9:37PM	JACK0001
#0112 *X1*		
DEPT. IND. GROUP		
D02	3115Q	
DPT. 02		\$3891.86
D03	19Q	
DPT. 03		\$40.46
DPT GR-1	3134Q	\$3932.32

Dept. code
Sales q'ty
Sales amount
Dept. label
Group 1 sales q'ty and amount

■ Department markdown report

08/26/2002		123456
#1638	9:40PM	JACK0001
#0119 *X1*		
M-DOWN DEPT.		
D01		
DPT. 01		
(-) 3	2Q	-3.02
(-) 4	1Q	-1.73
(-) 5	1Q	-1.36
***TOTAL	4Q	-6.11
%3	2Q	-0.80
%4	1Q	-1.02
%5	1Q	-0.90
***TOTAL	4Q	-2.72
D02		
DPT. 02		
(-) 3	1Q	-1.51
(-) 4	1Q	-1.73
(-) 5	1Q	-1.36
***TOTAL	3Q	-4.60
%3	2Q	-1.35
%4	1Q	-0.78
%5	1Q	-1.56
***TOTAL	4Q	-3.69
D03		
DPT. 03		
(-) 3	1Q	-1.51
(-) 4	1Q	-1.73
(-) 5	1Q	-1.36
***TOTAL	3Q	-4.60
%3	2Q	-2.00
%4	1Q	-0.98
%5	1Q	-1.72
***TOTAL	4Q	-4.70

Dept. code
Dept. label
(-)3 counter and total (Item (-))
Item (-) counter and total for dept. 1
%3 counter and total (Item %)
Item % counter and total for dept. 1

■ Full group total report on departments

08/26/2002		123456
#1633	9:39PM	JACK0001
#0113 *X1*		
DEPT. GR. TOTAL		
DPT GR-1	3134Q	\$3932.32
DPT GR-2	7698Q	\$18044.47
DPT GR-3	11Q	\$224.70
DPT GR-4	0Q	\$0.00
DPT GR-5	0Q	\$0.00
DPT GR-6	0Q	\$0.00
DPT GR-7	0Q	\$0.00
DPT GR-8	0Q	\$0.00
DPT GR-9	7Q	\$8.40

Group 1 sales q'ty and amount

■ PLU/UPC report by designated range

• Sample X report

08/26/2002		123456	
#1645	9:41PM	JACK0001	
#0120 *X1*			PLU code
PLU/UPC			Item label for price level 1
	00001-9999999999999		PLU range
PLU			
P00001			
PLO0001-1	3072Q	\$3839.62	Sales q'ty and amount for price level 1
COMBO	3Q	\$4.50	Combo sales for price level 1
WASTE	-6Q	-7.50	
RF	-15Q	-18.75	
CP	7Q	-9.07	
NET SLS	3054Q	\$3808.80	Coupon counter and total for price level 1
PLO0001-2	1Q	\$1.30	
COMBO	1Q	\$1.50	
NET SLS	2Q	\$2.80	Net sales for price level 1
*1 If you need these information, please consult your dealer.			
PLO0001-6	1Q	\$1.28	
COMBO	1Q	\$1.50	
NET SLS	2Q	\$2.78	
P00002			
PLO0002-1	7334Q	\$16867.36	
COMBO	3Q	\$7.50	
WASTE	-4Q	-9.20	
PLO0020-6	1Q	\$2.20	
NET SLS	1Q	\$2.20	
***TOTAL	10923Q	\$22117.49	Total sales q'ty and total sales amount for price level 1
COMBO TL	18Q	\$50.10	
WASTE TL	-14Q	-29.10	
		0.13%	
RF TL	-63Q	-125.95	
CP	13Q	-18.34	
NET TL	10864Q	\$21994.20	
	10Q	\$28.41	Total sales q'ty and total sales amount for price level 6
COMBO TL	6Q	\$16.70	
WASTE TL	0Q	\$0.00	
		0.00%	
RF TL	0Q	\$0.00	
CP	0Q	\$0.00	
NET TL	16Q	\$45.11	

• Sample Z report

08/26/2002		123456	
#1817	11:04PM	JACK0001	
#0120 *Z1*			
PLU/UPC			
PLU/UPC Z1/Z2		0006	
The subsequent printout occurs in the same format as in the sample X report.			
UPC			
3111111111111#			
ITEM-K-1	2Q	-4.40	
NET SLS	2Q	-4.40	
ITEM-K-2	1Q	-2.10	
NET SLS	1Q	-2.10	
ITEM-K-3	1Q	-2.00	
NET SLS	1Q	-2.00	
ITEM-K-4	1Q	-2.30	
NET SLS	1Q	-2.30	
ITEM-K-5	1Q	-2.40	
NET SLS	1Q	-2.40	
ITEM-K-6	2Q	-5.00	
NET SLS	2Q	-5.00	
3234567891082#			
ITEM-B-1	4Q	\$11.44	
NET SLS	4Q	\$11.44	
5087654321106#			
ITEM-F-1	4Q	\$12.80	
NET SLS	4Q	\$12.80	
ITEM-F-6	4Q	\$12.00	
NET SLS	4Q	\$12.00	
***TOTAL	24Q	\$50.50	
WASTE TL	0Q	\$0.00	
		0.00%	
RF TL	-1Q	-2.10	
CP	0Q	\$0.00	
NET TL	23Q	\$48.40	
	22Q	\$43.50	
WASTE TL	0Q	\$0.00	
		0.00%	
RF TL	-1Q	-2.20	
CP	0Q	\$0.00	
NET TL	21Q	\$41.30	

■ PLU/UPC pick up report

• Sample X report

08/26/2002		123456
#1647	9:47PM	JACK0001
#0120 *X1*		
PLU/UPC		
PLU		PLU code
P00001		Item label for price level 1
PLO0001-1	3072Q	\$3839.62
COMBO	3Q	\$4.50
WASTE	-6Q	-7.50
RF	-15Q	-18.75
CP	7Q	-9.07
NET SLS	3054Q	\$3808.80
		17.44%
PLO0001-2	1Q	\$1.30
COMBO	1Q	\$1.50
*1		
If you need these information, please consult your dealer.		
PLO0001-6	1Q	\$1.28
COMBO	1Q	\$1.50
NET SLS	2Q	\$2.78
		21.99%
P00002		
PLO0002-1	7334Q	\$16867.36
COMBO	3Q	\$7.50
PLO0003-6	1Q	\$2.68
COMBO	1Q	\$2.10
NET SLS	2Q	\$4.78
		37.82%
***TOTAL	10816Q	\$21976.74
COMBO TL	9Q	\$18.30
WASTE TL	-14Q	-29.10
		0.13%
RF TL	-49Q	-107.35
CP	13Q	-18.34
NET TL	10762Q	\$21840.25
		100.00%
COMBO TL	3Q	\$6.54
WASTE TL	0Q	\$0.00
		0.00%
RF TL	0Q	\$0.00
CP	0Q	\$0.00
NET TL	6Q	\$12.64
		100.00%

• Sample Z report

08/26/2002		123456
#1820	11:10PM	JACK0001
#0120 *Z1*		
PLU/UPC		
PLU/UPC	Z1/Z2	0007
↓		
The subsequent printout occurs in the same format as in the sample X report.		
UPC	3234567891082#	
ITEM-B-1	4Q	\$11.44
NET SLS	4Q	\$11.44
		35.27%
ITEM-B-6	4Q	\$9.20
NET SLS	4Q	\$9.20
		34.33%
5012345678906#	ITEM-A-1	
	11Q	\$23.10
ITEM-A-6	9Q	\$19.80
RF	-1Q	-2.20
NET SLS	8Q	\$17.60
		65.67%
***TOTAL	15Q	\$34.54
WASTE TL	0Q	\$0.00
		0.00%
RF TL	-1Q	-2.10
CP	0Q	\$0.00
NET TL	14Q	\$32.44
		100.00%
WASTE TL	11Q	\$28.70
	0Q	\$0.00
		0.00%
RF TL	0Q	\$0.00
CP	0Q	\$0.00
NET TL	11Q	\$28.70
		100.00%

■ PLU/UPC report by associated department

• Sample X report

08/26/2002		123456
#1650	9:48PM	JACK0001
#0121 *X1*		
PLU BY DEPT		
DPT. 01		DO1
PLU		
P00002		
PL00002-1	7334Q	\$16867.36
COMBO	3Q	\$7.50
WASTE	-4Q	-9.20
RF	-21Q	-48.30
CP	3Q	-5.19
NET SLS	7312Q	\$16812.17
		93.10%
PL00002-2	1Q	\$2.50

Associated dept. code
PLU code
Item label
Sales q'ty and amount for price level 1

PL00002-6	1Q	\$2.58
COMBO	1Q	\$2.50
NET SLS	2Q	\$5.08
		21.93%
P00003		
PL00003-1	410Q	\$1269.76
COMBO	3Q	\$6.30

PL00020-6	1Q	\$2.20
NET SLS	1Q	\$2.20
		9.50%

***TOTAL	7749Q	\$18148.98
COMBO TL	9Q	\$28.80
WASTE TL	-8Q	-21.60
		0.12%
RF TL	-34Q	-88.60
CP	6Q	-9.27
NET TL	7716Q	\$18058.31
		100.00%

Total sales q'ty and total sales amount for price level 1

COMBO TL	5Q	\$13.56
WASTE TL	3Q	\$9.60
	0Q	\$0.00
		0.00%
RF TL	0Q	\$0.00
CP	0Q	\$0.00
NET TL	8Q	\$23.16
		100.00%

Total sales q'ty and total sales amount for price level 6

• Sample Z report

08/26/2002		123456
#1822	11:12PM	JACK0001
#0121 *Z1*		
PLU BY DEPT		
PLU/UPC	Z1/Z2	0008

The subsequent printout occurs in the same format as in the sample X report.

UPC	3234567891082#	
ITEM-B-1	4Q	\$11.44
NET SLS	4Q	\$11.44
		35.97%

ITEM-B-6	4Q	\$9.20
NET SLS	4Q	\$9.20
		32.06%

5045678912304#		
ITEM-D-1	3Q	\$7.56

ITEM-F-6	4Q	\$12.00
NET SLS	4Q	\$12.00
		41.81%

***TOTAL	11Q	\$31.80
WASTE TL	0Q	\$0.00
		0.00%
RF TL	0Q	\$0.00
CP	0Q	\$0.00
NET TL	11Q	\$31.80
		100.00%

WASTE TL	11Q	\$28.70
	0Q	\$0.00
		0.00%
RF TL	0Q	\$0.00
CP	0Q	\$0.00
NET TL	11Q	\$28.70
		100.00%

■ Individual group report on PLUs/UPCs

08/26/2002		123456
#1661	9:53PM	JACK0001
#0122 *X1*		
PLU IND. GROUP		
PLU		PLU code
P00003		
PL00003-1	396Q	\$1219.28
PL00003-2	2Q	\$5.60
PL00003-3	2Q	\$3.30
PL00003-4	2Q	\$4.85
PL00003-5	1Q	\$2.60
PL00003-6	2Q	\$4.78
P00004		
PL00004-1	69Q	\$84.18
PL00004-2	1Q	\$1.76
PL00004-3	1Q	\$2.22
PL00004-4	1Q	\$2.10
PL00004-5	1Q	\$2.15
PL00004-6	1Q	\$2.20
UPC		
5012345678906#		
ITEM-A-1	10Q	\$21.00
ITEM-A-2	9Q	\$22.50
ITEM-A-3	6Q	\$12.90
ITEM-A-4	6Q	\$15.60
ITEM-A-5	4Q	\$11.00
ITEM-A-6	8Q	\$17.60
PLU GR01	522Q	\$1435.62

Group 1 sales q'ty and amount

■ PLU/UPC stock report by designated range

08/26/2002		123456
#1663	9:51PM	JACK0001
#0124 *X1*		
PLU STOCK		
	00001-999999999999	Range
PLU		PLU code
P00001		
PL00001-1	521S	\$651.25
P00002		
PL00002-1	362S	\$832.60
UPC		
3111111111111#		
ITEM-K-1	62S	-136.40
3112345678905#		
ITEM-J-1	35S	\$10.50
UPC		
5089123456708#		
ITEM-C-1	20S	\$24.00
5099887654302#		
ITEM-E-1	21S	\$0.21

■ Full group total report on PLUs/UPCs

08/26/2002		123456
#1662	9:54PM	JACK0001
#0123 *X1*		
PLU GR. TOTAL		
PLU GR01	522Q	\$1435.62
PLU GR02	7418Q	\$16984.48
PLU GR03	3090Q	\$3907.73
PLU GR99	7350Q	\$16920.53

■ PLU/UPC stock pick up report

08/26/2002		123456
#1667	9:56PM	JACK0001
#0124 *X1*		
PLU STOCK		
PLU		PLU code
P00001		
PL00001-1	521S	\$651.25
P00002		
PL00002-1	362S	\$832.60
P00003		
PL00003-1	268S	\$830.80
UPC		
3234567891082#		
ITEM-B-1	12S	\$34.32
5012345678906#		
ITEM-A-1	34S	\$71.40

■ PLU/UPC zero sales report (full)

```

08/26/2002 123456
#1671 10:02PM JACK0001

#0127 *X1*
PLU ZERO SALES

PLU
P00013 PL00013-1
P00014 PL00014-1
P00015 PL00015-1
P00016 PL00016-1
P00017 PL00017-1
-----
UPC
3112345678905#ITEM-J-1
3222222222221#ITEM-U-1
3232109876582#ITEM-G-1
3555555555551#ITEM-Q-1
5089123456708#ITEM-C-1
5099887654302#ITEM-E-1
    
```

PLU code
Item label

■ PLU/UPC minimum stock report

```

08/26/2002 123456
#1685 10:05PM JACK0001

#0128 *X1*
PLU MIN. STOCK

00001-9999999999999999
PLU
P00007
PL00007-1 15S
P00008
PL00008-1 12S
-----
UPC
3234567891082#
ITEM-B-1 12S
    
```

Range
PLU code
Stock q'ty
Item label

■ PLU/UPC zero sales (by dept.) report

```

08/26/2002 123456
#1673 10:02PM JACK0001

#0127 *X1*
PLU ZERO SALES

DPT. 02
PLU
P00014 PL00014-1
-----
UPC
3222222222221#ITEM-U-1
3555555555551#ITEM-Q-1
    
```

PLU code
Associated dept. code
Item label

■ PLU/UPC price category report

• Sample X report

08/26/2002		123456
#1688	10:09PM	JACK0001
#0129 *X1*		
PLU CATEGORY		
	2.00-	2.20
PLU		Price range
P00001		
PL00001-4	1Q	\$2.10
P00004		
PL00004-4	1Q	\$2.10
PL00004-5	1Q	\$2.15
PL00004-6	1Q	\$2.20
P00020		
PL00020-6	1Q	\$2.20

***TOTAL	0Q	\$0.00
	0Q	\$0.00
	0Q	\$0.00
	2Q	\$4.20
	1Q	\$2.15
	2Q	\$4.40

UPC		
3234567891082#		
ITEM-B-5	1Q	\$2.20
5012345678906#		
ITEM-A-1	11Q	\$23.10
ITEM-A-3	7Q	\$15.05
ITEM-A-6	9Q	\$19.80

***TOTAL	11Q	\$23.10
	0Q	\$0.00
	7Q	\$15.05
	0Q	\$0.00
	1Q	\$2.20
	9Q	\$19.80

■ Cash in drawer report

• Sample X report

08/26/2002		123456
#1727	10:22PM	JACK0001
#0131 *X1*		
CID		
SRV#0001	JACK	Server code
TRANS CT	610Q	Server name
NET3	\$22902.59	Transaction counter
****CID	\$21564.91	Sales total

SRV#0002	JIM	Cash in drawer
TRANS CT	6Q	
NET3	\$1892.56	
****CID	\$1892.56	

***TOTAL		
TRANS CT	621Q	Total
NET3	\$26658.80	
****CID	\$25321.12	

■ Positive check report

• Sample X report

08/26/2002		123456
#1731	10:24PM	JACK0001
#0139 *X1*		
POSITIVE CHECK		
#0000000055667788		
CHARGE7	\$62.02	
#0000000022331100		
CHECK3	\$110.00	

• Sample Z report

08/26/2002		123456
#1829	11:23PM	JACK0001
#0139 *Z1*		
POSITIVE CHECK		
#0000000055667788		
CHARGE7	\$62.02	
#0000000022331100		
CHECK3	\$110.00	

■ Dynamic UPC report by designated range

• Sample X report

08/26/2002		123456
#1693	10:14PM	JACK0001
#0169 *X1*		
DYNAMIC UPC		
1000000000000-999999999999		
1123456789005#		
ITM(2)-1	5Q	\$15.85
NET SLS	5Q	\$15.85
		100.00%
ITM(2)-6	8Q	\$22.40
NET SLS	8Q	\$22.40
		100.00%

***TOTAL	5Q	\$15.85
WASTE TL	0Q	\$0.00
		0.00%
RF TL	0Q	\$0.00
CP	0Q	\$0.00
NET TL	5Q	\$15.85
		100.00%
WASTE TL	8Q	\$22.40
	0Q	\$0.00
		0.00%
RF TL	0Q	\$0.00
CP	0Q	\$0.00
NET TL	8Q	\$22.40
		100.00%

■ Dynamic UPC pick up report

• Sample X report

08/26/2002		123456
#1694	10:15PM	JACK0001
#0169 *X1*		
DYNAMIC UPC		
1123456789005#		
ITM(2)-1	5Q	\$15.85
NET SLS	5Q	\$15.85
		100.00%
ITM(2)-6	8Q	\$22.40
NET SLS	8Q	\$22.40
		100.00%

***TOTAL	5Q	\$15.85
WASTE TL	0Q	\$0.00
		0.00%
RF TL	0Q	\$0.00
CP	0Q	\$0.00
NET TL	5Q	\$15.85
		100.00%
WASTE TL	8Q	\$22.40
	0Q	\$0.00
		0.00%
RF TL	0Q	\$0.00
CP	0Q	\$0.00
NET TL	8Q	\$22.40
		100.00%

*1

If you need these information, please consult your dealer.

• Sample Z report

08/26/2002		123456
#1823	11:15PM	JACK0001
#0169 *Z1*		
DYNAMIC UPC		



The subsequent printout occurs in the same format as in the sample X report.

■ Dynamic UPC report by associated department

- Sample X report

08/26/2002		123456
#1699	10:16PM	JACK0001
#0166 *X1*		
D-UPC BY DEPT		
DPT. 01		DO1
1123456789005#		
ITM(2)-1	5Q	\$15.85
NET SLS	5Q	\$15.85
		100.00%
ITM(2)-6	8Q	\$22.40
NET SLS	8Q	\$22.40
		100.00%

***TOTAL	5Q	\$15.85
WASTE TL	0Q	\$0.00
		0.00%
RF TL	0Q	\$0.00
CP	0Q	\$0.00
NET TL	5Q	\$15.85
		100.00%

WASTE TL	8Q	\$22.40
	0Q	\$0.00
		0.00%
RF TL	0Q	\$0.00
CP	0Q	\$0.00
NET TL	8Q	\$22.40
		100.00%

- Sample Z report

08/26/2002		123456
#1824	11:16PM	JACK0001
#0166 *Z1*		
D-UPC BY DEPT		



The subsequent printout occurs in the same format as in the sample X report.

*1

If you need these information, please consult your dealer.

■ Tax report

08/26/2002 123456			
#1741	10:30PM	JACK0001	
#0133 *X1*			
TAX			
TAX1 ST	\$73.25	Net taxable 1 total	
GRS TAX1	\$4.71	Gross tax 1 total	
RFD TAX1	-0.30	Refund tax 1 total	
TAX1	\$4.41	Net tax 1 total	
TX1 EXPT	\$5.00	Taxable 1 exempt total	
TAX2 ST	\$56.15		
GRS TAX2	\$2.61		
RFD TAX2	-0.36		
TAX2	\$2.25		
TX2 EXPT	\$9.20		
TAX3 ST	\$87.09		
GRS TAX3	\$4.86		
RFD TAX3	-0.70		
TAX3	\$4.16		
TX3 EXPT	\$10.52		
TAX4 ST	\$49.05		
GRS TAX4	\$3.32		
RFD TAX4	-0.62		
TAX4	\$2.70		
TX4 EXPT	\$7.98	Gross manual tax total	
GRS MTAX	\$1.47	Refund manual tax total	
RFD MTAX	-0.58	Net manual tax total	
M-TAX	\$0.89		
TTL TAX	\$14.41	Tax total	

(When the Canadian tax system is selected)

Tax 1	
TAX1 ST	\$39.45
GRS TAX1	\$2.53
RFD TAX1	-0.15
TAX1	\$2.38
TX1 EXPT	\$5.00

Tax 4	
TAX4 ST	\$39.29
GRS TAX4	\$2.59
RFD TAX4	-0.47
TAX4	\$2.12
TX4 EXPT	\$7.98
GRS MTAX	\$1.47
RFD MTAX	-0.38
M-TAX	\$1.09
GST EXPT	\$20276.17
PST TTL	\$6.03
GST TTL	\$2.12

Manual tax
Exempt total from GST
PST total
GST total

■ Key capture report

08/26/2002 123456			
#1737	10:26PM	JACK0001	
#0179 *X1*			
KEY CAPTURE			
#01		Capture job no.	
08/26/2002	8:31PM	} Capture information	
#1527	JACK0001		
CAPTURE01	12345		
#02			
08/26/2002	8:31PM	}	
#1528	JACK0001		
CHARGE5	212121		
08/26/2002	8:33PM	}	
#1529	JACK0001		
CAPTURE02	212121		

Individual server report

• Sample X report

08/26/2002		123456
#1744	10:37PM	JACK0001
#0141 *X1*		
IND. SERVER		
SRV#0001	JACK	Server name
NET 1	\$22919.11	Net sales total
(%) SALES	\$1145.96	
V. CP UPC	0Q	\$0.00
GRATUITY		\$49.17
CA TIP	0Q	\$0.00
CH TIP	0Q	\$0.00
TIP PAID	1Q	\$19.00
TRANS CT	614Q	Transaction counter
COVER CT	647Q	Cover counter
NET 3	\$23161.42	
CLOSE CK	2Q	\$96.23
OPEN CK	0Q	\$0.00
TRAN. OUT	1Q	\$23.05
TRAN. IN	1Q	\$23.05
***RA	1Q	\$82.00
***RA2	1Q	\$75.00
***PO	1Q	\$20.00
***PO2	1Q	\$50.00
REFUND	69Q	\$140.25
RETURN	3Q	\$6.65
DIR VD	5Q	\$13.10
PAST VD	9Q	\$18.10
(-) 1	5Q	-5.60
(-) 2	5Q	-6.00
%1	1Q	-1.82
%2	1Q	-1.61
(-) 3	7Q	-10.57
(-) 4	6Q	-10.38
(-) 5	6Q	-8.16
%3	8Q	-4.53
%4	6Q	-3.62
%5	5Q	-5.42
GDISC%1	2Q	-0.63
GDISC%2	2Q	-2.30
GDISC%3	2Q	-3.88
GDISC%TL	6Q	-6.81
GAS(-)1	3Q	-147.60

• Sample Z report

08/26/2002		123456
#1825	11:19PM	JACK0001
#0141 *Z1*		
IND. SERVER		
SERVER Z1/Z2		0006

The subsequent printout occurs in the same format as in the sample X report.

GAS(-) 19	0Q	\$0.00
DRW CNT	146Q	
CONV 1		30.00
CONV 2		40.00
CONV 3		35.00
CONV 4		33.00
CASH	528Q	\$21822.00
CASH2	2Q	\$35.74
CASH3	2Q	\$40.72
CASH4	3Q	\$56.96
CASH5	2Q	\$45.57
CHARGE1	10Q	\$150.35
CHARGE1-	1Q	-3.75
CHARGE9	5Q	\$47.18
CHARGE9-	1Q	-8.63
CHECK1	3Q	\$162.50
CHECK2	3Q	\$65.05
CHECK3	6Q	\$260.20
CHECK4	4Q	\$120.65
CHECK5	3Q	\$162.39
CA+CH ID		\$22331.89
****CID		\$21561.10
GROUP1	3238Q	\$4331.65
GROUP2	7953Q	\$18765.10
GROUP3	6Q	\$36.12
GROUP4	0Q	\$0.00
GROUP5	0Q	\$0.00
GROUP6	0Q	\$0.00
GROUP7	0Q	\$0.00
GROUP8	0Q	\$0.00
GROUP9	7Q	\$8.40

Server group 1 total

NOTE

When the tip amount remains unchanged in Individual Server Resetting, the tip paid function is automatically executed and a tip receipt is printed on the report printer prior to report printing.

■ Full server report

- Sample X report

```
08/26/2002 123456
#1747 10:43PM JACK0001

#0140 *X1*
ALL SERVER
```

- Sample Z report

```
08/26/2002 123456
#1827 11:20PM JACK0001

#0140 *Z1*
ALL SERVER

SERVER Z1/Z2 0007
```

Reset counter

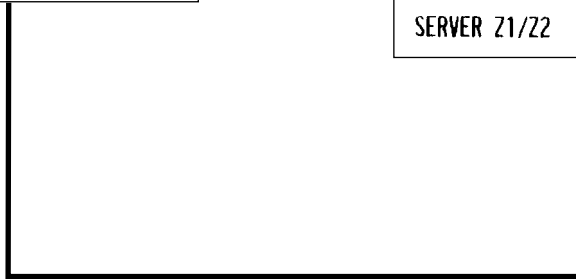

The subsequent printout occurs in the same format as in the sample report shown in the "Individual server report"; and sales data on servers print in this sequence.

Hourly report

• Sample X report

08/26/2002		123456	
#1511	7:52PM	JACK0001	
#0160 *X1*			
HOURLY			
10:00AM	36Q	\$1829.20	Transaction counter
COVER CT	36Q		Sales total
AVE.		\$50.81	Cover counter
10:30AM	72Q	\$2662.20	Average sales amount per customer (Sales total/cover counter)
COVER CT	72Q		
AVE.		\$36.98	
SUBTOTAL	108Q	\$4491.40	Subtotal (10:00 - 10:59)
COVER CT	108Q		
7:00PM	57Q	\$2495.80	
COVER CT	57Q		
AVE.		\$43.79	
7:30PM	66Q	\$2923.80	
COVER CT	66Q		
AVE.		\$44.30	
SUBTOTAL	123Q	\$5419.60	
COVER CT	123Q		

• Sample Z report

08/26/2002		123456
#1828	11:21PM	JACK0001
#0160 *Z1*		
HOURLY		
HOURLY Z1		0006



The subsequent printout occurs in the same format as in the sample X report.

NOTE The hourly report can be formatted by 15 min., 30 min., or 1 hour intervals depending upon programming.

■ GLU/PBLU report

• Sample X report

08/26/2002		123456
#1772	10:48PM	JACK0001
#0180 *X1*		
GLU		
1#		1-9999
COVER CT	2Q	0001
***PBAL		\$31.00
2#		0001
COVER CT	3Q	
***PBAL		\$73.50

Range
Table#/PBLU code
Server code
Cover counter
Balance amount

8T		0002
COVER CT	2Q	
***PBAL		\$72.60
FREE GLU		
7#		
COVER CT	2Q	
***PBAL		\$57.50
***TOTAL		
COVER CT	9Q	
***PBAL		\$187.75

"T": This table#/PBLU code was used in the training mode.

Free table#/PBLU code
(This number or code has been transferred out.)

Total

• Sample Z report

08/26/2002		123456
#1830	11:25PM	JACK0001
#0180 *Z1*		
GLU		
GLU Z1		0006

↓
The subsequent printout occurs in the same format as in the sample X report.

■ GLU/PBLU report by server

• Sample X report

08/26/2002		123456
#1777	10:49PM	JACK0001
#0181 *X1*		
GLU BY SERVER		
SRV#0001		JACK
1#		
COVER CT	2Q	
***PBAL		\$31.00
FREE GLU		
7#		
COVER CT	2Q	
***PBAL		\$57.50
***TOTAL		
COVER CT	9Q	
***PBAL		\$187.75

Server code
Server name
Table#/PBLU code
Cover counter
Balance amount

• Sample Z report

08/26/2002		123456
#1831	11:26PM	JACK0001
#0181 *Z1*		
GLU BY SERVER		
GLU Z1		0007

↓
The subsequent printout occurs in the same format as in the sample X report.

■ Closed GLU/PBLU report

• Sample X report

08/26/2002		123456
#1783	10:50PM	JACK0001
#0182 *X1*		
CLOSED GLU		
0021#	0001-9999	Bill no.
TBL#1	0001	Bill range
COVER CT	2Q	Server code
CHARGE6	\$56.92	Table#
TIP AMT	\$0.00	Cover counter
FIN. BAL	\$56.92	Amount
0022#	0001	Tip amount by tip edit
TBL#2		Final balance amount
COVER CT	2Q	
CHARGE6	\$39.31	
TIP AMT	\$0.00	
FIN. BAL	\$39.31	
0029#	0001	
TBL#4		
COVER CT	2Q	
CASH	\$80.77	
FIN. BAL \$88.03		
***TOTAL		
COVER CT	14Q	
CASH	1Q	\$80.77
CHK/CG	2Q	\$1.94
CHECK1	1Q	\$85.00
CHECK2	1Q	\$85.00
CHARGE5	1Q	\$70.77
CHARGE6	2Q	\$96.23
CONV 1	1Q	116.64
TIP AMT	0Q	\$0.00
FIN. BAL	7Q	\$503.86

• Sample Z report

08/26/2002		123456
#1832	11:27PM	JACK0001
#0182 *Z1*		
CLOSED GLU		
GLU Z1		0008

↓

The subsequent printout occurs in the same format as in the sample X report.

■ Closed GLU/PBLU report by server

• Sample X report

08/26/2002 123456		
#1786	10:51PM	JACK0001
#0183 *X1*		
CL-GLU BY SERV		
SRV#0001	JACK	Server code
0021#		Server name
TBL#1		Bill no.
COVER CT	2Q	Table#
CHARGE6		Cover counter
TIP AMT		Amount
FIN. BAL		Tip amount by tip edit
0022#		Final balance amount
TBL#2		
COVER CT	2Q	
CHARGE6		
FIN. BAL		\$88.03
***TOTAL		
COVER CT	14Q	
CASH	1Q	\$80.77
CHK/CG	2Q	\$1.94
CHECK1	1Q	\$85.00
CHECK2	1Q	\$85.00
CHARGE5	1Q	\$70.77
CHARGE6	2Q	\$96.23
CONV 1	1Q	116.64
TIP AMT	0Q	\$0.00
FIN. BAL	7Q	\$503.86

• Sample Z report

08/26/2002 123456		
#1834	11:28PM	JACK0001
#0183 *Z1*		
CL-GLU BY SERV		
GLU Z1		0009

↓
The subsequent printout occurs in the same format as in the sample X report.

■ X1/Z1 stacked reports

You can print multiple X1/Z1 reports in sequence under a single report job number. In this case, you need to program in advance which X1/Z1 reports should be printed. Refer to "Stacked report" under the section "Report Programming" in Chapter 13.

Periodic Consolidation

Your POS terminal allows you to take consolidation X and Z reports of a chosen period (the period is usually one week or month).

- **General overview**

The periodic reading or resetting reports are the same in format as those in the X1/Z1 report for daily sales information except mode indication ("X2" or "Z2").

■ Transaction report

- **Sample X report**

```
08/26/2002 123456
#1837 11:34PM JACK0001

#0230 *X2*
TRANSACTION
```

Read symbol
Report title

- **Sample Z report**

```
08/26/2002 123456
#1841 11:36PM JACK0001

#0230 *Z2*
TRANSACTION

TRANS. Z1 0009
TRANS. Z2 0002
GT1 $00000076837.52
GT2 $00000077368.86
GT3 -00000000531.34
TR $00000001353.84
```

Reset symbol
Report title
Reset counter of periodic consolidation
Grand totals

The subsequent printouts are the same in format as those in the X/Z report on daily totals.

■ Daily net report

- Sample X report

09/30/2002			123456
#5137	10:38PM	JACK0001	
#0270 *X2*			
DAILY NET			
09/01	114Q	\$6100.86	
09/02	102Q	\$3520.02	
09/03	126Q	\$5578.02	
09/29	105Q	\$4501.95	
09/30	138Q	\$6402.06	
***TOTAL	1113Q	\$49477.47	

Date
 Transaction counter
 Sales total

- Sample Z report

09/30/2002			123456
#5163	11:00PM	JACK0001	
#0270 *Z2*			
DAILY NET			
DAILY NET Z2			0003



The subsequent printout occurs in the same format as in the sample X report.

■ Customer sales report 1 and 2

NOTE

Customer sales report 1 and 2 are printed in the same format except the report title. You can print either report depending on the programming of CUSTOMER DATA in FUNC.SELECT2 menu. On the customer sales report 1, you can print (and reset in Z2 mode) details (date/sales item) only. On the customer sales report 2, you can print (and reset in Z2 mode) accumulated sales q'ty/total and details.

#0285 *X2*			*
CUSTOM SALES1			
#0000000000001-#9999999999999			Code range
#0000000000020			Customer code
NAME-20			Name
ADDRESS-20			Address
	2Q	\$67.37	Sales q'ty and total
CHARGE		\$27.36	Charge account
12/16/2002			Date
P00005			
PL00005-1	1Q	\$1.60	Sales items
P00003			
PL00003-1	1Q	\$3.10	
P00002			
#0000000065321			
NAME-65321			
ADDRESS-65321			
	1Q	\$57.52	
CHARGE		\$0.00	
12/16/2002			
P00002			
PL00002-1	25Q	\$57.50	
P00003			
PL00003-1	17Q	\$52.70	
P00003			
PL00003-1	-17Q	-52.70	
SUBTOTAL	6Q	\$261.28	Subtotal on the report
CHARGE		\$89.38	
***TOTAL	6Q	\$261.28	The full total on the customer file
CHARGE		\$89.38	

* When you take a Z report, "Z2" is printed instead of "X2".

■ Customer sales report by sales range

#0286 *X2*			
CUSTOM BY AMT			
	\$0.01-\$9999999.99		Sales range
#0000000000020			Customer code
NAME-20			Name
ADDRESS-20			Address
	2Q	\$67.37	Sales q'ty and total
CHARGE		\$27.36	Charge account
12/16/2002			Date
P00005			
PL00005-1	1Q	\$1.60	Sales items

* When you take a Z report, "Z2" is printed instead of "X2".

#0000000065321			
NAME-65321			
ADDRESS-65321			
	1Q	\$57.52	
CHARGE		\$0.00	
12/16/2002			
P00002			
PL00002-1	25Q	\$57.50	
P00003			
PL00003-1	17Q	\$52.70	
P00003			
PL00003-1	-17Q	-52.70	
SUBTOTAL	6Q	\$261.28	Subtotal on the report
CHARGE		\$89.38	
***TOTAL	6Q	\$261.28	The full total on the customer file
CHARGE		\$89.38	

■ Customer charge account report

#0288 *X2*			
CHARGE ACCOUNT			
#0000000000020			Customer code
NAME-20			Name
ADDRESS-20			Address
CHARGE		\$27.36	
#0000000000075			
NAME-75			
ADDRESS-75			
CHARGE		\$62.02	
SUBTOTAL			
CHARGE		\$89.38	
***TOTAL			
CHARGE		\$89.38	

■ X2/Z2 stacked report

You can print multiple X2/Z2 reports in sequence under a single transaction. In this case you need to program in advance which X2/Z2 reports should be printed. Refer to "Stacked report" under Section "Report Programming" in Chapter 13 "Programming."

* When you take a Z report, "Z2" is printed instead of "X2".

11

Non-accessed UPC, Dynamic UPC and Customer Deletion

X1/Z1 MODE

X2/Z2 MODE

You can delete UPCs and customers that had not been accessed for a certain period. You can program a period in the PGM2 mode. As for customer, you can also delete customers with regardless to a non-accessed period.

Follow the procedure shown below.

Non-accessed UPC deletion

1. Move the mode key to X1/Z1 position.
2. Select "6 UPC DELETE".
3. Select "1 READING" to take a report, or "2 DELETE" to delete non-accessed UPCs.
4. When you select "2 DELETE", select whether you want to delete all the non-accessed UPCs (1 ALL DELETE) or delete the non-accessed UPCs individually (2 IND.DELETE).

NOTE *It is recommended to take a report first before executing deleting operation.*

Dynamic UPC clear

1. Move to the mode key to X1/Z1 position.
2. Select "6 UPC DELETE".
3. Select "3 D-UPC CLEAR" to clear by designated range, "4 D-UPC CLR PICK" to clear by pick up codes (see the "NOTE" on page 63), or "5 D-UPC CLR DEPT" to clear by associated department.

Non-accessed customer deletion

1. Move the mode key to X2/Z2 position.
2. Select "5 NO ACCESS. CUST.".
3. Select "1 READING" to take a report, or "2 DELETE" to delete non-accessed customers.
4. When you select "2 DELETE", select you want to delete all the non-accessed customers (1 ALL DELETE) or delete the non-accessed customers individually (2 IND.DELETE).

NOTE *It is recommended to take a report first before executing deleting operation.*

Customer deletion

1. Move the mode key to X2/Z2 position.
2. Select "6 CUSTOM DELETE".
3. Specify the range (start/end customer codes) you want to delete.

■ Non-accessed UPC report

	#0105 *X1*			*1
	UPC DELETE			
UPC				
UPC code	3112345678905#			
Item label	ITEM-J-1	0Q	\$0.00	
		0Q	\$0.00	
		0Q	\$0.00	
		0Q	\$0.00	
		0Q	\$0.00	
		0Q	\$0.00	
	ITEM-J-6	0Q	\$0.00	
	322222222221#			
	ITEM-U-1	1Q	\$0.10	
	NET SLS	1Q	\$0.10	
		0Q	\$0.00	
		0Q	\$0.00	
		0Q	\$0.00	
		0Q	\$0.00	
	ITEM-U-6	0Q	\$0.00	
				*2

*1 When you select "DELETE", "Z1" is printed instead of "X1".

*2 When there is any sales data of the UPC for PLU/UPC report, the data is printed here.

When you delete the UPC in Z1 mode under this situation, the UPC data for PLU/UPC report is also deleted.

■ Non-accessed customer report

	#0287 *X2*			*
	NO ACCES.CUST.			
	#0000000000020			Customer code
	NAME-20			Name
	ADDRESS-20			Address
		2Q	\$67.37	
	CHARGE		\$27.36	
	#0000000000075			
	NAME-75			
	ADDRESS-75			
		3Q	\$136.39	
	CHARGE		\$62.02	
	#00000000065321			
	NAME-65321			
	ADDRESS-65321			
		1Q	\$57.52	
	CHARGE		\$0.00	
	SUBTOTAL	6Q	\$261.28	
	CHARGE		\$89.38	
	***TOTAL	6Q	\$261.28	
	CHARGE		\$89.38	

* When you select "DELETE", "Z2" is printed instead of "X2".

Customer delete report

#0298 *Z2*		
CUSTOM DELETE		
#0000000000001-#9999999999999		Customer range
#0000000000102		Customer code
NAME-102		Name
ADDRESS-102		Address
CHARGE	0Q	\$0.00
		\$0.00
#0000000000123		
NAME-123		
ADDRESS-123		
CHARGE	0Q	\$0.00
		\$0.00
#00000000005678		
NAME-5678		
ADDRESS-5678		
CHARGE	0Q	\$0.00
		\$0.00
SUBTOTAL	0Q	\$0.00
CHARGE		\$0.00
***TOTAL	0Q	\$0.00
CHARGE		\$0.00

Dynamic UPC clear

(by designated range)

#0168 *Z1*		
D-UPC CLEAR		
1000000000000-9999999999999		
1123456789005#		
ITM(2)-1	5Q	\$15.85
NET SLS	5Q	\$15.85
		100.00%
ITM(2)-6	8Q	\$22.40
NET SLS	8Q	\$22.40
		100.00%
---TOTAL	5Q	\$15.85
WASTE TL	0Q	\$0.00
		0.00%
RF TL	0Q	\$0.00
CP	0Q	\$0.00
NET TL	5Q	\$15.85
		100.00%
WASTE TL	8Q	\$22.40
	0Q	\$0.00
		0.00%
RF TL	0Q	\$0.00
CP	0Q	\$0.00
NET TL	8Q	\$22.40
		100.00%

(by pickup list)

#0168 *Z1*	
D-UPC CLEAR	

(by associated dept.)

#0167 *Z1*	
D-UPC CLR DEPT	
DPT. 01	DO1

*1
If you need these information,
please consult your dealer.

12

How to Use the Programming Keyboard Sheet

The programming keyboard sheet is used for programming in the PGM 1 or PGM 2 mode. This sheet is transparent. Place the sheet over the standard keyboard sheet or blank keyboard sheet when programming.

Programming Keyboard Layout

↑ RECEIPT	↑ JOURNAL		[]	Ñ	_	-	+	¿	{	}				
							”	’	?	<	>				
!	@	#	\$	%	^	&	*	()	=			(INS)	(DEL)	
Q	W	E	R	T	Y	U	I	O	P	/			(CANCEL)	(RECALL)	(BACK SPACE)
A	S	D	F	G	H	J	K	L	;	:	@/FOR	•	CL	(PREV. RECORD)	
	Z	X	C	V	B	N	M	,	.	(PAGE UP)	7	8	9	(NEXT RECORD)	
(SHIFT)		(SPACE)	(SPACE)	(SPACE)	(SPACE)	(SPACE)			(DC)	(PAGE DOWN)	4	5	6	(UPDATE)	
									(↑)	(ENTER)	1	2	3		
									(←)	(↓)	(→)	0	00	000	SBTL CA/AT

 : The shaded area contains the character keys which are used for programming characters.

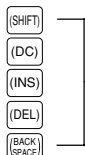

Used for programming characters. For more information about programming characters, see the section “How to Program Alphanumeric Characters.”



Used to move the cursor.



: Used to program each setting.



: Used to finalize programming.



: Used to cancel programming and to get back to the previous screen.



: Used to go back to the previous record, e.g., from the department 2 programming window back to the department 1 programming window.



: Used to go to the next record, for example, in order to program unit prices for sequential departments.



: Used to scroll the window to go to the next page.



: Used to scroll the window to go back to the previous page.



: Used to clear the last setting you have programmed or clear the error state.



: Used to toggle between two or more options.

[SBTL] : Used to list those options which you can toggle by the **[.]** key.

[RECALL] : Used to call up a desired code.

[UPDATE] : Used to update PLU unit price or name.

Numeric keys: Used for entering figures.

For more information about using these keys, see the “Basic Instructions” section in Chapter 13 “Programming.”

How to Program Alphanumeric Characters

This section discusses how to program alphanumeric characters such as “DESCRIPTION,” “NAME” and “TEXT.”

■ Using character keys on the keyboard

Entering alphanumeric characters

To enter a character, simply press a corresponding character on the programming keyboard sheet.

To enter a digit, simply press a corresponding numeric key.

Entering double-size characters

[DC] : This key toggles the double-size character mode and the normal-size character mode. The default is the normal-size character mode. When the double-size character mode is selected, the letter “W” appears at the bottom of the display.

Entering upper-case letters

[SHIFT] : You can enter an upper-case letter by using this key. Press this key just before you enter the upper-case letter. You should press this key each time you enter an upper-case letter.

Editing text

You can edit the text you have entered by deleting and/or inserting characters.

To select a text editing mode

[INS] : Toggles between the insert mode (“_”) and the overwrite mode (“■”).

To move the cursor

[←] or **[→]** : Moves the cursor.

To delete a character or figure

[DEL] : Deletes a character or figure in the cursor position.

[BACK SPACE] : Backs up the cursor for deleting the character or figure at the left of the cursor. When your POS terminal is in the insert mode, this key deletes the character or the value at the cursor position.

Text copy/paste

Copy (to the buffer): Move the cursor to the target text line to copy, and press **[@/FOR]** key.

Paste (from the buffer): Move the cursor to the target text line to paste, and press **[.]** key.

■ Entering character codes

Numerals, letters and symbols are programmable by pressing the 00 key followed by character codes. Use the following procedure with the cursor placed at the position where you want to enter characters:

00 → XXX XXX: Character code (3 digits)

Character code:

032 - 047	032	033	034	035	036	037	038	039	040	041	042	043	044	045	046	047
		!	"	#	\$	%	&	'	()	*	+	,	-	.	/
048 - 063	048	049	050	051	052	053	054	055	056	057	058	059	060	061	062	063
	0	1	2	3	4	5	6	7	8	9	:	;	<	=	>	?
064 - 079	064	065	066	067	068	069	070	071	072	073	074	075	076	077	078	079
	Q	A	B	C	D	E	F	G	H	I	J	K	L	M	N	O
080 - 095	080	081	082	083	084	085	086	087	088	089	090	091	092	093	094	095
	P	Q	R	S	T	U	V	W	X	Y	Z	[\]	^	_
096 - 111	096	097	098	099	100	101	102	103	104	105	106	107	108	109	110	111
	`	a	b	c	d	e	f	g	h	i	j	k	l	m	n	o
112 - 127	112	113	114	115	116	117	118	119	120	121	122	123	124	125	126	127
	p	q	r	s	t	u	v	w	x	y	z	{		}	~	Δ
128 - 143	128	129	130	131	132	133	134	135	136	137	138	139	140	141	142	143
	Ç	ü	é	â	ä	à	ã	ç	ê	ë	è	ï	î	ì	Ä	Å
144 - 159	144	145	146	147	148	149	150	151	152	153	154	155	156	157	158	159
	É	æ	ƒ	ô	ö	ò	û	ù	ÿ	ö	ü	ç	ƒ	¥	℞	f
160 - 175	160	161	162	163	164	165	166	167	168	169	170	171	172	173	174	175
	á	í	ó	ú	ñ	Ñ	º	º	¿	¡	½	¼	¡	«	»	
176 - 191	176	177	178	179	180	181	182	183	184	185	186	187	188	189	190	191
	⋮	⋮	⋮					π	π	π	π	π	π	π	π	π
192 - 207	192	193	194	195	196	197	198	199	200	201	202	203	204	205	206	207
	L	L	T	T	-	+	+		U	π	π	π	π	=	π	±
208 - 223	208	209	210	211	212	213	214	215	216	217	218	219	220	221	222	223
	π	T	π	U	U	ƒ	π	π	†	J	γ	■	■	■	■	■
224 - 239	224	225	226	227	228	229	230	231	232	233	234	235	236	237	238	239
	α	β	γ	π	Σ	σ	μ	τ	ϑ	θ	Ω	δ	ω	φ	€	π
240 - 255	240	241	242	243	244	245	246	247	248	249	250	251	252	253	254	255
	≡	±	≥	≤	Γ	J	÷	≈	°	.	.	√	π	z	■	(DC)

*(DC) : Double-size character code

"_" (095): Line feed code

■ : Shade characters can not be printed by the built-in printer (display only).

This chapter explains how to program various items. Before you start programming, turn the mode switch to PGM1 or PGM2 depending on the item you are going to program.

Basic Instructions

This section illustrates the basic programming by using an example of programming for departments.

Procedure

PGM2	↓
01 READING	
02 SETTING	
03 AUTO KEY	
04 D-UPC LOAD	
05 DATA CLEAR	
06 OPEN STORE	

[ENTER] ↓ ↑ [CANCEL]

SETTING	↓
01 ARTICLE	
02 DIRECT KEY	
03 PLU MENU KEY	
04 FUNCTION	
05 MEDIA	
06 TEXT	

[ENTER] ↓ ↑ [CANCEL]

ARTICLE	↓
01 DEPARTMENT	
02 PLU/UPC	
03 DYNAMIC UPC	
04 PLU RANGE	
05 PLU STOCK	
06 LINK PLU TABLE	

[ENTER] ↓ ↑ [CANCEL]

Programming example

The following example shows how to program \$2.00 for the unit price, "ABCDE" for the description, and the scale entry to be enabled for department 1.

- In the PGM2 window, select "02 SETTING" by using the or key and press the key.
 - The SETTING window will appear.

NOTE

- You can also select "02 SETTING" by pressing the and .
- If you return to the previous screen, press the key.

- Select "01 ARTICLE."
 - The ARTICLE window will appear.

NOTE

The arrow mark in the upper-right corner of the window shows that the window contains more options than are now on the screen. To scroll the window, press the key. To return to the previous page, press the key.

- Select "01 DEPARTMENT."
 - The DEPARTMENT window will appear, listing programmable departments.

DEPARTMENT	↓
01 DPT.01	
02 DPT.02	
03 DPT.03	
04 DPT.04	
05 DPT.05	
06 DPT.06	

(ENTER) ↓ ↑ (CANCEL)

01	↓
PRICE	200_
SIGN	+
DPT.01	
ITEM UP	NON-COMPUL.
TARE NO.	0
SCALE	INHIBIT

↓ ↑

01	↓
PRICE	2.00
SIGN	+
DPT.01	
ITEM UP	NON-COMPUL.
TARE NO.	0
SCALE	INHIBIT
	a

↓ ↑

01	↓
PRICE	2.00
SIGN	+
ABCDE	
ITEM UP	NON-COMPUL.
TARE NO.	0
SCALE	ENABLE

- Select "01" to program for department 1.
 - The "01" window will appear.

- On the first page of the "01" window, program the unit price and description as follows:

NOTE

There are three entry patterns for the programming: the numeric entry, character entry, and selective entry.

- Move the cursor to "PRICE," enter "200" by using numeric keys, then press the (ENTER) key. → **Numeric entry**
- Move the cursor to "DPT.01," enter "ABCDE" by using character keys, then press the (ENTER) key. → **Character entry**

If you want to clear the setting, press the (CL) key before you press the (ENTER) key.

- On the first page of the "01" window, program the machine to enable the scale entry as follows:

- Move the cursor to "SCALE," press the (◦) key until "ENABLE" appears, then press the (ENTER) key. → **Selective entry**

NOTE

The (◦) key toggles between three options as follows:
 INHIBIT → ENABLE → COMPUL. → INHIBIT → ...
 Pressing the (SBTL) key displays all available options.

- Select one of the following actions:

- To cancel the programming, press the (CANCEL) key. Select "YES" in the "ARE YOU SURE ?" window.
- To finalize the programming, press the (CA/AT) key, then press the (CANCEL) key. You will return to the "DEPARTMENT" window.
- To program for the following department, press the (NEXT RECORD) key. The "02" window will appear. To return to the "01" window, press the (PREV RECORD) key.

The following sections describe how to program each item which is contained in a programming group.

Article Programming

Use the following procedure to select any option included in the article programming group.

Procedure

SETTING
01 ARTICLE
02 DIRECT KEY
03 PLU MENU KEY
04 FUNCTION
05 MEDIA
06 TEXT

(ENTER) ↓ ↑ (CANCEL)

ARTICLE
01 DEPARTMENT
02 PLU/UPC
03 DYNAMIC UPC
04 PLU RANGE
05 PLU STOCK
06 LINK PLU TABLE

(PAGE DOWN) ↓ ↑ (PAGE UP)

ARTICLE
07 CONDIMENT TBL.
08 MIX&MATCH
09 COMBO MEAL
10 SCALE TABLE
11 UPC NON-PLU
12 UPC DELETE

1. In the SETTING window, select “01 ARTICLE.”

- The ARTICLE window will appear.

2. Select any option from the following options list:

1 DEPARTMENT:	Departments
2 PLU/UPC:	PLUs/UPCs
3 DYNAMIC UPC:	Dynamic UPC
4 PLU RANGE:	A range of PLUs
5 PLU STOCK:	PLU/UPC stock quantity
6 LINK PLU TABLE:	Link PLU table
7 CONDIMENT TBL.:	Condiment table
8 MIX&MATCH:	Mix & match table
9 COMBO MEAL:	Combo meal table
10 SCALE TABLE:	Scale table
11 UPC NON-PLU:	UPC non-PLU type code format
12 UPC DELETE:	UPC record delete period

The following illustration shows those options included in the article programming group.

1 ARTICLE	— 1 DEPARTMENT
	— 2 PLU/UPC
	— 3 DYNAMIC UPC
	— 4 PLU RANGE
	— 5 PLU STOCK
	— 6 LINK PLU TABLE
	— 7 CONDIMENT TBL.
	— 8 MIX&MATCH
	— 9 COMBO MEAL
	— 10 SCALE TABLE
	— 11 UPC NON-PLU
	— 12 UPC DELETE

- ➔ See “Department” on page 97.
- ➔ See “PLU/UPC” on page 99.
- ➔ See “Dynamic UPC” on page 102.
- ➔ See “PLU range” on page 102.
- ➔ See “PLU/UPC stock” on page 103.
- ➔ See “Link PLU table” on page 104.
- ➔ See “Condiment table” on page 105.
- ➔ See “Mix & Match table” on page 106.
- ➔ See “Combo meal table” on page 107.
- ➔ See “Scale table” on page 108.
- ➔ See “UPC Non-PLU code format” on page 109.
- ➔ See “UPC delete” on page 110.

■ Department

Your machine is equipped with 10 standard departments, and can be equipped with a maximum of 99 departments.

Use the following procedure to program for departments.

Procedure

Select the desired dept. code from the departments list.

↓

01	↓
PRICE	0.00
SIGN	+
DPT. 01	
ITEM VP NON-COMPUL.	
TARE NO.	0
SCALE	INHIBIT

↓

01	↑↓
SIF/SICS	NORMAL
DEPT. TYPE	NORMAL
ENTRY TYPE	OPEN
TAXABLE 1	NO
TAXABLE 2	NO
TAXABLE 3	NO

The screen continues.

Program each item as follows:

NOTE

For more information about the entry patterns, see the "Basic Instructions" section.

- **PRICE (Use the numeric entry)**

Unit price (max. 6 digits)

NOTE

When the zero-value department entry (unit price "0") is made, a text of the department is only displayed/printed.

- **SIGN (Use the selective entry)**

+: Assigns a plus sign to departments for normal sales transactions.

-: Assigns a minus sign for minus transactions.

- **DPT.01<Default for dept.1> (Use the character entry)**

Description for a department. Up to 8 or 16 characters can be entered.

- **ITEM VP (Use the selective entry)**

COMPUL.: Makes item validation printing compulsory.

NON-COMPUL.: Makes item validation printing non-compulsory.

- **TARE NO. (Use the numeric entry)**

Tare table number associated with scale entry (1 thru 9).

- **SCALE (Use the selective entry)**

INHIBIT: Inhibits a scale entry.

COMPULSORY: Makes a scale entry compulsory.

ENABLE: Enables a scale entry.

- **SIF/SICS (Use the selective entry)**

Department type selection

SIF: SIF department

SICS: SICS department

NORMAL: Department other than SIF or SICS department

- **DEPT. TYPE (Use the selective entry)**

Department type selection

GAS: Gas department

BR: Bottle return department

HASH: Hash department

NORMAL: Normal department

- A hash department is used to enter the amount of a special "sale," such as a gift certificate, etc. Any amounts entered in this department are not added to the grand total exclusive of tax amounts.

- **ENTRY TYPE (Use the selective entry)**

Type of unit price entry for departments

OPEN & PRES.: Open & preset

PRESET: Preset only

OPEN: Open only

INHIBIT: Inhibited

■ Department (continued)

• TAXABLE 1 thru 4 (Use the selective entry)

Tax status

NO : Non-taxable

YES : Taxable

- When an entry of a taxable department is made in a transaction, tax is automatically computed according to the associated tax table or rate.

• FOOD STAMP (Use the selective entry)

Food stamp status

NO : Food stamp ineligible

YES : Food stamp eligible

• GR. DISC. 1 thru 3 (Use the selective entry)

Group discount status

NO : Non-discountable

YES : Discountable

• HALO (Use the numeric entry)

- You can set an upper limit amount (HALO) for each department. The limit is effective for the REG-mode operations and can be overridden in the MGR mode.

- AB is the same as $A \times 10^B$

A: Significant digit for HALO (1 thru 9)

B: Number of zeros to follow the significant digit for HALO (0 thru 7)

• LALO (Use the numeric entry)

- You can set a lower limit amount (LALO). The limit is effective for the REG-mode operations and can be overridden in the MGR mode.

- AB is the same as $A \times 10^B$

A: Significant digit for LALO (1 thru 9)

B: Number of zeros to follow the significant digit for LALO (0 thru 7)

• AGE LIMIT. (Use the numeric entry)

Age limitation (0 thru 99)

When a department for which a figure other than zero (01 to 99) has been programmed as the age limitation is entered, the birthday entry must be completed.

• SERVER Gr. No. (Use the numeric entry)

Server group number (0 thru 9)

Every department can be assigned to any of the server department groups. The sales total of each department group is printed on the server report.

• GROUP No. (Use the numeric entry)

Group number (0 thru 9)

You can assign departments to a maximum of nine groups. This programming enables you to take group sales reports.

• MODIFIED OUTPUT (Use the selective entry)

NO : Disables output to network remote printers.

YES : Enables output to network remote printers. Modified to follow a previous item.

• OUTPUT KP No. 1 thru 3 (Use the numeric entry)

ID number of the network remote printer 1, 2 or 3 (1 thru 9)

If the number "0" is entered, no remote printer will operate.

• CHIT RECEIPT (Use the selective entry)

YES : Prints the department sales information on the chit receipt in the remote printer format.

NO : Prints nothing on the chit receipt.

• CVM CTRL CHAR. (Use the numeric entry)

CVM (Color Video Monitor) control character (0 thru 255)

- This programming enables you to assign each department with a number that can be used as a CVM control character. This number is converted to a two-digit character code that is transmitted for use with a CVM device.

• DATA ENT. JOB# (Use the numeric entry)

Key data entry job number (Capture job number: 0 thru 99)

When "0" is programmed, data entry is inhibited.

■ PLU/UPC

NOTE

- In this manual, the word “UPC” represents UPC (Universal Product Code) and the word “EAN” represents EAN (European Article Number).
- With regard to the UPC codes available to this POS terminal, please refer to the chapter 14.

Procedure

Select the desired PLU code from the PLUs list, or directly enter a PLU/UPC code.

```

00001 ↓
PRICE 1 0.00
1# PLO0001
KP1 PLO0001
DEPT.CODE 01
SIGN +
ENTRY TYPE PRESET
    
```

```

00001 ↑↓
BASE Q'TY 0
MIN. STOCK 0
PRICE SHIFT ENABLE
ZERO OF P1 ALLOWED
CP OBJECT 00000
MENU TYPE NORMAL
    
```

```

00001 ↑↓
LINK TBL# 00
MIX&MATCH TBL# 00
CONDIMENT TBL# 00
TARE TBL# 0
CONDIMENT TYPE NO
CONDIMEN NON-COMPUL.
    
```

Program each item as follows:

- ***PRICE 1 thru 6 (Use the numeric entry)**
Unit price of each price level (max. 6 digits).
- ***1# thru 6 (Use the character entry)**
Description for a PLU/UPC (for each price level). Up to 8 or 16 characters can be entered.
- ***KP 1 thru 6 (Use the character entry)**
Description of text for kitchen printer for each price level. Up to 12 characters can be entered.
- **DEPT.CODE (Use the numeric entry)**
Department code to be associated with the entered PLU/UPC (01 through 99)
When a PLU/UPC is associated with a department, the following functions of the PLU/UPC depend on the programming for the department.
 - Item validation print compulsory/non-compulsory
 - Single item cash sale/single item finalize
- **SIGN (Use the selective entry)**
 - + : Plus PLU/UPC
 - : Minus PLU/UPC
 The function of every PLU/UPC varies according to the combination of its sign and the sign of its associated department as follows:

Department:	+	} Serves as a normal plus PLU/UPC
PLU/UPC:	+	
Department:	-	} Serves as a normal minus PLU/UPC
PLU/UPC:	-	
Department:	+	} Accepts store coupon entries, but not split-pricing entries.
PLU/UPC:	-	
Department:	-	} Not valid; not accepted
PLU/UPC:	+	

NOTE

* On the sample screen, the price level 1 setting only is shown. Depending on the default settings, you may see the price level 1 through 6 settings on the screen. Please consult your authorized SHARP dealer for more details.

■ PLU/UPC (continued)



00001	↑↓
SCALE	INHIBIT
TAXABLE 1	NO
TAXABLE 2	NO
TAXABLE 3	NO
TAXABLE 4	NO
FOOD STAMP	NO



00001	↑↓
GR.DISC.1	NO
GR.DISC.2	NO
GR.DISC.3	NO
AGE LIMIT.	00
GROUP1	00
GROUP2	00



00001	↑↓
GROUP3	00
PRIORITY GR.	0
MODIFY OUTPUT	NO
OUTPUT KP No.1	0
OUTPUT KP No.2	0
OUTPUT KP No.3	0



00001	↑
OUTPUT KP No.3	0
CHIT RECEIPT	NO
CUM CTRL CHAR.	000
REPEAT ROUND	NO
DATA ENT.JOB#	00
NON-ACCESS NON DEL.	

- **ENTRY TYPE (Use the selective entry)**

Mode parameter

OPEN & PRESET: Open price and preset price

PRESET: Preset price only

OPEN: Open price only

INHIBIT: Inhibited

NOTE For UPC, it is fixed to "PRESET".

- **BASE Q'TY (Use the numeric entry)**

Base quantity for each PLU/UPC which is counted each time the item is entered. (max. 2 digits)

- **MIN. STOCK (Use the numeric entry)**

Minimum stock quantity for a PLU (max. 7 digits)

- **PRICE SHIFT (Use the selective entry)**

COMPUL.: Makes PLU/UPC price level shift compulsory.

INHIBIT: Inhibits PLU/UPC price level shift.

ENABLE: Enables PLU/UPC price level shift.

NOTE

When "COMPULSORY" is selected for a PLU/UPC, repeat entries of the PLU/UPC are inhibited.

- ***ZERO OF P1 thru 6 (Use the selective entry)**

ALLOWED: Allows a zero-price entry.

INHIBIT: Inhibits a zero-price entry.

- **CP OBJECT (Use the numeric entry)**

Select an object PLU code (max. 5 digits).

A coupon-like PLU is able to link to another PLU (object PLU).

By this programming, the associated coupon PLU cannot be entered unless the object PLU has been rung up.

(However, the quantity is not affected.)

NOTE

• Any object PLU should not be programmed as a minus PLU or belong to any minus department.

- **MENU TYPE (Use the selective entry)**

PLU menu type selection

LINK: Link PLU/UPC

NORMAL: Normal PLU/UPC

- **LINK TBL# (Use the numeric entry)**

Table number for link PLUs (1 thru 99)

- **MIX&MATCH TBL# (Use the numeric entry)**

Table number for mix and match (1 thru 99)

- **CONDIMENT TBL# (Use the numeric entry)**

Table number for condiment entry (1 thru 99)

NOTE For UPC, it is fixed to "00".

■ PLU/UPC (continued)

- **TARE TBL# (Use the numeric entry)**

Tare table number associated with scale entry (1 thru 9)

- **CONDIMENT TYPE (Use the selective entry)**

YES : Condiment type

NO : Non-condiment type

NOTE For UPC, it is fixed to "NO".

- **CONDIMENT (Use the selective entry)**

COMPUL.: Makes a condiment entry compulsory.

NON-COMPUL.: Makes a condiment entry non-compulsory.

NOTE For UPC, it is fixed to "NON-COMPUL.".

- **SCALE (Use the selective entry)**

COMPUL.: Makes a scale entry compulsory.

ENABLE: Enables a scale entry.

INHIBIT: Inhibits a scale entry.

- **TAXABLE 1 thru 4 (Use the selective entry)**

YES : Makes the PLU/UPC taxable.

NO : Makes the PLU/UPC non-taxable.

- **FOOD STAMP (Use the selective entry)**

Food stamp status

NO : Food stamp ineligible

YES : Food stamp eligible

- **GR. DISC. 1 thru 3 (Use the selective entry)**

Group discount status

NO : Non-discountable

YES : Discountable

- **AGE LIMIT. (Use the numeric entry)**

Age limitation (0 thru 99)

When a PLU/UPC for which a figure other than zero (01 to 99) has been programmed as the age limitation, the birthday entry must be completed.

- **GROUP 1 thru 3 (Use the numeric entry)**

PLU group number (00 thru 99)

- **PRIORITY GR. (Use the numeric entry)**

PLU group which is to be given the highest priority to in printing on the remote printer (1 thru 9)

- **MODIFY OUTPUT (Use the selective entry)**

NO : Will not follow previous PLUs which has the remote printer assignment.

YES : Will follow previous PLUs which has the remote printer assignment.

- **OUTPUT KP No.1 thru 3 (Use the numeric entry)**

ID number of the network remote printer 1, 2 or 3 (1 thru 9)

If the number "0" is entered, no remote printer will operate.

- **CHIT RECEIPT (Use the selective entry)**

YES : Prints the PLU sales information on the chit receipt in the remote printer format.

NO : Prints nothing on the chit receipt.

- **CVM CTRL CHAR. (Use the numeric entry)**

CVM (Color Video Monitor) control character (0 thru 255)

■ PLU/UPC (continued)

- **REPEAT ROUND (Use the selective entry)**
 YES : Allows repeat round registration
 NO : Inhibits repeat round registration
- **DATA ENT. JOB# (Use the numeric entry)**
 Key data entry job number (Capture job number: 0 thru 99)
 When "0" is programmed, data entry is inhibited.
- **NON-ACCESS (Use the selective entry)**
 NON DEL.: Not delete non-accessed UPCs by Z1 report.
 DEL. BY Z: Delete non-accessed UPCs by Z1 report.

NOTE For PLU, it is fixed to "NON DEL."

■ Dynamic UPC

NOTE For the UPC codes available to this POS terminal and type UPC files, please refer to the chapter 14.

After you select "3 DYNAMIC UPC" on the "ARTICLE" menu, enter an UPC code or select a pertinent code. The same setting items excepting MIN. STOCK as the "PLU/UPC" described in the previous section will appear. Please refer to "PLU/UPC" section for entering values or selecting options. The data will be saved in the Dynamic UPC file.

■ PLU range

You can program the PLUs by a range as follows:

Procedure

PLU RANGE	
START	00000
END	00000
OPERATION	MAINT.



00001-00020 ↓	
PRICE 1	0.00
1#	
KP1	
DEPT.CODE	
SIGN	
ENTRY TYPE	

The screen continues in the same format as screens shown in section "■ PLU/UPC."

Enter a value or select an option for each item as follows:

- **START (Use the numeric entry)**
 Starting PLU code (max. 5 digits)
- **END (Use the numeric entry)**
 Ending PLU code (max. 5 digits)
- **OPERATION (Use the selective entry)**
 MAINT.: Enables you to change the setting you have programmed.
 NEW&MAINT.: Enables you to change the current setting when the specified codes have already been created or to create new codes when the specified codes have not been created yet.
 DELETE: Enables you to delete a specified range of PLUs.

■ PLU/UPC stock

You can assign a stock quantity to each PLU/UPC code.
Shown below is an example of selecting “1 OVER WRITE.”

Procedure

PLU STOCK	
1	OVER WRITE
2	ADD
3	SUB



Select the desired PLU code from the PLUs list, or directly enter a PLU/UPC code.



00001	
CURRENT	0
NEW STOCK	0

After selecting “1 OVER WRITE,” select a pertinent PLU/UPC code. Then the next screen will appear to show the following items:

- **CURRENT**

The current stock is displayed.

- **NEW STOCK (Use the numeric entry)**

Enter a new stock quantity (max. 7 digits: 1 to 9999.999)

NOTE

- If you need to add or subtract a stock quantity to or from the current stock quantity, select “2 ADD” or “3 SUB” and enter a value to be added or subtracted.
- You cannot enter any values for the item marked with “!”
- The entry of a new stock value will update to the PLU/UPC stock counter.

Selected
condiment table
number → (ENTER)

01		↓
REPEAT TIMES		1
NEXT TABLE#	00	
PLU#01	00000	
PLU#02	00000	
PLU#03	00000	
PLU#04	00000	

The screen continues.

■ Mix & Match table

Procedure

MIX&MATCH	
---NOTHING---	

Selected
mix & match
table number → (ENTER)

01		
BASE QTY		0
PRICE	0.00	

- **PLU#1-15 (Use the numeric key)**

Select condiment PLUs contained in the table (max. 15 PLUs) from the list.

NOTE

- The description of the first PLU is used as the display prompt.
- PLU codes should be defined before programming a condiment table.
- If the (DEL) key is pressed on the table number selection menu, the table in the cursor position will be deleted.

Program each item as follows:

- **MIX&MATCH (Use the numeric entry)**

Mix & match table number (1 thru 99)

- **BASE QTY (Use the numeric entry)**

Base quantity for each mix & match table (max. 2 digits)

- **PRICE (Use the numeric entry)**

Unit price for each mix & match table (max. 7 digits)

NOTE

- If the (DEL) key is pressed on the table number selection menu, the table in the cursor position will be deleted.

■ Combo meal table

When two or more menu items, consisting of PLUs related to a special offering, are to be programmed together, the combo meal function should be specified. Up to 20 combo keys (tables) can be programmed. And each combo key can be associated with 9 PLUs (items).

Procedure

COMBO MEAL
---NOTHING---

Selected combo table no. →

ENTER

01	↓
KP	
CONDIMENT TBL#	00
CONDIMEN NON-COMPUL.	
PRIORITY GR.	0
MODIFY OUTPUT	NO
	a

01	↑↓
OUTPUT KP No.1	0
OUTPUT KP No.2	0
OUTPUT KP No.3	0
CHIT RECEIPT	NO
CVM CTRL CHAR.	000
DATA ENT.JOB#	00

Program each item as follows

- **COMBO MEAL (Use the numeric entry)**
Combo meal table number (1 thru 20)
- **Combo title (Use the character entry)**
Title of each combo meal table (max. 16 characters).
- **KP (Use the character entry)**
Description of the kitchen printer for a combo key.
Up to 12 characters can be entered.
- **CONDIMENT TBL# (Use the numeric entry)**
Table number for condiment entry (1 thru 99)
- **CONDIMENT (Use the selective entry)**
COMPUL.: Makes a condiment entry compulsory.
NON-COMPUL.: Makes a condiment entry non-compulsory.
- **PRIORITY GR. (Use the numeric entry)**
Combo group which is to be given the highest priority to in printing on the remote printer (1 thru 9).
- **MODIFY OUTPUT (Use the selective entry)**
NO : Will not follow previous PLUs which has the remote printer assignment.
YES : Will follow previous PLUs which has the remote printer assignment.
- **OUTPUT KP No.1 thru 3 (Use the numeric entry)**
ID number of the network remote printer 1, 2 or 3 (1 thru 9).
If the number "0" is entered, no remote printer will operate.
- **CHIT RECEIPT (Use the selective entry)**
YES : Print the combo sales information on the chit receipt in the remote printer format.
NO : Print nothing on the chit receipt.
- **CVM CTRL CHAR. (Use the numeric entry)**
CVM (Color Video Monitor) control character (0 thru 255)
- **DATA ENT. JOB# (Use the numeric entry)**
Key data entry job number (Capture job number: 0 thru 99)
When "0" is programmed, the data capture entry is inhibited.

■ Combo meal table (continued)

↓

01	↑↓
COMBO PLU#1	00000
PRICE1	0.00
PRICE2	0.00
COMBO PLU#2	00000
PRICE1	0.00
PRICE2	0.00

The screen continues.

- **COMBO PLU#1-9 (Use the numeric entry)**
Select associated PLUs (max. 9 PLUs) from the list.
- **PRICE1 (Use the numeric entry)**
Unit price of each associated PLU (max. 6 digits).
- **PRICE2 (Use the numeric entry)**
2nd unit price (for Upcharge function) of each associated PLU (max. 6 digits).

NOTE

- *The PRICE1 is selected by the combo meal entry. When the UPSIZE key is pressed after the combo meal entry, the entry of PRICE1 is voided and a new entry of PRICE2 is registered.*
- *PLU codes should be defined before programming a combo meal table.*
- *If the DEL key is pressed on the table number selection menu, the programmed data in the cursor position will be deleted.*

■ Scale table

The POS terminal can be programmed with up to nine tare tables and allows different tares to be assigned to scalable items (for auto scale entries).

Procedure

SCALE TABLE	↓
1	
2	
3	
4	
5	
6	

↓

Selected tare table number → ENTER

↓

1	
WEIGHT	0.001b

Program each item as follows:

- **SCALE TABLE (Use the numeric entry)**
Tare table number (1 thru 9)
- **WEIGHT (Use the numeric entry)**
Enter a tare weight for the scale table number (max. 4 digits: 1 to 99.99 lbs.).

NOTE

Your POS terminal may also be set to accommodate 1-integer + 3-decimal weights. For more details, please consult your authorized SHARP dealer.

■ UPC Non-PLU code format

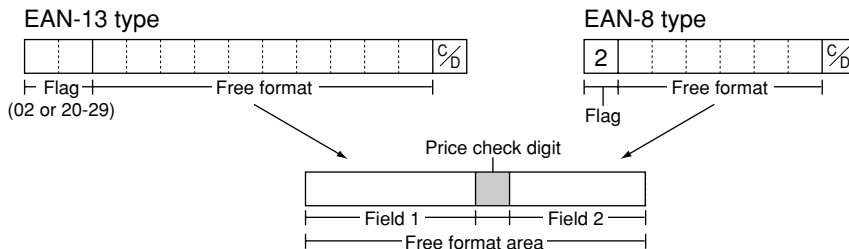

Procedure

Select an arbitrary number, or the desired UPC TYPE OF CODE & SYSTEM CODE you set.

03	↓
TYPE OF CODE	EAN13
SYSTEM CODE	00
LENGTH FLD#1	0
LENGTH FLD#2	0
FIELD#2 DATA	PRICE
PRICE C/D	NO

The screen continues.

Program each item as follows:

- **TYPE OF CODE (Use the selective entry)**

EAN-8: EAN-8 format code (consists of 8 digits)
 EAN-13 (UPC-A): EAN-13 format code (consists of 13 digits)

- **SYSTEM CODE (Use the numeric entry)**

System code (i.e. flag code): EAN-8: 1 digit, EAN-13: 2 digits

NOTE

ISBN/ISSN and press codes are always used the fixed format even if code, 37, 43, 78, 98, or 97 is entered.

- **LENGTH FLD#1 (Use the numeric entry)**

Length of field 1 (number of digits): 0 to 9

- **LENGTH FLD#2 (Use the numeric entry)**

Length of field 2 (number of digits): 0 to 9

- **FIELD#2 DATA (Use the selective entry)**

Meaning of field 2
 QUANTITY: Quantity
 PRICE: Price

- **PRICE C/D (Use the selective entry)**

Price check digit
 YES: Use the price check digit
 NO: Not use the price check digit

- **TAB (Use the selective entry)**

TAB or decimal point of field: 3/2/1/0

Direct Key Programming

Use the following procedure to select direct-key programming:

■ Direct PLU/COMBO/Dept. key

You can assign PLUs, combo meals and departments directly to the keyboard. In the case of combo meals or PLUs, you may assign up to 10-levels to be accessed directly on the keyboard.

Procedure

SETTING	↓
01 ARTICLE	
02 DIRECT KEY	
03 PLU MENU KEY	
04 FUNCTION	
05 MEDIA	
06 TEXT	



Select the desired key no. from the key numbers list (Refer to the next page).



001	
TYPE	PLU



001	
LEVEL1	00001
LEVEL2	00000
LEVEL3	00000
LEVEL4	00000
LEVEL5	00000

In the case of setting "00001 DIRECT PLU"

1. In the SETTING window, select "02 DIRECT KEY."
 - The DIRECT KEY window will appear.

• TYPE (Use the selective entry)

- PLU: Assigns the key as a direct PLU key.
- COMBO: Assigns the key as a direct combo key.
- DEPT: Assigns the key as a direct department key.

NOTE

- You can also select a direct PLU key by pressing the corresponding key when the PLU has been assigned directly on the keyboard instead of selecting the key from the menu.
- When selecting a department, the screen on which a department code is to be entered (the message "DEPT. CODE") will appear.
- When selecting a combo, the screen on which a combo table number is to be entered ("COMBO TBL#") will appear.

• LEVEL1 thru 5 (Use the numeric entry)

- Enter a PLU number or combo table number for each level. For example, if you want to use this key as PLU code 1 (level 1) and PLU code 101 (level 2), enter 1 for the "LEVEL1" and 101 for the "LEVEL2."

Key numbers

↑ RECEIPT	↑ JOURNAL	25	34	43	52	61	70	79	88	97	106	115	124	133	142
8	16	24	33	42	51	60	69	78	87	96	105	114	123	132	141
7	15	23	32	41	50	59	68	77	86	95	104	113	122	131	140
6	14	22	31	40	49	58	67	76	85	94	103	112	121	130	139
5	13	21	30	39	48	57	66	75	84	93	102	111	120	129	138
4	12	20	29	38	47	56	65	74	83	92	101	110	119	128	137
3	11	19	28	37	46	55	64	73	82	91	100	109	118	127	136
2	10	18	27	36	45	54	63	72	81	90	99	108	117	126	135
1	9	17	26	35	44	53	62	71	80	89	98	107	116	125	134

Default keyboard: Departments, PLUs and combo meals programmable area

NOTE

You cannot place a department, PLU or combo meal key where a function key has been previously programmed.

For more information, please consult your authorized SHARP dealer.

PLU Menu Key Programming

Use the following procedure to select the PLU menu key programming:

■ PLU menu key

When you enter PLUs, using the PLU menu key makes it easy to find categorized PLU items from the menu list.

Your POS terminal allows you to program a max. of 50 PLU menu keys. You can program a max. of 15 PLUs/sub-menus for each PLU menu key.

Procedure

SETTING
01 ARTICLE
02 DIRECT KEY
03 PLU MENU KEY
04 FUNCTION
05 MEDIA

PLU MENU KEY
---NOTHING---

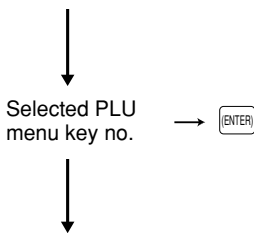

01
TEX

01
TYPE
PLU

01
PLU
00000

Use the following procedure to program a PLU menu key:

In the SETTING window, select "03 PLU MENU KEY" and program each item as follows:

- **PLU MENU KEY (Use the numeric entry)**
 PLU menu key number (1 thru 50)
 1 thru 50 : For the direct PLU menu key.
- **TEXT (Use the character entry)**
 Description for the PLU menu key. Up to 16 characters can be entered.
- **TYPE (Use the selective entry)**
 PLU: Selects to program a PLU.
 MENU: Selects to program a sub-menu.
- **PLU or MENU (Use the numeric entry)**
 Select a menu PLU or sub-menu from the list.

NOTE

When selecting a sub-menu, the screen on which a sub-menu number is to be entered (the message "MENU") will appear.

NOTE

- The PLU code should be defined before programming a PLU menu key.
- If the key is pressed on the menu key number selection menu, the menu list will be canceled.
- If the key is pressed on the menu PLU code selection menu, the menu in the cursor position will be deleted.

Functional Programming

Use the following procedure to select any option included in the functional programming group:

Procedure

SETTING ↓
01 ARTICLE
02 DIRECT KEY
03 PLU MENU KEY
04 FUNCTION
05 MEDIA
06 TEXT



FUNCTION ↓
01 (-)
02 %
03 GROUP DISC.%
04 GAS DISCOUNT
05 GRATUITY
06 TIP

The screen continues.

1. In the SETTING window, select “04 FUNCTION.”

- The FUNCTION window will appear.

2. Select any option from the following options list:

1 (-):	Discount key
2 %:	Percent key
3 GROUP DISC.%:	Group discount
4 GAS DISCOUNT:	Gas discount
5 GRATUITY:	Gratuity
6 TIP:	Tip
7 RA:	Received on account
8 PO:	Paid out
9 MANUAL TAX:	Manual tax
10 TAX DELETE:	Tax delete
11 NO SALE:	No-sale
12 VOID:	Void
13 REFUND:	Refund

The following illustration shows those options included in the functional programming group.

4 FUNCTION	1 (-)	➔ See “Discount key” on page 115 .
	2 %	➔ See “Percent key” on page 116 .
	3 GROUP DISC.%	➔ See “Group discount” on page 117 .
	4 GAS DISCOUNT	➔ See “Gas discount” on page 118 .
	5 GRATUITY	➔ See “Gratuity” on page 119 .
	6 TIP	➔ See “Tip” on page 119 .
	7 RA	➔ See “RA” on page 120 .
	8 PO	➔ See “PO” on page 121 .
	9 MANUAL TAX	➔ See “Manual tax” on page 121 .
	10 TAX DELETE	➔ See “Tax delete” on page 122 .
	11 NO SALE	➔ See “No sale” on page 122 .
	12 VOID	➔ See “Void” on page 123 .
	13 REFUND	➔ See “Refund” on page 123 .

■ Discount key (⊖1 thru ⊖5)

Procedure

Select the desired discount key from the discount keys list.

(-) 1	↓
AMOUNT	-0.00
TEXT	(-) 1
SIGN	-
TAXABLE1	NO
TAXABLE2	NO
TAXABLE3	NO

(-) 1	↑↓
TAXABLE4	NO
FOOD STAMP	NO
GR.DISC.1	NO
GR.DISC.2	NO
GR.DISC.3	NO
HALO	17

The screen continues.

Program each item as follows:

- **AMOUNT (Use the numeric entry)**
Discount amount (max. 6 digits: 0 to 999999)
- **TEXT (Use the character entry)**
Description for the discount key. Up to 8 characters can be entered.
- **SIGN (Use the selective entry)**
Programming of the + or – sign assigns the premium or discount function to each discount key.
–: Minus amount (discount)
+: Plus amount (premium)
- **TAXABLE1 thru 4 (Use the selective entry)**
YES: Taxable
NO: Non-taxable
- **FOOD STAMP (Use the selective entry)**
Food stamp status
NO: Food stamp ineligible
YES: Food stamp eligible
- **GR. DISC. 1 thru 3 (Use the selective entry)**
Group discount status
NO: Non-discountable
YES: Discountable
- **HALO (High Amount Lockout: use the numeric entry)**
A: Significant digit for HALO (1 thru 9)
B: Number of zeros to follow the significant digit for HALO (0 thru 7)
AB is the same as $A \times 10^B$.
- **ENTRY TYPE (Use the selective entry)**
ITEM: Item (–)
SBTL: Subtotal (–)
- **ENTRY IN REG (Use the selective entry)**
YES: Allows a discount entry in the REG mode.
NO: Inhibits a discount entry in the REG mode.
- **DATA ENT. JOB# (Use the numeric entry)**
Key data entry job number (Capture job number: 0 thru 99)
When “0” is programmed, data capture is inhibited.
- **PLU1 thru 20 (Use the numeric entry)**
Program the PLU code which is allowed for the corresponding (–) key. (1 thru 99999)

NOTE

For the Markdown coupon entry (item (–)):

The coupon entry will be allowed only for a PLU which is listed in this table.

For the Discount coupon entry (ST (–)):

The coupon entry will be allowed only when all PLUs which is listed in this table have been entered.

NOTE

You can also select a discount key by pressing the corresponding key when it has been placed directly on the keyboard instead of selecting the key from the menu.

■ Percent key (%1 thru %5)

Procedure

Select the desired percent key from the percent keys list.

1	↓
RATE	-0.00%
TEXT	1
SIGN	-
TAXABLE1	NO
TAXABLE2	NO
TAXABLE3	NO

1	↑↓
TAXABLE4	NO
FOOD STAMP	NO
GR.DISC.1	NO
GR.DISC.2	NO
GR.DISC.3	NO
%HALO	100.00%

The screen continues.

Program each item as follows:

- **RATE (Use the numeric entry)**
Percent rate (0.00 to 100.00)
- **TEXT (Use the character entry)**
Description for the percent key. Up to 8 characters can be entered.
- **SIGN (Use the selective entry)**
Programming of the + or – sign assigns the premium or discount function to each percent key.
–: Minus (discount)
+: Plus (premium)
- **TAXABLE1 thru 4 (Use the selective entry)**
YES: Taxable
NO: Non-taxable
- **FOOD STAMP (Use the selective entry)**
Food stamp status
NO: Food stamp ineligible
YES: Food stamp eligible
- **GR. DISC. 1 thru 3 (Use the selective entry)**
Group discount status
NO: Non-discountable
YES: Discountable
- **%HALO (High Amount Lockout: use the numeric entry)**
HALO (High Amount Lockout) for the percent key (0.00 to 100.00)
- **ENTRY TYPE (Use the selective entry)**
ITEM: Item %
SBTL: Subtotal %
- **DATA ENT. JOB# (Use the numeric entry)**
Key data entry job number (Capture job number: 0 thru 99)
When “0” is programmed, data entry is inhibited.
- **PLU1 thru 20 (Use the numeric entry)**
Program PLU code which is allowed for the corresponding % key. (1 thru 99999)

NOTE

*For the Markdown % entry (item %):
The % entry will be allowed only for a PLU which is listed in this table.*

*For the Discount % entry (ST %):
The % entry will be allowed only when all PLUs which is listed in this table have been entered.*

NOTE

You can also select a percent key by pressing the corresponding key when it has been placed directly on the keyboard instead of selecting the key from the menu.

■ Group discount key (GDSC %1 thru GDSC %3)

Procedure

Select the desired key from the group discount keys list.

GDISC%1	↓
RATE	-0.00%
TEXT(%)	GDISC%1
TEXT(ST)	GD1 ST
SIGN	-
TAXABLE1	NO
TAXABLE2	NO

GDISC%1	↑
TAXABLE2	NO
TAXABLE3	NO
TAXABLE4	NO
FOOD STAMP	NO
%HALO	100.00%
DATA ENT .JOB#	00

Program each item as follows:

- **RATE (Use the numeric entry)**
Percent rate (0.00 to 100.00)
- **TEXT (%) (Use the character entry)**
Description for the group discount key. Up to 8 characters can be entered.
- **TEXT (ST) (Use the character entry)**
Description for the group subtotal. Up to 8 characters can be entered.
- **SIGN (Use the selective entry)**
Programming of the + or – sign assigns the premium or discount function to each group discount key.
–: Minus (discount)
+: Plus (premium)
- **TAXABLE1 thru 4 (Use the selective entry)**
YES: Taxable
NO: Non-taxable
- **FOOD STAMP (Use the selective entry)**
Food stamp status
NO: Food stamp ineligible
YES: Food stamp eligible
- **%HALO (High Amount Lockout: use the numeric entry)**
HALO (High Amount Lockout) for the group discount key (0.00 to 100.00)
- **DATA ENT. JOB# (Use the numeric entry)**
Key data entry job number (Capture job no.: 0 thru 99)
When “0” is programmed, data entry is inhibited.

NOTE

You can also select a group discount key by pressing the corresponding key when it has been placed directly on the keyboard instead of selecting the key from the menu.

■ Gas discount

Procedure

Select the desired Gas discount (1 thru 19) from the list.

GAS(-)1	
PRICE(Cent)	0.0
TEXT	GAS(-)1
TEXT(ST)	GAS1 ST

Program each item as follows:

- **PRICE(Cent) (Use the numeric entry)**
Reduce unit price for each media (0.0 to 99.9 Cent)
- **TEXT (Use the character entry)**
Description for the gas discount. Up to 8 characters can be entered.
- **TEXT(ST) (Use the character entry)**
Description for the gas discount subtotal. Up to 8 characters can be entered.

■ Gratuity

Procedure

GRATUITY	↓
RATE	-0.00%
TEXT	GRATUITY
SIGN	-
TAXABLE1	NO
TAXABLE2	NO
TAXABLE3	NO

The screen continues.

Program each item as follows:

- **RATE (Use the numeric entry)**
Percent rate (0.00 to 100.00)
- **TEXT (Use the character entry)**
Description for the gratuity. Up to 8 characters can be entered.
- **SIGN (Use the selective entry)**
Programming of the + or – sign assigns the premium or discount function for the gratuity.
–: Minus (discount)
+ : Plus (premium)
- **TAXABLE1 thru 4 (Use the selective entry)**
YES: Taxable
NO: Non-taxable
- **FOOD STAMP (Use the selective entry)**
Food stamp status
NO: Food stamp ineligible
YES: Food stamp eligible

■ Tip

Procedure

TIP	
RATE	0.00%
TEXT(CASH)	CA TIP
TEXT(CHR)	CH TIP
HALO	17

Program each item as follows:

- **RATE (Use the numeric entry)**
Percent rate (0.00 to 100.00)
- **TEXT(CASH) (Use the character entry)**
Description for the cash tip. Up to 8 characters can be entered.
- **TEXT(CHR) (Use the character entry)**
Description for the non-cash tip. Up to 8 characters can be entered.
- **HALO (High Amount Lockout: use the numeric entry)**
A: Significant digit for HALO (1 thru 9)
B: Number of zeros to follow the significant digit for HALO (0 thru 8)
AB is the same as $A \times 10^B$.

NOTE

You can also select a tip key by pressing the corresponding key when it has been placed directly on the keyboard instead of selecting the key from the menu.

■ RA

Procedure

Select the desired received-on-account key from the RA keys list.

```
***RA
↓
HALO 18
TEXT ***RA
DATA ENT. JOB# 00
CAT NOT COMPUL.
RESERVE ONLINE COMP.
RESERVED NO
```

Program each item as follows:

- **HALO (High Amount Lockout: use the numeric entry)**

A: Significant digit for HALO (1 thru 9)

B: Number of zeros to follow the significant digit for HALO (0 thru 8)

AB is the same as $A \times 10^B$.

- **TEXT (Use the character entry)**

Description for the received-on-account key. Up to 8 characters can be entered.

NOTE

You can also select an RA key by pressing the corresponding key when it has been placed directly on the keyboard instead of selecting the key from the menu.

- **DATA ENT. JOB# (Use the numeric entry)**

Key data entry job no. (Capture job no.: 0 thru 99)

When "0" is programmed, data entry is inhibited.

- **CAT (Use the selective entry)**

CAT programming (reserved/non-compulsory)

- NOT COMPUL.
- RESERVED

- **RESERVED (Use the selective entry)**

- CARD RD COMP.
- OFFLINE COMP.
- ONLINE COMP.

- **RESERVED (Use the selective entry)**

- NO
- YES

■ PO

Procedure

Select the desired paid-out key from the PO keys list.

```
***PO
-----
HALO                                     18
TEXT          ***PO
DATA ENT. JOB# 00
```

Program each item as follows:

- **HALO (High Amount Lockout: use the numeric entry)**
 - A: Significant digit for HALO (1 thru 9)
 - B: Number of zeros to follow the significant digit for HALO (0 thru 8)
 - AB is the same as $A \times 10^B$.
- **TEXT (Use the character entry)**
 - Description for the paid-out key. Up to 8 characters can be entered.

NOTE

You can also select a PO key by pressing the corresponding key when it has been placed directly on the keyboard instead of selecting the key from the menu.

- **DATA ENT. JOB# (Use the numeric entry)**
 - Key data entry job no. (Capture job no.: 0 thru 99)
 - When "0" is programmed, data entry is inhibited.

■ Manual tax

Procedure

```
MANUAL TAX
-----
HALO                                     17
TEXT          M-TAX
DATA ENT. JOB# 00
```

Program each item as follows:

- **HALO (High Amount Lockout: use the numeric entry)**
 - A: Significant digit for HALO (1 thru 9)
 - B: Number of zeros to follow the significant digit for HALO (0 thru 8)
 - AB is the same as $A \times 10^B$.
- **TEXT (Use the character entry)**
 - Description for the manual tax key. Up to 8 characters can be entered.

NOTE

You can also select the manual tax key by pressing the corresponding key when it has been placed directly on the keyboard instead of selecting the key from the menu.

- **DATA ENT. JOB# (Use the numeric entry)**
 - Key data entry job no. (Capture job no.: 0 thru 99)
 - When "0" is programmed, data entry is inhibited.

■ Void

Procedure

Select the desired void function from the list (DIR VD/PAST VD/SBTL VD).

DIR VD	
TEXT	DIR VD
DATA ENT .JOB#	00
a	

Program each item as follows:

- **TEXT (Use the character entry)**
Description for the void function.
Up to 8 characters can be entered.
- **DATA ENT. JOB# (Use the numeric entry)**
Key data entry job no. (Capture job no.: 0 thru 99)
When "0" is programmed, data entry is inhibited.

■ Refund

Procedure

Select the refund or return function.

REFUND	
TEXT	REFUND
DATA ENT .JOB#	00
a	

Program each item as follows:

- **TEXT (Use the character entry)**
Description for the refund or return function.
Up to 8 characters can be entered.
- **DATA ENT. JOB# (Use the numeric entry)**
Key data entry job no. (Capture job no.: 0 thru 99)
When "0" is programmed, data entry is inhibited.

Media Key Programming

Use the following procedure to select any option included in the media group:

Procedure

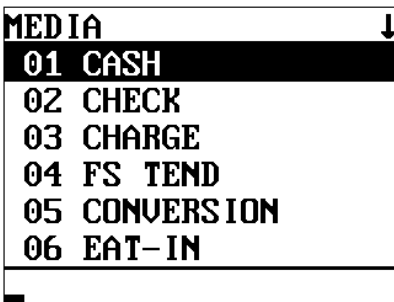
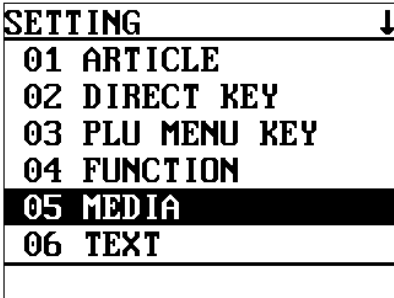

The screen continues.

1. In the SETTING window, select “05 MEDIA.”

- The MEDIA window will appear.

2. Select any option from the following options list:

1 CASH:	Cash key
2 CHECK:	Check key
3 CHARGE:	Charge key
4 FS TEND:	Food stamp tender key
5 CONVERSION:	Currency conversion keys
6 EAT-IN:	Eat-in key
7 SERVICE:	Service key
8 FINAL:	Final key
9 CID:	Cash in drawer
10 CH/CG:	Check change
11 CA/CK:	Check cashing

The following illustration shows those options included in the media key programming group.

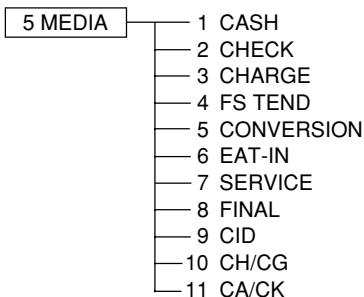

- ➔ See “Cash keys” on page [125](#).
- ➔ See “Check keys” on page [129](#).
- ➔ See “Charge keys” on page [133](#).
- ➔ See “Food stamp tender key” on page [137](#).
- ➔ See “Currency conversion keys” on page [139](#).
- ➔ See “Eat-in keys” on page [139](#).
- ➔ See “Service key” on page [140](#).
- ➔ See “Final key” on page [142](#).
- ➔ See “Cash in drawer” on page [144](#).
- ➔ See “Check change” on page [144](#).
- ➔ See “Check cashing” on page [145](#).

■ Cash keys

Procedure

Select the desired cash key from the cash keys list.

CASH	↓
TEXT	CASH
HALO	18
GLU/PBLU	ENABLE
SHORT TENDER	ENABLE
HEADER ON BILL	NO
FOOTER ON BILL	NO
	a

The screen continues.

Program each item as follows:

- **TEXT (Use the character entry)**
Description for the cash key. Up to 8 characters can be entered.
- **HALO (High Amount Lockout: use the numeric entry)**
AB is the same as $A \times 10^B$.
A: Significant digit (1 thru 9)
B: Number of zeros to follow the significant digit (0 thru 8)
You can set AB at 18 for no limitation.
- **GLU/PBLU (Use the selective entry)**
GLU/PBLU entry
COMPUL.: Makes the GLU/PBLU entry compulsory.
INHIBIT: Inhibits GLU/PBLU entry.
ENABLE: Enables GLU/PBLU entry.
- **SHORT TENDER (Use the selective entry)**
Short amount tender
DISABLE: Disables short amount tender.
ENABLE: Enables short amount tender.
- **HEADER ON BILL (Use the selective entry)**
YES: Enables header printing on the bill.
NO: Disables header printing on the bill.
- **FOOTER ON BILL (Use the selective entry)**
YES: Enables footer printing on the bill.
NO: Disables footer printing on the bill.
- **CLOSED GC (Use the selective entry)**
RETAIN.: Retains the closed GLU/PBLU summary data.
NO RETAIN.: Does not retain the closed GLU/PBLU summary data.
- **BILL PR. (Use the selective entry)**
Compulsory/non-compulsory bill printing
COMPUL.: Compulsory bill printing
NON-COMPUL.: Non-compulsory bill printing
- **FOOTER ON RCPT (Use the selective entry)**
This item decides whether or not your POS terminal should print a message at the foot of a receipt when a specified cash key is used.
YES: Enables footer printing on the receipt.
NO: Disables footer printing on the receipt.

■ Cash keys (continued)

- **NON ADD# (Use the selective entry)**

You can enforce the non-add code entry when a cash entry is accepted.

COMPUL.: Compulsory non-add code entry

NON-COMPUL.: Non-compulsory non-add code entry

- **NEG # CHECK (Use the selective entry)**

YES: Enables the negative # check function.

Any code (non-add code) existing in the negative # file is treated as invalid. The negative # check function can be overridden depending upon the programming.

NO: Disables the negative # check function.

- **POSITIVE # (Use the selective entry)**

YES: Enables the positive # check function.

Any code (non-add code) existing in the positive # file is treated as valid.

NO: Disables the positive # check function.

- **VP (Use the selective entry)**

COMPUL.: Compulsory validation printing

NON-COMPUL.: Non-compulsory validation printing

- **GAS DISCOUNT (Use the selective entry)**

YES: Enables gas discount.

NO: Disables gas discount.

- **TAX1 thru 4 DELETE (Use the selective entry)**

You can program each cash key to delete tax (i.e. tax 1, tax 2, tax 3, and tax 4) when it is pressed.

YES: Deletes Tax n (1 thru 4).

NO: Calculates Tax n (1 thru 4).

- **DRAWER OPENING (Use the selective entry)**

You can program each cash key to open the drawer.

NO: Disables the drawer opening.

YES: Opens the drawer.

- **AMOUNT (Use the selective entry)**

You may select compulsory or non-compulsory amount tender.

COMPUL.: Compulsory amount tendered entry

NON-COMPUL.: Non-compulsory amount tendered entry

- **OUTPUT KP No.1 thru No.3 (Use the numeric entry)**

ID number of the remote printer 1, 2 or 3 (1 digit: 1 to 9)

If the number "0" is entered, no items will be sent to the remote printer.

- **CHIT RECEIPT (Use the selective entry)**

YES: Prints on the chit receipt in the remote printer format.

NO: Prints nothing on the chit receipt.

- **DATA ENT. JOB# (Use the numeric entry)**

Key data entry job no. (Capture job no.: 0 thru 99)

When "0" is programmed, the data capture entry is inhibited.

■ Cash keys (continued)

- **CAT (Use the selective entry)**

You can select compulsory or non-compulsory CAT2/CAT1.

RESERVED:

CAT#2 COMPUL.: Compulsory CAT2

CAT#1 COMPUL.: Compulsory CAT1

NOT COMPUL.: Non-compulsory CAT2/CAT1

- **CAT 1 (Use the selective entry)**

Select the ACTION CODE from the following items:

- RESERVED
- DIAL
- NOT TRANSMIT

- **CAT 2 (Use the selective entry)**

Select the ACTION CODE from the following items:

- AUTH-ONLY
- DIAL
- POST-AUTH

- **CAT2 (Use the selective entry)**

Select the transaction type.

- CHECK
- RESERVED
- CREDIT

- **RESERVED (Use the selective entry)**

- ONLINE COMP.
- OFFLINE COMP.
- CARD RD COMP.

- **RESERVED (Use the selective entry)**

- NO
- YES

- **RESERVED (Use the selective entry)**

- NO
- YES

- **CARD# PRT. (Use the selective entry)**

YES: Prints the card number.

NO: Does not print the card number.

- **CARD# FORMAT (Use the selective entry)**

FULL: Prints the entire card number.

PARTIAL: Prints only part of a card number.

- **SIGN.LINE PRT. (Use the selective entry)**

YES: Prints the signature line.

NO: Does not print the signature line.

■ Cash keys (continued)

- **CARD HOLD. PRT. (Use the selective entry)**

YES: Prints the name of the card holder.

NO: Not prints the name of the card holder.

- **EXPIRATION PRT. (Use the selective entry)**

YES: Prints the card expiration date.

NO: Not prints the card expiration date.

- **NUMBER OF RCPT (Use the numeric entry)**

Number of authorization receipts to be issued (1 digit: 1 to 9)

If the number "0" is entered, no authorization receipt is issued.

NOTE

You can also select a cash key by pressing the corresponding key when it has been placed directly on the keyboard instead of selecting the key from the menu.

■ Check keys

Procedure

Select the desired check key from the check keys list.

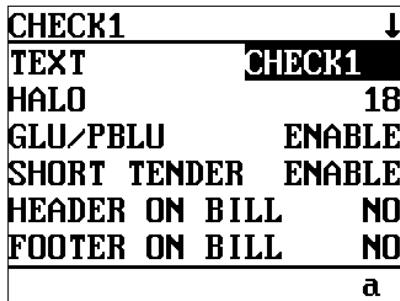

CHECK1	
TEXT	CHECK1
HALO	18
GLU/PBLU	ENABLE
SHORT TENDER	ENABLE
HEADER ON BILL	NO
FOOTER ON BILL	NO
	a

The screen continues.

Program each item as follows:

- **TEXT (Use the character entry)**
Description for the check key. Up to 8 characters can be entered.
- **HALO (High Amount Lockout: use the numeric entry)**
AB is the same as $A \times 10^B$.
A: Significant digit (1 thru 9)
B: Number of zeros to follow the significant digit (0 thru 8)
You can set AB at 18 for no limitation.
- **GLU/PBLU (Use the selective entry)**
COMPUL.: Makes GLU/PBLU entry compulsory.
INHIBIT: Inhibits GLU/PBLU entry.
ENABLE: Enables GLU/PBLU entry.
- **SHORT TENDER (Use the selective entry)**
DISABLE: Disables short amount tender.
ENABLE: Enables short amount tender.
- **HEADER ON BILL (Use the selective entry)**
YES: Enables header printing on the bill.
NO: Disables header printing on the bill.
- **FOOTER ON BILL (Use the selective entry)**
YES: Enables footer printing on the bill.
NO: Disables footer printing on the bill.
- **CLOSED GC (Use the selective entry)**
RETAIN.: Retains the closed GLU/PBLU summary data.
NO RETAIN.: Does not retain the closed GLU/PBLU summary data.
- **BILL PR. (Use the selective entry)**
COMPUL.: Compulsory bill printing
NON-COMPUL.: Non-compulsory bill printing
- **FOOTER ON RCPT (Use the selective entry)**
YES: Enables footer printing on the receipt.
NO: Disables footer printing on the receipt.
- **NON ADD # (Use the selective entry)**
COMPUL.: Compulsory non-add code entry
NON-COMPUL.: Non-compulsory non-add code entry

■ Check keys (continued)

- **NEG # CHECK (Use the selective entry)**

YES: Enables the negative # check function.

Any code (non-add code) existing in the negative # file is treated as invalid. The negative # check function can be overridden depending upon the programming.

NO: Disables the negative # check function.

- **POSITIVE # (Use the selective entry)**

YES: Enables the positive # check function.

Any code (non-add code) existing in the positive # file is treated as valid.

NO: Disables the positive # check function.

- **CHANGE DUE (Use the selective entry)**

Either change enable or disable can be selected for each check key.

DISABLE: Disables change calculation.

ENABLE: Enables change calculation.

- **VP (Use the selective entry)**

COMPUL.: Compulsory validation printing

NON-COMPUL.: Non-compulsory validation printing

- **GAS DISCOUNT (Use the selective entry)**

YES: Enables gas discount.

NO: Disables gas discount.

- **TAX1 thru 4 DELETE (Use the selective entry)**

You can program each check key to delete tax (i.e. tax 1, tax 2, tax 3, and tax 4) when it is pressed.

YES: Deletes Tax n (1 thru 4).

NO: Calculates Tax n (1 thru 4).

- **DRAWER OPENING (Use the selective entry)**

NO: Disables the drawer opening.

YES: Opens the drawer.

- **AMOUNT (Use the selective entry)**

COMPUL.: Compulsory amount tendered entry

NON-COMPUL.: Non-compulsory amount tendered entry

- **OUTPUT KP No.1 thru 3 (Use the numeric entry)**

ID number of the remote printer 1, 2 or 3 (1 digit: 1 to 9)

If the number "0" is entered, no items will be sent to the remote printer.

- **CHIT RECEIPT (Use the selective entry)**

YES: Prints on the chit receipt in the remote printer format.

NO: Prints nothing on the chit receipt.

- **DATA ENT. JOB# (Use the numeric entry)**

Key data entry job no. (Capture job no.: 0 thru 99)

When "0" is programmed, the data capture entry is inhibited.

■ Check keys (continued)

- **CAT (Use the selective entry)**
 - CAT#2 COMPUL.: Compulsory CAT2
 - CAT#1 COMPUL.: Compulsory CAT1
 - NOT COMPUL.: Non-compulsory CAT2/CAT1

- **CAT 1 (Use the selective entry)**
 - Select the ACTION CODE from the following items:
 - RESERVED
 - DIAL
 - NOT TRANSMIT

- **CAT 2 (Use the selective entry)**
 - Select the ACTION CODE from the following items:
 - AUTH-ONLY
 - DIAL
 - POST-AUTH

- **CAT2 (Use the selective entry)**
 - Select the transaction type.
 - CHECK
 - RESERVED
 - CREDIT

- **RESERVED (Use the selective entry)**
 - ONLINE COMP.
 - OFFLINE COMP.
 - CARD RD COMP.

- **RESERVED (Use the selective entry)**
 - NO
 - YES

- **RESERVED (Use the selective entry)**
 - NO
 - YES

- **CARD# PRT. (Use the selective entry)**
 - YES: Prints the card number.
 - NO: Does not print the card number.

- **CARD# FORMAT (Use the selective entry)**
 - FULL: Prints the entire card number.
 - PARTIAL: Prints only part of a card number.

- **SIGN.LINE PRT. (Use the selective entry)**
 - YES: Prints the signature line.
 - NO: Does not print the signature line.

- **CARD HOLD. PRT. (Use the selective entry)**
 - YES: Prints the name of the card holder.
 - NO: Does not print the name of the card holder.

■ Check keys (continued)

- **EXPIRATION PRT. (Use the selective entry)**

YES: Prints the card expiration date.

NO: Does not print the card expiration date.

- **NUMBER OF RCPT (Use the numeric entry)**

Number of authorization receipts to be issued (1 digit: 1 to 9)

If the number "0" is entered, no authorization receipt is issued.

NOTE

You can also select a check key by pressing the corresponding key when it has been placed directly on the keyboard instead of selecting the key from the menu.

■ Charge keys

Procedure

Select the desired charge key from the charge keys list.

CHARGE1	↓
TEXT(GROSS)	CHARGE1
TEXT(REFUND)	CHARGE1-
HALO	18
GLU/PBLU	ENABLE
SHORT TENDER	ENABLE
HEADER ON BILL	NO
	a

The screen continues.

Program each item as follows:

- **TEXT(GROSS) (Use the character entry)**
Description for the charge (gross sales) key. Up to 8 characters can be entered.
- **TEXT(REFUND) (Use the character entry)**
Description for the (refunded) charge key. Up to 8 characters can be entered.
- **HALO (High Amount Lockout: use the numeric entry)**
AB is the same as $A \times 10^B$.
A: Significant digit (1 thru 9)
B: Number of zeros to follow the significant digit (0 thru 8)
You can set AB at 18 for no limitation.
- **GLU/PBLU (Use the selective entry)**
COMPUL.: Makes GLU/PBLU entry compulsory.
INHIBIT: Inhibits GLU/PBLU entry.
ENABLE: Enables GLU/PBLU entry.
- **SHORT TENDER (Use the selective entry)**
DISABLE: Disables short amount tender.
ENABLE: Enables short amount tender.
- **HEADER ON BILL (Use the selective entry)**
YES: Enables header printing on the bill.
NO: Disables header printing on the bill.
- **FOOTER ON BILL (Use the selective entry)**
YES: Enables footer printing on the bill.
NO: Disables footer printing on the bill.
- **CLOSED GC (Use the selective entry)**
RETAIN.: Retains the closed GLU/PBLU summary data.
NO RETAIN.: Does not retain the closed GLU/PBLU summary data.
- **BILL PR. (Use the selective entry)**
Compulsory/non-compulsory bill printing
COMPUL.: Compulsory bill printing
NON-COMPUL.: Non-compulsory bill printing
- **FOOTER ON RCPT (Use the selective entry)**
YES: Enables footer printing on the receipt.
NO: Disables footer printing on the receipt.
- **NON ADD # (Use the selective entry)**
COMPUL.: Compulsory non-add code entry
NON-COMPUL.: Non-compulsory non-add code entry

■ Charge keys (continued)

- **NEG # CHECK (Use the selective entry)**

YES: Enables the negative # check function.

Any code (non-add code) existing in the negative # file is treated as invalid. The negative # check function can be overridden depending upon the programming.

NO: Disables the negative # check function.

- **POSITIVE # (Use the selective entry)**

YES: Enables the positive # check function.

Any code (non-add code) existing in the positive # file is treated as valid.

NO: Disables the positive # check function.

- **CHANGE DUE (Use the selective entry)**

Either change enable or disable can be selected for each check key.

DISABLE: Disables change calculation.

ENABLE: Enables change calculation.

- **VP (Use the selective entry)**

COMPUL.: Compulsory validation printing

NON-COMPUL.: Non-compulsory validation printing

- **GAS DISCOUNT (Use the selective entry)**

YES: Enables gas discount.

NO: Disables gas discount.

- **TAX1 thru 4 DELETE (Use the selective entry)**

You can program each check key to delete tax (i.e. tax 1, tax 2, tax 3, and tax 4) when it is pressed.

YES: Deletes Tax n (1 thru 4).

NO: Calculates Tax n (1 thru 4).

- **DRAWER OPENING (Use the selective entry)**

NO: Disables the drawer opening.

YES: Opens the drawer.

- **AMOUNT (Use the selective entry)**

COMPUL.: Compulsory amount tendered entry

INHIBIT: Inhibit amount tendered entry

- **OUTPUT KP No.1 thru 3 (Use the numeric entry)**

ID number of the remote printer 1, 2 or 3 (1 digit: 1 to 9)

If the number "0" is entered, no items will be sent to the remote printer.

- **CHIT RECEIPT (Use the selective entry)**

YES: Prints on the chit receipt in the remote printer format.

NO: Prints nothing on the chit receipt.

- **DATA ENT. JOB# (Use the numeric entry)**

Key data entry job no. (Capture job no.: 0 thru 99)

When "0" is programmed, the data capture entry is inhibited.

■ Charge keys (continued)

- **CAT (Use the selective entry)**

RESERVED:

CAT#2 COMPUL.: Compulsory CAT2

CAT#1 COMPUL.: Compulsory CAT1

NOT COMPUL.: Non-compulsory CAT2/CAT1

- **CAT 1 (Use the selective entry)**

Select the ACTION CODE from the following items:

- RESERVED
- DIAL
- NOT TRANSMIT

- **CAT 2 (Use the selective entry)**

Select the ACTION CODE from the following items:

- AUTH-ONLY
- DIAL
- POST-AUTH

- **CAT2 (Use the selective entry)**

Select the transaction type.

- CHECK
- RESERVED
- CREDIT

- **RESERVED (Use the selective entry)**

- ONLINE COMP.
- OFFLINE COMP.
- CARD RD COMP.

- **RESERVED (Use the selective entry)**

- NO
- YES

- **RESERVED (Use the selective entry)**

- NO
- YES

- **CARD# PRT. (Use the selective entry)**

YES: Prints the card number.

NO: Does not print the card number.

- **CARD# FORMAT (Use the selective entry)**

FULL: Prints the entire card number.

PARTIAL: Prints only part of a card number.

- **SIGN.LINE PRT. (Use the selective entry)**

YES: Prints the signature line.

NO: Does not print the signature line.

- **CARD HOLD. PRT. (Use the selective entry)**

YES: Prints the name of the card holder.

NO: Does not print the name of the card holder.

■ Charge keys (continued)

- **EXPIRATION PRT. (Use the selective entry)**

YES: Prints the card expiration date.

NO: Does not print the card expiration date.

- **NUMBER OF RCPT (Use the numeric entry)**

Number of authorization receipts to be issued (1 digit: 1 to 9)

If the number "0" is entered, no authorization receipt is issued.

NOTE

You can also select a charge key by pressing the corresponding key when it has been placed directly on the keyboard instead of selecting the key from the menu.

■ Food stamp tender key

Procedure

FS TEND	↓
TEXT	FS TEND
GLU/PBLU	ENABLE
HEADER ON BILL	NO
FOOTER ON BILL	NO
CLOSED GC NO RETAIN.	
BILL PR. NON-COMPUL.	
	a

The screen continues.

Program each item as follows:

- **TEXT (Use the character entry)**
Description for the check key. Up to 8 characters can be entered.
- **GLU/PBLU (Use the selective entry)**
COMPUL.: Makes GLU/PBLU entry compulsory.
INHIBIT: Inhibits GLU/PBLU entry.
ENABLE: Enables GLU/PBLU entry.
- **HEADER ON BILL (Use the selective entry)**
YES: Enables header printing on the bill.
NO: Disables header printing on the bill.
- **FOOTER ON BILL (Use the selective entry)**
YES: Enables footer printing on the bill.
NO: Disables footer printing on the bill.
- **CLOSED GC (Use the selective entry)**
RETAIN.: Retains the closed GLU/PBLU summary data.
NO RETAIN.: Does not retain the closed GLU/PBLU summary data.
- **BILL PR. (Use the selective entry)**
COMPUL.: Compulsory bill printing
NON-COMPUL.: Non-compulsory bill printing
- **FOOTER ON RCPT (Use the selective entry)**
YES: Enables footer printing on the receipt.
NO: Disables footer printing on the receipt.
- **NON ADD # (Use the selective entry)**
COMPUL.: Compulsory non-add code entry
NON-COMPUL.: Non-compulsory non-add code entry
- **NEG # CHECK (Use the selective entry)**
YES: Enables the negative # check function.
Any code (non-add code) existing in the negative # file is treated as invalid. The negative # check function can be overridden depending upon the programming.
NO: Disables the negative # check function.

■ Food stamp tender key (continued)

- **POSITIVE # (Use the selective entry)**

YES: Enables the positive # check function.

Any code (non-add code) existing in the positive # file is treated as valid.

NO: Disables the positive # check function.

- **VP (Use the selective entry)**

COMPUL.: Compulsory validation printing

NON-COMPUL.: Non-compulsory validation printing

- **DRAWER OPENING (Use the selective entry)**

NO: Disables the drawer opening.

YES: Opens the drawer.

- **OUTPUT KP No.1 thru 3 (Use the numeric entry)**

ID number of the remote printer 1, 2 or 3 (1 digit: 1 to 9)

If the number "0" is entered, no items will be sent to the remote printer.

- **CHIT RECEIPT (Use the selective entry)**

YES: Prints on the chit receipt in the remote printer format.

NO: Prints nothing on the chit receipt.

- **DATA ENT. JOB# (Use the numeric entry)**

Key data entry job no. (Capture job no.: 0 thru 99)

When "0" is programmed, the data capture entry is inhibited.

NOTE

You can also select a food stamp tender key by pressing the corresponding key when it has been placed directly on the keyboard instead of selecting the key from the menu.

■ Currency conversion keys

Procedure

Select the desired currency conversion key from the currency conversion keys list.

CONV 1	
RATE	0.0000
TEXT	CONV 1
DESCRIPTOR	

Program each item as follows:

- **RATE (Use the numeric entry)**
Currency conversion rate (0.0000 to 9999.9999) (for CONV1 thru CONV3)
- **TEXT (Use the character entry)**
Description for the currency conversion key. Up to 8 characters can be entered.
- **DESCRIPTOR (Use the character entry)**
Currency descriptor. Up to 4 characters can be entered.

NOTE

You can also select a conversion key by pressing the corresponding key when it has been placed directly on the keyboard instead of selecting the key from the menu.

■ Eat-in keys

Procedure

Select the desired eat-in key from the eat-in keys list.

EAT IN 1	
TEXT	EAT IN 1
TAX1 DELETE	NO
TAX2 DELETE	NO
TAX3 DELETE	NO
TAX4 DELETE	NO
a	

Program each item as follows:

- **TEXT (Use the character entry)**
Description for the eat-in key. Up to 8 characters can be entered.
- **TAX1 thru 4 DELETE (Use the selective entry)**
YES: Deletes Tax n (1 thru 4).
NO: Calculates Tax n (1 thru 4).

NOTE

You can also select an eat-in key by pressing the corresponding key when it has been placed directly on the keyboard instead of selecting the key from the menu.

■ Service key

Procedure

SERVICE	↓
TEXT(GLU) SERVICE	
HEADER ON BILL	NO
FOOTER ON BILL	NO
BILL PR. NON-COMPUL.	
OUTPUT KP No.1	0
OUTPUT KP No.2	0
	a

The screen continues.

Program each item as follows:

- **TEXT (GLU) (Use the character entry)**
Description for the service key. Up to 8 characters can be entered.
- **HEADER ON BILL (Use the selective entry)**
YES: Enables header printing on the bill.
NO: Disables header printing on the bill.
- **FOOTER ON BILL (Use the selective entry)**
YES: Enables footer printing on the bill.
NO: Disables footer printing on the bill.
- **BILL PR. (Use the selective entry)**
COMPUL.: Compulsory bill printing
NON-COMPUL.: Non-compulsory bill printing
- **OUTPUT KP No.1 thru 3 (Use the selective entry)**
ID number of the remote printer 1, 2 or 3 (1 digit: 1 to 9)
If the number "0" is entered, data will be printed at the remote printer.
- **CHIT RECEIPT (Use the selective entry)**
YES: Prints on the chit receipt in the remote printer format.
NO: Prints nothing on the chit receipt.
- **DATA ENT. JOB# (Use the numeric entry)**
Key data entry job no. (Capture job no.: 0 thru 99)
When "0" is programmed, the data capture entry is inhibited.
- **CAT (Use the selective entry)**
RESERVED:
CAT#2 COMPUL.: Compulsory CAT2
CAT#1 COMPUL.: Compulsory CAT1
NOT COMPUL.: Non-compulsory CAT2/CAT1
- **CAT 1 (Use the selective entry)**
Select the ACTION CODE from the following items:
 - RESERVED
 - DIAL
 - NOT TRANSMIT
- **CAT 2 (Use the selective entry)**
Select the ACTION CODE from the following items:
 - POST-AUTH
 - DIAL
 - AUTH-ONLY

■ Service key (continued)

- **CAT2 (Use the selective entry)**

Select the transaction type.

- CHECK
- RESERVED
- CREDIT

- **RESERVED (Use the selective entry)**

- ONLINE COMP.
- OFFLINE COMP.
- CARD RD COMP.

- **RESERVED (Use the selective entry)**

- NO
- YES

- **RESERVED (Use the selective entry)**

- NO
- YES

- **CARD# PRT. (Use the selective entry)**

YES: Prints the card number.

NO: Does not print the card number.

- **CARD# FORMAT (Use the selective entry)**

FULL: Prints the entire card number.

PARTIAL: Prints only part of a card number.

- **SIGN.LINE PRT. (Use the selective entry)**

YES: Prints the signature line.

NO: Does not print the signature line.

- **CARD HOLD. PRT. (Use the selective entry)**

YES: Prints the name of the card holder.

NO: Does not print the name of the card holder.

- **EXPIRATION PRT. (Use the selective entry)**

YES: Prints the card expiration date.

NO: Does not print the card expiration date.

- **NUMBER OF RCPT (Use the numeric entry)**

Number of authorization receipts to be issued (1 digit: 1 to 9)

If the number "0" is entered, no authorization receipt is issued.

NOTE

You can also select the service key by pressing the corresponding key when it has been placed directly on the keyboard instead of selecting the key from the menu.

■ Final key

Procedure

FINAL	↓
HEADER ON BILL	NO
FOOTER ON BILL	NO
BILL PR. NON-COMPUL.	
OUTPUT KP No.1	0
OUTPUT KP No.2	0
OUTPUT KP No.3	0

The screen continues.

Program each item as follows:

- **HEADER ON BILL (Use the selective entry)**
 - YES: Enables header printing on the bill.
 - NO: Disables header printing on the bill.
- **FOOTER ON BILL (Use the selective entry)**
 - YES: Enables footer printing on the bill.
 - NO: Disables footer printing on the bill.
- **BILL PR. (Use the selective entry)**
 - COMPUL.: Compulsory bill printing
 - NON-COMPUL.: Non-compulsory bill printing
- **OUTPUT KP No.1 thru 3 (Use the number entry)**
 - ID number of the remote printer 1, 2 or 3 (1 digit: 1 to 9)
 - If the number "0" is entered, data will be printed at the remote printer.
- **CHIT RECEIPT (Use the selective entry)**
 - YES: Prints on the chit receipt in the remote printer format.
 - NO: Prints nothing on the chit receipt.
- **DATA ENT. JOB# (Use the numeric entry)**
 - Key data entry job no. (Capture job no.: 0 thru 99)
 - When "0" is programmed, the data capture entry is inhibited.
- **CAT (Use the selective entry)**
 - RESERVED:
 - CAT#2 COMPUL.: Compulsory CAT2
 - CAT#1 COMPUL.: Compulsory CAT1
 - NOT COMPUL.: Non-compulsory CAT2/CAT1
- **CAT 1 (Use the selective entry)**
 - Select the ACTION CODE from the following items:
 - RESERVED
 - DIAL
 - NOT TRANSMIT
- **CAT 2 (Use the selective entry)**
 - Select the ACTION CODE from the following items:
 - POST-AUTH
 - DIAL
 - AUTH-ONLY
- **CAT2 (Use the selective entry)**
 - Select the transaction type.
 - CREDIT
 - RESERVED
 - CHECK

■ Final key (continued)

- **RESERVED (Use the selective entry)**
 - ONLINE COMP.
 - OFFLINE COMP.
 - CARD RD COMP.

- **RESERVED (Use the selective entry)**
 - NO
 - YES

- **RESERVED (Use the selective entry)**
 - NO
 - YES

- **CARD# PRT. (Use the selective entry)**
 - YES: Prints the card number.
 - NO: Does not print the card number.

- **CARD# FORMAT (Use the selective entry)**
 - FULL: Prints the entire card number.
 - PARTIAL: Prints only part of a card number.

- **SIGN.LINE PRT. (Use the selective entry)**
 - YES: Prints the signature line.
 - NO: Does not print the signature line.

- **CARD HOLD. PRT. (Use the selective entry)**
 - YES: Prints the name of the card holder.
 - NO: Does not print the name of the card holder.

- **EXPIRATION PRT. (Use the selective entry)**
 - YES: Prints the card expiration date.
 - NO: Does not print the card expiration date.

- **NUMBER OF RCPT (Use the numeric entry)**
 - Number of authorization receipts to be issued (1 digit: 1 to 9)
 - If the number "0" is entered, no authorization receipt is issued.

NOTE

You can also select the final key by pressing the corresponding key when it has been placed directly on the keyboard instead of selecting the key from the menu.

■ Cash in drawer

You can program the description and the upper limit amounts for cash in drawer (sentinel).

Procedure

CID	
TEXT	████████CID
HALO	9999999.99
a	

Program each item as follows:

- **TEXT (Use the character entry)**
Description for the cash in drawer. Up to 8 characters can be entered.
- **HALO (High Amount Lockout: used the numeric entry)**
Limit amount: 0 to 9999999.99

■ Check change

You can program the description and the upper limit amounts for check change.

Procedure

CH/CG	
TEXT	████████CHK/CG
HALO	999999.99
a	

Program each item as follows:

- **TEXT (Use the character entry)**
Description for check change. Up to 8 characters can be entered.
- **HALO (High Amount Lockout: used the numeric entry)**
Limit amount: 0 to 999999.99

■ Check cashing

You can program the description and the upper limit amounts for check cashing.

Procedure

Select the desired check cashing no. from the check cashing numbers list.

CA/CHK1	↓
TEXT	CA/CHK1
HALO	999999.99
CAT	NOT COMPUL.
CAT1	NOT TRANSMIT
CAT2	POST-AUTH
CAT2	CREDIT
	a

The screen continues.

Program each item as follows:

- **TEXT (Use the character entry)**
Description for check cashing. Up to 8 characters can be entered.
- **HALO (High Amount Lockout: used the numeric entry)**
Limit amount: 0 to 999999.99
- **CAT (Use the selective entry)**
CAT#2 COMPUL.: Compulsory CAT2
CAT#1 COMPUL.: Compulsory CAT1
NOT COMPUL.: Non-compulsory CAT2/CAT1
- **CAT 1 (Use the selective entry)**
Select the ACTION CODE from the following items:
 - RESERVED
 - DIAL
 - NOT TRANSMIT
- **CAT 2 (Use the selective entry)**
Select the ACTION CODE from the following items:
 - POST-AUTH
 - DIAL
 - AUTH-ONLY
- **CAT2 (Use the selective entry)**
Select the transaction type.
 - CREDIT
 - RESERVED
 - CHECK
- **CARD# PRT. (Use the selective entry)**
YES: Prints the card number.
NO: Does not print the card number.
- **CARD# FORMAT (Use the selective entry)**
FULL: Prints the entire card number.
PARTIAL: Prints only part of a card number.
- **SIGN.LINE PRT. (Use the selective entry)**
YES: Prints the signature line.
NO: Does not print the signature line.
- **CARD HOLD. PRT (Use the selective entry)**
YES: Prints the name of the card holder.
NO: Does not print the name of the card holder.

■ Check cashing (continued)

- **EXPIRATION PRT (Use the selective entry)**

YES: Prints the card expiration date.

NO: Does not print the card expiration date.

- **NUMBER OF RCPT (Use the numeric entry)**

Number of authorization receipts to be issued (1 digit: 1 to 9)

If the number "0" is entered, no authorization receipt is issued.

Text Programming

Use the following procedure to select any option included in the text group:

Procedure

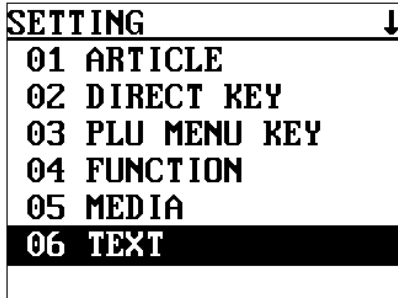

SETTING ↓

- 01 ARTICLE
- 02 DIRECT KEY
- 03 PLU MENU KEY
- 04 FUNCTION
- 05 MEDIA
- 06 TEXT**

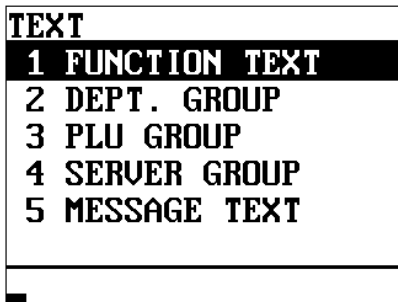

TEXT

- 1 FUNCTION TEXT**
- 2 DEPT. GROUP
- 3 PLU GROUP
- 4 SERVER GROUP
- 5 MESSAGE TEXT

1. In the SETTING window, select "06 TEXT."
 - The TEXT window will appear.

2. Select any option from the following options list:

1 FUNCTION TEXT:	Function text
2 DEPT. GROUP:	Department group text
3 PLU GROUP:	PLU group text
4 SERVER GROUP:	Server group text
5 MESSAGE TEXT:	Message text

The following illustration shows those options included in the text programming group.

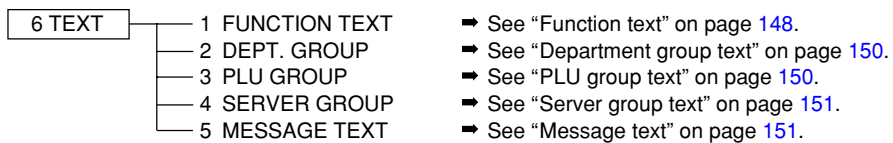

■ Function text

You can program a maximum of eight characters for each function by using the following table:

Procedure

FUNCTION TEXT ↓	
001	NET 1
002	TAX1 ST
003	GRS TAX1
004	RFD TAX1
005	TAX1
006	TX1 EXPT

The screen continues.

Function no.	Function	Default text
001	Net sales total	NET 1
002	Net taxable 1 subtotal	TAX1 ST
003	Gross tax 1 total	GRS TAX1
004	Tax 1 total of refund entries	RFD TAX1
005	Net tax 1 total	TAX1
006	Exempt tax 1	TX1 EXPT
007	Net taxable 2 subtotal	TAX2 ST
008	Gross tax 2 total	GRS TAX2
009	Tax 2 total of refund entries	RFD TAX2
010	Net tax 2 total	TAX2
011	Exempt tax 2	TX2 EXPT
012	Net taxable 3 subtotal	TAX3 ST
013	Gross tax 3 total	GRS TAX3
014	Tax 3 total of refund entries	RFD TAX3
015	Net tax 3 total	TAX3
016	Exempt tax 3	TX3 EXPT
017	Net taxable 4 subtotal	TAX4 ST
018	Gross tax 4 total	GRS TAX4
019	Tax 4 total of refund entries	RFD TAX4
020	Net tax 4 total	TAX4
021	Exempt tax 4	TX4 EXPT
022	Gross manual tax total	GRS MTAX
023	Refund manual tax total	RFD MTAX
024	Exempt total from GST	GST EXPT
025	PST total	PST TTL
026	GST total	GST TTL
027	Tax total	TTL TAX
028	Tax 1 forgiveness total	FS TX1

Function no.	Function	Default text
029	Tax 2 forgiveness total	FS TX2
030	Tax 3 forgiveness total	FS TX3
031	Net	NET
032	Sales total including tax total	NET 2
033	COMBO 1 (for transaction report)	COMBO1
034	COMBO 2 (for transaction report)	COMBO2
035	COMBO 3 (for transaction report)	COMBO3
036	COMBO 4 (for transaction report)	COMBO4
037	COMBO 5 (for transaction report)	COMBO5
038	COMBO 6 (for transaction report)	COMBO6
039	COMBO 7 (for transaction report)	COMBO7
040	COMBO 8 (for transaction report)	COMBO8
041	COMBO 9 (for transaction report)	COMBO9
042	COMBO 10 (for transaction report)	COMBO10
043	COMBO 11 (for transaction report)	COMBO11
044	COMBO 12 (for transaction report)	COMBO12
045	COMBO 13 (for transaction report)	COMBO13
046	COMBO 14 (for transaction report)	COMBO14
047	COMBO 15 (for transaction report)	COMBO15
048	COMBO 16 (for transaction report)	COMBO16
049	COMBO 17 (for transaction report)	COMBO17
050	COMBO 18 (for transaction report)	COMBO18
051	COMBO 19 (for transaction report)	COMBO19
052	COMBO 20 (for transaction report)	COMBO20
053	Coupon-like PLU	CP PLU
054	Vender coupon UPC	V. CP UPC
055	Manager void	MGR VD
056	Void mode	VOID

■ Function text (continued)

Function no.	Function	Default text
057	Hash direct void	HASH VD
058	Hash past void	HA P.VD
059	Hash item refund	HASH RF
060	Hash item return	HASH RT
061	Validation print counter	VP CNT
062	Bill count	BILL CNT
063	Tray counter	TRAY CNT
064	Drawer counter	DRW CNT
065	Transfer out	TRAN.OUT
066	Transfer in	TRAN.IN
067	Previous balance (for GLU)	***PBAL
068	Cover count	COVER CT
069	Customer counter	TRANS CT
070	Sales total	NET 3
071	Hash net total	HASH TTL
072	Food stamp change (cash)	FS/CG
073	Cash+check in drawer	CA+CH ID
074	Food stamp in drawer	FS ID
075	Deposit	DEPOSIT
076	Deposit refund	DPST RF
077	Tip paid	TIP PAID
078	(+) dept. total	*DEPT TL
079	(-) dept. total	DEPT(-)
080	Hash (+) dept. total	*HASH TL
081	Hash (-) dept. total	HASH(-)
082	Bottle (+) dept. total	*BTTL TL
083	Bottle (-) dept. total	BTTL(-)
084	Gasoline (+) dept. total	*GAS TL
085	Gasoline (-) dept. total	GAS(-)
086	Subtotal	SUBTOTAL
087	Merchandise subtotal	MDSE ST
088	Total	***TOTAL
089	Change	CHANGE
090	Due	DUE
091	Tip due	TIP DUE
092	Tray total	TRAY TL
093	Food stamp subtotal	FS ST
094	Food stamp tender	FS TEND
095	Food stamp change	FS CG
096	Items	ITEMS
097	Customer charge	CHARGE
098	Balance	BALANCE

Function no.	Function	Default text
099	Copy	COPY
100	B.T. title	B.T.
101	B.S. title	B.S.
102	Slip print message	SLIP PR.
103	Final balance	FIN.BAL
104	Balance forward	BAL FWD
105	Close check	CLOSE CK
106	Open check	OPEN CK
107	Percent of net sales	(%)SALES
108	Seat code	SEAT#
109	Exempt VAT	VAT EXP
110	Individual payment	IND.PAY
111	Tare weight	TARE WT.
112	Receipt switch	RCP S.W.
113	Free GLU	FREE GLU
114	WASTE title	WASTE
115	Average sales	AVE SALE
116	ST(-) total	ST(-) TL
117	ST% total	ST % TL
118	Item(-) total	(-) TL
119	Item% total	% TL
120	Group discount % total	GDISC%TL
121	Gas discount total	GASDISTL
122	CASH total	CASH TL
123	RA total	RA TL
124	PO total	PO TL
125	CA/CK total	CA/CK TL
126	CONV total	CONV TL
127	CHARGE total	CHR TL
128	CHECK total	CHECK TL
129	COMBO (for PLU report)	COMBO
130	WASTE (for PLU report)	WASTE
131	RF (for PLU report)	RF
132	CP (for PLU report)	CP
133	NET SLS (for PLU report)	NET SLS
134	COMBO TL (for PLU report)	COMBO TL
135	WASTE TL (for PLU report)	WASTE TL
136	RF TL (for PLU report)	RF TL
137	NET TL (for PLU report)	NET TL
138	GLU text	TBL #
139	Server sign-on text	SIGN-ON
140	Server sign-off text	SIGN-OFF

■ Department group text

You can program a maximum of eight characters for each department group (1~9).

Procedure

Select the desired department group number from the department groups list.

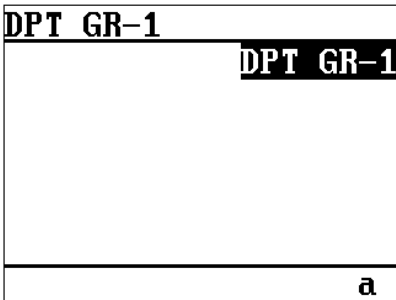

DPT GR-1

DPT GR-1

a

Program the item as follows:

- **TEXT (Use the character entry)**

Description for the department group. Up to 8 characters can be entered.

■ PLU group text

You can program a maximum of eight characters for each PLU group (1~99).

Procedure

Select the desired PLU group number from the PLU groups list.

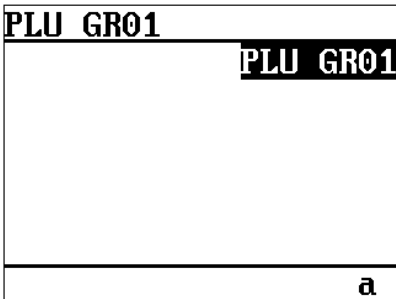

PLU GR01

PLU GR01

a

Program the item as follows:

- **TEXT (Use the character entry)**

Description for the PLU group. Up to 8 characters can be entered.

■ Server group text

You can program a maximum of eight characters for each server group (1~9).

Procedure

Select the desired server group no. from the server groups list.

GROUP1

GROUP1

a

Program the item as follows:

- **TEXT (Use the character entry)**

Description for the server group. Up to 8 characters can be entered.

■ Message text

You can program a message consisting of a maximum of 16 characters for each remote printer.

Procedure

Select the desired message no. from the message list.

MESSAGE1

MESSAGE 1

REMOTE PRINTER 0

PRINT LOCATION TOP

a

Program each item as follows:

- **TEXT (Use the character entry)**

Description for a remote printer message. Up to 16 characters can be entered.

- **REMOTE PRINTER (Use the numeric entry)**

Remote printer number (1 - 9/0)

- **PRINT LOCATION (Use the selective entry)**

TOP: Prints the message at the top of a remote printer receipt.

BOTTOM: Prints the message at the bottom of a remote printer receipt.

Personnel Programming

Use the following procedure to select any option included in the personnel group:

■ Server

Procedure

SETTING	↑↓
07 PERSONNEL	
08 TERMINAL	
09 DATE/TIME	
10 OPTIONAL	
11 SECRET CODE	
12 REPORT	



PERSONNEL
1 SERVER



SERVER	↓
0001 SERV.001	
0002 SERV.002	
0003 SERV.003	
0004 SERV.004	
0005 SERV.005	
0006 SERV.006	



0001	
SECRET CODE	0000
NAME	SERV.001
ENTRY	NON-COMPUL.
DRAWER#	1
NET SALES%	0.00%

1. In the SETTING window, select "07 PERSONNEL."
 - The PERSONNEL window will appear.

2. Select the server options.

Program each item as follows:

- **SECRET CODE (Use the numeric entry)**
Secret code (max. 4 digits: 0001 to 9999/0000)
- **NAME (Use the character entry)**
Name for the server. Up to 8 characters can be entered.
- **ENTRY (Use the selective entry)**
GLU(PBLU): Compulsory GLU(PBLU)
NON-COMPUL.: Non-compulsory GLU(PBLU)
- **DRAWER# (Use the numeric entry)**
Drawer number (1 or 2/0)
- **NET SALES% (Use the numeric entry)**
Net sales percent rate (max. 5 digits: 0.00 to 100.00)

Terminal Programming

Use the following procedure to select any option included in the terminal group:

Procedure

SETTING	↑↓
07 PERSONNEL	
08 TERMINAL	
09 DATE/TIME	
10 OPTIONAL	
11 SECRET CODE	
12 REPORT	



TERMINAL
1 MACHINE#
2 CONSECUTIVE#
3 INTERVAL TIMER
4 DEF. MENU LEVEL
5 AVAILABLE GLU#
6 BILL NUMBER

1. In the SETTING window, select "08 TERMINAL."
 - The TERMINAL window will appear.

2. Select any option from the following options list:

1 MACHINE#:	Machine number
2 CONSECUTIVE#:	Consecutive number
3 INTERVAL TIMER:	Interval timer
4 DEF. MENU LEVEL	Default menu level
5 AVAILABLE GLU#	Available GLU code
6 BILL NUMBER	Bill number

The following illustration shows those options included in the terminal programming group.

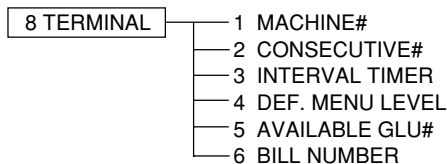

- ➔ See "Machine number" on page [154](#).
- ➔ See "Consecutive number" on page [154](#).
- ➔ See "Interval timer" on page [154](#).
- ➔ See "Default menu level" on page [155](#).
- ➔ See "Available GLU code" on page [155](#).
- ➔ See "Bill number" on page [155](#).

Date/Time Setting

Use the following procedure to select the menu option "09 DATE/TIME":

■ Date/time

You can set the date and time for the POS terminal.

Procedure

SETTING	↑↓
07 PERSONNEL	
08 TERMINAL	
09 DATE/TIME	
10 OPTIONAL	
11 SECRET CODE	
12 REPORT	



DATE/TIME	
DATE	010100
TIME	0000

Set each item as follows:

- **DATE (Use the numeric entry)**

Enter the month (2 digits), day (2 digits), and year (2 digits) in this sequence.

- **TIME (Use the numeric entry)**

Set the time (max. 4 digits) on the military time (24-hour) system. For example, when the time is set to 2:30 AM, enter 0230; and when it is set to 2:30 PM, enter 1430. The time will be printed and displayed on the real-time system. Once you set the time, the internal clock unit will continue to run as long as the battery pack is charged and also update the date (month, day, year) when required.

Optional Feature Selection

Use the following procedure to select any option included in the optional group:

Procedure

SETTING	↑↓
07 PERSONNEL	
08 TERMINAL	
09 DATE/TIME	
10 OPTIONAL	
11 SECRET CODE	
12 REPORT	



OPTIONAL
1 FUNC.PROHIBIT
2 FUNC.SELECT1
3 FUNC.SELECT2
4 PRINT SELECT

1. In the SETTING window, select "10 OPTIONAL."
 - The OPTIONAL window will appear.

2. Select any option from the following options list:

1 FUNC.PROHIBIT.:	Function prohibition
2 FUNC.SELECT1:	Function selection 1
3 FUNC.SELECT2:	Function selection 2
4 PRINT SELECT:	Printing selection

The following illustration shows those options included in the optional feature programming group.

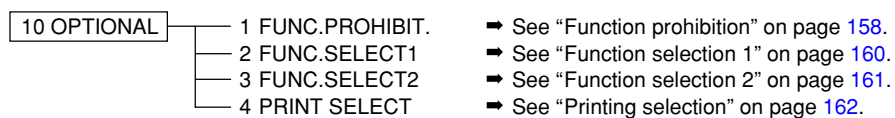

■ Function prohibition

Your POS terminal allows you to select whether to enable or disable various functions.

Program each item as follows:

- **OPX/Z REPORT (Use the selective entry)**

- DISABLE: Disables the server report printing in the OP X/Z mode.
- ENABLE: Enables the server report printing in the OP X/Z mode.

- **PAID OUT (Use the selective entry)**

- LIMITED: Allowed only in the MGR mode.
- PUBLIC: Allowed in the REG and MGR modes.

- **RFND SALES (Use the selective entry)**

- LIMITED: Allowed only in the MGR mode.
- PUBLIC: Allowed in the REG and MGR modes.

- **(-) ENTRY (Use the selective entry)**

- LIMITED: Allowed only in the MGR mode.
- PUBLIC: Allowed in the REG and MGR modes.

- **RF/RETURN (Use the selective entry)**

- LIMITED: Allowed only in the MGR mode.
- PUBLIC: Allowed in the REG and MGR modes.

- **1st LAST VD (Use the selective entry)**

- DISABLE: Disables first-item direct void.
- ENABLE: Enables first-item direct void.

- **DIRECT VD (Use the selective entry)**

- LIMITED: Allowed only in the MGR mode.
- PUBLIC: Allowed in the REG and MGR modes.

- **INDIR. VD (Use the selective entry)**

- LIMITED: Allowed only in the MGR mode.
- PUBLIC: Allowed in the REG and MGR modes.

- **SBTL VOID (Use the selective entry)**

- LIMITED: Allowed only in the MGR mode.
- PUBLIC: Allowed in the REG and MGR modes.

- **VOID MODE (Use the selective entry)**

- LIMITED: Allowed only in the MGR mode.
- PUBLIC: Allowed in the REG and MGR modes.

- **NO SALE (Use the selective entry)**

- LIMITED: Allowed only in the MGR mode.
- PUBLIC: Allowed in the REG and MGR modes.

- **PAY WHEN ST=0 (Use the selective entry)**

- DISABLE: Disables finalization in the REG mode when the subtotal is zero.
- ENABLE: Enables finalization in the REG mode when the subtotal is zero.

- **TIP PAID (Use the selective entry)**

- LIMITED: Allowed only in the MGR mode.
- PUBLIC: Allowed in the REG and MGR modes.

- **TRANS IN/OUT (Use the selective entry)**

- LIMITED: Allowed only in the MGR mode.
- PUBLIC: Allowed in the REG and MGR modes.

Procedure

FUNC. PROHIBIT		↓
OPX/Z REPORT	ENABLE	
PAID OUT	PUBLIC	
RFND SALES	PUBLIC	
(-) ENTRY	PUBLIC	
RF/RETURN	PUBLIC	
1st LAST VD	ENABLE	

The screen continues.

■ Function prohibition (continued)

- **P.VD IN GLU (Use the selective entry)**

DISABLE: Disables the indirect void/refund/return entry with in the GLU re-order.

ENABLE: Enables the indirect void/refund/return entry with in the GLU re-order.

- **OPEN GLU DISP (Use the selective entry)**

DISABLE: Does not displays GLU currently opened automatically.

ENABLE: Displays and recalls the GLU balances currently opened automatically.

- **UPC LEARNING (Use the selective entry)**

DISABLE: Disables the UPC learning function.

ENABLE: Enables the UPC learning function.

- **PRICE CHANGE (Use the selective entry)**

LIMITED: Allowed only in the MGR mode.

PUBLIC: Allowed in the REG and MGR modes.

- **CUSTOMER OPN (Use the selective entry)**

LIMITED: Allowed only in the MGR mode.

PUBLIC: Allowed in the REG and MGR modes.

■ Function selection 1

Your POS terminal enables you to select various functional settings.

Program each item as follows:

- **ITEM VP (Use the selective entry)**

- DISABLE: Disables item validation printing.
- ENABLE: Enables item validation printing.

- **RF/RT VP (Use the selective entry)**

- COMPUL.: Compulsory refund/return validation printing.
- NON-COMPUL.: Non-compulsory refund/return validation printing.

- **(-) VP (Use the selective entry)**

- COMPUL.: Compulsory minus entry validation printing.
- NON-COMPUL.: Non-compulsory minus entry validation printing.

- **CA/CHK V (Use the selective entry)**

- COMPUL.: Compulsory cashing a check validation printing.
- NON-COMPUL.: Non-compulsory cashing a check validation printing.

- **RA VP (Use the selective entry)**

- COMPUL.: Compulsory RA validation printing.
- NON-COMPUL.: Non-compulsory RA validation printing.

- **PO VP (Use the selective entry)**

- COMPUL.: Compulsory PO validation printing.
- NON-COMPUL.: Non-compulsory PO validation printing.

- **TIP VP (Use the selective entry)**

- COMPUL.: Compulsory tip validation printing.
- NON-COMPUL.: Non-compulsory tip validation printing.

- **L.SFT TYPE <Level shift type> (Use the selective entry)**

- MANUAL: Lock shift mode
- AUTO: Automatic return mode

- **LEVEL SHIFT (Use the selective entry)**

- LIMITED: Allowed only in the MGR mode.
- PUBLIC: Allowed in the REG and MGR modes.

- **PR.SFT TYPE <Price shift type> (Use the selective entry)**

- MANUAL: Lock shift mode
- AUTO: Automatic return mode

- **PRICE SHIFT (Use the selective entry)**

- LIMITED: Allowed only in the MGR mode.
- PUBLIC: Allowed in the REG and MGR modes.

- **RETURN TO L1 <Return to level 1> (Use the selective entry)**

When the PLU level shift system is set to "AUTO," the PLU level can be returned to level 1 by one of the following methods:

- RECEIPT: Returns the PLU level to level 1 by one receipt.
- BY ITEM: Returns the PLU level to level 1 by one item.

- **RETURN TO P1 <Return to price 1> (Use the selective entry)**

When the PLU price level shift method is set to "AUTO," the price level can be returned to price 1 by one of the following methods:

- RECEIPT: Returns the price level to price 1 by one receipt.
- BY ITEM: Returns the price level to price 1 by one item.

Procedure

FUNC.SELECT1		↓
ITEM VP		ENABLE
RF/RT VP	NON-COMPUL.	
(-) VP	NON-COMPUL.	
CA/CHK V	NON-COMPUL.	
RA VP	NON-COMPUL.	
PO VP	NON-COMPUL.	

The screen continues.

■ Function selection 2

Your POS terminal enables you to select various functional settings.

Program each item as follows:

Procedure

- **SEAT # (Use the selective entry)**

COMPUL.: Compulsory seat number entry (GLU operations)

INHIBIT: Inhibited seat number entry (GLU operations)

- **COVER CT (Use the selective entry)**

COMPUL.: Compulsory cover count entry (GLU operations)

NON-COMPUL.: Non-compulsory cover count entry (GLU operations)

- **TIP ENTRY (Use the selective entry)**

FIX RATE: Tip entry using a programmed rate

AMOUNT: Manual tip entry

- **SRVR DRW (Use the selective entry)**

COMPUL.: Compulsory server drawer assignment at sign-on

INHIBIT: Inhibited server drawer assignment at sign-on

- **SHIFT KEY ACT (Use the selective entry)**

CAPS: Locks the upper-case letter mode once the shift key is pressed.

SHIFT: Shifts the upper-case letter mode to the lower-case letter mode after a letter is entered.

- **AUTO HOURLY (Use the selective entry)**

DISABLE: Disables automatic hourly report.

ENABLE: Enables automatic hourly report.

If "ENABLE" is selected, a hourly report may be issued at hourly intervals automatically.

- **COND. CANCEL (Use the selective entry)**

Select the active mode for the cancel operation from the following.

LIMITED: Allowed only in the MGR mode.

PUBLIC: Allowed in the REG and MGR modes.

- **ISBN PRICE (Use the selective entry)**

Price entry after ISBN/ISSN code entry INHIBIT/COMPUL.

- **CUSTOMER DATA (Use the selective entry)**

TOTAL: Sales total and charge sales total

DETAIL: Detail data (Sales total, charge sales total, sales date, item's name, amount and quantity)

- **SERVER POPUP (Use the selective entry)**

DISABLE: Disables the display of SERVER POPUP sign on window upon 1st item entry.

ENABLE: Enables the display of SERVER POPUP sign on window upon 1st item entry.

- **T-LOG FULL (Use the selective entry)**

LOCK: Locks entries at a terminal when T-LOG buffer becomes full.

CONTINUE: Not locks entries at a terminal even when T-LOG butter becomes full.

- **CAPTURE FUL (Use the selective entry)**

LOCK: Locks entries at a terminal when CAPTURE job memory becomes full.

CONTINUE: Not locks entries at a terminal even when CAPTURE job memory becomes full.

FUNC.SELECT2		↓
SEAT#		INHIBIT
COVER CT	NON-COMPUL.	
TIP ENTRY		AMOUNT
SRVR DRW		INHIBIT
SHIFT KEY ACT		CAPS
AUTO HOURLY		DISABLE

The screen continues.

■ Printing selection

You can program various printing functions.

Procedure

PRINT SELECT	↓
PURCHASE NO.	NO
TIME	YES
JOURNAL SEL.	FULL
JOURNAL SIZE	NORMAL
ITEM ON BILL	YES
SHARE%	YES

The screen continues.

Program each item as follows:

- **PURCHASE NO. (Use the selective entry)**
 - YES: Prints the number of purchases.
 - NO: Does not print the number of purchases.
- **TIME (Use the selective entry)**
 - NO: Does not print the time on the receipt and journal.
 - YES: Prints the time on the receipt and journal.
- **JOURNAL SEL. (Use the selective entry)**
 - PARTIAL: Prints the summary information on the journal.
 - FULL: Prints the detailed information on the journal.
- **JOURNAL SIZE (Use the selective entry)**
 - NORMAL: Prints the normal-size letters on the journal.
 - SMALL: Prints the compressed-size letters on the journal.
- **ITEM ON BILL (Use the selective entry)**
 - NO: Does not print items in a GLU/PBLU transaction on the bill printer.
 - YES: Prints items in a GLU/PBLU transaction on the bill printer.
- **SHARE% (Use the selective entry)**
 - NO: Does not print the share percent in the department report.
 - YES: Prints the share percent in the department report.
- **REORDER KP MSG. (Use the selective entry)**
 - YES: Prints the reorder message on a kitchen printer.
 - NO: Does not print the reorder message on a kitchen printer.
- **CUSTOMER REP. (Use the selective entry)**
 - Non-payment customer report format
 - DETAIL: Detail data
 - CHARGE: Charge amount data
- **BIRTHDAY (Use the selective entry)**
 - YES: Prints the entered birthday.
 - NO: Does not print entered birthday.
- **TX STATUS RJ (Use the selective entry)**
 - Taxable status printing on R/J
 - (YES/NO)
- **TX STATUS BILL (Use the selective entry)**
 - Taxable status printing on Bill (Slip)
 - (YES/NO)
- **TX STATUS KP (Use the selective entry)**
 - Taxable status printing on KP
 - (YES/NO)

Secret Code Programming

Use the following procedure to program a secret code:

Procedure

SETTING	↑↓
07 PERSONNEL	
08 TERMINAL	
09 DATE/TIME	
10 OPTIONAL	
11 SECRET CODE	
12 REPORT	



SECRET CODE
1 Z1
2 PGM2
3 SYS Z1
4 SYS PGM2
5 INITIAL D/L
6 MAINTEN. D/L

1. In the SETTING window, select "11 SECRET CODE."
 - The SECRET CODE window will appear.

2. Select any option from the following options list:

1 Z1:	Z1 reports
2 PGM2:	PGM2 operations
3 SYS Z1:	System Z1 reports
4 SYS PGM2:	System PGM2 operations
5 INITIAL D/L:	Initial down-loading
6 MAINTEN. D/L:	Maintenance down-loading

The following illustration shows those options included in the secret code programming group.

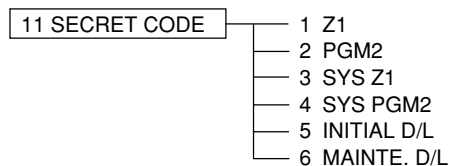

- ➔ See "Z1 reports" on page [164](#).
- ➔ See "PGM2-mode operations" on page [164](#).
- ➔ See "System Z1 reports" on page [165](#).
- ➔ See "System PGM2-mode operations" on page [165](#).
- ➔ See "Initial down-loading" on page [166](#).
- ➔ See "Maintenance down-loading" on page [166](#).

■ Z1 reports

You can assign a secret code to each report.

Secret code: max. 4 digits (0001 to 9999/0000) **(Use the numeric entry)**

NOTE If "0" is entered, the "compulsory secret code entry" will be canceled.

Procedure

Z1	↓
DEPARTMENT	0000
PLU	0000
PLU BY DEPT	0000
DYNAMIC UPC	0000
D-UPC BY DEPT	0000
TRANSACTION	0000

The screen continues.

Program each item as follows:

DEPARTMENT	Department report
PLU	PLU report
PLU BY DEPT	PLU by department report
DYNAMIC UPC	Dynamic UPC report
D-UPC BY DEPT	Dynamic UPC by department report
TRANSACTION	Transaction report
POSITIVE#	Positive number report
ALL SERVER	All server report
IND. SERVER	Individual server report
HOURLY	Hourly report
GLU	GLU report
GLU BY SERVER	GLU by server report
CLOSED GLU	Closed GLU report
CL-GLU BY SERVER	Closed GLU by server report
STACKED REPORT	Stacked report
NON ACCESS UPC	Non-access UPC
D-UPC CLEAR	Dynamic UPC clear report
D-UPC CLR DEPT	Dynamic UPC clear by dept. report
CAT	CAT
RESERVED	Reserved

■ PGM2-mode operations

You can assign a secret code to each programming operation in the PGM2 mode.

Secret code: max. 4 digits (0001 to 9999/0000) **(Use the numeric entry)**

NOTE If "0" is entered, the "compulsory secret code entry" will be canceled.

Procedure

PGM2	↓
ARTICLE	0000
DIRECT KEY	0000
PLU MENU KEY	0000
FUNCTION	0000
MEDIA	0000
TEXT	0000

The screen continues.

Program each item as follows:

ARTICLE	Article programming
DIRECT KEY	Direct key programming
PLU MENU KEY	PLU menu key programming
FUNCTION	Function programming
MEDIA	Media programming
TEXT	Text programming
PERSONNEL	Personnel programming
TERMINAL	Terminal programming
DATE/TIME	Date/time programming
OPTIONAL	Optional programming
SECRET CODE	Secret code programming
REPORT	Report programming
LOGO TEXT	Logo programming
DEVICE CONFIG	Device configuration programming
GLU CODE	GLU code programming
TAX	Tax programming
CUSTOMER	Customer programming
NEGATIVE#	Negative number programming
POSITIVE#	Positive number programming
MACRO KEY	Macro key programming
FUNC. MENU KEY	Function menu key programming
CAPTURE KEY	Capture key programming
CAPTURE JOB#	Capture job programming
TRAINING	Training mode
DATA SEND	Backup data send
DATA RECEIVE	Backup data receive

■ System Z1 reports

You can assign a secret code to each system report.

Secret code: max. 4 digits (0001 to 9999/0000) **(Use the numeric entry)**

NOTE If "0" is entered, the "compulsory secret code entry" will be canceled.

Procedure

SYS Z1		↓
DEPARTMENT	0000	
PLU	0000	
PLU BY DEPT	0000	
DYNAMIC UPC	0000	
D-UPC BY DEPT	0000	
TRANSACTION	0000	

The screen continues.

Program each item as follows:

DEPARTMENT	Department report
PLU	PLU report
PLU BY DEPT	PLU by department report
DYNAMIC UPC	Dynamic UPC report
D-UPC BY DEPT	Dynamic UPC by department report
TRANSACTION	Transaction report
POSITIVE#	Positive number report
ALL SERVER	All server report
IND. SERVER	Individual server report
HOURLY	Hourly report
GLU	GLU report
GLU BY SERVER	GLU by server report
CLOSED GLU	Closed GLU report
CL-GLU BY SERV	Closed GLU by server report
STACKED REPORT	Stacked report

■ System PGM2-mode operations

You can assign a secret code to each system programming operation in the PGM2 mode.

Secret code: max. 4 digits (0001 to 9999/0000) **(Use the numeric entry)**

NOTE If "0" is entered, the "compulsory secret code entry" will be canceled.

Procedure

SYS PGM2		↓
DATA CLEAR	0000	
KP SETTING	0000	
ONLINE SETTING	0000	
CVM SETTING	0000	
CAT SETTING	0000	
RESERVED	0000	

The screen continues.

Program each item as follows:

DATA CLEAR	Data clear operation
KP SETTING	Kitchen printer setting
ONLINE SETTING	Online setting
CVM SETTING	CVM setting
CAT SETTING	CAT setting
RESERVED	Reserved
MWS SETTING	Manager work station setting
INLINE SETTING	Inline setting

■ Initial down-loading (with clearing of memory)

You can assign a secret code to each preset data to be downloaded.

Secret code: max. 4 digits (0001 to 9999/0000) **(Use the numeric entry)**

NOTE If "0" is entered, the "compulsory secret code entry" will be canceled.

Procedure

INITIAL D/L	↓
DEPT	0000
DIRECT KEY	0000
PLU/UPC	0000
PLU MENU KEY	0000
LINK PLU	0000
CONDIMENT	0000

The screen continues.

Program each item as follows:

DEPT	Department preset
DIRECT KEY	Direct department/PLU preset
PLU/UPC	PLU/UPC preset
PLU MENU KEY	PLU menu key preset
LINK PLU	Link PLU preset
CONDIMENT	Condiment PLU preset
MIX&MATCH	Mix & Match preset
COMBO MEAL	Combo meal preset
UPC NON-PLU	UPC Non-PLU code format
TRANSACTION	Transaction preset
SERV. SIGN OFF	All server sign off
OPTION	Other preset
DATE/TIME	Date/time preset
LOGO	Logo text preset
DEF. MENU LEVEL	Default menu level
TAX	Tax preset
NEGATIVE#	Negative number preset
POSITIVE#	Positive number preset
MACRO KEY	Macro key preset
FUNC. MENU KEY	Function menu key preset
CAPTURE KEY	Capture key preset
CAPTURE JOB#	Capture job preset
ONLINE PRESET	Online preset
INLINE PRESET	Inline preset
KP PRESET	Kitchen printer preset
DEVICE CONFIG	Device configuration preset
ALL PGM	All PGM preset

■ Maintenance down-loading (without clearing of memory)

You can assign a secret code to each preset data to be downloaded.

Secret code: max. 4 digits (0001 to 9999/0000) **(Use the numeric entry)**

NOTE If "0" is entered, the "compulsory secret code entry" will be canceled.

Procedure

MAINTN. D/L	↓
DEPT	0000
DEPT PRICE	0000
DEPT CVM DATA	0000
PLU/UPC	0000
PLU PRICE	0000
PLU CVM DATA	0000

The screen continues.

Program each item as follows:

DEPT	Department preset
DEPT PRICE	Department price preset
DEPT CVM DATA	Dept. CVM data
PLU/UPC	PLU/UPC preset
PLU PRICE	PLU price preset
PLU CVM DATA	PLU CVM data
LINK PLU	Link PLU preset
CONDIMENT	Condiment PLU preset
MIX&MATCH	Mix & Match preset
COMBO MEAL	Combo meal preset
COMBO CVM DATA	Combo CVM data
TRANSACTION	Transaction preset
POSITIVE#	Positive number preset

Report Programming

Use the following procedure to select any option included in the report group:

Procedure

SETTING	↑↓
07 PERSONNEL	
08 TERMINAL	
09 DATE/TIME	
10 OPTIONAL	
11 SECRET CODE	
12 REPORT	



REPORT
1 0 SKIP
2 HOURLY RPT
3 STACKED RPT

1. In the SETTING window, select "12 REPORT."
 - The REPORT window will appear.

2. Select any option from the following list:

- | | |
|----------------|----------------|
| 1 0 SKIP: | Zero skip |
| 2 HOURLY RPT: | Hourly report |
| 3 STACKED RPT: | Stacked report |

The following illustration shows those options included in the report programming group.



■ Zero skip

You can program whether or not to skip “0” sales totalizer in each report.

Procedure

0 SKIP	
SERVER	SKIP
TRANSACTION	SKIP
DEPARTMENT	SKIP
PLU/UPC	SKIP
HOURLY	SKIP
DAILY NET	SKIP

Program each item as follows:

- **SERVER (Use the selective entry)**
 - NOT SKIP: Does not skip those data that are “0” sales in the server report.
 - SKIP: Skips those data that are “0” sales in the server report.
- **TRANSACTION (Use the selective entry)**
 - NOT SKIP: Does not skip those data that are “0” sales in the transaction report.
 - SKIP: Skips those data that are “0” sales in the transaction report.
- **DEPARTMENT (Use the selective entry)**
 - NOT SKIP: Does not skip those data that are “0” sales in the department report.
 - SKIP: Skips those data that are “0” sales in the department report.
- **PLU/UPC (Use the selective entry)**
 - NOT SKIP: Does not skip those data that are “0” sales in the PLU/UPC report.
 - SKIP: Skips those data that are “0” sales in the PLU/UPC report.
- **HOURLY (Use the selective entry)**
 - NOT SKIP: Does not skip those data that are “0” sales in the hourly report.
 - SKIP: Skips those data that are “0” sales in the hourly report.
- **DAILY NET (Use the selective entry)**
 - NOT SKIP: Does not skip those data that are “0” sales in the daily net report.
 - SKIP: Skips those data that are “0” sales in the daily net report.

■ Hourly report

You can program the memory type and the starting time for the hourly report.

Procedure

HOURLY RPT	
MEMORY TYPE	30MIN
STARTING TIME	00

Program each item as follows:

- **MEMORY TYPE (Use the selective entry)**
 - 15MIN: Selects the 15-minute type.
 - 30MIN: Selects the 30-minute type.
 - 60MIN: Selects the 60-minute type.
- **STARTING TIME (Use the numeric entry)**
 - Starting time entry (max. 2 digits: 0 to 23)

■ Stacked report

Your POS terminal is equipped with the stacked report printing function that enables multiple X/Z reports to be printed in sequence with a single request.

Procedure

Select a stacked report no. from the stacked reports list.

```

REPORT 1 ↓
01
02
03
04
05
06
  
```

The screen continues.

```

01 ↓
01 DEPARTMENT
02 DEPT. IND. GROUP
03 DEPT. GR. TOTAL
04 M-DOWN DEPT.
05 PLU/UPC
06 PLU BY DEPT
  
```

The screen continues.

You can select a maximum of twenty reports from the stacked reports list. Some reports can be set their parameters such as "START CODE" and "END CODE."

- **01 DEPARTMENT (Use the numeric entry)**
Full department report
Parameter: Start department code/end department code (1 thru 50)
- **02 DEPT.IND.GROUP (Use the numeric entry)**
Individual group report on departments
Parameter: Department group no. (1 thru 9)
- **03 DEPT.GR. TOTAL**
Full group total report on departments
- **04 M-DOWN DEPT. (Use the numeric entry)**
Markdown for department report
Parameter: Start department code/end department code (1 thru 50)
- **05 PLU/UPC (Use the numeric entry)**
PLU report by designated range
Parameter: Start PLU code/end PLU code (1 thru 999999)
- **06 PLU BY DEPT (Use the numeric entry)**
PLU report by associated departments
Parameter: Department code (1 thru 50)
- **07 PLU IND. GROUP (Use the numeric entry)**
PLU report by individual group
Parameter: PLU group no. (00 thru 99)
- **08 PLU GR. TOTAL**
Full group total report on PLUs
- **09 PLU STOCK (Use the numeric entry)**
PLU stock report
Parameter: Start PLU code/end PLU code (1 thru 99999)
- **10 PLU MIN. STOCK (Use the numeric entry)**
PLU minimum stock report
Parameter: Start PLU code/end PLU code (1 thru 99999)
- **11 PLU ZERO SALES (Use the selective/numeric entry)**
PLU zero sales report
Parameter: 1 ALL/2 BY DEPT.
When "2 BY DEPT." is selected, enter a department code (1 thru 50).

■ Stacked report (continued)

- **12 PLU CATEGORY (Use the numeric entry)**

PLU price category report

Parameter: Start unit price/end unit price

- **13 DYNAMIC UPC**

Dynamic UPC report

- **14 TRANSACTION**

Transaction report

- **15 CID**

Cash in drawer report

- **16 TAX**

Tax report

- **17 ALL SERVER**

Full server report

- **18 IND. SERVER (Use the numeric entry)**

Individual server report

Parameter: Server code (1 thru 9999)

- **19 HOURLY (Use the numeric entry)**

Hourly report

Parameter: Start time/end time (0 thru 2345)

NOTE

To take the hourly Z report, you have to specify the full-range hourly report.

- **20 POSITIVE CHECK**

Positive check report

- **21 KEY CAPTURE**

Key capture report

- **22 GLU (Use the numeric entry)**

GLU/PBLU report

Parameter: Start GLU code/end GLU code (1 thru 99999999)

- **23 GLU BY SERVER (Use the numeric entry)**

GLU/PBLU report by server

Parameter: Server code (1 thru 9999/Up to 255 servers can be assigned.)

- **24 CLOSED GLU (Use the numeric entry)**

Closed GLU/PBLU report

Parameter: Start GLU code/end GLU code (1 thru 99999999)

- **25 CL-GLU BY SERV (Use the numeric entry)**

Closed GLU/PBLU report by server

Parameter: Server code (1 thru 9999/Up to 255 servers can be assigned.)

■ Stacked report (continued)

- **26 CUSTOM SALES1 (Use the numeric entry)**
Customer report 1
Parameter: Start customer code/end customer code
- **27 CUSTOM SALES2 (Use the numeric entry)**
Customer report 2
Parameter: Start customer code/end customer code
- **28 CHARGE ACCOUNT**
Charge account (customer no payment) report
- **29 NO ACCES. CUST.**
No-access customer report
- **30 DAILY NET**
Daily net report

Logo Text Programming

Use the following procedure to select any option included in the logo text group.

Procedure

SETTING	↑↓
13 LOGO TEXT	
14 DEVICE CONFIG	
15 GLU CODE	
16 CUSTOMER	
17 NEGATIVE#	
18 POSITIVE#	



LOGO TEXT
1 RECEIPT LOGO
2 UP TEXT
3 BILL LOGO

1. In the SETTING window, select "13 LOGO TEXT."
 - The LOGO TEXT window will appear.

2. Select any option from the following options list:

- | | |
|-----------------|--------------------------|
| 1 RECEIPT LOGO: | Receipt logo |
| 2 VP TEXT: | Validation printing text |
| 3 BILL LOGO: | Bill logo |

The following illustration shows those options included in the logo text programming group.



■ Receipt logo

Your POS terminal can print programmed messages for customers on every receipt.

Procedure



Program the item as follows:

- **RECEIPT LOGO (Use the character entry)**

Logo text for the receipt (max. 30 characters x 6 lines)

NOTE

The programmable number of lines for a message varies according to the message type: the "3-line header message" type, "3-line footer message" type, "6-line header message" type and "Stamp only" type. Please contact your authorized SHARP dealer.

■ Validation printing text

Your POS terminal can print programmed validation messages.

Procedure

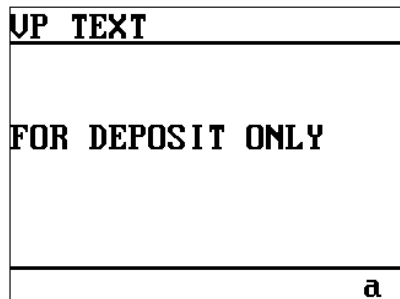

Program the item as follows:

- **VP TEXT (Use the character entry)**

Text for the validation slip (max. 30 characters x 3 lines)

Device Configuration Programming

Use the following procedure to select a device configuration programming:

Procedure

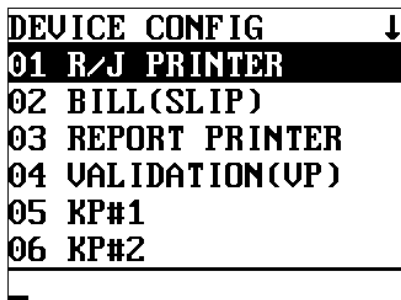
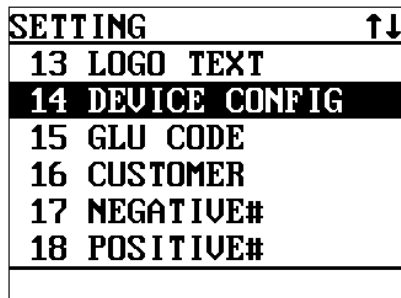

The screen continues.

1. In the SETTING window, select "14 DEVICE CONFIG."
 - The DEVICE CONFIG window will appear.

2. Select any option from the following options list:

- | | |
|---------------------|---|
| 01 R/J PRINTER: | Receipt/Journal Printer (Bult-in printer) |
| 02 BILL (SLIP): | Bill (Slip) printer |
| 03 REPORT PRINTER: | Report printer |
| 04 VALIDATION (VP): | Validation printer |
| 05 KP#1: | Remote printer #1 |
| 06 KP#2: | Remote printer #2 |
| 07 KP#3: | Remote printer #3 |
| 08 KP#4: | Remote printer #4 |
| 09 KP#5: | Remote printer #5 |
| 10 KP#6: | Remote printer #6 |
| 11 KP#7: | Remote printer #7 |
| 12 KP#8: | Remote printer #8 |
| 13 KP#9: | Remote printer #9 |
| 14 BCR(SCANNER): | Scanner |

The following illustration shows those options included in the device configuration programming group.

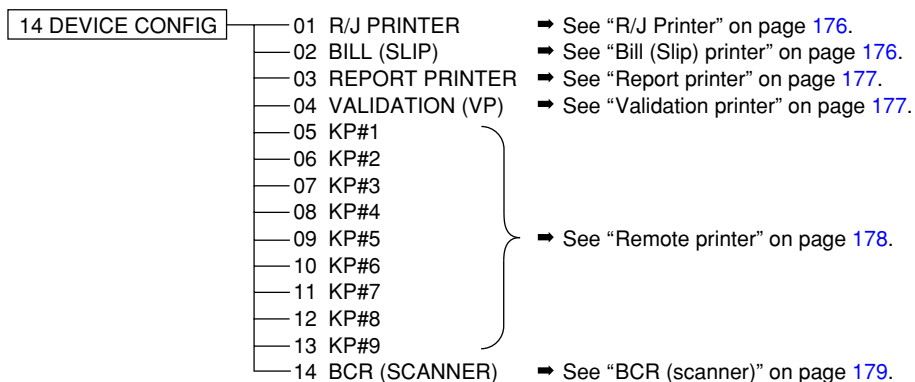

■ R/J printer (Built-in printer)

Procedure

R/J PRINTER	
LIGHT&SHADE	50
IMAGE FOOT NOT PRINT	
PRINT BUFFERING	
TRAY ST FEED#	0

Program each item as follows:

- **LIGHT&SHADE (Use the numeric entry)**
Select a light and shade level. (00 to 99)
00: 65% for standard
50: 100% <standard>
99: 135% for standard
- **IMAGE FOOT (Use the selective entry)**
PRINT: Prints footer graphic logo.
NOT PRINT: Not print footer graphic logo.
- **PRINT (Use the selective entry)**
BUFFERING: The receipt/journal prints the recapitulated data at the finalization.
REAL TIME: The receipt/journal print each data at same time when each item is entered.
- **TRAY ST FEED# (Use the numeric entry)**
Tray subtotal feed line (0 to 9)

■ Bill (slip) printer

Procedure

BILL(SLIP)	
PRINTER	TM-295
AUTO CUTTER	NO
INITIAL FEED#	00
SLIP MAX LINE	99

Program each item as follows:

- **PRINTER (Use the selective entry)**
Select the printer to be used.
EPSON TM-295 EPSON TM-T88/85
EPSON TM-T80 EPSON TM-U200
EPSON TM-T88(2) EPSON TM-300
- **AUTO CUTTER (Use the selective entry)**
Auto cutter function
YES: Enables auto cutter function.
NO: Disables auto cutter function.
(This item is invalid for TM-295.)
- **INITIAL FEED# (Use the numeric entry)**
Initial line feed for a slip (0 to 64 lines): only for TM-295
- **SLIP MAX LINE (Use the numeric entry)**
Maximum number of lines printable on a slip (0 to 99): only for TM-295

■ Report printer

Procedure

REPORT PRINTER	
PRINTER	BUILT-IN
AUTO CUTTER	NO
LOGO TEXT	PRINT

Program each item as follows:

- **PRINTER (Use the selective entry)**

Select the printer to be used.

EPSON TM-T80

EPSON TM-U200

EPSON TM-T88/85

EPSON TM-300

EPSON TM-T88(2)

BUILT-IN (built-in printer)

- **AUTO CUTTER (Use the selective entry)**

Auto cutter function

YES: Enables auto cutter function.

NO: Disables auto cutter function.

- **LOGO TEXT (Use the selective entry)**

Select the logo text printing status.

NOT PRINT: Logo text is not printed.

PRINT: Logo text is printed.

■ Validation printer

Procedure

VALIDATION(VP)	
PRINTER	TM-295
VP TIMES	1

Program each item as follows:

- **PRINTER (Use the selective entry)**

Select the printer to be used.

EPSON TM-295

- **VP TIMES (Use the numeric entry)**

Number of times of validation printing (0 thru 9)

■ Remote printer (KP#1 thru KP#9)

Procedure

KP#1	
PRINTER	TM-T88/85
AUTO CUTTER	NO
LOGO TEXT	NOT PRINT

Program each item as follows:

- **PRINTER (Use the selective entry)**

Select the printer to be used.

EPSON TM-U200

EPSON TM-300

EPSON TM-T88/85

EPSON TM-T80

EPSON TM-T88(2)

BUILT-IN (built-in printer)

- **AUTO CUTTER (Use the selective entry)**

Auto cutter function

YES: Enables auto cutter function.

NO: Disables auto cutter function.

- **LOGO TEXT (Use the selective entry)**

Select the logo text printing status.

NOT PRINT: Logo text is not printed.

PRINT: Logo text is printed.

■ BCR (SCANNER)

Procedure

BCR(SCANNER)	
BAUD RATE	4800bps
DATA BITS	7 Bits
PARITY	ODD
STOP BIT	1 Bit

Program each item as follows:

- **BAUD RATE (Use the selective entry)**
Transmission speed (baud rate)
19200 bps/9600 bps/4800 bps
- **DATA BITS (Use the selective entry)**
Data bit: 7 bits/8 bits
- **PARITY (Use the selective entry)**
Parity bit: NON/ODD/EVEN
- **STOP BIT (Use the selective entry)**
Stop bit: 1 bit/2 bits

GLU Code Programming

Use the following procedure to select an option included in the GLU code group:

Procedure

SETTING	↑↓
13 LOGO TEXT	
14 DEVICE CONFIG	
15 GLU CODE	
16 CUSTOMER	
17 NEGATIVE#	
18 POSITIVE#	



GLU CODE
1 GLU



GLU	
START CODE	0001
END CODE	9999

1. In the SETTING window, select "15 GLU CODE."
 - The GLU CODE window will appear.

2. Select any item from the following options list:
 - 1 GLU: GLU/PBLU code

You can program the range of available guest check codes.

Program each item as follows:

- **START CODE (Use the numeric entry)**
Start GLU code (max. 4 digits: 1 to 9999)
- **END CODE (Use the numeric entry)**
End GLU code (max. 4 digits: 1 to 9999)

Customer Programming

Use the following procedure to select any option included in the customer programming group:

Procedure

SETTING	↑↓
13 LOGO TEXT	
14 DEVICE CONFIG	
15 GLU CODE	
16 CUSTOMER	
17 NEGATIVE#	
18 POSITIVE#	



CUSTOMER
1 CUSTOMER
2 CUSTOMER PROG.

1. In the SETTING window, select "16 CUSTOMER".
2. Select an option from the following options list:
 - 1 CUSTOMER: Customer code
 - 2 CUSTOMER PROG.: Customer programming

The following illustration shows those options included in the customer programming group.



■ Customer code

Procedure

Select or enter the pertinent customer code.

Program each item as follows:

- **NAME (Use the character entry)**
Enter a customer's name (max. 16 characters)
- **ADDRESS (Use the character entry)**
On the second line, enter the customer's address (max. 40 characters)

■ Customer programming

Procedure

Program each item as follows:

- **PERIOD:MONTH (Use the numeric entry)**
Preset a period to delete customer detail data.
Enter the period in a unit of month. (01 to 99)
If you enter "00", the customer detail data will not be deleted.

NOTE If the following condition is satisfied, its code is deleted using the deleting operation.

Date of the deleting (Year, Month) \geq Date of the last access (Year, Month) + programmed period + 1

[Ex.] Date of the deleting = 8/(1 to 31)/2002, Period = 12 months:

Customer	Date of the last access		
Customer A	(6/(1 to 30)/2001)	→	Deleted
Customer B	(7/(1 to 31)/2001)	→	Deleted
Customer C	(8/(1 to 31)/2001)	→	Kept intact

Positive Code File Programming

Use the following procedure to select the menu option "18 POSITIVE#":

■ Positive code

You can create/delete the positive code.

Procedure

SETTING ↑↓
13 LOGO TEXT
14 DEVICE CONFIG
15 GLU CODE
16 CUSTOMER
17 NEGATIVE#
18 POSITIVE#



POSITIVE#
---NOTHING---



Selected positive code →



POSITIVE#
#000000000000000001

Program the item as follows:

- **POSITIVE# (Use the numeric entry)**
Positive code (max. 16 digits)

NOTE

- When you create a new code, enter the code, then press the key.
- When you delete a positive code, enter the code or move the cursor to pertinent positive code, then press the key.

Macro Key Programming

Use the following procedure to select the menu option "19 MACRO KEY" :

■ Mode position/Auto key no.

The purpose of the Macro Key Function is to run a series of instructions with a single key stroke. You can program up to 15 max. mode position/auto key no. for each macro key.

Procedure

SETTING	↑↓
19 MACRO KEY	
20 FUNC.MENU KEY	
21 CAPTURE KEY	
22 CAPTURE JOB#	
23 TAX	
24 TRAINING	



MACRO KEY	
1 MACRO#1	
2 MACRO#2	
3 MACRO#3	
4 MACRO#4	

Select a pertinent macro key.



MACRO#1	↓
MODE#1	INHIBIT
KEY#1	INHIBIT
MODE#2	INHIBIT
KEY#2	INHIBIT
MODE#3	INHIBIT
KEY#3	INHIBIT

Program the item as follows:

- **MACRO#1 thru MACRO#4 (Use the selective entry)**

Select the pertinent macro key from the list.

- **MODE#1 thru MODE#15 (Use the selective entry)**

INHIBIT: AUTO key is inhibited.

PGM2: PGM2 mode

PGM1: PGM1 mode

OPXZ: OP X/Z mode

REG: REG mode

MGR: MGR mode

X1Z1: X1/Z1 mode

X2Z2: X2/Z2 mode

- **KEY#1 thru KEY#15 (Use the selective entry)**

INHIBIT: AUTO key is inhibited.

AUTO1 thru AUTO25: AUTO key no.

Function Menu Key Programming

Use the following procedure to select Function menu key programming:

■ Function menu key

You can program a max. of 15 functions for each function menu key.

Procedure

SETTING	↑↓
19 MACRO KEY	
20 FUNC.MENU KEY	
21 CAPTURE KEY	
22 CAPTURE JOB#	

FUNC.MENU KEY	↓
01 INHIBIT	
02 INHIBIT	
03 INHIBIT	
04 INHIBIT	
05 INHIBIT	
06 INHIBIT	

Select menu no. →

01	↓
001 INHIBIT	
002 %1	
003 %2	
004 %3	
005 %4	
006 %5	

Select function →

FUNC.MENU KEY	↓
01 %1	
02 INHIBIT	
03 INHIBIT	

Use the following procedure to program the function menu key.

1. In the SETTING window, select "20 FUNC.MENU KEY".
 - The FUNC.MENU KEY window will appear.

2. Select menu number (01 thru 15).

NOTE

- If the key is pressed on the menu number selection, the function will be canceled.

3. Select function from the following list.

Function no.	Function
001	INHIBIT
002	%1
003	%2
004	%3
005	%4
006	%5
?	?
135	CAP.10

Capture Key Programming

Use the following procedure to select the menu option "21 CAPTURE KEY" :

■ Capture key data

You can program max. 10 data capture key entries for the capture data function.

Procedure

SETTING	↑↓
19 MACRO KEY	
20 FUNC.MENU KEY	
21 CAPTURE KEY	
22 CAPTURE JOB#	
23 TAX	
24 TRAINING	



CAPTURE KEY	↓
01 CAPTURE01	
02 CAPTURE02	
03 CAPTURE03	
04 CAPTURE04	
05 CAPTURE05	
06 CAPTURE06	

The screen continues.

Select a pertinent data capture key.



CAP . 1	
TEXT	CAPTURE01
TEXT PRINT	NO
ENTRY COMPUL	NO
LINK JOB#	00
a	

Program the item as follows:

- **CAPTURE01 thru 10 (Use the selective entry)**
Select the desired data capture key from the list.
- **TEXT (Use the character entry)**
Description for the data capture key. Up to 12 characters can be entered.
- **TEXT PRINT (Use the selective entry)**
YES: Print the data capture key TEXT on R/J or bill.
NO: Does not print the data capture key TEXT.
- **ENTRY COMPUL (Use the selective entry)**
Enforcing the data capture key.
BEGIN: Enforced at the beginning of transaction.
END: Enforced at the end of the transaction.
NO: Not enforced-assigned key data function no.
- **LINK JOB# (Use the numeric entry)**
Capture job number (1 to 99)

Key Data Entry Job Table Programming

Use the following procedure to select the menu option "22 CAPTURE JOB#" :

■ Capture job number

You can program a max. of 99 capture job numbers.

Procedure

SETTING		↑↓
19	MACRO KEY	
20	FUNC.MENU KEY	
21	CAPTURE KEY	
22	CAPTURE JOB#	
23	TAX	
24	TRAINING	



CAPTURE JOB#	
---NOTHING---	



Select a pertinent job number. →



01		↓
MESSAGE		
ENTRY#1	INHIBIT	
MAX.LENGTH#1	13	
MIN.LENGTH#1	00	
TEXT PRINT#1	NO	
MESSAGE		
		a

The screen continues.

Program the item as follows:

- **CAPTURE JOB# (Use the selective entry)**
Select the pertinent capture Job number. (1 to 99)
- **MESSAGE (Use the character entry)**
Description for the job (display message). Up to 12 characters can be entered.
(for job#1 thru 4)
- **ENTRY#1 thru 4 (Use the selective entry)**
Data entry type
 NUMERIC: Numeric data type
 CHARACTER: Character data type
 INHIBIT: Data entry is inhibited.
- **MAX. LENGTH#1 thru 4 (Use the numeric entry)**
Max. length of data entry (0 to 13)
"0" means the ENTER key entry only.
- **MIN. LENGTH#1 thru 4 (Use the numeric entry)**
Min. length of data entry (0 to 13)
- **TEXT PRINT#1 thru 4 (Use the selective entry)**
 YES: Prints the entry data on R/J or Bill printer.
 NO: Does not print the entry data.

NOTE

- If the key is pressed on the job number selection menu, the selected job table will be deleted.

Tax Programming

Use the following procedure to select any option included in the tax group:

Procedure

SETTING	↑↓
19 MACRO KEY	
20 FUNC.MENU KEY	
21 CAPTURE KEY	
22 CAPTURE JOB#	
23 TAX	
24 TRAINING	



TAX
1 TAX1
2 TAX2
3 TAX3
4 TAX4

1. In the SETTING window, select "23 TAX."
 - The TAX window will appear.

2. Select any option from the following options list:

1 TAX1:	Tax1
2 TAX2:	Tax2
3 TAX3:	Tax3
4 TAX4:	Tax4
5 DOUGHNUT EXPT:	Doughnut exemption (for the Canadian tax system)

NOTE

- The option "5 DOUGHNUT EXPT" appears only when the Canadian tax system is selected.
- If the **[DEL]** key is pressed on the tax number selection menu, the tax table or the tax in the cursor position will be deleted.

The following illustration shows those options included in the tax programming group.

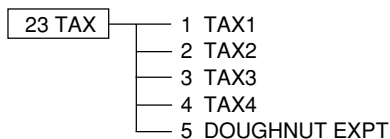

- ➔ See "Table tax" on page 190 or "Rate (%) tax" on page 192.
- ➔ See "Table tax" on page 190 or "Rate (%) tax" on page 192.
- ➔ See "Table tax" on page 190 or "Rate (%) tax" on page 192.
- ➔ See "Table tax" on page 190 or "Rate (%) tax" on page 192.
- ➔ See "Doughnut tax exempt" on page 192.

■ Table tax

Your POS terminal has an automatic tax calculation feature which allows you to program four tax tables. Automatic tax calculations require you to program, in addition to the tax table, the tax status of each pertinent department, PLU, and function key.

Sample tax table

New Jersey tax table: 6%

Tax	Range of sales amount		A: Difference between a minimum breakpoint and the next one (¢)	
	Minimum breakpoint	Maximum breakpoint		
.00	.01	to .10	-	
.01 -T	.11 -Q	to .22	10 (0.11 - 0.01)	B: Non-cyclic
.02	.23	to .38	12 (0.23 - 0.11)	
.03	.39	to .56	16 (0.39 - 0.23)	
.04	.57	to .72	18 (0.57 - 0.39)	
.05	.73	to .88	16 (0.73 - 0.57)	C: Cyclic 1
.06	.89	to 1.10	16 (0.89 - 0.73)	
.07	1.11 -M1	to 1.22	22 (1.11 - 0.89)	
.08	1.23	to 1.38	12 (1.23 - 1.11)	
.09	1.39	to 1.56	16 (1.39 - 1.23)	
.10	1.57	to 1.72	18 (1.57 - 1.39)	
.11	1.73	to 1.88	16 (1.73 - 1.57)	D: Cyclic 2
.12	1.89	to 2.10	16 (1.89 - 1.73)	
.13	2.11 -M2	to 2.22	22 (2.11 - 1.89)	

To program a tax table, first make a table like the right table shown above.

From the tax table, calculate the differences between a minimum breakpoint and the next one (A). Then, from the differences, find irregular cycles (B) and regular cycles (C and D). These cycles will show you the following items necessary to program the tax table:

- T:** Tax amount collected on the minimum taxable amount (Q)
- Q:** Minimum taxable amount
- M1:** Maximum value of the minimum breakpoint on a regular cycle (C).
We call this point "MAX point."
- M2:** Maximum value of the minimum breakpoint on a regular cycle (D).
We call this point "MAX point."
- M:** Range of the minimum breakpoint on a regular cycle: difference between Q and M1 or between M1 and M2

■ Rate (%) tax

You can program a tax rate for each tax rate number.

Procedure

Select a pertinent tax no. from the taxes list.

TAX1
1 TABLE TAX
2 %TAX

%TAX
TAX RATE 0.0000%
LOWER LIMIT 0.00

Program each item as follows:

- **TAX RATE (Use the numeric entry)**
Tax rate (max. 7 digits: 0.0000 to 999.9999%)
- **LOWER LIMIT (Use the numeric entry)**
Lowest taxable amount (max. 5 digits: 0.01 to 999.99)

■ Doughnut tax exempt (for the Canadian tax system)

Procedure

DOUGHNUT EXPT
QUANTITY 0

Program the item as follows:

- **QUANTITY (Use the numeric entry)**
Quantity for the doughnut tax exempt (for Canadian tax)
(max. 2 digits: 1 to 99/0)

NOTE

This option is available only when the Canadian tax system is selected.

TRAINING Mode Selection

Use the following procedure to select the training mode:

■ TRAINING mode

You will use the TRAINING mode if you need to train someone in machine operations without any change in POS terminal's memory. Reports are not available. When the training is completed, exit this mode and put your POS terminal back into the normal mode of operation.

Procedure

SETTING	↑↓
19 MACRO KEY	
20 FUNC.MENU KEY	
21 CAPTURE KEY	
22 CAPTURE JOB#	
23 TAX	
24 TRAINING	



TRAINING	
TRAINING MODE	NO

Program the item as follows:

- **TRAINING MODE (Use the selective entry)**

YES: Allows entering the training mode.

NO: Disallows entering the training mode.

NOTE

- All operations in the training mode are the same as the REG-mode operations.
- In the training mode, the consecutive number is incremented.
- The cash drawer does not open in the training mode.
Items normally sent to the remote printers are not sent.

Backup Data Send Programming

Use the following procedure to select the menu option "25 BACKUP SEND":

NOTE

For more information, please consult your authorized SHARP dealer.

Backup data send

Your POS terminal can send data to another device for the purpose of backing its program up.

Procedure

SETTING	↑
21 CAPTURE KEY	
22 CAPTURE JOB#	
23 TAX	
24 TRAINING	
25 BACKUP SEND	
26 BACKUP RECEIVE	



BACKUP SEND	
SEND DATA	ALL RAM
SPEED	PROGRAMMED

Program each item as follows:

• SEND DATA (Use the selective entry)

Select one of the following options (data sources):

- ALL RAM
- SSP

• SPEED (Use the selective entry)

Select one of the following options (data transmission speeds):

PROGRAMMED: Sends data at a programmed speed.

115200bps: Sends data at 115200 bps.

57600bps: Sends data at 57600 bps.

38400bps: Sends data at 38400 bps.

19200bps: Sends data at 19200 bps.

9600bps: Sends data at 9600 bps.

4800bps: Sends data at 4800 bps.

2400bps: Sends data at 2400 bps.

Backup Data Receive Programming

Use the following procedure to select the menu option "26 BACKUP RECEIVE":

NOTE

For more information, please consult your authorized SHARP dealer.

■ Backup data receive

Your POS terminal can receive data from another device which has previously received the data.

Procedure

SETTING	↑
21 CAPTURE KEY	
22 CAPTURE JOB#	
23 TAX	
24 TRAINING	
25 BACKUP SEND	
26 BACKUP RECEIVE	



BACKUP RECEIVE	
SPEED	PROGRAMMED

Program the item as follows:

• SPEED (Use the selective entry)

Select one of the following options (data transmission speeds):

PROGRAMMED: Receives data at a programmed speed.

115200bps: Receives data at 115200 bps.

57600bps: Receives data at 57600 bps.

38400bps: Receives data at 38400 bps.

19200bps: Receives data at 19200 bps.

9600bps: Receives data at 9600 bps.

4800bps: Receives data at 4800 bps.

2400bps: Receives data at 2400 bps.

CAUTION: The receiving unit must have equal or greater memories than the terminal sending the program.

PLU Updating (in the PGM1 Mode)

The PLU UPDATE option is chiefly used for daily changes of the PLU's unit price or name by a supervisor or manager.

Procedure

PGM1
1 READING
2 SETTING
3 PLU UPDATE



PLU/UPC	↓
00001	
PL00001	
00002	
PL00002	
00003	
PL00003	



00001
PRICE 1 0.00
1# PL00001
KP1 PL00001

To program a unit price or name for the PLU as follows:

1. In the PGM1 window, press the  key or select the option "3 PLU UPDATE".
 - The PLU list will appear.
2. Select any PLU code from the list.
3. Program a unit price or name for the corresponding price level.
 - ***PRICE1 thru 6 (Use the numeric entry)**
Unit price of each price level (max. 6 digits)
 - ***1# thru 6 (Use the character entry)**
Name of each price level. Up to 8 or 16 characters can be entered.
 - ***KP1 thru 6 (Use the character entry)**
Description of text for kitchen printer for each price level. Up to 12 characters can be entered.

NOTE

* On the sample screen, the price level 1 setting is only shown. Depending on the default settings, you may see the price level 1 through 6 settings on the screen. Please consult your authorized SHARP dealer for more details.

Automatic Sequencing Key Programming

If you program frequently performed key operations for the AUTO keys, you can enter those key operations simply by pressing the corresponding AUTO keys in key operations.

Procedure

Select "03 AUTO KEY" from the PGM2 window.

AUTO KEY

PUSH AUTO KEY

01

01

01	7	KEY
02	0	KEY
03	0	KEY
04	P00009	
05	CA/AT	

To program an automatic sequencing key as follows:

1. Press the automatic sequencing key which you want to program.

AUTO
1

2. Enter the desired sequence to use the automatic sequencing key in the programmed sequence.

700 → 9 → CA/AT

3. Press the automatic sequencing key again.

AUTO
1

4. Press the CANCEL key to finalize the programming.

Loading Dynamic UPC to the Main UPC File

The UPC master file (main file) can be updated by loading the data recorded in the dynamic UPC file to the UPC master file.

Procedure

For loading dynamic UPC:

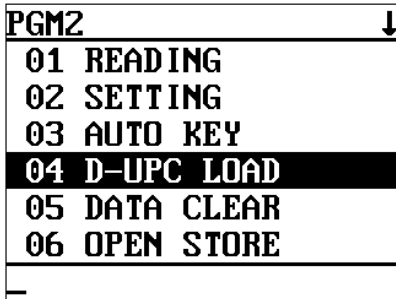

PGM2 ↓

01 READING
02 SETTING
03 AUTO KEY
04 D-UPC LOAD
05 DATA CLEAR
06 OPEN STORE

1. Select "4 D-UPC LOAD" from the PGM2 window.

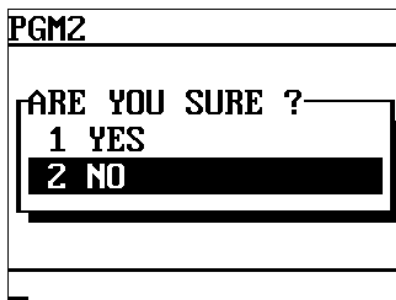

PGM2

ARE YOU SURE ?

1 YES
2 NO

2. Select "YES" or "NO", and press the key.

Reading of Stored Programs

You can read programs stored in the PGM1 or PGM2 mode.

■ Program reading sequence

To read those programs stored in the PGM1 or PGM2 mode, use the following procedure:

1. Place the mode key to the PGM1 or PGM2 position.
2. Select "01 READING" from the PGM1 or PGM2 mode window to display the items list.
3. Select an item listed in the table shown later.
4. Where "RANGE" and/or "PICK UP" are displayed on the screen, select either option. Select "RANGE" to read program by range, and "PICK UP" to read program by picking up codes. The procedure to specify a range or to pick up codes are the same as the one in sales report.
On the table, for the item you can specify a range, "*1" is indicated, and for the item you can pick up codes, "*2" is indicated.

Item:	Description:	Available mode:
1 DEPARTMENT *1	Department	PGM1 or PGM2
2 PLU/UPC *2	PLU/UPC	PGM1 or PGM2
3 DYNAMIC UPC *2	Dynamic UPC	PGM1 or PGM2
4 LINK PLU TABLE *1	Link PLU table	PGM2
5 CONDIMENT TBL. *1	Condiment table	PGM2
6 MIX&MATCH	Mix-and-match table	PGM2
7 COMBO MEAL *1	Combo meal table	PGM2
8 UPC OTHER	UPC others	PGM2
9 SCALE TABLE	Scale table	PGM2
10 FUNCTION	Function	PGM1 or PGM2
11 MEDIA	Media key	PGM2
12 SERVER	Server	PGM1 or PGM2
13 OPTIONAL	Optional feature	PGM2
14 FUNCTION TEXT	Function text	PGM2
15 DEPT. GROUP	Department group	PGM2
16 PLU GROUP	PLU/UPC group	PGM2
17 SERVER GROUP	Server group	PGM2
18 TEXT	Text	PGM2
19 TAX	Tax	PGM2
20 GLU CODE	GLU	PGM2
21 CUSTOMER *1	Customer	PGM2
22 CUSTOMER PROG.	Customer programming	PGM2
23 NEGATIVE #	Negative no.	PGM2
24 POSITIVE #	Positive no.	PGM2
25 AUTO KEY	Automatic sequencing key	PGM2
26 MACRO KEY	Macro key	PGM2
27 CAPTURE KEY	Capture key	PGM2
28 CAPTURE JOB#	Capture job	PGM2
29 DEVICE CONFIG	Device configuration	PGM2
30 DIRECT KEY	Direct key	PGM2
31 FUNC. MENU KEY	Function menu key	PGM2
32 PLU MENU KEY	PLU menu key	PGM2

■ Sample printouts

• Departments (PGM1 or PGM2 mode)

Date	08/26/2002	123456	Machine number
Consecutive number	#1003	8:01PM	JACK0001 Server name/server code
Operating mode*	*PGM2*		Time
Report type	DEPARTMENT		
Dept. code	D01	10. 00	Key data entry job no.
Item label	HUMBURG	G1	Unit price
Tax status	T1	A00	Group no.
	000003	000	Age limitation
Server group no.	S1	40	CVM control character
	D02	L17/10	HALO/LALO
	DPT. 02	0. 00	Print station
Group discount status (1/2/3)	00	G0	Function programming
	000001	A00	0 0 0 0 3
	S0	00	Type of unit price entry (open & preset/preset/open/inhibit)
	D03	L17/10	Gas/BR/Hash/Normal
	DPT. 03	0. 00	SIF/SICS/Normal
	00	G0	Scale status (compulsory/enable/inhibit)
	000001	A00	Tara table no.
	S0	00	Validation printing (compulsory/non-compulsory)
	D04	L17/10	
	0. 00		
	D10	-0. 00	Minus department
	DPT. 10	G0	
	00	A00	
	000001	000	
	S0	KP00000	
		L17/10	

* When you take this report in the PGM1 mode, the PGM2 indication is replaced by a "PGM1."

• PLU/UPC (PGM1 or PGM2 mode)

Report type
Dept. code
PLU code
Item label for price level 1
Zero price (allowed/disallowed)
Item label for price level 2
Item label for price level 3
Item label for price level 4
Item label for price level 5
Item label for price level 6
Condiment table no.
Tax status
Mix & match table no.
Link PLU table no.
Scale table no.
Coupon object PLU
Print station
Kitchen printer text for price 1
Kitchen printer text for price 2
Kitchen printer text for price 3
Kitchen printer text for price 4
Kitchen printer text for price 5
Kitchen printer text for price 6

08/26/2002 123456
#1007 8:02PM JACK001

PGM2
PLU/UPC

P00001	(02)	0			
MILK			1.25	Price level 1	
COKE			0.80	Price level 2	
COFFEE			2.50	Price level 3	
TEA			2.70	Price level 4	
WINE			5.00	Price level 5	
JUICE			1.50	Price level 6	
T1	G00 00 00		A00	Age limitation	
M00 C00			00	Key data entry job no.	
#00 TO		000 000002	PG0 40	CVM control character	
P00000	KP00000	0 M	0	Minimum stock q'ty	
S				Priority group no.	
MK				Stock q'ty	
CK					
CF					
TE					
WN					
JC					
P00002	(01)		/ 0	Function programming	0 0 0 0 2
PL00002				Mode parameter	(open & preset/preset/open/inhibit)
				Scale status	(compulsory/allowed/prohibited)
				Condiment entry to menu item	(compulsory/non-compulsory)
				Condiment type/ non-condiment type	
				Price shift (compulsory/prohibited/allowed)	
				Repeat round (Yes/no)	

Group nos.
Base q'ty
PLU's menu type
Blank : Normal PLU
L : Link PLU
C : Combo meal

(for UPC)
Blank: Auto delete
* : No delete

NOTE The UPC codes are printed out in the sequence shown below.

UPC-A
UPC-E
EAN-13
EAN-8

• Link PLU table (PGM2 mode)

08/26/2002		123456
#1017	8:05PM	JACK0001
PGM2		
LINK PLU TABLE		
#01		P00011
		P00012
		P00013
		P00014
		P00015
#02		P00016
		P00017

Report type
Link PLU table no.
Assigned PLU codes

• Mix & Match table (PGM2 mode)

08/26/2002		123456
#1021	8:05PM	JACK0001
PGM2		
MIX&MATCH		
#01	/ 3	5.75
#02	/ 5	11.25
#03	/12	250.00

Report type
Mix & Match table no.
Price
Base q'ty

• Condiment table (PGM2 mode)

08/26/2002		123456
#1019	8:05PM	JACK0001
PGM2		
CONDIMENT TBL.		
#01	/3	P00007
		P00008
		P00009
		P00010
#02	/2	#02
		P00003
		P00004
		P00005

Report type
Condiment table no.
Assigned PLU codes
Next table#

Number of repeats

• Dynamic UPC (PGM2 mode)

08/26/2002		123456
#1012	8:03PM	JACK0001
PGM2		
DYNAMIC UPC		
5067891234506#(03) / 0		
ITEM-N1		
1		1. 10
ITEM-N2		
0		1. 50
ITEM-N3		
0		1. 20
ITEM-N4		
0		2. 10
ITEM-N5		
0		1. 70
ITEM-N6		
0		1. 30
G00 00 00 A00		
M00 C00 00		
#00 TO 000 000002		
P00000 KP00000 PGO 00		
IT-1		
IT-2		
IT-3		
IT-4		
IT-5		
IT-6		

• Combo meal table (PGM2 mode)

08/26/2002		123456
#1027	8:10PM	JACK0001
PGM2		
COMBO MEAL		
#01	CHICKEN COMBO	
	CKN CB	
	COO 0 00	
KP00000	PGO 00	
	P00018	
	1.20	
	1.30	
	P00019	
	2.10	
	2.15	
	P00020	
	1.75	
	1.75	

Report type
 Combo table no.
 Combo meal text
 Kitchen printer text
 Condiment entry to menu item (compulsory/non-compulsory)
 Print station/Priority group no./CVM control character
 Associated PLU text
 Associated PLU unit price (PRICE1)
 Associated PLU upsized price (PRICE2)

Condiment table no.

• Scale tare table (PGM2 mode)

08/26/2002		123456
#1029	8:10PM	JACK0001
PGM2		
SCALE TABLE		
#1		2.75
#2		3.50
#3		12.00
#4		0.00
#5		0.00
#6		0.00
#7		0.00
#8		0.00
#9		0.00

Report type
 Scale table no.
 Weight

• UPC other (PGM2 mode)

08/26/2002		123456
#1031	8:11PM	JACK0001
PGM2		
UPC OTHER		
UPC NON-PLU		
20		5 4 0 1 2
02		4 5 0 1 2
UPC DELETE		
		99

• Functions (PGM1 or PGM2 mode)

08/26/2002 123456		#1035 8:15PM JACK0001	
PGM2			
FUNCTION			
(-) 1		-1.00	
I T1	RO	L17	
000		00	
		P00001	
		P00002	
		P00003	
		P00004	
		P00005	
(-) 2		-2.00	
S	RO	L17	
000		00	
		P00001	
		P00002	
%1		-10.00%	
I		L 20.00%	
000		00	
		P00010	
		P00011	
%2		-0.00%	
S		L100.00%	
000		00	
GD1 ST		-0.00%	
GD1SC%2		L100.00%	
00		00	
GD2 ST		-0.00%	
GD2SC%3		L100.00%	
00		00	
GD3 ST		-0.00%	
GAS(-)1		L100.00%	
GAS1 ST		0.000	
GAS19 ST		-0.00%	
GRATUITY			
CA TIP		0.00%	
		L17	
CH TIP		L18	
***RA		00	
		000	
***RA2		L18	
		00	
		000	
***PO		L18	
		00	
***PO2		L18	
		00	
M-TAX		L17	
		00	
TAX DEL.		00	
NO SALE		00	
DIR VD		00	
PAST VD		00	
SBTL VD		00	
REFUND		00	
RETURN		00	

• Media (PGM2 mode)

08/26/2002 123456		#1037 8:19PM JACK0001	
PGM2			
MEDIA			
CASH		KP0000 L18	
		0000000000 00	
		00000000	
		000000000001	
CHECK1		KP0000 L18	
		0000000000 00	
		0000000000	
		000000000001	
CHARGE1		KP0000 L18	
CHARGE1-		0000000000 00	
		0000000000	
		000000000001	
FS TEND		KP0000	
		0000000000 00	
		00	
		000000000001	
CONV 1		0.0000	
CONV 2		0.0000	
CONV 3		0.0000	
CONV 4			
EAT IN 1			
EAT IN 2			
EAT IN 3			
SERVICE		KP0000	
		000 00	
		000000000001	
FINAL		KP0000	
		000 00	
		000000000001	
****CID		999999.99	
CHK/CG		999999.99	
CA/CHK1		999999.99	
		00000001	
CA/CHK2		999999.99	
		00000001	
CA/CHK3		999999.99	
		00000001	
CA/CHK4		999999.99	
		00000001	
CA/CHK5		999999.99	
		00000001	

• Server (PGM1 or PGM2 mode)

```

08/26/2002 123456
#1042 8:20PM JACK0001

*PGM2*
SERVER
SRV#0001 JACK
RANGE 1-10
GLU#1 33
GLU#2 35
0.00%
SRV#0002 OD1 (0000)
RANGE 11-20 JIM
GLU#1 30
0.00%

SRV#0014 SERV. 014
RANGE 1-9999
0.00% OD1 (0000)
SRV#0015 SERV. 015
RANGE 1-9999
0.00% OD1 (0000)
    
```

Report type
Server code
Server name
Linked GLU codes
Function programming
Net sales %

• Customer (PGM2 mode)

```

08/26/2002 123456
#1075 8:49PM JACK0001

*PGM2*
CUSTOMER
#0000000000020
NAME-20
ADDRESS-20
#0000000000075
NAME-75
ADDRESS-75
    
```

• Customer control (PGM2 mode)

```

08/26/2002 123456
#1078 8:49PM JACK0001

*PGM2*
CUSTOMER PROG.

99
    
```

• Negative no. (PGM2 mode)

```

08/26/2002 123456
#1080 8:49PM JACK0001

*PGM2*
NEGATIVE#
#000000000000123 0
#000000000000135 1
#0000000000003050 0
    
```

• Positive no. (PGM2 mode)

```

08/26/2002 123456
#1081 8:49PM JACK0001

*PGM2*
POSITIVE#
#0000000000003030
#0000000000006651
#0000000000007752
    
```

• Optional features (PGM2 mode)

```

08/26/2002 123456
#1046 8:27PM JACK001

*PGM2*
OPT I O N A L

OPT I O N A L
FUNC. PROHIBIT
OPX/Z REPORT          ENABLE
PAID OUT              PUBLIC
RFND SALES            PUBLIC
(-) ENTRY             PUBLIC
RF/RETURN             PUBLIC
1st LAST VD          ENABLE
DIRECT VD            PUBLIC
INDIR. VD            PUBLIC
SBTL VOID             PUBLIC
VOID MODE            PUBLIC
NO SALE              PUBLIC
PAY WHEN ST=0        ENABLE
TIP PAID             PUBLIC
TRANS IN/OUT         PUBLIC
P. VD IN GLU         ENABLE
OPEN GLUDISP         DISABLE
UPC LEARNING         ENABLE
PRICE CHANGE         PUBLIC
CUSTOMER OPN         PUBLIC

FUNC. SELECT1
ITEM VP              ENABLE
RF/RT VP            NON-COMPUL.
(-) VP              NON-COMPUL.
CA/CHK VP           NON-COMPUL.
RA VP               NON-COMPUL.
PO VP               NON-COMPUL.
TIP VP              NON-COMPUL.
L. SFT TYPE         AUTO
LEVEL SHIFT         PUBLIC
PR. SFT TYPE        AUTO
PRICE SHIFT         PUBLIC
RETURN TO L1        BY ITEM
RETURN TO P1        BY ITEM

FUNC. SELECT2
SEAT#                INHIBIT
COVER CT             NON-COMPUL.
TIP ENTRY            AMOUNT
SRVR DRW             INHIBIT
SHIFT KEY ACT        CAPS
AUTO HOURLY          DISABLE
COND. CANCEL         PUBLIC
ISBN PRICE           COMPUL.
CUSTOMER DATA       DETAIL
SERVER POPUP         DISABLE
T-LOG FULL           CONTINUE
CAPTURE FULL         CONTINUE
    
```

Report type

Setting

```

PRINT SELECT
PURCHASE NO.        NO
TIME                YES
JOURNAL SEL.        FULL
JOURNAL SIZE        NORMAL
ITEM ON BILL        YES
SHARE%              YES
REORDER KP MSG      YES
CUSTOMER REP.       CHARGE
BIRTHDAY            YES
TX STATUS RJ        NO
TX STATUS BILL      NO
TX STATUS KP        NO

INTERVAL TIMER
TILL TIMER          0
SCREEN SAVE         0

DEF. MENU LEVEL
DEF. MENU LEVEL     1

AVAILABLE GLU#
START CODE          1
END CODE            9999

BILL NUMBER
BILL NUMBER         0000

O SKIP
SERVER              SKIP
TRANSACTION         SKIP
DEPARTMENT          SKIP
PLU/UPC             SKIP
HOURLY              SKIP
DAILY NET           SKIP

HOURLY RPT
MEMORY TYPE         30
STARTING TIME       00

STACKED RPT
1
DEPARTMENT          01-10
PLU BY DEPT         01
DEPT. GR. TOTAL

2
PLU CATEGORY        5.00 - 15.00

HOURLY
GLU                 1- 100
    
```

To be continued

• Function text (PGM2 mode)

```

08/26/2002 123456
#1048      8:30PM JACK001

*PGM2*
FUNCTION TEXT

NET 1      NET 1
TAX1 ST    TAX1 ST
GRS TAX1   GRS TAX1
RFD TAX1   RFD TAX1
TAX1       TAX1
TX1 EXPT   TX1 EXPT
TAX2 ST    TAX2 ST
GRS TAX2   GRS TAX2
RFD TAX2   RFD TAX2
TAX2       TAX2
TX2 EXPT   TX2 EXPT
TAX3 ST    TAX3 ST
GRS TAX3   GRS TAX3
RFD TAX3   RFD TAX3
TAX3       TAX3
TX3 EXPT   TX3 EXPT
TAX4 ST    TAX4 ST
GRS TAX4   GRS TAX4
RFD TAX4   RFD TAX4
TAX4       TAX4
TX4 EXPT   TX4 EXPT
GRS MTAX   GRS MTAX
RFD MTAX   RFD MTAX
GST EXPT   GST EXPT
PST TTL    PST TTL
GST TTL    GST TTL
TTL TAX    TTL TAX
FS TX1     FS TX1
FS TX2     FS TX2
FS TX3     FS TX3
NET        NET
NET2       NET2
COMBO1     COMBO1
  
```

Report type
 Function text (default)
 Text (preset)

```

*DEPT TL   *DEPT TL
DEPT (-)   DEPT (-)
*GAS TL    *GAS TL
GAS (-)    GAS (-)
SUBTOTAL   SUBTOTAL
  
```

To be continued

```

MOSE ST    MOSE ST
***TOTAL   ***TOTAL
CHANGE     CHANGE
DUE        DUE
TIP DUE    TIP DUE
TRAY TL    TRAY TL
FS ST      FS ST
FS TEND    FS TEND
FS CG      FS CG
ITEMS      ITEMS
BALANCE    BALANCE
COPY       COPY
B. T.      B. T.
B. S.      B. S.
SLIP PR.   SLIP PR.
FIN. BAL   FIN. BAL
BAL FWD    BAL FWD
CLOSE CK   CLOSE CK
OPEN CK    OPEN CK
(%) SALES  (%) SALES
SEAT#      SEAT#
VAT EXPT   VAT EXPT
IND. PAY   IND. PAY
TARE WT.   TARE WT.
RCP S.W.   RCP S.W.
FREE GLU   FREE GLU
WASTE      WASTE
AVE SALE   AVE SALE
ST (-) TL  ST (-) TL
ST % TL    ST % TL
(-) TL     (-) TL
% TL       % TL
GDISC%TL   GDISC%TL
GASDISTL   GASDISTL
CASH TL    CASH TL
RA TL      RA TL
PO TL      PO TL
CA/CK TL   CA/CK TL
CONV TL    CONV TL
CHR TL     CHR TL
CHECK TL   CHECK TL
COMBO      COMBO
WASTE      WASTE
RF         RF
CP         CP
NET SLS    NET SLS
COMBO TL   COMBO TL
WASTE TL   WASTE TL
RF TL      RF TL
NET TL     NET TL
TBL#       TBL#
SIGN-ON    SIGN-ON
SIGN-OFF   SIGN-OFF
  
```

• Department group text (PGM2 mode)

08/26/2002		123456
#1051	8:37PM	JACK0001
PGM2		
DEPT.	GROUP	Report type
DPT GR-1	DPT GR-1	Function text (default)
DPT GR-2	DPT GR-2	Text (preset)
DPT GR-3	DPT GR-3	
DPT GR-4	DPT GR-4	
DPT GR-5	DPT GR-5	
DPT GR-6	DPT GR-6	
DPT GR-7	DPT GR-7	
DPT GR-8	DPT GR-8	
DPT GR-9	DPT GR-9	

• Server group text (PGM2 mode)

08/26/2002		123456
#1056	8:41PM	JACK0001
PGM2		
SERVER	GROUP	Report type
GROUP1	GROUP1	Function text (default)
GROUP2	GROUP2	Text (preset)
GROUP3	GROUP3	
GROUP4	GROUP4	
GROUP5	GROUP5	
GROUP6	GROUP6	
GROUP7	GROUP7	
GROUP8	GROUP8	
GROUP9	GROUP9	

• PLU group text (PGM2 mode)

08/26/2002		123456
#1053	8:39PM	JACK0001
PGM2		
PLU	GROUP	Report type
PLU GR01	PLU GR01	Function text (default)
PLU GR02	PLU GR02	Text (preset)
PLU GR03	PLU GR03	
~ ~ ~ ~ ~		
PLU GR97	PLU GR97	
PLU GR98	PLU GR98	
PLU GR99	PLU GR99	

• Logo text (PGM2 mode)

```

08/26/2002 123456
#1066      8:47PM JACK0001

*PGM2*
TEXT ----- Report type

RECEIPT LOGO
SHARP
PRESENTS THE
UP-700
SHARP
IS THE
BEST
----- Receipt logo text

VP TEXT

FOR DEPOSIT ONLY

BILL LOGO
HEADER ----- Header text for
bill printer

FOOTER ----- Footer text for
bill printer

MESSAGE TEXT
1 MESSAGE 1 00
2 MESSAGE 2 00
3 MESSAGE 3 00
4 MESSAGE 4 00
5 MESSAGE 5 00
    
```

• GLU code (PGM2 mode)

```

08/26/2002 123456
#1070      8:47PM JACK0001

*PGM2*
GLU CODE ----- Report type

GLU ----- Start code
1-9999 ----- End code
    
```

• Tax rate (PGM2 mode)

```

08/26/2002 123456
#1068      8:47PM JACK0001

*PGM2*
TAX ----- Report type

TAX1 ----- Tax no.
6.0000 % ----- Rate
/ 1.00 ----- Cycle
1 0.11 ----- Lower tax limit
2 0.23 ----- Breakpoint amount
3 0.39 ----- Breakpoint amount
4 0.57 ----- Breakpoint amount
5 0.73 ----- Breakpoint amount
6 0.89 ----- Breakpoint amount
7 1.11 ----- Breakpoint amount

TAX2 4.0000 % ----- Lower tax limit
0.12 ----- Lower tax limit

TAX3 5.0000 % ----- Lower tax limit
0.20 ----- Lower tax limit

EXPT COUNT ----- Doughnut tax
TAX4 6.0000 % ----- exempt count
0.30 ----- exempt count
    
```

• AUTO key (PGM2 mode)

```

08/26/2002 123456
#1072      8:48PM JACK0001

*PGM2*
AUTO KEY ----- Report type

#01 ----- AUTO key no.
2 KEY ----- Entry sequence
PLU ----- programmed
1 KEY ----- Entry sequence
00 KEY ----- programmed
P00008 ----- Entry sequence

#02 ----- AUTO key no.
P00003 ----- Entry sequence
P00001 ----- Entry sequence

#24 -----
#25 -----
    
```

• Macro key (PGM2 mode)

```

08/26/2002 123456
#1083      8:49PM JACK0001

      *PGM2*
MACRO KEY

MACRO#1
                X1Z1
                AUTO3
                X1Z1
                AUTO5

MACRO#2
                X2Z2
                AUTO6

MACRO#3
                X2Z2
                AUTO7
                X2Z2
                AUTO8

MACRO#4
                PGM2
                AUTO10
    
```

• Capture key (PGM2 mode)

```

08/26/2002 123456
#1087      8:50PM JACK0001

      *PGM2*
CAPTURE KEY

#1      CAPTURE01
                10 00
#2      CAPTURE02
                10 00
#3      CAPTURE03
                10 00
#4      CAPTURE04
                10 00
#5      CAPTURE05
                10 00
#6      CAPTURE06
                10 00
#7      CAPTURE07
                10 00
#8      CAPTURE08
                10 00
#9      CAPTURE09
                10 00
#10     CAPTURE10
                10 00
    
```

• Function menu key (PGM2 mode)

```

08/26/2002 123456
#1085      8:50PM JACK0001

      *PGM2*
FUNC. MENU KEY

01      %1
02      %2
03      %3
04      %4
05      %5
06      (-)1
07      (-)2
08      (-)3
09      (-)4
10      (-)5
11      GDSC%1
12      GDSC%2
13      GDSC%3
14      BIRTH
15      CAP. 1
    
```

• Capture job no. (PGM2 mode)

```

08/26/2002 123456
#1086      8:50PM JACK0001

      *PGM2*
CAPTURE JOB#

#01
                MSG1
                1 13 00 1
                MSG2
                2 13 00 1
                MSG3
                0 13 00 1
                MSG4
                0 13 00 1

#02
                MSG1
                0 13 00 1
                MSG2
                0 13 00 1
                MSG3
                0 13 00 1
                MSG4
                0 13 00 1
    
```

• Device configuration (PGM2 mode)

```

08/26/2002 123456
#1090 8:50PM JACK0001

*PGM2*
DEVICE CONFIG
R/J PRINTER
BILL (SLIP)
REPORT PRINTER
VALIDATION (VP)
KP#1

NOT PRINT
BUFFERING
0
50
---
T#000-C#0
NO
PRINT
BUILT-IN
---
---
---
---
---
---

```

Report type

Image mode

Print mode

Line feed count for tray subtotal

Print shade

Printer type

• Direct key (PGM2 mode)

```

08/26/2002 123456
#1092 8:50PM JACK0001

*PGM2*
DIRECT KEY
001
141
142

L1
L2
L3
L4
L5

P00001
----
----
----
----
----

L1
L2
L3
L4
L5

P00086
----
----
----
----
----

L1
L2
L3
L4
L5

P00100
----
----
----
----
----

```

Report type

Key no.

PLU code

• PLU menu key (PGM2 mode)

```

08/26/2002 123456
#1094 8:51PM JACK0001

*PGM2*
PLU MENU KEY
#01
#02
#05

PLU MENU01
P00001
P00002
P00003
P00004
P00005
P00006
P00007
P00008
P00009
P00010
PLU MENU02
P00011
P00012
P00013
P00014
P00015
P00016
P00017
P00018
P00019
P00020

PLU MENU05
P00001
P00012
P00003
P00014
P00005

```

PLU menu key no.

Title

Menu

PLU

Data Clear

The DATA CLEAR is chiefly used for clearing data such as report data e.g. hourly report, daily net sales, or electronic journal file data in the event some system trouble occurred.

Use the following procedure to perform the data clear operation only when instructed by your authorized SHARP dealer.

Procedure

PGM2	↓
01 READING	
02 SETTING	
03 AUTO KEY	
04 D-UPC LOAD	
05 DATA CLEAR	
06 OPEN STORE	



DATA CLEAR	↓
1 T-LOG	
2 CAPTURE DATA	
3 TRANSACTION	
4 HOURLY	
5 DAILY NET	
6 SIGN ON FLAG	

The screen continues.

1. In the PGM2 mode menu, select "5 DATA CLEAR".
 - The DATA CLEAR window will appear.

2. Select the desired operation.

14

Universal Product Code (UPC) or European Article Number (EAN)

■ UPC or EAN code

Your machine can transact the following codes:

- UPC-A (Number system character: 0, 2, 3, 4)
- UPC-E
- EAN-8
- EAN-13
- Internal code EAN-8/EAN-13

For the codes used for in-store marking, there are two kinds of PLU type (treated as a code like PLU code) and Non-PLU type (price/quantity information is included in the code).

When a code is a non-PLU type, the price/quantity in the code is read for sales entries (in case of quantity, “quantity multiplies preset unit price” is processed to obtain the price.)

UPC-A

- Number system character: 0 <used in the source marking>
- Number system character: 3 <used as NDC or HRI>

For entry, a full 12 digit number or 11 digit number (omitting the check digits) must be entered.

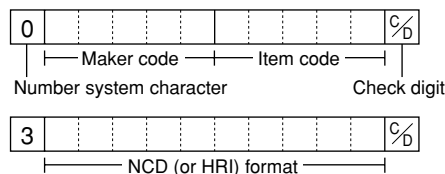

- Number system character: 2 <In-store marking Non-PLU type> You can program the format in “EAN NON-PLU” in ARTICLE setting.
- Number system character: 4 <In-store marking PLU type>

For entry, a full 12 digit number, 11 digit number (omitting the check digit), or a leading zero plus 12 digit number must be entered. (Any number is allowed for the digits marked with *, and on the receipt/journal, non-PLU type code is printed like 2020008**** (****: price information).)

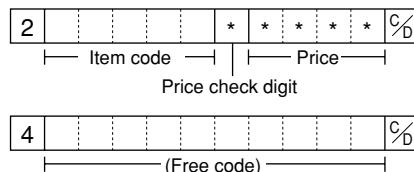

UPC-E

- UPC-E is a zero-suppressed version of UPC-A that conforms to the UPC-E Standards. This code is used for marking small packages.

For entry, a 6 digit number or a leading zero plus 6 digits number must be entered.

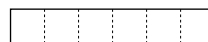

EAN-8

- Ordinary EAN-8 code (flag: neither 0 nor 2) <used in the source marking>

For entry, a full 8 digit number must be entered.

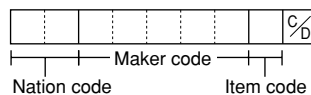

- Internal code (flag 2) <in-store marking non-PLU short type> Program the format in “EAN NON-PLU” in ARTICLE setting.
- Internal code (flag 0) <in-store marking PLU short type>

For entry, a full 8 digit number must be entered. On the receipt/journal, non-PLU type code is printed like 208**** (****: price/quantity information)

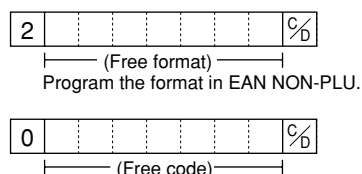

EAN-13

- Ordinary EAN-13 code (used in the source marking)
- Specific EAN-13 code (flag 977, 978, 979) (used in the source marking: ISBM, ISSN)

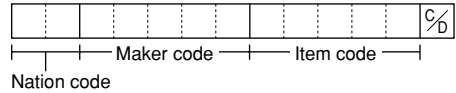

For entry, you must enter a full of 13 digit number.

- Internal code (used for in-store marking, the flag character number: 20 through 29 and 02)
Program the format in “EAN NON-PLU” in ARTICLE setting.

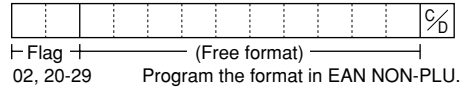

■ Add-on code

UPC-A and EAN-13 may be followed by a two digit number or a five digit number as an add-on code, except the UPC-A without a check digit plus two or five digit add-on code.

Therefore, the total number of digits enterable for sales entries are as shown below:

Code entry	No add-on code	2-digit add-on code	5-digit add-on code
UPC-A	12	14	17
UPC-A w/leading zero	13	15	18
UPC-A w/o check digit	11	—	—
UPC-E	6	—	—
EAN-8	8	—	—
EAN-13	13	15	18

NOTE

Your register automatically judges the add-on code in an EAN code entered from the total number of digits and the flag.

■ UPC file

Your POS terminal has a UPC main file and can provide a Dynamic UPC (D-UPC) file.

UPC main file

In general use, all UPC items are managed in the UPC main file.

The programming data and sales information is recorded in the UPC main file.

Dynamic UPC file

If the dynamic UPC file is allocated, the items entered by the UPC learning function (refer to “UPC learning function” section.) are saved in this file temporarily. (If not generated, they are directly saved in the UPC main file.) The data saved temporarily can be transferred to the UPC main file when necessary by executing the D-UPC LOAD in the PGM2 mode.

If you want to use the dynamic UPC file, please consult your authorized SHARP dealer.

15

Operator Maintenance

In Case of Power Failure

When power is lost, the POS terminal retains its memory contents and all information on sales entries.

- When power failure is encountered while the POS terminal is at an idle state or during an entry, the POS terminal returns to the normal state of operation after power recovery.
- When a power failure is encountered during a printing cycle, the register prints “=====” and then carries out the correct printing procedure after power recovery. (See the sample print.)

08/26/2002	123456
#1116	9:17PM JACK0001
PL00002	\$2.50
DPT.05	\$8.20
=====	----
PL00005	\$7.20
CASH	\$17.90

Power failure symbol

Print after power recovery

In Case of Printer Error

If the printer runs out of paper, the printer will stall, and “PAPER EMPTY” will appear on the display. Key entries will not be accepted. Referring to “Installing and Removing the Paper Roll” in this chapter, install a new paper roll in the proper position, then press the **CL** key. The printer will print the power failure symbol and resume printing.

If the print head comes up, the printer stalls, and “HEAD UP” will appear on the display. Key entries will not be accepted. Bring back the print head to the correct position, then press the **CL** key. The printer will print the power failure symbol and resume printing.

Thermal Printing

Your POS terminal prints by means of thermal printing. The print head applies heat to thermal paper which is chemically treated to change color when heated to a certain level. This creates the printed text.

■ Cautions in handling the printer

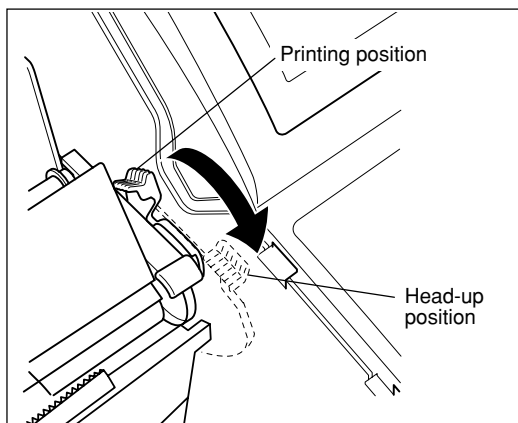

- If you are not going to use the POS terminal for an extended period of time, pull the print head release lever toward you so that the print head is set apart from the plate.

- Avoid the following environments:
 - Dusty and humid places
 - Direct sunlight
 - Iron powder (A permanent magnet and electromagnet are used in this machine.)
- Use the print head release lever only when necessary.
- Never pull the paper when it is in contact with the print head. First release the head with the print head release lever, and then remove the paper.
- Never touch the surface of the print head.
- Never touch around the print head and the motor during printing or before they have had sufficient time to cool.

■ Cautions in handling the recording paper (thermal paper)

- Use only the paper specified by SHARP.
- Do not unpack the thermal paper until you are ready to use it.
- Avoid heat. The paper will color at around 70°C.
- Avoid dusty and humid places for storage. Avoid direct sunlight.
- The printed text on the paper can discolor under the following conditions:
 - Exposure to high humidity and temperature
 - Exposure to the direct sunlight
 - Contact with glue, thinner or a freshly copied blueprint.
 - Heat caused by friction from scratching or other such means.
 - Contact with a rubber eraser or adhesive tape.
- Be very careful when handling the thermal paper. If you want to keep a permanent record, copy the printed text with a photocopier.

Installing and Removing the Paper Roll

■ Recording paper specifications

Be sure to use paper rolls specified by SHARP.

The use of any other paper rolls than specified could cause paper jamming, resulting in a POS terminal malfunction.

Paper specification

Paper width:	2.26 ± 0.02 in. (57.5 ± 0.5 mm)
Max. outside diameter:	3.15 in. (80 mm)
Quality:	Thermal paper
Paper tube:	0.71 in. (18 mm)

- **Be sure to set paper roll(s) prior to using your machine, otherwise it may cause a malfunction.**

Install the paper roll in the printer. Be careful to set the roll and cut the paper end correctly.

NOTE

If the top end of the paper roll is fixed with paste or tape, the paper may lose its color development ability in the pasted or taped area due to the deterioration of the heat-sensitive color development component of the paper surface. This may result in nothing appearing at this location when printing is performed. Therefore, when setting a new paper roll in the machine, be sure to cut off approximately one revolution (approx. 25 cm long).

(How to set the paper roll)

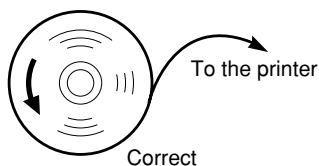
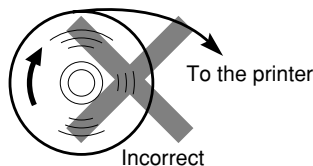

(How to cut the paper end)

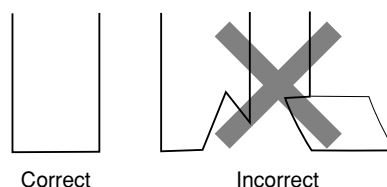

■ Installing the paper roll

Installing the receipt paper roll

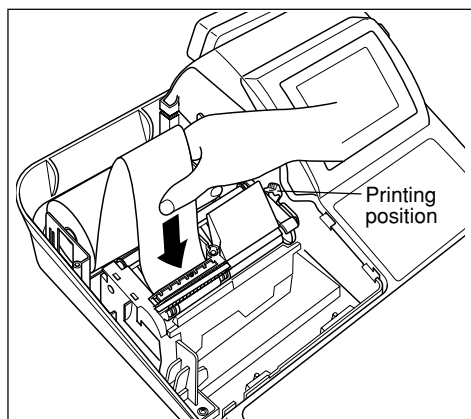

1. Turn the mode switch to the "REG" position with the AC cord connected and the power switch "ON".
2. Remove the printer cover.
3. Check that the print head release lever is in its printing position.
4. Set the paper correctly as illustrated above in the receipt side of the printer.
5. Insert the end of the paper into the paper chute as shown on the left. It will automatically be fed through the printer.
6. Cut off the excess paper that comes out of the printer with the manual cutter.
7. Replace the printer cover.

Installing the journal paper roll

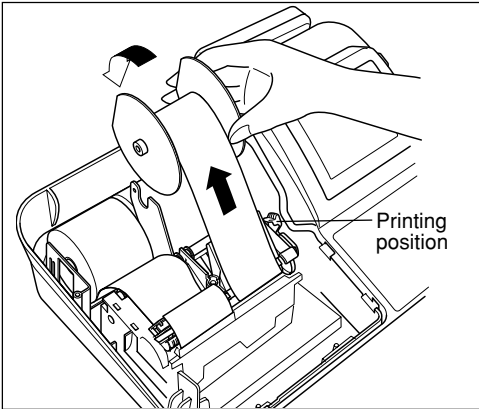

1. Turn the mode switch to the “REG” position with the AC cord connected and the power switch “ON”.
2. Remove the printer cover.
3. Check that the print head release lever is in its printing position.
4. Set the paper correctly as illustrated on the previous page in the journal side of the printer.
5. Insert the end of the paper into the paper chute as shown on the left. It will automatically be fed through the printer.
6. Insert the end of the paper into the slit in the paper take-up spool. (Press the  key to feed more paper through if required.)
7. Wind the paper two or three turns around the spool shaft.
8. Set the spool on the bearing.
9. Replace the printer cover.

• When you want to manually install a new roll of paper while your machine is turned off, follow the steps shown below:

1. Pull the print head release lever toward you to lift up the print head.
2. Correctly place the new paper roll into the receipt/journal paper roll location.
3. Insert the paper end into the paper chute until it comes out of the printer.
4. Cut or roll the paper onto the take-up spool as described for automatic installation.
5. Return the print head release lever to its original position.

■ Removing the paper roll

When a colored dye appears on the paper roll, it is time to replace the existing paper roll. Replace the paper roll with a new one. If you plan not to use your POS terminal for an extended period of time, remove the paper roll, and store it in the appropriate place.

Removing the receipt paper roll

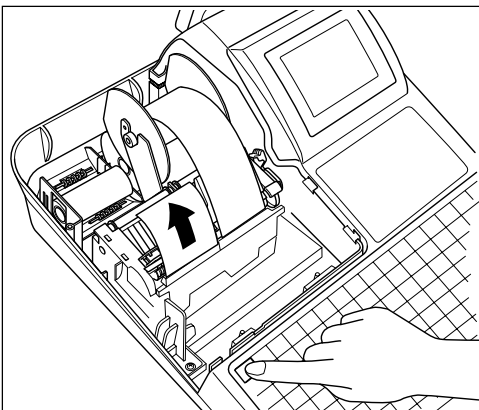

1. Remove the printer cover.
2. Cut the paper behind the printer and near the paper roll.
3. Press the  key until the paper remaining in the printer comes out completely.
4. Remove the paper roll from the back of the printer.

NOTE Do not pull the paper through the printer.

Removing the journal paper roll

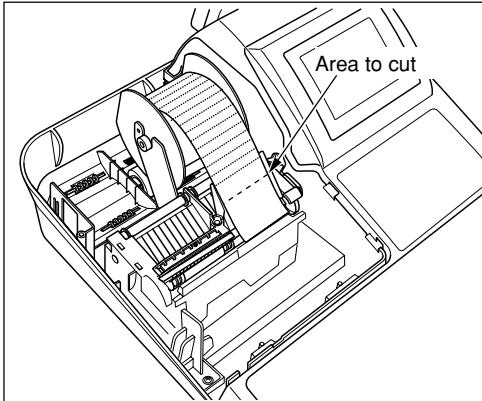

1. Remove the printer cover.
2. Press the  key to advance the journal paper until its printed part is out of the way.
3. Cut the paper and remove the take-up spool.

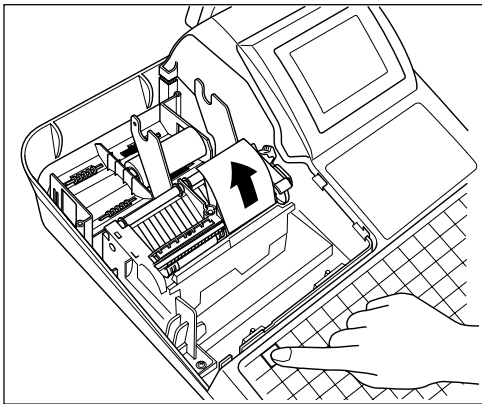

4. Cut the paper behind the printer and near the paper roll.
5. Press the  key until the paper remaining in the printer comes out completely.
6. Remove the paper roll from the back of the printer.

NOTE Do not pull the paper through the printer.

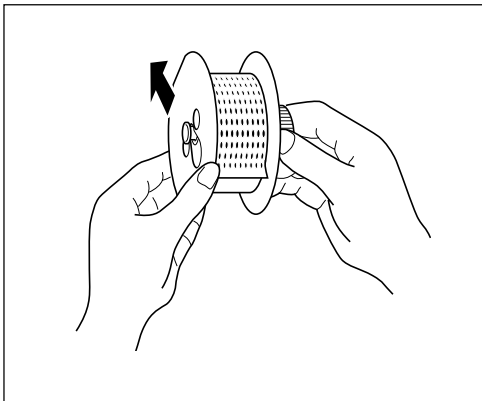

7. Remove the outer side of the take-up spool as shown on the left.

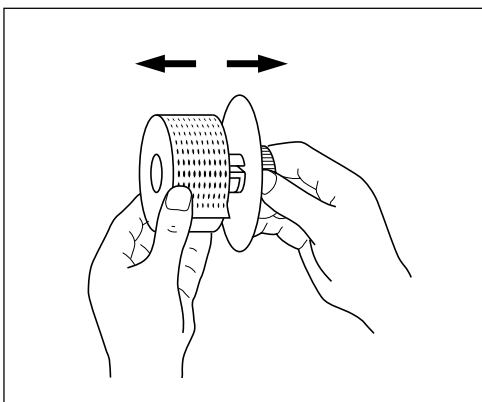

8. Remove the printed journal roll from the take-up spool.

■ Removing a paper jam

Precaution: Be very careful with the manual cutter to avoid cutting yourself. Never touch the print head immediately after printing, because the head may still be hot.

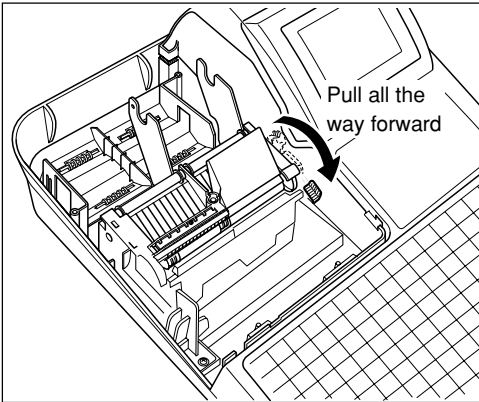

- 1.** Remove the printer cover.
- 2.** Pull the print head release lever all the way forward (after it stops at one position, continue pulling forward until it stops again and cannot be pulled forward any further).
- 3.** Remove the paper jam. Check for and remove any shreds of paper that may remain in the printer.
- 4.** Return the print head release lever to its original position.
- 5.** Reset the paper roll(s) correctly by following the steps in "Installing the paper roll".
- 6.** Replace the printer cover.

Cleaning the Print Head

When the printed text is getting dark or faint, paper dust may be stuck to the print head. Clean the print head as follows:

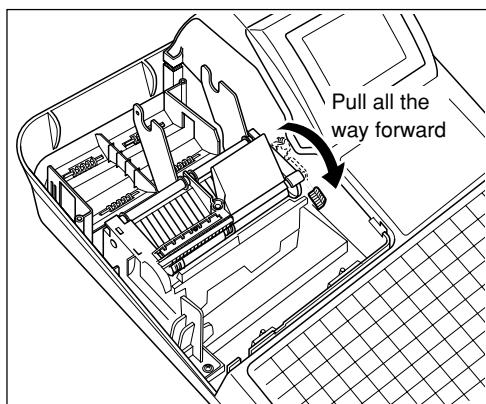

1. Turn the mode switch to the "OFF" position and remove the AC power.
2. Remove the printer cover.
3. Pull the print head release lever all the way forward (after it stops at one position, continue pulling forward until it stops again and cannot be pulled forward any further).

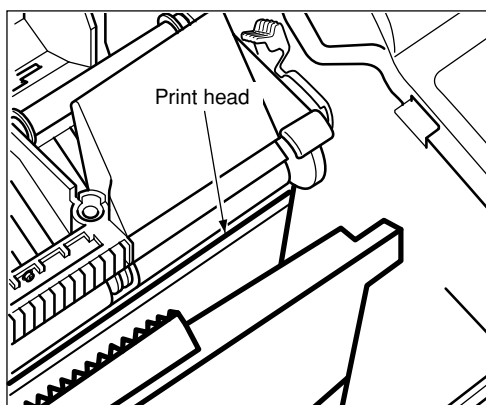

4. Clean the print head with a soft rag moist with ethyl alcohol or isopropyl alcohol.
5. Return the print head release lever to its original position immediately after cleaning.
6. Reset the paper roll(s) correctly by following the steps in "Installing the paper roll".
7. Replace the printer cover.

Precautions:

Never touch the print head with a tool or anything hard as it may damage the head.

Removing the Till and the Drawer

The till in the POS terminal is detachable. After closing your business for the day, remove the till from the drawer and keep the drawer open. To detach the drawer, pull it forward fully with the till removed, and remove it by lifting it up.

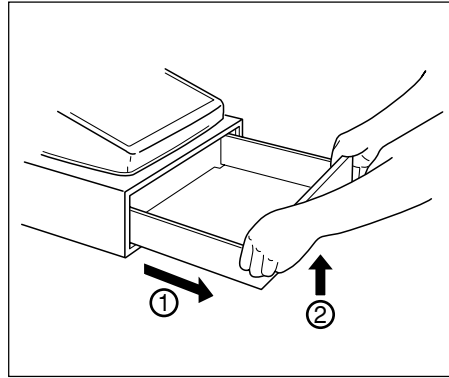
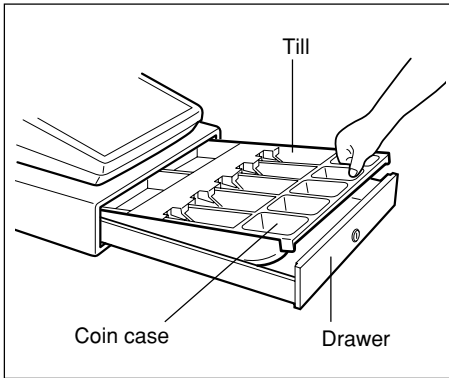

Operating the Drawer by Hand

The drawer automatically opens at the end of a sales transaction. However, when power failure is encountered or the machine becomes out of order, insert the key into the drawer lock and turn it 45 degrees clockwise. (See the figure below.)

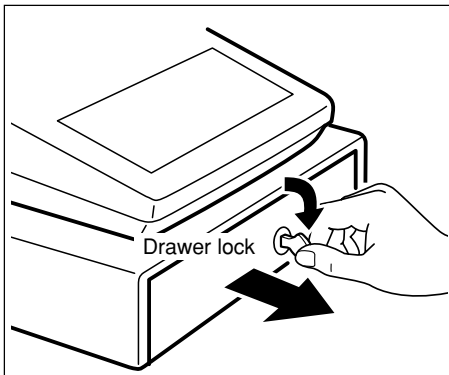

Before Calling for Service

The malfunctions shown in the left-hand column below, labeled “Fault,” do not necessarily indicate functional faults of the machine. It is therefore advisable to refer to the “Checking” section shown in the right-hand column before calling for service.

Fault	Checking
<ul style="list-style-type: none">The display is not illuminated even when the mode switch is turned to any other position than “OFF”.	<ul style="list-style-type: none">Is power supplied to the electric outlet?Is the power cord plug out or loosely connected to the electrical outlet?Is the power switch in the “ON” position?Is the contrast control adjusted correctly?Is the terminal in screen-save mode?
<ul style="list-style-type: none">The display is illuminated, but the whole machine refuses entries.	<ul style="list-style-type: none">Is a server code assigned to the POS terminal?Is the mode switch set properly at the “REG” position?
<ul style="list-style-type: none">No receipt is issued.	<ul style="list-style-type: none">Is the receipt paper roll properly installed?Is there a paper jam?Is the receipt function in the “OFF” status?Is the print head release lever at the printing position?
<ul style="list-style-type: none">No journal paper is taken up.	<ul style="list-style-type: none">Is the take-up spool installed on the bearing properly?Is there a paper jam?
<ul style="list-style-type: none">Printing is unusual.	<ul style="list-style-type: none">Is the print head release lever at the printing position?Is the paper roll properly installed?

16 Options

List of Options

For your UP-700 POS terminal, the following options are available:

For details, contact your authorized SHARP dealer. Do not try to install any options yourself.

- RAM memory board models UP-S02MB, UP-S04MB
- Remote drawer model ER-03DW or ER-04DW
- Magnetic card reader model UP-E13MR
- Remote customer display model UP-P16DP (Pole type)
- Two-port RS-232 interface model ER-A5RS
- Barcode reader model ER-A6HS1

Specifications

Model:	UP-700	
Dimensions:	17.5 (W) x 19.1 (D) x 12.3 (H) in. (445 (W) x 485 (D) x 312 (H) mm)	
Weight:	36.2 lbs. (16.4 kg)	
Power source:	120 V AC \pm 10%, 60 Hz	
Power consumption:	Stand-by:	16W
	Operating:	57W (max.)
Working temperatures:	32 to 104°F (0 to 40°C)	
Electronics:	LSI (CPU) etc.	
Built-in battery:	Rechargeable battery pack, memory holding time of about 1 month (with fully charged built-in battery pack, at room temperature)	
Display:	Operator display:	LCD display 83.18 (W) X 55.18 (H) (0.24 X 0.21 mm/pixel) Dark blue and white
	Customer display:	7-segment display (7 positions)
Printer:	Type:	2-station thermal printer
	Printing speed:	Approx. 17 lines/second
	Printing capacity:	30 digits each for receipt and journal paper
	Other functions:	<ul style="list-style-type: none"> • Graphic logo printing function • Logo message function • Receipt (ON-OFF) function, journal selective function • Receipt and journal independent paper feed function
Paper roll:	Width:	2.26 \pm 0.02 in. (57.5 \pm 0.5 mm)
	Max. diam.:	3.15 in. (80 mm)
	Quality:	High quality (0.06 to 0.08 mm thickness)
Cash drawer:	7 slots for bill and 5 for coin denominations	
Accessories:	Manager key	2
	Submanager key	2
	Operator key	2
	Printer cover lock key	2
	Standard keyboard sheet	1 (placed under keyboard cover)
	Programming keyboard sheet	1 (placed under keyboard cover)
	Paper roll	2
	Take-up spool	1
	Leaflet	1 copy
Drawer lock key	2	
Ferrite cores	3 (used for communications cabling installation)	

* Specifications and appearance subject to change without notice for improvement.

NOTICE

BE SURE TO ASK YOUR AUTHORIZED SHARP DEALER ABOUT THE WARRANTY THAT YOUR SELLING DEALER EXTENDS TO YOU. In order to assure you, the end-user, of warranty protection, Sharp extends a limited warranty to each of its authorized dealers, and in turn requires each of its authorized dealers to extend its own warranty to you on terms that are no less favorable than those given to the dealer by Sharp. You should be aware, however, that Sharp does not itself extend any warranties, either express or implied, directly to you, the end-user, and no one is authorized to make any representations or warranties on behalf of Sharp. Specifically, SHARP DOES NOT EXTEND TO YOU, THE END-USER, ANY EXPRESS WARRANTY OR ANY IMPLIED WARRANTY OF MERCHANTABILITY, FITNESS FOR USE OR FITNESS FOR ANY PARTICULAR PURPOSE IN CONNECTION WITH THE HARDWARE, SOFTWARE, OR FIRMWARE EMBODIED IN OR USED IN CONJUNCTION WITH THIS PRODUCT. Sharp is not responsible for any damages or loss, either direct, incidental or consequential, which you, the end-user, may experience as a result of your purchase or use of the hardware, software or firmware embodied in or used in conjunction with this product. Your sole remedy in the event that you encounter any difficulties with the product is against the authorized dealer from which you purchased the product. In the event that this authorized dealer does not honor its warranty commitments, please contact the Point of Sale Division, ISG, Sharp Electronics Corporation, Sharp Plaza, P.O. Box 650, Mahwah, NJ 07430-2135 so that Sharp can try to help you to assure complete satisfaction of all the warranty rights to which you are entitled from the authorized dealer.

SHARP®

SHARP ELECTRONICS CORPORATION

Sharp Plaza, Mahwah, New Jersey 07430-2135

1-800-BE-SHARP

<http://www.sharp-usa.com>

SHARP CORPORATION