

SHARP®

POS TERMINAL

MODEL

UP-820N

INSTRUCTION MANUAL



WARNING

FCC Regulations state that any unauthorized changes or modifications to this equipment not expressly approved by the manufacturer could void the user's authority to operate this equipment.

Note: This equipment has been tested and found to comply with the limits for a Class A digital device, pursuant to Part 15 of the FCC Rules. These limits are designed to provide reasonable protection against harmful interference when the equipment is operated in a commercial environment.

This equipment generates, uses, and can radiate radio frequency energy and, if not installed and used in accordance with the instruction manual, may cause harmful interference to radio communications. Operation of this equipment in a residential area is likely to cause harmful interference, in which case the user will be required to correct the interference at his own expense.

CAUTION

The AC power socket-outlet should be installed near the equipment and should be easily accessible.

FOR YOUR RECORDS

Please record below the model number and serial number for easy reference in case of loss or theft. These numbers are located on the right side of the unit. Space is provided for further pertinent data.

Model Number _____

Serial Number _____

Date of Purchase _____

Place of Purchase _____

INTRODUCTION

Thank you very much for your purchase of the SHARP POS Terminal Model UP-820N. Please read this Manual carefully before operating your POS terminal in order to gain full understanding of functions and features. Please keep this manual for future reference. It will help you if you encounter any operational problems.

IMPORTANT

- **Avoid installing this terminal in a location that may be subjected to direct radiation, unusual temperature changes, and high humidity or exposure to water or other liquids.**
Installation in such a location could cause damage to the cabinet and the electronic components.
 - **Do not operate this terminal with wet hands.**
This may cause damage to the terminal.
 - **Do not apply excessive pressure to the display. Do not use a sharp-pointed object on the display.**
This may cause damage to the LCD.
 - **When cleaning this terminal, use a dry, soft cloth. Never use solvents, such as benzene or thinner.**
The use of such chemicals will lead to discoloration or deterioration of the cabinet.
 - **The terminal plugs into any standard wall outlet (120V ± 10% AC) with a dedicated earth-ground.**
Other electrical devices on the same electrical circuit could cause the terminal to malfunction.
 - **If the terminal malfunctions, call your local authorized dealer for service. Do not try to repair the terminal yourself.**
 - **For a complete electrical disconnection, remove the AC power cord from the wall outlet.**
 - **This POS terminal uses a nickel metal hydride battery pack for memory protection. The battery pack must be replaced at least every three years at the user's expense. For replacement of the battery pack, please consult your authorized SHARP dealer.**
-

PRECAUTION

This POS terminal has a built-in memory protection circuit which is operated by a rechargeable battery pack. It should be known that all batteries will, in time, dissipate their charge even if not used. Therefore to insure an adequate initial charge in the protection circuit and to prevent any possible loss of memory upon installation, it is recommended that each unit be allowed to be charged for a period of 24 to 48 hours prior to use by the customer.

In order to charge the battery pack, the machine must be plugged in. This charging precaution can prevent unnecessary initial service calls.

BATTERY DISPOSAL

Contains Nickel Metal Hydride Battery. Must be Disposed of Properly.
Contact Local Environmental Officials for Disposal Instructions.

This product utilizes tin-lead solder, and fluorescent lamp containing a small amount of mercury.

Disposal of these materials may be regulated due to environmental considerations.

For disposal or recycling information, please contact your local authorities, the Electronics Industries Alliance: www.eiae.org, the lamp recycling organization: www.lamprecycle.org or Sharp at 1-800-BE-SHARP

(For U.S.A only)

CONTENTS

INTRODUCTION	1
IMPORTANT	1
PRECAUTION	1
1. Part Names and Functions	9
External View	9
Front view	9
Rear view	9
Printer	10
RS232 Connector/SD Card Slot	11
Opening the RS232 connector cover.....	11
Opening the SD card slot cover	11
Keyboard	12
Standard keyboard layout	12
Optional keys	13
Default key texts on the display	15
Drawer lock key	17
Display	17
Operator display	17
Display angle	19
Customer display	20
Display contrast adjustment	20
Screen save mode	20
2. Selecting Operating Mode	21
Operating Modes	21
Mode Selection	22
3. Time Display and Automatic Date Updating	23
4. Receipts	24
Built-in Printer Sample Receipt	24
5. Prior to Entries	25
Preparations for Entries	25
Error Warning	25
Starting Cash Memory Entry	26
6. Entries	27
Server Code Entries	27
Item Selection from the Function Menu Windows	27
Item Entries	30
Single item entries	30
Repeat entries	32
Multiplication entries	33
Split-pricing entries	35
Successive multiplication entries	36
Scale entries	38
Single item Findization (SIF)	40
Age verification (Birthday entry)	41
Special Entries for PLU/UPC	42
Promotion (mix-and-match) function	42
PLU/UPC link entries	42
UPC learning function	43
PLU/UPC price inquiry (view) function	44

UPC price change function	45
PLU level shift (for direct PLUs)	47
PLU price level shift	48
Combo meal entries	49
Condiment entries (for PLU)	49
Repeat round entries	50
Display of Subtotals	51
Merchandise subtotal	51
Taxable subtotal	51
Tax-inclusive subtotal (full subtotal)	51
Tray subtotal	51
Eat-in subtotal	51
Food stamp-eligible subtotal	51
Group discountable subtotal	52
Gasoline discount subtotal	52
Holding/Recalling of Transaction	53
Hold/Recall Function	53
Finalization of Transaction	54
Cash or check tendering	54
Mixed tendering (check + cash)	54
Cash or check sale that does not need any tender entry (Expect payment)	54
Charge (credit) sale	54
Mixed-tender sale (cash or check tendering + charge tendering)	54
Positive/Negative code checking function	54
Food stamp tendering	55
Food stamp status shift	55
Tax Calculations	56
Automatic tax	56
Manual tax	56
Tax deletion	57
Tax status shift	58
Guest Check (GLU/PBLU)	59
GLU/PBLU system	59
Deposit entries	61
Transferring guest checks out or in (Transfer-out/in)	62
Bill totalizing/bill transfer	63
Bill separating	65
Bill printing	67
Auxiliary Entries	68
Percent calculations (premium or discount)	68
Discount entries	69
Refund entries	70
Return entries	70
Printing of non-add code numbers	71
Refund sales mode	71
Group discount entries	71
Remote printer send function	72
Gratuity	72
Payment Treatment	73
Tip-in entries	73
Tip editing	73
Tip paid entries	74
Currency conversion	74
Received-on-account entries	74
Paid-out entries	76
No-sale (exchange)	77
Cashing a check	77

Customer management	78
WASTE mode	79
7. Correction	80
Correction of the Last Entry (Direct Void)	80
Correction of the Next-to-Last or Earlier Entries (Indirect Void)	81
Subtotal Void	82
Correction of Incorrect Entries Not Handled by the Direct or Indirect Void Function	82
8. Special Printing Functions.....	83
Printing Message Text for Remote Printer or Chit Receipts	83
Copy Receipt Printing	83
Validation Printing Function	84
9. Manager's Override Entries and Correction after Finalization	85
Override Entries	85
Correction after Finalization	86
10. Reading (X) and Resetting (Z) of Sales Totals	87
How to take an OPXZ, X1/Z1 or X2/Z2 reports	87
Flash report	87
Daily Sales Totals	90
Transaction report	90
Department report	93
Individual group total report on departments	94
Full group total report on departments	94
Department markdown report	94
PLU/UPC report by designated range	95
PLU/UPC pick up report	96
PLU/UPC report by associated department	97
Individual group total report on PLUs/UPCs	98
Full group total report on PLUs/UPCs	98
PLU/UPC stock report by designated range	98
PLU/UPC stock pick up report	98
PLU/UPC zero sales report (full)	99
PLU/UPC zero sales (by dept.) report	99
PLU/UPC minimum stock report	99
PLU/UPC price category report	100
Cash in drawer report	100
Positive check report	100
Dynamic UPC report by designated range	101
Dynamic UPC pick up report	101
Dynamic UPC report by associated department	102
Tax report	103
Key capture report	103
Individual server report	104
Full server report	105
SCM(Starting cash memory)report	105
Hourly report	106
GLU/PBLU report	107
GLU/PBLU report by server	107
Closed GLU/PBLU report	108
Closed GLU/PBLU report by server	109
X1/Z1 stacked reports	109
Periodic Consolidation	110
Transaction report	110
Daily net report	111

Customer sales report	112
Customer sales report by sales range	113
Customer charge account report	113
X2/Z2 stacked report	113
Electronic journal	114
11. Non-accessed UPC and Customer Deletion	115
Non-accessed UPC report	116
Non-accessed customer report	116
Customer delete report	117
Dynamic UPC clear	117
12. How to Use the Programming Keyboard	118
Programming Keyboard Layout	118
How to Enter Text Using Alphanumeric Characters	119
Using character keys on the keyboard	119
Entering character codes	120
13. Programming	121
Basic Procedure	121
Programming screens	121
Programming example	122
Article Programming	124
Department	125
PLU/UPC	127
Dynamic UPC	130
PLU range	130
PLU/UPC stock	131
Link PLU table (for PLU/UPC)	132
Condiment table	133
Mix & Match table	135
Combo meal table	136
Scale table	137
UPC Non-PLU code format	138
UPC delete	139
Direct Key Programming	140
Direct PLU/COMBO/Dept. key	140
PLU Menu Key Programming	142
PLU menu key	142
Functional Programming	144
Discount key (- 1 thru - 9)	145
Percent key (%1 thru %9)	146
Group discount key (GDSC%1 thru GDSC%3)	146
Gas discount	148
Gratuity	149
Tip	149
RA	150
PO	151
Manual tax	151
Tax delete	152
No-sale	152
Void	153
Refund	153
Return	154
Media Key Programming	155
Cash keys	156
Check keys	160

Charge keys	163
Food stamp tender key	167
FSTEND EBT key	169
Cash benefit EBT (CASH BNF key)	171
Currency conversion keys	173
Eat-in keys	173
Service key.....	174
Final key.....	176
Cash in drawer	178
Check change	178
Check cashing	179
Currency denominations (MONEY)	181
Text Programming	182
Function text	183
Department group text	185
PLU group text	185
Server group text	186
Message text	186
Personnel Programming	187
Server	187
Manager	188
Terminal Programming	189
Machine number	190
Consecutive number	190
Interval timer.....	190
Default menu level	191
Available GLU code	191
Bill number	191
Brightness	191
Date/Time Setting	192
Date/time	192
Optional Feature Selection	193
Function prohibition	194
Function selection 1	196
Function selection 2	197
Printing selection.....	199
Secret Code Programming	201
Z1 reports	202
PGM2-mode operations	202
System Z1 reports	203
System PGM2-mode operations	203
Initial down-loading (with clearing of memory)	204
Maintenance down-loading (without clearing of memory)	204
Auto key	205
Report Programming	206
Zero skip	207
Hourly report	207
Stacked report	208
Logo Text Programming	211
Receipt logo	212
Validation printing text	212
Bill logo	213
Scrolling message for pole display.....	213
Device Configuration Programming.....	214
Built-in printer	215
Journal printer	215
External journal	215

Receipt printer	216
Bill printer	216
Report printer	217
Validation (VP) printer	217
Remote printer (KP#1 thru KP#9)	218
BCR (SCANNER)	218
Pole display	219
GLU Code Programming	220
Customer Programming	221
Customer code	222
Customer programming	222
Negative Code File Programming	223
Negative code/Override status	223
Positive Code File Programming	225
Positive code	225
Macro Key Programming	227
Mode position/Auto key no.	227
Function Menu Key Programming	228
Function menu key	229
Function key	231
Function menu key list	232
Capture Key Programming	233
Capture key data	233
Key Data Entry Job Table Programming	234
Capture job number	234
Tax Programming	235
Table tax	236
Rate (%) tax	238
Doughnut tax exemption (for the Canadian tax system)	238
TRAINING Mode Selection	239
TRAINING mode	239
Backup Data Send Programming	240
Backup data send	240
Backup Data Receive Programming	241
Backup data receive	241
PLU Updating (in the PGM1 Mode)	242
Automatic Sequencing Key Programming	243
Loading Dynamic UPC to the Main UPC File	244
SD CARD Mode	245
Reading Stored Programs	247
Program reading sequence	247
Sample printouts	248
Data Clear	261
14. Universal Product Code (UPC) or European Article Number (EAN)	262
UPC or EAN code	262
Add-on code	263
UPC file	263
15. Operator Maintenance	264
In Case of Power Failure	264
In Case of a Printer Error	264
Thermal Printing	264
Cautions in handling the printer	264
Cautions in handling the recording paper (Thermal paper)	265
Installing and Removing the Paper Roll	265

Recording paper specifications	265
Installing a paper roll	266
Manual installing of a paper roll	266
Removing the journal paper roll	267
Prevention of paper jams	268
Removing a paper jam	269
Cleaning the Print Head	270
Removing the Till and the Drawer.....	271
Operating the Drawer by Hand.....	271
Before Calling for Service	272
16. List of Options	272
17. Specifications.....	273

1

Part Names and Functions

This chapter describes the part names and functions of this POS terminal.

External View

■ Front view

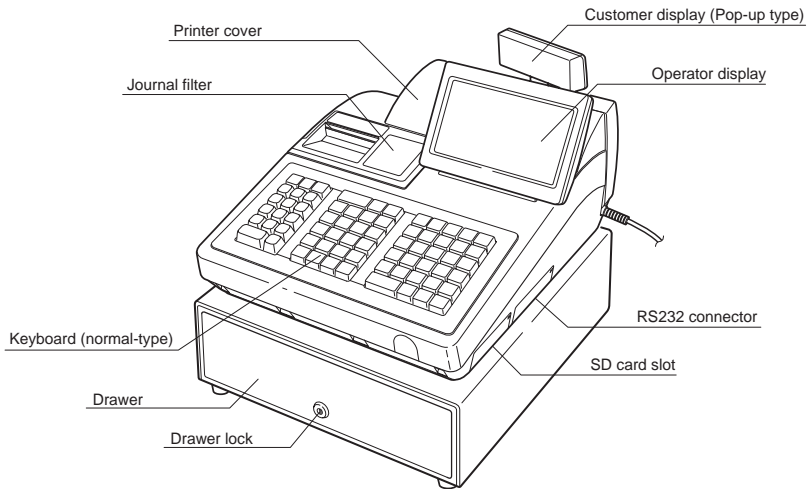

■ Rear view

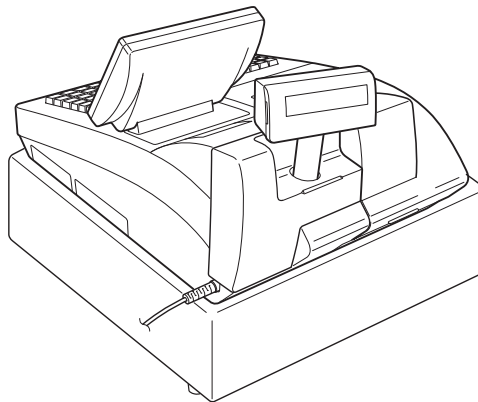

Printer

NOTE *The POS terminal UP-820N may be configured with multiple types of printers offered by the market. For specific instructions related to the handling and care of the printer, please refer to the applicable printer instruction manual.*

The built-in printer is a 2-station (receipt/journal) type thermal printer, and therefore it does not require any type of ink ribbon or cartridge. The average life of the printer is approximately 5 million lines.

To open the printer cover, lift up the cover as shown in the illustration on the right.

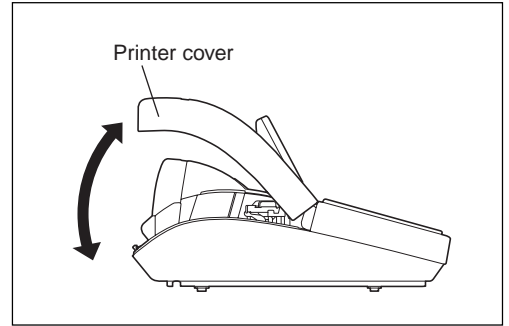

Your POS terminal is shipped with the print head release lever held by a white retainer in the lifted up position. Be sure to remove this retainer and push down the print head release lever before you use the terminal.

Print head release lever

The print head can be lifted by the green lever on the right side of the printer. Pulling the lever forward lifts the print head up. If the paper becomes jammed, you need to lift the print head.

Cutter open tab

If a paper jam occurs, pull the cutter unit open while pushing the cutter open lever to the right. Then remove the paper jam inside the printer. For further information, refer to the "Removing a paper jam" section in the "Operator Maintenance" chapter.

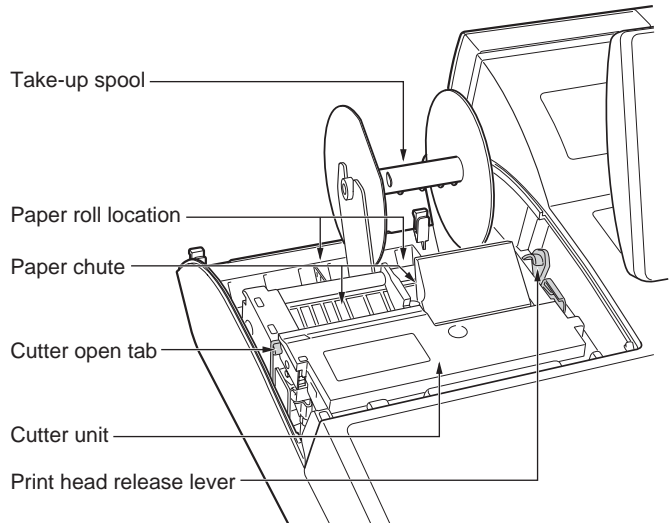

NOTE *Do not attempt to remove the paper roll with the head in the down position. This may result in damage to the printer and print head.*

RS232 Connector/SD Card Slot

■ Opening the RS232 connector cover

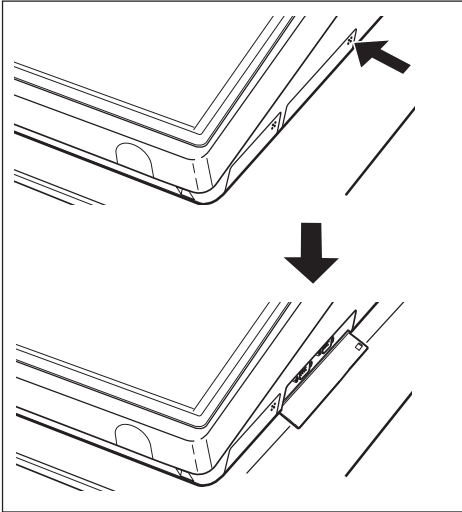

To open the RS232 connector cover, push the part of the cover as indicated by the arrow in the illustration on the left.

* To close the cover, push the same part in until you hear it click.

■ Opening the SD card slot cover

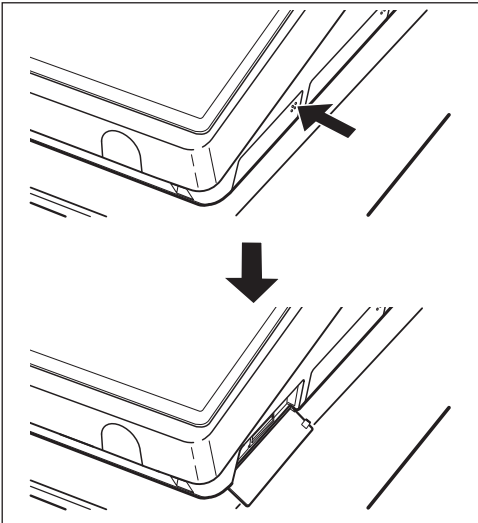

To open the SD card slot cover, push the part or the cover as indicated by the arrow in the illustration on the left.

* To close the cover, push the same part in until you hear it click.

For further information, refer to the "SD Card Mode" section.

Keyboard

■ Standard keyboard layout

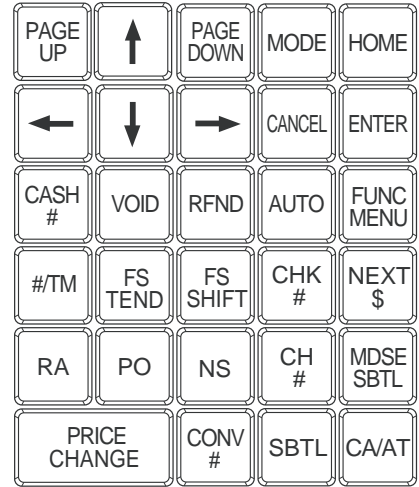
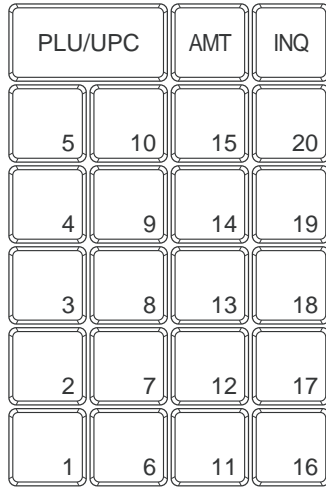

- NOTE**
- In addition to the keys shown above, many optional keys are available to customize your keyboard. For details, refer to the section "Optional keys" in INSTRUCTION MANUAL.
 - All the keys except the and keys can be re-positioned. If you want to change the layout, contact your authorized SHARP dealer.
 - Department keys through are shown as through in this manual.























































	Receipt paper feed key		Charge menu key
	Journal paper feed key		Check menu key
...	Department keys		Subtotal key
...	} Numeric keys		Cash/amount tendered key
			Page up/down keys
	Decimal point key		} Cursor (up/down/right/left arrow) keys
	Clear key		
	Multiplication key		Cancel key
	Receipt print key		Enter key
	Refund key		Mode key
	Void key		Home key

	Inquiry key		Price change key
	PLU/UPC key		Amount entry key
	Merchandise sub total key		Currency conversion menu key
	Auto menu key		Cashier (server) code entry key
	Paid out key		Food stamp shift key
	Non-add code/time key		Food stamp tender key
	Function menu key		No sale key
	Received on account key		Next high dollar key

NOTE *The following optional keys can be assigned in place of those shown in the figure of the standard keyboard layout. For details, please consult your authorized SHARP dealer.*

■ Optional keys

	Numeric keys		Tip paid key
	Dept. number key		Eat in 1 thru 3 keys
	Direct price lookup keys		Tax 1 thru Tax 5 shift keys
	Department keys		Deposit key
%1 ... %9 key"/>	Percent 1 thru 9 keys		Deposit refund key
⊖1 ... ⊖9 key"/>	Discount 1 thru 9 keys		PLU level shift menu key
CH 1 ... CH 9 key"/>	Charge 1 thru 9 keys		Automatic sequencing 2 thru 99 keys
CA2 ... CA5 key"/>	Cash 2 thru 5 keys		Backspace key
CONV1 ... CONV4 key"/>	Conversion 1 thru 4 keys		Delete key
RA2 key"/>	Received-on-account 2 key		Service key
PO2 key"/>	Paid-out 2 key		Final key
CHK 1 ... CHK 9 key"/>	Check 1 thru 9 keys		Tray subtotal key
TRANS OUT key"/>	Transfer out key		Return key
TRANS IN key"/>	Transfer in key		Gasoline sales 1 thru 28 subtotal key
CASH TIP key"/>	Cash tip key		Guest lookup key
CHARGE TIP key"/>	Charge tip key		Scale entry key

	...		PLU level shift 1 thru 5 keys		Repeat entry key		
	...		Price level shift 1 thru 6 keys		Individual payment key		
	...		Group discount shift 1 thru 3 keys		Customer code entry key		
			Validation print key		Birthday entry key		
			Bill print key		Table no. (seat no.) entry key		
			Past void key		Void menu key		
			Subtotal void key		Refund sale key		
	...		Group discount %1 thru 3 keys		Receipt ON/OFF key		
			Cover count entry key		Waste mode key		
			New check key		Condiment next key		
			Bill separation key		Edit tip key		
			Bill totalize/Bill transfer key (CHECK-ADD)		Repeat round key		
			"Food stamp tender by EBT" key		Table# recall key		
			Guest check copy key		...		Message 1 thru 5 keys
			Cash benefit key				Message menu key
			Guest check balance key		...		PLU menu 1 thru 50 keys
			Cash menu key		...		Macro 1 thru 4 keys
	...		Function menu 2 thru 30 key				Upsize key
			Manual tax key		...		Data capture 1 thru 10 key
			Remote printer send key		...		Check cashing 1 thru 9 keys
			Gratuity exempt key				Manager number keys
			Tare entry key				Hold/Recall keys
			Balance key				

■ Default key texts on the display

The **HOME** key and **FUNC MENU** through **FUNC MENU30** keys can be set as function keys on the keyboard area of the display. Note that the labels on the key tops in this manual may differ from the displayed default key texts.

The default texts are as follows:

key	Default text	key	Default text
ST	SUB TOTAL	I.VOID	I.VOID
MODE	MODE	ST VD	ST VD
HOME	HOME	REFUND	REFUND
TL	CASH TOTAL	RETURN	RETURN
#/TM	# TIME	TAX	TAX
NS	NS	COVER COUNT	COVER COUNT
SCALE	SCALE	PBAL	PBAL
OPEN TARE	OPEN TARE	N.C.	N.C.
PLU/UPC	PLU UPC	SERVICE	SRVC
GCCOPY	GCCOPY	FINAL	FINAL
RCPT	RCPT	DEPOSIT	DEPO
RA	RA	DEPOSIT RF	DEPO REFUND
RA2	RA2	B.T.	B.T.
PO	PO	FSTEND	FSTEND
PO2	PO2	FSTEND EBT	FSTENDEBT
REPEAT	REPEAT	CASH BENEFIT	CASH BN
RPT ON/OFF	RCP ON/OFF	SERVER#	SRV#
WASTE	WASTE	RP SND	RP SND
MDS ST	MDS ST	GRATUITY	GRATUITY
TRY ST	TRY ST	BALANCE	BAL
FS/CBN SHIFT	FS/CBN SHIFT	AMOUNT	AMOUNT
PRINT	PRINT	DEPT#	DEPT#
BILL	BILL	INQ	INQ
CHARGE TIP	CHARGE TIP	PRICE CHANGE	PRICE CHANGE
CASH TIP	CASH TIP	CUSTOMER	CUST
TIP PAID	TIP PAID	BIRTH	BIRTH
VOID	VOID	TRANS OUT	TRANS OUT

key	Default text	key	Default text
TRANS IN	TRANS IN	TAX1SF ... TAX5SF	TAX1SF thru TAX5SF
SEAT#	SEAT#	GD1SFT ... GD3SFT	GD1SFT thru GD3SFT
I.PAY	I.PAY	GDSC%1 ... GDSC%3	GROUP DISC1 thru 3
RF.SAL	RF.SAL	%1 ... %9	%1 thru 9
B.S.	B.S.	⊖1 ... ⊖9	(-)1 thru (-)9
WASTE	WASTE	CONV1 ... CONV4	CONV1 thru CONV4
C NEXT	C NEXT	RA	RA
NEXT\$	NEXT\$	RA2	RA2
EDIT TIP	EDIT TIP	PO	PO
REPEAT ROUND	REPEAT ROUND	PO2	PO2
GLU RC	GLU RC	CA/CHK1 ... CA/CHK9	CA/CHK 1 thru CA/CHK 9
UPSIZE	UPSIZE	EATIN1 ... EATIN3	EATIN1 thru 3
GC BAL	GC BAL	MESSAGE1 ... MESSAGE5	MSG1 thru 5
MGR#	MGR#	CAP.1 ... CAP.10	CAP.1 thru 10
HOLDRECALL	HOLD RECALL	GAS1 ST ... GAS28 ST	GAS1 ST thru GAS28 ST
LEVEL#	LEVEL#	CA2 ... CA5	CA2 thru CA5
L1 ... L5	L1 thru L5	CHECK ... CHECK9	CHECK thru CHECK9
PRICE SFT#	PRICE SHIFT#	CHARGE1 ... CHARGE9	CHG1 thru CHG9
PRICE SFT1 ... PRICE SFT6	P1 thru 6		

NOTE You can change the default texts in the PGM2 mode.

Drawer lock key

This key locks and unlocks the cash drawer. To lock it, turn 90 degrees counter-clockwise. To unlock it, turn 90 degrees clockwise.

This key is also used to open the cash drawer.

(Please refer to "15. Operator Maintenance — Operating the Drawer by Hand".)

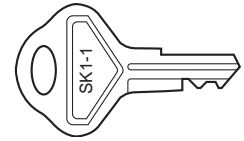

Display

Operator display (touch panel)

Screen example 1 (REG mode)

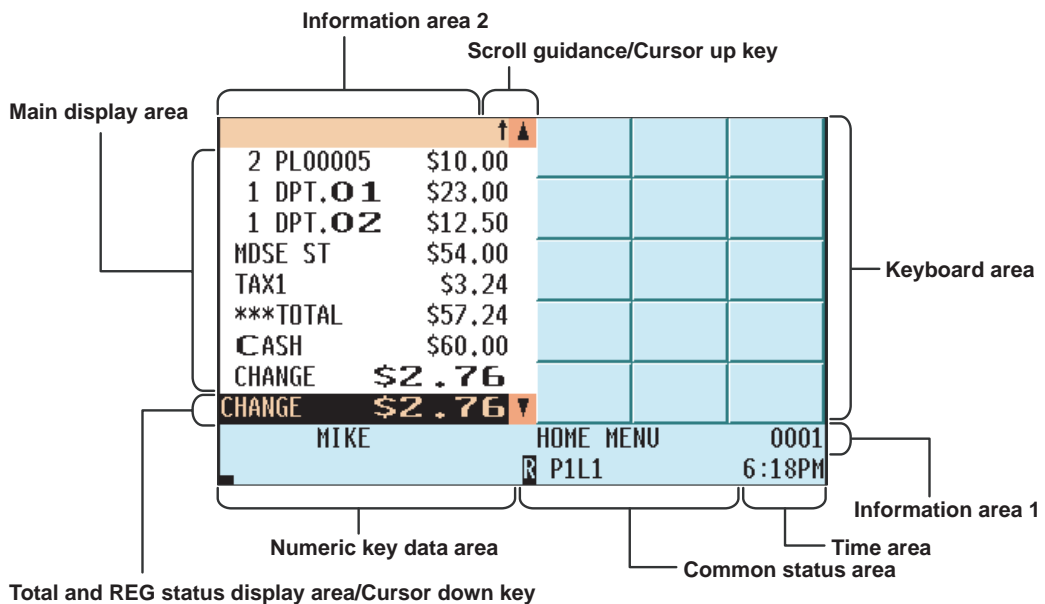

Main display area

Shows sales information you have just entered.

Total and REG status display area

Shows the sales total.

Scroll guidance/Cursor up (down) keys

Shows the scroll guidance to indicate you can scroll in the arrow direction using the cursor up/down keys / when the transaction information occupies more than 8 lines.

Keyboard area

Shows the keyboard.

By pressing a menu key such as key, a function menu key, or a PLU menu keys, the currently displayed keys are replaced by the keys assigned to the menu key.

Information area 1

Shows the following items:

- Server name** : Shows the current server name.
- Menu title** : Shows the current menu title.
- Server code** : Shows the current server code.
- Electronic mail indicator (M)** : Appears when an electronic mail is received.

- Item text** : Appears when an item is selected on the main display area or registered.
- Modification status** : Shows "REFUND", "RETURN" or the like when the corresponding key is pressed.

Information area 2

Shows the GLU code during a GLU entry.

Time area

Shows the current time.

Common status area

Shows the following items:

- Price level shift indicator (P1-P6)** : Shows the current PLU/UPC price level.
- PLU level shift indicator (L1-L5)** : Shows the current PLU level.
- Receipt shift indicator (r)** : Shows the receipt shift status.
- T-Log near full indicator** :
 - appears when the used memory is 80%.
 - appears when the used memory is 90%.
 - appears when the used memory is 95%.
- Stock alarm indicator (!)** : Appears when the stock of the PLU which you entered is zero, negative or the minimum.
- Electronic journal near full indicator** :
 - appears when the used memory is 80%.
 - appears when the used memory is 90%.
 - appears when the used memory is 95%.
- Tax shift status indicator (V)** : Appears when the Tax status is shifted.
- Receipt ON/OFF state indicator (R)** : Appears when the receipt ON-OFF function is in the "OFF" state.
- Sentinel mark (X)** : Appears when the cash in drawer exceeds the programmed sentinel amount.
The sentinel server is performed for the total cash in drawer.

Numeric key data area

Shows numeric data by numeric key entry.

• **Screen example 2 (PGM mode)**

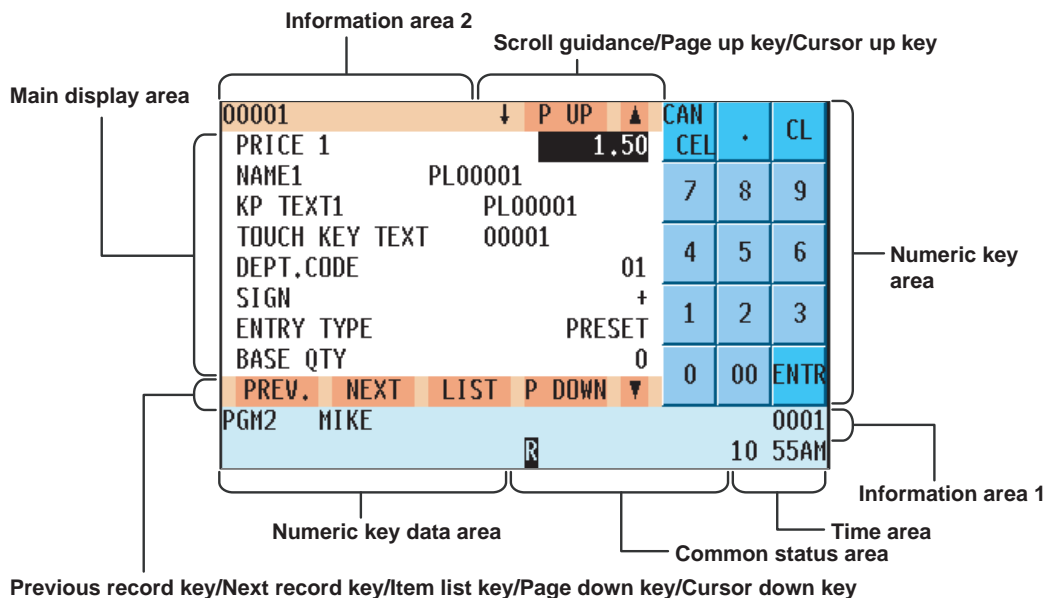

Main display area

Shows programmable items.

Information area 1

Shows the mode you are in, server name, electronic mail indicator (M) and server code. Refer to the REG mode screen example for details.

Information area 2

Shows the current job name like "READING", "RESETTING", etc.

Numeric key area

Shows the numeric keys.

Time area/Numeric key data area/Scroll guidance/Cursor up (down) keys

Refer to the REG mode screen example.

Common status area

Shows the following indicators besides some of those shown in the REG mode screen example:

Caps lock indicator (A/a) :

During text entry for programming, the upper-case letter "A" appears when caps lock is on, and the lower-case letter "a" appears when caps lock is off.

Double-size character mode indicator (W) : Appears when the double-size character mode is selected during text entry for programming.

Page up (down) keys (P UP / P DOWN)

Used to scroll the window to go to the next page or back to the previous page.

Next/Previous record key (NEXT / PREV.)

Used to go to the next record or back to the previous record.

Item list key (LIST)

Used to list programmable options. You can also toggle the options with the  key.

■ Display angle

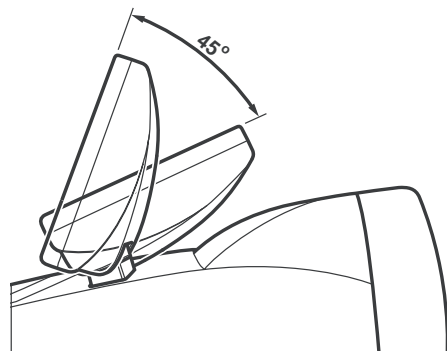
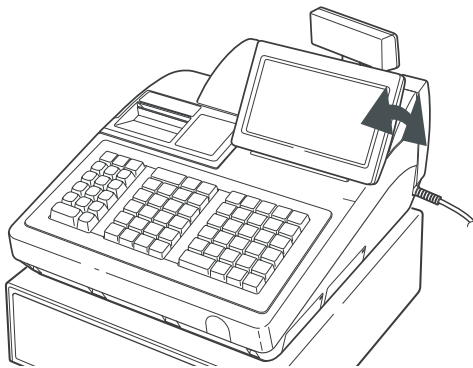

The operator display can be tilted for the best viewing angle. It can be tilted within 45 degrees as shown in the above illustrations.

CAUTION : Do not pull or push the display beyond the allowable tilt angle range (45 degrees) nor apply excessive pressure to the display.

■ Customer display (pop-up type)



■ Display contrast adjustment (operator display)

You can adjust the contrast of the display in the "BRIGHTNESS" menu of "TERMINAL" programming.

The backlight in the display is a consumable part.

When the contrast is no longer adjustable and the display becomes darker, consult your authorized SHARP dealer.

■ Screen save mode

When you want to save the electric power or save the display's life, use the screen save function. This function can turn off the LCD backlight when the POS terminal is to be out of operation for an extended period of time. You can program the time for which your POS terminal should keep the normal status (in which the backlight is "ON") before it goes into the screen save mode.

To go back to the normal mode, press any key.

2

Selecting an Operating Mode

When you turn on the POS terminal and press the **MODE** key, a mode selection window will appear on the display, listing available operating modes as shown below.

Mode selection window

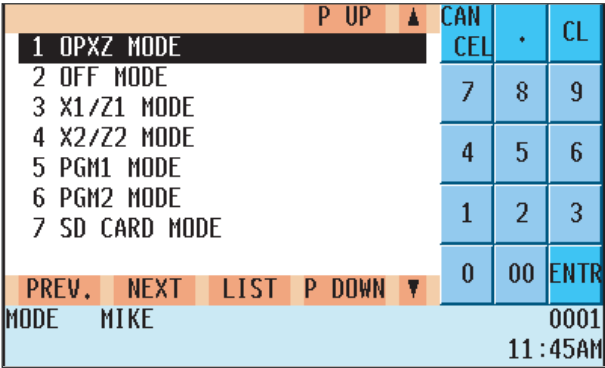

Operating Modes

You can select any mode other than REG from the list in the mode selection window. Your POS terminal supports the following eight operating modes:

REG mode	This mode allows you to enter various sales information. The mode selection window does not list this mode. To select this mode from the mode selection window, press the CANCEL key.
OPX/Z mode	This mode allows cashiers/servers to take X or Z reports on their sales. It can also be used to specify the number of hours for which employees work.
OFF mode	This mode locks all the operational functions of the POS terminal. When you select this mode, the window will disappear. Pressing any key turns the POS terminal "ON."
X1/Z1 mode	This mode is used to take various daily total reports (X1/Z1 reports).
X2/Z2 mode	This mode is used to take various weekly or monthly reports (X2/Z2 reports).
PGM1 mode	This mode allows you to program those items which need to be frequently changed, such as unit prices of departments or PLUs and percentages.
PGM2 mode	This mode allows you to program those items which can be programmed in the PGM1 and need not be frequently changed, such as date, time and functions.
SD Card mode	This mode allows you to save the data of your POS terminal to an SD card or load the data saved in the SD card on the terminal.

Mode Selection

Procedure

P UP ▲		CAN	CEL	.	CL
1	OPXZ MODE	7	8	9	
2	OFF MODE	4	5	6	
3	X1/Z1 MODE	1	2	3	
4	X2/Z2 MODE	0	00	ENTR	
5	PGH1 MODE				0001
6	PGH2 MODE				11 46AM
7	SD CARD MODE				
PREV. NEXT LIST P DOWN ▼					
MODE MIKE					

P UP ▲		CAN	CEL	.	CL
1	OPXZ MODE	7	8	9	
2	OFF MODE	4	5	6	
3	X1/Z1 MODE	1	2	3	
4	X2/Z2 MODE	0	00	ENTR	
5	PGH1 MODE				0001
6	PGH2 MODE				11:47AM
7	SD CARD MODE				
PREV. NEXT LIST P DOWN ▼					
MODE MIKE					

Procedure

TAX \$0.00 SBTL \$0.00 ▼					
MIKE		HOME MENU			0001
		P1L1			11 48AM

Procedure

P UP ▲		CAN	CEL	.	CL
1	READING	7	8	9	
2	SETTING	4	5	6	
3	PLU UPDATE	1	2	3	
PREV. NEXT LIST P DOWN ▼		0	00	ENTR	
PGH1 MIKE					0001
					11:49AM

■ Selecting a mode

1. Use one of the following ways:

- Move the cursor to the desired option using the or key.
- Enter the desired option number using a numeric key.
- Touch the desired option.
- Move the cursor to the desired option by touching the or key.

2. Press the key.

- You need not press the key when you have touched the option directly.
- When you want to enter the REG mode, press the key.

■ Returning to the mode selection window from the REG mode

To return to the mode selection window from the REG mode:

1. Press the key.

- You will return to the mode selection window.

■ Returning to the mode selection window from modes other than the REG mode

To return to the mode selection window from modes other than the REG mode, use the following procedure:

1. Press the or key with the selected mode menu screen for the selected mode displayed.

- You will enter the REG mode.

2. Press the key.

- You will return to the mode selection window.

3 Time Display and Automatic Date Updating

Time display

The screen always displays the current time in the bottom left corner as shown below.

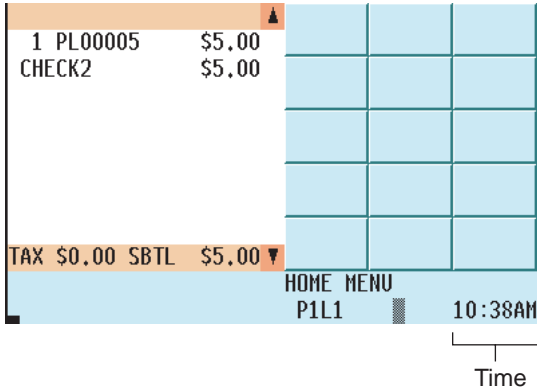

Automatic date updating

Once the internal clock is started at the correct time, it continues to run until the battery is exhausted. It also updates the date automatically.

4

Receipts

This chapter describes the part names and functions of this POS terminal.

Built-in Printer Sample Receipt

YOUR RECEIPT
THANK YOU

Date	08/12/2008	000001	Machine no.	
Consecutive no.	#1026	11:03AM	MIKE0001	Server name / Server code
			Time	
Item entry	PL00004	\$4.00		
		2 @ \$5.00		
	PL00005	\$10.00		
	PL00006	\$6.00		
	DPT. 01	\$12.50		
	DPT. 02	\$23.00		
	MDSE ST	\$55.50		
TAX1	\$1.20			
	***TOTAL	\$56.70	Sales total	
	CASH	\$60.00	Cash amount tendered	
	CHANGE	\$3.30	Change due	



5 Prior to Entries

Preparations for Entries

■ Receipt/Journal paper rolls

If the paper rolls are not installed in the built-in printer of your POS terminal, install a new one (ones) according to section "Installing and Removing the Paper Roll" under "Operator Maintenance." If the roll in the printer is getting low, replace it with a new one.

■ Receipt ON/OFF function

You can disable receipt printing in the REG mode to save paper using the receipt On/Off function. To disable receipt printing, press the  key and then touch the  key. Set the function to "OFF" by pressing the  key. When this function is in the OFF state, the Receipt Off Indicator "R" is highlighted. To enable receipt printing, touch "RCP ON/OFF" with this function in the OFF state.

NOTE *Your POS terminal will print reports regardless of the state of the Receipt ON/OFF function. This means that the paper roll(s) must be installed even when the Receipt ON/OFF function is preset to "OFF".*

Error Warning

In the following examples, your POS terminal will go into an error state accompanied by a warning beep and the error message on the display. Clear the error state by pressing the  key and take a proper action.

- When you exceed a 32-digit number (entry limit overflow):
Cancel the entry and reenter a correct number.
- When you make an error in key operation:
Clear the error and try the entry again.
- When you make an entry beyond a programmed amount entry limit:
Check to see if the entered amount is correct. If it is correct, it can be rung up by the manager. Contact your manager.
- When an including-tax subtotal exceeds eight digits:
Delete the subtotal by pressing the  key and press a media key to finalize the transaction.

Starting Cash Memory Entry

If you enter the amount of cash for change (starting cash) in the drawer before starting entry operations, you can discriminate that amount from the sales amount when reports are generated. Your POS terminal can be programmed to enforce the entry of starting cash into memory. For details, consult your authorized SHARP dealer.

Procedure Select the OPXZ mode and perform the following operation:

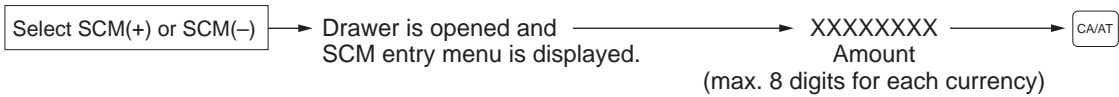

Example

OPXZ MODE	P UP ▲	CAN	.	CL
1 READING		CEL		
2 RESETTING		7	8	9
3 GLUR# ASSIGN				
4 SCM(+)		4	5	6
5 SCM(-)		1	2	3
		0	00	ENTR
PREV. NEXT LIST P DOWN ▼				
OPX/Z MIKE				0001
				2:33PM

1. Select "04 SCM(+)" or "05 SCM(-)" in the OPXZ mode.
 - The SCM entry menu is displayed.

SCH (+)	↓ P UP ▲	CAN	.	CL
1 CENTS		0	CEL	
5 CENTS		0	7	8
10 CENTS		0		9
25 CENTS		0	4	5
50 CENTS		0		6
100 CENTS		0	1	2
\$1		0		3
\$2		0	00	ENTR
PREV. NEXT LIST P DOWN ▼				
OPX/Z MIKE				0001
				2:33PM

2. Enter the amounts of cash in domestic and foreign currencies.

10/20/2008		000001
#1290	4:10PM	MIKE0001
SRV#0001	MIKE	
		\$0.00
20 @	0.01	\$0.20
20 @	0.05	\$1.00
20 @	0.10	\$2.00
20 @	0.25	\$5.00
10 @	0.50	\$5.00
10 @	1.00	\$10.00
20 @	1.00	\$20.00
10 @	2.00	\$20.00
10 @	5.00	\$50.00
20 @	10.00	\$200.00
5 @	20.00	\$100.00
3 @	50.00	\$150.00
1 @	100.00	\$100.00
SCM (+)		\$663.20
SCM TTL		\$663.20

3. Press the CAIAT key.
 - The SCM report is printed.

6

Entries

Server Code Entries

Prior to an item entry, the server will be compelled to enter his or her assigned server code. However, this may not be necessary when the POS terminal has been programmed for “stay-down server mode.”

Procedure

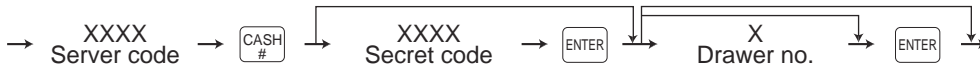

- NOTE** • When the server entry on system is programmed for “stay-down server mode,” no server can sign on while another server signs.
- When the server entry system is programmed for “automatic server sign-off mode,” a server must sign on prior to each sales transaction.

The sign-off operation can be performed by using the following procedure in the REG.

To sign off a server: → CASH#

- NOTE** • Depending upon how your POS terminal has been preset, if an item entry is attempted when the server has not signed on, server entry will be prompted on the window to compel server entry.

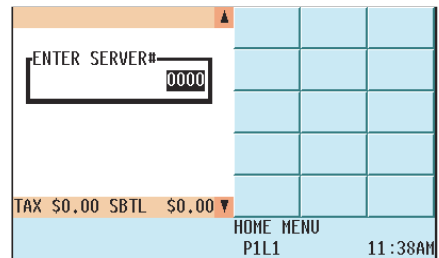

Item Selection from the Function Menu Windows

Your POS terminal allows you to select functions from specified function menu windows depending upon the terminal setup. For example, if you want to finalize a charge 2 sale, select the option “CHG 2” from the charge menu instead of pressing the CHG 2 key. Each menu can be opened as follows:

• **Miscellaneous function menu window**

FUNC MENU	→	▲	RCP	CA/CHK	CA/CHK	
			ON/OFF	1	6	
			RA	CA/CHK	CA/CHK	
			2	7		
			RA2	CA/CHK	CA/CHK	
		3	8			
		PD	CA/CHK	CA/CHK		
		4	9			
		PO2	CA/CHK	NS		
		5				
TAX \$0.00 SBTL \$0.00 ▼						
SERV.001			MISC MENU		0001	
			P1L1		4 48PM	

• **Conversion menu window**

CONV #	→	▲	CONV1		
			CONV2		
			CONV3		
			CONV4		
TAX \$0.00 SBTL \$0.00 ▼					
SERV.001			CONV MENU		0001
			P1L1		6 38AM

• **Cash menu window**

CASH #	→	▲	CASH		
			TOTAL		
			CA2		
			CA3		
			CA4		
		CA5			
TAX \$0.00 SBTL \$0.00 ▼					
SERV.001			CASH MENU		0001
			P1L1		4 49PM

• **Message menu window**

MSG MENU	→	▲	MSG1	MAIL	
			MSG2	HSG	
			MSG3		
			MSG4		
			MSG5		
TAX \$0.00 SBTL \$0.00 ▼					
SERV.001			MSG MENU		0001
			P1L1		6 39AM

• **Check menu window**

CHK #	→	▲	CHECK	CHECK6	
			CHECK2	CHECK7	
			CHECK3	CHECK8	
			CHECK4	CHECK9	
			CHECK5		
TAX \$0.00 SBTL \$0.00 ▼					
SERV.001			CHECK MENU		0001
			P1L1		4 51PM

• **Void menu window**

VOID MENU	→	▲	VOID		
			I.VOID		
			ST VD		
TAX \$0.00 SBTL \$0.00 ▼					
SERV.001			VOID MENU		0001
			P1L1		6 39AM

• **Charge menu window**

CH #	→	▲	CHG1	CHG6	
			CHG2	CHG7	
			CHG3	CHG8	
			CHG4	CHG9	
			CHG5		
TAX \$0.00 SBTL \$0.00 ▼					
SERV.001			CHARGE MENU		0001
			P1L1		4:50PM

• **PLU menu window**

PLU MENU1	→	▲	00001	00006	00011
			00002	00007	00012
			00003	00008	00013
			00004	00009	00014
			00005	00010	00015
TAX \$0.00 SBTL \$0.00 ▼					
SERV.001			PLU001		0001
			P1L1		9:46AM

NOTE * The keys on these menus are shown as examples. You can set your choice of function keys on the function menu and PLU keys on the PLU menu.

Example

Selling the PLU no.10 item and finalizing through charge 2

1	PL00010	\$10.00			
TAX \$0.60 SBTL \$10.60					
PL00010	\$10.00	HOME MENU		0001	
		P1L1		4:37PM	

1. Press the key.

1	PL00010	\$10.00	CHG1	CHG6	
TAX \$0.60 SBTL \$10.60			CHG2	CHG7	
PL00010	\$10.00	CHARGE MENU		0001	
		P1L1		4:38PM	

2. Press the key.

- The charge CHECK menu window will appear in the keyboard area.

1	PL00010	\$10.00	CHG1	CHG6	
MDSE ST	\$10.00	CHG2	CHG7		
TAX1	\$0.60	CHG3	CHG8		
CHARGE2	\$10.60	CHG4	CHG9		
TAX \$0.60 SBTL \$10.60		CHG5			
MIKE		CHARGE MENU		0001	
		P1L1		4:38PM	

3. Select "CHG2."

- The transaction will be finalized.

Item Entries

Single item entries

Department entries (direct department entries)

Enter a unit price and press the corresponding department key.
If you use a programmed unit price, press the department key only.

Procedure

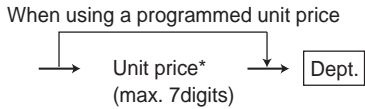

*Less than the programmed upper limit amount

NOTE When a department programmed with the unit price as zero (0) is entered, only the sales quantity is added.

Department entries (indirect department entries)

Procedure

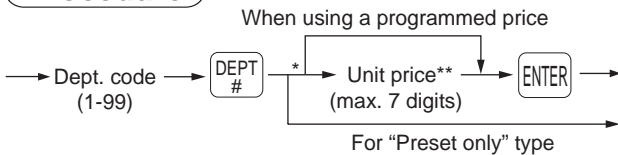

* The pop-up window for amount entry will open.

** Less than the programmed upper limit amount.

Example

Key Operation

```

    1200 [7]
           [6]
           8 [DEPT#]
    5 [DEPT#] 680 [ENTER]
                [CAIAT]
  
```

Display

	AMOUNT		
1 DPT.07	\$12.00		
1 DPT.06	\$6.00	DEPT#	
1 DPT.08	\$8.00		
1 DPT.05	\$6.80		
HDSE ST	\$32.80		
TAX1	\$1.97		
CASH	\$34.77		
TAX \$1.97 SBTL \$34.77			
JACK		FUNCTION MENU09	0002
		P1L1	10:35AM

PLU entries (indirect PLU entries)

Enter a PLU code and press the key.

Procedure



NOTE When a PLU programmed with the unit price as zero (0) is entered, only the sales quantity is added.

Subdepartment (open PLU) entries

Procedure

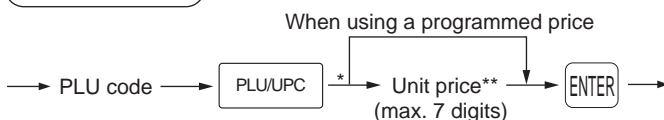

* The pop-up window for amount entry will open.

** Less than the programmed upper limit amount.

PLU entries (direct PLU entries)

Procedure

When using a programmed price

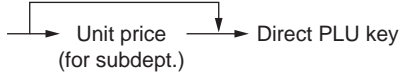

Example

Key Operation		Display	
16	PLU/UPC	1	PL00002 \$2.00
2	PLU/UPC	1	PL00016 \$16.00
1600	ENTER	1	PL00008 \$8.00
	8		MDSE ST \$26.00
	CA/AT		TAX1 \$1.56
			CASH \$27.56
			TAX \$1.56 SBTL \$27.56
			JACK HOME MENU 0002
			P1L1 10 43AM

PLU menu-based entries (PLU entries and subdepartment entries)

Follow this procedure:

Procedure

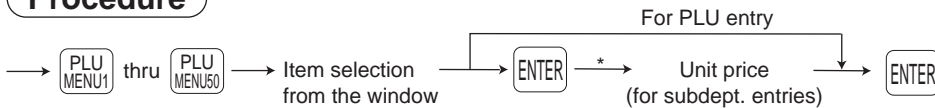

* The pop-up window for amount entry will open.

UPC entries

Procedure

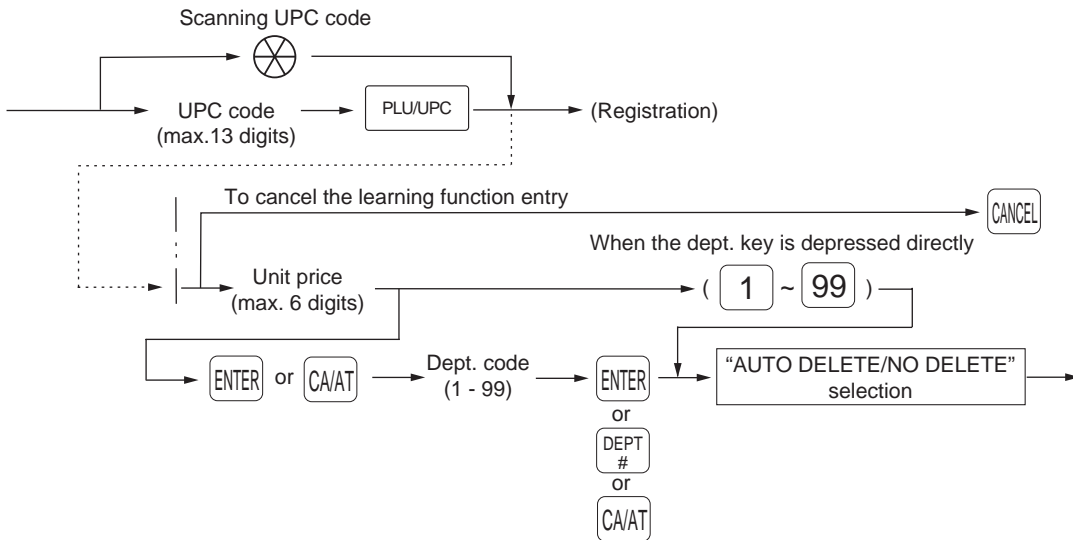

Example

Key Operation		Display	
5099887654302	PLU/UPC	1	ITEM A \$2.50
	CA/AT		MDSE ST \$2.50
			TAX1 \$0.15
			CASH \$2.65
			TAX \$0.15 SBTL \$2.65
			JACK HOME MENU 0002
			P1L1 11 20PM

Repeat entries

You can use this function for repetitive entries of the same item. Simply press the repeat function key after a valid item entry.



Example

Key Operation	
Repeated department entry (direct)	200 [8]
	[8]
	[8]
Repeated department entry (indirect)	5 [DEPT #] 680 [ENTER]
	[DEPT #]
	[DEPT #]
Repeated PLU entry (indirect)	10 [PLU/UPC]
	[PLU/UPC]
	[PLU/UPC]
Repeated PLU entry (direct)	[3]
	[3]
	[3]
Repeated subdepartment entry	20 [PLU/UPC]
	2000 [ENTER]
	[PLU/UPC]
Repeated UPC entry	5099887654302 [PLU/UPC]
	[PLU/UPC]
	[PLU/UPC]
Repeated department entry (direct) using the repeat key	600 [2]
	[REPEAT]
	[REPEAT]
	[CA/AT]

Print	
11/01/2008	000001
#1337	11:29PM JACK0002
DPT. 08	3 @ \$2.00
	\$6.00
DPT. 05	2 @ \$6.80
	\$13.60
PL00010	3 @ \$10.00
	\$30.00
PL00003	2 @ \$3.00
	\$6.00
PL00020	2 @ \$20.00
	\$40.00
5099887654302#	2 @ \$2.50
ITEM A	
	\$5.00
DPT. 02	3 @ \$6.00
	\$18.00
MDSE ST	\$118.60
TAX1	\$6.30
CASH	\$124.90

■ Multiplication entries

Use this function feature when you need to enter two or more of the same item.

This feature helps you when you sell large quantities of items or need to enter quantities that contain decimals.

Procedure

FF method (for quick multiplication of direct PLU)

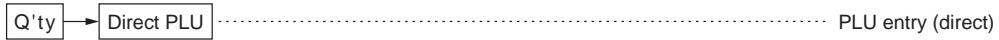

- The FF (fast food) method cannot be used for a COUPON-LIKE PLU entry.

Normal method

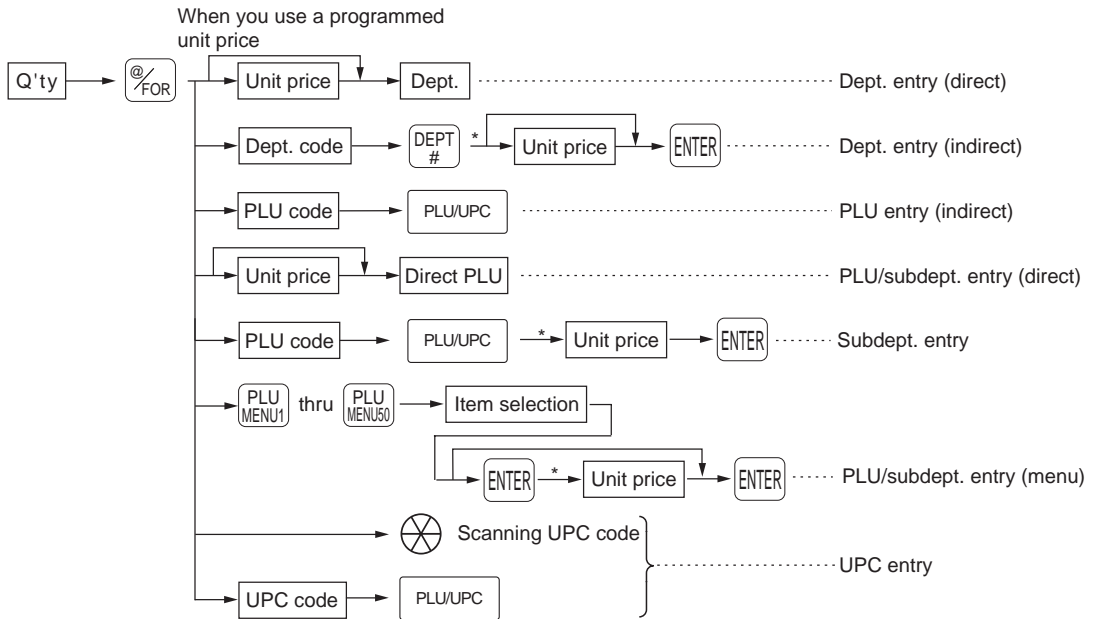

* The pop-up window for amount entry will open.

- After scanning a UPC code or entering a UPC code and pressing the **PLU/UPC** key, the learning UPC function may require you to enter a unit price with the display "UNDEFINED CODE". Enter the unit price and department code to be associated with the UPC.
- Q'ty: Up to four digits integer + three digits decimal
- Unit price: Less than the programmed upper limit
- Q'ty x unit price: Up to seven digits

Example

Key Operation

7
 165
 2
 5
 250
 15
 8
 8
 19
 3
 18
 1800
 5
 5099887654302
 2
 [Select PLU code 20
 from the menu.]

Print

10/20/2008		000002
#2043	3:54PM	SERV.0010001
DPT. 08	7 @ \$1.65	\$11.55
	2 @ \$2.50	\$5.00
DPT. 05	15 @ \$8.00	\$120.00
PL00008	8 @ \$19.00	\$152.00
PL00019	3 @ \$18.00	\$54.00
PL00018	5 @ \$1.00	\$5.00
5099887654302#	ITEM-M	2 @ \$20.00
		\$40.00
CASH		\$387.55

■ Split-pricing entries

You will use this function when your customer wants to separately buy items normally sold in base (unit) quantities.

Procedure

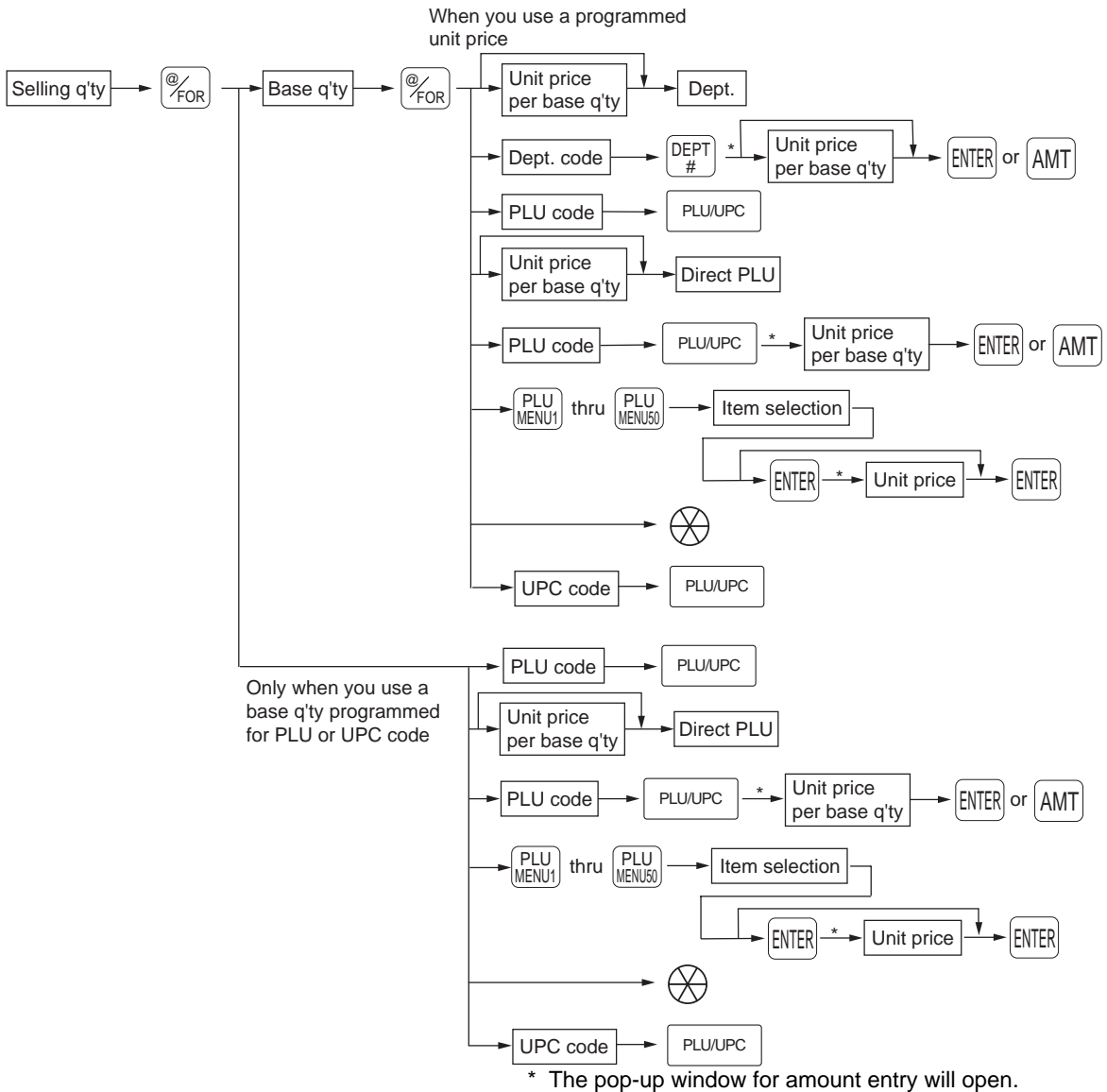

- After scanning a UPC code or entering a UPC code and pressing the PLU/UPC key, the learning UPC function may require you to enter a unit price with the display “UNDEFINED CODE”. Enter the unit price and department code to be associated with the UPC.
- Selling quantity: Up to four digits integer + three digits decimal
- Base quantity: Up to two digits (integer)

NOTE For actual use of this function, please consult your dealer.

Example

Key Operation

7 $\text{\textcircled{Q}}/\text{\textcircled{F}}/\text{\textcircled{O}}/\text{\textcircled{R}}$ 10 $\text{\textcircled{Q}}/\text{\textcircled{F}}/\text{\textcircled{O}}/\text{\textcircled{R}}$
 600 6
 8 $\text{\textcircled{Q}}/\text{\textcircled{F}}/\text{\textcircled{O}}/\text{\textcircled{R}}$ 5 $\text{\textcircled{Q}}/\text{\textcircled{F}}/\text{\textcircled{O}}/\text{\textcircled{R}}$
 15 PLU/UPC
 5 $\text{\textcircled{Q}}/\text{\textcircled{F}}/\text{\textcircled{O}}/\text{\textcircled{R}}$ 6 $\text{\textcircled{Q}}/\text{\textcircled{F}}/\text{\textcircled{O}}/\text{\textcircled{R}}$
 5099887654302 PLU/UPC
 PLU MENU1 3 $\text{\textcircled{Q}}/\text{\textcircled{F}}/\text{\textcircled{O}}/\text{\textcircled{R}}$ 5 $\text{\textcircled{Q}}/\text{\textcircled{F}}/\text{\textcircled{O}}/\text{\textcircled{R}}$
 [Select PLU code 17
 from the menu.]
 CA/AT

Print

10/16/2008	000001
#1224	11:38AM JACK0002
	7 @ 10/ \$6.00
DPT. 06	\$4.20
	8 @ 5/ \$15.00
PL00015	\$24.00
	5 @ 6/ \$7.50
5099887654302#	
ITEM-M	\$6.25
	3 @ 5/ \$17.00
PL00017	\$10.20
MOSE ST	\$44.65
TAX1	\$2.68
CASH	\$47.33

Successive multiplication entries

This function is practical for such entries as a sale of an item sold by area (square foot).

Procedure

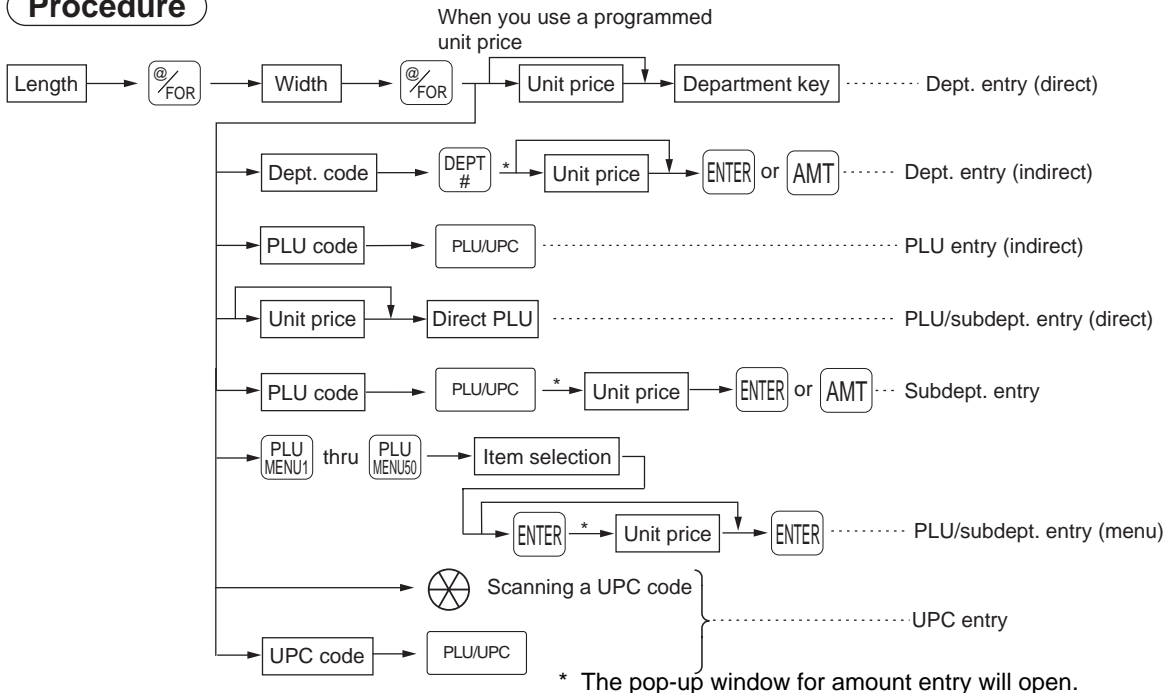

- After scanning a UPC code or entering a UPC code and pressing the $\text{\textcircled{P}}/\text{\textcircled{L}}/\text{\textcircled{U}}/\text{\textcircled{P}}/\text{\textcircled{C}}$ key, the learning UPC function may require you to enter a unit price with the display “UNDEFINED CODE”. Enter the unit price and department code to be associated with the UPC.
- Selling quantity: Up to four digits integer + three digits decimal
- Base quantity: Up to two digits (integer)

NOTE For actual use of this function, please consult your dealer.

Example

Key Operation

3 4
 400
 1 5
 2 5
 8
 1 75
 7 75

 4 5
 5099887654302
 1 2
 1 2
 [Select PLU code 50
 from the menu.]

Print

	3 @ 4 @	\$4.00
DPT. 08		\$48.00
	1.500 @ 2.500 @	\$8.00
PL00008		\$30.00
	1.750 @ 7.750 @	\$3.00
PL00003		\$40.69
	4 @ 5 @	\$1.00
5099887654302#		
ITEM-M		\$20.00
	1.200 @ 1.200 @	\$50.00
PL00050		\$72.00
CASH	\$210.69	

Scale entries

For entry of items sold by weight, a scale must be connected to read the weight automatically. To make a refund entries, enter the weight manually while the scale platter is empty or reads zero.

i) Auto scale entries

Procedure

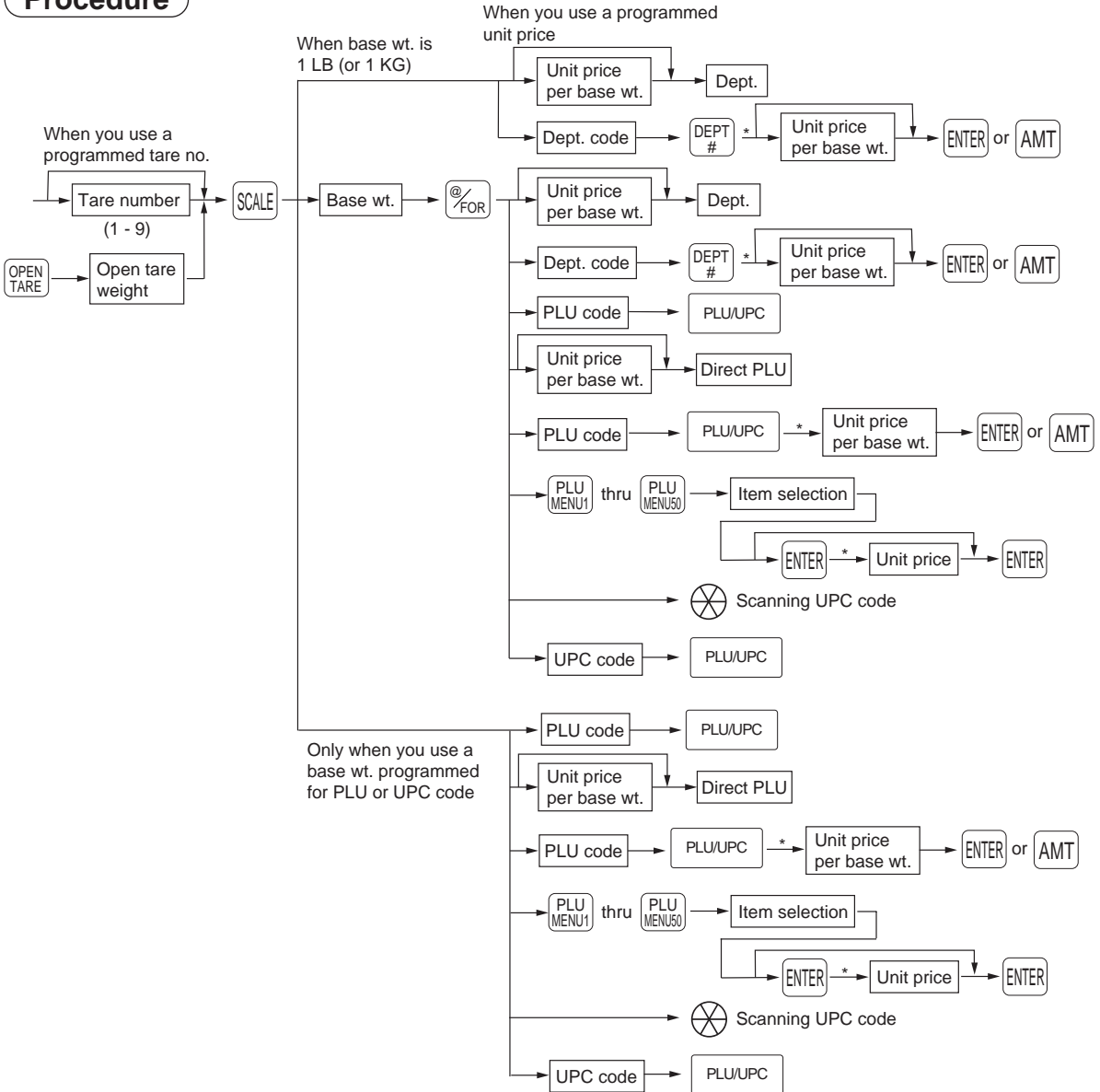

* The pop-up window for amount entry will open.

- Open tare weight: Up to 5 digits (integer + decimal)
- Net weight: Up to 5 digits (integer + decimal)
- Base weight: Up to 2 digits (integer)

NOTE

- This POS terminal can be programmed with up to nine tare tables and allows different kinds of tares to be assigned to them.
- When the **SCALE** key is pressed, the weight is automatically read from the connected scale (option) and the net weight appears on the display.
- When an item is programmed for "Scale compulsory", it is not necessary to press the **SCALE** key.

ii) Manual scale entries

Procedure

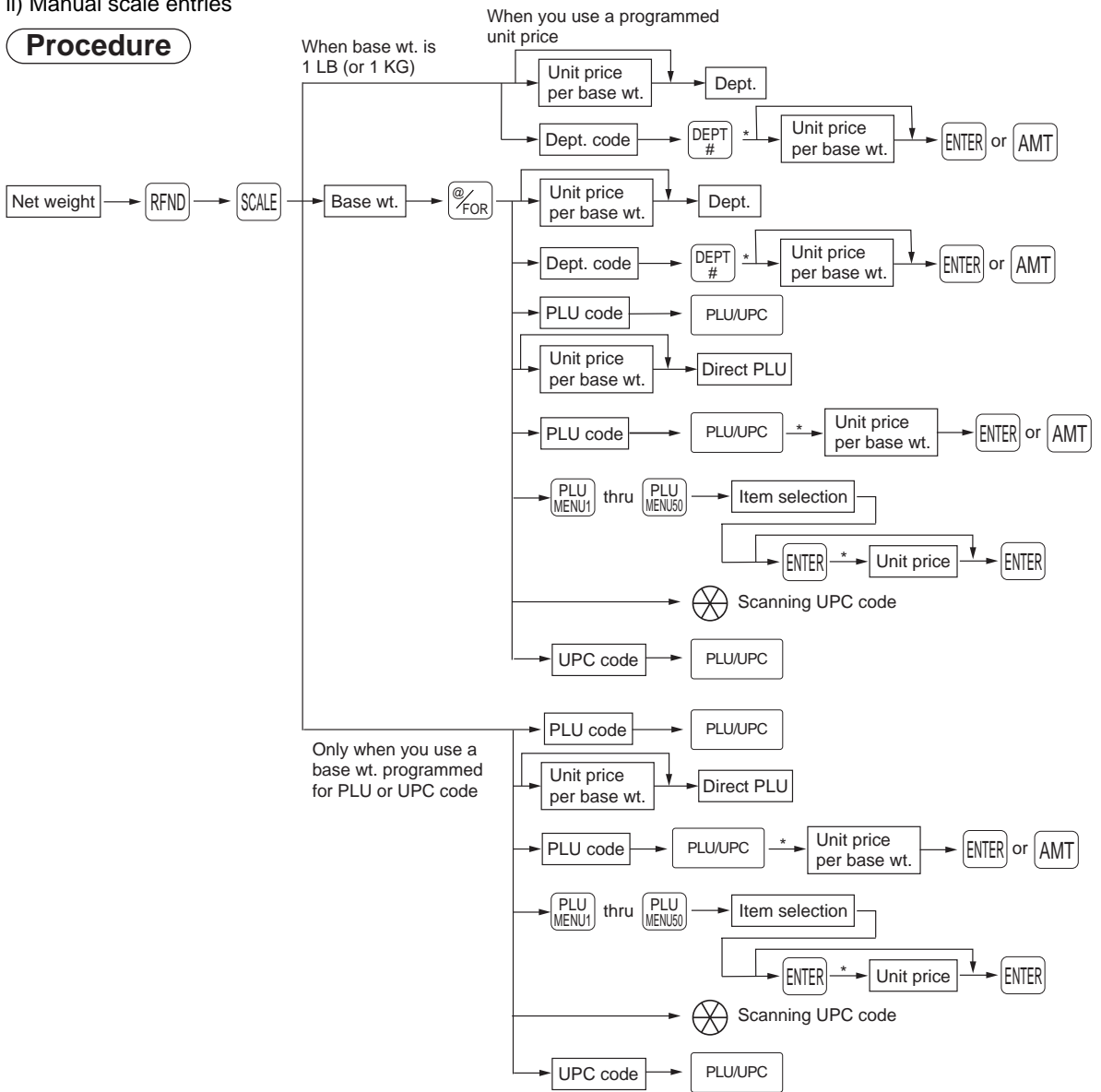

* The pop-up window for amount entry will open.

- Net weight: Up to 5 digits (integer + decimal)
- Base weight: Up to 2 digits (integer)

■ Single item cash sale (SICS) and single item finalization (SIF)

SICS entries

- This function is useful when only one item (for example, a pack of cigarettes) is sold by cash. This function is applicable only to those departments programmed for SICS or to the PLUs, subdepartments or UPC which are associated with the department.
- The transaction is finalized and the drawer opens as soon as you press the corresponding department key, key, key or the corresponding direct PLU key.

NOTE *If entry of a department, PLU/subdepartment or UPC programmed for SICS follows entries of departments, PLUs/subdepartments or UPC not programmed for SICS, the transaction is not finalized and is treated as a normal sale.*

Example

Key Operation

250
For finishing the transaction →

Print

10/16/2008	000001
#1231 12:19PM	JACK0002
DPT. 09	\$2.50
MDSE ST	\$2.50
TAX1	\$0.15
CASH	\$2.65

SIF entries

- If entry of a department, PLU/subdepartment or UPC programmed for SIF follows entries of departments, PLUs/subdepartments or UPC not programmed for SIF, the transaction is finalized immediately as a single item cash sale.
- Like the SICS function, this function is available for single-item cash settlement.

Example

Key Operation

1745
1500
For finishing the transaction →

Print

10/16/2008	000001
#1233 12:21PM	JACK0002
DPT. 08	\$17.45
DPT. 09	\$15.00
MDSE ST	\$32.45
TAX1	\$1.95
CASH	\$34.40

■ Age verification (Birthday entry)

The age verification function is used for prohibiting sales of goods (departments, PLUs, or UPCs) for to persons under a given age which are based on birthday entries.

When a department/PLU/UPC for which a figure other than zero (01 to 99) has been programmed as the age limitation (in years) is entered, a birthday entry must be performed.

Procedure

→ XXXXXX → BIRTH

Birthday (five or six digits)

NOTE

- A birthday entry can be performed two or more times at any point during a transaction, though the last entered birthday remains in effect.
- You can enter the date as far back as 98 years.
[Ex.] When the current year is 2008: you can enter a year between 1910-2008.
When the current year is 2011: you can enter a year between 1913-2011.

Special Entries for PLU/UPC

Promotion (mix-and-match) function

This function is convenient for selling a mix of different PLU/UPC items by the lump (e.g. value meal, bundle sale, etc.). Operation is the same as for normal PLU/UPC. The base quantity and unit price are assigned to a mix-and-match table. All items that are programmed into the table are treated as if they belong to one group.

- Using the UPC learning function, you can store necessary data for new UPC codes in the training mode for later use in the REG mode.

Example (For a certain PLU)

PLU00039 (ITEM D) of unit price \$2.00

Mix-and-match table no. 1 (Text: Promotion; Base quantity: 3; Price: \$5.00)

Key Operation

3

Display

3	ITEM D	\$6.00			
1	PROMOTION	-1.00			
	CASH	\$5.00			
TAX \$0.00 SBTL		\$5.00			
JACK		HOME MENU	0002		
		PIL1	10 56AM		

Example (For different PLUs)

PLU00040 (ITEM A, \$2.00), PLU00041 (ITEM B, \$3.10), and PLU00042 (ITEM C, \$2.50)

Mix-and-match table no. 2 (Text: VALUE SET; Base quantity: 3; Price: \$6.90)

Key Operation

Treated as \$2.30 item →

Treated as \$3.10 item →

Treated as \$2.50 item →

Print

ITEM A		\$2.30	
ITEM B		\$3.10	
ITEM C		\$2.50	
VALUE SET	1Q	-1.00	Promotion discount
CASH		\$6.90	

PLU/UPC link entries

It is possible to link PLUs/UPCs (linked PLUs/UPCs) with a leading link PLU/UPC so that they can be combined for a single key entry of the leading PLU/UPC. You can program a maximum of 99 leading link PLUs/UPCs. A maximum of five PLUs/UPCs can be linked to a leading PLU/UPC.

In case that you register a PLU/UPC to which any PLUs/UPCs are linked, the linked PLUs/UPCs are automatically registered together with the leading link PLU/UPC. Only the leading PLU is affected by the status shift keys (, , , , and keys). The percent calculation is in effect for the amount of the leading PLU.

Example (In case of link PLU)

Key Operation

Print

PL00021	\$16.00	
PL00025	\$2.50	Linked PLUs
PL00026	\$3.00	
PL00027	\$3.00	
CASH	\$24.50	

■ UPC learning function

When you enter or scan an undefined UPC code, you are required to enter its unit price and associated department. The entered UPC code, associated department and unit price are stored in the UPC file or the dynamic UPC file and used for future UPC sales entries.

- NOTE**
- When there is no remaining space in the file, the data is not stored in the file.
 - The text for the associated department is applied to the UPC code.
 - You can use the UPC learning function in the training mode. This may be convenient to practice on the scanning system.
 - Using the UPC learning function, you can store necessary data for new UPC codes in the training mode for later use in the REG mode.

Procedure

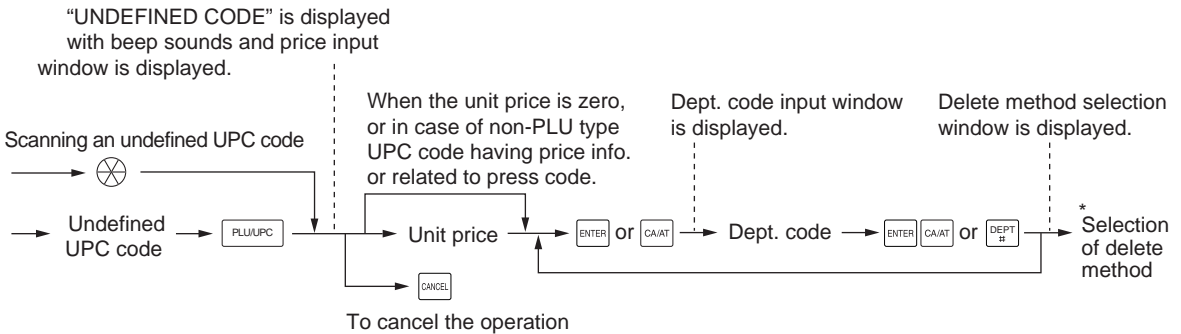

* Select “1 AUTO DELETE” when you want to exempt the UPC code entered from the non-accessed UPC delete function (deletion by selecting DELETE option from UPC DELETE menu in Z1 mode).

NOTE For repeat entry, use the **REPEAT** key.

Example

Key Operation	
“UNDEFINED CODE” is displayed.	→ 5099887654302 PLU/UPC
	750 CA/AT
	5 ENTER
Select “1 AUTO DELETE”.	CA/AT

Print	
10/16/2008	000001
#1218	10:51AM JACK0002
5099887654302#	
DPT. 05	\$7.50
MDSE ST	\$7.50
TAX1	\$0.45
CASH	\$7.95

■ PLU/UPC price inquiry (view) function

This function displays the unit price of a PLU/UPC item (view mode).

Procedure

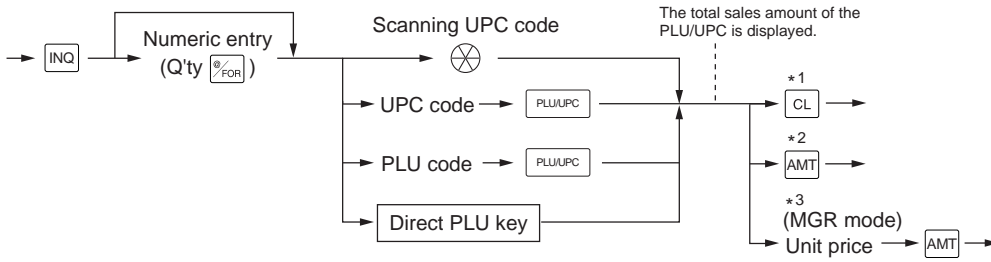

*1: Press the keys to cancel the view mode.

*2: Press the key to register the displayed unit price of the PLU/UPC item.

*3: The manager can change the unit price temporarily. The unit price programmed in the PGM mode can not be changed. The manager need to enter his or her manager code and secret code before the manager's operation.

NOTE For repeat entry, use the key.

■ UPC price change function

NOTE To use this function, consult your dealer.

The manager and servers/cashiers can use this function when they need to change the unit price or associated department of a UPC item.

There are two methods for change:

1. Price change mode

You can change the preset price and/or the associated department of a UPC item without entering the PGM mode.

2. Changing price during a transaction

When you have found an incorrect UPC price and/or associated department upon transaction, you can correct them during the transaction. Upon entry of new price and/or associated department, the preset price and/or associated department is automatically changed to the new price and/or associated department.

NOTE For Non-PLU type prices embedded in UPC-A codes and press codes, the prices in the codes have priority over the preset prices. So, for these codes, a changed price is valid only during the current transaction.

Procedure

Price change mode

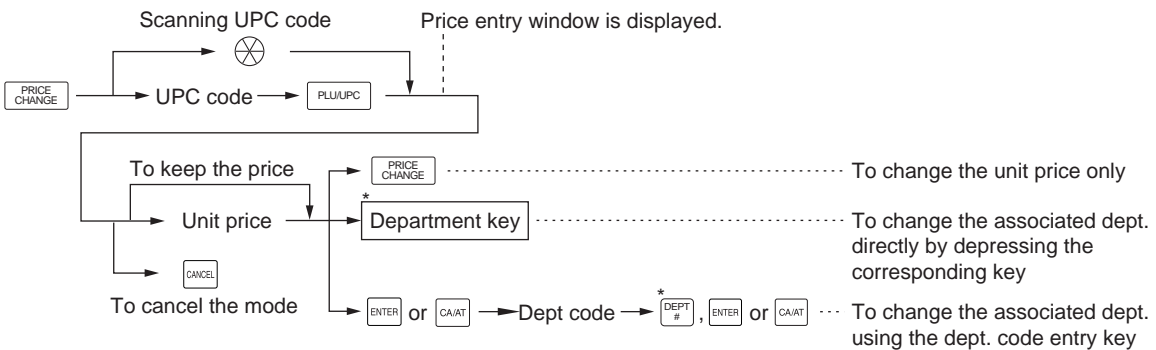

Changing price during a transaction

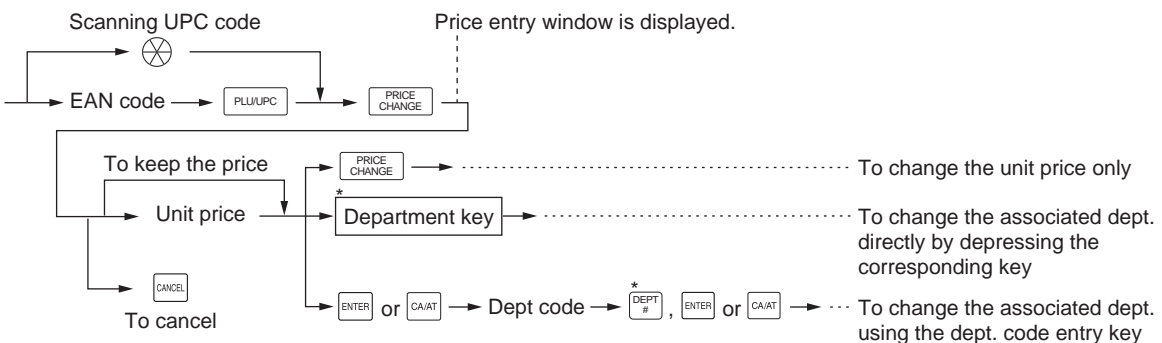

*: Associated department can be changed only when the totalizer of the item is "0".

Example**Price change mode****Key Operation**

5087654321106
 600

Print

PR. CHNG	
DEPT01	
5087654321106#	
ITEM J	\$6.00

Example**Changing a price during a transaction****Key Operation**

5087654321106
 600



Print

PL00001	\$1.00	
5087654321106#		
ITEM J	\$6.00	Price change
CASH	\$7.00	

NOTE

- When an undefined code is entered in the price change mode, the POS terminal goes to an error status.
- During a transaction, you can void the UPC entry by the first depression of the key, then you can enter a correct price and/or associated department.
- When an associated department is changed, the item label for the department will be also changed automatically.
- For repeat entry, use the key.

■ PLU level shift (for direct PLUs)

This function can increase the number of direct PLUs on your POS terminal without adding additional direct PLU keys. You can use direct PLUs in five levels by utilizing the PLU level shift keys  thru . The level key shifts the PLU level to the required level. (The normal level is level 1.)

You must program your machine in the PGM2 mode to select one of the two PLU level shift modes — automatic return mode* or lock shift mode** — and decide whether to allow both the manager and servers/cashiers or only the manager to perform the PLU level shift function.

- * The automatic return mode automatically shifts the PLU level back to the preset level after pressing a direct PLU key or finalizing each transaction.
- ** The lock shift mode holds the current PLU level until another PLU level shift key is pressed.

Automatic return mode (for PLU levels)

If your terminal has been programmed for PLU level shift in the automatic return mode, press a desired PLU level shift key before a numeric entry.

Procedure

(Returning every item entry to the preset level)



(Returning every transaction to the present level)

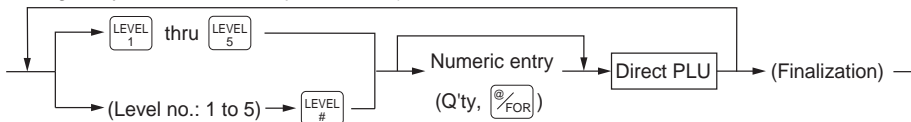



NOTE When using the FF method (PLU), you need not press the  key for a multiplication entry.

Lock shift mode (for PLU levels)

If your terminal has been programmed for PLU level shift in the lock shift mode, press a desired PLU level shift key before a numeric entry.

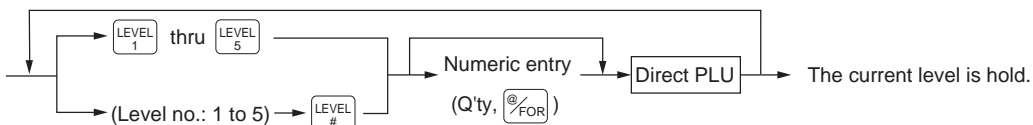
Procedure



NOTE • When using the FF method (PLU), you need not press the  key for a multiplication entry.







■ PLU price level shift

NOTE To use this function, please consult your authorized SHARP dealer.

Six different price levels can be programmed for each PLU.

The price levels can be changed for each PLU registration.

These keys have the following functions:

-  : Shifts the PLU price level from level 2, 3, 4, 5, or 6 to level 1 (base level).
-  : Shifts the PLU price level from level 1, 3, 4, 5, or 6 to level 2. When you press this key, the price level shift indicator will show "P2."
-  : Shifts the PLU price level from level 1, 2, 4, 5, or 6 to level 3. When you press this key, the price level shift indicator will show "P3."
-  : Shifts the PLU price level from level 1, 2, 3, 5, or 6 to level 4. When you press this key, the price level shift indicator will show "P4."
-  : Shifts the PLU price level from level 1, 2, 3, 4, or 6 to level 5. When you press this key, the price level shift indicator will show "P5."
-  : Shifts the PLU price level from level 1, 2, 3, 4, or 5 to level 6. When you press this key, the price level shift indicator will show "P6."

* The automatic return mode shifts the PLU price level back to level 1 after a PLU entry automatically. You can select whether the PLU price level should return to level 1 each time you enter one item or each time you finalize one transaction.

** The lock shift mode holds the current PLU price level shift until a price level shift key is pressed.

Automatic return mode (for price shifts)

If your terminal has been programmed for PLU/UPC price level shift in the automatic return mode, press a desired price level shift key before a numeric entry.

Procedure

(each item)

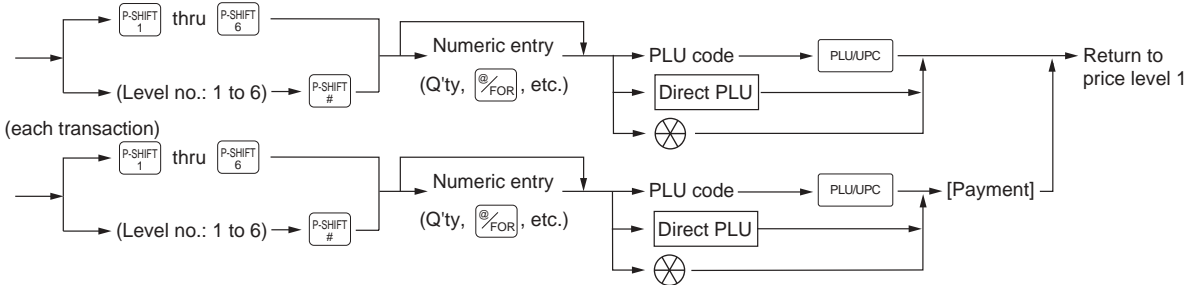

NOTE When you use the FF method (PLU), you need not press the  key for a multiplication entry.

Lock shift mode (for price shifts)

If your terminal has been programmed for PLU/UPC price level shift in the lock shift mode, press the desired price level shift key before a numeric entry.

Procedure

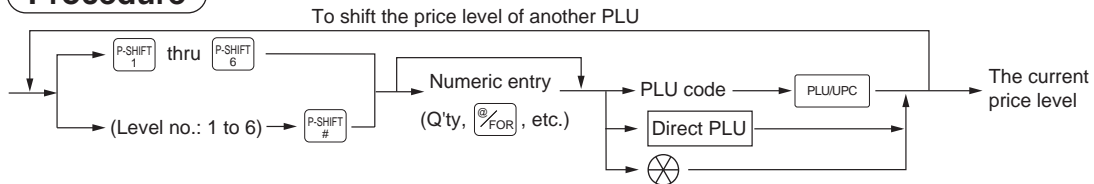

- NOTE**
- If you select the automatic return mode, it is not necessary to use the **P-SHIFT 1** key on the keyboard. If you select the lock shift mode, it is necessary to use the **P-SHIFT 1** key.
 - When you use the FF method (PLU), you need not press the **%/FOR** key for a multiplication entry.

Combo meal entries

The operation is the same as for normal PLU entries.

When a combo meal is entered with a combo (function) key, the labels of those PLUs linked to the combo key can be printed automatically. The sum of all adjusted prices (of the PLUs linked to the combo key) is the “combo meal” price.

- NOTE**
- When a combo meal is entered with a combo key, the quantity totalizer of the combo key and the amount totalizers of the linked PLUs are updated.
 - When the **UPSIZE** key is pressed with the cursor pointing at a combo meal selected, the combo meal entry of 1st price level is voided and the combo meal of 2nd price level is registered.

Condiment entries (for PLU)

Your POS terminal may be programmed to prompt you to condiment and preparatory instructions for a menu-item PLU.

Example:

When you enter a menu-item PLU, a prompting message such as “HOW COOK?” and a list of the “Following PLUs” will appear. You must specify one of the “Following PLUs” such as “without mustard” to meet a special order of the guest. In an example of the condiment table shown below, it is assumed that the condiment table no.1 is assigned to PLU code 21 (programmed text “STEAK”) and table no. 4 is linked to table no. 1 as the next table no. When you enter the PLU code 21, the message “HOW COOK?” will appear to prompt you to choose one option from “RARE,” “MED.RARE,” and “WELLDONE.” If the guest chooses “RARE,” enter it. Then the next message “POTATO?” will appear to prompt you to choose one option from “P.CHIPS,” “MASHED P.,” and “BAKED P.” If the guest chooses “MASHED P.,” enter it. Then press the **CA/AT** key to end this entry.

An example of linked condiment tables is shown below.

Table number	PLU codes for condiment entry (programmed text, price)			Next table no.	
1	(HOW COOK?)	23 (RARE 0.00)	25 (MED.RARE 0.00)	27 (WELLDONE 0.00)	4
4	(POTATO?)	33 (P. CHIPS 0.60)	37 (MASHED P. 0.60)	38 (BAKED P. 0.50)	_____

Menu-item PLUs Message text PLUs

Example

Key Operation

21

[Touch "RARE"
on the keyboard.]

[Touch "MASHED P."
on the keyboard.]

CA/AT

Print

1 STEAK A	\$21.00	▲ RARE		
		MED. RA		
		RE		
		WELL DO		
		NE		
TAX \$1.26	SBTL \$22.26	▼		
STEAK A		HOW COOK?	0002	
	\$21.00	P1L1	11 42AM	

1 STEAK A	\$21.00	▲ P. CHIP		
1 RARE		S		
		MASHED		
		P.		
		BAKED		
		P.		
TAX \$1.26	SBTL \$22.26	▼		
RARE		POTATO?	0002	
		P1L1	11 43AM	

1 STEAK A	\$21.00	▲		
1 RARE				
1 MASHED P.	\$0.60			
MDSE ST	\$21.60			
TAX1	\$1.30			
CASH	\$22.90			
TAX \$1.30	SBTL \$22.90	▼		
JACK		HOME MENU	0002	
		P1L1	11:43AM	

NOTE

- When the condiment entry is programmed as compulsory, your POS terminal will continue to prompt condiment entry until you finish the entire condiment entry programmed for the PLU. During the condiment entry, if you enter a PLU which is not in the condiment table, an error message will appear.
- When the condiment entry is programmed as non-compulsory, entering a PLU which is not in the condiment table cancels the condiment entry.
- When the **CANCEL** key is pressed, the entry skips to the next condiment table which is programmed.
- When you enter a PLU priced at "0.00," only the text may be printed on the receipt.
- No refund entry is possible for any condiment entries. When you perform a refund entry with a menu-item PLU, the condiment PLUs assigned to the menu-item PLU are automatically registered as a refund entry.
- You may omit the compulsory condiment entry by pressing the **CANCEL** key.
- Cursor void entry or touching void entry is allowed for those PLUs that are entered as condiments (menu and condiment).
- Multiplication entry can be made for each condiment item independently. However, the sum of manually entered quantities per condiment table should not be more than the ordered quantity of the menu PLU. When no multiplication entry is made, the quantity is decided automatically to reach the ordered quantity number of the menu PLU.
- You can press the **P-SHIFT #** key to shift the price level during condiment PLU entry.

Repeat round entries

This function can be used for reorder entries of PLU items (single PLU item and condiment PLU) simply by depressing the **REPEAT ROUND** key. To enable this function, the PLU must be preset as "yes" for repeat entries.

Upon the first depression of the **REPEAT ROUND** key, those items that were previously registered in a transaction are shown as reorderable items, and upon second depression of the **REPEAT ROUND** key, those items registered after the previous depression of the **REPEAT ROUND** key including the first reordered items are shown as reorderable items.

NOTE

When the **VOID** key is pressed just after the depression of the **REPEAT ROUND** key, all items subjected to the repeat round entry are voided.

Display of Subtotals

Your POS terminal provides these eight types of subtotals:



■ Merchandise subtotal

You may press the  key at any point during a transaction.



The net sales subtotal - not including tax - and the symbol "MDSE ST" will appear in the display.

■ Taxable subtotal



Taxable 1 subtotal

Press the  and  keys in this order at any point during a transaction. The sales subtotal of taxable 1 items will appear in the window and the caption "TAX1" and the tax 1 amount will appear.



Taxable 2 subtotal

Press the  and  keys in this order at any point during a transaction. The sales subtotal of taxable 2 items will appear in the window and the caption "TAX2" and the tax 2 amount will appear.



Taxable 3 subtotal

Press the  and  keys in this order at any point during a transaction. The sales subtotal of taxable 3 items will appear in the window and the caption "TAX3" and the tax 3 amount will appear.

Taxable 4 subtotal

Press the  and  keys in this order at any point during a transaction. The sales subtotal of taxable 4 items will appear in the window and the caption "TAX4" and the tax 4 amount will appear.

Taxable 5 subtotal

Press the  and  keys in this order at any point during a transaction. The sales subtotal of taxable 5 items will appear in the window and the caption "TAX5" and the tax 5 amount will appear.

■ Tax-inclusive subtotal (full subtotal)

You may press the  key at any point during a transaction. The sales subtotal including tax and the symbol "SUBTOTAL" will appear in the display.

■ Tray subtotal

You may press the  key during a transaction in the REG.

The contents of the tray total itemizer which includes tax are printed and displayed.

■ Eat-in subtotal

You may press an eat-in key prior to entering a payment. Your POS terminal will calculate a subtotal according to the programmed tax exemption status and display the subtotal, the symbol "EAT IN," and a corresponding caption ("EAT IN 1," "EAT IN 2," or "EAT IN 3") will be displayed.



For a transaction with an eat-in subtotal, you must finalize the transaction by making a payment entry. Just after pressing the eat-in key, however, you can cancel the entry of that key by pressing the  key or another eat-in key.

■ Food stamp-eligible subtotal



You may press the  key at any point during a transaction. The sale subtotal of items eligible for food stamp payment will appear in the display.

■ Group discountable subtotal



Group 1 discountable subtotal

You may press the  GD1 SHIFT and  keys in this order at any point during a transaction.

Group 2 discountable subtotal

You may press the  GD2 SHIFT and  keys in this order at any point during a transaction.

Group 3 discountable subtotal

You may press the  GD3 SHIFT and  keys in this order at any point during a transaction.

■ Gasoline discount subtotal

You may press the  key and select the payment media at any point during a transaction. The gasoline discount subtotal will appear in the display.

Holding/Recalling of Transaction

Hold/Recall Function

This function can be used during entry of a transaction to start entry of the next transaction. For example, if it seems to take time for a guest to make payment, by pressing the HOLD/RECALL key or touching "HOLD/RECALL" in the keyboard area of the display, you can start entry of a transaction with the next guest. While the former transaction is held, the red mark "HOLD" appears in the top left corner of the display indicating that the transaction is held. You can resume the transaction with the former guest by pressing or touching the key again (RECALL).

If you like to use this function, consult your authorized SHARP dealer.

Procedure

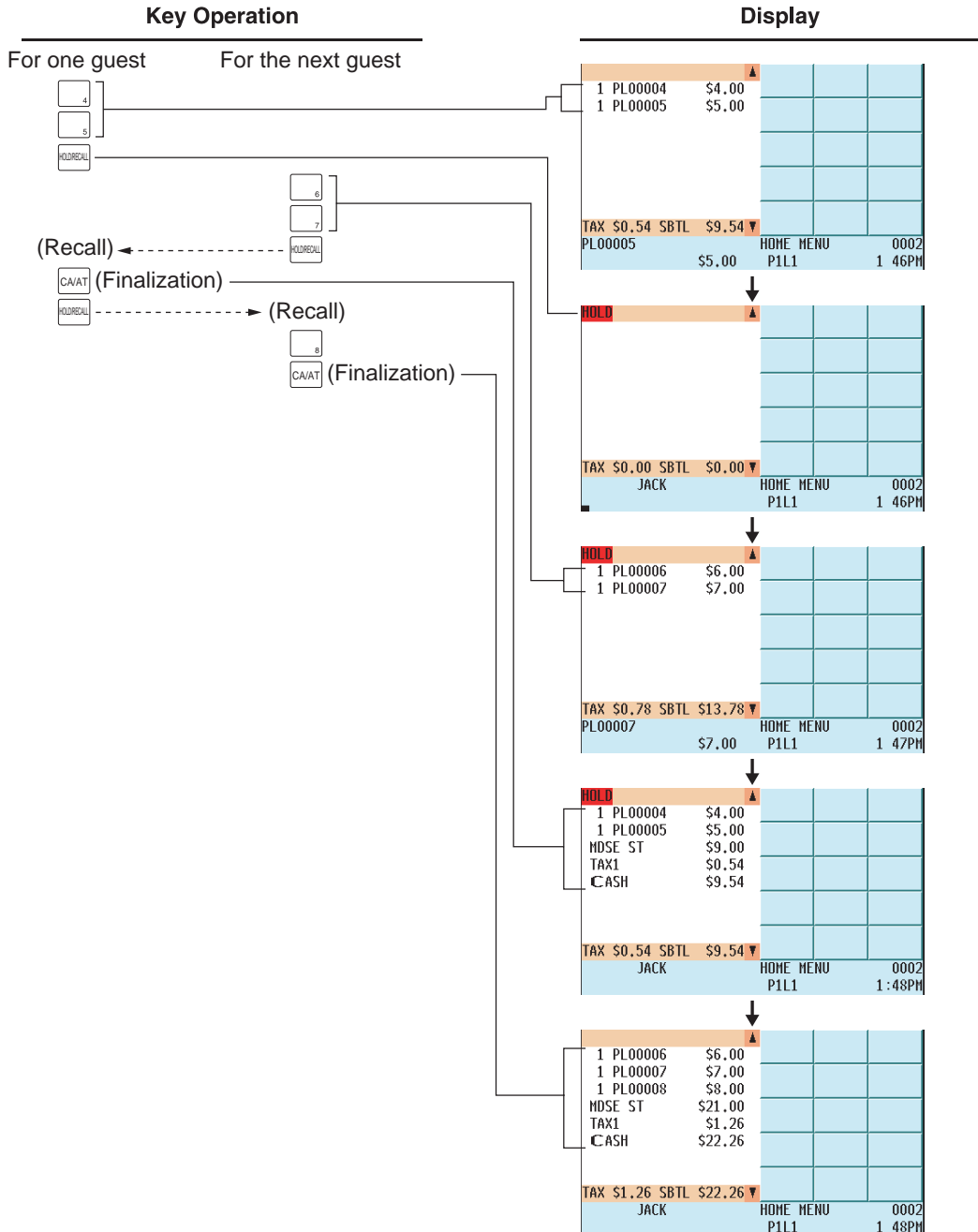

Finalization of Transaction

■ Cash or Check tendering

Press the key to get the tax-inclusive subtotal, enter the amount tendered by your customer, then press any of the thru keys if it is a cash tender or press any of the thru key if it is a check tender. When the amount tendered is greater than the amount of the sale, your POS terminal will show the amount of change due and the symbol "CHANGE." Otherwise your POS terminal will show the symbol "DUE" and the deficit amount. To settle the deficit amount, another tender amount equal to or equal to or exceeding the amount due must be entered.

NOTE • You can also enter a check or cash tender from the check or cash menu window. Press the or key and select the desired check or cash media key and enter the amount.

■ Mixed tendering (check + cash)

Mixed tendering of check and cash is possible. After pressing the key, enter the amount tendered by your customer in check or cash, and press the corresponding key, then again enter the amount tendered in cash or check, and press the corresponding key.

■ Cash or check sale that does not need any tender entry (Exact Payment)

Enter items and press any of the thru key if it is a cash sale or press any of the thru keys if it is a check sale. Your POS terminal will display the total sales amount.

■ Charge (credit) sale

Enter items and press the corresponding charge keys (thru).

NOTE • Amount tendering operations (i.e. change calculations) can be achieved by using the thru key when PGM2-mode programming your POS terminal has been preset programmed for amount tender compulsory in the PGM2 mode.

• When charge tendering is performed with EFT/ACCT compulsory, the corresponding card authorization sequence is initiated.

• You can also enter a charge tender from the charge menu window. Press the key and select the desired charge media key and enter the amount.

■ Mixed-tender sale (cash or check tendering + charge tendering)

In case of mixed tendering of cash and charge, press the key to get a tax-inclusive subtotal, enter the amount tendered in cash by your customer, and press the thru key. Then press an appropriate charge key to settle the payment of a deficit.

In case of mixed tendering of check and charge, tendering, use press the thru keys in place of the thru key.

■ Positive/Negative code checking function

The Positive/Negative code checking function can be used to inhibit an entry of any invalid code by checking whether the entered non-add code, such as a card or check code, is valid (positive) or invalid (negative).

For details, please consult your authorized SHARP dealer.



■ Food stamp tendering

If your customer makes payment (or tendering) by food stamps, obtain the food stamp-eligible subtotal* by pressing the  key and make a food stamp tender entry before entering a cash or check tender.

* Note: The food stamp-eligible subtotal depends upon how your POS terminal is programmed about the food stamp-eligibility of the automatic tax on a sale of items eligible for food stamp payment, or whether your POS terminal is programmed to allow the automatic tax to be paid with food stamps or not or to exempt taxation. The example below presupposes that your POS terminal has been programmed to exempt taxation.

- ① When the amount tendered in food stamps is greater than the food stamp-eligible subtotal: Your POS terminal shows two amounts of change due in its on the display: the food stamp change due appears at the left on the display and the cash change due at the right.
- ② When the food stamp tender is smaller than the food stamp-eligible subtotal:
 - The remainder may be paid by food stamps, or in cash or check.However, if your POS terminal is programmed to exempt taxation, it cannot accept an additional food stamp tender.

■ Food stamp status shift

Your POS terminal allows you to shift the programmed food-stamp status of each department,  thru , percent key, the UPC or the PLU key by pressing the  key prior to pressing those keys. After the status shift operation each entry is completed, the programmed food stamp status is resumed.

Tax Calculations

Automatic tax

When your POS terminal is programmed with a tax table (or tax rate) and a department or PLU is set for programmed as taxable, it automatically computes the tax on any item that is entered directly into the department or indirectly via a related PLU.

Display Example

	1 DPT.02	\$25.00			
	1 DPT.03	\$0.32			
Tax and subtotal	TAX \$1.52	SBTL \$26.84			
	DPT.03	\$0.32	HOME MENU		0001
			P1L1		2 54PM

	1 DPT.02	\$25.00	CHG1	CHG6	
	1 DPT.03	\$0.32	CHG2	CHG7	
Tax	MDSE ST	\$25.32	CHG3	CHG8	
	TAX1	\$1.52	CHG4	CHG9	
	CHARGE1	\$26.84	CHG5		
Tax and subtotal	TAX \$1.52	SBTL \$26.84			
	MIKE		CHARGE MENU		0001
			P1L1		2:55PM

Manual tax

Your POS terminal allows you to enter tax manually after item entries as follows:
After an item entry, enter the tax amount and press the **TAX** key.

Example

Key Operation	Display																																			
<div style="display: flex; align-items: center; gap: 10px;"> <div style="border: 1px solid black; border-radius: 50%; width: 30px; height: 30px; display: flex; align-items: center; justify-content: center;">10</div> <div style="font-size: 24px;">60</div> <div style="border: 1px solid black; border-radius: 50%; width: 30px; height: 30px; display: flex; align-items: center; justify-content: center;">TAX</div> <div style="border: 1px solid black; border-radius: 50%; width: 30px; height: 30px; display: flex; align-items: center; justify-content: center;">CA/AT</div> </div>	<table border="1"> <tr> <td>1 PL00010</td> <td>\$10.00</td> <td>TAX</td> <td></td> <td></td> </tr> <tr> <td>M-TAX</td> <td>\$0.60</td> <td>TAX1SF</td> <td></td> <td></td> </tr> <tr> <td>CASH</td> <td>\$10.60</td> <td>TAX2SF</td> <td></td> <td></td> </tr> <tr> <td></td> <td></td> <td>TAX3SF</td> <td></td> <td></td> </tr> <tr> <td>TAX \$0.00</td> <td>SBTL \$10.60</td> <td></td> <td></td> <td></td> </tr> <tr> <td>JACK</td> <td></td> <td>FUNCTION MENU11</td> <td></td> <td>0002</td> </tr> <tr> <td></td> <td></td> <td>P1L1</td> <td></td> <td>2 16PM</td> </tr> </table>	1 PL00010	\$10.00	TAX			M-TAX	\$0.60	TAX1SF			CASH	\$10.60	TAX2SF					TAX3SF			TAX \$0.00	SBTL \$10.60				JACK		FUNCTION MENU11		0002			P1L1		2 16PM
1 PL00010	\$10.00	TAX																																		
M-TAX	\$0.60	TAX1SF																																		
CASH	\$10.60	TAX2SF																																		
		TAX3SF																																		
TAX \$0.00	SBTL \$10.60																																			
JACK		FUNCTION MENU11		0002																																
		P1L1		2 16PM																																

■ Tax deletion

You can delete the automatic tax on the taxable 1, taxable 2, taxable 3, taxable 4, or taxable 5 subtotal of each transaction with the following procedure. Press the corresponding TAX SHIFT key and then the subtotal key. After the subtotal is displayed, press the **TAX** key.

Example

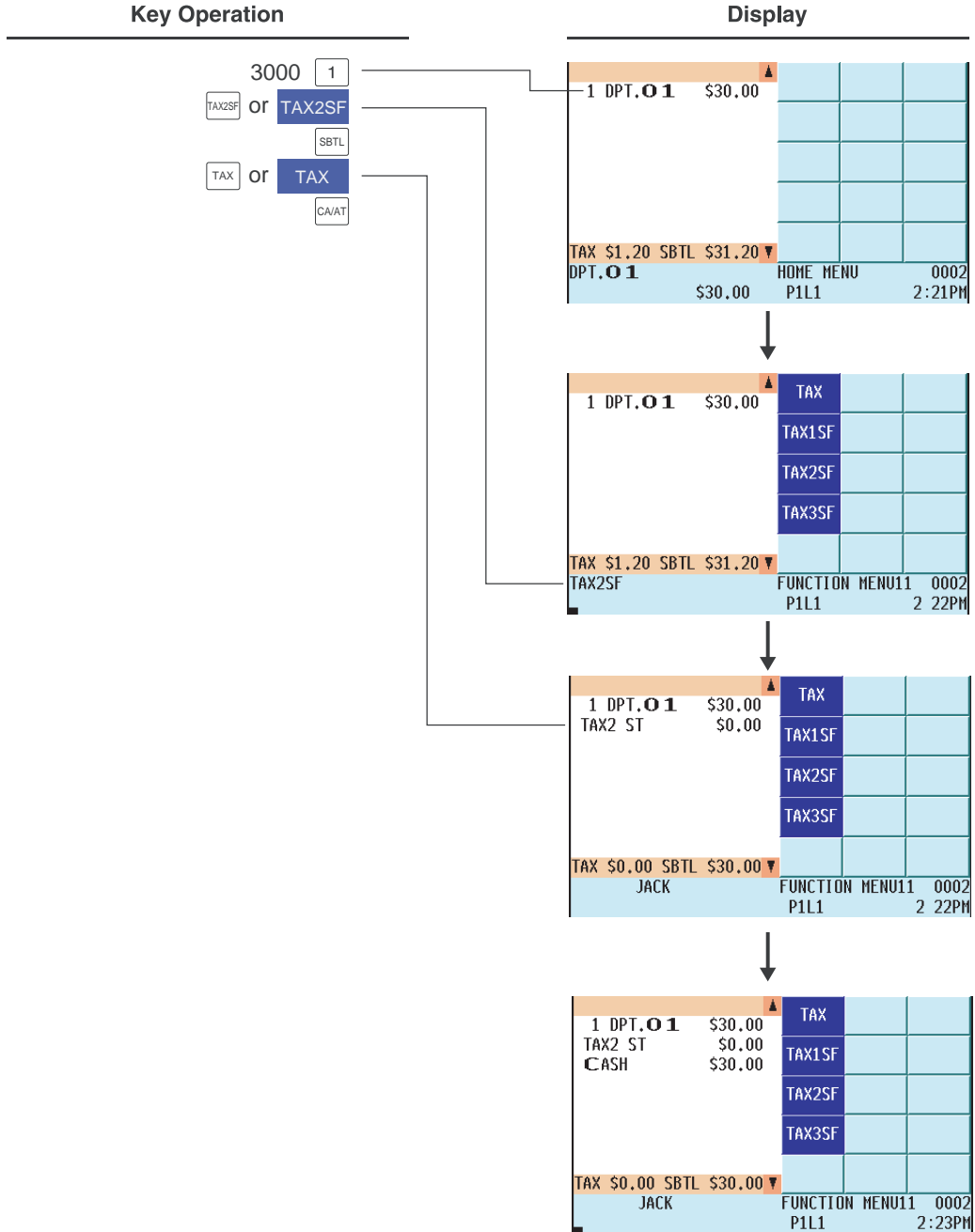

NOTE

If any of the media keys (i.e. cash, check 1 thru check 9, or charge 1 thru charge 9) is programmed for tax deletion in the PGM2 mode, the tax can be deleted without using the procedures above. In this case, pressing the corresponding media key programmed for tax deletion will always cause the selected tax to be deleted.

■ Tax status shift

Your POS terminal allows you to shift the programmed tax status of a department or PLU key or discount or percent key by pressing the **TAX1 SF**, **TAX2 SF**, **TAX3 SF**, **TAX4 SF** and/or **TAX5 SF** keys before that key. After the entry is completed, the programmed tax status of the key is resumed.

Example

Key Operation



Display

TAX		
TAX1SF		
TAX2SF		
TAX3SF		
TAX \$0.00 SBTL \$0.00		
JACK	FUNCTION MENU11	0002
3000	P1L1	6:00PM

TAX		
TAX1SF		
TAX2SF		
TAX3SF		
TAX \$0.00 SBTL \$0.00		
TAX1SF	FUNCTION MENU11	0002
3000	P1L1	6:00PM

1 DPT.01	\$30.00	TAX		
		TAX1SF		
		TAX2SF		
		TAX3SF		
TAX \$3.00 SBTL \$33.00				
DPT.01	FUNCTION MENU11		0002	
\$30.00	P1L1		6:00PM	

1 DPT.01	\$30.00	TAX		
NDSE ST	\$30.00	TAX1SF		
TAX1	\$1.80			
TAX2	\$1.20	TAX2SF		
CASH	\$33.00	TAX3SF		
TAX \$3.00 SBTL \$33.00				
JACK	FUNCTION MENU11		0002	
	P1L1		6:01PM	

NOTE The entry of a multi-taxable item for PST and/or GST is prohibited as follows (for Canada):

In case of; Tax 1: PST, Tax 2: PST, Tax 3: PST, Tax 4: GST, Tax 5: PST

Taxable 1 and 2 item	prohibited
Taxable 1 and 3 item	prohibited
Taxable 1 and 4 item	allowed
Taxable 1 and 5 item	prohibited
Taxable 2 and 3 item	prohibited
Taxable 2 and 4 item	allowed
Taxable 2 and 5 item	prohibited
Taxable 3 and 4 item	allowed
Taxable 3 and 5 item	prohibited
Taxable 4 and 5 item	allowed

In case of; Tax 1: PST, Tax 2: PST, Tax 3: GST, Tax 4: GST, Tax 5: PST

Taxable 1 and 2 item	prohibited
Taxable 1 and 3 item	allowed
Taxable 1 and 4 item	allowed
Taxable 1 and 5 item	prohibited
Taxable 2 and 3 item	allowed
Taxable 2 and 4 item	allowed
Taxable 2 and 5 item	prohibited
Taxable 3 and 4 item	prohibited
Taxable 3 and 5 item	allowed
Taxable 4 and 5 item	allowed

Guest Check (GLU/PBLU)

Two different guest check entry systems are available: the GLU system and previous balance lookup (PBLU) system. It depends on how your POS terminal has been programmed which of these is used.

(Consult your authorized SHARP dealer for this selection.)

GLU system: If this system is selected, the balance due and details of the order are saved in the guest check file. The information can be recalled for additional ordering or finalization by pressing the  key, or entering a GLU code.

PBLU system: If this system is selected, the previous balance is stored in the previous balance lookup file (PB lookup file). The information can be recalled for additional ordering by entering a previous balance lookup code (a PBLU code).

■ GLU/PBLU system

Procedure

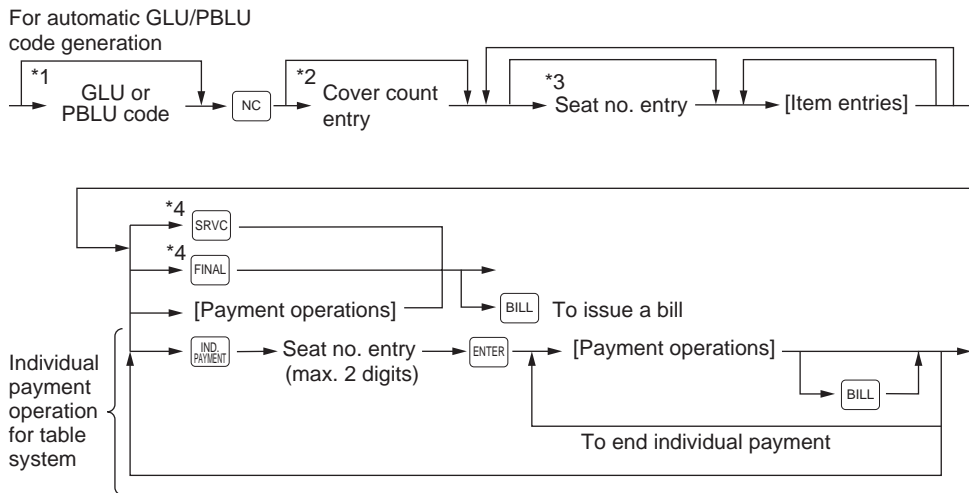



NOTE



- The GLU/PBLU code refers to a number/code that will be used whenever the guest check must be accessed for re-ordering or final payment. The range of GLU or PBLU codes that can be entered in each terminal can be programmed, and also can be specified in the OPX/Z mode for each server.
- Your POS terminal can be programmed for table #/PBLU codes in a sequential fashion. If your POS terminal has not been so programmed, table #/PBLU codes can be entered manually.

*1 GLU/PBLU code: 1 to 9999

When the range of GLU or PBLU codes is programmed in the PGM2 mode and/or specified in the OPX/Z mode, a GLU code that can be entered is limited to the range.



*2 The cover count refers to the number of people in a party. When cover count entry is compulsory, you must enter the cover count (max. 2 digits). When cover count entry is not compulsory, enter the cover count and press the  key; however, in the table system, it is automatically calculated by the number of times the  key is pressed. (When the cover count is not entered and the  key is not pressed, the cover count is counted as 1.)

*3 Seat # entry is only for the table system.

When seat # entry is compulsory, you must enter a seat #. To enter the first person #, enter the seat # (max. 2 digits) and press the  key. To enter the second or subsequent person#, enter the number and press the  key.

The number of times of seat # entry must not exceed the entered cover count.

*4 These are of optional functions (Temporary finalization).

You can temporarily finalize a guest check by pressing the  or  key. It is advisable to use the

SRVC key when printing is not desired and to use the **FINAL** key when printing of the current balance including tax is desired. Even after this temporary finalization operation, the guest check is still “open”.

This means you can still make additional orders for the guest check.

GLU recall

Each server can recall his or her GLUs for reorder entry or settlement by pressing the **GLU RECALL** key. On the display, the list of GLUs that are still open is displayed. Select the desired GLU and press the **ENTER** key, or enter the desired GLU and press the **GLU** key while the recall window is shown on the display.

The recall window will be displayed automatically if so programmed.

GLU RECALL	P UP ▲	CAN	·	CL
#1	\$16.96	CEL		
#2	\$21.20	7	8	9
		4	5	6
		1	2	3
		0	00	ENTR
TAX \$1.20	SBTL \$20.00	P DOWN ▼		
JACK				0002
	P1L1		10	26AM

An example of GLU recall window

Reorder entries

For making additional guest check entries;

Procedure

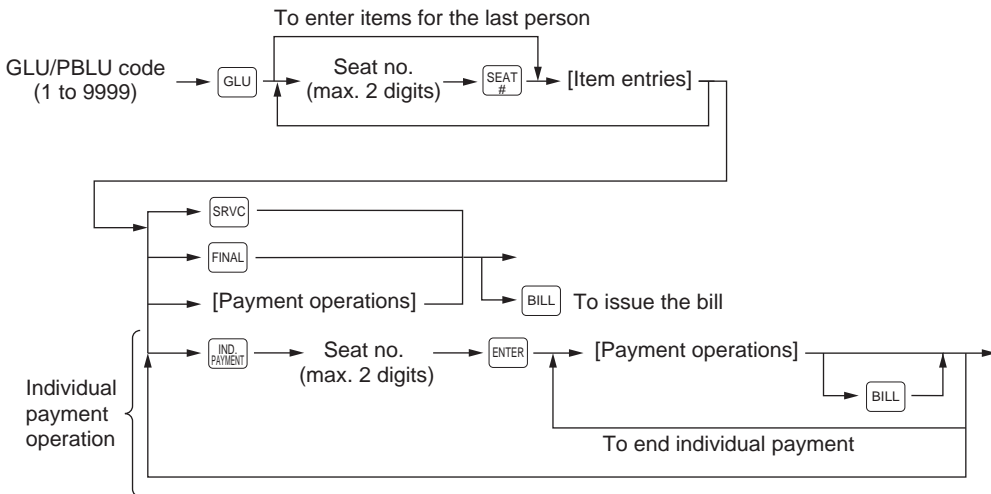

Settlement

Use the following procedure:

Procedure

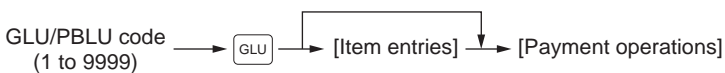

NOTE You can make a tip-in entry before a tender entry. For a tip-in entry, the tip amount must be entered by using the associated media key e.g. CH1 thru CH9 for the charge tip and CASH 1 thru CASH 5 for the cash tip.

■ Deposit entries

Deposit refers to a prepayment on a guest check. It can be received as a cash, check or charge tender.

You can make a deposit entry only when entering a guest check. It cannot be done during handling of a tendered amount.



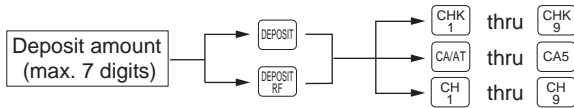

A received deposit can be refunded by pressing the  key. You cannot attempt to refund an amount larger than the deposit balance.

Procedure







Example

Key Operation





101 
 5000  (or )

Display





TBL #101				
***PBAL	\$0.00			
CASH				
DEPOSIT	\$50.00			
TAX \$0.00	SBTL -50.00			
JACK		FUNCTION MENU15	0002	
		P1L1	5 08PM	

Example

Key Operation

101 
 5000  (or )

Display

TBL #101				
***PBAL	\$0.00			
CASH				
DEPOSIT	\$50.00			
CASH				
DPST RF	-50.00			
TAX \$0.00	SBTL \$0.00			
JACK		FUNCTION MENU15	0002	
		P1L1	5 17PM	

■ Transferring guest checks out or in (Transfer-out/in)

Transferring guest checks out

At the end of server shift or whenever a server is relieved, the server's responsibility for one or more open guest checks can be released to transfer it to another server.

Procedure

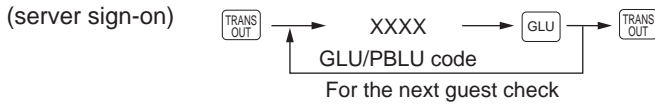

Example

Key Operation

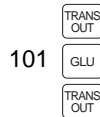

Print

```

11/09/2008 000001
#1330 5:35PM JACK0002

*TRAN. OUT*
***PBAL TBL#101 $13.00
  
```

Transferring guest checks in

When the second server is assigned to be responsible for guest checks that have been transferred out:

Procedure

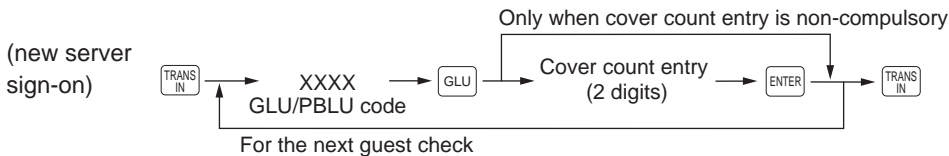

Example

Key Operation

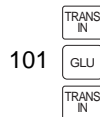

Print

```

11/09/2008 000001
#1333 5:38PM MIKE0001

*TRAN. IN*
***PBAL TBL#101 $13.00
  
```

■ Bill totalizing/bill transfer

Bill totalizing

The bill totalizing function is used to combine multiple bills. The function is useful, for example, when a particular guest pays not only his or her bill, but also the bills of other guests (Adding guest checks).

Procedure

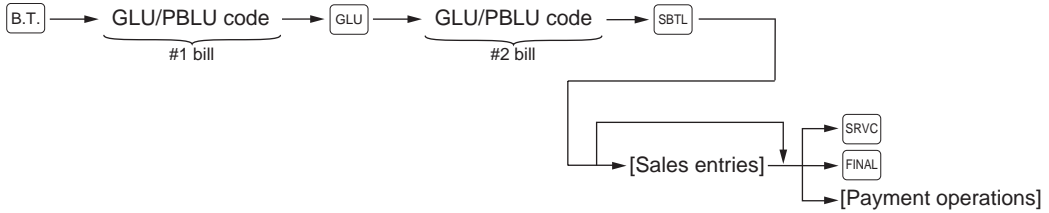

NOTE

- A #1 bill is added to a #2 bill. A maximum of 5 bills may be added to a #2 bill.
- The GLU/PBLU code of #1 must be in use. If the guest check(s) of #1 or #2 has already been handled by another server, the guest check(s) must have been transferred out (by the Transfer-out operation).
- After the bill totalizing operation, the individual payment function is not allowed.

Example

Key Operation

B.T.
 102 GLU
 103 SBTL
 SERV

Display

TBL #103		B.T.	
***PBAL	#102	TRANS	
	\$0.00	OUT	
1 PL00006	\$6.00		
***PBAL	#103	TRANS	
	\$0.00	IN	
1 PL00008	\$8.00		
-----		GCCOPY	
TAX \$0.84	SBTL \$14.84	BILL	
ENTER SRVC		FUNCTION MENU14	0002
		P111	3:27PM

Bill transfer

This function is used to change the GLU/PBLU code of a particular bill.

Procedure

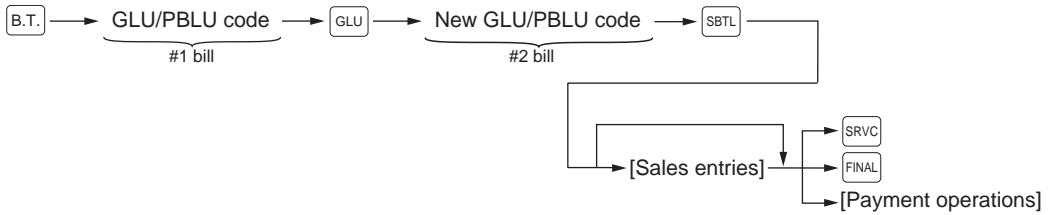

NOTE

- This function requires that the current GLU/PBLU code be entered for #1 and a new GLU/PBLU code be entered for #2.
- A #1 bill is transferred to a #2 bill. The #1 bill is then cleared.

Example

Key Operation

101

 102

Display

TBL #102		B.T.		
	#101			
***PBAL	\$0.00	TRANS		
1 PL00004	\$4.00	OUT		
1 PL00005	\$5.00	TRANS		
		IN		
	#102			
***PBAL	\$0.00	GCCOPY		

TAX \$0.54	SBTL \$9.54	BILL		
ENTER SRVC		FUNCTION MENU14	0002	
		P111	3:30PM	

■ Bill separating

The function is used when each guest of a group pays his or her own order. With this function, you can select some items from a guest check and make an entry for the payment. Also, you can transfer the selected items to other guest checks. This function is available only in the GLU system.

Procedure

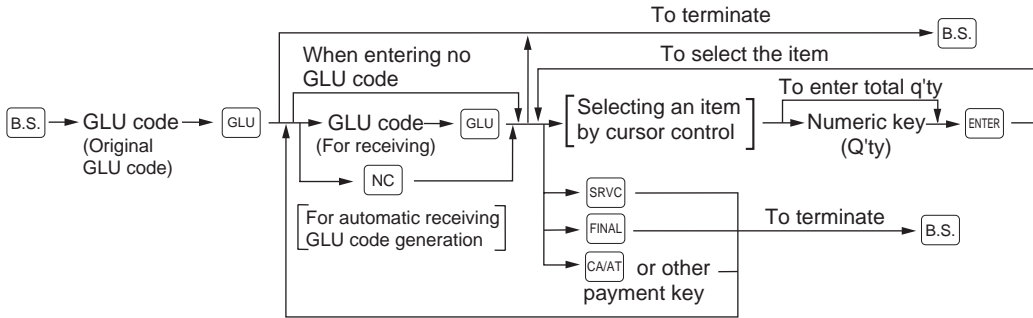

NOTE

- If a receiving GLU code is not entered during a bill separating operation, it is considered that the payment function has been made by pressing **CA/AT** key or other payment key.
- If a particular receiving GLU code is already in use, a lock error occurs when that number is entered.
- You cannot specify the quantity of an item for selection when the stored quantity has a decimal fraction.

Example

Key Operation

Display

101 B.S.
GLU

ORG#101 ▲	
3 PL00004	
1 PL00005	
1 PL00006	
TAX \$1.38 SBTL \$24.38 ▼ TAX \$0.00 SBTL \$0.00	
ENTER RCV# or IBSI	0002
P1L1	3:50PM

102 GLU
[Touch the item for bill splitting]

ORG#101 ▲ RCV#102	
3 PL00004	
1 PL00005	
1 PL00006	
TAX \$1.38 SBTL \$24.38 ▼ TAX \$0.00 SBTL \$0.00	
PL00004	0002
\$12.00	P1L1 3:52PM

2 ENTER

ORG#101 ▲ RCV#102	
1 PL00004	2 PL00004
1 PL00005	
1 PL00006	
TAX \$0.90 SBTL \$15.90 ▼ TAX \$0.48 SBTL \$8.48	
Select or Finalize	0002
P1L1	3:54PM

CA/AT

TBL #102 ▲		B.T.		
***PBAL	\$0.00	TRANS		
2 PL00004	\$8.00	OUT		
BAL FWD	\$8.00	TRANS		
MDSE ST	\$8.00	IN		
TAXI	\$0.48			
CASH	\$8.48	GCCOPY		
BALANCE	\$0.00			
-CHECK CLOSE	3:51PM	BILL		
TAX \$0.48 SBTL \$8.48 ▼				
[<-] or IBSI	FUNCTION MENU14	0002		
P1L1		3:55PM		

←
B.S.

ORG#101 ▲	
1 PL00004	
1 PL00005	
1 PL00006	
TAX \$0.90 SBTL \$15.90 ▼ TAX \$0.00 SBTL \$0.00	
ENTER RCV# or IBSI	0002
P1L1	3:56PM

■ Bill printing

This function is used for issuing the bill to the guest. Your POS terminal can print the bill (normal bill or cumulative bill) on the slip, roll, receipt, or journal printer. For selecting these printers, consult your authorized SHARP dealer.

Procedure

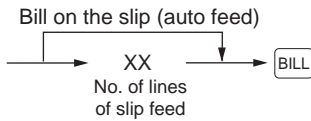

NOTE

- This function is available immediately after the finalization of a transaction (including after pressing the or the key).
- If the copy function is allowed, you can print the bill copy on the slip and receipt only once. If you need the bill copy, consult your authorized SHARP dealer.

Auxiliary Entries

■ Percent calculations (premium or discount)

- Your POS terminal provides a percent calculation for a merchandise subtotal or an item entry. You need to specify, in advance, a merchandise subtotal or item entry for which your POS terminal should perform a percent calculation.
- For percent calculations (premium, discount, merchandise subtotal or individual), you may use the thru keys.
- Percentage: 0.01 to 99.99%

NOTE

- For ST % (merchandise subtotal) entry:
The % entry is allowed only when all PLUs associated with the % key have been entered.
- For Item % entry:
The % entry is allowed only for a PLU associated with the % key.

Percent calculation for a merchandise subtotal

Example

Key Operation

(When a discount of 10% is preset for the key)

2

Print

11/18/2008		000001
#1446	9:56PM	JACK0002
PL00003		\$3.00
	2 @	\$5.00
PL00005		\$10.00
MDSE ST		\$13.00
		-10.00%
%1		-1.30
CASH		\$11.70

Percent calculation for item entries

Example

Key Operation

(When a discount of 15% is preset for the key)

Print

11/18/2008		000001
#1441	9:47PM	JACK0002
PL00006		\$6.00
		-15.00%
%2		-0.90
CASH		\$5.10

Discount entries

For discount or coupon tenderings, you may use the thru keys if so programmed.

If the discount or tendered coupon is the one applicable to sales, use the vendor coupon; and if it is applicable to an item entry, use the store coupon.

NOTE •Discount entries beyond the programmed limit for servers can be made by a manager.

- NOTE**
- For a vendor coupon entry:
The coupon entry is allowed only when all PLUs associated with the (-) key have been entered.
 - For a store coupon entry:
The coupon entry is allowed only for a PLU which is associated with the (-) key.

Discount for a merchandise subtotal

Example

Key Operation	Print
<div style="display: flex; align-items: center; justify-content: center;"> <div style="margin-right: 10px;">30</div> <div style="border: 1px solid black; padding: 2px;">7</div> </div> <div style="margin-top: 5px; text-align: center;"> <input type="button" value="PLU/UPC"/> </div> <div style="margin-top: 5px; text-align: center;"> <input type="button" value="MDSE ST"/> </div> <div style="margin-top: 5px; text-align: center;"> <input type="button" value="02"/> </div> <div style="margin-top: 5px; text-align: center;"> <input type="button" value="CA/AT"/> </div>	<div style="border: 1px solid black; padding: 5px;"> <p>11/18/2008 000001 #1451 10:05PM JACK0002</p> <p>PL00007 \$7.00 PL00030 \$30.00 (-) 2 -2.00 MDSE ST \$35.00 TAX1 \$1.80</p> <p>CASH \$36.80</p> </div>

Discount for a merchandise subtotal

Example

Key Operation	Print
<div style="display: flex; align-items: center; justify-content: center;"> <div style="margin-right: 10px;">50</div> <div style="border: 1px solid black; padding: 2px;">01</div> <div style="margin-left: 10px; margin-top: 5px;"> <div style="border: 1px solid black; padding: 2px;">7</div> <div style="border: 1px solid black; padding: 2px;">7</div> </div> </div> <div style="margin-top: 5px; text-align: center;"> <input type="button" value="CA/AT"/> </div>	<div style="border: 1px solid black; padding: 5px;"> <p>11/18/2008 000001 #1453 10:10PM JACK0002</p> <p>PL00007 \$7.00 (-) 1 -0.50 PL00007 -0.50</p> <p>CASH \$6.50</p> </div>

■ Refund entries

If a refunded item is to be entered into a department, enter the amount of the refund, then press the **REFUND** key and a corresponding department key in this order; and if an item entered into a PLU (or UPC) is returned, enter a corresponding PLU code (or UPC code), then press the **REFUND** and **PLU/UPC** keys, or press the **REFUND** and direct PLU keys without entry of PLU code, in this order.

If an refunded item is to be entered into an open PLU, enter a corresponding PLU code, press the **REFUND** and **PLU/UPC** keys, then enter price and press the **ENTER** .

Example

Key Operation	Print
RFND <input type="text" value="3"/> 2 <input type="text" value="0"/> <input type="text" value="FOR"/> 17 RFND <input type="text" value="PLU/UPC"/> 1 RFND <input type="text" value="DEPT#"/> 300 <input type="text" value="ENTER"/> 11 RFND <input type="text" value="PLU/UPC"/> 250 <input type="text" value="ENTER"/> <input type="text" value="CA/AT"/>	<div style="border: 1px solid black; padding: 5px;"> <p>11/18/2008 000001 #1457 10:19PM JACK0002</p> <p>PL00003 R-3.00 -2 @ \$17.00 PL00017 R-34.00 DPT. 01 R-3.00 PL00011 R-2.50 MDSE ST -42.50 TAX1 -2.04</p> <p>CHANGE \$44.54</p> </div>

■ Return entries

If a returned item is to be entered into a department, enter the amount of the return, then press the **RETURN** key and a corresponding department key in this order; and if an item entered into a PLU (or UPC) is returned, enter a corresponding PLU code (or UPC code), then press the **RETURN** and **PLU/UPC** keys, or press the **RETURN** and direct PLU keys without entry of PLU code, in this order.

If an returned item is to be entered into an open PLU, enter a corresponding PLU code, press the **RETURN** and **PLU/UPC** keys, then enter the price and press the **ENTER** .





Example

Key Operation	Print
<input type="text" value="5"/> RETURN <input type="text" value="4"/> 7 RETURN <input type="text" value="PLU/UPC"/> 1 RETURN <input type="text" value="DEPT#"/> 300 <input type="text" value="ENTER"/> 11 RETURN <input type="text" value="PLU/UPC"/> 250 <input type="text" value="ENTER"/> <input type="text" value="CA/AT"/>	<div style="border: 1px solid black; padding: 5px;"> <p>11/18/2008 000001 #1458 10:22PM JACK0002</p> <p>PL00005 \$5.00 PL00004 RT-4.00 PL00007 RT-7.00 DPT. 01 RT-3.00 PL00011 RT-2.50</p> <p>CHANGE \$11.50</p> </div>

■ Printing of non-add code numbers

Enter a non-add code number with a maximum of 16 digits such as a customer reference number and press the  key at any point during a transaction.

Example

Key Operation	Print
1230 	<div style="border: 1px solid black; padding: 5px;"> <p>11/18/2008 000001 #1460 10:27PM JACK0002</p> <p>#1230 PL00005 \$5.00 PL00010 \$10.00</p> <p>CHARGE2 \$15.00</p> </div>
	
	
	

■ Refund sales mode

This function can be used only for item return entries relating to departments and PLUs/UPCs.

Pressing the  key at the beginning of a transaction causes your POS terminal to enter the REFUND SALES mode.

All entries in the REFUND SALES mode are automatically treated as refund entries. This mode cannot be finalized by a check payment entry.



■ Group discount entries

- Your POS terminal provides percent (discount/premium) calculations for three groups.
- Percentage: 0.01 to 100.00%

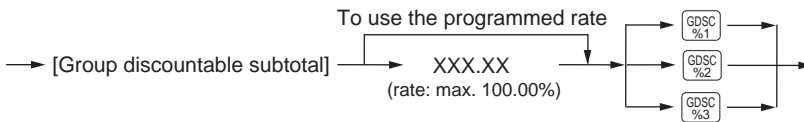
Procedure



• Group discount status shift

Your POS terminal allows you to shift the programmed group discount status of each dept., PLU, UPC, ⊖1 thru ⊖9, percent by pressing the , , and/or  keys before that key. After each entry is completed, the programmed group discount status of the key is resumed.

Remote printer send function

This function enables a partial order to be sent to the kitchen for preparation while the server is waiting for an order for other items.

Procedure

Item entry →  → Data transfer to the remote printer

Remaining items will be sent to the remote printer when the transaction is finalized.

When this function is used, subtotal void operation is not allowed.

Gratuity

If the gratuity function is enabled, you can easily add a gratuity as programmed to the subtotal by pressing the  key before finalization of the transaction.

When the transaction is subject to gratuity, the gratuity symbol [G] appears on the display screen.

To cancel the gratuity function, press the  key again.

Example

Key Operation

1 







Display

TBL #1				
***PBAL	\$0.00			
1 PL00009	\$9.00			
1 PL00010	\$10.00			
TAX \$1.26 SBTL \$22.16				
PL00010	\$10.00	HOME MENU		0002
		P1L1	G	11 08AM

TBL #1				
1 PL00010	\$10.00	CHG1	CHG6	
BAL FWD	\$19.00	CHG2	CHG7	
HDSE ST	\$19.00			
GRATUITY	\$1.90	CHG3	CHG8	
TAX1	\$1.26	CHG4	CHG9	
CHARGE2	\$22.16			
BALANCE	\$0.00			
-CHECK CLOSE	11:06AM	CHG5		
TAX \$1.26 SBTL \$22.16				
JACK		CHARGE MENU		0002
		P1L1		11:09AM

NOTE

- You cannot add a gratuity during a payment operation.
- You can also make food stamp tendering operation after pressing the  key though tax exemption is not allowed.
- If you combine a guest check subject to gratuity and one(s) not subject to gratuity by the Bill Totalizing function, a gratuity will be charged to the subtotal of the combined guest check the gratuity amount

Payment Treatment

Tip-in entries

Your POS terminal allows the entry of tips given to servers in cash or by credit card.

A tip entry should be done before a payment entry.

You must use the corresponding media key (e.g. CH1 thru CH9) for a charge tip and CASH 1 thru CASH 5 for a cash tip.

Two different tip-in entry systems are available: the tip amount entry system and the tip percent rate entry system. Which system is used depends on how your POS terminal has been programmed.

Procedure

Tip amount entry system:

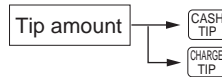

Tip percent rate entry system:

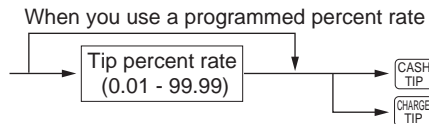

Example

Key Operation

101

101
300

Print

```

11/18/2008 000001 BILL#1024
#1461 10:31PM JACK0002

***PBAL TBL#101
PLO0005 $0.00
PLO0007 $5.00
PLO0008 $7.00
CA TIP $8.00
BAL FWD $3.00
CASH $20.00
CASH $23.00
    
```

Tip editing

This function is used for entering a tip amount after finalizing a guest check transaction. This function is available when the guest check transaction is finalized by a charge tender, and also when the tip is paid by a charge tender. To edit or add tip amount, the bill number which is issued when the or key is pressed in the guest check entry must be used in order to identify the guest. For editing operation, press the key or touch "EDIT TIP" in the keyboard area and follow the prompts on the display to enter the bill number and tip amount.

Tip paid entries

This operation is used to distribute a tip paid by credit card to servers in cash. To perform a tip paid entry, enter the server code, then press the **TIP PAID** key or touch "TIP PAID" in the keyboard area.

You can prohibit the tip paid operation in the REG mode by PGM2 programming.

NOTE When the tip amount remains unchanged in Individual Server Resetting, the tip paid function is automatically executed and a tip receipt is issued on the report printer prior to report printing.

Currency conversion

Your POS terminal allows payment entries in foreign currency. Pressing any of the **CONV1** thru **CONV4** keys creates a subtotal in foreign currency. After currency conversion, finalization can be done only by cash.

Procedure

After an entry is completed or
After the amount tendered is found smaller than the sales amount in a sales entry

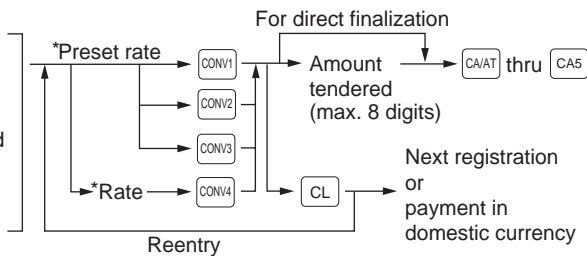

* Preset rate:
0.0000 to 9999.9999

- NOTE**
- When the amount tendered is short, the equivalent to the deficit is shown in domestic currency.
 - You can also enter a currency conversion tender from the conversion menu window. Press the **CONV** key and select a pertinent conversion number.
 - The amount of change will be displayed and printed in domestic currency.

Received-on-account entries

Procedure

Direct key entries

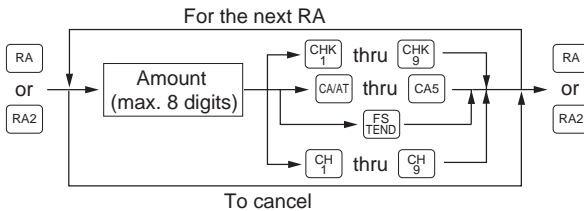

Menu-based entries

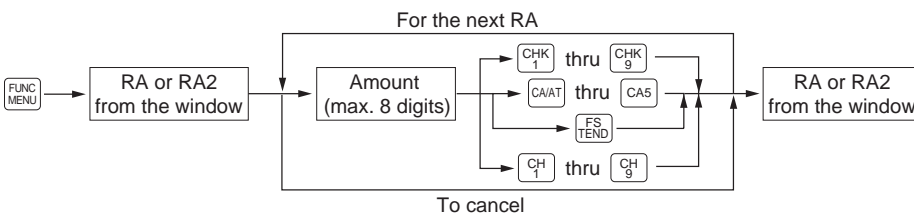

Example

Key Operation

12345

 4800

Print

```

11/18/2008 000001
#1466 10:51PM JACK0002

#12345
***RA
CHECK1 $48.00
***RA $48.00
  
```

NOTE

Instead of the above procedures, you may choose the following received-on-account entry procedure only for cash payment.
 Contact your authorized SHARP dealer to change the procedure.

Procedure

Direct key entries

→ → or

Menu-based entries

→ → →

Example

Key Operation

12345
 4800

Display

#12345		RCP	CA/CHK	CA/CHK
***RA	\$48.00	ON/OFF	1	6
		RA	CA/CHK	CA/CHK
		RA2	2	7
			CA/CHK	CA/CHK
			3	8
		PD	CA/CHK	CA/CHK
			4	9
		PD2	CA/CHK	
			5	NS
TAX \$0.00	SBTL \$0.00			
HIKE		HISC MENU		0001
		P1L1		3:54PM

■ Paid-out entries

Procedure

Direct key entries

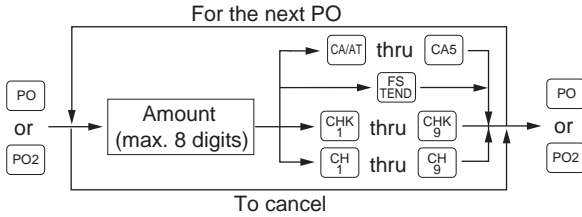

Menu-based entries

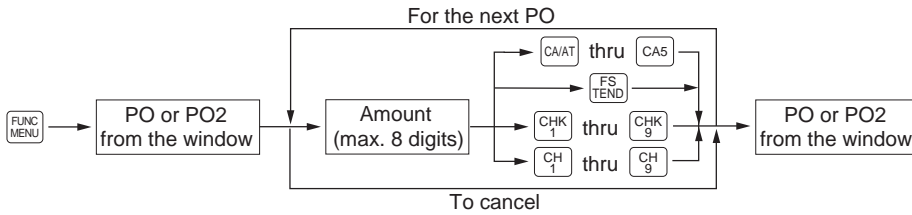

Example

Key Operation

56789 #/TM
 PO
 3000 CA/AT
 PO

Print

```

11/18/2008 000001
#1467 10:56PM JACK0002

#56789
***PO
CASH $30.00
***PO $30.00
  
```

NOTE *Instead of the above procedures, you may choose the following paid-out entry procedure only for cash payment.
 Contact your authorized SHARP dealer to change the procedure.*

Procedure

Direct key entries

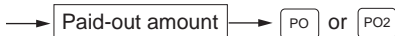

Menu-based entries

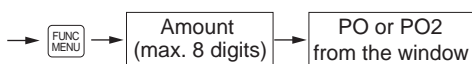

Example

Key Operation

5000

Display

***PO	\$50.00	▲ RCP	CA/CHK	CA/CHK
		ON/OFF	1	6
		RA	CA/CHK	CA/CHK
			2	7
		RA2	CA/CHK	CA/CHK
			3	8
		PO	CA/CHK	CA/CHK
			4	9
TAX \$0.00	SBTL \$0.00 ▼	PO2	CA/CHK	NS
			5	
MIKE		MISC MENU		0001
		P1L1		3 56PM

■ No-sale (exchange)

For exchange of money, simply press the key without any entry. The drawer will open and the printer will issue a receipt on which "NO SALE" is printed. If your POS terminal is programmed to allow a non-add code entry and you enter a non-add code number before pressing the key, a no-sale entry will be achieved with a non-add code number printed.

Example

Key Operation

Print

11/18/2008 000001
 #1468 10:59PM JACK0002
 NO SALE

NOTE

You can also enter "No-sale" from the Function Menu 1 window. Press the key and select "NS" (No Sale) from the window.

■ Cashing a check

To cash a check, enter the check amount, then press any of the thru keys.

Procedure

Direct key entries

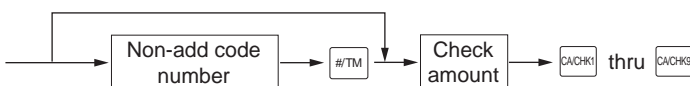

(When non-add code entry is allowed.)

Menu-based entries



Example

Key Operation	Print
12345 <input type="button" value="#/TM"/>	<div style="border: 1px solid black; padding: 5px;"> <p>11/18/2008 000001</p> <p>#1469 11:00PM JACK0002</p> <p>#12345</p> <p>CA/CHK1 \$50.00</p> </div>
5000 <input type="button" value="CA/CHK1"/>	

Customer management

Your POS terminal can provide a customer management function.

To enable the customer management function, enter the customer code assigned to a customer. You can enter the customer code at any point during a transaction.

Normally customer information (name, code and address) is previously set by programming.

However, you can enter information on a new customer during a transaction. When an undefined customer code is entered, the message "UNDEFINED CODE" is displayed, then you can enter the customer's name and address, which are saved in the customer file.

For the customer registered, you can defer his/her payment. Take a tentative finalization procedure using the CH 1 key. The sales amount is added to the charge amount for the customer. When the customer settles his/her charge account, take a received-on account entry procedure.

Procedure

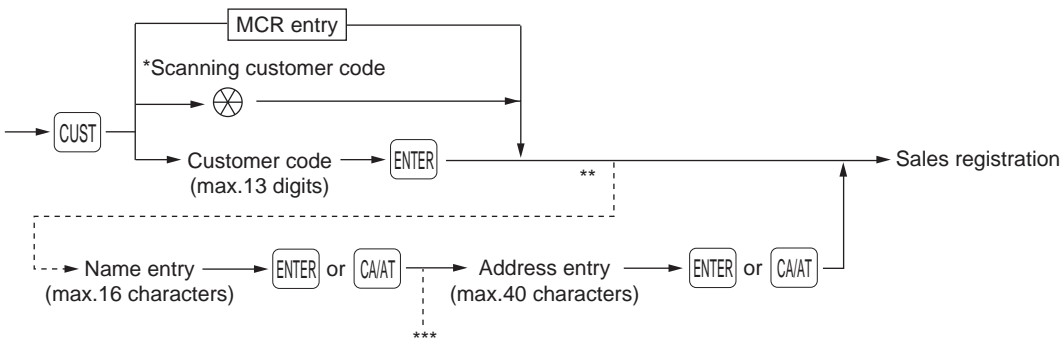

*: Scan the customer code on a Customer Card provided to the customer, or enter the EAN-13 format bar code. The customer code can be entered by the optional magnet card reader.

** : When an entered customer code does not exist in the customer file, "UNDEFINED CODE" is displayed for a moment with beep sound. Then the NAME entry window entered appears and prompts the operator to enter the customer's name.

***: The ADDRESS entry window is displayed.

NOTE

- Customer code entry is inhibited after payment operation.
- When the wrong code is entered, take the following procedure to cancel it.
If no item has been entered, press the key.
If an item entry has been made, perform a subtotal void operation.

WASTE mode

This mode is used to remove an article which has already been prepared and is no longer suitable to be served.

Procedure

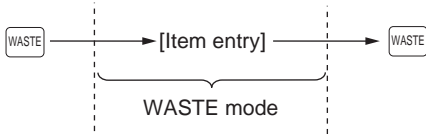





NOTE

- *PLU entries are only allowed in the WASTE mode, and direct and indirect void operations are also allowed in this mode.*
- *When a WASTE-mode transaction is finalized, the drawer does not open.*
- *The consecutive number is incremented every WASTE-mode transaction.*
- *When the WASTE mode is activated by pressing the  key, the mode caption "WASTE" is displayed.*

Example

Key Operation

Print

	WASTE	
PL00010		\$10.00
PL00011		\$11.00

7

Correction

REG MODE

Correction of the Last Entry (Direct Void)

If you make an incorrect entry relating to a department, PLU/subdepartment, UPC, percentage ([%1] thru [%9]), discount ([⊖1] thru [⊖9]), manual tax, or tip, you can immediately void the entry by pressing the [VOID] key or touching "VOID" in the keyboard area of the display.

Procedure

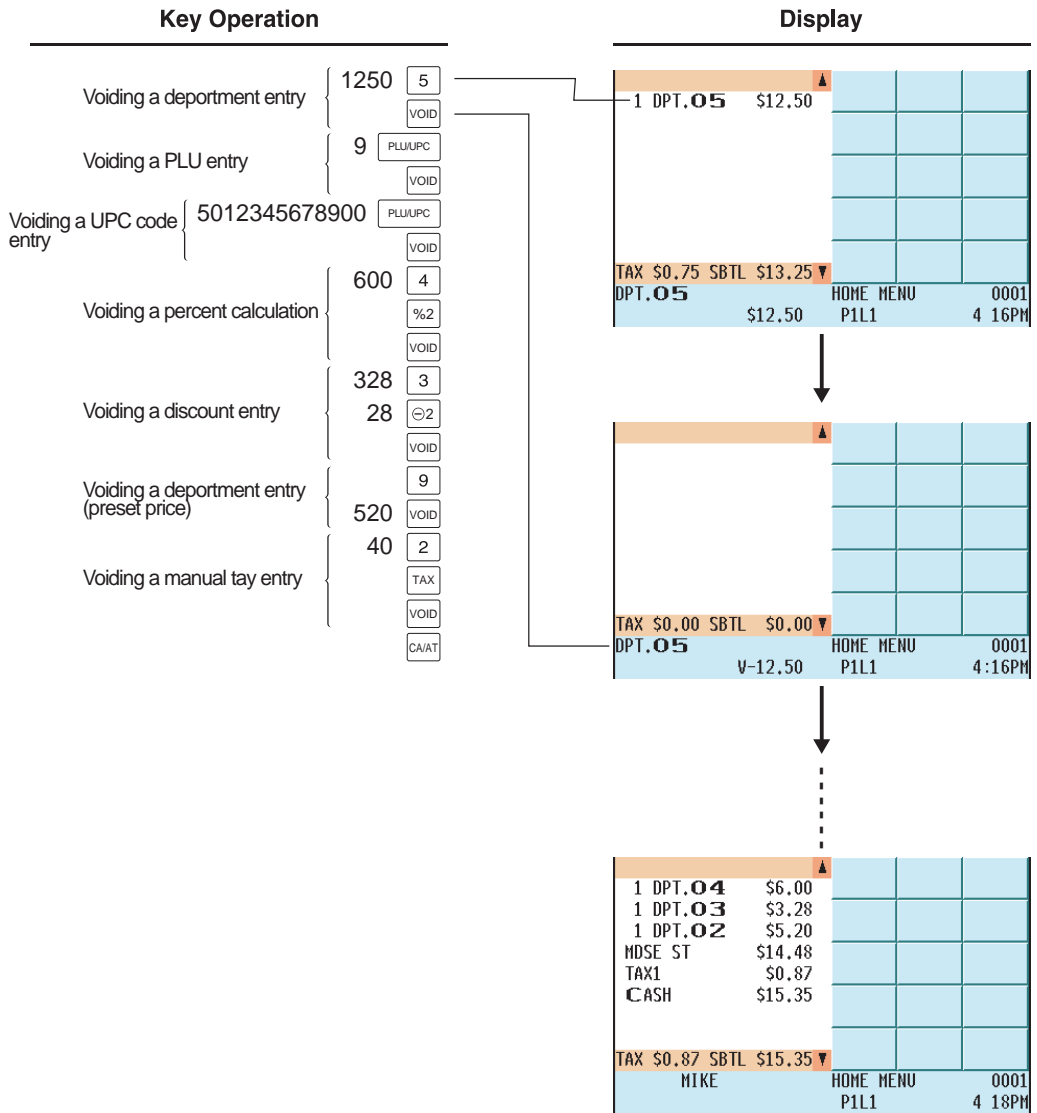

NOTE You can also void an entry from the void menu window. Press the [VOID MENU] key and select the desired void option.

Correction of the Next-to-Last or Earlier Entries (Indirect Void)

By selecting a line and touching "I.VOID" in the keyboard area, you can void any incorrect department, PLU/subdepartment, UPC or item refund entry made earlier than the last entry if you find it before finalizing the transaction (e.g. before pressing the **CA/AT** key).

This function is applicable only to entries relating to a department and PLU/subdepartment, UPC and item refund.

Procedure

Key Operation

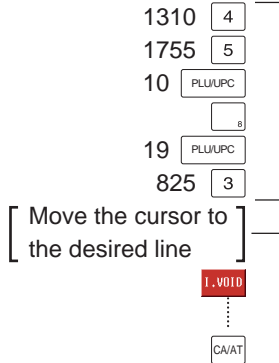

Display

1	DPT.04	\$13.10			
1	DPT.05	\$17.55			
1	PL00010	\$10.00			
1	PL00008	\$8.00			
1	PL00019	\$19.00			
1	DPT.03	\$8.25			
TAX \$4.55 SBTL \$80.45					
DPT.03			HOME MENU	0001	
		\$8.25	P1L1		4:29PM

1	DPT.04	\$13.10	VOID		
1	DPT.05	\$17.55	I.VOID		
1	PL00010	\$10.00	ST VD		
1	PL00008	\$8.00			
1	PL00019	\$19.00			
1	DPT.03	\$8.25			
TAX \$4.55 SBTL \$80.45					
DPT.04			VOID MENU	0001	
		\$13.10	P1L1		4:30PM

1	DPT.05	\$17.55	VOID		
1	PL00010	\$10.00	I.VOID		
1	PL00008	\$8.00	ST VD		
1	PL00019	\$19.00			
1	DPT.03	\$8.25			
TAX \$3.77 SBTL \$66.57					
DPT.04			VOID MENU	0001	
		V-13.10	P1L1		4:30PM

1	DPT.05	\$17.55	VOID		
1	PL00010	\$10.00	I.VOID		
1	DPT.03	\$8.25	ST VD		
	HDSE ST	\$35.80			
	TAX1	\$2.15			
	CASH	\$37.95			
TAX \$2.15 SBTL \$37.95					
MIKE			VOID MENU	0001	
			P1L1		4:33PM

NOTE

• To void entries that include a tax status shift, press the **TAX1 SHIFT**, **TAX2 SHIFT**, **TAX3 SHIFT**, **TAX4 SHIFT**, and/or **TAX5 SHIFT** keys prior to touching "I.VOID."

Subtotal Void

With the SBTL VOID key or selecting a line and touching "ST VD", you can void an entire transaction. Once a subtotal void is executed, the transaction is canceled and the POS terminal issues a receipt.

Procedure

Key Operation

1310 [3]
 1755 [4]
 2 [%FOR] 5 [PLU/UPC]
 10 [PLU/UPC]
 [SBTL]
 [ST VD] or [SBTL VOID]

Display

1	DPT.03	\$13.10	VOID		
1	DPT.04	\$17.50	I.VOID		
2	PL00005	\$10.00			
1	PL00010	\$10.00	ST VD		
TAX \$3.04 SBTL \$53.64					
SUBTOTAL			VOID MENU	0002	
\$53.64			P1L1	11:24AM	

1	DPT.03	\$13.10	VOID		
1	DPT.04	\$17.50	I.VOID		
2	PL00005	\$10.00			
1	PL00010	\$10.00	ST VD		
	HDSE ST	\$50.60			
	SBTL VOID	-50.60			
	***TOTAL	\$0.00			
TAX \$0.00 SBTL \$0.00					
JACK			VOID MENU	0002	
			P1L1	11:24AM	

Correction of Incorrect Entries Not Handled by the Direct or Indirect Void Function

You cannot void any errors after finalization of a transaction or during entry of an amount tendered. These errors must be handled by the manager.

The following steps should be taken.

1. If you are entering an amount tendered, finalize the transaction.
2. Hand the incorrect receipt to your manager for recording purposes.

8

Special Printing Functions

REG MODE

Printing Message Text on Remote Printers or Chit Receipts

You can print a message on a remote printer or a chit receipt if so programmed. Press the **MSG MENU** key and select the relevant message key in the keyboard area, or press one of the **MSG1** thru **MSG5** keys during an item entry. The message will be printed in double sized characters together with the content of the transaction.

NOTE You can not finalize the transaction when a message only is entered.
When multiple messages are entered, the last message only is printed.

Copy Receipt Printing

When the receipt ON-OFF function is in the OFF state, you can get a receipt by pressing the **RCPT** key. When the receipt ON-OFF function is in the ON state, you can get a copy receipt by pressing the **RCPT** key.

NOTE To toggle the receipt ON-OFF function, use either of the following procedures:

- Touch "RCP ON/OFF" from the window which is opened by pressing the **FUNC MENU** key.
- Press the RCP SW key to open the "RCP ON/OFF" window.

Procedure

Printing a receipt after making entries as shown below with the receipt ON-OFF function "OFF".

Key Operation

3 **2**
3
CAIAT

Print on the journal

For receipting → **RCPT**

Print

08/21/2008	000001
#1064	11:26AM JACK0002
PLO0002	\$2.00
	3 @ \$3.00
PLO0003	\$9.00
HOSE ST	\$11.00
TAX1	\$0.66
***TOTAL	\$11.66
CASH	\$12.00
CHANGE	\$0.34

Print on the receipt

08/21/2008	000001
#1064	11:26AM JACK0002
PLO0002	\$2.00
	3 @ \$3.00
PLO0003	\$9.00
HOSE ST	\$11.00
TAX1	\$0.66
***TOTAL	\$11.66
CASH	\$12.00
CHANGE	\$0.34

The "COPY" symbol is printed on the copy receipt.



Validation Printing Function

Your POS terminal can perform validation printing when it is connected a slip printer. For the details of the slip printer, consult your authorized SHARP dealer.

1. Set a validation slip on the slip printer.
2. Press the PRINT key. Validation printing will start.

NOTE If the validation printing function is programmed as compulsory, it can be overridden by the following operation. If you need this override function, consult your authorized SHARP dealer.

1. Enter the manager code and press .
2. Enter your secret code and press .
3. Press the key and then the key. (→)

9

Manager's Override Entries and Correction after Finalization

Manager(s) can override programmed limits (such as maximum amounts) for various functions and void incorrect entries that servers or cashiers cannot correct (incorrect entries that are found after finalizing a transaction or cannot be corrected by direct or indirect void).

Override Entries

Programmed limits for various functions can be overridden by a manager as follows

Example

Selling a \$14.00 item (Dept 03) for cash and subtracting the coupon amount \$2.50 from the sales amount (This example presumes that the POS terminal has been programmed not to allow coupon entries)

Key Operation

Normal REG-mode entries { 1400 [2] }
 { 250 [⊖] [2] Error }
 { [CL] }

Enter the manager code and press [ENTER], and then enter his or her secret code and press [ENTER]. 250 [⊖] [2]

Return to the normal REG mode. [CA/AT]

Display

1 DPT.02	\$14.00	71		
(-)2		72		
1 DPT.02	-2.50			
MOSE ST	\$11.50	(-)1		
TAX1	\$0.69	(-)2		
CASH	\$12.19			
TAX \$0.69 SBTL	\$12.19			
JACK		FUNCTION MENU10	0002	
		P1L1	1 20AM	

Correction after Finalization

To void incorrect entries, follow the procedure below

1. Enter the manager code and press .
2. Enter your secret code and press .
3. Press the VOID key to put your POS terminal in the VOID mode. (Note the indication on the display.)
4. Repeat the entries recorded on the incorrect receipt. (All data on the incorrect receipt is removed from the POS terminal memory; the voided amounts are added to the void mode totalizer.)

Incorrect receipt		Cancellation receipt	
11/07/2008	000001	11/07/2008	000001
#1431 12:27PM	MIKE0001	#1432 12:29PM	MIKE0001
PL00005	\$5.00	*VOID*	
PL00007	\$7.00	PL00005	\$5.00
MDSE ST	\$12.00	PL00007	\$7.00
TAX1	\$0.72	MDSE ST	\$12.00
		TAX1	\$0.72
CASH	\$12.72	CASH	\$12.72

NOTE

Your POS terminal exits the VOID mode when the transaction is completed (i.e. finalized in the VOID mode). To void additional transactions, repeat steps 1 and 4 above.

10

Reading (X) and Resetting (Z) of Sales Totals

X1/Z1 MODE

X2/Z2 MODE

OPXZ MODE

- Use the reading function (X) when you need to take an X report (reading) of sales information entered after the last resetting operation. You can take this report any number of times. It does not affect the POS terminal's memory.
- Use the resetting function (Z) when you need to clear the POS terminal's memory. Resetting operation prints all sales information and clears the entire memory except GT1 through GT3, the reset count, and the consecutive number.
- X1 and Z1 reports show daily sales information. You can take these reports in the X1/Z1 mode.
- X2 and Z2 reports show periodic (monthly) consolidation information. You can take these reports in the X2/Z2 mode.
- In the OPXZ mode, a server/cashier can take his or her report.
- If you want to stop printing a report, press the **[CANCEL]** key. Even if the printing is stopped, the consecutive number (and Z counter if you are printing a Z report) is increased by one.

■ How to take an OPXZ, X1/Z1 or X2/Z2 report

[To take an OPX, X1 or X2 report:]

1. Enter the OPXZ, X1/Z1, or X2/Z2 mode from the mode selection window.
2. Select "1 READING" to display the report list.
3. Select a report title listed in the table (shown later). When you select an item in parentheses on the opening screen, you can jump to the associated report title(s).
4. If needed, enter the corresponding values in the "Data to be entered" column in the table (shown later).

[To take an OPX, Z1 or Z2 report:]

1. Enter the OPXZ, X1/Z1, or X2/Z2 mode from the mode selection window.
2. Select "2 RESETTING" to display the report list.
3. Select a report title listed in the table (shown later).
4. If needed, enter the corresponding values in the "Data to be entered" column in the table (shown later).
5. After all steps to take a report are completed, the message "ARE YOU SURE ?" will appear.
Select one of the following options:
 - "YES" to reset the sales information.
 - "NO" to cancel the report procedure.

■ Flash report

You can take flash reports (display only) in the X1 mode for department sales, cash in drawer (CID) and sales total for a fast view of sales revenue.

1. Enter the X1/Z1 mode from the mode selection window.
2. Select "3 FLASH MODE" to display the flash report menu.
3. Select "DEPT SALES" to take a flash report of department sales, "CID" to take a flash report of cash in drawer, or "SALES TOTAL" to take a flash report of sales total.

Report title	Description	Available report type in each mode			Data to be entered
		OPXZ	X1/Z1	X2/Z2	
<DEPARTMENT>					
DEPARTMENT	Department by group		X1, Z1	X2, Z2	Start/end department codes
DEPT.IND. GROUP	Individual group total of departments		X1	X2	Department group no.
DEPT.GROUP. TOTAL	Full group total of departments		X1	X2	
MARKDOWN DEPT.	Department markdown		X1	X2	
<PLU>					
PLU/UPC	PLU/UPC by designated range		X1, Z1	X2, Z2	Start/end PLU/UPC codes
PLU PICK UP	PLU/UPC pick up report		X1, Z1	X2, Z2	*1
PLU BY DEPT	PLU/UPC by associated dept.		X1, Z1	X2, Z2	Department code
PLU IND. GROUP	Individual group of PLU/UPC		X1	X2	PLU/UPC group no.
PLU GROUP. TOTAL	Full group total of PLU/UPC		X1	X2	
PLU STOCK	PLU stock by designated range		X1, Z1		Start/end PLU/UPC codes
PLU STOCK PICK	PLU/UPC stock pick up report		X1		*1
PLU ZERO SALES	PLU/UPC zero sales		X1	X2	All
	PLU/UPC zero sales by department		X1	X2	Department code
PLU MINIMUM. STOCK	PLU/UPC minimum stock		X1		Start/end PLU/UPC codes
PLU PRICE CATEGORY	PLU/UPC by price category		X1	X2	Price
<DYNAMIC>					
DYNAMIC UPC	Dynamic UPC by designated range		X1, Z1	X2, Z2	Start/end UPC codes
D-UPC PICK UP	Dynamic UPC pick up report		X1, Z1	X2, Z2	*1
D-UPC BY DEPT	Dynamic UPC by associated dept.		X1, Z1	X2, Z2	Department code
NON-ACCESSED UPC	Non-accessed UPC report		X1	Z2	
<TRANSACTION>					
TRANSACTION	Transaction		X1, Z1	X2, Z2	
CID	Cash in drawer		X1	X2	
POSITIVE CHECK	Positive check		X1, Z1		
KEY CAPTURE	Key capture report		X1		
TAX	Tax		X1	X2	
ALL SERVER	Full server		X1, Z1	X2, Z2	
SCM	Starting cash memory	X	X1		X: Server code; X1: All server data
IND. SERVER	Individual server	X, Z	X1, Z1	X2, Z2	
				X, Z	

Report title	Description	Available report type in each mode			Data to be entered
		OPXZ	X1/Z1	X2/Z2	
HOURLY	Hourly (full)		X1, Z1		Start/end time
	Hourly (by range)		X1		
DAILY NET	Daily net			X2, Z2	
GLU	GLU		X1, Z1		Start/end GLU code
GLU BY SERVER	GLU by server		X1, Z1		
<CLOSE>					
CLOSE GLU	Closed GLU		X1, Z1		Start/end GLU code
CL-GLU BY SERVER	Closed GLU by server		X1, Z1		
<CUSTOM>					
CUSTOMER DETAILS ONLY REPORT	Customer details only report			X2	Start/end customer codes
CUSTOMER SALES ALL REPORT	Customer sales all report			X2, Z2	Start/end customer codes
CUSTOM BY SALES RANGE	Customer by designated sales range			X2	Amount
CHARGE ACCOUNT	Customer no payment			X2	
STACKED REPORT	Stacked report 1		X1, Z1	X2, Z2	
	Stacked report 2		X1, Z1	X2, Z2	
E.JOURNAL	Electronic journal		X1, Z1		

NOTE 1: You can pick up PLU/UPC codes for issuing a report. You can pick up new PLU/UPC codes or the codes that were picked up last time. To pick up new codes, select "1 NEW PICK UP", and follow the procedure below to pick up new codes. To pick up the codes that were picked up last time, select "2 LAST PICK UP".

Follow the below procedure for picking up PLU/UPC codes.

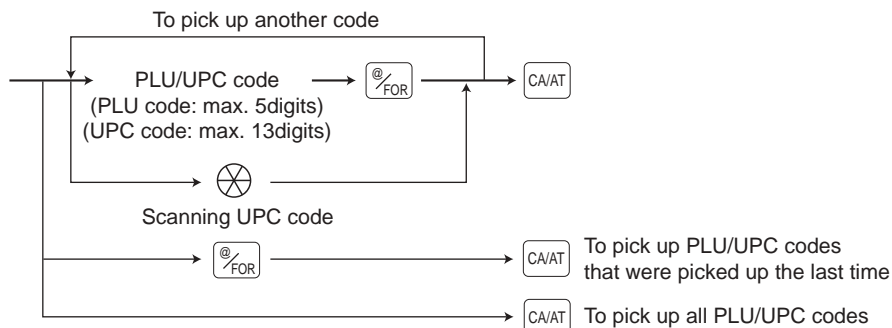

* The following reports relating to PLU/UPC is issued in the following sequence:
 PLU, PLU BY DEPT, PLU IND. GROUP, PLU ZERO SALES, PLU STOCK, PLU MINIMUM. STOCK and PLU CATEGORY

Also the UPC codes are printed in the sequence shown below.

UPC-A
UPC-E
EAN-13
EAN-8

Daily Sales Totals

Transaction report

• Sample X report

12/06/2008	000001		
#1796	10:37AM		
#0130 *X1*			
TRANSACTION			
TR		\$000000000000.00	
(-) 2	1Q	-2.00	
ST(-) TL	1Q	-2.00	
GDISC%1	2Q	-1.80	

GDISC%TL	12Q	-21.80	
NET 1		\$5537.86	
TAX1 ST		\$2864.08	
GRS TAX1		\$176.26	
RFD TAX1		-4.38	
TAX1		\$171.88	
TX1 EXPT		\$49.00	
TAX2 ST		\$70.00	
GRS TAX2		\$3.50	
TAX2		\$3.50	
TX2 EXPT		\$15.00	
TAX3 ST		\$311.00	
GRS TAX3		\$15.05	
TAX3		\$15.05	
TAX4 ST		\$211.00	
GRS TAX4		\$16.88	
TAX4		\$16.88	
TAX5 ST		\$459.00	
GRS TAX5		\$31.44	
TAX5		\$31.44	
GRS MTAX		\$1.14	
M-TAX		\$1.14	
FS TX1		\$17.50	
TTL TAX		\$239.89	
NET		\$5517.78	
NET2		\$5757.67	
COMB01	2Q	\$12.20	

• Sample Z report

12/06/2008	000001		
#1799	10:39AM		
#0130 *Z1*			
TRANSACTION			
TRANS. Z1		0003	
GT1		\$00000154443.01	
GT2		\$00000155077.14	
GT3		-00000000634.13	
TR		\$00000000000.00	

The subsequent printout occurs in the same format as in the sample X report.

(When the Canadian tax system is selected)

TAX1 ST	\$2771.58	
GRS TAX1	\$170.71	
RFD TAX1	-4.38	
TAX1	\$166.33	Tax 1
TX1 EXPT	\$49.00	
TAX2 ST	\$70.00	
GRS TAX2	\$3.50	
TAX2	\$3.50	
TX2 EXPT	\$15.00	
TAX3 ST	\$58.00	
GRS TAX3	\$2.90	
TAX3	\$2.90	
TAX4 ST	\$172.00	
GRS TAX4	\$13.76	
TAX4	\$13.76	Tax 4
TAX5 ST	\$308.00	
GRS TAX5	\$21.56	
TAX5	\$21.56	
GRS MTAX	\$1.14	
M-TAX	\$1.14	Manual tax
GST EXPT	\$524.58	Exempt total from GST
PST TTL	\$25.84	PST total
GST TTL	\$7.52	GST total

To be continued on the next page

(-) 1	18Q	-19.00	
(-) 3	4Q	-10.00	(-)3 counter and total (Item(-))
(-) TL	22Q	-29.00	Total for item(-)
%1	6Q	-3.65	%1 counter and total (Item %)
%2	7Q	-13.35	
%3	1Q	-0.60	
%4	3Q	-3.12	
%5	2Q	-1.92	
% TL	19Q	-22.64	Total for item %
V. CP UPC	1Q	-0.89	Vender coupon UPC counter and total
EAT IN 1	3Q	\$60.56	Eat-in 1 counter and total

DIRECT VOID	10Q	\$409.52	Direct void counter and total
PAST VOID	6Q	\$73.70	Indirect void counter and total
SBTL VOID	3Q	\$72.08	Subtotal void counter and total
MGR VD	1Q	\$10.00	Manager item void counter and total
VOID	1Q	\$10.00	Void-mode transaction counter and total
REFUND	8Q	\$82.50	Refund counter and total
RETURN	4Q	\$16.50	Return counter and total
HASH VD	2Q	\$4.25	Hash item void counter and total
HA P. VD	1Q	\$1.20	Hash item indirect void
HASH RF	1Q	\$3.20	Hash item refund counter and total
HASH RT	1Q	\$5.12	Hash item refund counter and total
NO SALE	1Q		No-sale (exchange) counter
G. C. CNT	1Q		Guest check copy counter
BILL CNT	2Q		Bill print counter
DRW CNT	146Q		Till timer counter
TRAY CNT	8Q		Tray subtotal print counter
***PBAL	25Q		GLU/PBLU counter
SERVICE	31Q		Service counter (for GLU/PBLU)
COVER CT	166Q		Cover counter
TRAN. OUT	1Q	\$13.00	Transfer-out counter and total
TRAN. IN	1Q	\$13.00	Transfer-in counter and total
TRANS CT	196Q		Transaction counter
AVE SALE		\$34.68	
NET3		\$5765.17	Sales total (including hash dept. total)
WASTE TL	7Q	-29.50	Waste counter and total
CASH	156Q	\$4666.14	Cash counter and total
CASH2	3Q	\$25.14	Cash 2 counter and total
CASH3	1Q	\$40.95	
CASH4	1Q	\$12.72	
CASH5	1Q	\$12.96	
CASH TL	162Q	\$4757.91	Total for cash
FS SALE	2Q	\$17.50	Food stamp sales total
FS SALE EBT	1Q	\$10.00	FS tendering by EBT sales total

To be continued on the next page

SCM (+)		\$3360.00	Starting cash memory(+)
SCM (-)		-2696.80	Starting cash memory(-)
SCM TTL		\$663.20	Starting cash memory total
***RA	1Q	\$48.00	Received-on-account counter and total
RA TL	1Q	\$48.00	Total for received-on-account
***PO	5Q	\$130.00	Paid-out counter and total
PO TL	5Q	\$130.00	Total for paid-out
CA/CHK1	1Q	\$50.00	Check cashing 1 counter and total
CA/CK TL	1Q	\$50.00	Total for check cashing
FS/CG		\$0.50	Food stamp change(by cash)
CONV 2		40.00	
CONV 3		35.00	
CONV 4		33.00	Currency conversion 4 total (by manual rate)
CONV TL		138.00	Total for conversion
FS ID		\$18.00	Food stamp in drawer
CHARGE1	2Q	\$59.70	Gross charge 1 counter and total
CHARGE2	11Q	\$339.75	
CHARGE3	1Q	\$80.00	

CHR TL	14Q	\$479.45	Total for charge
CHECK1	12Q	\$392.75	Check 1 sale counter and tendering counter
CHECK2	4Q	\$106.10	
CHECK3	3Q	\$62.02	
CHECK4	1Q	\$25.44	
CHECK9	1Q	\$19.00	
CHECK TL	21Q	\$605.31	Total for check
CA+CH ID		\$5872.92	Cash+check in drawer
****CID		\$5267.61	Cash in drawer
DEPOSIT	1Q	\$50.00	Deposit counter and total
DPST RF	1Q	-50.00	Deposit refund counter and total
TIP PAID	4Q	\$24.00	Tip-paid counter and total
CA TIP	1Q	\$3.00	Cash tip-in counter and total
CH TIP	3Q	\$21.00	Charge tip-in counter and total

■ Department report

• Sample X report

12/06/2008		000001
#1654	1:12PM	JACK0002
#0110 *X1*		
DEPARTMENT		
D01	39.000Q	23.68%
DPT. 01		\$223.20
D02	17.000Q	16.07%
DPT. 02		\$151.50
D03	10.000Q	20.83%
DPT. 03		\$196.28
D04	8.000Q	19.26%
DPT. 04		\$181.50
D05	1.000Q	0.53%
DPT. 05		\$5.00
D08	1.000Q	2.12%
DPT. 08		\$20.00
D09	1.000Q	5.31%
DPT. 09		\$50.00
*DEPT TL	79.000Q	\$942.48
		100.00%
D10	2.000Q	
DPT. 10		-3.00
DEPT (-)	2.000Q	-3.00
*GAS TL	0.000Q	0
		\$0.00
GAS (-)	0.000Q	0
		\$0.00

• Sample Z report

12/06/2008		000001
#1656	1:16PM	JACK0002
#0110 *Z1*		
DEPARTMENT		
DEPARTMENT Z1		0006

↓

The subsequent printout occurs
in the same format as in the
sample X report.

Individual group total report on departments

12/06/2008		000001
#1655	1:13PM	JACK0002
#0112 *X1*		
DEPT. IND. GROUP		
D01	39.000Q	
DPT. 01		\$223.20
D02	17.000Q	
DPT. 02		\$151.50
DPT GR-1	56.000Q	\$374.70

Dept. code
Sales q'ty
Sales amount
Dept. label
Group 1 sales q'ty and amount

Department markdown report

12/06/2008		000001
#1746	8:27AM	MIKE0001
#0119 *X1*		
MARKDOWN DEPT.		
D01		
DPT. 01		
(-) 1	1Q	-1.00
***TOTAL	1Q	-1.00
%1	1Q	-0.50
***TOTAL	1Q	-0.50
D02		
DPT. 02		
(-) 1	1Q	-1.00
***TOTAL	1Q	-1.00
%2	1Q	-3.00
***TOTAL	1Q	-3.00

Dept. code
Dept. label
(-)1 counter and total(item(-))
Item (-) counter and total for dept. 1
%1 counter and total(item%)
Item % counter and total for dept. 1

Full group total report on departments

12/06/2008		000001
#1656	1:13PM	JACK0002
#0113 *X1*		
DEPT. GROUP TOTAL		
DPT GR-1	56.000Q	\$374.70
DPT GR-2	18.000Q	\$377.78
DPT GR-3	2.000Q	\$55.00
DPT GR-4	0.000Q	\$0.00
DPT GR-5	0.000Q	\$0.00
DPT GR-6	0.000Q	\$0.00
DPT GR-7	1.000Q	\$65.00
DPT GR-8	2.000Q	\$70.00
DPT GR-9	2.000Q	-3.00

Group 1 sales q'ty and amount

■ PLU/UPC report by designated range

• Sample X report

12/06/2008			000001
#1661	1:18PM	JACK0002	
#0120 *X1*	PLU code		
PLU/UPC	00001-	999999	PLU range
PLU	P00001	MILK	Item label for price level1
CP	1.000Q	\$25.50	Sales q'ty and amount for price level 1
NET SLS	13.004Q	-1.00	Coupon counter and total for price level 1
P00002	13.004Q	\$24.50	Net sales for price level 1
PL00002	10.004Q	\$28.00	
CP	1.000Q	-1.00	
NET SLS	10.004Q	\$27.00	
P00003	20.009Q	\$87.00	
RF	-2.000Q	-6.00	
CP	2.000Q	-2.00	
NET SLS	18.009Q	\$79.00	
P00004	18.002Q	\$80.00	
COMBO	2.000Q	\$7.00	Combo sales for price level 1*
CP	2.000Q	-2.00	
NET SLS	18.002Q	\$85.00	
P00005	27.010Q	\$185.00	
NET SLS	27.010Q	\$185.00	
P00006	12.003Q	\$89.10	
NET SLS	12.003Q	\$89.10	
P00007	17.001Q	\$124.95	
CP	2.000Q	-1.00	
NET SLS	17.001Q	\$123.95	
P00008	12.021Q	\$264.00	
NET SLS	12.021Q	\$264.00	
P00009	5.002Q	\$62.55	
NET SLS	5.002Q	\$62.55	
P00010	9.008Q	\$170.00	
WASTE	-1.000Q	-10.00	
NET SLS	8.008Q	\$160.00	

• Sample Z report

12/06/2008			000001
#1668	11:18PM	JACK0002	
#0120 *Z1*	PLU/UPC		
PLU/UPC	Z1/Z2	0006	

The subsequent printout occurs in the same format as in the sample X report.

P00045	PL00045	2.000Q	\$90.00
NET SLS	2.000Q	\$90.00	
***TOTAL 187.098Q \$2237.50			
COMBO TL	2.000Q	\$7.00	
WASTE TL	-2.000Q	-21.00	
		0.98%	
RF TL	-7.000Q	-76.50	
CP	9.000Q	-8.00	
NET TL	178.098Q	\$2132.00	
UPC			
5099887654302#			
ITEM A	5.012Q	\$71.25	
NET SLS	5.012Q	\$71.25	
		74.03%	
5099887654303#			
ITEM B	2.000Q	\$7.00	
NET SLS	2.000Q	\$7.00	
		7.27%	
5099887654304#			
ITEM M	4.000Q	\$18.00	
NET SLS	4.000Q	\$18.00	
		18.70%	
***TOTAL 11.012Q \$96.25			
WASTE TL	0.000Q	\$0.00	
		0.00%	
RF TL	0.000Q	\$0.00	
CP	0.000Q	\$0.00	
NET TL	11.012Q	\$96.25	
		100.00%	

Total sales q'ty and total sales amount for price level 1

■ PLU/UPC pick up report

• Sample X report

12/08/2008		000001
#1809	4:45PM	
#0120 *X1*		
PLU/UPC		
PLU		
P00002		
PL00002	324.004Q	\$656.00
COMBO	0.000Q	\$0.00
WASTE	-2.000Q	-4.00
CP	2.000Q	-2.00
NET SLS	322.004Q	\$650.00
		33.09%
P00003		
PL00003	32.009Q	\$122.85
RF	-2.000Q	-6.00
CP	2.000Q	-2.00
NET SLS	30.009Q	\$114.85
		5.85%
P00004		
PL00004	35.002Q	\$148.00
CP	3.000Q	-3.00
NET SLS	35.002Q	\$145.00
		7.38%
P00005		
PL00005	40.010Q	\$249.75
CP	2.000Q	-2.00
NET SLS	40.010Q	\$247.75
		12.61%
P00006		
PL00006	15.003Q	\$106.20
CP	1.000Q	-2.50
NET SLS	15.003Q	\$103.70
		5.28%
P00007		
PL00007	21.001Q	\$152.95
CP	2.000Q	-1.00
NET SLS	21.001Q	\$151.95
		7.73%
P00008		
PL00008	15.021Q	\$286.80
CP	1.000Q	-2.50
NET SLS	15.021Q	\$284.30
		14.47%
P00009		
PL00009	8.002Q	\$89.55
NET SLS	8.002Q	\$89.55
		4.56%

PLU code
Item label for price level 1
Sales q'ty and amount for price level 1
Combo sales for price level 1
Coupon counter and total for price level 1
Net sales for price level 1

*1
If you need these information, please consult your dealer.

• Sample Z report

12/06/2008		000001
#1670	11:21PM	JACK0002
#0120 *Z1*		
PLU/UPC		
PLU/UPC	Z1/Z2	0007

The subsequent printout occurs in the same format as in the sample X report.

P00010		
PL00010	11.008Q	\$190.00
WASTE	-1.000Q	-10.00
CP	1.000Q	-2.50
NET SLS	10.008Q	\$177.50
		9.03%
***TOTAL 501.060Q \$2002.10		
COMBO TL	0.000Q	\$0.00
WASTE TL	-3.000Q	-14.00
		0.71%
RF TL	-2.000Q	-6.00
CP	14.000Q	-17.50
NET TL	496.060Q	\$1964.60
		100.00%
UPC		
5099887654302#		
ITEM A	5.012Q	\$71.25
NET SLS	5.012Q	\$71.25
		74.03%
5099887654303#		
ITEM B	2.000Q	\$7.00
NET SLS	2.000Q	\$7.00
		7.27%
5099887654304#		
ITEM M	4.000Q	\$18.00
NET SLS	4.000Q	\$18.00
		18.70%
***TOTAL 11.012Q \$96.25		
WASTE TL	0.000Q	\$0.00
		0.00%
RF TL	0.000Q	\$0.00
CP	0.000Q	\$0.00
NET TL	11.012Q	\$96.25
		100.00%

Total sales q'ty and total sales amount for price level 1

■ PLU/UPC report by associated department

• Sample X report

12/06/2008		000001
#1802	10:41AM	JACK0002
#0121 *X1*		
PLU BY DEPT		
DPT. 01	DO1	Associated dept. code
PLU		PLU code
P00002		Item label
PL00002	324.004Q	\$656.00
WASTE	-2.000Q	-4.00
CP	2.000Q	-2.00
NET SLS	322.004Q	\$650.00
		30.97%
P00003		
PL00003	32.009Q	\$122.85
RF	-2.000Q	-6.00
CP	2.000Q	-2.00
NET SLS	30.009Q	\$114.85
		5.47%
P00004		
PL00004	35.002Q	\$148.00
CP	3.000Q	-3.00
NET SLS	35.002Q	\$145.00
		6.91%
P00005		
PL00005	40.010Q	\$249.75
CP	2.000Q	-2.00
NET SLS	40.010Q	\$247.75
		11.80%
P00006		
PL00006	15.003Q	\$106.20
CP	1.000Q	-2.50
NET SLS	15.003Q	\$103.70
		4.94%
P00007		
PL00007	21.001Q	\$152.95
CP	2.000Q	-1.00
NET SLS	21.001Q	\$151.95
		7.24%
P00008		
PL00008	15.021Q	\$286.80
CP	1.000Q	-2.50
NET SLS	15.021Q	\$284.30
		13.54%
P00009		
PL00009	8.002Q	\$89.55
NET SLS	8.002Q	\$89.55
		4.27%

• Sample Z report

12/06/2008		000001
#1804	10:42AM	JACK0002
#0121 *Z1*		
PLU BY DEPT		
PLU BY DEPT	Z1/Z2	0007

The subsequent printout occurs in the same format as in the sample X report.

***TOTAL	508.066Q	\$2150.14	Total sales q'ty and total sales amount for price level 1
COMBO TL	0.000Q	\$0.00	
WASTE TL	-4.000Q	-25.00	
		1.18%	
RF TL	-3.000Q	-8.50	
CP	14.000Q	-17.50	
NET TL	501.066Q	\$2099.14	
		100.00%	
UPC			
5099887654303#			
ITEM B	2.000Q	\$7.00	
NET SLS	2.000Q	\$7.00	
		28.00%	
5099887654304#			
ITEM M	4.000Q	\$18.00	
NET SLS	4.000Q	\$18.00	
		72.00%	
***TOTAL	6.000Q	\$25.00	Total sales q'ty and total sales amount for price level 6
WASTE TL	0.000Q	\$0.00	
		0.00%	
RF TL	0.000Q	\$0.00	
CP	0.000Q	\$0.00	
NET TL	6.000Q	\$25.00	
		100.00%	

■ Individual group report on PLUs/UPCs

12/06/2008		000001
#1803	10:41AM	JACK0002
#0122 *X1*		
PLU IND. GROUP		
PLU		PLU code
P00001		
MILK	22.004Q	\$36.00
P00002		Sales q'ty and amount for price level 1
PL00002	322.004Q	\$650.00
P00003		Item label
PL00003	30.009Q	\$114.85
P00004		
PL00004	35.002Q	\$145.00
P00005		
PL00005	40.010Q	\$247.75

UPC		
5099887654302#		
ITEM A	5.012Q	\$71.25
5099887654303#		
ITEM B	2.000Q	\$7.00
5099887654304#		
ITEM M	4.000Q	\$18.00

PLU GR01	449.029Q	\$1193.60
Group 1 sales q'ty and amount		

■ PLU/UPC stock report by designated range

12/06/2008		000001
#1798	10:39AM	
#0124 *X1*		
PLU STOCK		
	00001-	00040
	Range	
PLU		
P00001		
MILK	43.000S	
P00002		PLU code
PL00002	16.000S	\$32.00
P00003		Stock q'ty
PL00003	21.000S	\$63.00

P00019		
PL00019	3.000S	\$57.00
P00020		
PL00020	4.000S	\$80.00

UPC		
5099887654303#		
ITEM B	4.000S	\$7.00

■ Full group total report on PLUs/UPCs

12/06/2008		000001
#1804	10:41AM	
#0123 *X1*		
PLU GROUP TOTAL		
		Item label
PLU GR01	449.029Q	\$1193.60
PLU GR02	69.035Q	\$807.00
PLU GR03	0.000Q	\$0.00
Sales q'ty and amount for PLU group 1		

PLU GR51	45.037Q	\$371.10
PLU GR52	59.027Q	\$629.50

■ PLU/UPC stock pick up report

12/06/2008		000001
#1818	9:40AM	
#0124 *X1*		
PLU STOCK		
PLU		
P00001		
PL00001	43.000S	
P00002		
PL00002	16.000S	\$32.00
P00003		
PL00003	21.000S	\$63.00

P00045		
PL00045	20.000S	\$900.00

UPC		
5099887654302#		
ITEM A	20.000S	\$50.00
5099887654303#		

■ PLU/UPC zero sales report (full)

```

12/06/2008 000001
#1730 5:06PM JACK0002

#0127 *X1*
PLU ZERO SALES

PLU
P00022 PL00022
P00024 PL00024
P00026 PL00026
P00027 PL00027
P00028 PL00028
P00029 PL00029
P00031 PL00031
P00033 PL00033
P00034 PL00034
P00035 PL00035
P00036 PL00036
P00037 PL00037
P00038 PL00038
P00039 PL00039
P00040 PL00040
P00041 PL00041
P00042 PL00042
P00043 PL00043
P00044 PL00044

-----
UPC
5099887654305#ITEM N
5099887654306#ITEM P
    
```

PLU code
Item label

■ PLU/UPC minimum stock report

```

12/06/2008 000001
#1800 10:40AM JACK0002

#0128 *X1*
PLU MINIMUM STOCK

PLU
P00019
PL00019 3.000$
P00020
PL00020 4.000$

-----
UPC
5099887654302#
ITEM A 4.000$
    
```

Range

PLU code

Item label

■ PLU/UPC zero sales (by dept.) report

```

12/06/2008 000001
#1563 8:10AM JACK0002

#0127 *X1*
PLU ZERO SALES

DPT. 01 DO1
PLU
P00022 PL00022

-----
UPC
5099887654303#ITEM B
5099887654304#ITEM M
    
```

PLU code
Associated dept. code
Item label

■ PLU/UPC price category report

• Sample X report

12/06/2008		000001
#1823	11:56AM	MIKE0001
#0129 *X1*		
PLU PRICE CATEGORY		
	1.50-	5.00
PLU		Price range
P00001		
MILK	22.004Q	\$36.00
P00002		
PL00002	322.004Q	\$650.00
P00003		
PL00003	30.009Q	\$114.85
P00004		
PL00004	35.002Q	\$145.00
P00005		
PL00005	40.010Q	\$247.75

***TOTAL	449.029Q	\$1193.60

UPC		Price level 1
5099887654302#		
ITEM A	5.012Q	\$71.25
5099887654303#		
ITEM B	2.000Q	\$7.00
5099887654304#		
ITEM M	4.000Q	\$18.00

***TOTAL	11.012Q	\$96.25

		Price level 1

■ Cash in drawer report

• Sample X report

12/06/2008		000001
#1569	8:12AM	
#0131 *X1*		
CID		
SRV#0001	MIKE	Server code
TRANS CT	40Q	Server name
NET3	\$1153.94	Transaction counter
****CID	\$1692.44	Sales total
		Cash in drawer
SRV#0002	JACK	
TRANS CT	81Q	
NET3	\$1730.28	
****CID	\$1442.62	
	SUE	

***TOTAL		
TRANS CT	121Q	
NET3	\$2884.22	Total
****CID	\$3135.06	

■ Positive check report

• Sample X report

12/06/2008		000001
#1731	10:24PM	JACK0002
#0139 *X1*		
POSITIVE CHECK		
#0000000000003030		
CHARGE7	\$62.02	
#0000000000006561		
CHECK3	\$110.00	

• Sample Z report

12/06/2008		000001
#1829	11:23PM	JACK0002
#0139 *Z1*		
POSITIVE CHECK		
#0000000000003030		
CHARGE7	\$62.02	
#0000000000006561		
CHECK3	\$110.00	

DynamicUPC report by designated range

• Sample X report

12/06/2008		000001
#1783	10:45PM	JACK0002
#0169 *X1*		
DYNAMIC UPC		
	00001-	999999
1123456789005#		
ITM(2)-1	5Q	\$15.85
NET SLS	5Q	\$15.85
		100.00%
ITM(2)-6	8Q	\$22.40
NET SLS	8Q	\$22.40
		100.00%

***TOTAL	5Q	\$15.85
WASTE TL	0Q	\$0.00
		0.00%
RF TL	0Q	\$0.00
CP	0Q	\$0.00
NET TL	5Q	\$15.85
		100.00%
WASTE TL	8Q	\$22.40
	0Q	\$0.00
		0.00%
RF TL	0Q	\$0.00
CP	0Q	\$0.00
NET TL	8Q	\$22.40
		100.00%

DynamicUPC pick up report

• Sample X report

12/06/2008		000001
#1799	10:59PM	JACK0002
#0169 *X1*		
DYNAMIC UPC		
1123456789005#		
ITM(2)-1	5Q	\$15.85
NET SLS	5Q	\$15.85
		100.00%
ITM(2)-6	8Q	\$22.40
NET SLS	8Q	\$22.40
		100.00%

***TOTAL	5Q	\$15.85
WASTE TL	0Q	\$0.00
		0.00%
RF TL	0Q	\$0.00
CP	0Q	\$0.00
NET TL	5Q	\$15.85
		100.00%
WASTE TL	8Q	\$22.40
	0Q	\$0.00
		0.00%
RF TL	0Q	\$0.00
CP	0Q	\$0.00
NET TL	8Q	\$22.40
		100.00%

*1

If you need these information, please consult your dealer.

• Sample Z report

12/06/2008		000001
#1783	11:16PM	JACK0002
#0169 *Z1*		
DYNAMIC UPC		



The subsequent printout occurs in the same format as in the sample X report.

■ Dynamic UPC report by associated department

- Sample X report

12/06/2008		000001
#1799	10:59PM	JACK0002
#0166 *X1*		
D-UPC BY DEPT		
DPT. 01		DO1
1123456789005#		
ITM(2)-1	5Q	\$15.85
NET SLS	5Q	\$15.85
		100.00%
ITM(2)-6	8Q	\$22.40
NET SLS	8Q	\$22.40
		100.00%

***TOTAL	5Q	\$15.85
WASTE TL	0Q	\$0.00
		0.00%
RF TL	0Q	\$0.00
CP	0Q	\$0.00
NET TL	5Q	\$15.85
		100.00%

WASTE TL	8Q	\$22.40
	0Q	\$0.00
		0.00%
RF TL	0Q	\$0.00
CP	0Q	\$0.00
NET TL	8Q	\$22.40
		100.00%

- Sample Z report

12/06/2008		000001
#1784	11:19PM	JACK0002
#0166 *Z1*		
D-UPC BY DEPT		



The subsequent printout occurs in the same format as in the sample X report.

*1

If you need these information, please consult your dealer.

Tax report

12/06/2008	000001
#1715 4:51PM	MIKE0001
#0133 *X1*	
TAX	
TAX1 ST	\$2568.73
GRS TAX1	\$158.41
RFD TAX1	-4.26
TAX1	\$154.15
TX1 EXPT	\$49.00
TAX2 ST	\$70.00
GRS TAX2	\$3.50
TAX2	\$3.50
TX2 EXPT	\$15.00
TAX3 ST	\$58.00
GRS TAX3	\$2.90
TAX3	\$2.90
TAX4 ST	\$172.00
GRS TAX4	\$13.76
TAX4	\$13.76
TAX5 ST	\$308.00
GRS TAX5	\$21.56
TAX5	\$21.56
GRS MTAX	\$1.14
M-TAX	\$1.14
TTL TAX	\$197.01

(When the Canadian tax system is selected)

Net taxable 1 total
Gross tax 1 total
Refund tax 1 total
Net tax 1 total
Taxable 1 exempt total
Gross manual tax total
Net manual tax total
Tax total

TAX1 ST	\$39.45
GRS TAX1	\$2.53
RFD TAX1	-0.15
TAX1	\$2.38
TX1 EXPT	\$5.00

Tax 1

TAX4 ST	\$39.29
GRS TAX4	\$2.59
RFD TAX4	-0.47
TAX4	\$2.12
TX4 EXPT	\$7.98
GRS MTAX	\$1.47
RFD MTAX	-0.38
M-TAX	\$1.09
GST EXPT	\$20276.17
PST TTL	\$6.03
GST TTL	\$2.12

Tax 4

Manual tax
Exempt total from GST
PST total
GST total

Key capture report

12/06/2008	000001
#1716 11:32PM	JACK0002
#0179 *X1*	
KEY CAPTURE	
#01	
12/06/2008 10:15PM	
#1628	JACK0002
CAPTURE01	
12345	
#02	
12/06/2008 10:16PM	
#1629	JACK0002
CHARGES	
123456	
12/06/2008 10:16PM	
#1630	JACK0002
CAPTURE02	
123456	

Capture job no.
Capture information

Individual server report

• Sample X report

12/06/2008	000001
#1812 4:21PM	JACK0002
#0141 *X1*	
IND. SERVER	
SRV#0003	SUE
NET1	\$1403.64
CA TIP 1Q	\$2.00
CH TIP 1Q	\$3.00
TIP PAID 2Q	\$19.00
TRANS CT 43Q	
COVER CT 43Q	
NET3	\$1488.50
CLOSE CK 0Q	\$0.00
OPEN CK 0Q	\$0.00
TRAN. OUT 0Q	\$0.00
TRAN. IN 0Q	\$0.00
***RA 0Q	\$0.00
***RA2 0Q	\$0.00
***PO 0Q	\$0.00
***PO2 0Q	\$0.00
REFUND 0Q	\$0.00
RETURN 0Q	\$0.00
DIR VD 0Q	\$0.00
PAST VD 0Q	\$0.00
(-) 1 4Q	-4.00
%2 2Q	-3.90
%3 1Q	-0.24
%5 1Q	-1.02
GDISC%1 3Q	-2.70
GDISC%TL 3Q	-2.70
FS ID	\$25.00
CASH 26Q	\$1088.56
CASH2 1Q	\$12.72
CASH3 1Q	\$40.95
CASH4 1Q	\$12.72
CASH5 1Q	\$12.96
CHARGE2 1Q	\$34.29
CHARGE3 1Q	\$18.20
CHARGE4 2Q	\$40.26
CHARGE5 1Q	\$18.12
CHECK1 2Q	\$34.73
CHECK2 2Q	\$30.18
CHECK3 1Q	\$29.16
CHECK4 1Q	\$25.44
CHECK6 1Q	\$45.21
CHECK9 1Q	\$19.00
CA+CH ID	\$1352.63
***CID	\$1168.91

- Server code
- Server name
- Net sales total
- Cash tip-in
- Charge tip-in
- Tip paid counter and total
- Transaction counter
- Cover counter
- Closed GLU/PBLU counter and total
- Open GLU/PBLU counter and total
- Transfer-out counter and total
- Transfer-in counter and total

• Sample Z report

12/06/2008	000001
#1838 4:36PM	MIKE0001
#0141 *Z1*	
IND. SERVER	
SERVER Z1/Z2	0006

The subsequent printout occurs in the same format as in the sample X report.

GAS (-) 19	0Q	\$0.00
DRW CNT	146Q	
CONV 1		30.00
CONV 2		40.00
CONV 3		35.00
CONV 4		33.00
CASH	528Q	\$21822.00
CASH2	2Q	\$35.74
CASH3	2Q	\$40.72
CASH4	3Q	\$56.96
CASH5	2Q	\$45.57
CHARGE1	10Q	\$150.35
CHARGE1-	1Q	-3.75

CHARGE9	5Q	\$47.18
CHARGE9-	1Q	-8.63
CHECK1	3Q	\$162.50
CHECK2	3Q	\$65.05
CHECK3	6Q	\$260.20
CHECK4	4Q	\$120.65
CHECK5	3Q	\$162.39
CA+CH ID		\$22331.89
***CID		\$21561.10
GROUP1	3238Q	\$4331.65
GROUP2	7953Q	\$18765.10
GROUP3	6Q	\$36.12
GROUP4	0Q	\$0.00
GROUP5	0Q	\$0.00
GROUP6	0Q	\$0.00
GROUP7	0Q	\$0.00
GROUP8	0Q	\$0.00
GROUP9	7Q	\$8.40

Server group 1 total

NOTE When the tip amount remains unchanged in Individual Server Resetting, the tip paid function is automatically executed and a tip receipt is printed on the report printer prior to report printing.

■ Full server report

- Sample X report

```

12/06/2008 000001
#1574      8:14AM  MIKE0001

#0140 *X1*
ALL SERVER
    
```

- Sample Z report

```

12/06/2008 000001
#1577      8:17AM  MIKE0001

#0140 *Z1*
ALL SERVER

SERVER Z1/Z2                0006 — Reset counter
    
```

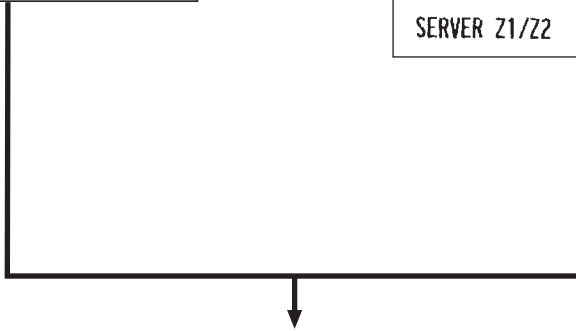

The subsequent printout occurs in the same format as in the sample report shown in the "Individual server report"; and sales data on servers print in this sequence.

■ SCM(Starting cash memory)report

```

12/06/2008 000002
#2060      4:29PM

#0147 *X1*
SCM

SRV#0001      MIKE
SCM (+)       $272.20
SCM (-)       -10.00
SCM TTL       $262.20
SRV#0002      JACK
SCM (+)       $275.70
SCM TTL       $275.70
SRV#0003      SUE
SRV#0004      SERV. 004
SRV#0005      SERV. 005
SRV#0006      SERV. 006
SRV#0007      SERV. 007

SRV#0013      SERV. 013
SRV#0014      SERV. 014
SRV#0015      SERV. 015

***TOTAL
SCM (+)       $547.90
SCM (-)       -10.00
SCM TTL       $537.90
    
```

Hourly report

• Sample X report

12/06/2008			000001
#1576	8:15PM	MIKE0001	
#0160 *X1*			
HOURLY			
10:00PM	9Q	\$39.50	Transaction counter
COVER CT	9Q		Sales total
AVE.		\$4.39	Cover counter
10:30PM	2Q	\$22.00	Average sales amount per customer (Sales total/cover counter)
COVER CT	2Q		
AVE.		\$11.00	
SUBTOTAL	11Q	\$61.50	Subtotal (10:00 - 10:59)
COVER CT	11Q		

7:00PM	2Q	\$34.50	
COVER CT	2Q		
AVE.		\$17.25	
7:30PM	3Q	\$23.00	
COVER CT	3Q		
AVE.		\$7.67	
SUBTOTAL	5Q	\$57.50	
COVER CT	5Q		

• Sample Z report

12/06/2008			000001
#1576	8:15PM	MIKE0001	
#0160 *Z1*			
HOURLY			
HOURLY Z1			

↓

The subsequent printout occurs in the same format as in the sample X report.

NOTE

The hourly report can be formatted by 15 min., 30 min., or 1 hour intervals depending upon programming.

■ GLU/PBLU report

• Sample X report

12/06/2008		000001
#1801	10:34PM	JACK0002
#0180 *X1*		
GLU		
1#		1-9999
COVER CT	2Q	0002
***PBAL		\$25.00
2#		0002
COVER CT	2Q	0002
***PBAL		\$67.50
8T		0006
COVER CT	3Q	
***PBAL		\$81.60
FREE GLU		
7#		
COVER CT	2Q	
***PBAL		\$37.50
***TOTAL		
COVER CT	9Q	
***PBAL		\$196.75

Range
Table#/PBLU code
Server code
Cover counter
Balance amount

"T": This table#/PBLU code was used in the training mode.

Free table#/PBLU code
(This number or code has been transferred out.)

Total

• Sample Z report

12/06/2008		000001
#1790	11:21PM	JACK0002
#0180 *Z1*		
GLU		
GLU Z1		0006

↓
The subsequent printout occurs in the same format as in the sample X report.

■ GLU/PBLU report by server

• Sample X report

12/06/2008		000001
#1805	10:36PM	JACK0002
#0181 *X1*		
GLU BY SERVER		
SRV#0002	JACK	
1#		
COVER CT	2Q	
***PBAL		\$25.00
FREE GLU		
7#		
COVER CT	2Q	
***PBAL		\$37.50
***TOTAL		
COVER CT	9Q	
***PBAL		\$196.75

Server code
Server name
Table#/PBLU code
Cover counter
Balance amount

• Sample Z report

12/06/2008		000001
#1791	11:26PM	JACK0002
#0181 *Z1*		
GLU BY SERVER		
GLU Z1		0007

↓
The subsequent printout occurs in the same format as in the sample X report.

■ Closed GLU/PBLU report

• Sample X report

```

12/06/2008 000001
#1810 10:39PM JACK0002

#0182 *X1*
CLOSED GLU

0001# 0001-9999
TBL#1 0002
COVER CT 2Q
CHARGE1 $56.92
TIP AMT $0.00
FIN. BAL $56.92
0002# 0002
TBL#2
COVER CT 2Q
CHARGE1 $39.31
TIP AMT $0.00
FIN. BAL $39.31
0003# 0002
TBL#4
COVER CT 2Q
CASH $80.77
    
```

Bill no.
 Bill range
 Server code
 Table#
 Cover counter
 Amount
 Tip amount by tip edit
 Final balance amount

```

FIN. BAL $88.03

***TOTAL
COVER CT 14Q
CASH 1Q $80.77
CHK/CG 2Q $1.94
CHECK1 1Q $85.00
CHECK2 1Q $85.00
CHARGE1 1Q $96.23
CHARGE2 2Q $70.77
CONV 1 1Q 116.64
TIP AMT 0Q $0.00
FIN. BAL 7Q $503.86
    
```

Total

• Sample Z report

```

12/06/2008 000001
#1792 11:27PM JACK0002

#0182 *Z1*
CLOSED GLU

GLU Z1 0008
    
```



The subsequent printout occurs in the same format as in the sample X report.

■ Closed GLU/PBLU report by server

• Sample X report

12/06/2008	000001		
#1814	10:39PM	JACK0002	
#0183 *X1*			
CL-GLU BY SERVER			
SRV#0002	JACK		Server code
0001#			Server name
TBL#1			Bill no.
COVER CT	2Q		Table#
CHARGE1		\$56.92	Cover counter
TIP AMT		\$0.00	Amount
FIN. BAL		\$56.92	Tip amount by tip edit
0002#			Final balance amount
TBL#2			
COVER CT	2Q		
CHARGE1		\$39.31	
FIN. BAL			
		\$88.03	
***TOTAL			
COVER CT	14Q		} Total
CASH	1Q	\$80.77	
CHK/CG	2Q	\$1.94	
CHECK1	1Q	\$85.00	
CHECK2	1Q	\$85.00	
CHARGE1	1Q	\$96.23	
CHARGE2	2Q	\$70.77	
CONV 1	1Q	116.64	
TIP AMT	0Q	\$0.00	
FIN. BAL	7Q	\$503.86	

• Sample Z report

12/06/2008	000001		
#1794	11:27PM	JACK0002	
#0183 *Z1*			
CL-GLU BY SERVER			
GLU Z1			0009

↓

The subsequent printout occurs in the same format as in the sample X report.

■ X1/Z1 stacked reports

You can print multiple X1/Z1 reports in sequence under a single report job number. In this case, you need to program in advance which X1/Z1 reports should be printed. Refer to "Stacked report" under the section "Report Programming" in Chapter 13.

Periodic Consolidation

Your POS terminal allows you to take consolidation X and Z reports of a chosen period (the period is usually one week or month).

• General overview

The periodic reading or resetting reports are the same in format as those in the X1/Z1 report for daily sales information except mode indication ("X2" or "Z2").

■ Transaction report

• Sample X report

```
12/06/2008 000002
#2050 2:39PM JACK0002

#0230 *X2*
TRANSACTION
```

Read symbol
Report title

• Sample Z report

```
12/06/2008 000002
#2054 2:44PM JACK0002

#0230 *Z2*
TRANSACTION

TRANS. Z1 0005
TRANS. Z2 0002
GT1 $00000154443.01
GT2 $00000155077.14
GT3 -00000000634.13
TR $00000000000.00
```

Reset symbol
Report title
Reset counter of periodic consolidation
Grand totals

The subsequent printouts are the same in format as those in the X/Z report on daily totals.

■ Daily net report

- Sample X report

12/06/2008			000002
#2047	11:15PM	JACK0002	
#0270 *X2*			
DAILY NET			
11/01	102Q	\$5305.60	Date Transaction counter Sales total
11/02	82Q	\$3457.20	
11/03	142Q	\$6041.58	
11/29	205Q	\$10747.20	
11/30	103Q	\$5470.00	
***TOTAL	3714Q	\$182021.58	

- Sample Z report

12/06/2008			000002
#2052	2:42PM	JACK0002	
#0270 *Z2*			
DAILY NET			
DAILY NET Z2			0002
***TOTAL	0Q	\$0.00	



The subsequent printout occurs in the same format as in the sample X report.

■ Customer sales report

NOTE Customer details only report and customer sales all report are printed in the same format. You can print either report depending on the programming of CUSTOMER DATA in FUNC.SELECT2 menu. On the customer details only report, you can print details (date/sales item) only. On the customer sales all report, you can print (and reset in Z2 mode) accumulated sales q'ty/total and details.

#0285 *X2*			*
CUSTOMER SALES			
#0000000000001-#9999999999999			Code range
#0000000035521			Customer code
NAME-4194			Name
ADDRESS-4194			Address
	3Q	\$70.77	Sales q'ty and total
CHARGE		\$25.20	Charge account
12/12/2008			Date
3112345678905#			
AAA000	1Q	\$1.70	Sales items
12/13/2008			
P00004			
PL00004-1	1Q	\$2.70	
#0000000065321			
NAME-65321			
ADDRESS-65321			
	1Q	\$57.52	
CHARGE		\$0.00	
12/12/2008			
P00002			
PL00002-1	25Q	\$57.50	
P00003			
PL00003-1	17Q	\$52.70	
P00003			
PL00003-1	-17Q	-52.70	
SUBTOTAL	6Q	\$261.28	Subtotal on the report
CHARGE		\$89.38	
***TOTAL	6Q	\$261.28	The full total on the customer file
CHARGE		\$89.38	

* When you take a Z report, "Z2" is printed instead of "X2".

■ Customer sales report by sales range

#0286 *X2*			*
CUSTOMER BY AMT			
	\$0.01-\$9999999.99		Sales range
#0000000035521			Customer code
NAME-4194			Name
ADDRESS-4194			Address
	3Q	\$70.77	Sales q'ty and total
CHARGE		\$25.20	Charge account
12/12/2008			Date
3112345678905#			
AAA000	1Q	\$1.70	Sales items

* When you take a Z report, "Z2" is printed instead of "X2".

#0000000065321			
NAME-65321			
ADDRESS-65321			
	1Q	\$57.52	
CHARGE		\$0.00	
12/12/2008			
P00002			
PL00002-1	25Q	\$57.50	
P00003			
PL00003-1	17Q	\$52.70	
P00003			
PL00003-1	-17Q	-52.70	
SUBTOTAL	6Q	\$261.28	Subtotal on the report
CHARGE		\$89.38	
***TOTAL	6Q	\$261.28	The full total on the customer file
CHARGE		\$89.38	

■ Customer charge account report

#0288 *X2*			*
CHARGE ACCOUNT			
#0000000000020			Customer code
NAME-20			Name
ADDRESS-20			Address
CHARGE		\$27.36	
#0000000000075			
NAME-75			
ADDRESS-75			
CHARGE		\$62.02	
SUBTOTAL			
CHARGE		\$89.38	
***TOTAL			
CHARGE		\$89.38	

■ X2/Z2 stacked report

You can print multiple X2/Z2 reports in sequence under a single transaction. In this case you need to program in advance which X2/Z2 reports should be printed. Refer to "Stacked report" under "Report Programming" in Chapter 13 "Programming."

* When you take a Z report, "Z2" is printed instead of "X2".

Electronic journal

This function is intended to record the journal data in the electronic paper. For details, consult your authorized SHARP dealer.

• Recording data

The POS terminal records the printing output to the journal printer in REG, PGM1, PGM2, X1/Z1, and X2/Z2 modes into the electronic journal file.

• Reporting (X report)

The POS terminal reports the journal data (same as normal journal formats) in the electronic journal file by the report printer or the display.

Operation: Select the reading operation "E.JOURNAL" in the X1/Z1 mode.

It is possible to designate the range or code as follows:

C.C. No. (Consecutive no.):	ALL or RANGE (designate start no./end no.)
DATE (Date):	ALL or RANGE (designate start date/end date)
TIME (Time):	ALL or RANGE (designate start time/end time)
SERVER (Server/Cashier code):	ALL or INDIVIDUAL (designate server/cashier code)

• Resetting (Z report)

It is possible to take the resetting report of the journal data in the electronic journal file by the report printer.

Operation: Select the resetting operation "E.JOURNAL" in X1/Z1 or OPXZ mode.

It is possible to designate the range (consecutive no./date/time) or server/cashier code as shown in the Reporting (X report) paragraph can not be used.

11

Non-accessed UPC, Dynamic UPC and Customer Code Deletion

X1/Z1 MODE

X2/Z2 MODE

You can delete UPCs and customer codes that have not been accessed for a certain period. You can program this period in the PGM2 mode. As for customer codes, you can delete any customer code with regardless of the non-accessed period.

Follow the procedure below.

Non-accessed UPC deletion

1. Enter the X1/Z1 mode from the mode selection window.
2. Select "2 RESETTING".
3. Select "8 NON ACCESSED UPC" to delete non-accessed UPCs.
4. When you select "8 NON ACCESSED UPC", select whether to delete all the non-accessed UPCs at a time (1 ALL DELETE) or delete the non-accessed UPCs individually (2 IND.DELETE).

NOTE *It is recommended that you first take a report before deleting operation.*

Dynamic UPC clear

1. Enter the X1/Z1 mode from the mode selection window.
2. Select "2 RESETTING".
3. Select "9 D-UPC CLEAR" to clear a designated range of UPCs, "10 D-UPC CLEAR PICK" to pick up codes one by one to clear them (see the "NOTE" on page 89), or "11 D-UPC CLEAR DEPT" to clear codes on an associated department basis.

Non-accessed customer deletion

1. Enter the X2/Z2 mode from the mode selection window.
2. Select "5 NON ACCESS. CUST."
3. Select "1 READING" to take a report, or "2 DELETE" to delete non-accessed customer codes.
4. When you select "2 DELETE", select whether to delete all the non-accessed customer codes at a time (1 ALL DELETE) or delete non-accessed customers codes individually (2 IND.DELETE).

NOTE *It is recommended that you first take a report before deleting operation.*

Customer code deletion

1. Enter X2/Z2 mode from the mode selection window.
2. Select "6 CUSTOMER DELETE"
3. Specify the range (start/end customer codes) you want to delete.

■ Non-accessed UPC report

#0105 *X1*			*1
NON ACCESSED UPC			
UPC			
3112345678905#			UPC code
AAAA00	0Q	\$0.00	Item label
	0Q	\$0.00	
	0Q	\$0.00	
	0Q	\$0.00	
	0Q	\$0.00	
ITEM-J-6	0Q	\$0.00	
3222222222221#			
ITEM-U-1	1Q	\$0.10	
NET SLS	1Q	\$0.10	
	0Q	\$0.00	
	0Q	\$0.00	
	0Q	\$0.00	
	0Q	\$0.00	
ITEM-U-6	0Q	\$0.00	

*2

*1 When you select "DELETE", "Z1" is printed instead of "X1".

*2 When there is any sales data of the UPC for PLU/UPC report, the data is printed here.

When you delete the UPC in Z1 mode under this situation, the UPC data for PLU/UPC report is also deleted.

■ Non-accessed customer report

#0287 *X2*			*
NON ACCESSED CUST.			
#0000000000020			
			Customer code
NAME-20			
			Name
ADDRESS-20			
			Address
	2Q	\$67.37	
CHARGE		\$27.36	
#0000000000075			
NAME-75			
ADDRESS-75			
	3Q	\$136.39	
CHARGE		\$62.02	
#0000000065321			
NAME-65321			
ADDRESS-65321			
	1Q	\$57.52	
CHARGE		\$0.00	
SUBTOTAL	6Q	\$261.28	
CHARGE		\$89.38	
***TOTAL	6Q	\$261.28	
CHARGE		\$89.38	

* When you select "DELETE", "Z2" is printed instead of "X2".

Customer delete report

#0298 *Z2*			
CUSTOMER DELETE			
#0000000000001-#999999999999			Customer range
#0000000000102			Customer code
NAME-102			Name
ADDRESS-102			Address
CHARGE	0Q	\$0.00	
		\$0.00	
#0000000000123			
NAME-123			
ADDRESS-123			
CHARGE	0Q	\$0.00	
		\$0.00	
#00000000005678			
NAME-5678			
ADDRESS-5678			
CHARGE	0Q	\$0.00	
		\$0.00	
SUBTOTAL	0Q	\$0.00	
CHARGE		\$0.00	
***TOTAL	0Q	\$0.00	
CHARGE		\$0.00	

Dynamic UPC clear

(by designated range)

#0168 *Z1*			
D-UPC CLEAR			
1000000000000-999999999999			
1123456789005#			
ITM (2)-1	5Q	\$15.85	*1
NET SLS	5Q	\$15.85	
		100.00%	
ITM (2)-6	8Q	\$22.40	*1
NET SLS	8Q	\$22.40	
		100.00%	
--- --			
***TOTAL	5Q	\$15.85	*1
WASTE TL	0Q	\$0.00	
		0.00%	
RF TL	0Q	\$0.00	*1
CP	0Q	\$0.00	
NET TL	5Q	\$15.85	
		100.00%	
WASTE TL	8Q	\$22.40	*1
	0Q	\$0.00	
		0.00%	
RF TL	0Q	\$0.00	
CP	0Q	\$0.00	
NET TL	8Q	\$22.40	
		100.00%	

(by pickup list)

#0168 *Z1*
D-UPC CLEAR

(by associated dept.)

#0167 *Z1*	
D-UPC CLR DEPT	
DPT. 01	DO1

*1
If you need these information,
please consult your dealer.

12

How to Use the Programming Keyboard

Programming Keyboard Layout

When you are in the PGM 1 or PGM 2 mode, the keyboard layout will be shifted to the one for programming as shown below.

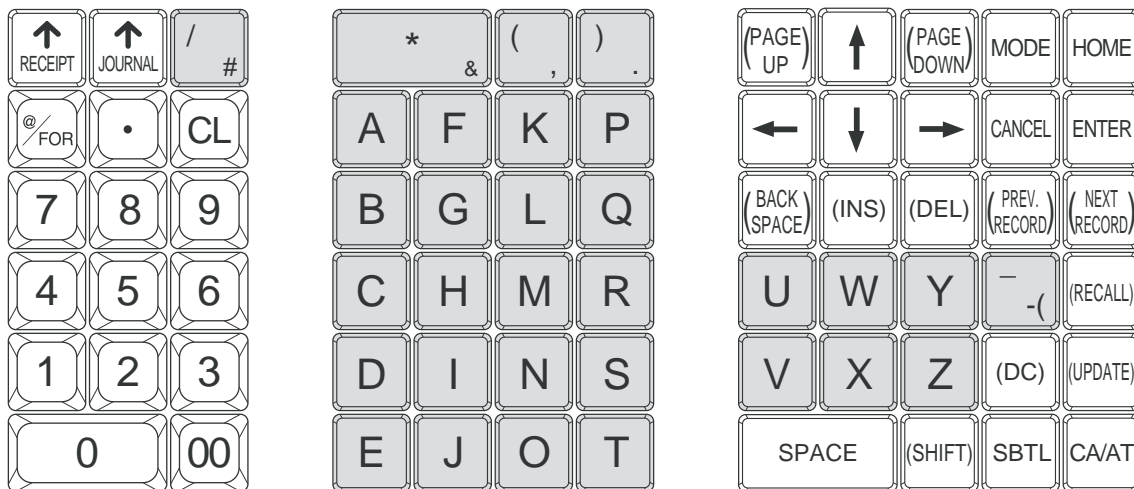

Shaded Area: The shaded area contains the character keys which are used for programming.

(SHIFT) (DC) (INS) (DEL) (BACK SPACE) : Used for entry of characters. For more information about characters for programming, see the section "How to Enter Text Using Alphanumeric Characters."

→ ← ↑ ↓ : Used to move the cursor.

(ENTER) : Used to enter each setting.

CA/AT : Used to finalize programming.

(CANCEL) : Used to cancel programming and to get back to the previous screen.

(PREV. RECORD) : Used to go back to the previous record, e.g., from the department 2 programming window back to the department 1 programming window.

(NEXT RECORD) : Used to go to the next record, for example, in order to program unit prices for sequential departments.

(PAGE DOWN) : Used to scroll the window to go to the next page.

(PAGE UP) : Used to scroll the window to go back to the previous page.

CL : Used to clear the last setting you have entered or clear an error state.







. : Used to toggle between two or more options.

SBTL : Used to list those options which you can toggle by the . key.

(RECALL) : Used to call up a desired code.

(UPDATE) : Used to update PLU unit price or name.

Numeric keys: Used for entering figures.

Regarding the , , , , , ,  keys, you can use the corresponding keys on the screen to perform the same actions:

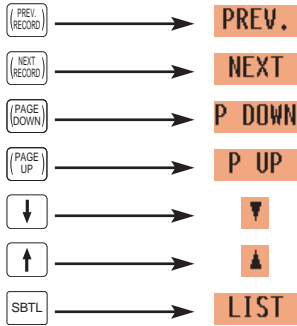

For more information about these keys, see the Basic Procedures section in Chapter 13 Programming.

How to Enter Text Using Alphanumeric Characters

This section discusses how to enter text using alphanumeric characters such as DESCRIPTION, NAME and TEXT.

■ Using character keys on the keyboard

Entering alphanumeric characters

To enter a character, simply press the corresponding character key on the programming keyboard sheet. To enter a digit, simply press the corresponding numeric key.

Entering double-size characters

 : This key toggles the double-size character mode and the normal-size character mode. The default is the normal-size character mode. When the double-size character mode is selected, the letter “W” appears at the bottom of the display.

Entering lower-case letters

 : You can enter lower-case letter by using this key. Press this key just before you enter the lower-case letter. The shifted state is held until this key is pressed again.

Editing text

You can edit the text you have entered by deleting and/or inserting characters.

To select a text editing mode

 : Toggles between the insert mode (“_”) and the overwrite (“■”) mode.

To move the cursor

 or  : Moves the cursor.

To delete a character or figure

 : Deletes a character or figure in the cursor position.

 : Moves the cursor back and deletes the character or figure at the left of the cursor.

Text copy/paste

Copy (to the buffer) : Move the cursor to the target text line to copy, and press  key.

Paste (from the buffer) : Move the cursor to the target text line to paste, and press  key.

■ Entering character codes

Numerals, letters and symbol can be used for programming by pressing the **00** key followed by character codes. Use the following procedure with the cursor placed at the position where you want to enter characters:

00 → XXX XXX: Character code (3 digits)

Character code:

032 - 047	032	033	034	035	036	037	038	039	040	041	042	043	044	045	046	047
		!	"	#	\$	%	&	'	()	*	+	,	-	.	/
048 - 063	048	049	050	051	052	053	054	055	056	057	058	059	060	061	062	063
	0	1	2	3	4	5	6	7	8	9	:	;	<	=	>	?
064 - 079	064	065	066	067	068	069	070	071	072	073	074	075	076	077	078	079
	@	A	B	C	D	E	F	G	H	I	J	K	L	M	N	O
080 - 095	080	081	082	083	084	085	086	087	088	089	090	091	092	093	094	095
	P	Q	R	S	T	U	V	W	X	Y	Z	[\]	^	_
096 - 111	096	097	098	099	100	101	102	103	104	105	106	107	108	109	110	111
	`	a	b	c	d	e	f	g	h	i	j	k	l	m	n	o
112 - 127	112	113	114	115	116	117	118	119	120	121	122	123	124	125	126	127
	p	q	r	s	t	u	v	w	x	y	z	{		}	~	Δ
128 - 143	128	129	130	131	132	133	134	135	136	137	138	139	140	141	142	143
	Ç	ü	é	â	ä	à	ã	ç	ê	ë	è	ï	î	ì	Ä	Å
144 - 159	144	145	146	147	148	149	150	151	152	153	154	155	156	157	158	159
	É	æ	ƒ	ô	ö	ò	û	ù	ÿ	ö	ü	ç	ƒ	¥	℞	f
160 - 175	160	161	162	163	164	165	166	167	168	169	170	171	172	173	174	175
	á	í	ó	ú	ñ	Ñ	º	º	¿	¡	½	¼	¿	«	»	
176 - 191	176	177	178	179	180	181	182	183	184	185	186	187	188	189	190	191
	⋮	⋮	⋮					π	π	π	π	π	π	π	π	π
192 - 207	192	193	194	195	196	197	198	199	200	201	202	203	204	205	206	207
	L	L	T	T	-	T	T		U	π	π	π		=		±
208 - 223	208	209	210	211	212	213	214	215	216	217	218	219	220	221	222	223
		T	π	U	U	F	π		†	J	π	■	■			■
224 - 239	224	225	226	227	228	229	230	231	232	233	234	235	236	237	238	239
	α	β	Γ	π	Σ	σ	μ	τ	ϑ	θ	Ω	δ	ω	∅	€	Π
240 - 255	240	241	242	243	244	245	246	247	248	249	250	251	252	253	254	255
	≡	±	≥	≤	↑	J	÷	≈	°	.	-	J	n	z	■	(DC)

*(DC) : Double-size character code

"_" (095): Line feed code

■ : Shade characters can not be printed by the built-in printer (display only).

13 Programming

PGM1 MODE
PGM2 MODE
SD CARD MODE

This chapter explains how to program various items. Before you start programming, select the PGM1, PGM2 or SD CARD mode from the mode selection screen depending on the item you are going to program.

Basic Procedure

This section illustrates the basic programming by using an example of programming for departments.

■ Programming screens

Opening screen: When you select the PGM1, PGM2 or SD CARD mode from the mode selection screen, your display will show a programming opening screen corresponding to the mode you selected.

Programming menu: Use the cursor keys or numeric keys to select the desired option and press the **[ENTER]** key, or touch the option on the screen.

Mode you are in

Numeric key area

Common status area

Numeric key data area

Code selecting screen (Dept. PLU/UPC, Customer):

Code title

Code number and its description:
(In case of PLU/UPC and customer, two lines are used for one code, upper line - code, lower line - description.)

Use the cursor keys or numeric keys to select the desired option and press the **[ENTER]** key, or touch the option on the screen. (When you select the last item, the screen goes to the selected option screen without pressing the **[ENTER]** key.)

Programming screen:

Selected menu message

Setting items:
Use the cursor to select the desired option or touch it on the screen.

There are three entry methods described below:
 Numeric entry : Use numeric keys.
 Character entry : Use character keys.
 Selective entry : Press the **[.]** key to toggle options and press the **[ENTER]** key to select it, or press the **[SBTL]** key to show the options list. Use the cursor keys to move the cursor and press the **[ENTER]** key to select it, or touch the option on the screen.

■ Programming example

The following example shows how to preset 2.00 for the unit price, ABCDE for the description, and taxable 2 yes for department

Procedure

PGM2 MODE	↓ P UP ▲	CAN	CEL	.	CL
01 READING					
02 SETTING		7	8	9	
03 AUTO KEY					
04 D-UPC LOAD		4	5	6	
05 DATA CLEAR					
06 OPEN STORE		1	2	3	
07 CLOSE STORE					
08 KP READING		0	00	ENTR	
PREV. NEXT LIST P DOWN ▼					
PGM2 MIKE					0001
		11	06AM		

(ENTER) ↓ ↑ (CANCEL)

SETTING	↓ P UP ▲	CAN	CEL	.	CL
01 ARTICLE					
02 DIRECT KEY		7	8	9	
03 PLU MENU KEY					
04 FUNCTION		4	5	6	
05 MEDIA					
06 TEXT		1	2	3	
07 PERSONNEL					
08 TERMINAL		0	00	ENTR	
PREV. NEXT LIST P DOWN ▼					
PGM2 MIKE					0001
		11	07AM		



(ENTER) ↓ ↑ (CANCEL)

ARTICLE	↓ P UP ▲	CAN	CEL	.	CL
01 DEPARTMENT					
02 PLU/UPC		7	8	9	
03 DYNAMIC UPC					
04 PLU RANGE		4	5	6	
05 PLU STOCK					
06 LINK PLU TABLE		1	2	3	
07 CONDIMENT TABLE					
08 MIX&MATCH		0	00	ENTR	
PREV. NEXT LIST P DOWN ▼					
PGM2 MIKE					0001
		11	07AM		



(ENTER) ↓ ↑ (CANCEL)

DEPARTMENT	↓ P UP ▲	CAN	CEL	.	CL
01 DPT.01					
02 DPT.02		7	8	9	
03 DPT.03					
04 DPT.04		4	5	6	
05 DPT.05					
06 DPT.06		1	2	3	
07 DPT.07					
08 DPT.08		0	00	ENTR	
PREV. NEXT LIST P DOWN ▼					
PGM2 MIKE					0001
		11	08AM		

(ENTER) ↓ ↑ (CANCEL)



1. In the PGM2 MODE window, select "02 SETTING" by using the  or  key and press the  key.
The SETTING screen will appear.

NOTE

- You can also select "2 SETTING" by using numeric key "2", then pressing the  key, or touching "2 SETTING" on the screen.
- To return to the previous screen, press the  key.

2. Select "01 ARTICLE".
The ARTICLE window will appear.

NOTE

- The arrow mark  in the window shows that the window contains more options than are now on the screen. To scroll the window, press the  key.
To return to the previous page, press the  key.

3. Select "01 DEPARTMENT".
The DEPARTMENT window will appear, listing programmable departments.

4. Select "01 DPT.01" to program for department 1.
The 01 window will appear.

01		↓ P UP ▲	CAN	·	CL
PRICE			0.00	CEL	
SIGN			+	7	8 9
DESCRIPTION	DPT. 01			4	5 6
ITEM VP	NON-COMPULSORY			1	2 3
TARE No.	0			0	00
SCALE	INHIBIT				ENTR
SIF/SICS	NORMAL				
DEPT. TYPE	NORMAL				
PREV. NEXT LIST P DOWN ▼					
PGM2 MIKE					0001
					11:08AM

(ENTER) ↓

01		↓ P UP ▲	CAN	·	CL
PRICE			2.00	CEL	
SIGN			+	7	8 9
DESCRIPTION	SOMEDEPTNAME			4	5 6
ITEM VP	NON-COMPULSORY			1	2 3
TARE No.	0			0	00
SCALE	INHIBIT				ENTR
SIF/SICS	NORMAL				
DEPT. TYPE	NORMAL				
PREV. NEXT LIST P DOWN ▼					
PGM2 MIKE					0001
					4 27PM

(PAGE DOWN) ↓

↑ (PAGE UP)

01		↑↓ P UP ▲	CAN	·	CL
ENTRY TYPE	OPEN&PRESET				
TAXABLE 1	NO			7	8 9
TAXABLE 2	YES			4	5 6
TAXABLE 3	NO			1	2 3
TAXABLE 4	NO			0	00
TAXABLE 5	NO				ENTR
FS/CASH BNF	NO				
GROUP DISCOUNT1	YES				
PREV. NEXT LIST P DOWN ▼					
PGM2 MIKE					0001
					4:29PM

5. On the first page of the “01” window, preset the unit price and description as follows:

NOTE

There are three entry methods for the programming: numeric entry, character entry, and selective entry.

- Move the cursor to or touch “PRICE”, enter “200” by using numeric keys, then press the (ENTER) key. → **Numeric entry**
- Move the cursor to or touch “DESCRIPTION”, enter “SOMEDEPTNAME” by using character keys, then press the (ENTER) key. → **Character entry**

If you want to clear the setting, press the (CA/AT) key before you press the (ENTER) key.

6. Press the (PAGE DOWN) key and you will see the page as shown left, then program the machine to set “TAXABLE 2” as follows:

- Move the cursor to or touch “TAXABLE 2”, press the (·) key to select “YES,” then press the (ENTER) key. → **Selective entry method**

NOTE

The (·) key toggles between two options as follows:
NO → YES → NO →

Pressing the (SBTL) key displays all pertinent options.

7. Select one of the following actions:

- To cancel the programming, press the (CANCEL) key. Select “1 YES” in the “ARE YOU SURE ?” window.
- To finalize the programming, press the (CA/AT) key, then press the (CANCEL) key. You will return to the “DEPARTMENT” window.
- To program the following department, press the (NEXT RECORD) key. The “02” window will appear. To return to the “01” window, press the (PREV. RECORD) key.

The following sections describe how to preset each item for programming.

Article Programming

Use the following procedure to select any option included in the article programming group.

Procedure

SETTING	↓ P UP ▲	CAN	·	CL
01 ARTICLE				
02 DIRECT KEY		7	8	9
03 PLU MENU KEY				
04 FUNCTION		4	5	6
05 MEDIA				
06 TEXT				
07 PERSONNEL		1	2	3
08 TERMINAL				
PREV. NEXT LIST P DOWN ▼		0	00	ENTR

PGM2 MIKE 0001
11 07AM

(ENTER) ↓ ↑ (CANCEL)

ARTICLE	↓ P UP ▲	CAN	·	CL
01 DEPARTMENT				
02 PLU/UPC		7	8	9
03 DYNAMIC UPC				
04 PLU RANGE		4	5	6
05 PLU STOCK				
06 LINK PLU TABLE		1	2	3
07 CONDIMENT TABLE				
08 MIX&MATCH				
PREV. NEXT LIST P DOWN ▼		0	00	ENTR

PGM2 MIKE 0001
11 07AM

(PAGE DOWN) ↓ ↑ (PAGE UP)

ARTICLE	↑ P UP ▲	CAN	·	CL
05 PLU STOCK				
06 LINK PLU TABLE		7	8	9
07 CONDIMENT TABLE				
08 MIX&MATCH		4	5	6
09 COMBO MEAL				
10 SCALE TABLE		1	2	3
11 UPC NON-PLU				
12 UPC DELETE				
PREV. NEXT LIST P DOWN ▼		0	00	ENTR

PGM2 MIKE 0001
11:21AM

1. In the SETTING window, select "01 ARTICLE."
" The ARTICLE window will appear.

2. Select any option from the following options list:

1 DEPARTMENT:	Departments
2 PLU/UPC:	PLUs/UPCs
3 DYNAMIC UPC:	Dynamic UPC
4 PLU RANGE:	A range of PLUs
5 PLU STOCK:	PLU/UPC stock quantity
6 LINK PLU TABLE:	Link PLU table
7 CONDIMENT TABLE:	Condiment table
8 MIX&MATCH:	Mix & match table
9 COMBO MEAL:	Combo meal table
10 SCALE TABLE:	Scale table
11 UPC NON-PLU:	UPC non-PLU type code format
12 UPC DELETE:	UPC record delete period

The following illustration shows the article programming option groups.

1 ARTICLE	1 DEPARTMENT	→ See "Department" on page 125.
	2 PLU/UPC	→ See "PLU/UPC" on page 127.
	3 DYNAMIC UPC	→ See "Dynamic UPC" on page 130.
	4 PLU RANGE	→ See "PLU range" on page 130.
	5 PLU STOCK	→ See "PLU/UPC stock" on page 131.
	6 LINK PLU TABLE	→ See "Link PLU table" on page 132.
	7 CONDIMENT TABLE	→ See "Condiment table" on page 133.
	8 MIX&MATCH	→ See "Mix & Match table" on page 135.
	9 COMBO MEAL	→ See "Combo meal table" on page 136.
	10 SCALE TABLE	→ See "Scale table" on page 137.
	11 UPC NON-PLU	→ See "UPC Non-PLU code format" on page 138.
	12 UPC DELETE	→ See "UPC delete" on page 139.

■ Department

Your POS terminal machine is equipped with 10 standard departments, and can be equipped with a maximum of 99 departments.

Use the following procedure to program for departments.

Select the desired dept. code from the departments list.

02	↓	P UP ▲	CAN	CEL	.	CL
PRICE					0.00	
SIGN						
DESCRIPTION	DPT. 02					
ITEM VP	NON-COMPULSORY					
TARE No.	0					
SCALE						
SIF/SICS	INHIBIT					
DEPT. TYPE	NORMAL					
PREV. NEXT LIST P DOWN ▼					00	ENTR
PGH2 MIKE						0001
						11:22AM

02	↑↓	P UP ▲	CAN	CEL	.	CL
ENTRY TYPE						
TAXABLE 1	OPEN					
TAXABLE 2	YES					
TAXABLE 3	NO					
TAXABLE 4	NO					
TAXABLE 5	NO					
FS/CASH BWF	NO					
GROUP DISCOUNT1	NO					
PREV. NEXT LIST P DOWN ▼					00	ENTR
PGH2 MIKE						0001
						11:23AM

The screen continues.

Program each item as follows:

NOTE For more information about the entry methods patterns, see the "Basic Procedure Instructions" section.

- **PRICE (Use the numeric entry method)**

Unit price (max. 6 digits)

NOTE When the zero-value department entry (unit price "0") is made, text of the department is only displayed/printed.

- **SIGN (Use the selective entry method)**

+ : Assigns a plus sign to departments for normal sales transactions.

- : Assigns a minus sign for minus transactions.

- **DESCRIPTION <Default for dept.1> (Use the character entry method)**

DESCRIPTION : Description for a department. Up to 8 or 16 characters can be entered.

- **ITEM VP (Use the selective entry method)**

NON-COMPULSORY : Makes item validation printing compulsory.

COMPULSORY : Makes item validation printing noncompulsory.

- **TARE No. (Use the numeric entry method)**

Tare table number associated with scale entry (1 thru 9).

- **SCALE (Use the selective entry method)**

INHIBIT : Inhibits a scale entry function.

ENABLE : Enables a scale entry function.

COMPULSORY : Makes a scale entry compulsory.

- **SIF/SICS (Use the selective entry method)**

Department type selection

NORMAL : Department other than SIF or SICS department

SICS : SICS department

SIF : SIF department

- **DEPT. TYPE (Use the selective entry method)**

Department type selection

NORMAL : Normal department

HASH : Hash department

BR : Bottle return department

GAS : Gas department

GIFT : Sale by Gift Card

GIFT RELOAD : Gift Card reloading

• A hash department is used to enter the amount of a special "sale," such as a gift certificate, etc. Any amounts entered in this department are not added to the grand total exclusive of tax amounts.

- **ENTRY TYPE (Use the selective entry method)**

Type of unit price entry for departments

OPEN : Open price only

PRESET : Preset price only

OPEN & PRESET : Open price and preset price

INHIBIT : Inhibited

■ Department (continued)

• TAXABLE 1 thru 5 (Use the selective entry method)

Tax status

NO : Non-taxable

YES : Taxable

- When an entry of a taxable department is made in a transaction, tax is automatically computed according to the associated tax table or rate.

• FS/CASH BNF (Use the selective entry method)

Food stamp/cash benefit status

NO : Food stamp/cash benefit ineligible

YES : Food stamp/cash benefit eligible

• GROUP DISCOUNT 1 thru 3 (Use the selective entry method)

Group discount status

NO : Non-discountable

YES : Discountable

• HALO (Use the numeric entry method)

- You can set an upper limit amount (HALO) for each department. The limit is effective for the REGmode operations and the manager can override it.

- AB is the same as $A \times 10B$

A: Significant digit for HALO (1 thru 9)

B: Number of zeros to follow the significant digit for HALO (0 thru 7)

• LALO (Use the numeric entry method)

- You can set a lower limit amount (LALO). The limit is effective for the REG-mode operations and the manager can override it.

- AB is the same as $A \times 10B$

A: Significant digit for LALO (1 thru 9)

B: Number of zeros to follow the significant digit for LALO (0 thru 7)

• AGE LIMITATION (Use the numeric entry method)

Age limitation (0 thru 99)

When a department for which a figure other than zero (01 to 99) has been programmed as the age limitation is entered, the birthday entry must be completed.

• SERVER GROUP No. (Use the numeric entry method)

Server group number (0 thru 9)

Every department can be assigned to any of the server groups. The sales total of each department group is printed on the server report.

• GROUP No. (Use the numeric entry method)

Group number (0 thru 9)

You can assign departments to a maximum of nine groups. This programming enables you to take group sales reports.

• MODIFY OUTPUT (Use the selective entry method)

NO : Disables output to network remote printers.

YES : Enables output to network remote printers. Modified to follow a previous item.

• OUTPUT KP No. 1 thru 3 (Use the numeric entry method)

ID number of the network remote printer 1, 2 or 3 (1 thru 9)

If the number "0" is entered, no remote printer will operate.

• CHIT RECEIPT (Use the selective entry method)

YES : Prints the department sales information on the chit receipt in the remote printer format.

NO : Prints nothing on the chit receipt.

• CVM CTRL CHAR. (Use the numeric entry method)

CVM (Color Video Monitor) control character (0 thru 255)

- This programming enables you to assign a number as a CVM control character to each department. This number is converted to a two-digit character code that is transmitted for use with a CVM device.

• DOUGHNUT EXEMPT (Use the selective entry method)

YES : Enables the doughnut tax exemption (Canadian tax system).

NO : Disables the doughnut tax exemption.

• DATA ENT. JOB# (Use the numeric entry method)

Key data entry job number (Capture job number: 0 thru 99)

When "0" is programmed, data entry is inhibited.

PLU/UPC

- NOTE**
- In this manual, the word *UPC* represents *UPC (Universal Product Code)* and the word *EAN* represents *EAN (European Article Number)*.
 - With regard to the *UPC* codes available to this *POS* terminal, please refer to Chapter 14.

Procedure

Select the desired PLU code from the PLUs list, or directly enter a PLU/UPC code.

↓

00001	↓	P UP ▲	CAN	CEL	.	CL
PRICE 1		0.00				
NAME1	PL00001		7	8	9	
KP TEXT1	PL00001		4	5	6	
TOUCH KEY TEXT	00001		1	2	3	
DEPT. CODE	01		0	00	ENTR	
SIGN	+					
ENTRY TYPE	PRESET					
BASE QTY	0					
PREV. NEXT LIST P DOWN ▼						
PGM2 MIKE						0001 11:25AM

↓

00001	↑↓	P UP ▲	CAN	CEL	.	CL
MINIMUM STOCK		0				
PRICE SHIFT	ENABLE		7	8	9	
ZERO OF PRICE1	ALLOWED		4	5	6	
COUPON OBJECT	00000		1	2	3	
MENU TYPE	NORMAL		0	00	ENTR	
LINK TBL#	00					
MIX&MATCH TBL#	00					
CONDIMENT TBL#	00					
PREV. NEXT LIST P DOWN ▼						
PGM2 MIKE						0001 11:26AM

↓

00001	↑↓	P UP ▲	CAN	CEL	.	CL
TARE TBL#		0				
CONDIMENT TYPE	NO		7	8	9	
CONDIMENT	NON-COMPULSORY		4	5	6	
AUTO COMBO OBJECT	NO		1	2	3	
AUTO COMBO No.	00		0	00	ENTR	
AUTO COMBO No.	00					
AUTO COMBO No.	00					
AUTO COMBO No.	00					
PREV. NEXT LIST P DOWN ▼						
PGM2 MIKE						0001 11:27AM

↓

Program each item as follows:

- *PRICE 1 thru 6 (Use the numeric entry method)**
Unit price of each price level (max. 6 digits).
- *NAME*1# thru 6 (Use the character entry method)**
Description for a PLU/UPC (for each price level). Up to 8 or 16 characters can be entered.
- *KP TEXT 1 thru 6 (Use the character entry method)**
Description of text for kitchen printer for each price level. Up to 12 characters can be entered.
- *TOUCH KEY TEXT (Use the character entry method)**
Description for a PLU touch key. Up to 12 characters can be entered.
- *DEPT.CODE (Use the numeric entry method)**
Department code to be associated with the entered PLU/UPC (01 through 99)
When a PLU/UPC is associated with a department, the following functions of the PLU/UPC depend on the programming for the department.
 - Item validation print compulsory/non-compulsory
 - Single item cash sale/single item finalize
- *SIGN (Use the selective entry method)**
+ : Plus PLU/UPC
- : Minus PLU/UPC
The function of every PLU/UPC varies according to the combination of its sign and the sign of its associated department as follows:
 Department: + Serves as a normal plus PLU/UPC
 PLU/UPC: +
 Department: - Serves as a normal minus PLU/UPC
 PLU/UPC: -
 Department: + Accepts store coupon entries, but not split-pricing entries.
 PLU/UPC: -
 Department: - Not valid; not accepted
 PLU/UPC: +

NOTE * On the sample screen, the price level 1 setting only is shown. Depending on the default settings, you may see the price level 1 through 6 settings on the screen. Please consult your authorized SHARP dealer for more details.

■ PLU/UPC (continued)

00001	↑↓	P	UP	▲	CAN	CEL	.	CL
AUTO COMBO No.				00				
SCALE				INHIBIT	7	8	9	
TAXABLE 1				YES				
TAXABLE 2				NO	4	5	6	
TAXABLE 3				NO				
TAXABLE 4				NO	1	2	3	
TAXABLE 5				NO				
FS/CASH BNF				NO	0	00	ENTR	
PREV.	NEXT	LIST	P	DOWN				
PGM2	HIKE							0001 11:27AM

00001	↑↓	P	UP	▲	CAN	CEL	.	CL
GROUP DISCOUNT1				NO				
GROUP DISCOUNT2				NO	7	8	9	
GROUP DISCOUNT3				NO				
AGE LIMITATION				00	4	5	6	
GROUP1				00				
GROUP2				00	1	2	3	
GROUP3				00				
PRIORITY GROUP				0	0	00	ENTR	
PREV.	NEXT	LIST	P	DOWN				
PGM2	HIKE							0001 11:27AM

00001	↑↓	P	UP	▲	CAN	CEL	.	CL
MODIFY OUTPUT				NO				
OUTPUT KP No.1				0	7	8	9	
OUTPUT KP No.2				0				
OUTPUT KP No.3				0	4	5	6	
CHIT RECEIPT				NO				
CVM CTRL CHAR.				000	1	2	3	
REPEAT ROUND				NO				
DOUGHNUT EXEMPT				NO	0	00	ENTR	
PREV.	NEXT	LIST	P	DOWN				
PGM2	HIKE							0001 11:28AM

00001	↑	P	UP	▲	CAN	CEL	.	CL
OUTPUT KP No.2				0				
OUTPUT KP No.3				0	7	8	9	
CHIT RECEIPT				NO				
CVM CTRL CHAR.				000	4	5	6	
REPEAT ROUND				NO				
DOUGHNUT EXEMPT				NO	1	2	3	
DATA ENT. JOB#				00				
NON-ACCESS				NON DEL.	0	00	ENTR	
PREV.	NEXT	LIST	P	DOWN				
PGM2	HIKE							0001 11:28AM

• ENTRY TYPE (Use the selective entry method)

Mode parameter

- PRESET : Preset price only
- OPEN & PRESET : Open price and preset price
- INHIBIT : Inhibited
- OPEN : Open price only

NOTE For UPC, it is fixed to PRESET .

• BASE QTY (Use the numeric entry method)

Base quantity for each PLU/UPC which is counted each time the item is entered. (max. 2 digits)

• MINIMUM STOCK (Use the numeric entry method)

Minimum stock quantity for a PLU (max. 7 digits)

• PRICE SHIFT (Use the selective entry method)

- ENABLE : Enables PLU/UPC price level shift.
- INHIBIT : Inhibits PLU/UPC price level shift.
- COMPULSORY : Makes PLU/UPC price level shift compulsory.

NOTE When COMPULSORY is selected for a PLU/UPC, repeat entries of the PLU/UPC are inhibited.

• *ZERO OF P1 thru 6 (Use the selective entry method)

- ALLOWED : Allows a zero-price entry.
- INHIBIT : Inhibits a zero-price entry.

• COUPON OBJECT (Use the numeric entry method)

Select an object PLU code (max. 5 digits).
A coupon-like PLU is able to link to another PLU (object PLU).
By this programming, the associated coupon PLU cannot be entered unless the object PLU has been rung up.
(However, the quantity is not affected.)

NOTE

- Any object PLU should not be programmed as a minus PLU or belong to any minus department.

• MENU TYPE (Use the selective entry method)

- PLU menu type selection
- NORMAL : Normal PLU/UPC
- LINK : Link PLU/UPC

• LINK TBL# (Use the numeric entry method)

Table number for link PLUs (1 thru 99)

• MIX&MATCH TBL# (Use the numeric entry method)

Table number for mix and match (1 thru 99)

• CONDIMENT TBL# (Use the numeric entry method)

Table number for condiment entry (1 thru 99)

NOTE For UPC, it is fixed to "00".

■ PLU/UPC (continued)

- **TARE TBL# (Use the numeric entry method)**

Tare table number associated with scale entry (1 thru 9)

- **CONDIMENT TYPE (Use the selective entry method)**

TIED : Condiment type

NO : Non-condiment type

NOTE For UPC, it is fixed to "NO".

- **CONDIMENT (Use the selective entry method)**

NON-COMPULSORY : Makes a condiment entry non-compulsory.

COMPULSORY : Makes a condiment entry compulsory.

NOTE For UPC, it is fixed to "NON-COMPULSORY."

- **AUTO COMBO OBJECT (Use the selective entry method)**

YES : Makes the PLU an AUTO COMBO object.

NO : Does not make the PLU/UPC an AUTO COMBO object.

NOTE For UPC, it is fixed to "NO."

- **AUTO COMBO No. (Use the numeric entry method)**

Auto Combo number (1 to 99)

If the number 0 is entered, the PLU is not an object of the AUTO COMBO.

NOTE For UPC, it is fixed to "0."

- **SCALE (Use the selective entry method)**

INHIBIT : Inhibits a scale entry.

ENABLE : Enables a scale entry.

COMPULSORY : Makes a scale entry compulsory.

- **TAXABLE 1 thru 5 (Use the selective entry method)**

YES : Makes the PLU/UPC taxable.

NO : Makes the PLU/UPC non-taxable.

- **FS/CASH BNF (Use the selective entry method)**

Food stamp/cash benefit status

NO : Food stamp/cash benefit ineligible

YES : Food stamp/cash benefit eligible

- **GROUP DISCOUNT 1 thru 3 (Use the selective entry method)**

Group discount status

NO : Non-discountable

YES : Discountable

- **AGE LIMITATION (Use the numeric entry method)**

Age limitation (0 thru 99)

When a PLU/UPC for which a figure other than zero (01 to 99) has been programmed as the age limitation, the birthday entry must be completed.

- **GROUP 1 thru 3 (Use the numeric entry method)**

PLU group number (00 thru 99)

- **PRIORITY GROUP (Use the numeric entry method)**

PLU group which is to be given the highest priority to in printing on the remote printer (1 thru 9)

- **MODIFY OUTPUT (Use the selective entry method)**

YES : Will follow previous PLUs which has the remote printer assignment.

NO : Will not follow previous PLUs which has the remote printer assignment.

- **OUTPUT KP No.1 thru 3 (Use the numeric entry method)**

ID number of the network remote printer 1, 2 or 3 (1 thru 9)

If the number 0 is entered, no remote printer will operate.

- **CHIT RECEIPT (Use the selective entry method)**

NO : Prints nothing on the chit receipt.

YES : Prints the PLU sales information on the chit receipt in the remote printer format.

- **CVM CTRL CHAR. (Use the numeric entry method)**

CVM (Color Video Monitor) control character (0 thru 255)

■ PLU/UPC (continued)

- **REPEAT ROUND (Use the selective entry method)**

- NO : Inhibits repeat round registration
- YES : Allows repeat round registration

- **DOUGHNUT EXEMPT (Use the selective entry method)**

- YES : Enables the doughnut tax exemption (Canadian tax system).
- NO : Disables the doughnut tax exemption.

- **DATA ENT. JOB# (Use the numeric entry method)**

- Key data entry job number (Capture job number: 0 thru 99)
- When 0 is programmed, data entry is inhibited.

- **NON-ACCESS (Use the selective entry method)**

- NON DEL : Not delete non-accessed UPCs by Z1 report.
- DEL. BY Z : Delete non-accessed UPCs by Z1 report.

NOTE For PLU, it is fixed to "NON DEL."

■ Dynamic UPC

NOTE For the UPC codes available to this POS terminal and type UPC files, please refer to the Chapter 14.

After you select 3 DYNAMIC UPC on the ARTICLE menu, enter an UPC code or select a pertinent code. The same items (except MIN. STOCK) as the PLU/UPC described in the previous section will appear. Please refer to the PLU/UPC section for entering values or selecting options. The data will be saved in the Dynamic UPC file.

■ PLU range

You can program the PLUs by a range as follows:

Procedure

PLU RANGE	P	UP	▲	CAN	CEL	·	CL
START CODE		00000					
END CODE		00000		7	8	9	
OPERATION		MAINTE.		4	5	6	
				1	2	3	
				0	00	ENTR	
PREV.	NEXT	LIST	P	DOWN	▼		
PGM2	MIKE						0001
							11:29AM



00001-00020	P	UP	▲	CAN	CEL	·	CL
PRICE 1		0.00					
NAME1				7	8	9	
KP TEXT1				4	5	6	
TOUCH KEY TEXT				1	2	3	
DEPT. CODE				0	00	ENTR	
SIGN							
ENTRY TYPE							
BASE QTY							
PREV.	NEXT	LIST	P	DOWN	▼		
PGM2	MIKE						0001
							11:30AM

Enter a value or select an option for each item as follows:

- **START CODE (Use the numeric entry method)**

Starting PLU code (max. 5 digits)

- **END CODE (Use the numeric entry method)**

Ending PLU code (max. 5 digits)

- **OPERATION (Use the selective entry method)**

MAINTE : Enables you to change the setting you have programmed.

NEW&MAINTE : Enables you to change the current setting when the specified codes have already been created or to create new codes when the specified codes have not been created yet.

DELETE : Enables you to delete a specified range of PLUs.

The screen is continues in the same format as screens shown in section "■ PLU/UPC"

■ PLU/UPC stock

You can assign a stock quantity to each PLU/UPC code.
Shown below is an example of selecting 1 OVER WRITE.

Procedure

PLU STOCK		P UP ▲	CAN	.	CL
1	OVER WRITE		CEL		
2	ADD		7	8	9
3	SUB		4	5	6
			1	2	3
			0	00	ENTR
PREV.	NEXT	LIST	P DOWN ▼		
PGH2	MIKE				0001
					4:45PM



Select the desired PLU code from the PLUs list, or directly enter a PLU/UPC code.



00001		P UP ▲	CAN	.	CL
CURRENT			CEL		
NEW STOCK		0.000	7	8	9
		0.000	4	5	6
			1	2	3
			0	00	ENTR
PREV.	NEXT	LIST	P DOWN ▼		
PGH2	MIKE				0001
					4:46PM

After selecting “1 OVER WRITE,” select a pertinent PLU/UPC code. Then the next screen will appear to show the following items:

- **CURRENT**

The current stock is displayed.

- **NEW STOCK (Use the numeric entry method)**

Enter a new stock quantity (max. 7 digits: 1 to 9999.999)

NOTE

- *If you need to add (or subtract) a stock quantity to (or from) the current stock quantity, select 2 ADD (or 3 SUB) and enter a value to be added or subtracted.*
- *The entry of a new stock value will update to the PLU/UPC stock counter.*

■ Link PLU table (for PLU/UPC)

It is possible to link PLUs (linked PLUs) with a PLU or UPC (link PLU/UPC) so that with a single key depression of the link PLU/UPC key. However, the maximum number of links is five. Even if more than five PLUs are linked, the sixth or higher link is invalid. not actualized.

Procedure

LINK PLU TABLE		P UP ▲	CAN	.	CL
---		CEL			
---NOTHING---		7	8	9	
		4	5	6	
		1	2	3	
		0	00	ENTR	
PREV.	NEXT	LIST	P DOWN ▼		
PGM2	MIKE			0001	11:34AM

Program each item as follows:

- **LINK PLU TABLE (Use the numeric entry method)**

Link PLU table number (1 thru 99)

- **LINKED PLU#1 thru 5 (5 PLUs. max.)**

Select linked PLUs (max. 5 PLUs) from the list.

NOTE

- PLU codes should be defined before programming a link PLU table.
- If the (DEL) key is pressed on the table number selection menu, the selected table will be deleted.

Selected link
PLU table no.

→ (ENTER)

01		P UP ▲	CAN	.	CL
		CEL			
LINKED PLU#1	00000				
LINKED PLU#2	00000	7	8	9	
LINKED PLU#3	00000	4	5	6	
LINKED PLU#4	00000	1	2	3	
LINKED PLU#5	00000	0	00	ENTR	
PREV.	NEXT	LIST	P DOWN ▼		
PGM2	MIKE			0001	11:34AM

■ Condiment table

The condiment entry is intended to assist the operator in making menu entries which require special cooking instructions. For example, a server can make such entries as a garnish of potato, with salad, and steak doneness. When a server enters a menu-item PLU to which PLUs for the condiment entry have been assigned, these orders (such as a garnish of potato) will be printed on the receipt and conveyed to the kitchen.

Before programming for the condiment entry, prepare a condiment table. The following shows an example of a condiment table:

Condiment tables

Table number	PLU codes for condiment entry (programmed text)					
01	Message text (HOW COOK?)	23 (RARE)	25 (MED.RARE)	27 (WELLDONE)	02
02	Message text (WITH?)	44 (SALAD)	45 (FRUITS)		
.....
04	Message text (POTATO?)	33 (P.CHIPS)	37 (MASHEDP.)	38 (BAKEDP.)	99
99	Message text (DRINK?)	63 (TEA)	65 (MILK)	67 (A..JUICE)	/

Condiment tables (Up to 99)

PLUs (Up to 28 for a table)
Next condiment table number

The condiment PLU programmed in a condiment table can be linked with another condiment table.

For Example, if condiment PLU 44 (SALAD) is linked with condiment table 10 (SAUCE) as shown below, choices of condiment table 10 will appear when PLU 44 (SALAD) is entered.

Table number	PLU codes for condiment entry (programmed text)				
10	Message text (SAUCE)	51 (ITALIAN)	53 (FRENCH)	12

Next condiment table number

The condiment table should contain the following:

Condiment table: The condiment table is a group of condiment PLUs, which is assigned to each menu item PLU. A table consists of a message text and up to 28 PLUs. You can assign the next condiment table number to a condiment table to link them.

The message text is used for displaying a prompting message. The PLU is used for the special order setting. For example, when a server enters a menu-item PLU, a message text such as "HOWCOOK?" will appear. Then specify one of the PLUs programmed for the text, such as "RARE."

Table number: The table number is intended to identify each condiment table.

Procedure

CONDIMENT TABLE		P UP ▲	CAN CEL	.	CL
---NOTHING---					
			7	8	9
			4	5	6
			1	2	3
			0	00	ENTR
PREV.	NEXT	LIST P DOWN ▼			
PGM2	MIKE		0001		
11:35AM					

Selected condiment table number → (ENTER)

CONDIMENT TABLE		P UP ▲	CAN CEL	.	CL
01	TEXT				
	REPEAT TIMES	1			
	NEXT TABLE#	00	7	8	9
	PLU#01	00000	4	5	6
	PLU#02	00000			
	PLU#03	00000	1	2	3
	PLU#04	00000			
	PLU#05	00000	0	00	ENTR
PREV.	NEXT	LIST P DOWN ▼			
PGM2	MIKE		0001		
11:36AM					

The screen continues.

Program each item as follows:

- CONDIMENT TABLE. (Use the numeric entry method)**
 Condiment table number (1 thru 99)
- REPEAT TIMES (Use the numeric entry method)**
 Repeat times (1 thru 9)
 When the REPEAT TIMES (2 thru 9) is programmed, the table is shown repeatedly as many times as programmed, then the next table will be shown.
- NEXT TABLE# (Use the numeric entry method)**
 Enter the next condiment table number (max. 2 digits).
- PLU#1-28 (Use the numeric key)**
 Select condiment PLUs contained in the table (max. 28 PLUs) from the list.

NOTE

- The description of the first PLU is used as the display prompt.
- PLU codes should be defined before programming a condiment table.
- If the (DEL) key is pressed on the table number selection menu, the table in the cursor position will be deleted.

Mix & Match table

Procedure

MIX&MATCH		P UP ▲	CAN	.	CL
---NOTHING---			CEL		
			7	8	9
			4	5	6
			1	2	3
			0	00	ENTR
PREV.	NEXT	LIST	P DOWN ▼		
PGH2	MIKE				0001
11:36AM					

Selected
mix & match
table number

→ (ENTER)

01		P UP ▲	CAN	.	CL
TEXT			CEL		
BASE QTY			0	7	8
PRICE		0.00	4	5	6
			1	2	3
			0	00	ENTR
PREV.	NEXT	LIST	P DOWN ▼		
PGH2	MIKE				0001
11:37AM					

Program each item as follows:

- **MIX&MATCH (Use the numeric entry method)**
Mix & match table number (1 thru 99)
- **TEXT (Use the character entry method)**
Description for the promotion (Mix and match)
- **BASE QTY (Use the numeric entry method)**
Base quantity for each mix & match table (max. 2 digits)
- **PRICE (Use the numeric entry method)**
Unit price for each mix & match table (max. 7 digits)

NOTE

- If the (DEL) key is pressed on the table number selection menu, the table in the cursor position will be deleted.

Programming examples

(For the examples on page 44)

Example 1 (for a certain PLU)

In addition to assignment of Mix-and-match table 01 to PLU 39, proceed programming as follows:

MIX&MATCH table no.: 1
 TEXT: PROMOTION
 BASE QTY: 3
 PRICE: \$5.00

Example 2 (for three PLU)

In addition to assignment of Mix-and-match table 02 to PLUs 40, 41, and 42, proceed programming as follows:

MIX&MATCH table no.: 2
 TEXT: VALUE SET
 BASE QTY: 3
 PRICE: \$6.90

■ Combo meal table

When two or more menu items, consisting of PLUs related to a special offering, are to be programmed together, the combo meal function should be used. Up to 20 combo keys (tables) can be programmed. Each combo key can be associated with 9 PLUs (items).

Procedure

COMBO MEAL		P UP	▲	CAN	CEL	.	CL
---NOTHING---							
				7	8	9	
				4	5	6	
				1	2	3	
				0	00	ENTR	
PREV.	NEXT	LIST	P DOWN ▼				
PGM2	MIKE			0001			
				11	38AM		

Selected combo table no. →

01		↓	P UP	▲	CAN	CEL	.	CL
TEXT					7	8	9	
KP TEXT								
CONDIMENT TABLE#	00			4	5	6		
CONDIMENT	NON-COMPULSORY			0				
PRIORITY GROUP				1	2	3		
MODIFY OUTPUT	NO			0	00	ENTR		
OUTPUT KP No.1	0							
OUTPUT KP No.2	0							
PREV.	NEXT	LIST	P DOWN ▼					
PGM2	MIKE			0001				
				11	39AM			

01		↑	P UP	▲	CAN	CEL	.	CL
OUTPUT KP No.3	0			7	8	9		
CHIT RECEIPT	NO							
CVM CTRL CHAR.	000			4	5	6		
DATA ENT. JOB#	00			1	2	3		
COMBO PLU#1	00000			0	00	ENTR		
PRICE1	0.00							
PRICE2	0.00							
COMBO PLU#2	00000							
PREV.	NEXT	LIST	P DOWN ▼					
PGM2	MIKE			0001				
				11	39AM			

Program each item as follows

- **COMBO MEAL (Use the numeric entry method)**
Combo meal table number (1 thru 20)
- **Combo title (Use the character entry method)**
Title of each combo meal table (max. 16 characters).
- **KP TEXT (Use the character entry method)**
Description of the kitchen printer for a combo key.
Up to 12 characters can be entered.
- **CONDIMENT TABLE (Use the numeric entry method)**
Table number for condiment entry (1 thru 99)
- **CONDIMENT (Use the selective entry method)**
COMPULSORY: Makes a condiment entry compulsory.
NON-COMPULSORY: Makes a condiment entry non-compulsory.
- **PRIORITY GROUP (Use the numeric entry method)**
Combo group which is to be given the highest priority to in printing on the remote printer (1 thru 9).
- **MODIFY OUTPUT (Use the selective entry method)**
NO : Will not follow previous PLUs which has the remote printer assignment.
YES : Will follow previous PLUs which has the remote printer assignment.
- **OUTPUT KP No.1 thru 3 (Use the numeric entry method)**
ID number of the network remote printer 1, 2 or 3 (1 thru 9).
If the number "0" is entered, no remote printer will operate.
- **CHIT RECEIPT (Use the selective entry method)**
YES : Prints the combo sales information on the chit receipt in the remote printer format.
NO : Prints nothing on the chit receipt.
- **CVM CTRL CHAR. (Use the numeric entry method)**
CVM (Color Video Monitor) control character (0 thru 255)
- **DATA ENT. JOB# (Use the numeric entry method)**
Key data entry job number (Capture job number: 0 thru 99)
When "0" is programmed, the data capture entry is inhibited.

■ Combo meal table (continued)

01		↑↓	P UP ▲	CAN	CEL	.	CL
PRICE1			0.00				
PRICE2			0.00	7	8	9	
COMBO PLU#3			00000	4	5	6	
PRICE1			0.00	1	2	3	
PRICE2			0.00	0	00	ENTR	
COMBO PLU#4			00000				
PRICE1			0.00				
PRICE2			0.00				
PREV.	NEXT	LIST	P DOWN ▼				
PGH2	MIKE						0001 11:39AM

- **COMBO PLU#1-9 (Use the numeric entry method)**
Select associated PLUs (max. 9 PLUs) from the list.
- **PRICE1 (Use the numeric entry method)**
Unit price of each associated PLU (max. 6 digits).
- **PRICE2 (Use the numeric entry method)**
2nd unit price (for Upsize function) of each associated PLU (max. 6 digits).

NOTE

- The PRICE1 is selected by the combo meal entry. When the **UPSIZ** key is pressed after the combo meal entry, the entry of PRICE1 is voided and a new entry of PRICE2 is registered.
- PLU codes should be defined before programming a combo meal table.
- If the **(DEL)** key is pressed on the table number selection menu, the programmed data in the cursor position will be deleted.

■ Scale table

The POS terminal can be programmed with up to nine tare tables and allows different tares to be assigned to scalable items (for auto scale entries).

Procedure

SCALE TABLE		↑↓	P UP ▲	CAN	CEL	.	CL
1							
2				7	8	9	
3				4	5	6	
4				1	2	3	
5				0	00	ENTR	
6							
7							
8							
PREV.	NEXT	LIST	P DOWN ▼				
PGH2	MIKE						0001 11:40AM

Program each item as follows:

- **SCALE TABLE (Use the numeric entry method)**
Tare table number (1 thru 9)
- **WEIGHT (Use the numeric entry method)**
Enter a tare weight for the scale table number (max. 4 digits: 1 to 99.99 lbs.).

NOTE

Your POS terminal may also be set to accommodate 1-integer + 3decimal weights. For more details, please consult your authorized SHARP dealer.

Selected tare table number → **(ENTER)**

1		P UP ▲	CAN	CEL	.	CL
WEIGHT		010				
			7	8	9	
			4	5	6	
			1	2	3	
			0	00	ENTR	
PREV.	NEXT	LIST	P DOWN ▼			
PGH2	MIKE					0001 11:41AM

■ UPC Non-PLU code format

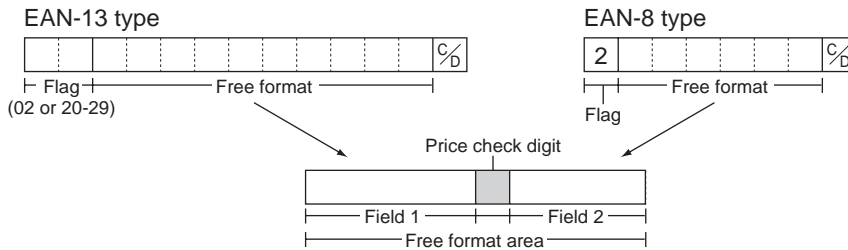

Procedure

Select an arbitrary number, or the desired UPC TYPE OF CODE & SYSTEM CODE you set.



03	P UP ▲	CAN	CEL	.	CL
TYPE OF CODE	EAN13				
SYSTEM CODE	00	7	8	9	
LENGTH FIELD#1	0				
LENGTH FIELD#2	0	4	5	6	
FIELD#2 DATA	PRICE				
PRICE C/D	NO	1	2	3	
TAB	0				
PREV.	NEXT	LIST	P DOWN ▼		
PGH2	MIKE			0001	
				11	43AH

Program each item as follows:

- **TYPE OF CODE (Use the selective entry method)**
EAN-8: EAN-8 format code (consists of 8 digits)
EAN-13 (UPC-A): EAN-13 format code (consists of 13 digits)
- **SYSTEM CODE (Use the numeric entry method)**
System code (i.e. flag code): EAN-8: 1 digit, EAN-13: 2 digits

NOTE

ISBN/ISSN and press codes are always used the fixed format even if code, 37, 43, 78, 98, or 97 is entered.

- **LENGTH FIELD#1 (Use the numeric entry method)**
Length of field 1 (number of digits): 0 to 9
- **LENGTH FIELD#2 (Use the numeric entry method)**
Length of field 2 (number of digits): 0 to 9
- **FIELD#2 DATA (Use the selective entry method)**
Meaning of field 2
QUANTITY : Quantity
PRICE : Price
- **PRICE C/D (Use the selective entry method)**
Price check digit
YES : Use the price check digit
NO : Not use the price check digit
- **TAB (Use the selective entry method)**
TAB or decimal point of field: 3/2/1/0

■ UPC delete

When you execute the delete job (UPC DELETE) in the X1 mode, you can delete the UPC codes which have not been accessed during the period you set in this program when you execute the delete job while in UPC DELETE in the X1 mode.

Procedure

Program each item as follows:

UPC DELETE	P UP ▲	CAN	.	CL
PERIOD(DAY)	99	CEL		
		7	8	9
		4	5	6
		1	2	3
		0	00	ENTR
PREV.	NEXT	LIST	P DOWN ▼	
PGM2	MIKE			0001
				11 43AM

- **PERIOD (DAY) (Use the numeric entry method)**

Enter the UPC record delete period: 01 to 99 (00: Not delete by the non-accessed deleting job)

Direct Key Programming

Use the following procedure to select direct-key programming:

■ Direct PLU/COMBO/Dept. key

You can assign PLUs, combo meals and departments directly to the keyboard. In the case of combo meals or PLUs, you may assign up to 5-levels to be accessed directly on the keyboard.

Procedure

SETTING	↓ P UP ▲	CAN	CEL	.	CL
01 ARTICLE					
02 DIRECT KEY		7	8	9	
03 PLU MENU KEY					
04 FUNCTION		4	5	6	
05 MEDIA					
06 TEXT		1	2	3	
07 PERSONNEL					
08 TERMINAL		0	00	ENTR	
PREV. NEXT LIST P DOWN ▼					
PGM2 HIKE					0001 11:44AM



Press the key on the keyboard you wish to program or select the desired key no. from the key numbers list (Refer to the next page).



020	P UP ▲	CAN	CEL	.	CL
TYPE	PLU				
		7	8	9	
		4	5	6	
		1	2	3	
		0	00	ENTR	
PREV. NEXT LIST P DOWN ▼					
PGM2 HIKE					0001 11:46AM



020	P UP ▲	CAN	CEL	.	CL
LEVEL1	00036				
LEVEL2	00000				
LEVEL3	00000	7	8	9	
LEVEL4	00000				
LEVEL5	00000	4	5	6	
		1	2	3	
		0	00	ENTR	
PREV. NEXT LIST P DOWN ▼					
PGM2 HIKE					0001 11:47AM

In the case of setting “00020 DIRECT PLU”

1. In the SETTING window, select “02 DIRECT KEY.”
 - The DIRECT KEY window will appear.

• TYPE (Use the selective entry method)

- PLU : Assigns the key as a direct PLU key.
- COMBO : Assigns the key as a direct combo key.
- DEPT : Assigns the key as a direct department key.

NOTE

- You can also select a direct PLU key by pressing the corresponding key when the PLU has been assigned directly on the keyboard instead of selecting the key from the menu.
- When selecting a department, the screen on which a department code is to be entered (the message “DEPT. CODE”) will appear.
- When selecting a combo, the screen on which a combo table number is to be entered (“COMBO TBL#”) will appear.

• LEVEL1 thru 5 (Use the numeric entry method)

- Enter a PLU number or combo table number for each level.
- For example, if you want to use this key as PLU code 1 (level 1) and PLU code 101 (level 2), enter 1 for the “LEVEL1” and 101 for the “LEVEL2.”

Key numbers

↑ RECEIPT	↑ JOURNAL	RCPT
@/FOR	•	CL
7	8	9
4	5	6
1	2	3
0	00	

PLU/UPC		AMT	INQ
5	10	15	20
4	9	14	19
3	8	13	18
2	7	12	17
1	6	11	16

PAGE UP	↑	PAGE DOWN	MODE	HOME
←	↓	→	CANCEL	ENTER
CASH #	VOID	RFND	AUTO	FUNC MENU
#/TM	FS TEND	FS SHIFT	CHK #	NEXT \$
RA	PO	NS	CH #	MDSE SBTL
PRICE CHANGE		CONV #	SBTL	CA/AT

Default keyboard: Departments, PLUs and combo meals programmable area

NOTE You cannot place a department, PLU or combo meal key where a function key has been previously programmed.
For more information, please consult your authorized SHARP dealer.

PLU Menu Key Programming

Use the following procedure for PLU menu key programming:

■ PLU menu key

When you enter PLUs, using the PLU menu key makes it easy to find categorized PLU items from the menu list. Your POS terminal allows you to program a max. of 50 PLU menu keys. You can program a max. of 15 PLUs/sub-menus for each PLU menu key.

Procedure

SETTING	P UP	▲	CAN	CEL	.	CL
01 ARTICLE			7	8	9	
02 DIRECT KEY			4	5	6	
03 PLU MENU KEY			1	2	3	
04 FUNCTION			0	00	ENTR	
05 MEDIA						
06 TEXT						
07 PERSONNEL						
08 TERMINAL						
PREV. NEXT LIST P DOWN ▼						

PGH2 12:54PM

PLU MENU KEY	P UP	▲	CAN	CEL	.	CL
01 PLU001			7	8	9	
02 PLU MENU02			4	5	6	
			1	2	3	
			0	00	ENTR	
PREV. NEXT LIST P DOWN ▼						

PGH2 12:55PM

Select a PLU menu key and press ENTER .
(or enter the corresponding key no.)

03	P UP	▲	CAN	CEL	.	CL
TEXT			7	8	9	
AFTER MENU ENTRY			4	5	6	
AUTO RETURN			1	2	3	
			0	00	ENTR	
PREV. NEXT LIST P DOWN ▼						

PGH2 12:56PM

03	P UP	▲	CAN	CEL	.	CL
01 INHIBIT			7	8	9	
02 INHIBIT			4	5	6	
03 INHIBIT			1	2	3	
04 INHIBIT			0	00	ENTR	
05 INHIBIT						
06 INHIBIT						
07 INHIBIT						
08 INHIBIT						
PREV. NEXT LIST P DOWN ▼						

PGH2 12:57PM

Use the following procedure to program a PLU menu key:

In the SETTING window, select “03 PLU MENU KEY” and program each item as follows:

- **PLU MENU KEY (Use the numeric entry method)**

PLU menu key number (1 thru 50)

1 thru 50: For the direct PLU menu key.

- **TEXT (Use the character entry method)**

Description for the PLU menu key. Up to 16 characters can be entered.

- **AFTER MENU ENTRY (Use the selective entry method)**

AUTO RETURN: The display returns to the home menu after menu entry.

STAY DOWN: The current window stays open after menu entry.

- **PLU or MENU (Use the selective entry method)**

Select a menu PLU or sub-menu from the list.

■ PLU menu key (continued)



01	P UP ▲	CAN	·	CL
TYPE	PLU	CEL		
		7	8	9
		4	5	6
		1	2	3
		0	00	ENTR
PREV. NEXT LIST P DOWN ▼				
PGM2				
				12:58PM

- **TYPE (Use the selective entry method)**

PLU : Selects to program a PLU.

MENU : Selects to program a sub-menu.

NOTE

When selecting a sub-menu, the screen on which a sub-menu number is to be entered (the message "MENU") will appear.

NOTE

- The PLU code should be defined before programming a PLU menu key.
- If the (DEL) key is pressed on the menu key number selection menu, the menu list will be canceled.
- If the (DEL) key is pressed on the menu PLU code selection menu, the menu in the cursor position will be deleted.

Functional Programming

Use the following procedure for functional programming group:

Procedure

SETTING	↓ P UP ▲	CAN	·	CL
01 ARTICLE		CEL		
02 DIRECT KEY		7	8	9
03 PLU MENU KEY				
04 FUNCTION		4	5	6
05 MEDIA				
06 TEXT		1	2	3
07 PERSONNEL				
08 TERMINAL		0	00	ENTR
PREV. NEXT LIST P DOWN ▼				
PGM2 MIKE				0001
				11 52AM



FUNCTION	↓ P UP ▲	CAN	·	CL
01 (-)		CEL		
02 %		7	8	9
03 GROUP DISC.%				
04 GAS DISCOUNT		4	5	6
05 GRATUITY				
06 TIP		1	2	3
07 RA				
08 PO		0	00	ENTR
PREV. NEXT LIST P DOWN ▼				
PGM2 MIKE				0001
				11 55AM

The screen continues.

1. In the SETTING window, select "04 FUNCTION."
• The FUNCTION window will appear.

2. Select any option from the following options list:

- | | |
|-----------------|---------------------|
| 1 (-): | Discount key |
| 2 %: | Percent key |
| 3 GROUP DISC.%: | Group discount |
| 4 GAS DISCOUNT: | Gas discount |
| 5 GRATUITY: | Gratuity |
| 6 TIP: | Tip |
| 7 RA: | Received on account |
| 8 PO: | Paid out |
| 9 MANUAL TAX: | Manual tax |
| 10 TAX DELETE: | Tax delete |
| 11 NO SALE: | No-sale |
| 12 VOID: | Void |
| 13 REFUND: | Refund |

The following illustration shows the functional programming options.

4 FUNCTION	1 (-)	➔ See "Discount key" on page 145.
	2 %	➔ See "Percent key" on page 146.
	3 GROUP DISC.%	➔ See "Group discount Key" on page 147.
	4 GAS DISCOUNT	➔ See "Gas discount " on page 148.
	5 GRATUITY	➔ See "Gratuity" on page 149.
	6 TIP	➔ See "Tip" on page 149.
	7 RA	➔ See "RA" on page 150.
	8 PO	➔ See "PO" on page 151.
	9 MANUAL TAX	➔ See "Manual tax" on page 151.
	10 TAX DELETE	➔ See "Tax delete" on page 152.
	11 NO SALE	➔ See "No sale" on page 152.
	12 VOID	➔ See "Void" on page 153.
	13 REFUND	➔ See "Refund" on page 153.

■ Discount key (thru)

Procedure

Select the desired discount key from the discount keys list.

↓

(-) 1		P UP	▲	CAN	CEL	.	CL
AMOUNT							
TEXT							
SIGN							
TAXABLE1		NO					
TAXABLE2		NO					
TAXABLE3		NO					
TAXABLE4		NO					
TAXABLE5		NO					
PREV.	NEXT	LIST	P DOWN				
PGH2	MIKE						
							0001
							11 56AM

↓

(-) 1		P UP	▲	CAN	CEL	.	CL
FS/CASH BNF		NO					
GROUP DISCOUNT1		NO					
GROUP DISCOUNT2		NO					
GROUP DISCOUNT3		NO					
HALO		17					
ENTRY TYPE		SBTL					
ENTRY IN REG		NO					
DATA ENT. JOB#		00					
PREV.	NEXT	LIST	P DOWN				
PGH2	MIKE						
							0001
							11 57AM

The screen continues.

Program each item as follows:

- **AMOUNT (Use the numeric entry method)**
Discount amount (max. 6 digits: 0 to 999999)
- **TEXT (Use the character entry method)**
Description for the discount key. Up to 12 characters can be entered.
- **SIGN (Use the selective entry method)**
The + or – sign assigns the premium or discount function to each discount key.
–: Minus amount (discount)
+: Plus amount (premium)
- **TAXABLE1 thru 5 (Use the selective entry method)**
YES : Taxable
NO : Non-taxable
- **FS/CASH BNF (Use the selective entry method)**
Food stamp/cash benefit status
NO : Food stamp/cash benefit ineligible
YES : Food stamp/cash benefit eligible
- **GROUP DISCOUNT 1 thru 3 (Use the selective entry method)**
Group discount status
NO : Non-discountable
YES : Discountable
- **HALO (High Amount Lockout: use the numeric entry method)**
A: Significant digit for HALO (1 thru 9)
B: Number of zeros to follow the significant digit for HALO (0 thru 7)
AB is the same as A x 10B.
- **ENTRY TYPE (Use the selective entry method)**
ITEM: Item (–)
SBTL: Subtotal (–)
- **ENTRY IN REG (Use the selective entry method)**
YES : Allows a discount entry in the REG mode.
NO : Inhibits a discount entry in the REG mode.
- **DATA ENT. JOB# (Use the numeric entry method)**
Key data entry job number (Capture job number: 0 thru 99)
When “0” is programmed, data capture is inhibited.
- **PLU1 thru 20 (Use the numeric entry method)**
Program the PLU code for which the corresponding (–) key is usable. (1 thru 99999)

NOTE For the Markdown coupon entry (item (–)):
The coupon entry will be allowed only for a PLU which is listed in this table.
For the Discount coupon entry (ST (–)):
The coupon entry will be allowed only when all PLU listed in this table have been entered.

NOTE You can also select a discount key by pressing the corresponding key when it has been placed directly on the keyboard instead of selecting the key from the menu.

■ Percent key (%1 thru %9)

Procedure

Select the desired percent key from the percent keys list.

↓

Z1	↓	P UP ▲	CAN	CEL	.	CL
RATE				-0.00%		
TEXT	Z1					
SIGN			7	8	9	
TAXABLE1		NO	4	5	6	
TAXABLE2		NO				
TAXABLE3		NO	1	2	3	
TAXABLE4		NO				
TAXABLE5		NO	0	00	ENTR	
PREV.	NEXT	LIST	P DOWN ▼			
PGM2	HIKE					0001 11:59AM

↓

Z1	↑↓	P UP ▲	CAN	CEL	.	CL
FS/CASH BNF		NO				
GROUP DISCOUNT1		NO	7	8	9	
GROUP DISCOUNT2		NO				
GROUP DISCOUNT3		NO	4	5	6	
%HALO	100.00%					
ENTRY TYPE	SBTL		1	2	3	
ENTRY IN REG		NO				
DATA ENT. JOB#		00	0	00	ENTR	
PREV.	NEXT	LIST	P DOWN ▼			
PGM2	HIKE					0001 12:00PM

The screen continues.

Program each item as follows:

- **RATE (Use the numeric entry method)**
Percent rate (0.00 to 100.00)
- **TEXT (Use the character entry method)**
Description for the percent key. Up to 12 characters can be entered.
- **SIGN (Use the selective entry method)**
Programming of the + or – sign assigns the premium or discount function to each percent key.
–: Minus (discount)
+: Plus (premium)
- **TAXABLE1 thru 5 (Use the selective entry method)**
YES : Taxable
NO : Non-taxable
- **FS/CASH BNF (Use the selective entry method)**
Food stamp/cash benefit status
NO : Food stamp/cash benefit ineligible
YES : Food stamp/cash benefit eligible
- **GROUP DISCOUNT 1 thru 3 (Use the selective entry method)**
Group discount status
NO : Non-discountable
YES : Discountable
- **%HALO (High Amount Lockout: use the numeric entry method)**
HALO (High Amount Lockout) for the percent key (0.00 to 100.00)
- **ENTRY TYPE (Use the selective entry method)**
ITEM : Item %
SBTL : Subtotal %
- **ENTRY IN REG (Use the selective entry method)**
YES : Allows a discount entry in the REG mode.
NO : Inhibits a discount entry in the REG mode.
- **DATA ENT. JOB# (Use the numeric entry method)**
Key data entry job number (Capture job number: 0 thru 99)
When “0” is programmed, data entry is inhibited.
- **PLU1 thru 20 (Use the numeric entry method)**
Program PLU code which the corresponding % key. (1 thru 99999)

NOTE

For the Markdown % entry (item %):

The % entry will be allowed only for a PLU which is listed in this table.

For the Discount % entry (ST %):

The % entry will be allowed only when all PLUs listed in this table have been entered.

NOTE

You can also select a percent key by pressing the corresponding key when it has been placed directly on the keyboard instead of selecting the key from the menu.

■ Group discount key (GDSC%1 thru GDSC%3)

Procedure

Select the desired key from the group discount keys list.

↓

GDISC%1	P	UP	▲	CAN	·	CL
RATE				CEL		
TEXT(%)				7	8	9
TEXT(ST)				4	5	6
SIGN			-	1	2	3
TAXABLE1			NO	0	00	ENTR
TAXABLE2			NO			
TAXABLE3			NO			
TAXABLE4			NO			
PREV.	NEXT	LIST	P	DOWN		

PGM2 10:29AM

↓

GDISC%1	P	UP	▲	CAN	·	CL
TAXABLE1			NO	7	8	9
TAXABLE2			NO	4	5	6
TAXABLE3			NO	1	2	3
TAXABLE4			NO			
TAXABLE5			NO			
FS/CASH BNF			NO	0	00	ENTR
ZHALO	100.00%					
DATA ENT. JOB#			00			
PREV.	NEXT	LIST	P	DOWN		

PGM2 10:29AM

Program each item as follows:

- **RATE (Use the numeric entry method)**
Percent rate (0.00 to 100.00)
- **TEXT (%) (Use the character entry method)**
Description for the group discount key. Up to 12 characters can be entered.
- **TEXT (ST) (Use the character entry method)**
Description for group subtotal. Up to 12 characters can be entered.
- **SIGN (Use the selective entry method)**
Programming of the + or – sign assigns the premium or discount function to each group discount key.
–: Minus (discount)
+: Plus (premium)
- **TAXABLE1 thru 5 (Use the selective entry method)**
YES : Taxable
NO : Non-taxable
- **FS/CASH BNF (Use the selective entry method)**
Food stamp/cash benefit status
NO : Food stamp/cash benefit ineligible
YES : Food stamp/cash benefit eligible
- **%HALO (High Amount Lockout: use the numeric entry method)**
HALO (High Amount Lockout) for the group discount key (0.00 to 100.00)
- **DATA ENT. JOB# (Use the numeric entry method)**
Key data entry job number (Capture job no: 0 thru 99)
When “0” is programmed, data entry is inhibited.

NOTE

You can also select a group discount key by pressing the corresponding key when it has been placed directly on the keyboard instead of selecting the key from the menu.

■ Gas discount

Procedure

Select the desired Gas discount (1 thru 28) from the list.



GAS(-)1	P UP ▲	CAN	·	CL
PRICE(Cent)		CEL		
TEXT	GAS(-)1	7	8	9
		4	5	6
		1	2	3
		0	00	ENTR
PREV.	NEXT	LIST	P DOWN ▼	
PGM2				10 31AM

Program each item as follows:

- **PRICE(Cent) (Use the numeric entry method)**
Reduce unit price for each medium (0.0 to 99.9 Cent)
- **TEXT (Use the character entry method)**
Description for gas discount. Up to 12 characters can be entered.

■ Gratuity

Procedure

GRATUITY	P UP ▲	CAN	CEL	.	CL
RATE	0.00%				
TEXT	GRATUITY		7	8	9
SIGN	+				
TAXABLE1	NO		4	5	6
TAXABLE2	NO				
TAXABLE3	NO		1	2	3
TAXABLE4	NO				
TAXABLE5	NO		0	00	ENTR
PREV. NEXT LIST P DOWN ▼					
PGM2 MIKE					0001 12 04PH

Program each item as follows:

- **RATE (Use the numeric entry method)**
Percent rate (0.00 to 100.00)
- **TEXT (Use the character entry method)**
Description for gratuity. Up to 12 characters can be entered.
- **SIGN (Use the selective entry method)**
The + or – sign assigns the premium or discount function for the gratuity.
–: Minus (discount)
+: Plus (premium)
- **TAXABLE1 thru 5 (Use the selective entry method)**
YES : Taxable
NO : Non-taxable

■ Tip

Procedure

TIP	P UP ▲	CAN	CEL	.	CL
RATE	0.00%				
TEXT(CASH)	CA TIP		7	8	9
TEXT(CHR)	CH TIP				
HALO	17		4	5	6
			1	2	3
			0	00	ENTR
PREV. NEXT LIST P DOWN ▼					
PGM2 MIKE					0001 12 04PH

Program each item as follows:

- **RATE (Use the numeric entry method)**
Percent rate (0.00 to 100.00)
- **TEXT(CASH) (Use the character entry method)**
Description for the cash tip. Up to 12 characters can be entered.
- **TEXT(CHR) (Use the character entry method)**
Description for the non-cash tip. Up to 12 characters can be entered.
- **HALO (High Amount Lockout: use the numeric entry method)**
A: Significant digit for HALO (1 thru 9)
B: Number of zeros to follow the significant digit for HALO (0 thru 8)
AB is the same as A x 10B.

NOTE

You can also select a tip key by pressing the corresponding key when it has been placed directly on the keyboard instead of selecting the key from the menu.

■ RA

Procedure

Select the desired received-on-account key from the RA keys list.



***RA2		P UP	A	CAN	.	CL
HALO			18	CEL		
TEXT	***RA2					
DATA ENT. JOB#		00		7	8	9
EFT/ACCT PROG.	NOT COMPULSORY			4	5	6
ACCT	ONLINE COMPULSORY					
ACCT NEGATIVE#	NO			1	2	3
ACCT POSITIVE#	NO					
PREV.	NEXT	LIST	P DOWN		00	ENTR
PGM2	MIKE					0001
						12:05PM

Program each item as follows:

- **HALO (High Amount Lockout: use the numeric entry method)**

A: Significant digit for HALO (1 thru 9)

B: Number of zeros to follow the significant digit for HALO (0 thru 8)

AB is the same as A x 10B.

- **TEXT (Use the character entry method)**

Description for the received-on-account key. Up to 12 characters can be entered.

NOTE

You can also select an RA key by pressing the corresponding key when it has been placed directly on the keyboard instead of selecting the key from the menu.

- **DATA ENT. JOB# (Use the numeric entry method)**

Key data entry job no. (Capture job no: 0 thru 99)

When "0" is programmed, data entry is inhibited.

- **EFT/ACCT PROG. (Use the selective entry method)**

EFT/ACCT programming

- NOT COMPULSORY.
- ACCT COMPULSORY.

- **ACCT (Use the selective entry method)**

- ONLINE COMPULSORY.
- OFFLINE COMPULSORY.
- CARD RD COMPULSORY.

- **ACCT NEGATIVE# (Use the selective entry method)**

- NO
- YES

- **ACCT POSITIVE# (Use the selective entry method)**

- NO
- YES

■ PO

Procedure

Select the desired paid-out key from the PO keys list.



***PO		P UP	▲	CAN	CEL	.	CL
HALO			18				
TEXT	***PO			7	8	9	
DATA ENT. JOB#		00		4	5	6	
				1	2	3	
				0	00	ENTR	
PREV.	NEXT	LIST	P DOWN ▼				
PGH2	HIKE						0001
							12:11PM

Program each item as follows:

- **HALO (High Amount Lockout: use the numeric entry method)**
 - A: Significant digit for HALO (1 thru 9)
 - B: Number of zeros to follow the significant digit for HALO (0 thru 8)
 - AB is the same as A x 10B.
- **TEXT (Use the character entry method)**
 - Description for the paid-out key. Up to 12 characters can be entered.

NOTE

You can also select a PO key by pressing the corresponding key when it has been placed directly on the keyboard instead of selecting the key from the menu.

- **DATA ENT. JOB# (Use the numeric entry method)**
 - Key data entry job no. (Capture job no: 0 thru 99)
 - When "0" is programmed, data entry is inhibited.

■ Manual tax

Procedure

MANUAL TAX		P UP	▲	CAN	CEL	.	CL
HALO			17				
TEXT	M-TAX			7	8	9	
DATA ENT. JOB#		00		4	5	6	
				1	2	3	
				0	00	ENTR	
PREV.	NEXT	LIST	P DOWN ▼				
PGH2	HIKE						0001
							12:12PM

Program each item as follows:

- **HALO (High Amount Lockout: use the numeric entry method)**
 - A: Significant digit for HALO (1 thru 9)
 - B: Number of zeros to follow the significant digit for HALO (0 thru 8)
 - AB is the same as A x 10B.
- **TEXT (Use the character entry method)**
 - Description for the manual tax key. Up to 12 characters can be entered.

NOTE

You can also select a manual tax key by pressing the corresponding key when it has been placed directly on the keyboard instead of selecting the key from the menu.

- **DATA ENT. JOB# (Use the numeric entry method)**
 - Key data entry job no. (Capture job no: 0 thru 99)
 - When "0" is programmed, data entry is inhibited.

■ Tax delete

Procedure

TAX DELETE		P UP ▲	CAN	.	CL
TEXT	TAX DELETE	00	CEL		
DATA ENT. JOB#			7	8	9
			4	5	6
			1	2	3
			0	00	ENTR
PREV.	NEXT	LIST	P DOWN ▼		0001
PGM2	MIKE				A 12 13PM

Program each item as follows:

- **TEXT (Use the character entry method)**
Description for the tax delete.
Up to 12 characters can be entered.
- **DATA ENT. JOB# (Use the numeric entry method)**
Key data entry job number (Capture job no: 0 thru 99)
When "0" is programmed, data entry is inhibited.

■ No-sale

Procedure

NO SALE		P UP ▲	CAN	.	CL
TEXT	NO SALE	00	CEL		
DATA ENT. JOB#			7	8	9
			4	5	6
			1	2	3
			0	00	ENTR
PREV.	NEXT	LIST	P DOWN ▼		0001
PGM2	MIKE				A 12 14PM

Program each item as follows:

- **TEXT (Use the character entry method)**
Description for the no-sale.
Up to 12 characters can be entered.
- **DATA ENT. JOB# (Use the numeric entry method)**
Key data entry job number (Capture job no: 0 thru 99)
When "0" is programmed, data entry is inhibited.

Void

Procedure

Select the desired void function from the list (DIRECT VOID/PAST VOID/SBTL VOID).

↓

DIRECT VOID		P UP ▲	CAN	·	CL
TEXT	DIRECT VOID		CEL		
DATA ENT. JOB#	00		7	8	9
			4	5	6
			1	2	3
			0	00	ENTR
PREV.	NEXT	LIST	P DOWN ▼		
PGM2	MIKE				0001
					12:16PM

Program each item as follows:

- **TEXT (Use the character entry method)**
Description for the void function.
Up to 12 characters can be entered.
- **DATA ENT. JOB# (Use the numeric entry method)**
Key data entry job no. (Capture job no: 0 thru 99)
When "0" is programmed, data entry is inhibited.

Refund

Procedure

FUNCTION		↑ P UP ▲	CAN	·	CL
06	TIP		CEL		
07	RA		7	8	9
08	PO		4	5	6
09	MANUAL TAX		1	2	3
10	TAX DELETE				
11	NO SALE				
12	VOID				
13	REFUND		0	00	ENTR
PREV.	NEXT	LIST	P DOWN ▼		
PGM2	MIKE				0001
					12:17PM

Program each item as follows:

- **TEXT (Use the character entry method)**
Description for the refund or return function.
Up to 12 characters can be entered.
- **DATA ENT. JOB# (Use the numeric entry method)**
Key data entry job no. (Capture job no: 0 thru 99)
When "0" is programmed, data entry is inhibited.

↓

REFUND		P UP ▲	CAN	·	CL
1	REFUND		CEL		
2	RETURN		7	8	9
			4	5	6
			1	2	3
			0	00	ENTR
PREV.	NEXT	LIST	P DOWN ▼		
PGM2	MIKE				0001
					12:17PM

↓

REFUND		P UP ▲	CAN	·	CL
TEXT	REFUND		CEL		
DATA ENT. JOB#	00		7	8	9
			4	5	6
			1	2	3
			0	00	ENTR
PREV.	NEXT	LIST	P DOWN ▼		
PGM2	MIKE				0001
					12:17PM

Return

Procedure

FUNCTION	↑ P UP ▲	CAN	CEL	.	CL
06 TIP					
07 RA		7	8	9	
08 PD					
09 MANUAL TAX		4	5	6	
10 TAX DELETE					
11 NO SALE		1	2	3	
12 VOID					
13 REFUND		0	00	ENTR	
PREV.	NEXT	LIST	P DOWN ▼		
PGM2	HIKE			0001	
					12 17PM



REFUND	↑ P UP ▲	CAN	CEL	.	CL
1 REFUND					
2 RETURN		7	8	9	
		4	5	6	
		1	2	3	
		0	00	ENTR	
PREV.	NEXT	LIST	P DOWN ▼		
PGM2					
					12 51PM



RETURN	↑ P UP ▲	CAN	CEL	.	CL
TEXT	RETURN				
DATA ENT. JOB#		00	7	8	9
		4	5	6	
		1	2	3	
		0	00	ENTR	
PREV.	NEXT	LIST	P DOWN ▼		
PGM2					
					12:52PM

Program each item as follows:

- TEXT (Use the character entry method)**
 Description for the return function.
 Up to 12 characters can be entered.
- DATA ENT. JOB# (Use the numeric entry method)**
 Key data entry job no. (Capture job no: 0 thru 99)
 When "0" is programmed, data entry is inhibited.

Media Key Programming

Use the following procedure for media key programming:

Procedure

SETTING	↓ P UP ▲	CAN	CEL	.	CL
01 ARTICLE		7	8	9	
02 DIRECT KEY		4	5	6	
03 PLU MENU KEY		1	2	3	
04 FUNCTION		0	00	ENTR	
05 MEDIA					
06 TEXT					
07 PERSONNEL					
08 TERMINAL					
PREV. NEXT LIST P DOWN ▼					
PGM2 MIKE				0001	12:18PM



MEDIA	↓ P UP ▲	CAN	CEL	.	CL
01 CASH		7	8	9	
02 CHECK		4	5	6	
03 CHARGE		1	2	3	
04 FS TEND		0	00	ENTR	
05 CASH BENEFIT					
06 CONVERSION					
07 EAT IN					
08 SERVICE					
PREV. NEXT LIST P DOWN ▼					
PGM2 MIKE				0001	12:19PM

The screen continues.

1. In the SETTING window, select “05 MEDIA.”
 - The MEDIA window will appear.

2. Select any option from the following options list:

1 CASH:	Cash key
2 CHECK:	Check key
3 CHARGE:	Charge key
4 FS TEND:	Food stamp tender key
5 CASH BENEFIT:	Cash benefit key
6 CONVERSION:	Currency conversion keys
7 EAT IN:	Eat-in key
8 SERVICE:	Service key
9 FINAL:	Final key
10 CID:	Cash in drawer
11 CH/CG:	Check change
12 CA/CK:	Check cashing
13 MONEY:	Currency denominations

The following illustration shows the media key programming options.

5 MEDIA	1 CASH	➔ See “Cash keys” on page 156 .
	2 CHECK	➔ See “Check keys” on page 160 .
	3 CHARGE	➔ See “Charge keys” on page 163 .
	4 FS TEND	➔ See “Food stamp tender key” on page 167 .
	5 CASH BENEFIT	➔ See “Cash benefit by EBT” on page 171 .
	6 CONVERSION	➔ See “Currency conversion keys” on page 173 .
	7 EAT-IN	➔ See “Eat-in keys” on page 173 .
	8 SERVICE	➔ See “Service key” on page 174 .
	9 FINAL	➔ See “Final key” on page 176 .
	10 CID	➔ See “Cash in drawer” on page 178 .
	11 CH/CG	➔ See “Check change” on page 178 .
	12 CA/CK	➔ See “Check cashing” on page 179 .
	13 MONEY	➔ See “Currency denominations” on page 181 .

■ Cash keys

Procedure

Select the desired cash key from the cash keys list.

CASH	P UP	CAN	CEL	CL
TEXT	CASH			
HALO	18	7	8	9
GLU/PBLU	ENABLE	4	5	6
SHORT TENDER	ENABLE	1	2	3
HEADER ON BILL	NO	0	00	ENTR
FOOTER ON BILL	NO			
CLOSED GC	NO RETAINED			
BILL PRINT	NON-COMPULSORY			
PREV.	NEXT	LIST	P DOWN	
PGH2	MIKE			0001
				12 20PM

The screen continues.

Program each item as follows:

- **TEXT (Use the character entry method)**

Description for the cash key. Up to 12 characters can be entered.

- **HALO (High Amount Lockout: use the numeric entry method)**

AB is the same as $A \times 10^B$.

A: Significant digit (1 thru 9)

B: Number of zeros to follow the significant digit (0 thru 8)

You can set AB at 18 for no limitation.

- **GLU/PBLU (Use the selective entry method)**

GLU/PBLU entry

COMPULSORY: Makes the GLU/PBLU entry compulsory.

INHIBIT: Inhibits GLU/PBLU entry.

ENABLE: Enables GLU/PBLU entry.

- **SHORT TENDER (Use the selective entry method)**

Short amount tender

DISABLE: Disables short amount tender.

ENABLE: Enables short amount tender.

- **HEADER ON BILL (Use the selective entry method)**

YES : Enables header printing on the bill.

NO : Disables header printing on the bill.

- **FOOTER ON BILL (Use the selective entry method)**

YES : Enables footer printing on the bill.

NO : Disables footer printing on the bill.

- **CLOSED GC (Use the selective entry method)**

RETAIN: Retains the closed GLU/PBLU summary data.

NO RETAIN: Does not retain the closed GLU/PBLU summary data.

- **BILL PRINT (Use the selective entry method)**

Compulsory/non-compulsory bill printing

COMPULSORY: Compulsory bill printing

NON-COMPULSORY: Non-compulsory bill printing

- **FOOTER ON RCPT (Use the selective entry method)**

This item decides whether or not your POS terminal should print a message at the foot of a receipt when a specified cash key is used.

YES : Enables footer printing on the receipt.

NO : Disables footer printing on the receipt.

■ Cash keys (continued)

- **NON ADD# (Use the selective entry method)**

You can enforce non-add code entry when a cash entry is accepted.

COMPULSORY: Compulsory non-add code entry

NON-COMPULSORY: Non-compulsory non-add code entry

- **NEGATIVE # CHECK (Use the selective entry method)**

YES : Enables the negative # check function.

Any code (non-add code) existing in the negative # file is treated as invalid. The negative # check function can be overridden depending upon the programming.

NO : Disables the negative # check function.

- **POSITIVE # CHECK (Use the selective entry method)**

YES : Enables the positive # check function.

Any code (non-add code) existing in the positive # file is treated as valid.

NO : Disables the positive # check function.

- **VP (Use the selective entry method)**

COMPULSORY: Compulsory validation printing

NON-COMPULSORY: Non-compulsory validation printing

- **GAS DISCOUNT (Use the selective entry method)**

YES : Enables gas discount.

NO : Disables gas discount.

- **TAX1 thru 5 DELETE (Use the selective entry method)**

You can program each cash key to delete tax (i.e. tax 1, tax 2, tax 3, tax 4, and tax 5) when it is pressed.

YES : Deletes Tax n (1 thru 5).

NO : Calculates Tax n (1 thru 5).

- **DRAWER OPENING (Use the selective entry method)**

You can program each cash key to open the drawer.

NO : Does not open the drawer.

YES : Opens the drawer.

- **AMOUNT (Use the selective entry method)**

You may select whether amount tendered entry is compulsory or non-compulsory.

COMPULSORY: Compulsory amount tendered entry

NON-COMPULSORY: Non-compulsory amount tendered entry

- **OUTPUT KP No.1 thru No.3 (Use the numeric entry method)**

ID number of the remote printer 1, 2 or 3 (1 digit: 1 to 9)

If the number "0" is entered, no data will be sent to the remote printer.

- **CHIT RECEIPT (Use the selective entry method)**

YES : Prints on the chit receipt in the remote printer format.

NO : Prints nothing on the chit receipt.

- **DATA ENT. JOB# (Use the numeric entry method)**

Key data entry job no. (Capture job no: 0 thru 99)

When "0" is programmed, data capture entry is inhibited.

■ Cash keys (continued)

- **EFT/ACCT PROG. (Use the selective entry method)**
You can select EFT/ACCT compulsory or not-compulsory.
NOT COMPULSORY: Not-compulsory EFT/ACCT
EFT COMPULSORY: Compulsory EFT
ACCT COMPULSORY: Compulsory ACCT
- **EFT (Use the selective entry method)**
Select ACTION CODE from the following options:
AUTH-ONLY
DIAL
POST-AUTH
- **EFT TYPE (Use the selective entry method)**
Select the transaction type.
GIFT CARD
CHECK
DEBIT
CREDIT
- **ACCT (Use the selective entry method)**
ONLINE COMPULSORY.
OFFLINE COMPULSORY.
CARD RD COMPULSORY.
- **ACCT NEGATIVE# (Use the selective entry method)**
NO
YES
- **ACCT POSITIVE# (Use the selective entry method)**
NO
YES
- **CARD# PRINT (Use the selective entry method)**
YES : Prints the card number.
NO : Does not print the card number.
- **SIGN.LINE PRINT (Use the selective entry method)**
YES : Prints the signature line.
NO : Does not print the signature line.
- **CARD HOLDER PRINT (Use the selective entry method)**
YES : Prints the name of the card holder.
NO : Does not print the name of the card holder.
- **EXPIRATION PRINT (Use the selective entry method)**
YES : Prints the card expiration date.
NO : Does not print the card expiration date.

■ Cash keys (continued)

- **NUMBER OF RCPT (Use the numeric entry method)**

Number of authorization receipts to be issued (1 digit: 1 to 9)
If the number "0" is entered, no authorization receipt is issued.

NOTE

You can also select a cash key by pressing the corresponding key when it has been placed directly on the keyboard instead of selecting the key from the menu.

- **PRINT LALO (Use the numeric entry method)**

LALO for gift card authorization receipt printing (00.00-99.99)

- **IC CARD (Use the selective entry method)**

YES : Enables IC card entry
NO : Disables IC card entry

■ Check keys

Procedure

Select the desired check key from the check keys list.

CHECK1	↓ P UP ▲	CAN	CEL	·	CL
TEXT	CHECK1	18			
HALO		7	8	9	
GLU/PBLU	ENABLE	4	5	6	
SHORT TENDER	ENABLE	1	2	3	
HEADER ON BILL	NO	0	00	ENTR	
FOOTER ON BILL	NO				
CLOSED GC	NO RETAINED				
BILL PRINT	NON-COMPULSORY				
PREV. NEXT	LIST P DOWN ▼				
PGM2 MIKE					0001
					12:23PM

The screen continues.

Program each item as follows:

- **TEXT (Use the character entry method)**

Description for the check key. Up to 12 characters can be entered.

- **HALO (High Amount Lockout: use the numeric entry method)**

AB is the same as A x 10B.

A: Significant digit (0 thru 9)

B: Number of zeros to follow the significant digit (0 thru 8)

You can set AB at 18 for no limitation.

- **GLU/PBLU (Use the selective entry method)**

COMPUL: Makes GLU/PBLU entry compulsory.

INHIBIT: Inhibits GLU/PBLU entry.

ENABLE: Enables GLU/PBLU entry.

- **SHORT TENDER (Use the selective entry method)**

DISABLE: Disables short amount tender.

ENABLE: Enables short amount tender.

- **HEADER ON BILL (Use the selective entry method)**

YES : Enables header printing on the bill.

NO : Disables header printing on the bill.

- **FOOTER ON BILL (Use the selective entry method)**

YES : Enables footer printing on the bill.

NO : Disables footer printing on the bill.

- **CLOSED GC (Use the selective entry method)**

RETAIN: Retains the closed GLU/PBLU summary data.

NO RETAIN: Does not retain the closed GLU/PBLU summary data.

- **BILL PRINT (Use the selective entry method)**

COMPULSORY: Compulsory bill printing

NON-COMPULSORY: Non-compulsory bill printing

- **FOOTER ON RCPT (Use the selective entry method)**

YES : Enables footer printing on the receipt.

NO : Disables footer printing on the receipt.

- **NON ADD # (Use the selective entry method)**

COMPULSORY: Compulsory non-add code entry

NON-COMPULSORY: Non-compulsory non-add code entry

- **NEGATIVE # CHECK (Use the selective entry method)**

YES : Enables the negative # check function.

Any code (non-add code) existing in the negative # file is treated as invalid. The negative # check function can be overridden depending upon the programming.

NO : Disables the negative # check function.

■ Check keys (continued)

- **POSITIVE # (Use the selective entry method)**

YES : Enables the positive # check function.

Any code (non-add code) existing in the positive # file is treated as valid.

NO : Disables the positive # check function.

- **CHANGE DUE (Use the selective entry method)**

Whether to enable or disable the change calculation function can be selected for each check key.

DISABLE: Disables change calculation.

ENABLE: Enables change calculation.

- **VP (Use the selective entry method)**

COMPULSORY: Compulsory validation printing

NON-COMPULSORY: Non-compulsory validation printing

- **GAS DISCOUNT (Use the selective entry method)**

YES : Enables gas discount.

NO : Disables gas discount.

- **TAX1 thru 5 DELETE (Use the selective entry method)**

You can program each check key to delete tax (i.e. tax 1, tax 2, tax 3, tax 4, and tax 5) when it is pressed.

YES : Deletes Tax n (1 thru 5).

NO : Calculates Tax n (1 thru 5).

- **DRAWER OPENING (Use the selective entry method)**

NO : Does not open the drawer.

YES : Opens the drawer.

- **AMOUNT (Use the selective entry method)**

COMPULSORY: Compulsory amount tendered entry

NON-COMPULSORY: Non-compulsory amount tendered entry

- **OUTPUT KP No.1 thru 3 (Use the numeric entry method)**

ID number of the remote printer 1, 2 or 3 (1 digit: 1 to 9)

If the number "0" is entered, no items will be sent to the remote printer.

- **CHIT RECEIPT (Use the selective entry method)**

YES : Prints on the chit receipt in the remote printer format.

NO : Prints nothing on the chit receipt.

- **DATA ENT. JOB# (Use the numeric entry method)**

Key data entry job no. (Capture job no: 0 thru 99)

When "0" is programmed, the data capture entry is inhibited.

- **EFT/ACCT PROG. (Use the selective entry method)**

You can select EFT/ACCT compulsory or not-compulsory.

NOT COMPULSORY: Not-compulsory EFT/ACCT

EFT COMPULSORY: Compulsory EFT

ACCT COMPULSORY: Compulsory ACCT

- **EFT (Use the selective entry method)**

Select the ACTION CODE from the following options:

AUTH-ONLY

DIAL

POST-AUTH

■ Check keys (continued)

- **EFT TYPE (Use the selective entry method)**

Select the transaction type.

GIFT CARD
CHECK
DEBIT
CREDIT

- **ACCT (Use the selective entry method)**

ONLINE COMPULSORY.
OFFLINE COMPULSORY.
CARD RD COMPULSORY.

- **ACCT NEGATIVE# (Use the selective entry method)**

NO
YES

- **ACCT POSITIVE# (Use the selective entry method)**

NO
YES

- **CARD# PRINT (Use the selective entry method)**

YES : Prints the card number.
NO : Does not print the card number.

- **SIGN.LINE PRINT (Use the selective entry method)**

YES : Prints the signature line.
NO : Does not print the signature line.

- **CARD HOLD. PRINT (Use the selective entry method)**

YES : Prints the name of the card holder.
NO : Does not print the name of the card holder.

- **EXPIRATION PRINT (Use the selective entry method)**

YES : Prints the card expiration date.
NO : Does not print the card expiration date.

- **NUMBER OF RCPT (Use the numeric entry method)**

Number of authorization receipts to be issued (1 digit: 1 to 9)
If the number "0" is entered, no authorization receipt is issued.

- **PRINT LALO (Use the numeric entry method)**

LALO for gift card authorization receipt printing (00.00-99.99)

- **IC CARD (Use the selective entry method)**

YES : Enables IC card entry
NO : Disables IC card entry

NOTE

You can also select a check key by pressing the corresponding key when it has been placed directly on the keyboard instead of selecting the key from the menu.

■ Charge keys

Procedure

Select the desired charge key from the charge keys list.

CHARGE1	↓ P UP ▲	CAN	·	CL
TEXT(GROSS)	CHARGE1	CEL		
TEXT(RFND)	CHARGE1-	7	8	9
HALO		18		
GLU/PBLU	ENABLE	4	5	6
SHORT TENDER	ENABLE	1	2	3
HEADER ON BILL	NO			
FOOTER ON BILL	NO			
CLOSED GC	NO RETAINED	0	00	ENTR
PREV.	NEXT	LIST	P DOWN	
PGH2	MIKE			0001

The screen continues.

Program each item as follows:

- **TEXT(GROSS) (Use the character entry method)**

Description for the charge (gross sales) key. Up to 12 characters can be entered.

- **TEXT(REFUND) (Use the character entry method)**

Description for the (refunded) charge key. Up to 12 characters can be entered.

- **HALO (High Amount Lockout: use the numeric entry method)**

AB is the same as A x 10B.

A: Significant digit (0 thru 9)

B: Number of zeros to follow the significant digit (0 thru 8)

You can set AB at 18 for no limitation.

- **GLU/PBLU (Use the selective entry method)**

COMPULSORY: Makes GLU/PBLU entry compulsory.

INHIBIT: Inhibits GLU/PBLU entry.

ENABLE: Enables GLU/PBLU entry.

- **SHORT TENDER (Use the selective entry method)**

DISABLE: Disables short amount tender.

ENABLE: Enables short amount tender.

- **HEADER ON BILL (Use the selective entry method)**

YES : Enables header printing on the bill.

NO : Disables header printing on the bill.

- **FOOTER ON BILL (Use the selective entry method)**

YES : Enables footer printing on the bill.

NO : Disables footer printing on the bill.

- **CLOSED GC (Use the selective entry method)**

RETAIN: Retains the closed GLU/PBLU summary data.

NO RETAIN: Does not retain the closed GLU/PBLU summary data.

- **BILL PRINT (Use the selective entry method)**

Compulsory/non-compulsory bill printing

COMPULSORY: Compulsory bill printing

NON-COMPULSORY: Non-compulsory bill printing

- **FOOTER ON RCPT (Use the selective entry method)**

YES : Enables footer printing on the receipt.

NO : Disables footer printing on the receipt.

- **NON ADD # (Use the selective entry method)**

COMPULSORY: Compulsory non-add code entry

NON-COMPULSORY: Non-compulsory non-add code entry

■ Charge keys (continued)

- **NEGATIVE # CHECK (Use the selective entry method)**

YES : Enables the negative # check function.

Any code (non-add code) existing in the negative # file is treated as invalid. The negative # check function can be overridden depending upon the programming.

NO : Disables the negative # check function.

- **POSITIVE # (Use the selective entry method)**

YES : Enables the positive # check function.

Any code (non-add code) existing in the positive # file is treated as valid.

NO : Disables the positive # check function.

- **CHANGE DUE (Use the selective entry method)**

Whether to enable or disable the change calculation function can be selected for each check key.

DISABLE: Disables change calculation.

ENABLE: Enables change calculation.

- **VP (Use the selective entry method)**

COMPULSORY: Compulsory validation printing

NON-COMPULSORY: Non-compulsory validation printing

- **GAS DISCOUNT (Use the selective entry method)**

YES : Enables gas discount.

NO : Disables gas discount.

- **TAX1 thru 5 DELETE (Use the selective entry method)**

You can program each check key to delete tax (i.e. tax 1, tax 2, tax 3, tax 4, and tax 5) when it is pressed.

YES : Deletes Tax n (1 thru 5).

NO : Calculates Tax n (1 thru 5).

- **DRAWER OPENING (Use the selective entry method)**

NO : Does not open the drawer.

YES : Opens the drawer.

- **AMOUNT (Use the selective entry method)**

COMPULSORY: Compulsory amount tendered entry

INHIBIT: Inhibit amount tendered entry

- **OUTPUT KP No.1 thru 3 (Use the numeric entry method)**

ID number of the remote printer 1, 2 or 3 (1 digit: 1 to 9)

If the number "0" is entered, no items will be sent to the remote printer.

- **CHIT RECEIPT (Use the selective entry method)**

YES : Prints on the chit receipt in the remote printer format.

NO : Prints nothing on the chit receipt.

- **DATA ENT. JOB# (Use the numeric entry method)**

Key data entry job no. (Capture job no: 0 thru 99)

When "0" is programmed, the data capture entry is inhibited.

- **EFT/ACCT PROG. (Use the selective entry method)**

You can select EFT/ACCT compulsory or not-compulsory.

NOT COMPULSORY: Not-compulsory EFT/ACCT

EFT COMPULSORY: Compulsory EFT

ACCT COMPULSORY: Compulsory ACCT

■ Charge keys (continued)

- **EFT (Use the selective entry method)**

Select ACTION CODE from the following options:

AUTH-ONLY

DIAL

POST-AUTH

- **EFT TYPE (Use the selective entry method)**

Select the transaction type.

GIFT CARD

CHECK

DEBIT

CREDIT

- **ACCT (Use the selective entry method)**

ONLINE COMPULSORY.

OFFLINE COMPULSORY.

CARD RD COMPULSORY.

- **ACCT NEGATIVE# (Use the selective entry method)**

NO

YES

- **ACCT POSITIVE# (Use the selective entry method)**

NO

YES

- **CARD# PRINT (Use the selective entry method)**

YES : Prints the card number.

NO : Does not print the card number.

- **SIGN.LINE PRINT (Use the selective entry method)**

YES : Prints the signature line.

NO : Does not print the signature line.

- **CARD HOLDER PRINT (Use the selective entry method)**

YES : Prints the name of the card holder.

NO : Does not print the name of the card holder.

- **EXPIRATION PRINT (Use the selective entry method)**

YES : Prints the card expiration date.

NO : Does not print the card expiration date.

- **NUMBER OF RCPT (Use the numeric entry method)**

Number of authorization receipts to be issued (1 digit: 1 to 9)

If the number "0" is entered, no authorization receipt is issued.

- **PRINT LALO (Use the numeric entry method)**

LALO for gift card authorization receipt printing (00.00-99.99)

- **IC CARD (Use the selective entry method)**

YES : Enables IC card entry

NO : Disables IC card entry

■ Charge keys (continued)

- **TIP LINE PRINT (Use the selective entry method)**

YES : Prints the tip line.

NO : Does not print the tip line.

NOTE

You can also select a charge key by pressing the corresponding key when it has been placed directly on the keyboard instead of selecting the key from the menu.

■ Food stamp tender key: For manual entry of paper food stamp payment

Procedure

MEDIA	↓ P UP ▲	CAN	·	CL
01 CASH		CEL		
02 CHECK		7	8	9
03 CHARGE				
04 FS TEND		4	5	6
05 CASH BENEFIT				
06 CONVERSION		1	2	3
07 EAT IN				
08 SERVICE		0	00	ENTR
PREV. NEXT LIST P DOWN ▼				
PGH2				1 37PM



FS TEND	↓ P UP ▲	CAN	·	CL
1 FS TEND		CEL		
2 FS TEND EBT		7	8	9
		4	5	6
		1	2	3
		0	00	ENTR
PREV. NEXT LIST P DOWN ▼				
PGH2				1 37PM



FS TEND	↓ P UP ▲	CAN	·	CL
TEXT	FS TEND	CEL		
GLU/PBLU	ENABLE	7	8	9
HEADER ON BILL	NO			
FOOTER ON BILL	NO	4	5	6
CLOSED GC	NO RETAINED			
BILL PRINT	NON-COMPULSORY	1	2	3
FOOTER ON RCPT	NO			
NON ADD#	NON-COMPULSORY	0	00	ENTR
PREV. NEXT LIST P DOWN ▼				
PGH2				1:37PM

The screen continues.

Program each item as follows:

- **TEXT (Use the character entry method)**

Description for the check key. Up to 12 characters can be entered.

- **GLU/PBLU (Use the selective entry method)**

COMPULSORY: Makes GLU/PBLU entry compulsory.

INHIBIT: Inhibits GLU/PBLU entry.

ENABLE: Enables GLU/PBLU entry.

- **HEADER ON BILL (Use the selective entry method)**

YES : Enables header printing on the bill.

NO : Disables header printing on the bill.

- **FOOTER ON BILL (Use the selective entry method)**

YES : Enables footer printing on the bill.

NO : Disables footer printing on the bill.

- **CLOSED GC (Use the selective entry method)**

RETAIN: Retains the closed GLU/PBLU summary data.

NO RETAIN: Does not retain the closed GLU/PBLU summary data.

- **BILL PRINT (Use the selective entry method)**

COMPULSORY: Compulsory bill printing

NON-COMPULSORY: Non-compulsory bill printing

- **FOOTER ON RCPT (Use the selective entry method)**

YES : Enables footer printing on the receipt.

NO : Disables footer printing on the receipt.

- **NON ADD # (Use the selective entry method)**

COMPULSORY: Compulsory non-add code entry

NON-COMPULSORY: Non-compulsory non-add code entry

- **NEGATIVE # CHECK (Use the selective entry method)**

YES : Enables the negative # check function.

Any code (non-add code) existing in the negative # file is treated as invalid. The negative # check function can be overridden depending upon the programming.

NO : Disables the negative # check function.

- **POSITIVE # (Use the selective entry method)**

YES : Enables the positive # check function.

Any code (non-add code) existing in the positive # file is treated as valid.

NO : Disables the positive # check function.

- **VP (Use the selective entry method)**

COMPULSORY: Compulsory validation printing

NON-COMPULSORY: Non-compulsory validation printing

■ Food stamp tender key (continued)

- **DRAWER OPENING (Use the selective entry method)**

NO : Does not open the drawer.

YES : Opens the drawer.

- **OUTPUT KP No.1 thru 3 (Use the numeric entry method)**

ID number of the remote printer 1, 2 or 3 (1 digit: 1 to 9)

If the number "0" is entered, no data will be sent to the remote printer.

- **CHIT RECEIPT (Use the selective entry method)**

YES : Prints on the chit receipt in the remote printer format.

NO : Prints nothing on the chit receipt.

- **DATA ENT. JOB# (Use the numeric entry method)**

Key data entry job no. (Capture job no: 0 thru 99)

When "0" is programmed, data capture entry is inhibited.

NOTE

You can also select a food stamp tender key by pressing the corresponding key when it has been placed directly on the keyboard instead of selecting the key from the menu.

■ FSTEND EBT key: For food stamp tendering by EBT (Electronic Benefits Transfer)

Procedure

FS TEND	P UP ▲	CAN	.	CL
1 FS TEND		CEL		
2 FS TEND EBT		7	8	9
		4	5	6
		1	2	3
		0	00	ENTR
PREV. NEXT LIST P DOWN ▼				
PGH2				1:39PM



FS TEND EBT	↓ P UP ▲	CAN	.	CL
TEXT	FS TEND EBT	CEL		
GLU/PBLU	ENABLE	7	8	9
HEADER ON BILL	NO	4	5	6
FOOTER ON BILL	NO	1	2	3
CLOSED GC	NO RETAINED	0	00	ENTR
BILL PRINT	NON-COMPULSORY			
FOOTER ON RCPT	NO			
NON ADD#	NON-COMPULSORY			
PREV. NEXT LIST P DOWN ▼				
PGH2				1:39PM

The screen continues.

Program each item as follows:

- **TEXT (Use the character entry method)**

Description for the check key. Up to 12 characters can be entered.

- **GLU/PBLU (Use the selective entry method)**

COMPULSORY: Makes GLU/PBLU entry compulsory.

INHIBIT: Inhibits GLU/PBLU entry.

ENABLE: Enables GLU/PBLU entry.

- **HEADER ON BILL (Use the selective entry method)**

YES : Enables header printing on the bill.

NO : Disables header printing on the bill.

- **FOOTER ON BILL (Use the selective entry method)**

YES : Enables footer printing on the bill.

NO : Disables footer printing on the bill.

- **CLOSED GC (Use the selective entry method)**

RETAIN: Retains the closed GLU/PBLU summary data.

NO RETAIN: Does not retain the closed GLU/PBLU summary data.

- **BILL PRINT (Use the selective entry method)**

COMPULSORY: Compulsory bill printing

NON-COMPULSORY: Non-compulsory bill printing

- **FOOTER ON RCPT (Use the selective entry method)**

YES : Enables footer printing on the receipt.

NO : Disables footer printing on the receipt.

- **NON ADD # (Use the selective entry method)**

COMPULSORY: Compulsory non-add code entry

NON-COMPULSORY: Non-compulsory non-add code entry

- **NEGATIVE # CHECK (Use the selective entry method)**

YES : Enables the negative # check function.

Any code (non-add code) existing in the negative # file is treated as invalid. The negative # check function can be overridden depending upon the programming.

NO : Disables the negative # check function.

- **POSITIVE # (Use the selective entry method)**

YES : Enables the positive # check function.

Any code (non-add code) existing in the positive # file is treated as valid.

NO : Disables the positive # check function.

- **VP (Use the selective entry method)**

COMPULSORY: Compulsory validation printing

NON-COMPULSORY: Non-compulsory validation printing

■ **FSTEND EBT key: For food stamp tendering by EBT (Electronic Benefits Transfer) (continued)**

- **DRAWER OPENING (Use the selective entry method)**

NO : Does not open the drawer.

YES : Opens the drawer.

- **OUTPUT KP No.1 thru 3 (Use the numeric entry method)**

ID number of the remote printer 1, 2 or 3 (1 digit: 1 to 9)

If the number "0" is entered, no data will be sent to the remote printer.

- **CHIT RECEIPT (Use the selective entry method)**

YES : Prints on the chit receipt in the remote printer format.

NO : Prints nothing on the chit receipt.

- **DATA ENT. JOB# (Use the numeric entry method)**

Key data entry job no. (Capture job no: 0 thru 99)

When "0" is programmed, data capture entry is inhibited.

- **CARD# PRINT (Use the selective entry method)**

YES : Prints the card number.

NO : Does not print the card number.

- **CARD HOLDER PRINT (Use the selective entry method)**

YES : Prints the name of the card holder.

NO : Does not print the name of the card holder.

- **EXPIRATION PRINT (Use the selective entry method)**

YES : Prints the card expiration date.

NO : Does not print the card expiration date.

NOTE

You can also select a food stamp tender key by pressing the corresponding key when it has been placed directly on the keyboard instead of selecting the key from the menu.

■ Cash benefit by EBT (CASH BNF key)

Procedure

MEDIA	↓ P UP ▲	CAN	CEL	.	CL
01 CASH					
02 CHECK		7	8	9	
03 CHARGE					
04 FS TEND		4	5	6	
05 CASH BENEFIT					
06 CONVERSION		1	2	3	
07 EAT IN					
08 SERVICE		0	00	ENTR	
PREV. NEXT LIST P DOWN ▼					
PGM2					2 43AM



CASH BENEFIT	↓ P UP ▲	CAN	CEL	.	CL
TEXT	CASH BNF				
GLU/PBLU	ENABLE	7	8	9	
HEADER ON BILL	NO				
FOOTER ON BILL	NO	4	5	6	
CLOSED GC	NO RETAINED				
BILL PRINT	NON-COMPULSORY	1	2	3	
FOOTER ON RCPT	NO				
NON ADD#	NON-COMPULSORY	0	00	ENTR	
PREV. NEXT LIST P DOWN ▼					
PGM2					2 43AM

The screen continues.

Program each item as follows:

- **TEXT (Use the character entry method)**

Description for the check key. Up to 12 characters can be entered.

- **GLU/PBLU (Use the selective entry method)**

COMPULSORY: Makes GLU/PBLU entry compulsory.

INHIBIT: Inhibits GLU/PBLU entry.

ENABLE: Enables GLU/PBLU entry.

- **HEADER ON BILL (Use the selective entry method)**

YES : Enables header printing on the bill.

NO : Disables header printing on the bill.

- **FOOTER ON BILL (Use the selective entry method)**

YES : Enables footer printing on the bill.

NO : Disables footer printing on the bill.

- **CLOSED GC (Use the selective entry method)**

RETAIN: Retains the closed GLU/PBLU summary data.

NO RETAIN: Does not retain the closed GLU/PBLU summary data.

- **BILL PRINT (Use the selective entry method)**

COMPULSORY: Compulsory bill printing

NON-COMPULSORY: Non-compulsory bill printing

- **FOOTER ON RCPT (Use the selective entry method)**

YES : Enables footer printing on the receipt.

NO : Disables footer printing on the receipt.

- **NON ADD # (Use the selective entry method)**

COMPULSORY: Compulsory non-add code entry

NON-COMPULSORY: Non-compulsory non-add code entry

- **NEGATIVE # CHECK (Use the selective entry method)**

YES : Enables the negative # check function.

Any code (non-add code) existing in the negative # file is treated as invalid. The negative # check function can be overridden depending upon the programming.

NO : Disables the negative # check function.

- **POSITIVE # (Use the selective entry method)**

YES : Enables the positive # check function.

Any code (non-add code) existing in the positive # file is treated as valid.

NO : Disables the positive # check function.

- **VP (Use the selective entry method)**

COMPULSORY: Compulsory validation printing

NON-COMPULSORY: Non-compulsory validation printing

■ Cash benefit by EBT (continued)

- **DRAWER OPENING (Use the selective entry method)**

NO : Does not open the drawer.

YES : Opens the drawer.

- **OUTPUT KP No.1 thru 3 (Use the numeric entry method)**

ID number of the remote printer 1, 2 or 3 (1 digit:1 to 9)

If the number "0" is entered, no data will be sent to the remote printer.

- **CHIT RECEIPT (Use the selective entry method)**

YES : Prints on the chit receipt in the remote printer format.

NO : Prints nothing on the chit receipt.

- **DATA ENT. JOB# (Use the numeric entry method)**

Key data entry job no. (Capture job no: 0 thru 99)

When "0" is programmed, data capture entry is inhibited.

- **CARD# PRINT (Use the selective entry method)**

YES : Prints the card number.

NO : Does not print the card number.

- **CARD HOLDER PRINT (Use the selective entry method)**

YES : Prints the name of the card holder.

NO : Does not print the name of the card holder.

- **EXPIRATION PRINT (Use the selective entry method)**

YES : Prints the card expiration date.

NO : Does not print the card expiration date.

NOTE

You can also select a food stamp tender key by pressing the corresponding key when it has been placed directly on the keyboard instead of selecting the key from the menu.

■ Currency conversion keys

Procedure

Select the desired currency conversion key from the currency conversion keys list.

↓

CONV 1	P UP ▲	CAN	CEL	.	CL
RATE	0.0000				
TEXT	CONV 1	7	8	9	
DESCRIPTOR		4	5	6	
DRAWER No.	0	1	2	3	
		0	00	ENTR	
PREV. NEXT LIST P DOWN ▼					0001
PGM2 MIKE					12 30PM

Program each item as follows:

- **RATE (Use the numeric entry method)**
Currency conversion rate (0.0000 to 9999.9999)
(for CONV1 thru CONV4)
- **TEXT (Use the character entry method)**
Description for the currency conversion key. Up to 12 characters can be entered.
- **DESCRIPTOR (Use the character entry method)**
Currency descriptor. Up to 4 characters can be entered.
- **DRAWER No.* (Use the numeric entry method)**
Foreign currency Drawer No. (1 digit: 0 to 2)

NOTE

You can also select a conversion key by pressing the corresponding key when it has been placed directly on the keyboard instead of selecting the key from the menu.

■ Eat-in keys

Procedure

Select the desired eat-in key from the eat-in keys list.

↓

EAT IN 1	P UP ▲	CAN	CEL	.	CL
TEXT	EAT IN 1				
TAX1 DELETE	NO	7	8	9	
TAX2 DELETE	NO	4	5	6	
TAX3 DELETE	NO	1	2	3	
TAX4 DELETE	NO	0	00	ENTR	
TAX5 DELETE	NO				
PREV. NEXT LIST P DOWN ▼					0001
PGM2					2 45AM

Program each item as follows:

- **TEXT (Use the character entry method)**
Description for the eat-in key. Up to 12 characters can be entered.
- **TAX1 thru 5 DELETE (Use the selective entry method)**
YES : Deletes Tax n (1 thru 5).
NO : Calculates Tax n (1 thru 5).

NOTE

You can also select an eat-in key by pressing the corresponding key when it has been placed directly on the keyboard instead of selecting the key from the menu.

■ Service key

Procedure

SERVICE	↓ P UP ▲	CAN	·	CL
TEXT (GLU)	SERVICE	CEL		
HEADER ON BILL	NO	7	8	9
FOOTER ON BILL	NO			
BILL PRINT	NON-COMPULSORY	4	5	6
OUTPUT KP No.1	0			
OUTPUT KP No.2	0	1	2	3
OUTPUT KP No.3	0			
CHIT RECEIPT	NO	0	00	ENTR
PREV. NEXT LIST P DOWN ▼				
PGH2 MIKE				0001
				A 12 32PM

The screen continues.

Program each item as follows:

- **TEXT (GLU) (Use the character entry method)**

Description for the service key. Up to 12 characters can be entered.

- **HEADER ON BILL (Use the selective entry method)**

YES : Enables header printing on the bill.
NO : Disables header printing on the bill.

- **FOOTER ON BILL (Use the selective entry method)**

YES : Enables footer printing on the bill.
NO : Disables footer printing on the bill.

- **BILL PRINT (Use the selective entry method)**

COMPULSORY: Compulsory bill printing
NON-COMPULSORY: Non-compulsory bill printing

- **OUTPUT KP No.1 thru 3 (Use the selective entry method)**

ID number of the remote printer 1, 2 or 3 (1 digit: 1 to 9)
If the number "0" is entered, data will be printed on the remote printer.

- **CHIT RECEIPT (Use the selective entry method)**

YES : Prints on the chit receipt in the remote printer format.
NO : Prints nothing on the chit receipt.

- **DATA ENT. JOB# (Use the numeric entry method)**

Key data entry job no. (Capture job no: 0 thru 99)
When "0" is programmed, data capture entry is inhibited.

- **EFT/ACCT PROG. (Use the selective entry method)**

You can select EFT/ACCT compulsory or not-compulsory.
NOT COMPULSORY: Not-compulsory EFT/ACCT
EFT COMPULSORY: Compulsory EFT
ACCT COMPULSORY: Compulsory ACCT

- **EFT (Use the selective entry method)**

Select the ACTION CODE from the following options:
AUTH-ONLY
DIAL
POST-AUTH

- **EFT TYPE (Use the selective entry method)**

Select the transaction type.
GIFT CARD
CHECK
DEBIT
CREDIT

■ Service key (continued)

- **ACCT (Use the selective entry method)**

ONLINE COMPULSORY.
OFFLINE COMPULSORY.
CARD RD COMPULSORY.

- **ACCT NEGATIVE# (Use the selective entry method)**

NO
YES

- **ACCT POSITIVE# (Use the selective entry method)**

NO
YES

- **CARD# PRINT. (Use the selective entry method)**

YES : Prints the card number.
NO : Does not print the card number.

- **SIGN.LINE PRINT (Use the selective entry method)**

YES : Prints the signature line.
NO : Does not print the signature line.

- **CARD HOLDER PRINT (Use the selective entry method)**

YES : Prints the name of the card holder.
NO : Does not print the name of the card holder.

- **EXPIRATION PRINT (Use the selective entry method)**

YES : Prints the card expiration date.
NO : Does not print the card expiration date.

- **NUMBER OF RCPT (Use the numeric entry method)**

Number of authorization receipts to be issued (1 digit: 1 to 9)
If the number "0" is entered, no authorization receipt is issued.

- **PRINT LALO (Use the numeric entry method)**

LALO for gift card authorization receipt printing (00.00-99.99)

- **IC CARD (Use the selective entry method)**

YES : Enables IC card entry
NO : Disables IC card entry

NOTE

You can also select a service key by pressing the corresponding key when it has been placed directly on the keyboard instead of selecting the key from the menu.

Final key

Procedure

FINAL	↓	P UP	▲	CAN	CEL	.	CL
HEADER ON BILL			NO				
FOOTER ON BILL			NO				
BILL PRINT		NON-COMPULSORY		7	8	9	
OUTPUT KP No.1			0	4	5	6	
OUTPUT KP No.2			0				
OUTPUT KP No.3			0	1	2	3	
CHIT RECEIPT			NO				
DATA ENT. JOB#			00	0	00	ENTR	
PREV. NEXT LIST P DOWN			▼				
PGM2 HIKE							0001
				12	34PM		

The screen continues.

Program each item as follows:

- **HEADER ON BILL (Use the selective entry method)**

YES : Enables header printing on the bill.

NO : Disables header printing on the bill.

- **FOOTER ON BILL (Use the selective entry method)**

YES : Enables footer printing on the bill.

NO : Disables footer printing on the bill.

- **BILL PRINT (Use the selective entry method)**

COMPULSORY: Compulsory bill printing

NON-COMPULSORY: Non-compulsory bill printing

- **OUTPUT KP No.1 thru 3 (Use the number entry method)**

ID number of the remote printer 1, 2 or 3 (1 digit: 1 to 9)

If the number "0" is entered, data will be printed on the remote printer.

- **CHIT RECEIPT (Use the selective entry method)**

YES : Prints on the chit receipt in the remote printer format.

NO : Prints nothing on the chit receipt.

- **DATA ENT. JOB# (Use the numeric entry method)**

Key data entry job no. (Capture job no: 0 thru 99)

When "0" is programmed, data capture entry is inhibited.

- **EFT/ACCT PROG. (Use the selective entry method)**

You can select EFT/ACCT compulsory or not-compulsory.

NOT COMPULSORY: Not-compulsory EFT/ACCT

EFT COMPULSORY: Compulsory EFT

ACCT COMPULSORY: Compulsory ACCT

- **EFT (Use the selective entry method)**

Select the ACTION CODE from the following options:

AUTH-ONLY

DIAL

POST-AUTH

- **EFT TYPE (Use the selective entry method)**

Select the transaction type.

GIFT CARD

CHECK

DEBIT

CREDIT

■ Final key (continued)

- **ACCT (Use the selective entry method)**
ONLINE COMPULSORY.
OFFLINE COMPULSORY.
CARD RD COMPULSORY.
- **ACCT NEGATIVE# (Use the selective entry method)**
NO
YES
- **ACCT POSITIVE# (Use the selective entry method)**
NO
YES
- **CARD# PRINT (Use the selective entry method)**
YES : Prints the card number.
NO : Does not print the card number.
- **SIGN.LINE PRINT (Use the selective entry method)**
YES : Prints the signature line.
NO : Does not print the signature line.
- **CARD HOLDER PRINT (Use the selective entry method)**
YES : Prints the name of the card holder.
NO : Does not print the name of the card holder.
- **EXPIRATION PRT. (Use the selective entry method)**
YES : Prints the card expiration date.
NO : Does not print the card expiration date.
- **NUMBER OF RCPT (Use the numeric entry method)**
Number of authorization receipts to be issued (1 digit:1 to 9)
If the number "0" is entered, no authorization receipt is issued.
- **PRINT LALO (Use the numeric entry method)**
LALO for gift card authorization receipt printing (00.00-99.99)
- **IC CARD (Use the selective entry method)**
YES : Enables IC card entry
NO : Disables IC card entry

NOTE

You can also select a final key by pressing the corresponding key when it has been placed directly on the keyboard instead of selecting the key from the menu.

■ Cash in drawer

You can program the description and the upper limit amount for the cash in drawer (sentinel).

Procedure

CID	P UP ▲	CAN	·	CL
TEXT	****CID	CEL		
HALO	9999999.99	7	8	9
		4	5	6
		1	2	3
		0	00	ENTR
PREV. NEXT LIST P DOWN ▼				
PGM2 MIKE				0001
				12:55PM

Program each item as follows:

- **TEXT (Use the character entry method)**

Description for the cash in drawer. Up to 12 characters can be entered.

- **HALO (High Amount Lockout: used the numeric entry method)**

Limit amount: 0 to 9999999.99
Program each item as follows:

■ Check change.

You can program the description and the upper limit amounts for check change

Procedure

CH/CG	P UP ▲	CAN	·	CL
TEXT	CHK/CG	CEL		
HALO	9999999.99	7	8	9
		4	5	6
		1	2	3
		0	00	ENTR
PREV. NEXT LIST P DOWN ▼				
PGM2 MIKE				0001
				12:56PM

- **TEXT (Use the character entry method)**

Description for check change. Up to 12 characters can be entered.

- **HALO (High Amount Lockout: used the numeric entry method)**

Limit amount: 0 to 9999999.99

■ Check cashing

You can program the description and the upper limit amounts for check cashing.

Procedure

Select the desired check cashing no. from the check cashing numbers list.



CA/CHK1	P UP	CAN	CEL	.	CL
TEXT	CA/CHK1				
HALO	99999.99	7	8	9	
NON ADD#	NON-COMPULSORY				
NEGATIVE# CHECK	NO	4	5	6	
POSITIVE# CHECK	NO				
DATA ENT. JOB#	00	1	2	3	
EFT/ACCT PROG.	NOT COMPULSORY				
EFT	POST-AUTH	0	00	ENTR	
PGH2					

The screen continues.

Program each item as follows:

- **TEXT (Use the character entry method)**
Description for check cashing. Up to 12 characters can be entered.
- **HALO (High Amount Lockout: used the numeric entry method)**
Limit amount: 0 to 999999.99
- **NON ADD # (Use the selective entry method)**
COMPULSORY: Compulsory non-add code entry
NON-COMPULSORY: Non-compulsory non-add code entry
- **NEGATIVE # CHECK (Use the selective entry method)**
YES : Enables the negative # check function.
Any code (non-add code) existing in the negative # file is treated as invalid. The negative # check function can be overridden depending upon the programming.
NO : Disables the negative # check function.
- **POSITIVE # (Use the selective entry method)**
YES : Enables the positive # check function.
Any code (non-add code) existing in the positive # file is treated as valid.
NO : Disables the positive # check function.
- **DATA ENT. JOB# (Use the numeric entry method)**
Key data entry job no. (Capture job no: 0 thru 99)
When "0" is programmed, data capture entry is inhibited.
- **EXPIRATION PRINT (Use the selective entry method)**
YES : Prints the card expiration date.
NO : Does not print the card expiration date.
- **NUMBER OF RCPT (Use the numeric entry method)**
Number of authorization receipts to be issued (1 digit: 1 to 9)
If the number "0" is entered, no authorization receipt is issued.
- **EFT/ACCT PROG. (Use the selective entry method)**
You can select EFT/ACCT compulsory or non-compulsory.
NOT COMPULSORY: Non-compulsory EFT/ACCT
EFT COMPULSORY: Compulsory EFT
ACCT COMPULSORY: Compulsory ACCT
- **EFT (Use the selective entry method)**
Select the ACTION CODE from the following options:
AUTH-ONLY
DIAL
POST-AUTH

■ Check cashing (continued)

- **EFT TYPE (Use the selective entry method)**

Select the transaction type.

GIFT CARD
CHECK
DEBIT
CREDIT

- **ACCT (Use the selective entry method)**

ONLINE COMPULSORY.
OFFLINE COMPULSORY.
CARD RD COMPULSORY.

- **ACCT NEGATIVE# (Use the selective entry method)**

NO
YES

- **ACCT POSITIVE# (Use the selective entry method)**

NO
YES

- **CARD# PRINT (Use the selective entry method)**

YES : Prints the card number.
NO : Does not print the card number.

- **SIGN.LINE PRINT (Use the selective entry method)**

YES : Prints the signature line.
NO : Does not print the signature line.

- **CARD HOLDER PRINT (Use the selective entry method)**

YES : Prints the name of the card holder.
NO : Does not print the name of the card holder.

- **EXPIRATION PRINT (Use the selective entry method)**

YES : Prints the card expiration date.
NO : Does not print the card expiration date.

- **NUMBER OF RCPT (Use the numeric entry method)**

Number of authorization receipts to be issued (1 digit: 1 to 9)
If the number "0" is entered, no authorization receipt is issued.

- **PRINT LALO (Use the numeric entry method)**

LALO for gift card authorization receipt printing (00.00-99.99)

- **IC CARD (Use the selective entry method)**

YES : Enables IC card entry
NO : Disables IC card entry

■ Currency denominations (MONEY)

You can program the texts and amounts of each denomination (domestic bill, coin and foreign currency) used for the starting cash memory. Up to 20 currency denominations (MONEY1 through 20) can be programmed.

NOTE For the starting cash memory (SCM), refer to the "Starting Cash Memory Entry" section on page 26.

Procedure

Select the desired currency denominations from the currency MONEY list.



MONEY1	P UP ▲	CAN	.	CL
TEXT	1 CENTS	CEL		
AMOUNT	0.01	7	8	9
		4	5	6
		1	2	3
		0	00	ENTR
PREV.	NEXT	LIST	P DOWN ▼	
PGM2				A 11 29AM

- **TEXT (Use the character entry method.)**

Description for the currency denomination
Up to 12 characters can be entered.

- **AMOUNT (Use the numeric entry method.)**

Amount for the currency denomination (max. 6 digits)

Text Programming

Use the following procedure for text programming:

Procedure

SETTING	P UP	▲	CAN	CEL	.	CL
01 ARTICLE			7	8	9	
02 DIRECT KEY			4	5	6	
03 PLU MENU KEY			1	2	3	
04 FUNCTION			0	00	ENTR	
05 MEDIA						
06 TEXT						
07 PERSONNEL						
08 TERMINAL						
PREV. NEXT LIST P DOWN ▼						
PGM2 MIKE						0001 10:34AM



TEXT	P UP	▲	CAN	CEL	.	CL
1 FUNCTION TEXT			7	8	9	
2 DEPT. GROUP			4	5	6	
3 PLU GROUP			1	2	3	
4 SERVER GROUP			0	00	ENTR	
5 MESSAGE TEXT						
PREV. NEXT LIST P DOWN ▼						
PGM2 MIKE						0001 10:35AM

1. In the SETTING window, select "06 TEXT."
 - The TEXT window will appear.

2. Select any option from the following options list:

- | | |
|------------------|-----------------------|
| 1 FUNCTION TEXT: | Function text |
| 2 DEPT. GROUP: | Department group text |
| 3 PLU GROUP: | PLU group text |
| 4 SERVER GROUP: | Server group text |
| 5 MESSAGE TEXT: | Message text |

The following illustration shows those options included in the text programming group.

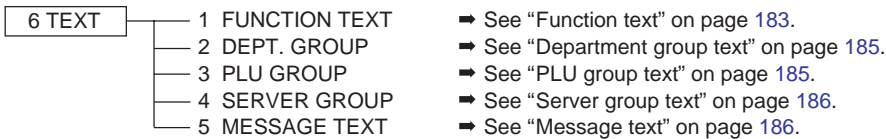

■ Function text

You can program a maximum of eight characters for each function by using the following table:

Procedure

FUNCTION TEXT	↓ P UP ▲	CAN	.	CL
001 NET1		CEL		
002 TAX1 ST		7	8	9
003 GRS TAX1				
004 RFD TAX1		4	5	6
005 TAX1				
006 TX1 EXPT		1	2	3
007 TAX2 ST				
008 GRS TAX2		0	00	ENTR
PGM2 MIKE	PREV. NEXT LIST P DOWN ▼			
				0001 10 35AM

The screen continues.

Function No.	Function	Default text
001	Net sales total	NET1
002	Net taxable 1 subtotal	TAX1 ST
003	Gross tax 1 total	GRS TAX1
004	Tax 1 total of refund entries	RFD TAX1
005	Net tax 1 total	TAX1
006	Exempt tax 1	TX1 EXPT
007	Net taxable 2 subtotal	TAX2 ST
008	Gross tax 2 total	GRS TAX2
009	Tax 2 total of refund entries	RFD TAX2
010	Net tax 2 total	TAX2
011	Exempt tax 2	TX2 EXPT
012	Net taxable 3 subtotal	TAX3 ST
013	Gross tax 3 total	GRS TAX3
014	Tax 3 total of refund entries	RFD TAX3
015	Net tax 3 total	TAX3
016	Exempt tax 3	TX3 EXPT
017	Net taxable 4 subtotal	TAX4 ST
018	Gross tax 4 total	GRS TAX4
019	Tax 4 total of refund entries	RFD TAX4
020	Net tax 4 total	TAX4
021	Exempt tax 4	TX4 EXPT
022	Net taxable 5 subtotal	TAX5 ST
023	Gross tax 5 total	GRS TAX5
024	Tax 5 total of refund entries	RFD TAX5
025	Net tax 5 total	TAX5
026	Exempt tax 5	TAX5 EXPT
027	Gross manual tax total	GRS MTAX
028	Refund manual tax total	RFD MTAX
029	Exempt total from GST	GST EXPT
030	PST total	PST TTL
031	GST total	GST TTL
032	Tax total	TTL TAX
033	Tax 1 forgiveness total	FS TX1
034	Tax 2 forgiveness total	FS TX2
035	Tax 3 forgiveness total	FS TX3
036	Cash benefit forgiveness1	CBNF TX1
037	Cash benefit forgiveness2	CBNF TX2
038	Cash benefit forgiveness3	CBNF TX3
039	Net	NET
040	Sales total including tax total	NET2
041	Coupon PLU	CP PLU
042	Vender Coupon UPC	V. CP UPC

Function No.	Function	Default text
043	Mix&Match Discount	DISCOUNT
044	Manager Void	MGR VD
045	VOID MODE	VOID
046	Hash Direct Void	HASH VD
047	Hash Past Void	HASH P.VD
048	Hash Refund	HASH RF
049	Hash Return	HASH RT
050	Vp Counter	VP CNT
051	Bill Counter	BILL CNT
052	Tray Counter	TRAY CNT
053	Guest Check Copy Counter	G.C. CNT
054	Drawer Counter	DRW CNT
055	Drawer Alarm	DRAWER ALARM
056	Trans Out	TRANS OUT
057	Trans In	TRANS IN
058	PBAL	***PBAL
059	Cover Count	COVER CT
060	Customer	TRANS CT
061	Net3 (Sales)	NET3
062	Mash Net Total	HASH TTL
063	Fs Change(Cash)	FS/CG
064	Cash Benefit Change(Cash)	CBNF/CG
065	Cash+Check In Drawer	CA+CH ID
066	Fs In Drawer	FS ID
067	Deposit	DEPOSIT
068	Deposit Refund	DPST RF
069	Tip Paid	TIP PAID
070	(+)Dept Total	*DEPT TL
071	(-)Dept Total	DEPT(-)
072	Hash (+)Dpt Total	*HASH TL
073	Hash (-)Dpt Total	*HASH(-)
074	Bottle (+)Dpt Total	*BTTL TL
075	Bottle (-)Dpt Total	*BTTL(-)
076	Gasoline (+)Dpt Total	*GAS TL
077	Gasoline (-)Dpt Total	GAS (-)
078	Subtotal	SUBTOTAL
079	Merchandize Subtotal	MDSE ST
080	Total	***TOTAL
081	Change	CHANGE
082	Due	DUE
083	Tip Due	TIP DUE
084	Tray Total	TRAY TL

■ Function text (continued)

Function No.	Function	Default text
085	Food Stamp Sales Total	FS SALE
086	Food Stamp Sales total by EBT	FS SALE EBT
087	Cash Benefit Sales Total	CBNF SALE
088	Food Stamp Sbtl	FS ST
089	Food Stamp/Cash benefit subtotal	FS/CBNF ST
090	Change(Food stamp)	FS CG
091	Voucher Purchase	FS VOUCHER
092	Food stamp refund by EBT	FS RFND EBT
093	Food stamp balance	FS BALANCE
094	Cash benefit balance	CBNF BALANCE
095	Cash back amount by cash benefit	CBNF CB
096	Items	ITEMS
097	Customer Charge	CHARGE
098	Balance	BALANCE
099	Copy Rcpt Title	COPY
100	G.C. Copy Titleg.C.Copy	G.C.COPY
101	B.T. Title	B. T.
102	B.S. Title	B. S.
103	Final Balance	FIN. BAL
104	Balance Forward	BAL FWD
105	Closed Check	CLOSE CK
106	Open Check	OPEN CK
107	Percent Of Net Sale	(%)SALES
108	Seat Number	SEAT#
109	Vat Exempt	VAT EXPT
110	Individual Payment	IND.PAY
111	Tare Weight	TARE WT.
112	Receipt Swicth	RCP S.W.
113	Free Glu	FREE GLU
114	Waste Title	WASTE
115	Average Sales	AVE SALE
116	St(-) TI	ST(-) TL
117	St % TI	ST % TL
118	Item(-) TI	(-) TL
119	Item % TI	% TL
120	Group Discount % TI	GDISC%TL
121	Gas Discount TI	GASDISTL
122	Cash TI	CASH TL
123	Ra TI	RA TL
124	Po TI	PO TL
125	Ca/Chk TI	CA/CK TL
126	Conv TI	CONV TL
127	Charge TI	CHR TL
128	Check TI	CHECK TL
129	PLU Repo:Combo	COMBO
130	PLU Repo:Waste	WASTE
131	PLU Repo:Rf	RF
132	PLU Repo:Cp	CP
133	PLU Repo:Net Sales	NET SLS
134	PLU Repo:Combo TI	COMBO TL
135	PLU Repo:Waste TI	WASTE TL
136	Pu Repo:Rf TI	RF TL
137	PLU Repo:Net TI	NET TL
138	Glu Text	TBL#
139	Server Sign-On Text	SIGN-ON
140	Server Sign-Off Text	SIGN-OFF
141	Gift Refund	GIFT RF
142	Gift Net Total	GIFT TTL

Function No.	Function	Default text
143	Gift Card Dpt Total	*GC TL
144	Gift Card Balance	GIFT BAL
145	Cash back amount by Cash	CB CA
146	Cash back amount by Cash2	CB CA2
147	Cash back amount by Cash3	CB CA3
148	Cash back amount by Cash4	CB CA4
149	Cash back amount by Cash5	CB CA5
150	Cash back amount by Caarge1	CB CHR1
151	Cash back amount by Caarge2	CB CHR2
152	Cash back amount by Caarge3	CB CHR3
153	Cash back amount by Caarge4	CB CHR4
154	Cash back amount by Caarge5	CB CHR5
155	Cash back amount by Caarge6	CB CHR6
156	Cash back amount by Caarge7	CB CHR7
157	Cash back amount by Caarge8	CB CHR8
158	Cash back amount by Caarge9	CB CHR9
159	Cash back amount by Check1	CB CHK1
160	Cash back amount by Check2	CB CHK2
161	Cash back amount by Check3	CB CHK3
162	Cash back amount by Check4	CB CHK4
163	Cash back amount by Check5	CB CHK5
164	Cash back amount by Check6	CB CHK6
165	Cash back amount by Check7	CB CHK7
166	Cash back amount by Check8	CB CHK8
167	Cash back amount by Check9	CB CHK9
168	Cash back title	CASH BACK
169	Cash back total	CB TL
170	Change + Cash Back amount display text	CG+CB
171	Scm(+)	SCM(+)
172	Scm(-)	SCM(-)
173	Scm Total	SCM TTL
174	Conversion1 Is	CONV1 IS
175	Conversion2 Is	CONV2 IS
176	Conversion3 Is	CONV3 IS
177	Conversion4 Is	CONV4 IS
178	Cash Is	CASH IS
179	Check1 Is	CHECK1 IS
180	Check2 Is	CHECK2 IS
181	Check3 Is	CHECK3 IS
182	Check4 Is	CHECK4 IS
183	Check5 Is	CHECK5 IS
184	Check6 Is	CHECK6 IS
185	Check7 Is	CHECK7 IS
186	Check8 Is	CHECK8 IS
187	Check9 Is	CHECK9 IS
188	Vender Coupon Is	V.CP UPC IS
189	Ccd	CCD
190	Ccd Differ	CCD DIF.
191	Ccd Differ Total	DIF. TL
192	Combo 1 (Trn.Rpt)	COMBO1
193	Combo 2 (Trn.Rpt)	COMBO2
194	Combo 3 (Trn.Rpt)	COMBO3
⋮	⋮	⋮
⋮	⋮	⋮
290	Combo 99 (Trn.Rpt)	COMBO99

■ Department group text

You can program a maximum of eight characters for each department group (1~9).

Procedure

Select the desired department group number from the department group list.



DEPT. GROUP1	P UP ▲	CAN	·	CL
DPT GR-1 <td></td> <td>CEL</td> <td></td> <td></td>		CEL		
		7	8	9
		4	5	6
		1	2	3
		0	00	ENTR
PREV. NEXT LIST P DOWN ▼				
PGM2 MIKE				0001
				A 10 37AM

Program the item as follows:

- **TEXT (Use the character entry method)**

Description for the department group. Up to 12 characters can be entered.

■ PLU group text

You can program a maximum of eight characters for each PLU group (1~99).

Procedure

Select the desired PLU group number from the PLU group list.



PLU GROUP01	P UP ▲	CAN	·	CL
PLU GRO1		CEL		
		7	8	9
		4	5	6
		1	2	3
		0	00	ENTR
PREV. NEXT LIST P DOWN ▼				
PGM2 MIKE				0001
				A 10 38AM

Program the item as follows:

- **TEXT (Use the character entry method)**

Description for the PLU group. Up to 12 characters can be entered.

■ Server group text

You can program a maximum of eight characters for each server group (1~9).

Procedure

Select the desired server group no. from the server groups list.



SERVER GROUP1		P UP ▲	CAN	.	CL
GROUP1			CEL		
			7	8	9
			4	5	6
			1	2	3
			0	00	ENTR
PREV.	NEXT	LIST	P DOWN ▼		
PGM2	MIKE				0001
			A	10	39AM

Program the item as follows:

- **TEXT (Use the character entry method)**

Description for the server group. Up to 12 characters can be entered.

■ Message text

You can program a message consisting of a maximum of 16 characters for each remote printer.

Select the desired message no. from the message list.



MESSAGE1		P UP ▲	CAN	.	CL
TEXT	MESSAGE 1		CEL		
REMOTE PRINTER		0	7	8	9
PRINT LOCATION	TOP		4	5	6
			1	2	3
			0	00	ENTR
PREV.	NEXT	LIST	P DOWN ▼		
PGM2	MIKE				0001
			A	10	40AM

Program each item as follows:

- **TEXT (Use the character entry method)**

Description for a remote printer message. Up to 16 characters can be entered.

- **REMOTE PRINTER (Use the numeric entry method)**

Remote printer number (1 - 9/0)

- **PRINT LOCATION (Use the selective entry method)**

TOP: Prints the message at the top of a remote printer receipt.

BOTTOM: Prints the message at the bottom of a remote printer receipt.

Personnel Programming

Use the following procedure for personnel programming:

■ Server

Procedure

SETTING	P UP	▲	CAN	CEL	.	CL
01 ARTICLE						
02 DIRECT KEY			7	8	9	
03 PLU MENU KEY						
04 FUNCTION			4	5	6	
05 MEDIA						
06 TEXT			1	2	3	
07 PERSONNEL						
08 TERMINAL			0	00	ENTR	
PREV.	NEXT	LIST	P DOWN	▼		
PGM2 MIKE					0001	
					10 41AM	



PERSONNEL	P UP	▲	CAN	CEL	.	CL
1 SERVER						
2 MANAGER			7	8	9	
			4	5	6	
			1	2	3	
			0	00	ENTR	
PREV.	NEXT	LIST	P DOWN	▼		
PGM2 MIKE					0001	
					10 41AM	



SERVER	P UP	▲	CAN	CEL	.	CL
0001 MIKE						
0002 JACK			7	8	9	
0003 SUE						
0004 SERV.004			4	5	6	
0005 SERV.005						
0006 SERV.006			1	2	3	
0007 SERV.007						
0008 SERV.008			0	00	ENTR	
PREV.	NEXT	LIST	P DOWN	▼		
PGM2 MIKE					0001	
					10:43AM	



SECRET CODE	P UP	▲	CAN	CEL	.	CL
SECRET CODE						
NAME	SERV.005		7	8	9	
ENTRY	NON-COMPULSORY					
G.C.COPY	ENABLE		4	5	6	
DRAWER#	1					
NET SALES%	0.00%		1	2	3	
			0	00	ENTR	
PREV.	NEXT	LIST	P DOWN	▼		
PGM2 MIKE					0001	
					10:43AM	

1. In the SETTING window, select "07 PERSONNEL."
 - The PERSONNEL window will appear.

2. Select the "SERVER".
 - The SEVER window will appear.

3. Select the server name.

Program each item as follows:

- **SECRET CODE (Use the numeric entry method)**
Secret code (max. 4 digits: 0001 to 9999/0000)
- **NAME (Use the character entry method)**
Name for the server. Up to 12 characters can be entered.
- **ENTRY (Use the selective entry method)**
GLU(PBLU): Compulsory GLU(PBLU)
NON-COMPULSORY: Non-compulsory GLU(PBLU)
- **G.C.COPY (Use the selective and method)**
ENABLE: Enables G.C.Copy.
DISABLE: Disables G.C.Copy.
- **DRAWER# (Use the numeric entry method)**
Drawer number (1 or 2/0)
- **NET SALES% (Use the numeric entry method)**
Net sales percent rate
(max. 5 digits, 0.00 to 100.00)

■ Manager

Procedure

SETTING	P UP ▲	CAN	CEL	.	CL
01 ARTICLE		CEL		.	CL
02 DIRECT KEY		7	8	9	
03 PLU MENU KEY		4	5	6	
04 FUNCTION		1	2	3	
05 MEDIA		0	00	ENTR	
06 TEXT					
07 PERSONNEL					
08 TERMINAL					
PREV. NEXT LIST P DOWN ▼					

PGH2 1:47PM



PERSONNEL	P UP ▲	CAN	CEL	.	CL
1 SERVER		CEL		.	CL
2 MANAGER		7	8	9	
		4	5	6	
		1	2	3	
		0	00	ENTR	
PREV. NEXT LIST P DOWN ▼					

PGH2 1:47PM



MANAGER	P UP ▲	CAN	CEL	.	CL
---NOTHING---		CEL		.	CL
		7	8	9	
		4	5	6	
		1	2	3	
		0	00	ENTR	
PREV. NEXT LIST P DOWN ▼					

PGH2 1:49PM



01	P UP ▲	CAN	CEL	.	CL
SECRET CODE	1234	CEL		.	CL
		7	8	9	
		4	5	6	
		1	2	3	
		0	00	ENTR	
PREV. NEXT LIST P DOWN ▼					

PGH2 1:50PM

1. In the SETTING window, select "07 PERSONNEL."
 - The PERSONNEL window will appear.

2. Select the "MANAGER".
 - The MANAGER window will appear.

3. Select or enter the manager code.

4. Program the item as follows:
 - SECRET CODE (Use the numeric entry method)
Secret code (max. 4 digits: 0001 to 9999/0000)

Terminal Programming

Use the following procedure for terminal programming:

Procedure

SETTING	P UP	▲	CAN	CEL	.	CL
01 ARTICLE			7	8	9	
02 DIRECT KEY			4	5	6	
03 PLU MENU KEY			1	2	3	
04 FUNCTION			0	00	ENTR	
05 MEDIA						
06 TEXT						
07 PERSONNEL						
08 TERMINAL						
PREV.	NEXT	LIST	P DOWN	▼		
PGM2	MIKE					0001
						10 45AM



TERMINAL	P UP	▲	CAN	CEL	.	CL
1 MACHINE#			7	8	9	
2 CONSECUTIVE#			4	5	6	
3 INTERVAL TIMER			1	2	3	
4 DEFAULT MENU LEVEL			0	00	ENTR	
5 AVAILABLE GLU#						
6 BILL NUMBER						
7 BRIGHTNESS						
PREV.	NEXT	LIST	P DOWN	▼		
PGM2	MIKE					0001
						10 46AM

1. In the SETTING window, select “08 TERMINAL.”
 - The TERMINAL window will appear.

2. Select any option from the following options list:

1 MACHINE#:	Machine number
2 CONSECUTIVE#:	Consecutive number
3 INTERVAL TIMER:	Interval timer
4 DEFAULT MENU LEVEL:	Default menu level
5 AVAILABLE GLU#:	Available GLU code
6 BILL NUMBER:	Bill number
7 BRIGHTNESS:	Brightness of the LCD display

The following illustration shows those options included in the terminal programming group.

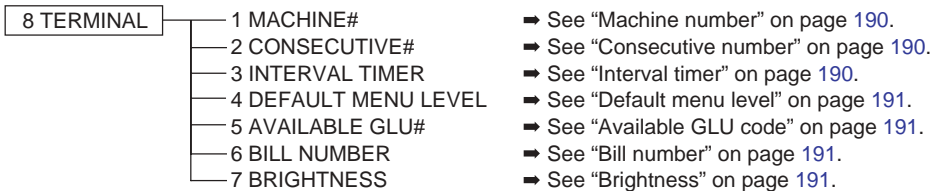

■ Machine number

When your store has two or more POS terminals, it is practical to assign unique machine numbers to them for identification.

Procedure

MACHINE#	P UP ▲	CAN CEL	.	CL
MACHINE#	000000			
		7	8	9
		4	5	6
		1	2	3
		0	00	ENTR
PREV. NEXT LIST P DOWN ▼				
PGM2 MIKE			0001	
			10:46AM	

Program the item as follows:

- **MACHINE# (Use the numeric entry method)**
Machine number (max. 6 digits: 0 to 999999)

■ Consecutive number

The consecutive number is increased by one each time a receipt is issued.

Procedure

CONSECUTIVE#	P UP ▲	CAN CEL	.	CL
CONSECUTIVE#	0000			
		7	8	9
		4	5	6
		1	2	3
		0	00	ENTR
PREV. NEXT LIST P DOWN ▼				
PGM2 MIKE			0001	
			10:48AM	

Program the item as follows :

- **CONSECUTIVE# (Use the numeric entry method)**
Enter a number (max. 4 digits: 0 to 9999) that is one less than the desired starting number.

■ Interval timer

You can program the timer for THE TILL TIMER, the screen save mode timer and the drawer alarm timer.

Procedure

INTERVAL TIMER	P UP ▲	CAN CEL	.	CL
TILL TIMER	000			
SCREEN SAVE	00			
DRAWER ALARM	000			
		7	8	9
		4	5	6
		1	2	3
		0	00	ENTR
PREV. NEXT LIST P DOWN ▼				
PGM2 MIKE			0001	
			10:48AM	

Program each item as follows :

- **TILL TIMER (Use the numeric entry method)**
The POS terminal counts the number of times the drawer is left open for longer than a programmed time limit. The counter will be incremented by one each time a programmed time limit is reached. The time limit for TILL TIMER can be preset to 0-255 seconds. The count is printed on the transaction report and server report. If the number "0" is entered, this function is unavailable.
- **SCREEN SAVE (Use the numeric entry method)**
Screen save mode timer (max. 2 digits : 0 to 99 minutes)
If the number "0" is entered, the POS terminal will turn off the display after the POS terminal remains idle.
- **DRAWER ALARM (Use the numeric entry method)**
Length of alarm time with drawer opening (0 to 255 seconds)
 - Your POS terminal monitors how long the drawer is kept open from the moment the drawer is opened at the end of a transaction in the REG/VOID mode. It stops time counting when a valid key (except the [TAX], [BILL], and [RCPT] keys) is pressed for the next transaction. It restarts time counting after that transaction is ended. You can stop the buzzer alarm by closing the drawer. No key entries can be made while the buzzer is sounding. If the number "0" is entered, this function will be unavailable.

■ Default menu level

You can preset the menu level to be returned after item entry.

Procedure

DEFAULT MENU LEVEL		P UP ▲	CAN CEL	.	CL
DEFAULT MENU LEVEL			7	8	9
			4	5	6
			1	2	3
			0	00	ENTR
PREV.	NEXT	LIST	P DOWN ▼		
PGM2	MIKE				0001
					10:50AM

Program the item as follows:

- **DEFAULT MENU LEVEL (Use the numeric entry method)**
Default menu level (1 to 5)

■ Available GLU code

You can specify the range of GLU numbers available for each terminal.

Procedure

AVAILABLE GLU#		P UP ▲	CAN CEL	.	CL
START CODE	0001		7	8	9
END CODE	9999		4	5	6
			1	2	3
			0	00	ENTR
PREV.	NEXT	LIST	P DOWN ▼		
PGM2	MIKE				0001
					10 51AM

Program the item as follows:

- **START CODE (Use the numeric entry method)**
Start GLU/PBLU code (max. 4 digits: 1 to 9999)
- **END CODE (Use the numeric entry method)**
End GLU/PBLU code (max. 4 digits: 1 to 9999)

■ Bill number

A consecutive bill number is automatically increased each time a GLU entry is finalized.

Procedure

BILL NUMBER		P UP ▲	CAN CEL	.	CL
BILL NUMBER	0000		7	8	9
			4	5	6
			1	2	3
			0	00	ENTR
PREV.	NEXT	LIST	P DOWN ▼		
PGM2	MIKE				0001
					10:53AM

Program the item as follows:

- **BILL NUMBER (Use the numeric entry method)**
Enter a number (max. 4 digits: 0 to 9999) that is one less than the desired starting number.

■ Brightness

You can adjust the brightness of the LCD.

Procedure

BRIGHTNESS		P UP ▲	CAN CEL	.	CL
BRIGHTNESS	00		7	8	9
			4	5	6
			1	2	3
			0	00	ENTR
PREV.	NEXT	LIST	P DOWN ▼		
PGM2	MIKE				0001
					10:54AM

- **BRIGHTNESS (Use the numeric entry Method)**
Brightness of the LCD (0 to 13)
"13" is the brightest.

Date/Time Setting

Use the following procedure to set the date and time:

■ Date/time

You can set the date and time for the POS terminal.

Procedure

SETTING	↑ ↓	P UP ▲	CAN	CEL	.	CL
09 DATE/TIME			7	8	9	
10 OPTIONAL			4	5	6	
11 SECRET CODE			1	2	3	
12 REPORT			0	00	ENTR	
13 LOGO TEXT						
14 DEVICE CONFIG						
15 GLU CODE						
16 CUSTOMER						
PREV.	NEXT	LIST	P DOWN ▼			
PGM2	MIKE				0001	
					10 55AM	



DATE/TIME	P UP ▲	CAN	CEL	.	CL
DATE	010100	7	8	9	
TIME	0000	4	5	6	
		1	2	3	
		0	00	ENTR	
PREV.	NEXT	LIST	P DOWN ▼		
PGM2	MIKE				0001
					12:00AM

1. In the SETTING window, select "09 DATE/TIME."
 - The DATE/TIME window will appear.

2. Set each item as follows:
 - **DATE (Use the numeric entry method)**
Enter the month (2 digits), day (2 digits), and year (2 digits) in this sequence.

- **TIME (Use the numeric entry method)**
Set the time (max. 4 digits) on the military time (24-hour) system. For example, to set 2:30 AM, enter 0230; and to set 2:30 PM, enter 1430. The time will be printed and displayed on the real-time system. Once you set the time, the internal clock will continue to run until the battery goes dead and also update the date (month, day, year) when required.

Optional Feature Selection

Use the following procedure to select an optional feature :

Procedure

SETTING	↑↓	P UP ▲	CAN	CEL	.	CL
09 DATE/TIME						
10 OPTIONAL			7	8	9	
11 SECRET CODE						
12 REPORT			4	5	6	
13 LOGO TEXT						
14 DEVICE CONFIG			1	2	3	
15 GLU CODE						
16 CUSTOMER			0	00	ENTR	
PREV. NEXT LIST P DOWN ▼						
PGM2 MIKE					0001	
					10:31AM	



OPTIONAL	P UP ▲	CAN	CEL	.	CL
1 FUNC. PROHIBIT					
2 FUNC. SELECT1			7	8	9
3 FUNC. SELECT2			4	5	6
4 PRINT SELECT			1	2	3
			0	00	ENTR
PREV. NEXT LIST P DOWN ▼					
PGM2 MIKE					0001
					10:31AM

1. In the SETTING window, select “10 OPTIONAL.”

- The OPTIONAL window will appear.

2. Select any option from the following options list:

- 1 FUNC.PROHIBIT: Function prohibition
- 2 FUNC.SELECT1: Function selection 1
- 3 FUNC.SELECT2: Function selection 2
- 4 PRINT SELECT: Printing selection

The following illustration shows the optional feature options.

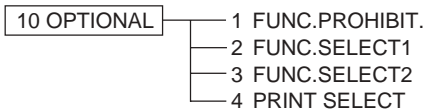

- ➔ See “Function prohibition” on page 194.
- ➔ See “Function selection 1” on page 196.
- ➔ See “Function selection 2” on page 197.
- ➔ See “Printing selection” on page 199.

■ Function prohibition

Your POS terminal allows you to select whether to enable or disable various functions.

Procedure

FUNC. PROHIBIT	↓	P	UP	▲	CAN	·	CL
OPX/Z REPORT				ENABLE	CEL		
PAID OUT				PUBLIC	7	8	9
RFND SALES				PUBLIC			
REFUND/RETURN				PUBLIC	4	5	6
1st LAST VOID				ENABLE			
DIRECT VOID				PUBLIC	1	2	3
INDIRECT VOID				PUBLIC			
SUBTOTAL VOID				PUBLIC	0	00	ENTR
PREV.	NEXT	LIST	P	DOWN			
PGM2	MIKE						0001
							10:32AM

The screen continues.

Program each item as follows:

- **OPX/Z REPORT (Use the selective entry method)**
 - DISABLE: Disables server report printing in the OP X/Z mode.
 - ENABLE: Enables server report printing in the OP X/Z mode.
- **PAID OUT (Use the selective entry method)**
 - LIMITED: Only available to the manager.
 - PUBLIC: Available to the manager and servers/cashiers.
- **RFND SALES (Use the selective entry method)**
 - LIMITED: Only available to the manager.
 - PUBLIC: Available to the manager and servers/cashiers.
- **REFUND/RETURN (Use the selective entry method)**
 - LIMITED: Only available to the manager.
 - PUBLIC: Available to the manager and servers/cashiers.
- **1st LAST VD (Use the selective entry method)**
 - DISABLE: Disables first-item direct void.
 - ENABLE: Enables first-item direct void.
- **DIRECT VD (Use the selective entry method)**
 - LIMITED: Only available to the manager.
 - PUBLIC: Available to the manager and servers/cashiers.
- **INDIRECT VD (Use the selective entry method)**
 - LIMITED: Only available to the manager.
 - PUBLIC: Available to the manager and servers/cashiers.
- **SBTL VOID (Use the selective entry method)**
 - LIMITED: Only available to the manager.
 - PUBLIC: Available to the manager and servers/cashiers.
- **VOID MODE (Use the selective entry method)**
 - LIMITED: Only available to the manager.
 - PUBLIC: Available to the manager and servers/cashiers.
- **NO SALE (Use the selective entry method)**
 - LIMITED: Only available to the manager.
 - PUBLIC: Available to the manager and servers/cashiers.
- **PAY WHEN ST=0 (Use the selective entry method)**
 - DISABLE: Disables finalization in the REG mode when the subtotal is zero.
 - ENABLE: Enables finalization in the REG mode when the subtotal is zero.
- **TIP PAID (Use the selective entry method)**
 - LIMITED: Only available to the manager.
 - PUBLIC: Available to the manager and servers/cashiers.
- **TRANS IN/OUT (Use the selective entry method)**
 - LIMITED: Only available to the manager.
 - PUBLIC: Available to the manager and servers/cashiers.

■ Function prohibition (continued)

- **INDIRECT VOID (GLU) (Use the selective entry method)**

- DISABLE: Disables indirect void/refund/return entry in GLU re-order.

- ENABLE: Enables indirect void/refund/return entry in GLU re-order.

- **OPEN GLU DISPLAY (Use the selective entry method)**

- DISABLE: Does not display currently opened GLU automatically.

- ENABLE: Displays and recalls the balances of currently opened GLU automatically.

- **UPC LEARNING (Use the selective entry method)**

- DISABLE: Disables the UPC learning function.

- ENABLE: Enables the UPC learning function.

- **PRICE CHANGE (Use the selective entry method)**

- LIMITED: Only available to the manager.

- PUBLIC: Available to the manager and servers/cashiers.

- **CUSTOMER LEARNING (Use the selective entry method)**

- ENABLE: Only available to the manager.

- DISABLE: Available to the manager and servers/cashiers.

- **CUSTOMER TEL# (Use the selective entry method)**

- DISABLE: Disables the learning function of customer telephone numbers.

- ENABLE: Enables the learning function of customer telephone numbers.

■ Function selection 1

Your POS terminal enables you to select various functional settings.

Program each item as follows:

Procedure

FUNC.SELECT1	↓ P UP ▲	CAN	CEL	.	CL
ITEM VP	ENABLE				
RF/RT VP	NON-COMPULSORY	7	8	9	
(-) VP	NON-COMPULSORY				
CA/CHK VP	NON-COMPULSORY	4	5	6	
RA VP	NON-COMPULSORY				
PO VP	NON-COMPULSORY	1	2	3	
TIP VP	NON-COMPULSORY				
LEVEL SHIFT TYPE	AUTO	0	00	ENTR	
PREV. NEXT LIST P DOWN ▼					0001
PGH2 HIKE					10 35AM

The screen continues.

- **ITEM VP (Use the selective entry method)**

DISABLE: Disables item validation printing.

ENABLE: Enables item validation printing.

- **RF/RT VP (Use the selective entry method)**

COMPULSORY: Compulsory refund/return validation printing.

NON-COMPULSORY: Non-compulsory refund/return validation printing.

- **(-) VP (Use the selective entry method)**

COMPULSORY: Compulsory minus entry validation printing.

NON-COMPULSORY: Non-compulsory minus entry validation printing.

- **CA/CHK VP (Use the selective entry method)**

COMPULSORY: Compulsory cashing a check validation printing.

NON-COMPULSORY: Non-compulsory cashing a check validation printing.

- **RA VP (Use the selective entry method)**

COMPULSORY: Compulsory RA validation printing.

NON-COMPULSORY: Non-compulsory RA validation printing.

- **PO VP (Use the selective entry method)**

COMPULSORY: Compulsory PO validation printing.

NON-COMPULSORY: Non-compulsory PO validation printing.

- **TIP VP (Use the selective entry method)**

COMPULSORY: Compulsory tip validation printing.

NON-COMPULSORY: Non-compulsory tip validation printing.

- **LEVEL SHIFT TYPE (Use the selective entry method)**

MANUAL: Lock shift mode

AUTO: Automatic return mode

- **LEVEL SHIFT (Use the selective entry method)**

LIMITED: Only available to the manager.

PUBLIC: Available to the manager and servers/cashiers.

- **PRICE SHIFT TYPE (Use the selective entry method)**

MANUAL: Lock shift mode

AUTO: Automatic return mode

- **PRICE SHIFT (Use the selective entry method)**

LIMITED: Only available to the manager.

PUBLIC: Available to the manager and servers/cashiers.

- **RETURN TO LEVEL1 <Return to level 1>**

- (Use the selective entry method)

When the PLU level shift system is set to "AUTO," the PLU level can be returned to level 1 by one of the following methods:

RECEIPT: Returns the PLU level to level 1 by one receipt.

BY ITEM: Returns the PLU level to level 1 by one item.

- **RETURN TO PRICE1 <Return to price 1> (Use the selective entry method)**

When the PLU price level shift method is set to "AUTO," the price level can be returned to price 1 by one of the following methods:

RECEIPT: Returns the price level to price 1 by one receipt.

BY ITEM: Returns the price level to price 1 by one item.

■ Function selection 2

Your POS terminal enables you to select various functional settings.

Program each item as follows:

Procedure

FUNC_SELECT2		↓ P UP ▲	CAN	.	CL
SEAT#		INHIBIT	CEL		
COVER CT	NON-COMPULSORY		7	8	9
TIP ENTRY	AMOUNT		4	5	6
SERVER DRAWER	INHIBIT		1	2	3
SHIFT KEY ACTION	CAPS		0	00	ENTR
AUTO HOURLY	DISABLE				
CONDIMENT CANCEL	PUBLIC				
ISBN PRICE	COMPULSORY				
PREV. NEXT LIST P DOWN ▼					
PGH2 MIKE					0001 10 38AM

The screen continues.

- **SEAT # (Use the selective entry method)**

COMPULSORY: Compulsory seat number entry (GLU operations)
INHIBIT: Inhibited seat number entry (GLU operations)

- **COVER CT (Use the selective entry method)**

COMPULSORY: Compulsory cover count entry (GLU operations)
NON-COMPULSORY: Non-compulsory cover count entry (GLU operations)

- **TIP ENTRY (Use the selective entry method)**

FIX RATE: Tip entry using a programmed rate
AMOUNT: Manual tip entry

- **SERVER DRAWER (Use the selective entry method)**

COMPULSORY: Compulsory server drawer assignment at sign-on
INHIBIT: Inhibits server drawer assignment at sign-on

- **SHIFT KEY ACTION (Use the selective entry method)**

CAPS: Locks the upper-case letter mode once the shift key is pressed.
SHIFT: Shifts the upper-case letter mode to the lower-case letter mode after an letter is entered.

- **AUTO HOURLY (Use the selective entry method)**

DISABLE: Disables automatic hourly reporting.
ENABLE: Enables automatic hourly reporting.
If "ENABLE" is selected, an hourly report is issued at hourly intervals automatically.

- **CONDIMENT. CANCEL (Use the selective entry method)**

LIMITED: Cancel operation is only available to the manager.
PUBLIC: Cancel operation is available to the manager and servers/cashiers.

- **ISBN PRICE (Use the selective entry method)**

Price entry after ISBN/ISSN code entry INHIBIT/COMPULSORY
COMPULSORY: Compulsory price entry after ISBN/ISSN code entry.
INHIBIT: Inhibits price entry after ISBN/ISSN code entry.

- **CUSTOMER DATA (Use the selective entry method)**

TOTAL: Sales total and charge sales total
DETAIL: Detail data (Sales total, charge sales total, sales date, item's name, amount and quantity)

- **SERVER POPUP (Use the selective entry method)**

DISABLE: Opens the SERVER POPUP sign on window upon 1st item entry.
ENABLE: Does not open the SERVER POPUP sign on window upon 1st item entry.

■ Function selection 2 (continued)

- **T-LOG FULL (Use the selective entry method)**

LOCK: Locks entries at a terminal when T-LOG buffer becomes full.

CONTINUE: Does not lock entries at a terminal even when T-LOG buffer becomes full.

- **E.J. FULL (Use the selective entry method)**

LOCK: Locks entries at a terminal when E.J. buffer becomes full.

CONTINUE: Does not lock entries at a terminal even when E.J. buffer becomes full.

- **CAPTURE FUL (Use the selective entry method)**

LOCK: Locks entries at a terminal when CAPTURE job memory becomes full.

CONTINUE: Not locks entries at a terminal even when CAPTURE job memory becomes full.

■ Printing selection

You can program various printing functions.

Procedure

PRINT SELECT	↓	P UP	▲	CAN	·	CL
PURCHASE No.			NO	CEL		
TIME			YES	7	8	9
JOURNAL SELECT			FULL	4	5	6
JOURNAL SIZE			NORMAL			
ITEM ON BILL			YES	1	2	3
SHARE%			YES			
REORDER KP MESSAGE			YES			
CUSTOMER REPORT			CHARGE	0	00	ENTR
PGH2	MIKE					0001
						10 39AM

The screen continues.

Program each item as follows:

- **PURCHASE NO. (Use the selective entry method)**
 - YES : Prints the purchase number.
 - NO : Does not print the purchase number.
- **TIME (Use the selective entry method)**
 - NO : Does not print the time on the receipt and journal.
 - YES : Prints the time on the receipt and journal.
- **JOURNAL SELECT (Use the selective entry method)**
 - PARTIAL: Prints summary information on the journal.
 - FULL: Prints detailed information on the journal.
- **JOURNAL SIZE (Use the selective entry method)**
 - NORMAL: Prints normal-size letters on the journal.
 - SMALL: Prints compressed-size letters on the journal.
- **ITEM ON BILL (Use the selective entry method)**
 - NO : Does not print items in a GLU/PBLU transaction on the bill printer.
 - YES : Prints items in a GLU/PBLU transaction on the bill printer.
- **SHARE% (Use the selective entry method)**
 - NO : Does not print the share percent in the department report.
 - YES : Prints the share percent in the department report.
- **REORDER KP MESSAGE (Use the selective entry method)**
 - YES : Prints the reorder message on a kitchen printer.
 - NO : Does not print the reorder message on a kitchen printer.
- **CUSTOMER REPORT (Use the selective entry method)**
 - Non-payment customer report format
 - DETAIL: Detail data
 - CHARGE: Charge amount data
- **BIRTHDAY (Use the selective entry method)**
 - YES : Prints the entered birthday.
 - NO : Does not print entered birthday.
- **TAX STATUS RJ (Use the selective entry method)**
 - Taxable status printing on the receipt and journal.
 - (YES/NO)
- **TAX STATUS BILL (Use the selective entry method)**
 - Taxable status printing on bill (slip)
 - (YES/NO)
- **TAX STATUS KP (Use the selective entry method)**
 - Taxable status printing on a kitchen printer
 - (YES/NO)

■ Printing selection (continued)

- **CUST. CODE&NAME KP (Use the selective entry method)**

YES : Prints the customer code and name on a kitchen printer (bill/slip).

NO : Does not print the customer code and name on a kitchen printer.

- **CUST. ADDRESS KP (Use the selective entry method)**

YES : Prints the customer address on a kitchen printer (bill/slip).

NO : Does not print the customer address on a kitchen printer.

- **CUST. TELEPHONE# KP (Use the selective entry method)**

YES : Prints the customer telephone number on a kitchen printer (bill/slip).

NO : Does not print the customer telephone number on a kitchen printer.

Secret Code Programming

Use the following procedure to program a secret code:

Procedure

SETTING	↑↓	P UP	▲	CAN	CEL	.	CL
10 OPTIONAL							
11 SECRET CODE				7	8	9	
12 REPORT							
13 LOGO TEXT				4	5	6	
14 DEVICE CONFIG							
15 GLU CODE				1	2	3	
16 CUSTOMER							
17 NEGATIVE#				0	00	ENTR	
PREV.	NEXT	LIST	P DOWN				
PGM2	MIKE					0001	
						10:40AM	



SECRET CODE	P UP	▲	CAN	CEL	.	CL
1 Z1						
2 PGM2						
3 SYSTEM Z1				7	8	9
4 SYSTEM PGM2						
5 INITIAL D/L				4	5	6
6 MAINTENANCE D/L						
7 AUTO KEY				1	2	3
				0	00	ENTR
PREV.	NEXT	LIST	P DOWN			
PGM2	MIKE					0001
						10:40AM

1. In the SETTING window, select “11 SECRET CODE.”

- The SECRET CODE window will appear.

2. Select any option from the following options list:

- 1 Z1: Z1 reports
- 2 PGM2: PGM2 operations
- 3 SYSTEM Z1: System Z1 reports
- 4 SYSTEM PGM2: System PGM2 operations
- 5 INITIAL D/L: Initial down-loading
- 6 MAINTENANCE. D/L: Maintenance down-loading
- 7 AUTO KEY: Auto keys

The following illustration shows those options included in the secret code programming group.

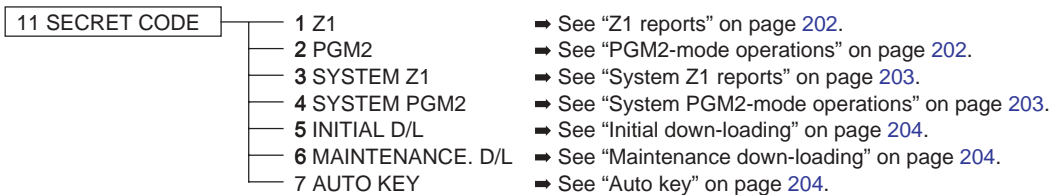

Z1 reports

You can assign a secret code to each report.

Secret code: max. 4 digits (0001 to 9999/0000) (Use the numeric entry method)

NOTE If "0" is entered, the "compulsory secret code entry" will be canceled.

Z1	↓ P UP ▲	CAN	·	CL
DEPARTMENT	0000	CEL		
PLU	0000	7	8	9
PLU BY DEPT	0000			
DYNAMIC UPC	0000	4	5	6
D-UPC BY DEPT	0000			
TRANSACTION	0000	1	2	3
POSITIVE#	0000			
ALL SERVER	0000	0	00	ENTR
PREV. NEXT LIST P DOWN ▼				0001
PGM2 MIKE				10 41AM

The screen continues.

Program each item as follows:

DEPARTMENT	Department report
PLU	PLU report
PLU BY DEPT	PLU by department report
DYNAMIC UPC	Dynamic UPC report
D-UPC BY DEPT	Dynamic UPC by department report
TRANSACTION	Transaction report
POSITIVE#	Positive number report
ALL SERVER	All server report
IND. SERVER	Individual server report
HOURLY	Hourly report
GLU	GLU report
GLU BY SERVER	GLU by server report
CLOSED GLU	Closed GLU report
CL-GLU BY SERVER	Closed GLU by server report
STACKED REPORT	Stacked report
NON ACCESS UPC	Non-access UPC
D-UPC CLEAR	Dynamic UPC clear report
D-UPC CLR DEPT	Dynamic UPC clear by dept. report
EFT	EFT
ACCT BAL SYS	Balance of account (system)
E.JOURNAL	Electronic journal

PGM2-mode operations

You can assign a secret code to each programming operation in the PGM2 mode.

Secret code: max. 4 digits (0001 to 9999/0000) (Use the numeric entry method)

NOTE If "0" is entered, the "compulsory secret code entry" will be canceled.

PGM2	↓ P UP ▲	CAN	·	CL
ARTICLE	0000	CEL		
DIRECT KEY	0000	7	8	9
PLU MENU KEY	0000			
FUNCTION	0000	4	5	6
MEDIA	0000			
TEXT	0000	1	2	3
PERSONNEL	0000			
TERMINAL	0000	0	00	ENTR
PREV. NEXT LIST P DOWN ▼				0001
PGM2 MIKE				10 43AM

The screen continues.

Program each item as follows:

ARTICLE	Article programming
DIRECT KEY	Direct key programming
PLU MENU KEY	PLU menu key programming
FUNCTION	Function programming
MEDIA	Media programming
TEXT	Text programming
PERSONNEL	Personnel programming
TERMINAL	Terminal programming
DATE/TIME	Date/time programming
OPTIONAL	Optional programming
SECRET CODE	Secret code programming
REPORT	Report programming
LOGO TEXT	Logo programming
DEVICE CONFIG	Device configuration programming
GLU CODE	GLU code programming
TAX	Tax programming
CUSTOMER	Customer programming
NEGATIVE#	Negative number programming
POSITIVE#	Positive number programming
MACRO KEY	Macro key programming
FUNCTION KEY	Function menu key programming
CAPTURE KEY	Capture key programming
CAPTURE JOB#	Capture job programming
TRAINING	Training mode
DATA SEND	Backup data send
DATA RECEIVE	Backup data receive

System Z1 reports

You can assign a secret code to each system report.

Secret code: max. 4 digits (0001 to 9999/0000) **(Use the numeric entry method)**

NOTE If "0" is entered, the "compulsory secret code entry" will be canceled.

SYSTEM Z1	P UP	CAN	.	CL
DEPARTMENT	0000	CEL	.	CL
PLU	0000	7	8	9
PLU BY DEPT	0000			
DYNAMIC UPC	0000	4	5	6
D-UPC BY DEPT	0000			
TRANSACTION	0000	1	2	3
POSITIVE#	0000			
ALL SERVER	0000	0	00	ENTR
PREV. NEXT LIST P DOWN				
PGH2 MIKE				0001 10:45AM

The screen continues.

Program each item as follows:

DEPARTMENT	Department report
PLU	PLU report
PLU BY DEPT	PLU by department report
DYNAMIC UPC	Dynamic UPC report
D-UPC BY DEPT	Dynamic UPC by department report
TRANSACTION	Transaction report
POSITIVE#	Positive number report
ALL SERVER	All server report
IND. SERVER	Individual server report
HOURLY	Hourly report
GLU	GLU report
GLU BY SERVER	GLU by server report
CLOSED GLU	Closed GLU report
CL-GLU BY SERV	Closed GLU by server report
STACKED REPORT	Stacked report
NON ACCESS UPC	Non-access UPC report
D-UPC CLEAR	Dynamic UPC clear report
D-UPC CLEAR DEPT	Dynamic UPC clear by department report
E.JOURNAL	Electronic journal

System PGM2-mode operations

You can assign a secret code to each system programming operation in the PGM2 mode.

Secret code: max. 4 digits (0001 to 9999/0000) (Use the numeric entry method)

NOTE If "0" is entered, the "compulsory secret code entry" will be canceled.

SYSTEM PGM2	P UP	CAN	.	CL
DATA CLEAR	0000	CEL	.	CL
KP SETTING	0000	7	8	9
ONLINE SETTING	0000			
CVM SETTING	0000	4	5	6
EFT SETTING	0000			
ACCT SETTING	0000	1	2	3
MWS SETTING	0000			
INLINE SETTING	0000	0	00	ENTR
PREV. NEXT LIST P DOWN				
PGH2 MIKE				0001 10:47AM

Program each item as follows:

DATA CLEAR	Data clear operation
KP SETTING	Kitchen printer setting
ONLINE SETTING	Online setting
CVM SETTING	CVM setting
EFT SETTING	EFT setting
ACCT SETTING	Account setting
MWS SETTING	Manager work station setting
INLINE SETTING	Inline setting

■ Initial down-loading (with clearing of memory)

You can assign a secret code to each preset data to be downloaded.

Secret code: max. 4 digits (0001 to 9999/0000) (Use the numeric entry method)

NOTE If "0" is entered, the "compulsory secret code entry" will be canceled.

INITIAL D/L	↓ P UP ▲	CAN	.	CL
DEPT	0000	CEL	.	CL
DIRECT KEY	0000	7	8	9
PLU/UPC	0000			
PLU MENU KEY	0000	4	5	6
LINK PLU	0000			
CONDIMENT	0000	1	2	3
MIX&MATCH	0000			
COMBO MEAL	0000			
PREV. NEXT LIST P DOWN ▼		0	00	ENTR
PGH2 MIKE				0001
				10 49AM

The screen continues.

Program each item as follows:

DEPT	Department preset
DIRECT KEY	Direct department/PLU preset
PLU/UPC	PLU/UPC preset
PLU MENU KEY	PLU menu key preset
LINK PLU	Link PLU preset
CONDIMENT	Condiment PLU preset
MIX&MATCH	Mix & Match preset
COMBO MEAL	Combo meal preset
UPC NON-PLU	UPC Non-PLU code format
TRANSACTION	Transaction preset
MANAGER	Manager preset
SERV. SIGN OFF	All server sign off
OPTION	Other preset
DATE/TIME	Date/time preset
LOGO	Logo text preset
DEF. MENU LEVEL	Default menu level
TAX	Tax preset
NEGATIVE#	Negative number preset
POSITIVE#	Positive number preset
MACRO KEY	Macro key preset
FUNC. MENU KEY	Function menu key preset
CAPTURE KEY	Capture key preset
CAPTURE JOB#	Capture job preset
ONLINE PRESET	Online preset
INLINE PRESET	Inline preset
KP PRESET	Kitchen printer preset
DEVICE CONFIG	Device configuration preset
ALL PGM	All PGM preset

■ Maintenance down-loading (without clearing of memory)

You can assign a secret code to each preset data to be downloaded.

Secret code: max. 4 digits (0001 to 9999/0000) (Use the numeric entry method)

NOTE If "0" is entered, the "compulsory secret code entry" will be canceled.

MAINTENANCE D/L	↓ P UP ▲	CAN	.	CL
DEPT	0000	CEL	.	CL
DEPT PRICE	0000	7	8	9
DEPT CVM DATA	0000			
PLU/UPC	0000	4	5	6
PLU PRICE	0000			
PLU CVM DATA	0000	1	2	3
LINK PLU	0000			
CONDIMENT	0000			
PREV. NEXT LIST P DOWN ▼		0	00	ENTR
PGH2 MIKE				0001
				10:50AM

The screen continues.

Program each item as follows:

DEPT	Department preset
DEPT PRICE	Department price preset
DEPT CVM DATA	dept CVM data
PLU/UPC	PLU/UPC preset
PLU PRICE	PLU price preset
PLU CVM DATA	PLU CVM data
LINK PLU	Link PLU preset
CONDIMENT	Condiment PLU preset
MIX&MATCH	Mix & Match preset
COMBO MEAL	Combo meal preset
COMBO CVM DATA	Combo CVM data
TRANSACTION	Transaction preset
POSITIVE#	Positive number preset

■ Auto key

You can assign a secret code to each automatic sequencing key (Auto key).

Secret code: max. 4 digits (0001 to 9999/0000) **(Use the numeric entry method)**

AUTO KEY	↓ P UP ▲	CAN	·	CL
AUTO	0000	CEL	.	CL
AUTO2	0000	7	8	9
AUTO3	0000			
AUTO4	0000	4	5	6
AUTO5	0000			
AUTO6	0000	1	2	3
AUTO7	0000			
AUTO8	0000	0	00	ENTR
PREV. NEXT LIST P DOWN ▼				
PGM2 MIKE				0001
				10:52AM

The screen continues.

AUTO	Auto key
AUTO2	Auto2 key
AUTO3	Auto3 key
...	...
AUTO99	Auto99 key

NOTE If "0" is entered, the "compulsory secret code entry" will be canceled.

Report Programming

Use the following procedure for report programming:

Procedure

SETTING	↑↓	P UP ▲	CAN	CEL	.	CL
09 DATE/TIME						
10 OPTIONAL			7	8	9	
11 SECRET CODE						
12 REPORT			4	5	6	
13 LOGO TEXT						
14 DEVICE CONFIG			1	2	3	
15 GLU CODE						
16 CUSTOMER			0	00	ENTR	
PREV. NEXT LIST P DOWN ▼						
PGM2 MIKE						0001
						10:54AM



REPORT	P UP ▲	CAN	CEL	.	CL
1 0 SKIP					
2 HOURLY REPORT		7	8	9	
3 STACKED REPORT					
		4	5	6	
		1	2	3	
		0	00	ENTR	
PREV. NEXT LIST P DOWN ▼					
PGM2 MIKE					0001
					10:55AM

1. In the SETTING window, select "12 REPORT."
• The REPORT window will appear.

2. Select any option from the following list:

- 1 0 SKIP: Zero skip
- 2 HOURLY REPORT: Hourly report
- 3 STACKED REPORT: Stacked report

The following illustration shows the report programming options.



■ Zero skip

You can program whether or not to skip “0” sales totalizer in each report.

Procedure

0 SKIP	P UP ▲	CAN	CEL	.	CL
SERVER	SKIP	7	8	9	
TRANSACTION	SKIP	4	5	6	
DEPARTMENT	SKIP	1	2	3	
PLU/UPC	SKIP	0	00	ENTR	
HOURLY	SKIP				0001
SCM	SKIP				10:55AM
DAILY NET	SKIP				
PREV. NEXT LIST P DOWN ▼					
PGM2 HIKE					

Program each item as follows:

- **SERVER (Use the selective entry method)**

NOT SKIP: Does not skip those data that are “0” sales in the server report.

SKIP: Skips those data that are “0” sales in the server report.

- **TRANSACTION (Use the selective entry method)**

NOT SKIP: Does not skip those data that are “0” sales in the transaction report.

SKIP: Skips those data that are “0” sales in the transaction report.

- **DEPARTMENT (Use the selective entry method)**

NOT SKIP: Does not skip those data that are “0” sales in the department report.

SKIP: Skips those data that are “0” sales in the department report.

- **PLU/UPC (Use the selective entry method)**

NOT SKIP: Does not skip those data that are “0” sales in the PLU/UPC report.

SKIP: Skips those data that are “0” sales in the PLU/UPC report.

- **HOURLY (Use the selective entry method)**

NOT SKIP: Does not skip those data that are “0” sales in the hourly report.

SKIP: Skips those data that are “0” sales in the hourly report.

- **SCM (Use the selective entry method)**

NOT SKIP: Does not skip those data that are “0” sales in the SCM report.

SKIP: Skips those data that are “0” sales in the SCM report.

- **DAILY NET (Use the selective entry method)**

NOT SKIP: Does not skip those data that are “0” sales in the daily net report.

SKIP: Skips those data that are “0” sales in the daily net report.

■ Hourly report

You can program the memory type and the starting time for the hourly report.

Procedure

HOURLY REPORT	P UP ▲	CAN	CEL	.	CL
MEMORY TYPE	30MIN	7	8	9	
STARTING TIME	00	4	5	6	
		1	2	3	
		0	00	ENTR	
PREV. NEXT LIST P DOWN ▼					
PGM2					3 02AM

Program each item as follows:

- **MEMORY TYPE (Use the selective entry method)**

15MIN: Selects the 15-minute type.

30MIN: Selects the 30-minute type.

60MIN: Selects the 60-minute type.

- **STARTING TIME (Use the numeric entry method)**

Starting time entry (max. 2 digits: 0 to 23)

■ Stacked report

Your POS terminal is equipped with the stacked report printing function that enables multiple X/Z reports to be printed in sequence by a single request.

Procedure

Select a stacked report no. from the stacked reports list.

↓

STACKED REPORT 1		↓	P UP	▲	CAN	CEL	.	CL
01					7	8	9	
02					4	5	6	
03					1	2	3	
04					0	00	ENTR	
05	PREV.	NEXT	LIST	P DOWN				
06	PGM2	MIKE						0001
								10:57AM

↓

STACKED REPORT 1		↓	P UP	▲	CAN	CEL	.	CL
01	DEPARTMENT				7	8	9	
02	DEPT.IND.GROUP				4	5	6	
03	DEPT.GROUP TOTAL				1	2	3	
04	MARKDOWN DEPT.				0	00	ENTR	
05	PLU/UPC							
06	PLU BY DEPT							
07	PLU IND. GROUP							
08	PLU GROUP TOTAL							
09	PREV.	NEXT	LIST	P DOWN				
10	PGM2	MIKE						0001
								10:57AM

The screen continues.

You can select a maximum of twenty reports from the stacked reports list. Some reports can be set their parameters such as "START CODE" and "END CODE."

- **01 DEPARTMENT (Use the numeric entry method)**
Full department report
Parameter: Start department code/end department code (1 thru 99)
- **02 DEPT.IND.GROUP (Use the numeric entry method)**
Individual group report on departments
Parameter: Department group no. (1 thru 9)
- **03 DEPT.GROUP TOTAL**
Full group total report on departments
- **04 MARKDOWN DEPT. (Use the numeric entry method)**
Markdown for department report
Parameter: Start department code/end department code (1 thru 50)
- **05 PLU/UPC (Use the numeric entry method)**
PLU report by designated range
Parameter: Start PLU code/end PLU code (1 thru 999999)
- **06 PLU BY DEPT (Use the numeric entry method)**
PLU report by associated departments
Parameter: Department code (1 thru 50)
- **07 PLU IND. GROUP (Use the numeric entry method)**
PLU report by individual group
Parameter: PLU group no. (00 thru 99)
- **08 PLU GROUP TOTAL**
Full group total report on PLUs
- **09 PLU STOCK (Use the numeric entry method)**
PLU stock report
Parameter: Start PLU code/end PLU code (1 thru 99999)
- **10 PLU ZERO SALES (Use the selective/numeric entry method)**
PLU zero sales report
Parameter: 1 ALL/2 BY DEPT.
When "2 BY DEPT." is selected, enter a department code (1 thru 99).
- **11 PLU MINIMUM STOCK (Use the numeric entry method)**
PLU minimum stock report
Parameter: Start PLU code/end PLU code (1 thru 99999)
- **12 PLU PRICE CATEGORY (Use the numeric entry method)**
PLU price category report
Parameter: Start unit price/end unit price

■ Stacked report (continued)

- **13 DYNAMIC UPC**

Dynamic UPC report

- **14 TRANSACTION**

Transaction report

- **15 CID**

Cash in drawer report

- **16 POSITIVE CHECK**

Positive check report

- **17 TAX**

Tax report

- **18 SCM**

Starting cash memory report

- **19 ALL SERVER**

Full server report

- **20 IND. SERVER (Use the numeric entry method)**

Individual server report

Parameter: Server code (1 thru 9999)

- **21 HOURLY (Use the numeric entry method)**

Hourly report

Parameter: Start time/end time (0 thru 2345)

NOTE *To take the hourly Z report, you have to specify the full-range hourly report.*

- **22 DAILY NET**

Daily net report

- **23 GLU (Use the numeric entry method)**

GLU/PBLU report

Parameter: Start GLU code/end GLU code (1 thru 99999999)

- **24 GLU BY SERVER (Use the numeric entry method)**

GLU/PBLU report by server

Parameter: Server code (1 thru 9999/Up to 255 servers can be assigned.)

- **25 CLOSED GLU (Use the numeric entry method)**

Closed GLU/PBLU report

Parameter: Start GLU code/end GLU code (1 thru 99999999)

- **26 CL-GLU BY SERVER (Use the numeric entry method)**

Closed GLU/PBLU report by server

Parameter: Server code (1 thru 9999/Up to 255 servers can be assigned.)

- **27 CUST. DETAILS ONLY (Use the numeric entry method)**

Customer details only report

Parameter: Start customer code/end customer code

■ Stacked report (continued)

- **28 CUSTOM SALES ALL (Use the numeric entry method)**

Customer sales all report

Parameter: Start customer code/end customer code

- **29 CHARGE ACCOUNT**

Charge account (customer no payment) report

- **30 KEY CAPTURE**

Key capture report

- **31 NON ACCESSED UPC**

No-access UPC report

- **32 NON ACCESSED CUST.**

No-access customer report

Logo Text Programming

Use the following procedure for logo text programming.

Procedure

SETTING	↑↓	P UP ▲	CAN CEL	.	CL
09 DATE/TIME			7	8	9
10 OPTIONAL			4	5	6
11 SECRET CODE			1	2	3
12 REPORT			0	00	ENTR
13 LOGO TEXT					
14 DEVICE CONFIG					
15 GLU CODE					
16 CUSTOMER					
PREV. NEXT LIST P DOWN ▼					
PGM2 MIKE					0001
					11:01AM



LOGO TEXT	P UP ▲	CAN CEL	.	CL	
1 RECEIPT LOGO			7	8	9
2 VP TEXT			4	5	6
3 BILL LOGO			1	2	3
4 SCROLL POLE DISP.			0	00	ENTR
PREV. NEXT LIST P DOWN ▼					
PGM2 MIKE					0001
					11:01AM

1. In the SETTING window, select “13 LOGO TEXT.”

- The LOGO TEXT window will appear.

2. Select any option from the following options list:

- | | |
|---------------------|------------------------------------|
| 1 RECEIPT LOGO: | Receipt logo |
| 2 VP TEXT: | Validation printing text |
| 3 BILL LOGO: | Bill logo |
| 4 SCROLL POLE DISP: | Scrolling message for pole display |

The following illustration shows the logo text programming options.

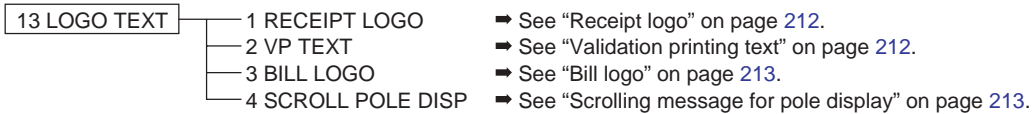

■ Receipt logo

Your POS terminal can print programmed messages for customers on every receipt.

Procedure

RECEIPT LOGO		P UP ▲	CAN	.	CL
■ SHARP PRESENTS THE BEST MACHINE			7	8	9
			4	5	6
			1	2	3
			0	00	ENTR
PREV.	NEXT	LIST	P DOWN ▼		
PGH2					A 2:52AM

Program the item as follows:

- **RECEIPT LOGO (Use the character entry method)**
Logo text for the receipt (max. 30 characters x 6 lines)

NOTE

The number of lines available for a message varies according to the message type: the "3-line header message" type, "3-line footer message" type, "6-line header message" type and "Stamp only" type. Please consult your authorized SHARP dealer.

■ Validation printing text

Your POS terminal can print programmed validation messages.

Procedure

VP TEXT		P UP ▲	CAN	.	CL
FOR DEPOSIT ONLY			7	8	9
			4	5	6
			1	2	3
			0	00	ENTR
PREV.	NEXT	LIST	P DOWN ▼		
PGH2 HIKE					0001
					A 11 03AM

Program the item as follows:

- **VP TEXT (Use the character entry method)**
Text for the validation slip (max. 30 characters x 3 lines)

■ Bill logo

Your POS terminal can print programmed messages for customers on the bill. Shown below is an example of selecting “1 HEADER”.

Procedure

BILL LOGO	P UP ▲	CAN	.	CL
1 HEADER		CEL		
2 FOOTER		7	8	9
		4	5	6
		1	2	3
		0	00	ENTR
PREV. NEXT LIST P DOWN ▼				
PGM2 MIKE				0001
				11 04AM

↓
If it is assumed that you have selected “1 HEADER.”

HEADER	P UP ▲	CAN	.	CL
■		CEL		
		7	8	9
		4	5	6
		1	2	3
		0	00	ENTR
PREV. NEXT LIST P DOWN ▼				
PGM2 MIKE				0001
				11:04AM

When “1 HEADER” is selected:

- **HEADER (Use the character entry method)**
Header text for the bill (max. 40 characters x 3 lines)

When “2 FOOTER” is selected:

- **FOOTER (Use the character entry method)**
Footer text for the bill (max. 30 characters x 6 lines)

NOTE

Header/Footer text for bill printer programming.

■ Scrolling message for pole display

Your POS terminal can display a scrolling message on the optional pole display.

SCROLL POLE DISP.	P UP ▲	CAN	.	CL
■		CEL		
		7	8	9
		4	5	6
		1	2	3
		0	00	ENTR
PREV. NEXT LIST P DOWN ▼				
PGM2 MIKE				0001
				11 05AM

Program the item as follows:

- **SCROLL POLE DISP. (Use the character entry method)**
Text for the scrolling message (max. 64 characters)

Device Configuration Programming

Use the following procedure to select a device configuration programming:

Procedure

SETTING	↑ P UP ▲	CAN	·	CL
09 DATE/TIME		CEL		
10 OPTIONAL		7	8	9
11 SECRET CODE				
12 REPORT		4	5	6
13 LOGO TEXT				
14 DEVICE CONFIG		1	2	3
15 GLU CODE				
16 CUSTOMER		0	00	ENTR
PREV. NEXT LIST P DOWN ▼				
PGM2 MIKE				0001 11 07AM



DEVICE CONFIG	↓ P UP ▲	CAN	·	CL
01 BUILT-IN PRINTER		CEL		
02 JOURNAL PRINTER		7	8	9
03 EXTERNAL JOURNAL				
04 RECEIPT PRINTER		4	5	6
05 BILL PRINTER				
06 REPORT PRINTER		1	2	3
07 VALIDATION (VP)				
08 KP#1		0	00	ENTR
PREV. NEXT LIST P DOWN ▼				
PGM2 MIKE				0001 11 08AM

The screen continues.

1. In the SETTING window, select "14 DEVICE CONFIG."
• The DEVICE CONFIG window will appear.

2. Select any option from the following options list:

- 01 BUILT-IN PRINTER: Built-in printer
- 02 JOURNAL PRINTER: Journal printer*
- 03 EXTERNAL PRINTER: External printer
- 04 RECEIPT PRINTER: Receipt printer
- 05 BILL PRINTER: Bill printer
- 06 REPORT PRINTER: Report printer
- 07 VALIDATION (VP): Receipt printer
- 08 KP#1: Remote printer #1
- 09 KP#2: Remote printer #2
- 10 KP#3: Remote printer #3
- 11 KP#4: Remote printer #4
- 12 KP#5: Remote printer #5
- 13 KP#6: Remote printer #6
- 14 KP#7: Remote printer #7
- 15 KP#8: Remote printer #8
- 16 KP#9: Remote printer #9
- 17 BCR(SCANNER): BCR (Scanner)
- 18 POLE DISPLAY: Pole display

The following illustration shows those options included in the device configuration programming group.

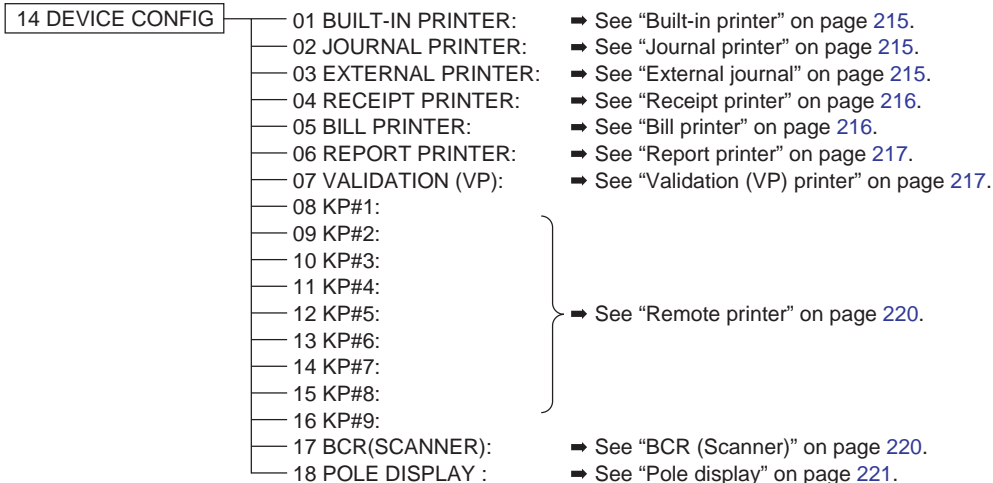

■ Built-in printer

Procedure

BUILT-IN PRINTER		P UP ▲	CAN	.	CL
LIGHT&SHADE		50	CEL		
IMAGE FOOTER	NOT PRINT		7	8	9
			4	5	6
			1	2	3
			0	00	ENTR
PREV.	NEXT	LIST	P DOWN ▼		
PGM2	MIKE				0001
					11:10AM

Program each item as follows:

- **LIGHT&SHADE (Use the numeric entry method)**

Select a light and shade level. (00 to 99)

00: 65% of the standard

50: 100% <standard>

99: 135% of the standard

- **IMAGE FOOTER (Use the selective entry method)**

PRINT: Prints footer graphic logo.

NOT PRINT: Does not print footer graphic logo.

■ Journal printer

Procedure

JOURNAL PRINTER		P UP ▲	CAN	.	CL
PRINTER		BUILT-IN	CEL		
			7	8	9
			4	5	6
			1	2	3
			0	00	ENTR
PREV.	NEXT	LIST	P DOWN ▼		
PGM2	MIKE				0001
					11:11AM

Journal printer is fixed to "BUILT IN."

■ External journal

Procedure

EXTERNAL JOURNAL		P UP ▲	CAN	.	CL
PRINTER		TM-T88(3)/T88(4)	CEL		
			7	8	9
			4	5	6
			1	2	3
			0	00	ENTR
PREV.	NEXT	LIST	P DOWN ▼		
PGM2					
					2:49AM

Program each item as follows:

- **PRINTER (Use the selective entry method)**

Select the printer to be used from the following:

TM-T88(3)/T88(4)

TM-U220/230

TM-T90

NOTE

If you want to access the EXTERNAL JOURNAL window, please consult your authorized SHARP dealer.

■ Report printer

Procedure

REPORT PRINTER		P UP ▲	CAN	·	CL
PRINTER	BUILT-IN		CEL		
AUTO CUTTER	YES		7	8	9
LOGO TEXT	PRINT		4	5	6
			1	2	3
			0	00	ENTR
PREV. NEXT LIST P DOWN ▼					
PGM2 MIKE					0001 11 15AM

Program each item as follows:

- **PRINTER (Use the selective entry method)**

Select the printer to be used.

BUILT-IN (built-in printer)

EPSON TM-295

EPSON TM-T88(3)/88(4)

EPSON TM-U220/230

EPSON TM-T90

- **AUTO CUTTER (Use the selective entry)**

Auto cutter function

YES: Enables auto cutter function.

NO: Disables auto cutter function.

- **LOGO TEXT (Use the selective entry method)**

Select the logo text printing status.

NOT PRINT: Logo text is not printed.

PRINT: Logo text is printed.

(This item is invalid for the built-in printer.)

■ Validation (VP) printer

Procedure

VALIDATION(VP)		P UP ▲	CAN	·	CL
PRINTER	TM-295		CEL		
VP TIMES	1		7	8	9
			4	5	6
			1	2	3
			0	00	ENTR
PREV. NEXT LIST P DOWN ▼					
PGM2					2 49AM

Program each item as follows:

- **PRINTER (Use the selective entry method)**

Select the printer to be used.

EPSON TM-295

- **VP TIMES (Use the numeric entry method)**

Number of times of validation printing (0 thru 9)

■ Remote printer (KP#1 thru KP#9)

Procedure

KP#1		P UP ▲	CAN	·	CL
PRINTER	TM-T88(3)/88(4)		CEL		
AUTO CUTTER	NO		7	8	9
LOGO TEXT	NOT PRINT				
TOP EXTRA LINE	0		4	5	6
BOTTOM EXTRA LINE	0		1	2	3
			0	00	ENTR
PREV.	NEXT	LIST	P DOWN ▼		
PGH2	MIKE				0001
					11:16AM

Program each item as follows:

- **PRINTER (Use the selective entry method)**

Select the printer to be used.

EPSON TM-T88(3)/88(4)

EPSON TM-U-220/230

EPSON TM-T90

BUILT-IN (built-in printer)

- **AUTO CUTTER (Use the selective entry method)**

Auto cutter function

YES : Enables auto cutter function.

NO : Disables auto cutter function.

- **LOGO TEXT (Use the selective entry method)**

Select the logo text printing status.

NOT PRINT: Logo text is not printed.

PRINT: Logo text is printed.

- **TOP EXTRA LINE (Use the numeric entry method)**

Number of leading blank lines to be fed for a remote printer (0 to 9)

- **BOTTOM EXTRA LINE (Use the numeric entry method)**

Number of tracking blank lines to be fed for a remote printer (0 to 9)

■ BCR (SCANNER)

Procedure

BCR(SCANNER)		P UP ▲	CAN	·	CL
BAUD RATE	4800bps		CEL		
DATA BITS	7 Bits		7	8	9
PARITY	ODD				
STOP BIT	1 Bit		4	5	6
			1	2	3
			0	00	ENTR
PREV.	NEXT	LIST	P DOWN ▼		
PGH2					2 50AM

Program each item as follows:

- **BAUD RATE (Use the selective entry method)**

Transmission speed (baud rate)

19200 bps/9600 bps/4800 bps

- **DATA BITS (Use the selective entry method)**

Data bit: 7 bits/8 bits

- **PARITY (Use the selective entry method)**

Parity bit: NON/ODD/EVEN

- **STOP BIT (Use the selective entry method)**

Stop bit: 1 bit/2 bits

■ Pole display

Procedure

POLE DISPLAY		P UP ▲	CAN	.	CL
WAITING TIME		000	CEL		
			7	8	9
			4	5	6
			1	2	3
			0	00	ENTR
PREV.	NEXT	LIST	P DOWN ▼		
PGN2	HIKE				0001
					11:19AM

Program the item as follows:

- **WAITING TIME (Use the numeric entry method)**

Waiting time until the message is displayed on the pole display (1 to 999)

When you enter "0", no message is displayed.

GLU Code Programming

Use the following procedure for GLU code programming:

Procedure

SETTING	↑↓	P UP ▲	CAN	CEL	.	CL
09 DATE/TIME						
10 OPTIONAL			7	8	9	
11 SECRET CODE						
12 REPORT			4	5	6	
13 LOGO TEXT						
14 DEVICE CONFIG			1	2	3	
15 GLU CODE						
16 CUSTOMER			0	00	ENTR	
PREV.	NEXT	LIST	P DOWN ▼			
PGM2 MIKE					0001	
					11 19AM	



GLU CODE	P UP ▲	CAN	CEL	.	CL
1 GLU					
			7	8	9
			4	5	6
			1	2	3
			0	00	ENTR
PREV.	NEXT	LIST	P DOWN ▼		
PGM2 MIKE					0001
					11 20AM



GLU	P UP ▲	CAN	CEL	.	CL
START CODE	0001				
END CODE	9999				
			7	8	9
			4	5	6
			1	2	3
			0	00	ENTR
PREV.	NEXT	LIST	P DOWN ▼		
PGM2 MIKE					0001
					11:20AM

1. In the SETTING window, select "15 GLU CODE."
 - The GLU CODE window will appear.

2. Select any item from the following option list:
 - 1 GLU: GLU/PBLU code

You can program the range of available guest check codes.

Program each item as follows:

- **START CODE (Use the numeric entry method)**
Start GLU code (max. 4 digits: 1 to 9999)
- **END CODE (Use the numeric entry method)**
End GLU code (max. 4 digits: 1 to 9999)

Customer Programming

Use the following procedure for customer programming:

Procedure

SETTING	↑↓	P UP ▲	CAN	·	CL
09 DATE/TIME			CEL		
10 OPTIONAL			7	8	9
11 SECRET CODE					
12 REPORT			4	5	6
13 LOGO TEXT					
14 DEVICE CONFIG			1	2	3
15 GLU CODE					
16 CUSTOMER			0	00	ENTR
PREV.	NEXT	LIST	P DOWN ▼		
PGM2 MIKE					0001
					11:20AM



CUSTOMER	P UP ▲	CAN	·	CL
1 CUSTOMER		CEL		
2 CUSTOMER PROGRAM		7	8	9
		4	5	6
		1	2	3
		0	00	ENTR
PREV.	NEXT	LIST	P DOWN ▼	
PGM2 MIKE				0001
				11:21AM

1. In the SETTING window, select “16 CUSTOMER”.

2. Select an option from the following option list:
1 CUSTOMER: Customer code
2 CUSTOMER PROGRAM: Customer programming

The following illustration shows those options included in the customer programming group.



■ Customer code

Procedure

0000000000001	P UP ▲	CAN	.	CL
NAME		CEL		
TEL#		7	8	9
		4	5	6
		1	2	3
		0	00	ENTR
PREV. NEXT LIST P DOWN ▼				
PGH2				A 10 51AM

Program each item as follows:

- **NAME (Use the character entry method)**
Enter a customer's name (max. 16 characters)
- **ADDRESS (Use the character entry method)**
On the second line, enter the customer's address (max. 40 characters)
- **TEL# (Use the numeric entry method)**
Enter a customer's telephone number (max. 24 characters)

■ Customer programming

Procedure

CUSTOMER PROGRAM	P UP ▲	CAN	.	CL
PERIOD:MONTH	99	CEL		
PBAL DISPLAY	NO	7	8	9
SERVICE DISPLAY	NO	4	5	6
		1	2	3
		0	00	ENTR
PREV. NEXT LIST P DOWN ▼				
PGH2				3:45PM

Program each item as follows:

- **PERIOD:MONTH (Use the numeric entry method)**
Preset a period to delete customer detail data.
Enter the period months. (01 to 99)
If you enter "00", the customer detail data will not be deleted.

NOTE If the following condition is satisfied, the code is deleted by deleting operation.

Date of deletion (Year, Month) Date of the last access (Year, Month) + programmed period + 1
[Ex.] Date of deletion = 8/(1 to 31)/2009, Period = 12 months:

Customer	Date of the last access		
Customer A	(6/(1 to 30)/2008)	→	Deleted
Customer B	(7/(1 to 31)/2008)	→	Deleted
Customer C	(8/(1 to 31)/2008)	→	Not deleted

- **PBAL DISPLAY (Use the selective entry method)**
YES : Displays the customer's PBAL amount in case of customer entry.
NO : Does not display the customer's PBAL amount in case of customer entry.
- **SERVICE DISPLAY (Use the selective entry method)**
YES : Displays the customer's service amount in case of customer entry.
NO : Does not display the customer's service amount in case of customer entry.

Negative Code File Programming

Use the following procedure for negative code file programming:

■ Negative code/Override status

You can program the negative code and its override status.

Procedure

SETTING	↑↓	P UP	▲	CAN	CEL	.	CL
17 NEGATIVE#							
18 POSITIVE#				7	8	9	
19 MACRO KEY							
20 FUNCTION KEY				4	5	6	
21 CAPTURE KEY							
22 CAPTURE JOB#				1	2	3	
23 TAX							
24 TRAINING				0	00	ENTR	
PREV.	NEXT	LIST	P DOWN				
PGM2 MIKE						0001	
						11 23AM	



NEGATIVE#	P UP	▲	CAN	CEL	.	CL
---NOTHING---						
			7	8	9	
			4	5	6	
			1	2	3	
			0	00	ENTR	
PREV.	NEXT	LIST	P DOWN			
PGM2 MIKE					0001	
					11 24AM	



Select a negative code and press .
(Or enter the corresponding code.)

Program each item as follows:

- **NEGATIVE# (Use the numeric entry method)**

Negative code (max. 16 digits)

- **OVERRIDE (Use the selective entry method)**

Negative code checking can be overridden in compliance with programmed override status.

(Override/access operation: →)

(Not to override: →)

REG&MGR: Available to the manager and servers/cashiers.
The message "ACCESS" is displayed.

MGR ONLY: Only available to the manager.

The message "CALL MGR" is displayed.

INHIBIT: The override operation is inhibited.

The message "NOT ACCEPT" is displayed.

NOTE

- You can create a new code by entering the code, then pressing the key.

#0000000000000001	P UP	▲	CAN	CEL	.	CL
OVERRIDE						
			7	8	9	
			4	5	6	
			1	2	3	
			0	00	ENTR	
PREV.	NEXT	LIST	P DOWN			
PGM2 MIKE					0001	
					11 24AM	

To delete a negative code, proceed as follows:

NEGATIVE#	P UP	▲	CAN	CEL	.	CL
#0000000000000001						
#0000000000000002						
			7	8	9	
			4	5	6	
			1	2	3	
			0	00	ENTR	
PREV.	NEXT	LIST	P DOWN			
PGM2					1:12PM	



Enter the code or move the cursor to the code, and then press the DEL key.

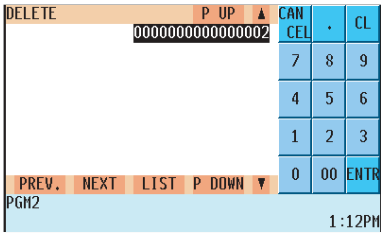

The DELETE window appears.

- Press the key.

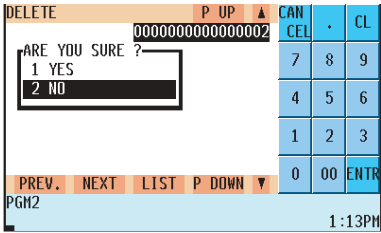

Message "ARE YOU SURE ?" appears.

- Select "YES" and press the key.
 - To cancel the deletion, select "NO" and press the key.
- To end the deletion procedure, press the key.

Positive Code File Programming

Use the following procedure for positive code file programming:

Positive code

You can create/delete the positive code.

Procedure

SETTING	↑↓	P UP ▲	CAN	CEL	.	CL
17						
18			7	8	9	
19						
20			4	5	6	
21						
22			1	2	3	
23						
24			0	00	ENTR	
PREV.	NEXT	LIST	P DOWN ▼			
PGM2	MIKE				0001	
					11	24AM

Program the item as follows:

- **POSITIVE# (Use the numeric entry method)**
Positive code (max. 16 digits)

NOTE

- You create a new code by entering the code, then pressing the key.

POSITIVE#	P UP ▲	CAN	CEL	.	CL	
---NOTHING---						
		7	8	9		
		4	5	6		
		1	2	3		
		0	00	ENTR		
PREV.	NEXT	LIST	P DOWN ▼			
PGM2	MIKE				0001	
					11	25AM

Select a negative code and press .

(Or enter the corresponding code.)

POSITIVE#	P UP ▲	CAN	CEL	.	CL	
#0000000000000001						
		7	8	9		
		4	5	6		
		1	2	3		
		0	00	ENTR		
PREV.	NEXT	LIST	P DOWN ▼			
PGM2	MIKE				0001	
					11	25AM

To delete a negative code, proceed as follows:

POSITIVE#	P UP ▲	CAN	CEL	.	CL
#0000000000000001					
#0000000000000002					
		7	8	9	
		4	5	6	
		1	2	3	
		0	00	ENTR	
PREV.	NEXT	LIST	P DOWN ▼		
PGM2					1
					16PM

Enter the code or move the cursor to the code, and then press the DEL key.

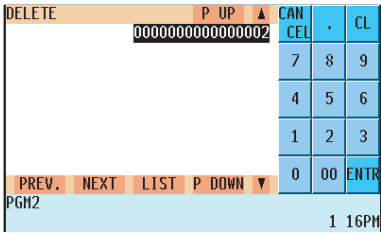

The DELETE window appears.

- Press the key.

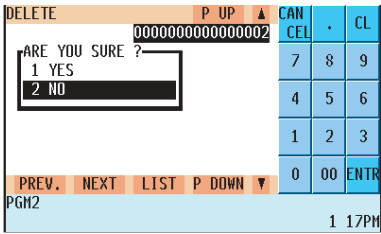

Message "ARE YOU SURE ?" appears.

- Select "YES" and press the key.
 - To cancel the deletion, select "NO" and press the key.
- To end the deletion procedure, press the key.

Macro Key Programming

Use the following procedure for macro key programming :

■ Mode position/Auto key no.

The Macro Key Function is used to run a series of instructions with a single key stroke. You can program up to 15 modes auto key numbers for each macro key.

Procedure

SETTING	↑↓	P UP	▲	CAN	·	CL
17 NEGATIVE#				CEL		
18 POSITIVE#				7	8	9
19 MACRO KEY						
20 FUNCTION KEY				4	5	6
21 CAPTURE KEY				1	2	3
22 CAPTURE JOB#						
23 TAX				0	00	ENTR
24 TRAINING						
PREV. NEXT LIST P DOWN ▼						
PGM2 MIKE						0001
						11 27AM



MACRO KEY	P UP	▲	CAN	·	CL
1 MACRO#1			CEL		
2 MACRO#2			7	8	9
3 MACRO#3			4	5	6
4 MACRO#4			1	2	3
			0	00	ENTR
PREV. NEXT LIST P DOWN ▼					
PGM2 MIKE					0001
					11 27AM



Select a pertinent macro key. →



MACRO#1	↓	P UP	▲	CAN	·	CL
MODE#1				INHIBIT		
KEY#1				INHIBIT	7	8
MODE#2				INHIBIT	4	5
KEY#2				INHIBIT	1	2
MODE#3				INHIBIT		
KEY#3				INHIBIT	0	00
MODE#4				INHIBIT		
KEY#4				INHIBIT		
PREV. NEXT LIST P DOWN ▼						
PGM2 MIKE						0001
						11 27AM

Program the item as follows:

- **MACRO#1 thru MACRO#4 (Use the selective entry method)**

Select the pertinent macro key from the list.

- **MODE#1 thru MODE#15 (Use the selective entry method)**

INHIBIT: AUTO key is inhibited.

PGM2: PGM2 mode

PGM1: PGM1 mode

OPXZ: OP X/Z mode

REG: REG mode

X1Z1: X1/Z1 mode

X2Z2: X2/Z2 mode

- **KEY#1 thru KEY#15 (Use the selective entry method)**

INHIBIT: AUTO key is inhibited.

AUTO1 thru AUTO99: AUTO key no.

Function Key Programming

Use the following procedure for the function key programming:

Procedure

SETTING	↑	P UP	▲	CAN CEL	.	CL
19 MACRO KEY						
20 FUNCTION KEY				7	8	9
21 CAPTURE KEY						
22 CAPTURE JOB#				4	5	6
23 TAX						
24 TRAINING				1	2	3
25 BACKUP SEND						
26 BACKUP RECEIVE				0	00	ENTR
PREV.	NEXT	LIST	P DOWN	▼		
PGH2						
2 28PH						



FUNCTION KEY	P UP	▲	CAN CEL	.	CL
1 FUNCTION MENU KEY			7	8	9
2 FUNCTION KEY			4	5	6
			1	2	3
			0	00	ENTR
PREV.	NEXT	LIST	P DOWN	▼	
PGH2					
2:28PH					

1. In the SETTING window, select “20 FUNCTION KEY”.

- The FUNCTION KEY window will appear.

2. Select an option from the following option list:

- 1 FUNCTION MENU KEY: Function menu key
- 2 FUNCTION KEY: Function key

The following illustration shows the function key programming options.

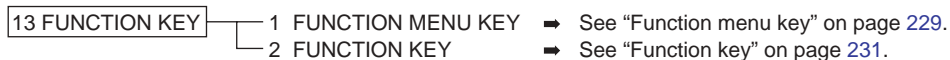

* See “Function menu key list” for the function keys assigned to each function menu key by default.

Function menu key

You can assign a maximum of 15 function keys to each of the 30 function menu keys. You can also program the display menu titles for each function menu key.

Pressing a function menu key displays its assigned function keys in the keyboard area, allowing you to use those function keys by touching.

Setting a function menu key

Procedure

FUNCTION MENU KEY	↓ P UP ▲	CAN	.	CL
01 HISC MENU		CEL		
02 CASH MENU		7	8	9
03 CHECK MENU		4	5	6
04 CHARGE MENU		1	2	3
05 CONV MENU		0	00	ENTR
06 VOID MENU				
07 MSG MENU				
08 FUNCTION MENU08				
PREV. NEXT LIST P DOWN ▼				
PGM2				

The screen continues.

FUNCTION MENU09	↓ P UP ▲	CAN	.	CL
1 SETTING		CEL		
2 MENU TITLE		7	8	9
		4	5	6
		1	2	3
		0	00	ENTR
PREV. NEXT LIST P DOWN ▼				
PGM2				

The screen continues.

FUNCTION MENU09	↓ P UP ▲	CAN	.	CL
01 AMOUNT		CEL		
02 DEPT#		7	8	9
03 INHIBIT		4	5	6
04 INHIBIT		1	2	3
05 INHIBIT		0	00	ENTR
06 INHIBIT				
07 INHIBIT				
08 INHIBIT				
PREV. NEXT LIST P DOWN ▼				
PGM2				

The screen continues.

01	↓ P UP ▲	CAN	.	CL
01 <028 ALL FUNC.KEY>		CEL		
02 <092 LEVEL#>		7	8	9
03 <098 PRICE SFT#>		4	5	6
04 <105 TAXISF>		1	2	3
05 <110 GD1SFT>		0	00	ENTR
06 <113 GDSCZ1>				
07 <116 Z 1>				
08 <125 (-)1>				
PREV. NEXT LIST P DOWN ▼				
PGM2				

The screen continues.

01	↑↓ P UP ▲	CAN	.	CL
x028 BACK SPACE		CEL		
x029 DELETE		7	8	9
030 HDS ST		4	5	6
031 TRY ST		1	2	3
032 GAS ST		0	00	ENTR
033 #/TH				
034 NO SALE				
035 SCALE				
PREV. NEXT LIST P DOWN ▼				
PGM2				

The screen continues.

1. Select the desired function menu key from the function menu key list.

2. Select "1 SETTING".

3. Select the desired function key number.

In this example, the AMOUNT and DEPT# keys are allocated to the #01 and #02 of  key.

(Some function menu keys have the specific function keys allocated to them by default. For details of the preprogrammed function keys, refer to "Function menu key list".)

4. Select the desired function key group.

Selecting a function key group here allows you to jump to a function key listed close to your desired one.

5. Select a function key which you like to assign to the function menu key.

■ Function menu key (continued)

Setting a menu title

Procedure

FUNCTION MENU KEY	↑↓	P UP ▲	CAN CEL	.	CL
09	FUNCTION MENU09				
10	FUNCTION MENU10		7	8	9
11	FUNCTION MENU11				
12	FUNCTION MENU12		4	5	6
13	FUNCTION MENU13				
14	FUNCTION MENU14		1	2	3
15	FUNCTION MENU15				
16	FUNCTION MENU16		0	00	ENTR
PREV. NEXT LIST P DOWN ▼					
PGM2 2:32PM					



FUNCTION MENU09	P UP ▲	CAN CEL	.	CL	
1	SETTING				
2	MENU TITLE		7	8	9
			4	5	6
			1	2	3
			0	00	ENTR
PREV. NEXT LIST P DOWN ▼					
PGM2 2:32PM					



FUNCTION MENU09	P UP ▲	CAN CEL	.	CL	
MENU TITLE	FUNCTION MENU09				
			7	8	9
			4	5	6
			1	2	3
			0	00	ENTR
PREV. NEXT LIST P DOWN ▼					
PGM2 A 2:57PM					

1. Select the desired function menu key from the function menu key list.

2. Select "2 MENU TITLE".

3. Enter a text for the menu title.

- **MENU TITLE (Use the character entry method)**

Text for the menu title

Up to 16 characters can be entered.

Some function menu keys have the preprogrammed title texts corresponding to the function keys allocated to them by default.

For details of the preprogrammed function keys, refer to "Function menu key list".

Function key

You can program a display key text and a display key color function key.

Procedure

FUNCTION KEY		P UP ▲	CAN CEL	.	CL
1	FUNCTION MENU KEY				
2	FUNCTION KEY		7	8	9
			4	5	6
			1	2	3
			0	00	ENTR
PREV. NEXT LIST P DOWN ▼					
PGH2					2:35PM

The screen continues.

FUNCTION KEY		P UP ▲	CAN CEL	.	CL
01	<028 ALL FUNC.KEY>				
02	<092 LEVEL#>		7	8	9
03	<098 PRICE SFT#>		4	5	6
04	<105 TAX1SF>		1	2	3
05	<110 GD1SFT>		0	00	ENTR
06	<113 GDSC/1>				
07	<116 % 1>				
08	<125 (-)1>				
PREV. NEXT LIST P DOWN ▼					
PGH2					2:36PM



FUNCTION KEY		P UP ▲	CAN CEL	.	CL
028	BACK SPACE				
029	DELETE		7	8	9
030	MDS ST		4	5	6
031	TRY ST		1	2	3
032	GAS ST		0	00	ENTR
033	#/TM				
034	NO SALE				
035	SCALE				
PREV. NEXT LIST P DOWN ▼					
PGH2					2:36PM

The screen continues.



028		P UP ▲	CAN CEL	.	CL
KEY TEXT	BACK_SPACE				
			7	8	9
			4	5	6
			1	2	3
			0	00	ENTR
PREV. NEXT LIST P DOWN ▼					
PGH2					2:37PM



KEY COLOR		P UP ▲	CAN CEL	.	CL
[Color palette]					
			7	8	9
			4	5	6
			1	2	3
			0	00	ENTR
PREV. NEXT LIST P DOWN ▼					
PGH2					2:37PM

1. In the FUNCTION KEY window, select "2 FUNCTION KEY".

2. Select a pertinent function key group.
Selecting a function key group here allows you to jump to a function key listed close to the desired one.

3. Select the desired function key.

4. Enter a key text and press the key.

• KEY TEXT (Use the character entry method)

Text for the function key

Up to 12 characters can be entered.

By entry of the character "_" the following text is displayed in the second line.

For the default texts of each function key, refer to "Default key text on the display".

5. Select the desired key color from 232 colors.

■ Function menu key list

For the function menu keys ( to ), the default settings are as follows.

Function menu 01 key

Menu title:	MISC MENU
Function key#1:	RCPT ON/OFF
Function key#2:	RA
Function key#3:	RA2
Function key#4:	PO
Function key#5:	PO2
Function key#6:	CA/CHK1
Function key#7:	CA/CHK2
Function key#8:	CA/CHK3
Function key#9:	CA/CHK4
Function key#10:	CA/CHK5
Function key#11:	CA/CHK6
Function key#12:	CA/CHK7
Function key#13:	CA/CHK8
Function key#14:	CA/CHK9
Function key#15:	NOSALE

Function menu 02 key

Menu title:	CASH MENU
Function key#1:	TL
Function key#2:	CASH2
Function key#3:	CASH3
Function key#4:	CASH4
Function key#5:	CASH5
Function key#6 to 15:	INHIBIT

Function menu 03 key

Menu title:	CHECK MENU
Function key#1:	CHECK
Function key#2:	CHECK2
Function key#3:	CHECK3
Function key#4:	CHECK4
Function key#5:	CHECK5
Function key#6:	CHECK6
Function key#7:	CHECK7
Function key#8:	CHECK8
Function key#9:	CHECK9
Function key#10 to 15:	INHIBIT

Function menu 04 key

Menu title:	CHARGE MENU
Function key#1:	CHARGE1
Function key#2:	CHARGE2
Function key#3:	CHARGE3
Function key#4:	CHARGE4
Function key#5:	CHARGE5
Function key#6:	CHARGE6
Function key#7:	CHARGE7
Function key#8:	CHARGE8
Function key#9:	CHARGE9
Function key#10 to 15:	INHIBIT

Function menu 05 key

Menu title:	CONV MENU
Function key#1:	CONV1
Function key#2:	CONV2
Function key#3:	CONV3
Function key#4:	CONV4
Function key#5 to 15:	INHIBIT

Function menu 06 key

Menu title:	VOID MENU
Function key#1:	VOID
Function key#2:	I. VOID
Function key#3:	ST VD
Function key#4 TO 15:	INHIBIT

Function menu 07 key

Menu title:	MSG MENU
Function key#1:	MESSAGE1
Function key#2:	MESSAGE2
Function key#3:	MESSAGE3
Function key#4:	MESSAGE4
Function key#5:	MESSAGE5
Function key#6:	MAIL MESSAGE
Function key#7 TO 15:	INHIBIT

Function menu 08 to 30 key to

Menu title:	FUNC. MENU
Function key#1 TO 15:	INHIBIT

Capture Key Programming

Use the following procedure for capture key programming:

■ Capture key data

You can program max. 10 data capture keys for the capture data function.

Procedure

SETTING	↑↓	P UP ▲	CAN	CEL	.	CL
17 NEGATIVE#			7	8	9	
18 POSITIVE#			4	5	6	
19 MACRO KEY			1	2	3	
20 FUNCTION KEY			0	00	ENTR	
21 CAPTURE KEY						
22 CAPTURE JOB#						
23 TAX						
24 TRAINING						
PREV. NEXT LIST P DOWN ▼						
PGM2						1 53PM



CAPTURE KEY	↓	P UP ▲	CAN	CEL	.	CL
01 CAPTURE01			7	8	9	
02 CAPTURE02			4	5	6	
03 CAPTURE03			1	2	3	
04 CAPTURE04			0	00	ENTR	
05 CAPTURE05						
06 CAPTURE06						
07 CAPTURE07						
08 CAPTURE08						
PREV. NEXT LIST P DOWN ▼						
PGM2						1 54PM



Select the desired macro key →



CAP.1	P UP ▲	CAN	CEL	.	CL
TEXT	CAPTURE01				
TEXT PRINT	NO	7	8	9	
ENTRY COMPUL	NO	4	5	6	
LINK JOB#	00	1	2	3	
PREV. NEXT LIST P DOWN ▼		0	00	ENTR	
PGM2					A 1:54PM

Program the item as follows:

- **CAPTURE01 thru 10 (Use the selective entry method)**
Select the desired data capture key from the list.
- **TEXT (Use the character entry method)**
Description for the data capture key. Up to 12 characters can be entered.
- **TEXT PRINT (Use the selective entry method)**
YES : Prints the data capture key TEXT on R/J or bill.
NO : Does not print the data capture key TEXT.
- **ENTRY COMPUL (Use the selective entry method)**
Enforcing the data capture key.
BEGIN: Enforced at the beginning of transaction.
END: Enforced at the end of transaction.
NO: Not enforced-assigned key data function no.
- **LINK JOB# (Use the numeric entry method)**
Capture job number (1 to 99)

Key Data Entry Job Table Programming

Use the following procedure for key data entry job table programming:

■ Capture job number

You can program a max. of 99 capture job numbers.

Procedure

SETTING	↑↓	P UP ▲	CAN	CEL	.	CL
17 NEGATIVE#			7	8	9	
18 POSITIVE#			4	5	6	
19 MACRO KEY			1	2	3	
20 FUNCTION KEY			0	00	ENTR	
21 CAPTURE KEY						
22 CAPTURE JOB#						
23 TAX						
24 TRAINING						
PREV. NEXT LIST P DOWN ▼						
PGM2						1:56PM



CAPTURE JOB#	P UP ▲	CAN	CEL	.	CL
--NOTHING--		7	8	9	
		4	5	6	
		1	2	3	
		0	00	ENTR	
PREV. NEXT LIST P DOWN ▼					
PGM2					1 56PM



Select a pertinent macro key. →



01	↓	P UP ▲	CAN	CEL	.	CL
MESSAGE#1			7	8	9	
ENTRY#1		INHIBIT	4	5	6	
MAX. LENGTH#1		13	1	2	3	
MIN. LENGTH#1		00	0	00	ENTR	
TEXT PRINT#1		NO				
MESSAGE#2						
ENTRY#2		INHIBIT				
MAX. LENGTH#2		13				
PREV. NEXT LIST P DOWN ▼						
PGM2						1 56PM

The screen continues.

Program each item as follows:

- CAPTURE JOB# (Use the selective entry method)**
 Select the pertinent capture Job number. (1 to 99)
- MESSAGE#1 Thru 4 (Use the character entry method)**
 Description for the job (display message). Up to 12 characters can be entered. (for MESSAGE#1 Thru 4)
- ENTRY#1 thru 4 (Use the selective entry method)**
 Data entry type
 NUMERIC: Numeric data type
 CHARACTER: Character data type
 INHIBIT: Data entry is inhibited.
- MAX. LENGTH#1 thru 4 (Use the numeric entry method)**
 Max. length of data entry (0 to 13)
 "0" means that ENTER key entry is only allowed.
- MIN. LENGTH#1 thru 4 (Use the numeric entry method)**
 Min. length of data entry (0 to 13)
- TEXT PRINT#1 thru 4 (Use the selective entry method)**
 YES : Prints entry data on R/J or Bill printer.
 NO : Does not print entry data.

NOTE

- If the key is pressed on the job number selection menu, the selected job table will be deleted.

Tax Programming

Use the following procedure for tax programming:

Procedure

SETTING	↑↓	P UP	▲	CAN	CEL	.	CL
17 NEGATIVE#				7	8	9	
18 POSITIVE#				4	5	6	
19 MACRO KEY				1	2	3	
20 FUNCTION KEY				0	00	ENTR	
21 CAPTURE KEY							
22 CAPTURE JOB#							
23 TAX							
24 TRAINING							
PREV.	NEXT	LIST	P DOWN	▼			

PGH2 1 57PM



TAX	P UP	▲	CAN	CEL	.	CL
1 TAX1			7	8	9	
2 TAX2			4	5	6	
3 TAX3			1	2	3	
4 TAX4			0	00	ENTR	
5 TAX5						
6 DOUGHNUT EXPT						
PREV.	NEXT	LIST	P DOWN	▼		

PGH2 1 58PM

1. In the SETTING window, select "23 TAX."
 - The TAX window will appear.

2. Select any option from the following options list:

- | | |
|------------------|--|
| 1 TAX1: | Tax1 |
| 2 TAX2: | Tax2 |
| 3 TAX3: | Tax3 |
| 4 TAX4: | Tax4 |
| 5 TAX5: | Tax5 |
| 6 DOUGHNUT EXPT: | Doughnut exemption (for the Canadian tax system) |

NOTE

- The option "6 DOUGHNUT EXPT" appears only when the Canadian tax system is selected.
- If the key is pressed on the tax number selection menu, the tax table or the tax in the cursor position will be deleted.

The following illustration shows the tax programming options.

23 TAX	1 TAX1
	2 TAX2
	3 TAX3
	4 TAX4
	5 TAX5
	6 DOUGHNUT EXPT

- ➔ See "Table tax" on page 236 or "Rate (%) tax" on page 238.
- ➔ See "Table tax" on page 236 or "Rate (%) tax" on page 238.
- ➔ See "Table tax" on page 236 or "Rate (%) tax" on page 238.
- ➔ See "Table tax" on page 236 or "Rate (%) tax" on page 238.
- ➔ See "Table tax" on page 236 or "Rate (%) tax" on page 238.
- ➔ See "Doughnut tax exemption" on page 238.

Table tax

Your POS terminal has an automatic tax calculation feature which allows you to program four tax tables. Automatic tax calculations require you to program, in addition to tax tables, the tax status of each pertinent department, PLU, and function key.

Sample tax table

New Jersey tax table: 6%

Tax	Range of sales amount		A: Difference between a minimum breakpoint and the next one (¢)	
	Minimum breakpoint	Maximum breakpoint		
.00	.01	to .10	-	B: Non-cyclic
.01-T	.11-Q	to .22	10 (0.11 - 0.01)	
.02	.23	to .38	12 (0.23 - 0.11)	C: Cyclic 1
.03	.39	to .56	16 (0.39 - 0.23)	
.04	.57	to .72	18 (0.57 - 0.39)	
.05	.73	to .88	16 (0.73 - 0.57)	
.06	.89	to 1.10	16 (0.89 - 0.73)	
.07	1.11-M1	to 1.22	22 (1.11 - 0.89)	D: Cyclic 2
.08	1.23	to 1.38	12 (1.23 - 1.11)	
.09	1.39	to 1.56	16 (1.39 - 1.23)	
.10	1.57	to 1.72	18 (1.57 - 1.39)	
.11	1.73	to 1.88	16 (1.73 - 1.57)	
.12	1.89	to 2.10	16 (1.89 - 1.73)	
.13	2.11-M2	to 2.22	22 (2.11 - 1.89)	

To program a tax table, first make a table like the right table shown above.

From the tax table, calculate the difference between each minimum breakpoint and the next one (A). Then, from the differences, find irregular cycles (B) and regular cycles (C and D). In connection with these cycles, the following items necessary to program a tax table will be shown:

- T: Tax amount collected on the minimum taxable amount (Q)
- Q: Minimum taxable amount
- M1: Maximum value of the minimum breakpoint on a regular cycle (C).
We call this point "MAX point."
- M2: Maximum value of the minimum breakpoint on a regular cycle (D).
We call this point "MAX point."
- M: Range of the minimum breakpoint on a regular cycle: difference between Q and M1 between M1 and M2

Table tax (continued)

Procedure

Select the desired tax no. from the taxes list.

↓

TAX1		P UP ▲	CAN	·	CL
1	TABLE TAX		CEL		
2	ZTAX		7	8	9
			4	5	6
			1	2	3
			0	00	ENTR
PREV. NEXT LIST P DOWN ▼					
PGH2					2:02PM

↓

TABLE TAX		P UP ▲	CAN	·	CL
1	INTERVAL LOW 0.99		CEL		
2	INTERVAL OVR 1.00		7	8	9
			4	5	6
			1	2	3
			0	00	ENTR
PREV. NEXT LIST P DOWN ▼					
PGH2					2 04PM

↓

TABLE TAX		P UP ▲	CAN	·	CL
TAX RATE	0.0000%		CEL		
CYCLE	0.00		7	8	9
INITIAL TAX	0.00		4	5	6
LOWER LIMIT	0.00		1	2	3
BREAK POINT1	0.00		0	00	ENTR
BREAK POINT2	0.00				
BREAK POINT3	0.00				
BREAK POINT4	0.00				
PREV. NEXT LIST P DOWN ▼					
PGH2					2:14PM

The screen continues.

Program each item as follows:

- **TAX RATE (Use the numeric entry method)**

Tax rate for the tax table (max. 7 digits: 0.0000 to 999.9999)

- **CYCLE (Use the numeric entry method)**

Range of the minimum breakpoint on a regular cycle for the tax table (max. 4 digits: 0.01 to 99.99)

See the description of "M" on the previous page.

- **INITIAL TAX (Use the numeric entry method)**

Initial tax amount for the tax table (max. 3 digits: 0.01 to 9.99)

See the description of "T" on the previous page.

- **LOWER LIMIT (Use the numeric entry method)**

Minimum taxable amount for the tax table (max. 5 digits: 0.01 to 999.99)

See the description of "Q" on the previous page.

- **BREAK POINT1 thru 72 (Use the numeric entry method)**

Breakpoints programmable for the tax table (max. 5 digits: 0.01 to 999.99)

72 breakpoints can be programmed for each tax table. (When the interval between breakpoints is one dollar or more and less than one hundred dollars, 36 breakpoints are programmed for each tax table.)

■ Rate (%) tax

You can program a tax rate for each tax rate number.

Procedure

Select a pertinent tax no. from the taxes list.

↓

TAX2	P UP ▲	CAN	CEL	.	CL
1 TABLE TAX					
2 %TAX		7	8	9	
		4	5	6	
		1	2	3	
		0	00	ENTR	

PREV. NEXT LIST P DOWN ▼

PGM2 2 21PH

↓

%TAX	P UP ▲	CAN	CEL	.	CL
TAX RATE	0.0000%	7	8	9	
LOWER LIMIT	0.00	4	5	6	
		1	2	3	
		0	00	ENTR	

PREV. NEXT LIST P DOWN ▼

PGM2 2 23PH

Program each item as follows:

- **TAX RATE (Use the numeric entry method)**

Tax rate (max. 7 digits: 0.0000 to 999.9999%)

- **LOWER LIMIT (Use the numeric entry method)**

Lowest taxable amount (max. 5 digits: 0.01 to 999.99)

■ Doughnut tax exemption (for the Canadian tax system)

Procedure

DOUGHNUT EXEMPT	P UP ▲	CAN	CEL	.	CL
QUANTITY	0	7	8	9	
		4	5	6	
		1	2	3	
		0	00	ENTR	

PREV. NEXT LIST P DOWN ▼

PGM2 6 04PH

Program the item as follows:

- **QUANTITY (Use the numeric entry method)**

Quantity for the doughnut tax exempt (for Canadian tax)
(max. 2 digits: 1 to 99/0)

NOTE

This option is available only when the Canadian tax system is selected.

TRAINING Mode Selection

Use the following procedure to select the training mode:

■ TRAINING mode

You will use the TRAINING mode if you need to train someone in machine operations without any change in POS terminal's memory. Reports are not available. When the training is completed, exit this mode and put your POS terminal back into the normal mode of operation.

Procedure

SETTING	↑↓	P UP ▲	CAN	CEL	.	CL
17 NEGATIVE#						
18 POSITIVE#			7	8	9	
19 MACRO KEY						
20 FUNCTION KEY			4	5	6	
21 CAPTURE KEY						
22 CAPTURE JOB#			1	2	3	
23 TAX						
24 TRAINING			0	00	ENTR	
PREV. NEXT LIST P DOWN ▼						

PGM2 2:26PM



TRAINING	P UP ▲	CAN	CEL	.	CL
TRAINING MODE	NO				
		7	8	9	
		4	5	6	
		1	2	3	
		0	00	ENTR	
PREV. NEXT LIST P DOWN ▼					

PGM2 3:01PM

Program the item as follows:

• TRAINING MODE (Use the selective entry method)

YES : The training mode is valid.

NO : The training mode is not valid.

NOTE

- All operations in the training mode are the same as the REG mode operations.
 - In the training mode, the consecutive number is incremented.
 - The cash drawer does not open in the training mode.
- No item data is sent to the remote printers in the training mode.

Backup Data Send Programming

Use the following procedure for backup data send programming:

NOTE

For more information, please consult your authorized SHARP dealer.

Backup data send

Your POS terminal can send data to another device via RS232 for the purpose of backing up its program.

Procedure

SETTING	↑ P UP ▲	CAN CEL	.	CL
19 MACRO KEY				
20 FUNCTION KEY		7	8	9
21 CAPTURE KEY				
22 CAPTURE JOB#		4	5	6
23 TAX				
24 TRAINING		1	2	3
25 BACKUP SEND				
26 BACKUP RECEIVE		0	00	ENTR
PREV. NEXT LIST P DOWN ▼				
PGH2				3:02PM



BACKUP SEND	↑ P UP ▲	CAN CEL	.	CL
SEND DATA	ALL RAM			
SPEED	PROGRAMMED	7	8	9
		4	5	6
		1	2	3
		0	00	ENTR
PREV. NEXT LIST P DOWN ▼				
PGH2				3:03PM

Program each item as follows:

• SEND DATA (Use the selective entry method)

Select one of the following options (data sources):

- ALL RAM
- SSP

• SPEED (Use the selective entry method)

Select one of the following options (data transmission speeds):

PROGRAMMED: Sends data at a programmed speed.

38400bps: Sends data at 38400 bps.

19200bps: Sends data at 19200 bps.

9600bps: Sends data at 9600 bps.

4800bps: Sends data at 4800 bps.

2400bps: Sends data at 2400 bps.

Backup Data Receive Programming

Use the following procedure for backup data receive programming:

NOTE

For more information, please consult your authorized SHARP dealer.

Backup data receive

Your POS terminal can receive data from another device via RS232 which has previously received the data.

Procedure

SETTING	↑	P UP	▲	CAN	·	CL
19 MACRO KEY				CEL		
20 FUNCTION KEY				7	8	9
21 CAPTURE KEY						
22 CAPTURE JOB#				4	5	6
23 TAX						
24 TRAINING				1	2	3
25 BACKUP SEND						
26 BACKUP RECEIVE				0	00	ENTR
PREV.	NEXT	LIST	P DOWN			
PGM2						3:03PM



BACKUP RECEIVE	P UP	▲	CAN	·	CL
SPEED	PROGRAMMED		CEL		
			7	8	9
			4	5	6
			1	2	3
			0	00	ENTR
PREV.	NEXT	LIST	P DOWN		
PGM2					3:03PM

Program the item as follows:

• SPEED (Use the selective entry method)

Select one of the following options (data transmission speeds):

PROGRAMMED: Receives data at a programmed speed.

38400bps: Receives data at 38400 bps.

19200bps: Receives data at 19200 bps.

9600bps: Receives data at 9600 bps.

4800bps: Receives data at 4800 bps.

2400bps: Receives data at 2400 bps.

CAUTION: The receiving unit must have equal or larger memories than the terminal sending the program.

PLU Updating (in the PGM1 Mode)

The PLU UPDATE option is primarily used by a supervisor or manager to change the PLU's unit price or name daily.

Procedure

To program a unit price or name for the PLU, proceed as follows:

PGM1 MODE		P UP ▲	CAN CEL	.	CL
1	READING		7	8	9
2	SETTING		4	5	6
3	PLU UPDATE		1	2	3
			0	00	ENTR
PREV.	NEXT	LIST	P DOWN ▼		
PGM1					
3 05PM					



PLU/UPC	P UP ▲	CAN CEL	.	CL
00001	PL00001	7	8	9
00002	PL00002	4	5	6
00003	PL00003	1	2	3
00004	PL00004	0	00	ENTR
PREV.	NEXT	LIST	P DOWN ▼	
PGM1				
3:05PM				



00001	P UP ▲	CAN CEL	.	CL
PRICE 1	0.00	7	8	9
NAME1	PL00001	4	5	6
KP TEXT1	PL00001	1	2	3
		0	00	ENTR
PREV.	NEXT	LIST	P DOWN ▼	
PGM1				
3 06PM				

1. In the PGM1 window, press the (UPDATE) key or select the option "3 PLU UPDATE".
 - The PLU list will appear.

2. Select the desired PLU code from the list.

3. Program a unit price or name for the corresponding price level.
 - *PRICE1 thru 6 (Use the numeric entry method)
 - Unit price of each price level (max. 6 digits)
 - *NAME1 thru 6 (Use the character entry method)
 - Name of each price level. Up to 8 or 16 characters can be entered.
 - *KP TEXT 1 thru 6 (Use the character entry method)
 - Description (text) for kitchen printer for each price level. Up to 12 characters can be entered.

NOTE

* On the sample screen, the price level 1 setting is only shown. Depending on the default settings, you may see the price level 1 through 6 settings on the screen. Please consult your authorized SHARP dealer for more details.

Automatic Sequencing Key Programming

If you program AUTO keys (automatic sequencing keys) for frequently performed key operations, you can enter those key operations simply by pressing the corresponding AUTO keys.

Procedure

Select "03 AUTO KEY" from the PGM2 window.

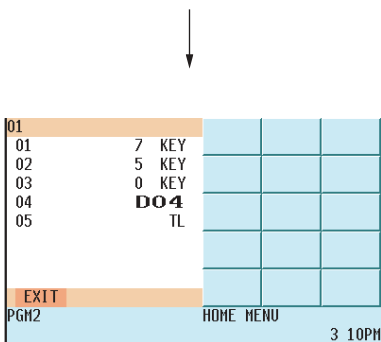
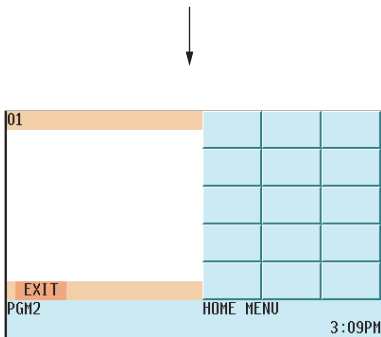
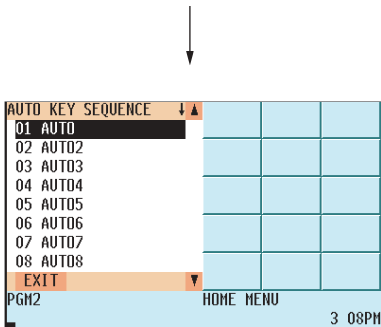

To program automatic sequencing keys as follows:

1. Select the automatic sequencing key which you want to program.
2. Enter the desired sequence for the automatic sequencing key in the programmed sequence.

750 → →
3. To end programming for the key, touch "EXIT" in the lower left corner of the display.
4. To program another automatic sequencing key, repeat the above steps.
5. To end programming automatic sequencing keys, press the key.

Loading Dynamic UPC to the Main UPC File

The UPC master file (main file) can be updated by loading the data in the dynamic UPC file to the UPC master file.

Procedure

PGM2 MODE	↓ P UP ▲	CAN	.	CL
01 READING		CEL		
02 SETTING		7	8	9
03 AUTO KEY				
04 D-UPC LOAD		4	5	6
05 DATA CLEAR				
06 OPEN STORE		1	2	3
07 CLOSE STORE				
08 KP READING		0	00	ENTR
PREV. NEXT LIST P DOWN ▼				
PGM2				3:12PM



	↓ P UP ▲	CAN	.	CL
ARE YOU SURE ?		CEL		
1 YES		7	8	9
2 NO		4	5	6
		1	2	3
		0	00	ENTR
PREV. NEXT LIST P DOWN ▼				
PGM2				3:12PM

To loading dynamic UPC, proceed as follows:

1. Select "4 D-UPC LOAD" from the PGM2 window.

2. Select "YES" or "NO", and press the ENTER key.

SD CARD Mode

In the SD CARD mode, you can save the data stored in your POS terminal into an SD card or load data from the SA card for various purposes. The types of data available in this mode are as follows:

- Sales data
- Electronic journal data
- T-LOG data
- Programming data
- All RAM data

Use the following procedure for operation in the SD CARD mode.

Installing SD card

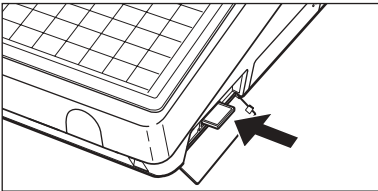
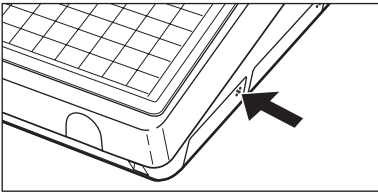

1. Push the SD card slot cover part indicated by the arrow to open the cover.
* To close the cover, push the arrowed part in until you hear it click.

2. Insert the SD card into the slot.
* To remove the SD card, push it again, and it comes out of the slot.

Procedure

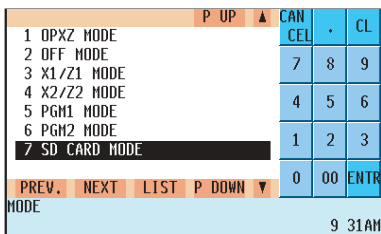

1. Select "7 SD CARD MODE" in the mode selection window.

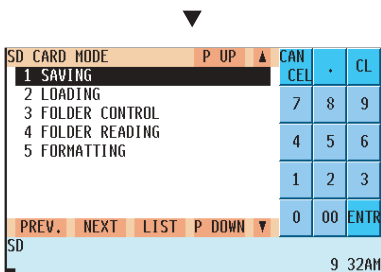

2. Select the desired type of operation.

In each menu of this mode, you can perform the following operations:

1 SAVING

1 SAVE ONLY : Saves the following data of the POS terminal to the SD card.

- 1 SALES DATA
- 2 EJ DATA
- 3 T-LOG DATA
- 4 PROGRAMMING DATA

2 SAVE & CLEAR : Saves the following data of the POS terminal to the SD card and clears them from the POS terminal.

- 1 EJ DATA
- 2 T-LOG DATA

2 LOADING : Loads the following data from the SD card to the POS terminal.

- 1 PROGRAMMING DATA
- 2 CUSTOMER NAME LIST

3 FOLDER CONTROL

1 FOLDER NAME : Specifies the name of the folder to be created, save and load the data into and from.

2 FOLDER CREATE : Creates a new user folder.

4 FOLDER READING : Reads the content of the folder saved in the SD card.

5 FORMATTING : Formats the SD card.

NOTE

- For details, please consult your authorized SHARP dealer.
- To save or load all RAM data, please consult your authorized SHARP dealer.
- This model supports SD cards only. Use of any other types of SD cards such as miniSD, microSD, etc. with an adapter is not supported.
- Do not turn off the POS terminal when it is accessing the SD card. The data in the card may be broken.
- Formatting the SD card erases all the data in it.

Reading Stored Programs

You can read programs stored in the PGM1 or PGM2 mode.

■ Program reading sequence

To read those programs stored in the PGM1 or PGM2 mode, use the following procedure:

1. In the mode selection window, select the PGM1 or PGM2 and press the key.
2. Select "01 READING" from the PGM1 or PGM2 mode window to display the items list.
3. Select an item listed in the table shown later.
4. Where "RANGE" and/or "PICK UP" are displayed on the screen, select either option. Select "RANGE" to read program by range, and "PICK UP" to read program by picking up codes. The procedure to specify a range or to pick up codes are the same as the one in sales report.
On the table, for the item you can specify a range, "*"1" is indicated, and for the item you can pick up codes, "**2" is indicated.

Item:	Description:	Available mode:
1 DEPARTMENT *1	Department	PGM1 or PGM2
2 PLU/UPC *2	PLU/UPC	PGM1 or PGM2
3 DYNAMIC UPC *2	Dynamic UPC	PGM1 or PGM2
4 LINK PLU TABLE *1	Link PLU table	PGM2
5 CONDIMENT TABLE. *1	Condiment table	PGM2
6 MIX&MATCH	Mix-and-match table	PGM2
7 COMBO MEAL *1	Combo meal table	PGM2
8 UPC OTHER	UPC others	PGM2
9 SCALE TABLE	Scale table	PGM2
10 FUNCTION	Function	PGM1 or PGM2
11 MEDIA	Media key	PGM2
12 SERVER	Server	PGM1 or PGM2
13 MANAGER	Manager	PGM2
14 OPTIONAL	Optional feature	PGM2
15 FUNCTION TEXT	Function text	PGM2
16 DEPT. GROUP	Department group	PGM2
17 PLU GROUP	PLU/UPC group	PGM2
18 SERVER GROUP	Server group	PGM2
19 TEXT	Text	PGM2
20 TAX	Tax	PGM2
21 GLU CODE	GLU	PGM2
22 CUSTOMER *1	Customer	PGM2
23 CUSTOMER PROGRAM.	Customer programming	PGM2
24 NEGATIVE #	Negative no.	PGM2
25 POSITIVE #	Positive no.	PGM2
26 AUTO KEY	Automatic sequencing key	PGM2
27 MACRO KEY	Macro key	PGM2
28 CAPTURE KEY	Capture key	PGM2
29 CAPTURE JOB#	Capture job	PGM2
30 DEVICE CONFIG	Device configuration	PGM2
31 DIRECT KEY	Direct key	PGM2
32 FUNCTION KEY	Function key	PGM2
33 FUNCTION MENU KEY	Function menu key	PGM2
34 PLU MENU KEY	PLU menu key	PGM2

■ Sample printouts

• Departments (PGM1 or PGM2 mode)

Date	12/06/2008	000001	Machine number	
Consecutive number	#1437	1:47PM	MIKE0001	Server name/server code
Operating mode*	*PGM2*			
Report type	DEPARTMENT			
Dept. code	D01	2.00	Unit price	
Item label	DPT.01	GO	Group no.	
Tax status	T 2 00	A00	Age limitation	
Server group no.	0000030 110	00	CVM control character	
	SO KP00000	L17/10	HALO/LALO	
	D02	0.00	Print station	
	DPT.02	GO	Function programming	
Group discount status (1/2/3)	T1 00	A00	0 0 0 0 3	
	0000010 000	00	Type of unit price entry (open & preset/preset/open/inhibit)	
	SO KP00000	L17/10	Gas/BR/Hash/Normal	
	D03	0.00	SIF/SICS/Normal	
	DPT.03	GO	Scale status (compulsory/enable/inhibit)	
	T1 00	A00	Tara table no.	
	0000010 000	00	Validation printing (compulsory/non-compulsory)	
	SO KP00000	L17/10		
	D04	0.00		
	DPT.10	GO	Minus department	
	T1 00	A00		
	0000010 000	00		
	SO KP00000	L17/10		

* When you take this report in the PGM1 mode, "PGM2" is replaced by "PGM1."

• PLU/UPC (PGM1 or PGM2 mode)

12/06/2008 000001
#1518 11:44AM

PGM2

Report type PLU/UPC

Dept. code

PLU code P00001 (01) 0

Zero price (allowed/disallowed) 1 1.50

M00 C00 000 000 A00
#00 TO 000 00000300
00 00 00 00 00
P00000 KP00000 PGO 00
S 0.000 M 0.000

PL00001
P00002 (01) 0

Condiment table no. 1 2.00

Mix & match table no. M00 C00 000 000 A00
Link PLU table no. #00 TO 000 00000200
Scale table no. 00 00 00 00 00

Coupon object PLU P00000 KP00000 PGO 00
Print station S 0.000 M 0.000

PL00002
P00003 (01) 0

PL00003
1 3.00

00003

ITEM A
5099887654303#(01) 0

ITEM B
1 3.50

ITEM B
G00 00 00 A00
M00 C00 000 000 A00
#00 TO 000 00000200
00 00 00 00 00
P00000 KP00000 PGO 00
S 0.000 M 0.000

ITEM B
5099887654304#(01) 0

ITEM M
1 4.50

ITEM M
G00 00 00 A00
M00 C00 000 000 A00
#00 TO 000 00000200
00 00 00 00 00
P00000 KP00000 PGO 00
S 0.000 M 0.000

ITEM M

Group nos.

Base q'ty

PLU's menu type
Blank : Normal PLU
L : Link PLU
C : Combo meal

Price level 1

Group discount status (1/2/3)

Age limitation

Key data entry job no.

CVM control character

Minimum stock q'ty

Priority group no.

Stock q'ty

Function programming
0 0 0 0 0 2
L Mode parameter (open & preset/preset/open/inhibit)
L Scale status (compulsory/allowed/prohibited)
L Condiment entry to menu item (compulsory/non-compulsory)
L Condiment type/non-condiment type
L Price shift (compulsory/prohibited/allowed)
L Repeat round (Yes/no)

NOTE The UPC codes are printed in the sequence shown below.

UPC-A
UPC-E
EAN-13
EAN-8

(for UPC)

Blank: Auto delete }
* : No delete }

• Link PLU table (PGM2 mode)

12/06/2008		000001
#1523	12:13PM	
PGM2		
LINK PLU TABLE		
#01		P00011
		P00012
		P00013
		P00014
		P00015
		P00016
		P00017
#02		

Report type: LINK PLU TABLE
 Link PLU table no.: #01
 Assigned PLU codes: P00011-P00017

• Mix & Match table (PGM2 mode)

12/06/2008		000001
#1524	12:13PM	
PGM2		
MIX&MATCH		
#01	/ 3	5.75
#01		
#02	/ 5	11.25
#02		
#03	/12	250.00
#03		

Report type: MIX&MATCH
 Mix & Match table no.: #01
 Price: 5.75
 Base qty: 3

• Condiment table (PGM2 mode)

12/06/2008		000001
#1440	1:50PM	MIKE0001
PGM2		
CONDIMENT TABLE		
#01	/1	P00023
		P00024
		P00025
		#04
HOW COOK?		P00031
#04	/2	P00032
		P00033
POTATO?		#00

Report type: CONDIMENT TABLE
 Condiment table no.: #01
 Assigned PLU codes: P00023-P00025
 Next table#: #04
 Number of repeats: 1

• Dynamic UPC (PGM2 mode)

12/06/2008		000001
#1527	1:54PM	
PGM2		
DYNAMIC UPC		
5067891234506#(01)		1
ITEM N1		
1		1.10
ITEM N1		
	G00 00 00	A00
M00 C00		00
#00 TO	000 00000200	
	00 00 00 00 00	
	P00000 KP00000 PGO 00	
ITEM N1		

• Combo meal table (PGM2 mode)

12/06/2008	000001
#1606	6:24PM MIKE0001
PGM2	
COMBO MEAL	Report type
#01	Combo table no.
CHICKEN COMBO	Combo meal text
CKN CB	Kitchen printer text
COO 0 00	Condiment entry to menu item (compulsory/non-compulsory)
KP01000 PGO 00	Print station/Priority group no./CVM control character
P00018	Associated PLU text
1.20	Associated PLU unit price (PRICE1)
1.30	Associated PLU upsize price (PRICE2)
P00019	
2.10	
2.15	
P00020	
1.75	
1.80	

Condiment table no.

• Scale tare table (PGM2 mode)

12/06/2008	000001
#1444	1:57PM MIKE0001
PGM2	
SCALE TABLE	Report type
#1	Scale table no.
	Weight
#2	0.00
#3	0.00
#4	0.00
#5	0.00
#6	0.00
#7	0.00
#8	0.00
#9	0.00

• UPC other (PGM2 mode)

12/06/2008	000001
#1531	2:13PM
PGM2	
UPC OTHER	
UPC NON-PLU	
02	5 4 0 1 2
2	2 4 0 0 2
UPC DELETE	
	99

• Functions (PGM1 or PGM2 mode)

12/06/2008 000001		#1543 3:31PM	
PGM2			
FUNCTION			Group discount status (1/2/3)
(-) 1		-1.00	Report type
I T1 R1		L17	Sign (plus/minus)
100		00	Amount
		P00001	Function text
		P00002	Key data entry job no.
		P00003	
		P00004	Associated PLUs (max. 20 items)
		P00005	
		P00007	
		P00030	
(-) 2		-2.00	Amount
S T1 R1		L17	HALO
100		00	Tax status
		P00001	
		P00002	
		P00003	
		P00007	Type
		P00030	I=Item
			S=Subtotal
%1		-10.00%	
S T1 R1		L100.00%	HALO
000		00	
		P00003	
		P00005	
		P00008	
		P00009	
		P00010	
%2		-15.00%	
I T 2 R1		L100.00%	Key data entry job no.
010		00	
		P00006	
		P00007	
		P00008	
GAS (-)28		0.00	
GRATUITY		0.00%	
CA TIP		0.00%	
		L17	
CH TIP			
***RA		L18	
		00	
***RA2		L18	
		00	
		0000	
***PO		L18	
		00	
***PO2		L18	
		00	
M-TAX		L17	
		00	
TAX DELETE		00	
NO SALE		00	
DIRECT VOID		00	
PAST VOID		00	
SBTL VOID		00	
REFUND		00	
RETURN		00	

• Media (PGM2 mode)

12/06/2008 000001		#1446 1:57PM MIKE0001	
PGM2			
MEDIA			Report type
CASH		KP0000 L18	Print station
		0000000000 00	HALO
		0000000000	Function text
		00000000001	Function programming (2)
			Function programming (3)
CHECK1		KP0000 L18	Function programming (1)/
		0000000000 00	Key data entry job no.
		0000000000	
		00000000001	
CHARGE1		KP0000 L18	Function text (gross)
CHARGE1-		0000000000 00	Function text (refund)
		0000000000	
		00000000001	
CONV 1		0.0000	Rate
		DO	
CONV 2		0.0000	
		DO	
CONV 3		0.0000	
		DO	
CONV 4			Tax status
		DO	
SERVICE		KP0000	
		000 00	Function programming/
		00000000001	Key data entry job no.
		0.00	
		0	
FINAL		KP0000	
		000 00	
		00000000001	
		0.00	
		0	
****CID		9999999.99	Sentinel
CHK/CG		999999.99	HALO
1 CENTS		0.01	
5 CENTS		0.05	
10 CENTS		0.10	
25 CENTS		0.25	
50 CENTS		0.50	
100 CENTS		1.00	
\$1		1.00	
\$2		2.00	
\$5		5.00	

• Server (PGM1 or PGM2 mode)

```

12/06/2008 000001
#1447 1:58PM MIKE0001

*PGM2*
SERVER _____ Report type
Server code
SRV#0001 MIKE Server name
RANGE 1-9999 Linked GLU
0.00% 0001 (0000) codes
SRV#0002 JACK Function
RANGE 1-9999 0.00% 0001 (0000) programming
SRV#0003 SUE Net sales %
RANGE 1-9999 0.00%

```

```

SRV#0014 SERV. 014
RANGE 1-9999 0.00% 0001 (0000)
SRV#0015 SERV. 015
RANGE 1-9999 0.00% 0001 (0000)

```

• Customer (PGM2 mode)

```

12/06/2008 000001
#1538 2:34PM

*PGM2*
CUSTOMER
#00000000000001
MR. JAMES
#00000000000002
MR&MRS SMITH
ADDRESS A
123 4567 0890

```

• Customer control (PGM2 mode)

```

12/06/2008 000001
#1539 2:34PM

*PGM2*
CUSTOMER PROGRAM

PBAL DISPLAY 99 YES
SERVICE DISPLAY YES

```

• Negative no. (PGM2 mode)

```

12/06/2008 000001
#1540 2:34PM

*PGM2*
NEGATIVE#
#0000000000000001 0
#0000000000000123 0
#0000000000000345 0

```

• Positive no. (PGM2 mode)

```

12/06/2008 000001
#1541 2:34PM

*PGM2*
POSITIVE#
#0000000000000001
#00000000000003030
#00000000000006561

```

• Manager (PGM2 mode)

```

12/06/2008 000001
#1448 1:58PM MIKE0001

*PGM2*
MANAGER
MGR#01 1234

```

• Optional features (PGM2 mode)

```

12/06/2008 000001
#1449 1:58PM MIKE0001

*PGM2*
OPTIONAL ----- Report type

OPTIONAL
FUNC. PROHIBIT
OPX/Z REPORT          ENABLE ----- Setting
PAID OUT              PUBLIC
RFND SALES            PUBLIC
REFUND/RETURN        PUBLIC
1st LAST VOID        ENABLE
DIRECT VOID           PUBLIC
INDIRECT VOID        LIMITED
SUBTOTAL VOID        PUBLIC
VOID MODE            PUBLIC
NO SALE              PUBLIC
PAY WHEN ST=0        ENABLE
TIP PAID             PUBLIC
TRANS IN/OUT         PUBLIC
INDIRECT VOID (GLU)  ENABLE
OPEN GLU DISPLAY     ENABLE
UPC LEARNING         ENABLE
PRICE CHANGE         PUBLIC
CUSTOMER LEARNING    ENABLE
CUSTOMER TEL#        ENABLE

FUNC. SELECT1
ITEM VP              ENABLE
RF/RT VP            NON-COMPULSORY
(-) VP              NON-COMPULSORY
CA/CHK VP           NON-COMPULSORY
RA VP               NON-COMPULSORY
PO VP               NON-COMPULSORY
TIP VP              NON-COMPULSORY
LEVEL SHIFT TYPE    AUTO
LEVEL SHIFT          PUBLIC
PRICE SHIFT TYPE     AUTO
PRICE SHIFT          PUBLIC
RETURN TO LEVEL1    BY ITEM
RETURN TO PRICE1    BY ITEM

FUNC. SELECT2
SEAT#                INHIBIT
COVER CT             NON-COMPULSORY
TIP ENTRY            AMOUNT
SERVER DRAWER        INHIBIT
SHIFT KEY ACTION     CAPS
AUTO HOURLY          ENABLE
CONDIMENT CANCEL     PUBLIC
ISBN PRICE           COMPULSORY
CUSTOMER DATA       DETAIL
SERVER POPUP         DISABLE
T-LOG FULL           CONTINUE
E. J. FULL           LOCK
CAPTURE FULL         CONTINUE
  
```

```

PURCHASE No.        NO
TIME                YES
JOURNAL SELECT      FULL
JOURNAL SIZE        SMALL
ITEM ON BILL        NO
SHARE%              YES
REORDER KP MESSAGE  YES
CUSTOMER REPORT     CHARGE
BIRTHDAY            YES
TAX STATUS RJ       NO
TAX STATUS BILL     NO
TAX STATUS KP       YES
CUST. CODE&NAME KP  NO
CUST. ADDRESS KP    NO
CUST. TELEPHONE# KP NO

INTERVAL TIMER
TILL TIMER          0
SCREEN SAVE         0
DRAWER ALARM        0

DEFAULT MENU LEVEL
DEFAULT MENU LEVEL 1

AVAILABLE GLU#
START CODE          1
END CODE            9999

BILL NUMBER
BILL NUMBER         1006

BRIGHTNESS
BRIGHTNESS          0

0 SKIP
SERVER              SKIP
TRANSACTION         SKIP
DEPARTMENT          SKIP
PLU/UPC             SKIP
HOURLY              SKIP
SCM                 SKIP
DAILY NET           SKIP

HOURLY REPORT
MEMORY TYPE         30
STARTING TIME       00

STACKED REPORT
1
2
  
```

To be continued

• Function text (PGM2 mode)

```

12/06/2008 000001
#1450 2:00PM MIKE0001

*PGM2*
FUNCTION TEXT
NET1 NET1
TAX1 ST TAX1 ST
GRS TAX1 GRS TAX1
RFD TAX1 RFD TAX1
TAX1 TAX1
TX1 EXPT TX1 EXPT
TAX2 ST TAX2 ST
GRS TAX2 GRS TAX2
RFD TAX2 RFD TAX2
TAX2 TAX2
TX2 EXPT TX2 EXPT
TAX3 ST TAX3 ST
GRS TAX3 GRS TAX3
RFD TAX3 RFD TAX3
TAX3 TAX3
TX3 EXPT TX3 EXPT
TAX4 ST TAX4 ST
GRS TAX4 GRS TAX4
RFD TAX4 RFD TAX4
TAX4 TAX4
TX4 EXPT TX4 EXPT
TAX5 ST TAX5 ST
GRS TAX5 GRS TAX5
RFD TAX5 RFD TAX5
TAX5 TAX5
TX5 EXPT TX5 EXPT
GRS MTAX GRS MTAX
RFD MTAX RFD MTAX
TTL TAX TTL TAX
NET NET
NET2 NET2
CP PLU CP PLU
V. CP UPC V. CP UPC
DISCOUNT DISCOUNT
MGR VD MGR VD
VOID VOID
DRW CNT DRW CNT
    
```

Report type
Function text (default)
Text (preset)

```

*DEPT TL *DEPT TL
DEPT (-) DEPT (-)
SUBTOTAL SUBTOTAL
MDSE ST MDSE ST
***TOTAL ***TOTAL
CHANGE CHANGE
DUE DUE
TIP DUE TIP DUE
ITEMS ITEMS
CHARGE CHARGE
BALANCE BALANCE
COPY COPY
B. T. B. T.
FIN. BAL FIN. BAL
BAL FWD BAL FWD
CLOSE CK CLOSE CK
OPEN CK OPEN CK
(%) SALES (%) SALES
VAT EXPT VAT EXPT
TARE WT. TARE WT.
RCP S.W. RCP S.W.
FREE GLU FREE GLU
AVE SALE AVE SALE
ST (-) TL ST (-) TL
ST % TL ST % TL
(-) TL (-) TL
% TL % TL
GDISC%TL GDISC%TL
CASH TL CASH TL
RA TL RA TL
PO TL PO TL
CA/CK TL CA/CK TL
CONV TL CONV TL
CHR TL CHR TL
CHECK TL CHECK TL
COMBO COMBO
RF RF
CP CP
NET SLS NET SLS
COMBO TL COMBO TL
WASTE TL WASTE TL
RF TL RF TL
NET TL NET TL
TBL# TBL#
SIGN-ON SIGN-ON
SIGN-OFF SIGN-OFF
CB CA CB CA
CB CA2 CB CA2
    
```

```

CB CHK8 CB CHK8
CB CHK9 CB CHK9
CASH BACK CashBack
CB TL CB TL
CG+CB CG+CB
SCM (+) SCM (+)
SCM (-) SCM (-)
SCM TTL SCM TTL
CASH IS CASH IS
CHECK1 IS CHECK1 IS
CHECK2 IS CHECK2 IS
CHECK3 IS CHECK3 IS
CHECK4 IS CHECK4 IS
CHECK5 IS CHECK5 IS
CHECK6 IS CHECK6 IS
CHECK7 IS CHECK7 IS
CHECK8 IS CHECK8 IS
CHECK9 IS CHECK9 IS
COMBO1 COMBO1
    
```

```

COMBO98 COMBO98
COMBO99 COMBO99
    
```

To be continued

To be continued

• Department group text (PGM2 mode)

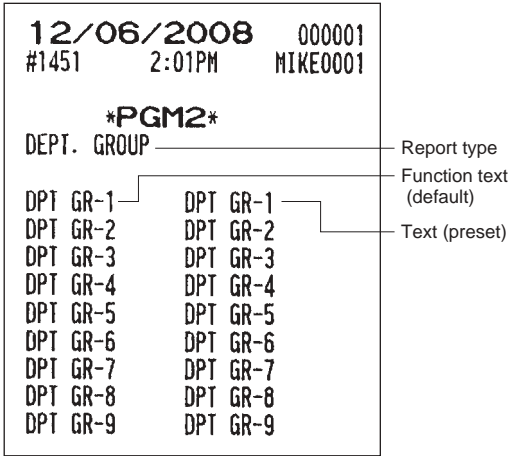

• Server group text (PGM2 mode)

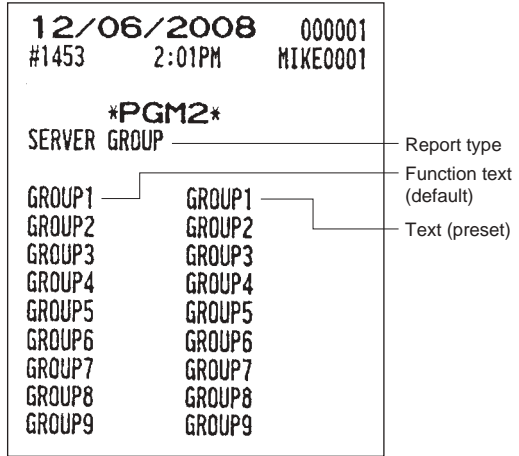

• PLU group text (PGM2 mode)

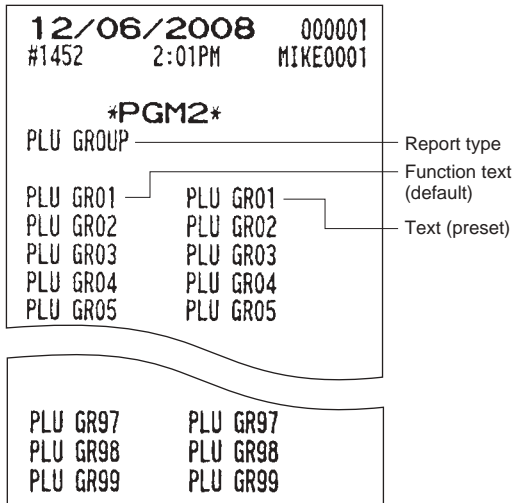

• Logo text (PGM2 mode)

```

12/06/2008 000001
#1454 2:01PM MIKE0001

*PGM2*
TEXT _____ Report type

      SHARP
      PRESENTS THE
      BEST MACHINE
      _____ Receipt logo text

VP TEXT
FOR DEPOSIT ONLY

BILL LOGO
HEADER _____ Header text for
bill printer

FOOTER _____ Footer text for
bill printer

MESSAGE TEXT
1 MESSAGE 1 00
2 MESSAGE 2 00
3 MESSAGE 3 00
4 MESSAGE 4 00
5 MESSAGE 5 00

SCROLL POLE DISP.
    
```

• Tax rate (PGM2 mode)

```

12/06/2008 000001
#1455 2:02PM MIKE0001

*PGM2*
TAX _____ Report type

TAX1 _____ Tax no.
      6.0000 % Rate
      / 1.00 Cycle
      1 0.11 Lower tax limit
      2 0.23
      3 0.39
      4 0.57 Breakpoint
      5 0.73 amount
      6 0.89
      7 1.11
TAX2 4.0000 % Lower tax limit
      0.12
TAX3 5.0000 %
      0.20 Doughnut tax
TAX4 _____ exempt count
TAX5 _____
    
```

• AUTO key (PGM2 mode)

```

12/06/2008 000001
#1461 2:03PM MIKE0001

*PGM2*
AUTO KEY _____ Report type

#01 _____ AUTO key no.
      7 KEY
      5 KEY
      0 KEY Entry sequence
      DO4 programmed
      TL
#02
      P00001
      P00002
    
```

• GLU code (PGM2 mode)

```

12/06/2008 000001
#1537 2:34PM

*PGM2*
GLU CODE _____ Report type

GLU _____ Start code
      1-9999 End code
    
```

```

#91 -----
#92 -----
#93 -----
#94 -----
#95 -----
#96 -----
#97 -----
#98 -----
#99 -----
    
```

• Macro key (PGM2 mode)

```

12/06/2008 000001
#1462 2:03PM MIKE0001

*PGM2*
MACRO KEY

MACRO#1 -----
MACRO#2 -----
MACRO#3 -----
MACRO#4 -----
    
```

• Capture key (PGM2 mode)

```

12/06/2008 000001
#1463 2:04PM MIKE0001

*PGM2*
CAPTURE KEY

#1 CAPTURE01
10 00
#2 CAPTURE02
10 00
#3 CAPTURE03
10 00
#4 CAPTURE04
10 00
#5 CAPTURE05
10 00
#6 CAPTURE06
10 00
#7 CAPTURE07
10 00
#8 CAPTURE08
10 00
#9 CAPTURE09
10 00
#10 CAPTURE10
10 00
    
```

• Function menu key (PGM2 mode)

```

12/06/2008 000001
#1468 2:06PM MIKE0001

*PGM2*
FUNCTION MENU KEY

#01 MISC MENU
01 RCP_ON/OFF 080
02 RA 259
03 RA2 260
04 PO 261
05 PO2 262
06 CA/CHK_1 263
07 CA/CHK_2 264
08 CA/CHK_3 265
09 CA/CHK_4 266
10 CA/CHK_5 267
11 CA/CHK_6 268
12 CA/CHK_7 269
13 CA/CHK_8 270
14 CA/CHK_9 271
15 NS 034

#02 CASH MENU
01 CASH_TOTAL 025
02 CA2 233
03 CA3 234
04 CA4 235
05 CA5 236
06 INHIBIT ---
07 INHIBIT ---

13 INHIBIT ---
14 INHIBIT ---
15 INHIBIT ---
    
```

• Capture job no. (PGM2 mode)

```

12/06/2008 000001
#1545 6:10PM

*PGM2*
CAPTURE JOB#

#01
MSG #1
0 13 00 1
MSG #2
0 13 00 1
MSG #3
0 13 00 1
MSG #4
0 13 00 1

#02
MSG #11
0 13 00 1
MSG #12
0 13 00 1
MSG #13
0 13 00 1
MSG #14
0 13 00 1
    
```

• Device configuration (PGM2 mode)

```

12/06/2008 000001
#1465 2:04PM MIKE0001

*PGM2*
DEVICE CONFIG
BUILT-IN PRINTER 50
IMAGE FOOTER NOT PRINT
JOURNAL PRINTER T#000-C#0
BUILT-IN
EXTERNAL JOURNAL ---
RECEIPT PRINTER
BILL PRINTER 0 YES
REPORT PRINTER ---
T#000-C#0
YES
PRINT
BUILT-IN
VALIDATION(VP) ---
KP#1 ---
KP#2 ---
    
```

```

EFT ---
PIN PAD ---
BCR(SCANNER) ---
BERG(BAR) ---
SCALE ---
COIN DISPENSER ---
ONLINE ---
CVM DATA I/F ---
PREPAID CARD ---
ONL ACCT BAL ---
IC CARD ---
POLE DISPLAY 000
    
```

• PLU menu key (PGM2 mode)

```

12/06/2008 000001
#1469 2:15PM MIKE0001

*PGM2*
PLU MENU KEY
#01
PLU001
AUTO RETURN
P00001
P00002
P00003
P00004
P00005
P00006
P00007
P00008
P00009
P00010
P00011
P00012
P00013
P00014
P00015
#02
PLU002
AUTO RETURN
P00021
P00022
P00023
P00024
P00025
P00026
P00027
P00028
P00029
P00030
P00031
P00032
P00033
P00034
P00035
    
```

```

#08
PLU001
AUTO RETURN
P00101
P00102
P00103
P00104
P00105
P00106
P00107
P00108
P00109
P00110
P00111
P00112
P00113
P00114
P00115
    
```

• Direct key (PGM2 mode)

12/06/2008			000001
#1466	2:04PM	MIKE0001	
PGM2			
DIRECT KEY			
001	L1	P00001	
	L2	----	
	L3	----	
	L4	----	
	L5	----	
002	L1	P00012	
	L2	----	
092	L5	----	
	L1	P00044	
	L2	----	
	L3	----	
	L4	----	
093	L5	----	
	L1	----	
094	L1	----	
140	L1	----	
141	L1	----	
142	L1	----	

Report type
Key no.
PLU code

Data Clear

The DATA CLEAR function is primarily used to clear data such as report data (T-LOG, capture data, transaction or hourly report, daily net sales, sign on/GLU used flag, offline account data, or electronic journal file data) in case some system trouble occurred occurs.

This data clear function should be used only when your authorized SHARP dealer instructs you to do so.

Use the following procedure to perform data clear operation. only when instructed by your authorized SHARP dealer.

Procedure

PGM2 MODE	↓	P UP	▲	CAN	·	CL
01 READING				CEL		
02 SETTING				7	8	9
03 AUTO KEY						
04 D-UPC LOAD				4	5	6
05 DATA CLEAR						
06 OPEN STORE				1	2	3
07 CLOSE STORE						
08 KP READING						
PREV.	NEXT	LIST	P DOWN	0	00	ENTR

PGM2 3:14PM



DATA CLEAR	↓	P UP	▲	CAN	·	CL
1 T-LOG				CEL		
2 CAPTURE DATA				7	8	9
3 TRANSACTION						
4 HOURLY				4	5	6
5 DAILY NET						
6 SIGN ON FLAG				1	2	3
7 GLU USED FLAG						
8 OFFLINE ACCT				0	00	ENTR
PREV.	NEXT	LIST	P DOWN			

PGM2 3:14PM

The screen continues.

1. In the PGM2 mode menu, select "5 DATA CLEAR".
 - The DATA CLEAR window will appear.

2. Select the data to be cleared.

14

Universal Product Code (UPC) or European Article Number (EAN)

■ UPC or EAN code

Your machine can handle the following codes:

- UPC-A (Number system character: 0, 2, 3, 4)
- UPC-E
- EAN-8
- EAN-13
- Internal code EAN-8/EAN-13

For the purpose of in-store marking, there are two kinds of PLU type (treated like PLU code) and Non-PLU type (for price/quantity information).

When a code is of the non-PLU type, the price/quantity in the code is read for sales entries (in case of quantity, "quantity multiplied by the preset unit price" is processed to obtain the price.)

UPC-A

- Number system character: 0 <used in the source marking>
- Number system character: 3 <used as NDC or HRI>

For entry, a full 12 digit number or 11digit number (omitting the check digits) must be entered.

- Number system character: 2 <In-store marking Non-PLU type> You can program the format in "EAN NON-PLU" in ARTICLE setting.
- Number system character: 4 <In-store marking PLU type>

Here, a full 12digit number, 11digit number (excluding the check digit), or a leading zero plus 12 digit number must be entered. (Any number is allowed for the digits marked with *, and on the receipt/journal, non-PLU type code is printed like 2020008**** (****: price information).)

UPC-E

- UPC-E is a zero-suppressed version of UPC-A that conforms to the UPC-E Standards. This code is used for marking small packages.

Here, a 6digit number or a leading zero plus 6digits number must be entered.

EAN-8

- Ordinary EAN-8 code (flag: neither 0 nor 2) <used in the source marking>

Here, a full 8 digit number must be entered.

- Internal code (flag 2) <in-store marking non-PLU short type> Program the format in "EAN NON-PLU" in ARTICLE setting.
- Internal code (flag 0) <in-store marking PLU short type>

Here, a full 8digit number must be entered. On the receipt/journal, non-PLU type code is printed like 208**** (****: price/quantity information)

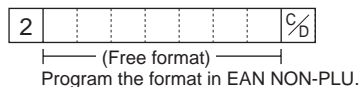
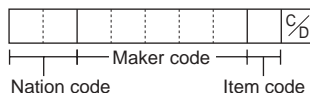
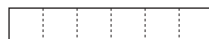
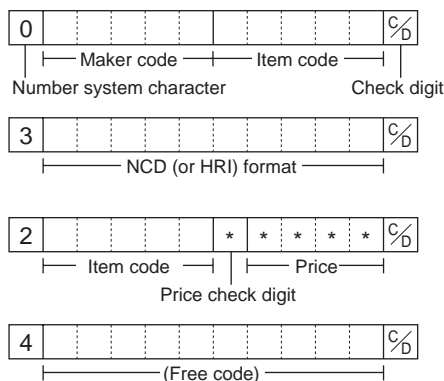

EAN-13

- Ordinary EAN-13 code (used in source marking)
- Specific EAN-13 code (flag 977, 978, 979) (used in the source marking: ISBM, ISSN)

Here, you must enter a full 13digit number.

- Internal code (used for in-store marking, flag character number: 20 through 29 and 02)
Program the format in “EAN NON-PLU” in ARTICLE setting.

■ Add-on code

UPC-A and EAN-13 may be followed by a twodigit number or a fivedigit number as an add-on code, except the UPC-A without a check digit.

Therefore, the total number of digits which can be entered for each type code is as shown below:

Code entry	No add-on code	2-digit add-on code	5-digit add-on code
UPC-A	12	14	17
UPC-A w/leading zero	13	15	18
UPC-A w/o check digit	11	–	–
UPC-E	6	–	–
EAN-8	8	–	–
EAN-13	13	15	18

NOTE *Your POS terminal automatically identifies the add-on code in an UPC/EAN code from the total number of digits and the flag.*

■ UPC file

Your POS terminal has a UPC main file and can provide a dynamic UPC (D-UPC) file.

UPC main file

Generally use, all UPC items are managed in the UPC main file.

Programming data and sales information is saved in the UPC main file.

Dynamic UPC file

If a dynamic UPC file is generated, the items entered by the UPC learning function (refer to the “UPC learning function” section.) are saved in this file temporarily. (If not generated, they are directly saved in the UPC main file.) The data saved temporarily can be transferred to the UPC main file when necessary by executing the D-UPC LOAD in the PGM2 mode.

If you want to use the dynamic UPC file, please consult your authorized SHARP dealer.

15

Operator Maintenance

In Case of Power Failure

Even when power is lost, your POS terminal retains its memory contents and all information on sales entries.

- When a power failure occurs while your POS terminal is idling or during an entry operation, it returns to the normal state after power recovery.
- When a power failure occurs during a printing cycle, the terminal prints “=====” and then carries out the correct printing procedure after power recovery. (See the sample print.)

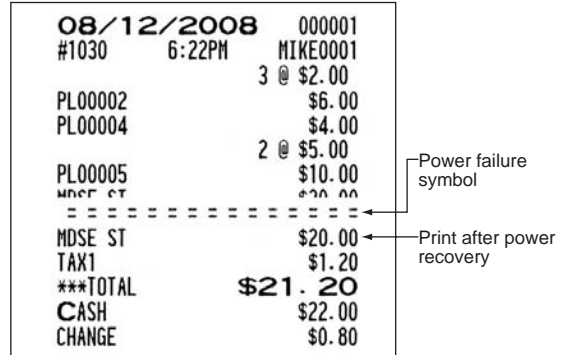

In Case of a Printer Error

If the printer runs out of paper, the printer will stall, and the “PAPER EMPTY” message will appear on the display. Any key entries will not be accepted. Referring to “Installing and Removing a Paper Roll” in this chapter, install a new paper roll properly, then press the **CL** key. The printer will print the power failure symbol and resume printing.

If the print head is in the “up” position, the printer will stall, and the “HEAD UP” message will appear on the display. Any key entries will not be accepted. Bring back the print head to the correct position, then press the **CL** key. The printer will print the power failure symbol and resume printing.

Thermal Printing

Your POS terminal uses a thermal printer. When the print head is heated to a certain level, printing is made on thermal paper.

■ Cautions in handling the printer

- If your POS terminal for an extended period of time, pull the print head release lever toward you so that the print head is set apart from the plate.
- Avoid installing the machine in any of the following places:
 - Dusty or humid places
 - Place exposed to direct sunlight
 - Place where there is iron powder (A permanent magnet and an electromagnet are used in this machine.)
- Use the print head release lever only when necessary.
- Never pull the paper when it is in consult with the print head. First release the head with the print head release lever, and then remove the paper.
- Never touch the surface of the print head.
- Never touch the print head and the motor during printing or before they cool down.

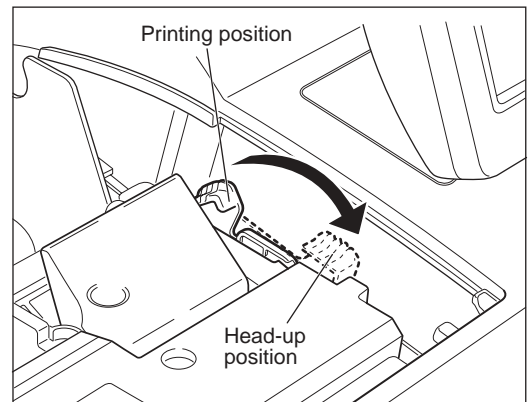

■ Cautions in handling the recording paper (thermal paper)

- Use only paper as specified by SHARP.
- Unpack the thermal paper just before you use it.
- Avoid heat. The paper begins to develop color at around 70 C.
- Avoid dusty and humid places for storage. Avoid direct sunlight.
- The printed text on the paper can discolor under the following conditions:
 - Exposure to high humidity and temperature.
 - Exposure to direct sunlight.
 - Contact with glue, thinner or a freshly copied blueprint.
 - Heat caused by friction (scratching etc.)
 - Contact with a rubber eraser or adhesive tape.
- Be very careful when handling the thermal paper. If you want to keep a permanent record, copy the printed text with a photocopier.

Installing and Removing a Paper Roll

■ Recording paper specifications

Be sure to use paper rolls as specified by SHARP.

The use of any paper rolls other than specified could cause paper jamming, resulting in a POS terminal malfunction.

Paper specification

Paper width:	2.26 ± 0.02 in. (57.5 ± 0.5 mm)
Max. outside diameter:	3.15 in. (80 mm)
Quality:	Thermal paper
Paper tube:	0.71 in. (18 mm)

- **Be sure to set paper roll(s) prior to using your machine. Otherwise it may cause a malfunction.**

Install the paper roll in the printer. Be careful to set the roll and cut the paper end correctly.

NOTE *If the leading end of the paper roll is fixed with paste or tape, the paper's color development ability may be lost in the pasted or taped area due to deterioration of the heat-sensitive color development component of the paper surface. As a result, nothing may be printed in this area. Therefore, when setting a new paper roll in the machine, be sure to cut off approximately one revolution (approx. 25 cm long).*

(How to set the paper roll)

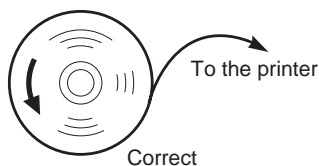
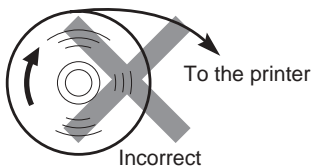

(How to cut the paper end)



■ Installing a paper roll

Installing the receipt paper roll

1. Select the "REG" mode with the AC cord connected.
2. Remove the printer cover.
3. Check that the print head release lever is in its printing position.
4. Set the paper correctly as illustrated right in the paper roll location (receipt side) of the printer.
5. Insert the end of the paper into the paper chute as shown on the right. It will automatically be fed through the printer.
6. Cut off the excess paper that comes out of the printer with the manual cutter.
7. Replace the printer cover.

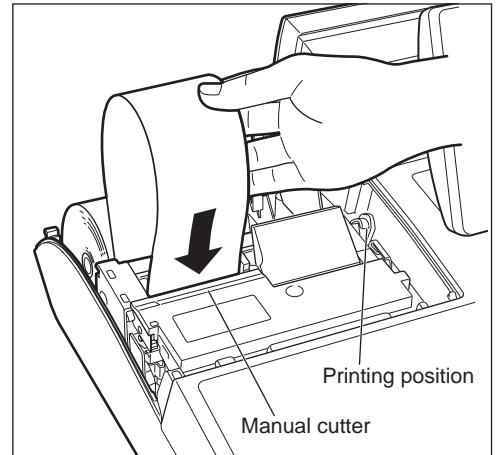

Installing a journal paper roll

1. Select the "REG" mode with the AC cord connected.
2. Remove the printer cover.
3. Confirm that the print head release lever is in its printing position.
4. Set the paper correctly in the journal paper holder of the printer. (See the illustrations on the previous page.)
5. Insert the end of the paper into the paper chute as shown on the right. It will automatically be fed through the printer.
6. Insert the end of the paper into the slit in the paper take-up spool. (Press the  key to feed paper more if required.)
7. Wind the paper around the spool shaft two or three turns.
8. Set the spool on the bearing.
9. Replace the printer cover.

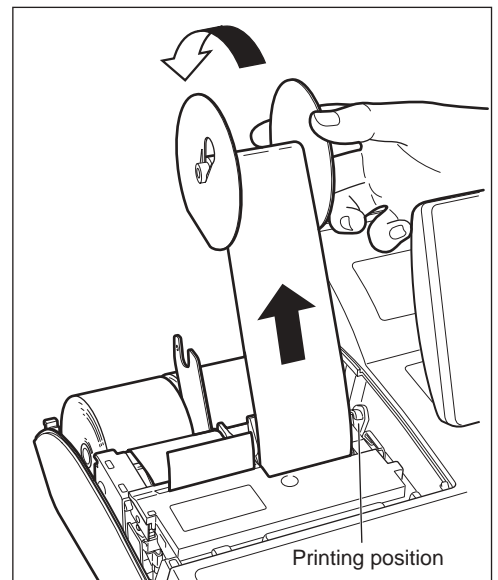

■ Manual installing of a paper roll

When you want to manually install a new roll of paper while your machine is turned off, follow the steps below:

1. Pull the print head release lever toward you to lift up the print head.
2. Correctly place the new paper roll in the receipt/journal paper roll holder.
3. Insert the paper end into the paper chute until it comes out of the printer.
4. Cut off the excess receipt paper or wind the paper around the take-up spool as described on the right (journal paper).
5. Return the print head release lever to its original position.

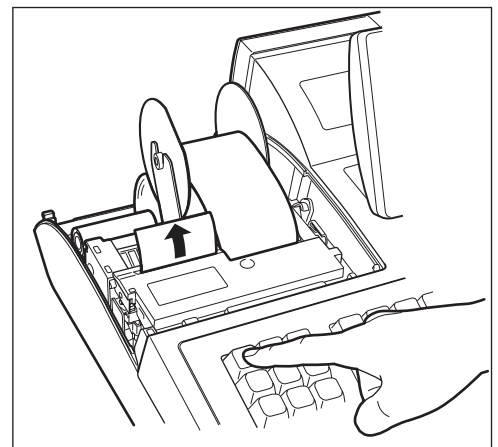

■ Removing the journal paper roll

1. Remove the printer cover.
2. Press the  key to feed the journal paper until all its printed part comes out.
3. Cut the paper and remove the take-up spool.

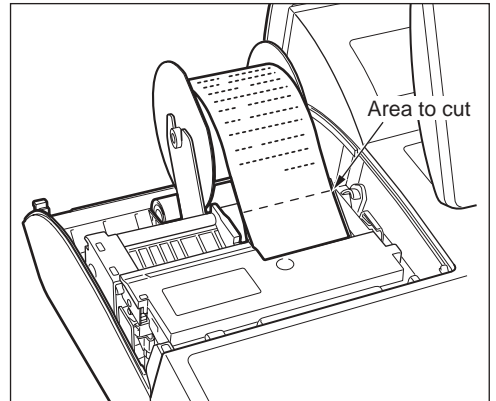

4. Cut the paper behind the printer and near the paper roll.
 5. Press the  key until the paper remaining in the printer comes out completely.
 6. Remove the paper roll from the back of the printer.
- NOTE** Do not pull the paper through the printer.

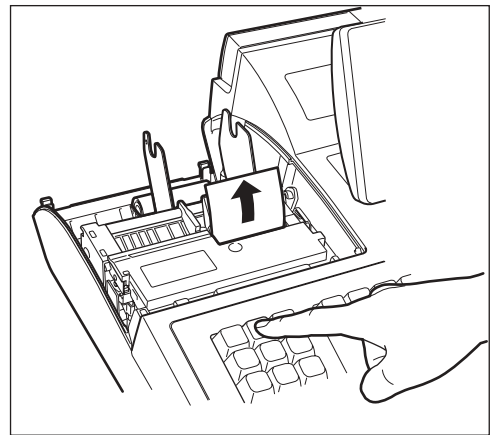

7. Remove the outer side of the take-up spool as shown on the right.

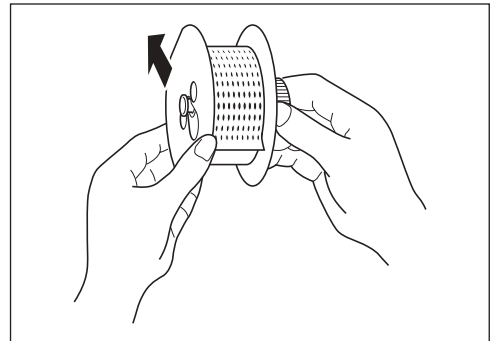

8. Remove the printed journal roll from the take-up spool.

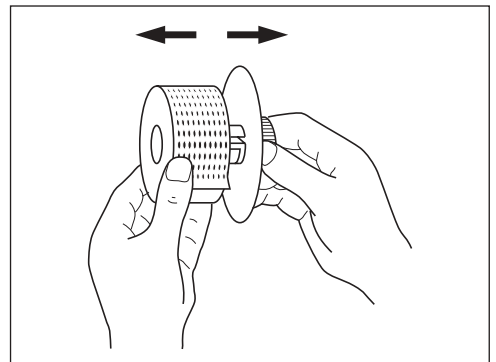

■ Prevention of paper jams

Keep the following points in mind to prevent paper jams.

- *Do not touch the receipt while it is being printed.*
- *Cut off the receipt after printing is finished. You hear the cutter sound when printing is finished.*
- *Pulling the receipt during printing may cause paper to jams.*

How to pull the receipt paper after the printing

Pull the receipt paper obliquely upward from behind holding the middle of its side.

How to pull the receipt (Correct)

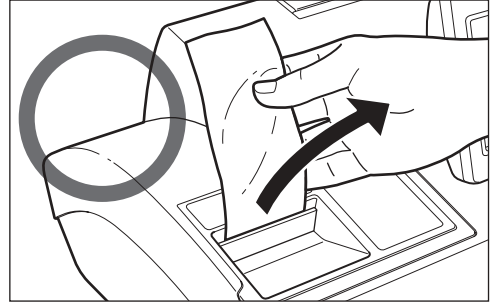

In case the receipt is short, always cut it off after the printing is finished.

How to pull the short receipt (Correct)

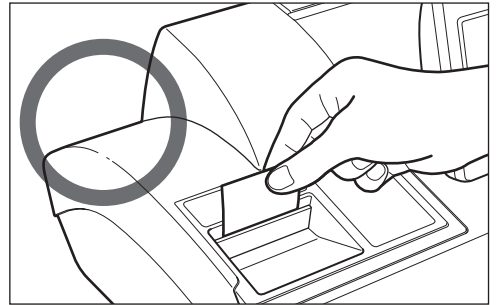

Do not press the receipt paper from above nor hold it in the way it wrinkles. This may result in a paper jam.

How to pull the receipt (Incorrect)

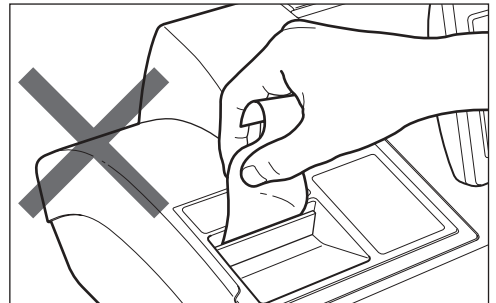

Do not pull the receipt paper obliquely (rightward or leftward). This may result in a paper jam.

How to pull the receipt (Incorrect)

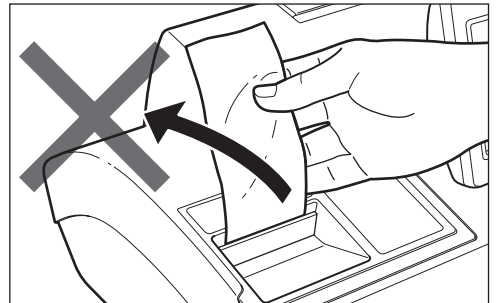

■ Removing a paper jam

Precaution: Be very careful with the cutter, so as not to cut yourself. Never touch the print head immediately after printing, because the head may still be hot.

1. Remove the printer cover.
2. Remove the receipt paper, and if the paper jam is at the journal paper, remove the journal paper, too.
3. While pushing the cutter open tab, pull up the cutter unit.
4. Pull the print head release lever all the way forward (after it stops at one position, continue pulling forward until it stops again and cannot be pulled forward any further).
5. Remove the paper jam. Check for and remove any shreds of paper that may remain in the printer.
6. Return the print head release lever to its original position.
7. Return the cutter unit to its original position. Make sure the metal part is surely hooked to the cutter open tab.
8. Reset the paper roll(s) correctly by following the steps in "Installing the paper roll".
9. Replace the printer cover.

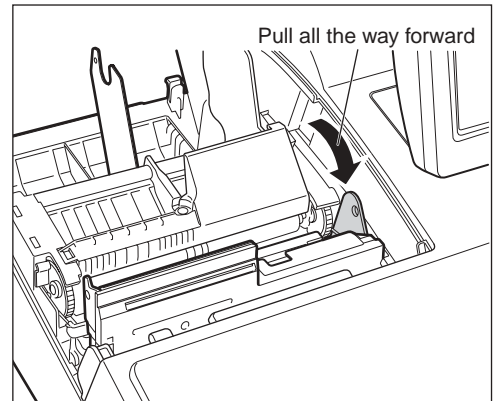
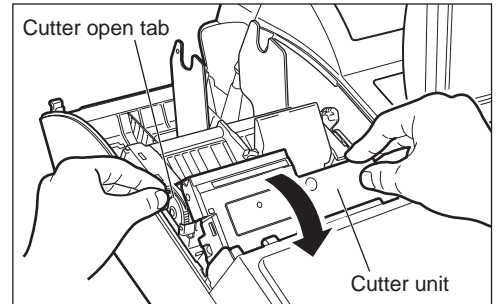

Cleaning the Print Head

When the printed text is getting dark or faint, there may be paper dust adhering to the print head. Clean the print head as follows:

- 1.** Select the OFF mode.
- 2.** Remove the printer cover.
- 3.** Pull up the print head release lever to the “up” position.
- 4.** Remove the paper roll(s).
- 5.** While pushing the cutter open lever to the right, pull up the cutter unit.
- 6.** Clean the print head with a soft rag moistened ethyl alcohol or isopropyl alcohol.
- 7.** Return the print head release lever to its original position immediately after cleaning.
- 8.** Return the cutter unit to its original position. Make sure the metal part is surely hooked to the cutter open lever.
- 9.** Reset the paper roll(s) correctly by following the step in “Installing a paper roll”.
- 10.** Replace the printer cover.

Precautions:

Never touch the print head with a tool or anything hard which may damage the head.

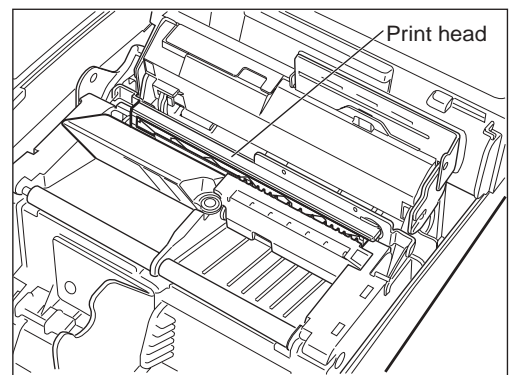
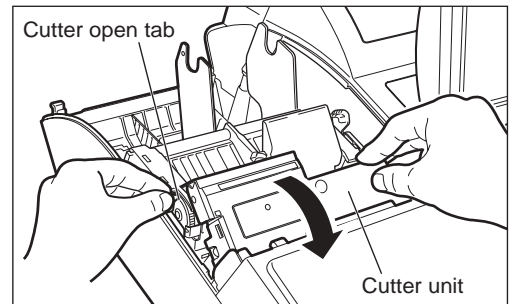

Removing the Till and the Drawer

The till in the POS terminal is detachable. After closing your business for the day, remove the till from the drawer and keep the drawer open. The 6-denomination coin case is also detachable from the till. To detach the drawer, pull it forward fully with the till removed, and remove it by lifting it up.

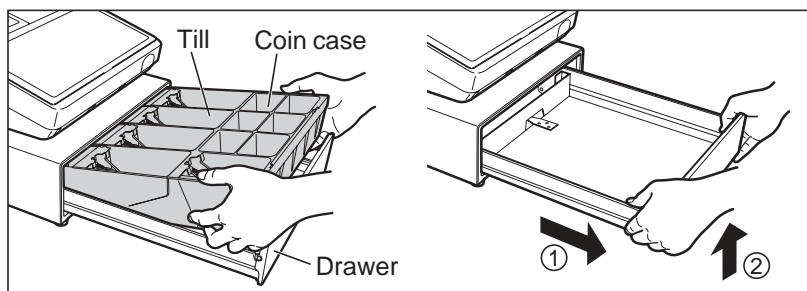

Opening the Drawer by Hand

The drawer automatically opens. However, when a power failure occurs or the machine becomes out of order, slide the lever located on the bottom of the machine in the direction of the arrow. (See the diagram on the right.)
The drawer will not open if it is locked with the key.

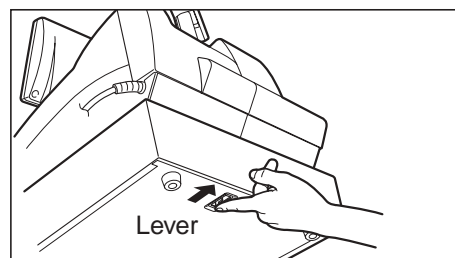

Before Calling for Service

Phenomena shown in the left-hand column of the table below do not always imply functional faults of the terminal. Before calling for service, please carry out checks as suggested in the "Check" column.

Phenomenon	Check
<ul style="list-style-type: none">● The display does not illuminate	<ul style="list-style-type: none">● Is power supplied to the electrical outlet?● Is the AC power cord plug disconnected or loosely connected to the electrical outlet?● Is the contrast control adjusted correctly?● Is the terminal in the screen-save mode?
<ul style="list-style-type: none">● The display is illuminated, but the whole machine rejects any entry.	<ul style="list-style-type: none">● Is a server code assigned to the POS terminal?● Is the terminal set properly to the "REG" mode?
<ul style="list-style-type: none">● No receipt is issued.	<ul style="list-style-type: none">● Is the paper roll properly installed?● Is there a paper jam?● Is the Receipt ON/OFF function in the "OFF" state?● Is the terminal set properly to the "REG" mode?
<ul style="list-style-type: none">● No journal paper is taken up.	<ul style="list-style-type: none">● Is the take-up spool installed on the bearing properly?● Is there a paper jam?
<ul style="list-style-type: none">● Printing is unusual.	<ul style="list-style-type: none">● Is the print head release lever in the printing position?● Is there a paper jam?

16 List of Options

The following options are available for your POS terminal:

For further information, contact your authorized SHARP dealer. Do not try to install any option yourself.

1. Remote customer display model UP-P20DPB
2. Remote drawer model ER-03DW(B7) or ER-04DW
3. Remote coin case model ER-55CC2 or ER-75CC3
4. RAM memory board model UP-S04MB2
5. Magnetic card reader model UP-E13MR3
6. Key kit models

You can change the keyboard layout or increase the number of departments using the following key kits.

ER-11KT8: 30 regular size key kit

ER-12KT8: 30 1x2 size key kit

ER-22KT8: 10 2x2 size key kit

ER-11DK8B: 30 regular size dummy key kit

ER-51DK8B: 10 5x1 size dummy key kit

17

Specifications

Model	UP-820N	
External dimensions	14.1 (W)* X17.6 (D) X14.7 (H) in. (358(W)* X 447(D) X 374(H) mm) * Including the touch panel.	
Weight	31.3 lbs (14.2 kg)	
Power source	120 V AC \pm 10%, 60 Hz	
Power consumption	Stand-by: 21W Operating: 52 W (max.)	
Operating temperature	32 to 104 F (0 to 40 C)	
Electronics	LSI (CPU) etc.	
Built-in battery	Rechargeable battery pack, memory retention time of about one month (with fully charged built-in battery pack, at 77 F [25 C])	
Keyboard	Normal keyboard	
Display	Operator display: Color LCD module and touch panel 400 (W) X 240 (H) (dots)	
Customer display	7-segment display (7 positions)	
Printer	Type	2-station thermal printer
	Printing speed	Max. 17.3 lines/second
	Printing capacity	30 digits for receipt paper and journal paper
	Other functions	Graphic logo printing function Logo message function Paper feed function
Paper roll	Width	22.6 \pm 0.02 in. (57.5 \pm 0.5 mm)
	Max. diam.	3.15 in. (80 mm)
	Quality	High quality (0.06 to 0.08 mm thickness)
Cash drawer	5 slots for bill and 6 for coin denominations	
Accessories	Hardware Operation Manual: 1 copy Paper roll: 2 Take-up spool: 1 Drawer lock keys: 2	

* Specifications and appearance are subject to change without notice for improvement.

NOTICE

PLEASE BE SURE TO ASK ABOUT THE WARRANTY THAT AN AUTHORIZED DEALER EXTENDS TO YOU. In order to assure you, the end-user, of warranty protection, Sharp extends a limited warranty to each of its authorized dealers, and in turn requires each of its authorized dealers to extend its own warranty to you on terms that are no less favorable than those given to the dealer by Sharp. You should be aware, however, that Sharp does not itself extend any warranties, either express or implied, directly to you, the end-user, and no one is authorized to make any representations or warranties on behalf of Sharp. Specifically, SHARP DOES NOT EXTEND TO YOU, THE END-USER, ANY EXPRESS WARRANTY OR ANY IMPLIED WARRANTY OF MERCHANTABILITY, FITNESS FOR USE OR FITNESS FOR ANY PARTICULAR PURPOSE IN CONNECTION WITH THE HARDWARE, SOFTWARE, OR FIRMWARE EMBODIED IN OR USED IN CONJUNCTION WITH THIS PRODUCT.

Sharp is not responsible for any damages or loss, either direct, incidental or consequential, which you, the end-user, may experience as a result of your purchase or use of the hardware, software or firmware embodied in or used in conjunction with this product. Your sole remedy in the event that you encounter any difficulties with the product is against the authorized dealer from which you purchased the product. In the event that this authorized dealer does not honor its warranty commitments, please contact the Point of Sale Division, ISG, Sharp Electronics Corporation, Sharp Plaza, P.O. Box 650, Mahwah, NJ 07495-1163 so that Sharp can try to help you to assure complete satisfaction of all the warranty rights to which you are entitled from the authorized dealer.

SHARP®

SHARP ELECTRONICS CORPORATION

Sharp Plaza, Mahwah, New Jersey 07495-1163

1-800-BE-SHARP

<http://www.sharp-usa.com>

SHARP CORPORATION