

# SHARP®

## MODEL UX-P115

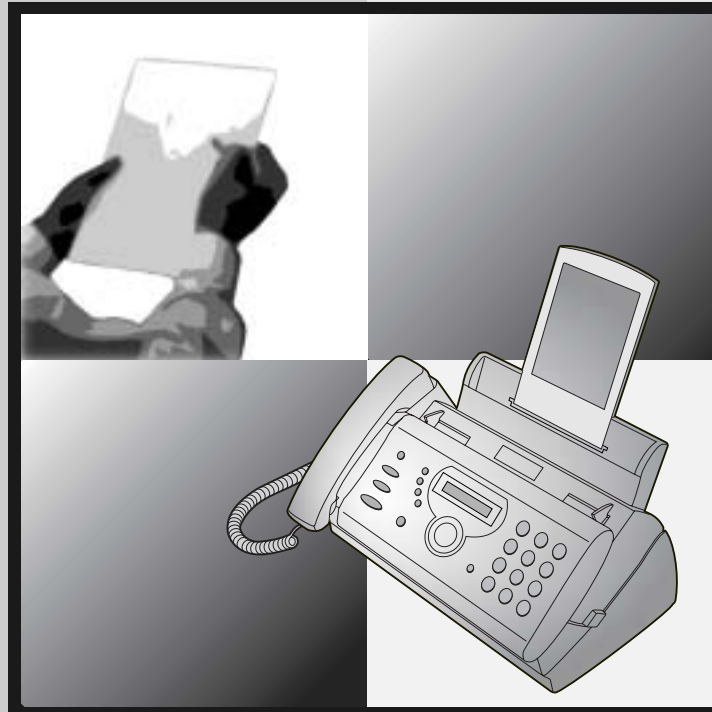

## FACSIMILE OPERATION MANUAL

1. Installation
2. Sending Faxes
3. Receiving Faxes
4. Making Copies
5. Special Functions
6. Printing Lists
7. Maintenance
8. Troubleshooting

SHARP FROM SHARP MINDS COME SHARP PRODUCTS™



GENUINE SUPPLIES

To ensure Sharp quality, look for the Sharp Genuine Supplies Logo on your business products. We provide a full line of supplies that are designed and tested to maximize the life and performance of all Sharp products.

### SharpPlace

**congratulations** on the purchase of your new Sharp Product!

For your convenience, Genuine Sharp Supplies, Accessories, and additional Sharp Products can be purchased from the Authorized Sharp Reseller where you purchased your product or on-line at:

**[www.SharpPlace.com](http://www.SharpPlace.com)**

**visit SharpPlace** to enter periodic contests and drawings!

© 2001 Sharp Electronics Corporation  
Design and specifications are subject to change without notice.

**WARNING** - FCC Regulations state that any unauthorized changes or modifications to this equipment not expressly approved by the manufacturer could void the user's authority to operate this equipment.

**Note:** This equipment has been tested and found to comply with the limits for a Class B digital device, pursuant to Part 15 of the FCC Rules.

These limits are designed to provide reasonable protection against harmful interference in a residential installation.

This equipment generates, uses and can radiate radio frequency energy and, if not installed and used in accordance with the instructions, may cause harmful interference to radio communications. However, there is no guarantee that interference will not occur in a particular installation. If this equipment does cause harmful interference to radio or television reception, which can be determined by turning the equipment off and on, the user is encouraged to try to correct the interference by one or more of the following measures:

- Reorient or relocate the receiving antenna.
- Increase the separation between the equipment and the receiver.
- Connect the equipment into an outlet on a circuit different from that to which the receiver is connected.
- Consult the dealer or an experienced radio/TV technician for help.

**ABOUT THE TELEPHONE CONSUMER PROTECTION ACT OF 1991**

"The Telephone Consumer Protection Act of 1991 makes it unlawful for any person to use a computer or other electronic device to send any message via a telephone facsimile machine unless such message clearly contains in a margin at the top or bottom of each transmitted page or on the first page of the transmission the following information:

- (1) The date and time of transmission.
- (2) Identification of either the business, business entity or individual sending the message.
- (3) Telephone number of either the sending machine, business, business entity or individual.

In order to program this information into your facsimile machine, please refer to the appropriate instructions in the operation manual."



As an ENERGY STAR™ partner, SHARP has determined that this product meets the ENERGY STAR™ guidelines for energy efficiency.

**FOR YOUR RECORDS**

Please record the model number and serial number below, for easy reference, in case of loss or theft. These numbers are located on the rear side of the unit. Space is also provided for other relevant information.

Model Number UX-P115

Serial Number \_\_\_\_\_

Date of Purchase \_\_\_\_\_

Place of Purchase \_\_\_\_\_

---

## Introduction

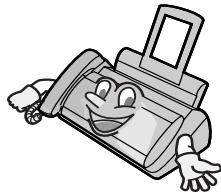

Welcome, and thank you for choosing a Sharp fax machine! The features and specifications of your new Sharp fax are shown below.

<b>Automatic dialing</b>	30 numbers
<b>Imaging film</b>	<b>Initial starter roll</b> (included with machine): 32 ft. (10 m) (approx. 30 letter-size pages) <b>Replacement roll</b> (not included): <b>UX-5CR</b> 164 ft. (50 m) (one roll yields approx. 150 letter-size pages)
<b>Memory size*</b>	448 KB (approx. 24 average pages)
<b>Modem speed</b>	9,600 bps with automatic fallback to lower speeds.
<b>Transmission time*</b>	Approx. 15 seconds
<b>Resolution</b>	<b>Horizontal:</b> 203 pels/inch (8 pels/mm) <b>Vertical:</b> Standard: 98 lines/inch (3.85 lines/mm) Fine /Halftone: 196 lines/inch (7.7 lines/mm) Super fine: 391 lines/inch (15.4 lines/mm)
<b>Automatic document feeder</b>	10 pages max. (letter/A4, 20 lb paper)
<b>Recording system</b>	Thermal transfer recording
<b>Halftone (grayscale)</b>	64 levels
<b>Compression scheme</b>	MR, MH, Sharp(H2)
<b>Display</b>	16-digit LCD display
<b>Applicable telephone line</b>	Public switched telephone network

\*Based on Sharp Standard Chart at standard resolution in Sharp special mode, excluding time for protocol signals (i.e., ITU-T phase C time only).

<b>Paper tray capacity</b>	Letter: Approx. 50 sheets (20-lb. copier paper at room temperature; maximum stack height should not be higher than the line on the tray) Legal: 5 sheets Recommended paper weight is 20-lb. Copy Bond
<b>Compatibility</b>	ITU-T (CCITT) G3 mode
<b>Input document size</b>	<b>Automatic feeding:</b> Width: 5.8 to 8.5" (148 to 216 mm) Length: 5.5 to 11" (140 to 279 mm) <b>Manual feeding:</b> Width: 5.8 to 8.5" (148 to 216 mm) Length: 5.5 to 23.6" (140 to 600 mm)
<b>Effective scanning width</b>	8.3" (210 mm) max.
<b>Effective printing width</b>	8.3" (210 mm) max.
<b>Contrast control</b>	Automatic/Dark selectable
<b>Reception modes</b>	TEL/FAX
<b>Copy function</b>	Single / Multi (99 copies/page)
<b>Telephone function</b>	Yes (cannot be used if power fails)
<b>Power requirements</b>	120 V AC, 60 Hz
<b>Operating temperature</b>	41 - 95 °F (5 - 35°C)
<b>Humidity</b>	25 - 85 % RH
<b>Power consumption</b>	Standby: 3.6 W Maximum: 100 W
<b>Dimensions</b> (without attachments)	Width: 12.9" (327 mm) Depth: 7.6" (193 mm) Height: 6.4" (163 mm)
<b>Weight</b> (without attachments)	Approx. 6.2 lbs. (2.8 kg)

As a part of our policy of continuous improvement, SHARP reserves the right to make design and specification changes for product improvement without prior notice. The performance specification figures indicated are nominal values of production units. There may be some deviations from these values in individual units.

### ***Important safety information***

Do not disassemble this machine or attempt any procedures not described in this manual. Refer all servicing to qualified service personnel.

Do not install or use the machine near water, or when you are wet. For example, do not use the machine near a bath tub, wash bowl, kitchen sink or laundry tub, in a wet basement, or near a swimming pool. Take care not to spill any liquids on the machine.

Unplug the machine from the power outlet and telephone jack and consult a qualified service representative if any of the following situations occur:

- Liquid has been spilled into the machine or the machine has been exposed to rain or water.
- The machine produces odors, smoke, or unusual noises.
- The power cord is frayed or damaged.
- The machine has been dropped or the housing damaged.

Do not allow anything to rest on the power cord, and do not install the machine where people may walk on the power cord.

This machine must only be connected to a 120 V, 60 Hz, grounded (3-prong) outlet. Connecting it to any other kind of outlet will damage the machine and invalidate the warranty.

Never insert objects of any kind into slots or openings on the machine. This could create a risk of fire or electric shock. If an object falls into the machine that you cannot remove, unplug the machine and consult a qualified service representative.

Do not place this machine on an unstable cart, stand or table. The machine could be seriously damaged if it falls.

Never install telephone wiring during a lightning storm.

Never install telephone jacks in wet locations unless the jack is specifically designed for wet locations.

Never touch bare telephone wires or terminals unless the telephone line has been disconnected at the network interface.

Use caution when installing or modifying telephone lines.

Avoid using a telephone (other than a cordless type) during an electrical storm. There may be a remote risk of electric shock from lightning.

Do not use a telephone to report a gas leak in the vicinity of the leak.

The power outlet must be installed near the equipment and must be easily accessible.

---

## ***Table of Contents***

<b>A Look at the Operation Panel</b>	<b>6</b>
<hr/>	
<b>1. Installation</b>	<b>8</b>
<hr/>	
Unpacking Checklist . . . . .	8
Connections . . . . .	9
Loading the Imaging Film . . . . .	12
Loading Printing Paper . . . . .	14
Entering Your Name and Fax Number . . . . .	16
Setting the Date and Time . . . . .	18
Setting the Reception Mode . . . . .	20
Volume Adjustment . . . . .	21
<b>2. Sending Faxes</b>	<b>23</b>
<hr/>	
Transmittable Documents . . . . .	23
Loading the Document . . . . .	24
Adjusting the Resolution and Contrast . . . . .	25
Sending a Fax by Normal Dialing . . . . .	27
Sending a Fax by Automatic Dialing . . . . .	28
Sending a Fax From Memory . . . . .	37
<b>3. Receiving Faxes</b>	<b>40</b>
<hr/>	
Using FAX Mode . . . . .	40
Using TEL Mode . . . . .	41
Optional Reception Settings . . . . .	44
Substitute Reception to Memory . . . . .	46
<b>4. Making Copies</b>	<b>47</b>
<hr/>	
<b>5. Special Functions</b>	<b>49</b>
<hr/>	
Caller ID (Requires Subscription to Service) . . . . .	49
Distinctive Ring (Requires Subscription to Service) . . . . .	54
Blocking Reception of Unwanted Faxes . . . . .	56
Polling (Requesting a Fax Transmission) . . . . .	57

<b>6. Printing Lists</b>	<b>58</b>
<b>7. Maintenance</b>	<b>61</b>
<b>8. Troubleshooting</b>	<b>64</b>
Problems and Solutions .....	64
Messages and Signals .....	68
Clearing Paper Jams .....	71
Ordering Parts .....	73
FCC Regulatory Information .....	74
<b>Quick Reference Guide</b>	<b>77</b>
<b>Guía de referencia rápida</b>	<b>78</b>
<b>Index</b>	<b>79</b>

---

## A Look at the Operation Panel

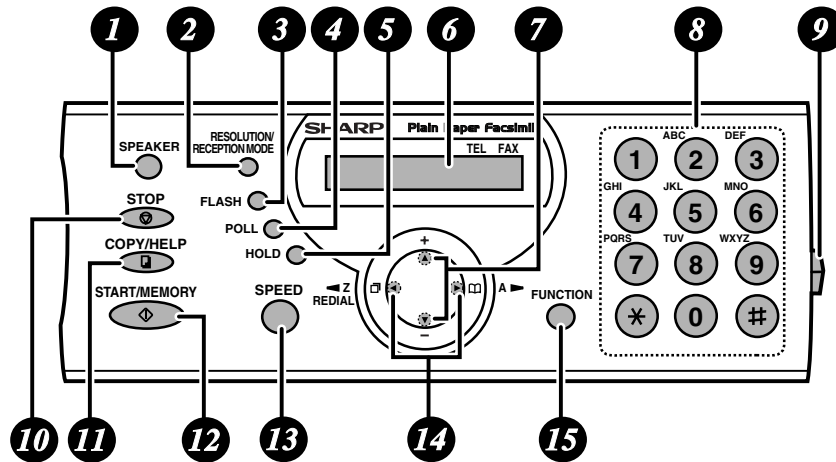

- 1 SPEAKER key**  
Press this key to listen to the line and fax tones through the speaker when faxing a document (page 27).  
Note: **This is not a speakerphone.** You must pick up the handset to talk with the other party.
- 2 RESOLUTION / RECEPTION MODE key**  
When a document is in the feeder, press this key to adjust the resolution for faxing or copying (page 25). At any other time, press this key to select the reception mode (an arrow in the display will point to the currently selected reception mode; page 20).
- 3 FLASH key**  
This key is used for Call Waiting and other special services that require subscription from your phone company. Your phone company will provide you with details on how to use the key.
- 4 POLL key**  
Press this key after dialing another fax machine to receive a document (previously loaded in the other machine's feeder) without assistance from the operator of the other machine (page 57).
- 5 HOLD key**  
Press this key to put the other party on hold during a phone conversation (page 43).



- 6 Display**  
This displays messages and prompts to help you operate the machine.
- 7 UP and DOWN arrow keys**  
**Enlarge/reduce setting:** When making a copy of a document, press these keys to select an enlarge/reduce setting (page 47).  
**Volume setting:** When a document is not in the feeder, press these keys to change the handset volume when the handset is lifted, the speaker volume when the **SPEAKER** key has been pressed, or the ringer volume at any other time (page 21).  
**FUNCTION key settings:** Press these keys after pressing the **FUNCTION** key to scroll through the FUNCTION MODE settings.
- 8 Number keys**  
Use these keys to dial numbers, and enter numbers and letters when storing auto-dial numbers.
- 9 Panel release**  
Press this release to open the operation panel.
- 10 STOP key**  
Press this key to cancel an operation before it is completed.
- 11 COPY/HELP key**  
When a document is in the feeder, press this key to make a copy of a document (page 47). At any other time, press this key to print out the Help List, a quick reference guide to the operation of your fax machine.
- 12 START/MEMORY key**  
Press this key after dialing to begin fax transmission (page 27). Press this key before dialing to send a fax through memory (page 37).
- 13 SPEED key**  
Press this key to dial a fax or voice number using an abbreviated 2-digit Speed Dial number (pages 29 and 33).
- 14 Left and right arrow keys**  
**Auto-dial numbers:** When sending a fax or making a phone call, press these keys to scroll through your auto-dial numbers (page 34), the "REVIEW CALLS" list (only available if you have Caller ID; page 51), and the last number dialed (redial; page 36).  
**FUNCTION key settings:** Press the right arrow key after scrolling with the up and down arrow keys to select a **FUNCTION** key setting.
- 15 FUNCTION key**  
Press this key followed by the arrow keys to select special functions and settings.

---

# 1. Installation

## Unpacking Checklist

Before setting up, make sure you have all of the following items.



If any are missing, contact your dealer or retailer.



Paper tray

Paper tray extension

Operation manual

Gears (2)

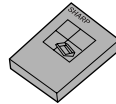
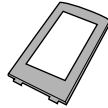
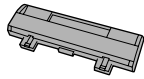

Handset

Handset cord

Telephone line cord

Imaging film (initial starter roll)

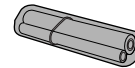
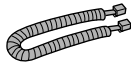

### Points to keep in mind when setting up

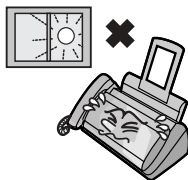

Do not place the machine in direct sunlight.

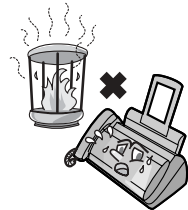

Do not place the machine near heaters or air conditioners.

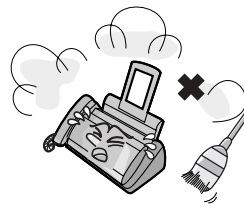

Keep dust away from the machine.

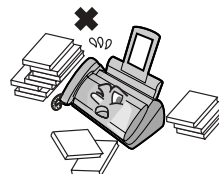

Keep the area around the machine clear.

### About condensation

If the machine is moved from a cold to a warm place, it is possible that condensation may form on the scanning glass, preventing proper scanning of documents for transmission. To remove the condensation, turn on the power and wait approximately two hours before using the machine.

## Connections

### Connecting the handset

Connect the handset as shown and place it on the handset rest.

- ◆ The ends of the handset cord are identical, so they will go into either jack.

Make sure the handset cord goes into the jack marked with a handset symbol on the side of the machine!

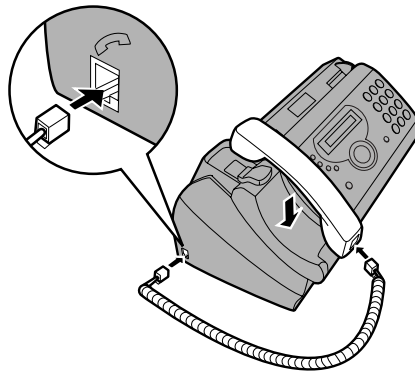
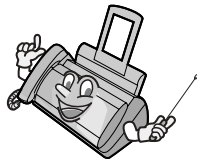

Use the handset to make ordinary phone calls, or to transmit and receive faxes manually.

### Connecting the power cord

Plug the power cord into a 120 V, 60 Hz, grounded AC (3-prong) outlet.

**Caution!**

Do not plug the power cord into any other kind of outlet. This will damage the machine and is not covered under the warranty.

The machine does not have a power on/off switch, so the power is turned on and off by simply plugging in or unplugging the power cord.

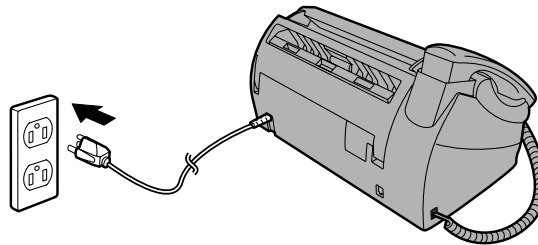

## Connections

### Connecting the telephone line cord

Insert one end of the line cord into the jack on the back of the machine marked **TEL. LINE**. Insert the other end into a standard (RJ11C) single-line wall telephone jack.

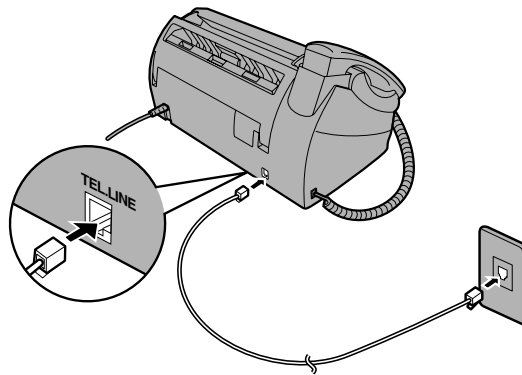

#### Setting the dial mode

The fax machine is set for tone dialing. If you are on a pulse dial line, you must set the fax machine for pulse dialing. Press the keys on the operation panel as follows:

- |  |   |
|--|---|
| <b>1</b> Press <b>FUNCTION</b> once and <b>▲</b> once.           | Display: <b>OPTION SETTING</b>  |
| <b>2</b> Press <b>▶</b> once and <b>▼</b> twice.                 | <b>DIAL MODE</b>  |
| <b>3</b> Press <b>▶</b> once.                                    | <b>1=TONE, 2=PULSE</b>  |
| <b>4</b> Select the dial mode:<br><b>TONE: 1</b> <b>PULSE: 2</b> | The display briefly shows your selection, then:<br><b>DISTINCTIVE</b> |
| <b>5</b> Press <b>STOP</b> to exit.                              |   |

**Comments:**

- ◆ The fax machine is not designed for use on a line which has call waiting, call forwarding, or certain other special services offered by your telephone company. If you attempt to use the fax machine in conjunction with any of these services, you may experience errors during transmission and reception of facsimile messages.
- ◆ The fax machine is not compatible with digital telephone systems.
- ◆ If your area experiences a high incidence of lightning or power surges, we recommend that you install surge protectors for the power and telephone lines. Surge protectors can be purchased at most telephone specialty stores.

***Attach the paper tray and paper tray extension***

Attach the paper tray.

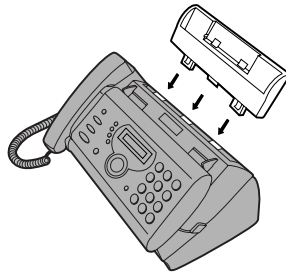

Attach the paper tray extension.

Insert horizontally  
and rotate up

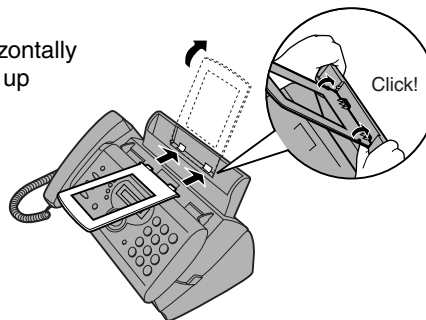

**Note:** The paper tray extension has a top side and a bottom side. If you cannot insert the tabs into the holes, turn the support over.

## Loading the Imaging Film

### Loading the Imaging Film

Your fax uses a roll of imaging film to create printed text and images. The print head in the fax applies heat to the imaging film to transfer ink to the paper. Follow the steps below to load or replace the film.

The initial starter roll of imaging film included with your fax can print about 30 letter-size pages.



When replacing the film, use a roll of Sharp **UX-5CR** imaging film. One roll can print about 150 letter-size pages.

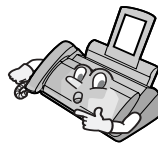

Use only Sharp Genuine Supplies with this logo:



- 1** Remove the paper from the paper tray and open the operation panel (press **1**).

If you are loading the imaging film for the first time, go to Step 4.

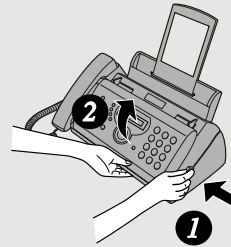

- 2** Remove the used film and empty spool.

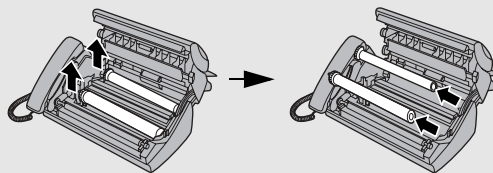

- 3** Remove the two green gears from the spools. **DO NOT DISCARD THE TWO GREEN GEARS!**

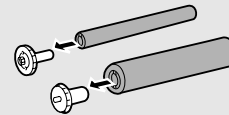

**4** Remove the new roll of imaging film from its packaging.

- Cut the band that holds the rolls together.

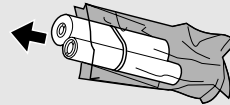

**5** Insert the green gears.

Make sure the gears fit into the slots in the ends of the rolls.

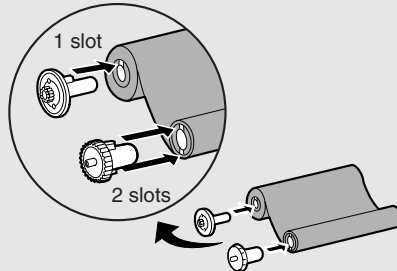

**6** Insert the film into the print compartment.

Fit ends of rolls onto hubs

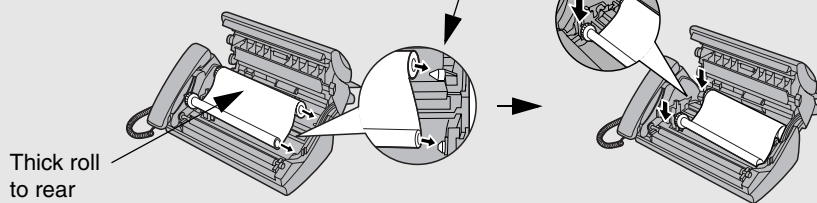

**7** Rotate the front gear as shown until the film is taut.

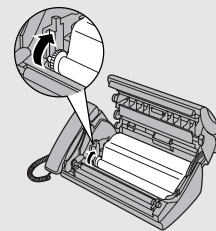

**8** Close the operation panel (press down on both sides to make sure it clicks into place).

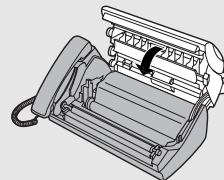

## Loading Printing Paper

You can load letter or legal size paper in the paper tray. Recommended paper weight is 20-lb. Copy Bond. The maximum number of sheets is as follows:

**Letter size:** Approx. 50 sheets (20-lb. copier paper at room temperature; maximum stack height should not be higher than the line on the tray)

**Legal size:** 5 sheets

- 1 Fan the paper, and then tap the edge against a flat surface to even the stack. Make sure the stack edges are even.**

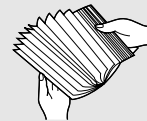

- 2 Insert the stack of paper into the tray, *PRINT SIDE DOWN*.**

- If paper remains in the tray, take it out and combine it into a single stack with the new paper.
- Be sure to load the paper so that printing takes place on the **print** side of the paper. Printing on the reverse side may result in poor print quality.
- **GENTLY LOAD PAPER INTO THE PAPER TRAY.**
- **DO NOT FORCE IT DOWN INTO THE FEED SLOT.**

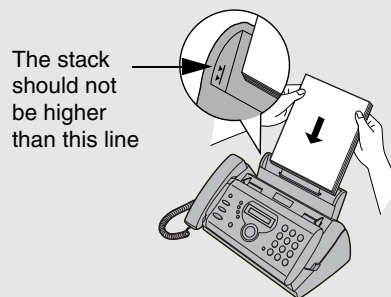

**Note:** Do not use paper that has already been printed on, or paper that is curled.

**Note:** If at any time the display shows the alternating messages at right, check the printing paper. If the tray is empty, add paper. If there is paper in the tray, take it out and then reinsert it.

When you are finished, press **START/MEMORY** 

ADD PAPER &









PRESS START KEY









### Setting the paper size

The fax has been set at the factory to scale received faxes to letter size paper. If you loaded legal paper, you must change the paper size setting to LEGAL.

<b>1</b>	Press  once and  once.	Display: <input type="text" value="OPTION SETTING"/>
<b>2</b>	Press  once and  twice.	<input type="text" value="PAPER SIZE SET"/>
<b>3</b>	Press  once.	<input type="text" value="1=LETTER,2=LEGAL"/>
<b>4</b>	Select the paper size: LETTER: <input type="radio"/> <b>1</b> LEGAL: <input type="radio"/> <b>2</b>	The display briefly shows your selection, then: <input type="text" value="COPY CUT-OFF"/>
<b>5</b>	Press  to return to the date and time display.	

### Print contrast setting

Your fax has been set at the factory to print at normal contrast. If desired, you can change the print contrast setting to LIGHT.

<b>1</b>	Press  once and  once.	Display: <input type="text" value="OPTION SETTING"/>
<b>2</b>	Press  once and  3 times.	<input type="text" value="PRINT CONTRAST"/>
<b>3</b>	Press  once.	<input type="text" value="1:NORMAL"/>
<b>4</b>	Select the print contrast: NORMAL: <input type="radio"/> <b>1</b> LIGHT: <input type="radio"/> <b>2</b>	The display briefly shows your selection, then: <input type="text" value="PAPER SIZE SET"/>
<b>5</b>	Press  to return to the date and time display.	

## Entering Your Name and Fax Number

### ***Entering Your Name and Fax Number***

Before you can begin sending faxes, you must enter your name and fax (telephone) number. You also need to set the date and time.



Once you enter this information, it will automatically appear at the top of each fax page you send.



#### **Important!**

FCC regulations require that your name, telephone/fax number, and the date and time appear on each fax message you send. Enter your name and fax number here and set the date and time as explained in the following section to have the fax machine include this information automatically at the top of your fax messages.

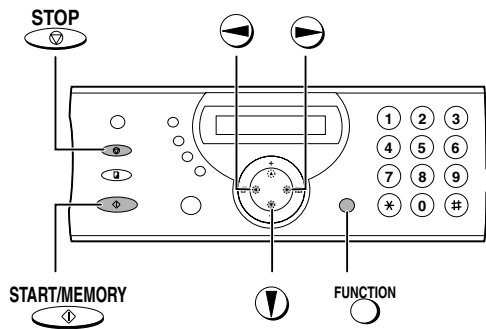

**1** Press **FUNCTION** once and **STOP** twice.

Display:

ENTRY MODE

**2** Press **RIGHT** once.

OWN NUMBER SET

**3** Press **RIGHT** once.

ENTER FAX #

**4** Enter your fax number by pressing the number keys (max. 20 digits).

- To insert a space between digits, press **#**.
- To clear a mistake, press **SPEAKER**.

**5** Press **START/MEMORY** to enter the fax number in memory.

**6** Enter your name by pressing number keys for each letter as shown in the chart below. Up to 24 characters can be entered.

Example: SHARP = 7777 44 2 777 **▶** 7

SPACE = <b>1</b>	G = <b>4</b>	N = <b>6 6</b>	U = <b>8 8</b>
A = <b>2</b>	H = <b>4 4</b>	O = <b>6 6 6</b>	V = <b>8 8 8</b>
B = <b>2 2</b>	I = <b>4 4 4</b>	P = <b>7</b>	W = <b>9</b>
C = <b>2 2 2</b>	J = <b>5</b>	Q = <b>7 7</b>	X = <b>9 9</b>
D = <b>3</b>	K = <b>5 5</b>	R = <b>7 7 7</b>	Y = <b>9 9 9</b>
E = <b>3 3</b>	L = <b>5 5 5</b>	S = <b>7 7 7 7</b>	Z = <b>9 9 9 9</b>
F = <b>3 3 3</b>	M = <b>6</b>	T = <b>8</b>	

- ◆ To enter two letters in succession that require the same key, press **▶** after entering the first letter.
- ◆ To clear a mistake, press **SPEAKER**.
- ◆ To enter a lower case letter, continue pressing the key for the letter until the lower case letter appears. To enter one of the following symbols, press **#** or **\*** repeatedly: . / ! " # \$ % & ' ( ) \* + , - : ; < = > ? @ [ ¥ ] ^ \_ ' { | } → ←

**7** Press **START/MEMORY**

Display:

DATE&TIME SET **▶▶**

**8** Press **STOP** to return to the date and time display.

## Setting the Date and Time

### Setting the Date and Time

The date and time appear in the display and are printed at the top of every page you fax. Set the date and time as shown below.

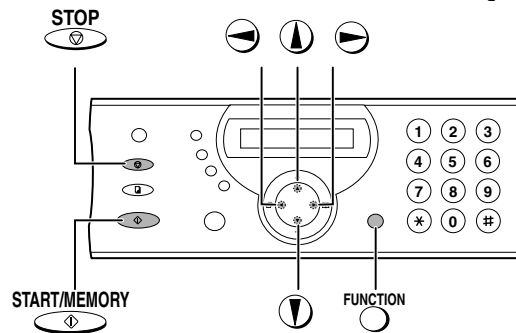
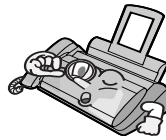

**1** Press **FUNCTION** once and **STOP** twice. Display: **ENTRY MODE**

**2** Press **RIGHT** once and **STOP** once. **DATE&TIME SET**

**3** Press **RIGHT** once. The currently set date appears (example): **DATE 08-15-2004**



**4** Enter a two-digit number for the month ("01" for January, "02" for February, "12" for December, etc.).

Example: January **0** **1** → **DATE 01-15-2004**

- To correct a mistake, press **LEFT** to move the cursor back to the mistake and then enter the correct number.







**5** Enter a two-digit number for the day ("01" to "31").

Example: the 5<sup>th</sup> **0** **5** → **DATE 01-05-2004**

<p><b>6</b> Enter the year (four digits).</p> <p>Example: 2004    2   0   0   4    →</p>	<p>The currently set time appears (example):</p> <p>TIME 12:19 PM</p>
<p><b>7</b> Enter a two-digit number for the hour (“01” to “12”) and a two-digit number for the minute (“00” to “59”).</p> <p>Example: 9:25    0   9   2   5    →</p>	<p>TIME 09:25 PM</p>
<p><b>8</b> Press * to select A.M. or # to select P.M.</p>	
<p><b>9</b> Press  to start the clock.    →</p>	<p>ANTI JUNK #    ↕</p>
<p><b>10</b> Press  to return to the date and time display.</p>	

### Daylight Saving Time

If desired, you can set the clock to move forward and backward automatically at the beginning and end of Daylight Saving Time. Follow these steps:

<p><b>1</b> Press  once and  once.</p>	<p>OPTION SETTING    ↕</p>
<p><b>2</b> Press  once and  5 times.</p>	<p>DAY LIGHT SAVE    ↕</p>
<p><b>3</b> Press  once.</p>	<p>1=YES, 2=NO</p>
<p><b>4</b> Press 1 to select YES, or 2 to select NO.</p>	<p>RECEIVE RATIO    ↕</p>
<p><b>5</b> Press  to return to the date and time display.</p>	

## Setting the Reception Mode

### **Setting the Reception Mode**

Your fax has two modes for receiving incoming faxes:

#### **FAX mode:**

Select this mode when you only want to receive faxes on your line. The fax machine will automatically answer all calls on four rings and receive incoming faxes.

#### **TEL mode:**

Select this mode when you want to receive both phone calls and faxes on the line connected to the fax machine. **All calls, including faxes, must be answered by picking up the fax machine's handset** or an extension phone connected to the same line.

### **Setting the reception mode**

Make sure a document *is not loaded in the document feeder*, and then

press  until the arrow in the display points to the desired mode.

◆ **Note:** When a document is loaded in the document feeder, pressing

 adjusts the resolution for faxing and copying.

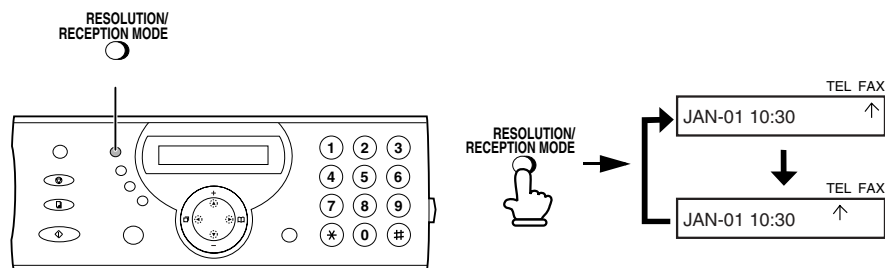

For more information on receiving faxes in FAX and TEL modes, see Chapter 3, *Receiving Faxes* (page 40).

## Volume Adjustment

You can adjust the volume of the speaker, handset, and ringer using the up and down arrow keys.

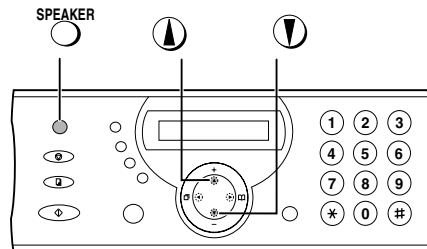

### Speaker

**1** Press 

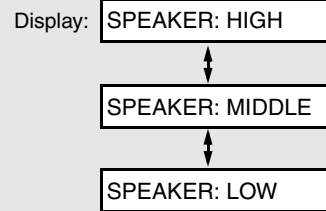

**2** Press  or  until the display shows the desired volume level.

- Press  again to turn off the speaker.



## Volume Adjustment

### Handset



**1** When talking through the handset, press  or  until the display shows the desired volume level.

- **Note:** The volume reverts to MIDDLE each time you replace the handset.

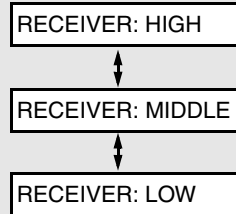
Display:





### Ringer

**1** Press  or . (Make sure  has not been pressed, the handset is not lifted, and a document is not loaded in the feeder.)

- The ringer will ring once at the selected level, then the date and time will reappear in the display.

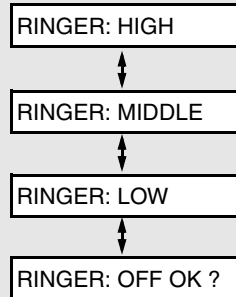
Display:



**2** If you selected RINGER: OFF OK ?, press .



## 2. Sending Faxes

### Transmittable Documents

#### Size and weight

The size and weight of documents that you can load in the document feeder depend on whether you load one page at a time or several pages at once.

Loading one page at a time:		Loading up to 10 pages at once:	
Minimum size	Maximum size	Minimum size	Maximum size
Minimum weight	Maximum weight	Minimum weight	Maximum weight
<div style="border: 1px solid black; padding: 5px; text-align: center;"> <b>14 lbs.</b>                      (52 g/m<sup>2</sup>)                 </div>	<div style="border: 1px solid black; padding: 5px; text-align: center;"> <b>42 lbs.</b>                      (157 g/m<sup>2</sup>)                 </div>	<div style="border: 1px solid black; padding: 5px; text-align: center;"> <b>14 lbs.</b>                      (52 g/m<sup>2</sup>)                 </div>	<div style="border: 1px solid black; padding: 5px; text-align: center;"> <b>21.5 lbs.</b>                      (80 g/m<sup>2</sup>)                 </div>

**Note:** Letters or graphics on the edges of a document will not be scanned.

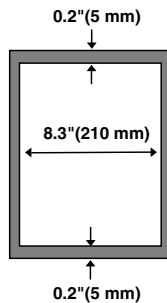

Letters in the shaded area will not be scanned.

Note: The full width of documents less than 8.3" (210 mm) wide is scanned.

## Loading the Document

### **Other restrictions**

- ◆ The scanner cannot recognize yellow, greenish yellow, or light blue ink.
- ◆ Ink, glue, and correcting fluid on documents must be dry before they pass through the document feeder.
- ◆ All clips, staples, and pins must be removed from documents before loading in the feeder. If these are not removed, they may damage the machine.
- ◆ Documents which are patched, taped, torn, smaller than the minimum size, carbon backed, easily smudged, or have a slippery coated surface should be photocopied, and the copy loaded in the feeder.

### **Loading the Document**

Up to 10 pages can be placed in the feeder at one time. The pages will automatically feed into the machine starting from the bottom page.

- ◆ If you need to send or copy more than 10 pages, place the additional pages gently and carefully in the feeder just before the last page is scanned. Do not try to force them in, as this may cause double-feeding or jamming.
- ◆ If your document consists of several large or thick pages which must be loaded one at a time, insert each page into the feeder as the previous page is being scanned. Insert gently to prevent double-feeding.

- 1** Adjust the document guides to the width of your document.

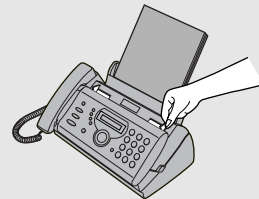

- 2** Insert the document face down in the document feeder. The top edge of the document should enter the feeder first.

- READY TO SEND will appear in the display.

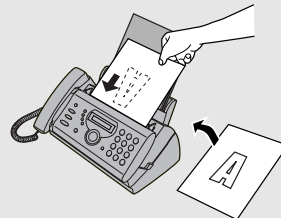

**3** Adjust the resolution and/or contrast settings as explained in *Resolution and Contrast* below, then dial the receiving machine as explained on page 27.

## Adjusting the Resolution and Contrast

If desired, you can adjust the resolution and contrast before sending a document.

The default resolution setting is STANDARD and the default contrast setting is AUTO.



You must adjust the settings each time you don't want to use the default settings.



**Note:** The resolution and contrast settings are only effective for sending a document. They are not effective for receiving a document.

### Resolution settings

STANDARD	Use STANDARD for ordinary documents. This setting gives you the fastest and most economical transmission.
FINE	Use FINE for documents containing small letters or fine drawings.
SUPER FINE	Use SUPER FINE for documents containing very small letters or very fine drawings.
HALF TONE	Use HALF TONE for photographs and illustrations. The original will be reproduced in 64 shades of gray.

## Adjusting the Resolution and Contrast

### Contrast settings

AUTO	Use AUTO for normal documents.
DARK	Use DARK for faint documents.

#### 1 Load the document(s).

- The document must be loaded before the resolution and contrast can be adjusted.

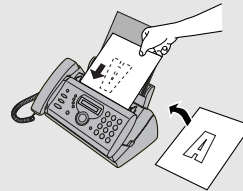

#### 2 Press one or more times until the desired resolution and contrast settings appear in the display.

- The first time you move through the list of resolution settings, the contrast setting AUTO will appear next to each resolution setting. The second time you move through the list, the contrast setting DARK will appear.

Display:

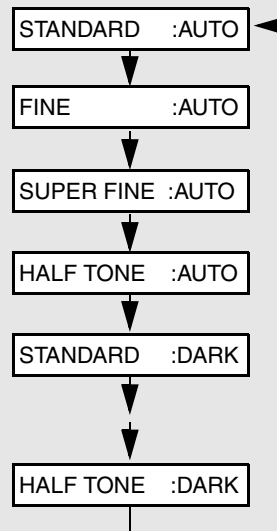

**Note:** In order to transmit in SUPER FINE resolution, the receiving fax machine must also have that resolution. If it doesn't, your machine will automatically step down to the next best available setting.

## Sending a Fax by Normal Dialing

With Normal Dialing, you pick up the handset (or press ) and dial by pressing the number keys.

- ◆ If a person answers, you can talk with them through the handset before sending the fax. (If you pressed , you must pick up the handset to talk.)
- ◆ Normal Dialing allows you to listen to the line and make sure the other fax machine is responding.

### 1 Load the document(s).

- If desired, press  to set the resolution and/or contrast.

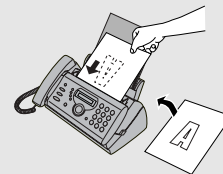

READY TO SEND

### 2 Pick up the handset or press . Listen for the dial tone.

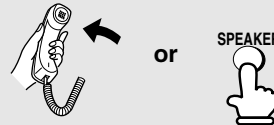

### 3 Dial the number of the receiving machine by pressing the number keys.



### 4 Wait for the connection. Depending on the setting of the receiving machine, you will either hear a fax tone or the other person will answer.

- If the other party answers, ask them to press their Start key (if you pressed , pick up the handset to speak with them). This causes the receiving machine to issue a fax tone.

## Sending a Fax by Automatic Dialing





**5** When you hear the fax tone, press  . Replace the handset.

- If the transmission is completed successfully, the fax will beep once.
- If an error occurs, the fax will beep three times and print a Transaction Report to inform you of the problem (see page 59).









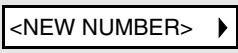

**Note:** If the transmission is unsuccessful and DOCUMENT JAMMED appears in the display, remove the document as explained on page 71. (This may occur if the other fax machine doesn't respond properly when you attempt to send the document.)

## *Sending a Fax by Automatic Dialing*

You can store up to 30 fax or phone numbers in the machine for automatic dialing. When you store a number, you select a two-digit Speed Dial number for it.

- ◆ Auto-dial numbers are dialed by pressing  , entering the two-digit Speed Dial number, and then pressing  .
- ◆ You can also search for an auto-dial number by pressing  or  .  
When the desired number appears in the display, press  to dial it.

























































### Storing fax and phone numbers for automatic dialing



<b>1</b> Press  once and  once.	Display: 
<b>2</b> If you know the Speed Dial number that you want to use, enter that number (for example, press   for Speed Dial 01). Otherwise, press  once (the machine will suggest an available Speed Dial number at the end of the storing procedure).	  <div style="border: 1px solid black; padding: 5px; width: fit-content;"><p>Any number from 01 to 30 can be selected as a Speed Dial number. The number must be 2 digits long (01, 02, 10, etc.).</p></div>
<b>3</b> Enter the fax or voice number by pressing the number keys. (Note: A space cannot be entered.) <ul style="list-style-type: none"><li>• To clear a mistake, press .</li><li>• If a pause is required between any of the digits to access a special service or an outside line, press . The pause appears as a hyphen (two seconds per pause). Several pauses can be entered in a row.</li></ul>	
<b>4</b> Press 	

Sending a Fax by Automatic Dialing

**5** Enter a name by pressing number keys for each letter as shown in the chart below. Up to 15 characters can be entered. (If you do not wish to enter a name, go directly to Step 6.)

Example: SHARP = 7777 44 2 777  7

SPACE = 	G = 	N =  	U =  
A = 	H =  	O =   	V =   
B =  	I =   	P = 	W = 
C =   	J = 	Q =  	X =  
D = 	K =  	R =   	Y =   
E =  	L =   	S =    	Z =    
F =   	M = 	T = 	

- ◆ To enter two letters in succession that require the same key, press  after entering the first letter.
- ◆ To enter a lower case letter, continue pressing the key for the letter until the lower case letter appears. To enter one of the following symbols, press  or  repeatedly:  
./!"#\$%&'()\*+,-.;<=>?@[¥]^\_`{|}~→←

**6** Press  .

If you selected a Speed Dial number in Step 2, the display will briefly show STORED, and then <NEW NUMBER>. Go to Step 7.

If you did not select a Speed Dial number in Step 2, the display will show the next available Speed Dial number. If that number is acceptable,

press  and go to Step 7. If not, enter the desired two digit

number, press , and go to Step 7.













**7** Return to Step 2 to store another number, or press  to return to the date and time display.



**Note:** The fax machine uses a lithium battery to keep automatic dialing numbers and other programmed information in memory when the power is turned off. Battery power is consumed primarily when the power is off. With the power kept continuously off, the life of the battery is about 5 years. If the battery dies, have your dealer or retailer replace it. Do not try to replace it yourself.

### ***Editing and clearing auto-dial numbers***



If you need to make changes to a previously stored auto-dial number, or clear a number, follow these steps:

<p><b>1</b> Press  once and  once.</p>	<p>Display:</p> <div style="border: 1px solid black; padding: 2px; display: inline-block;">&lt;NEW NUMBER&gt; </div>
<p><b>2</b> Enter the 2-digit Speed Dial number that you wish to edit or clear (for example, press  ) , or press  or  until the number appears in the display.</p>	
<p><b>3</b> Press  once.</p>	<div style="border: 1px solid black; padding: 2px; display: inline-block;">1=EDIT, 2=CLEAR</div>
<p><b>4</b> Select EDIT or CLEAR:</p> <p>EDIT:     CLEAR: </p> <ul style="list-style-type: none"> <li>• If you selected CLEAR, go to Step 8.</li> </ul>	
<p><b>5</b> If you selected EDIT, make the desired changes to the number.</p> <ul style="list-style-type: none"> <li>• Press  or  to move the cursor to the digit or digits you wish to change, and then enter the new digit. The new digit will replace the old digit.</li> <li>• If you do not wish to change the number, go directly to Step 6.</li> </ul>	

## Sending a Fax by Automatic Dialing

**6** Press **START/MEMORY** 

**7** Make the desired changes to the name.

- Press  or  to move the cursor to the letter or letters you wish to change, and then press the appropriate number key repeatedly until the desired letter appears (see Step 5 on page 30). The new letter will replace the old letter.
- If you do not wish to change the name, go directly to Step 8.

**8** Press **START/MEMORY** 

**9** Return to Step 2 to edit or clear another number, or press **STOP**  to return to the date and time display.



### Dialing an auto-dial number with the SPEED key

**1** Load the document(s).

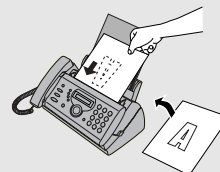
- If desired, press  to set the resolution and/or contrast.



READY TO SEND

**2** Press  and then enter the 2-digit Speed Dial number (for example, press  ).

**3** Check the display. If the name or number shown is correct, press

 . (If not, press  and repeat Step 2.)

- If the transmission is completed successfully, the machine will beep once.
- If an error occurs, the machine will beep three times and print a Transaction Report to inform you of the problem (see page 59).

**Using a Speed Dial number for a voice call**

To use a Speed Dial number for a voice call, lift the handset, press , and enter the Speed Dial number.

## Sending a Fax by Automatic Dialing

### Searching for an auto-dial number



If you don't remember the Speed Dial number in which you have stored a full fax or phone number, follow these steps to search for the number.

**1** If you are sending a fax, load the document(s).

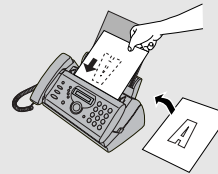
- If desired, press  to set the resolution and/or contrast.



READY TO SEND

**2** Press  (or ) until the name of the other party appears in the display (if no name was stored, the number will appear).

**3** If you are sending a fax, press . Dialing and transmission begins.

- If the transmission is completed successfully, the fax will beep once.
- If an error occurs, the fax will beep three times and print a Transaction Report to inform you of the problem (see page 59).

If you are making a phone call, lift the handset. Dialing begins. (If you lifted the handset before searching for the number, press  to begin dialing.)

### ***Sending a fax by Direct Keypad Dialing***

You can also enter a full number with the number keys and then press **START/MEMORY**  to begin dialing. You can use this method to dial a full number when you don't need to speak to the other party before faxing.

#### **1 Load the document(s).**

- If desired, press **RESOLUTION/RECEPTION MODE**  to set the resolution and/or contrast.

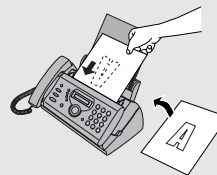

**READY TO SEND**

#### **2 Enter the number of the receiving machine by pressing the number keys.**

- If a pause is required between any of the digits to access a special service or an outside line, press **FUNCTION** . The pause will appear as a hyphen (two seconds per pause). Several pauses can be entered in a row.

#### **3 Check the display. If the number of the receiving machine shown is correct, press **START/MEMORY** .**

- If the number is not correct, press **STOP**  to backspace and clear one digit at a time, and then re-enter the correct digit(s).

## Sending a Fax by Automatic Dialing

### **Redial**

You can automatically redial the last number dialed. This procedure can be used to send a fax or make a phone call.

**1 If you are sending a fax, load the document(s).**

- If desired, press  to set the resolution and/or contrast.

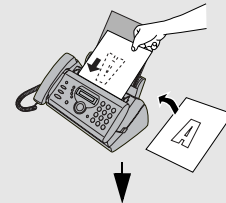

READY TO SEND

**2 Press  once. <REDIAL> appears in the display, followed by the last number dialed. Make sure the number that appears is the number you wish to dial.**

**3 If you are sending a fax, press . Dialing and transmission begins.**

**If you are making a phone call, lift the handset. Dialing begins.**

**Note:** If a fax transmission is unsuccessful and DOCUMENT JAMMED appears in the display, remove the document as explained on page 71. (This may occur if the other fax machine doesn't respond properly when you attempt to send the document.)

### **Automatic redialing**

If you use automatic dialing (including Direct Keypad Dialing) to send a fax and the line is busy, the fax machine will automatically redial the number. The fax machine will make three redial attempts at an interval of five minutes. During this time, RECALLING will appear in the display, followed by a two-digit number assigned to the fax job. You will not be able to dial any other locations while the message appears.

- ◆ To stop automatic redialing, press .
- ◆ Under certain conditions (for example if a person answers the call on a telephone), automatic redialing may stop before three redialing attempts are made.

## Sending a Fax From Memory

You can scan a document into the fax's memory and send the document from memory. This increases transmission speed and allows you to send a fax to multiple destinations in a single operation. After transmission, the document is automatically cleared from memory.

### Broadcasting (sending a fax to multiple destinations)

This function allows you to send the same fax to as many as 20 different locations in just one operation.

- ◆ When sending to multiple locations, only auto-dial numbers can be used to dial the numbers of the receiving machines.

#### 1 Load the document(s).

- If desired, press **RESOLUTION/RECEPTION MODE** to set the resolution and/or contrast.

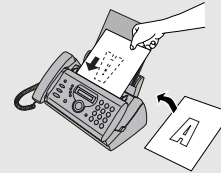

#### 2 Press **START/MEMORY**.

#### 3 Select a destination using one of the following methods:

- Press **SPEED** and enter a 2-digit Speed Dial number.
- Press **▶** (or **◀**) until the name of the number appears in the display (if no name was stored, the number will appear).

#### 4 Press **▼** to select the number.

#### 5 Repeat Steps 3 and 4 for each of the other locations to which you wish to send the fax (maximum of 20).

- To check your selected locations, press **▲** to scroll through them. To delete a location, scroll to the location and then press **STOP**.

## Sending a Fax From Memory







**6** When you are ready to begin transmission, press **START/MEMORY**  .

- A Transaction Report is automatically printed out after Broadcasting is completed. Check the "Note" column of the report to see if any of the locations are marked "Busy" or have a communication error code. If so, send the document to those locations again.

### ***Memory transmission***

You can also send a fax through memory when sending to a single location. This is convenient when sending to locations where the line is often busy, as it saves you from waiting to pick up the original document and frees the feeder for other operations.



To send a fax through memory, load the document, press **START/MEMORY**  , and then dial using one of the following methods:

- ◆ Press the number keys to enter the fax number and then press **START/MEMORY**  .
- ◆ Press **SPEED**  , enter a 2-digit Speed Dial number, and press **START/MEMORY**  .
- ◆ Press  repeatedly to select an auto-dial number and then press **START/MEMORY**  .
- ◆ Press  once to select the last number dialed and then press **START/MEMORY**  .



***If the memory becomes full...***

If the memory becomes full while the document is being scanned, MEMORY IS FULL and SEE MANUAL will alternately appear in the display.

- ◆ Press **START/MEMORY**  if you want to transmit the pages which have been stored up to that point in memory. The remaining pages will be ejected from the feeder. After transmission, the memory will be cleared and you can transmit the remaining pages. You will also need to transmit the page which was being scanned when the memory filled up.
  
- ◆ Press **STOP**  if you want to cancel the entire transmission.

---

## 3. Receiving Faxes

### Using FAX Mode

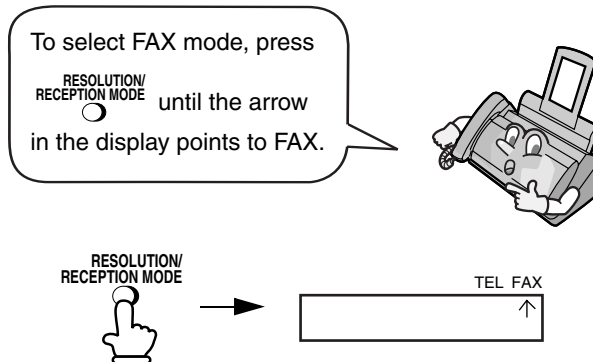

When the reception mode is set to FAX, the fax machine will automatically answer all calls on four rings and receive incoming faxes.

- ◆ If you pick up the handset before the machine answers, you can talk to the other party and/or receive a fax as explained in *Using TEL Mode* on page 41.

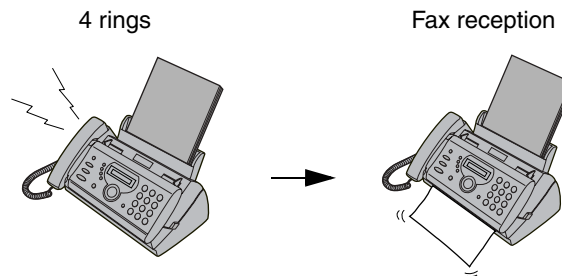







### Changing the number of rings

If desired, you can change the number of rings on which the fax machine answers incoming calls in FAX mode. Any number from 2 to 5 can be selected.

**1** Press  once and  once.

Display:

OPTION SETTING 

<b>2</b> Press  once.	NUMBER OF RING 
<b>3</b> Press  once.	ENTER (2-5) (4)
<b>4</b> Enter the desired number of rings (any number from 2 to 5).  Example: 3 rings 	The display briefly shows your selection, then:  TRANSACTION 
<b>5</b> Press  to return to the date and time display.	

Note: If you are using Distinctive Ring, the fax machine will answer calls after two rings regardless of the above setting.

## Using TEL Mode

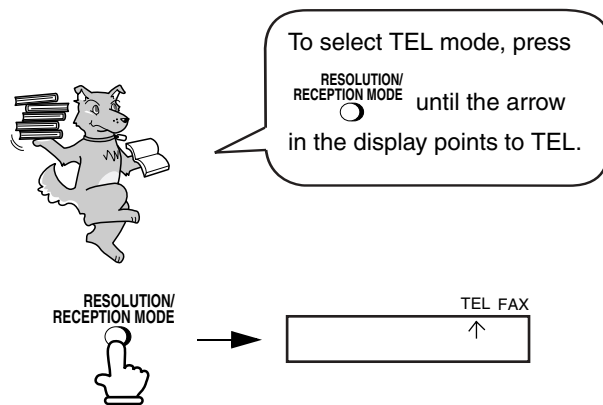

When the reception mode is set to TEL, you must answer all calls by picking up the fax machine's handset or an extension phone connected to the same line.

### Answering with the fax's handset

**Important:** If a document is loaded in the machine's feeder, remove it before performing the steps below. (Fax reception is not possible when a document is in the feeder.)

- 1** When the fax machine rings, pick up the handset.



- 2** If you hear a fax tone, wait until the display shows **RECEIVING** and then replace the handset.



RECEIVING

If **RECEIVING** does not appear (or if you have set the Fax Signal Receive setting to **NO**), press **START/MEMORY** to begin reception.



- 3** If the other party first speaks with you and then wants to send a fax, press **START/MEMORY** after speaking. (Press **START/MEMORY** before the sender presses their Start key.)

START/MEMORY



RECEIVING

- When **RECEIVING** appears in the display, hang up.



### **Answering on an extension phone connected to the same line**

**Important:** If a document is loaded in the machine's feeder, remove it before performing the steps below. (Fax reception is not possible when a document is in the feeder.)

- 1** Answer the extension phone when it rings.

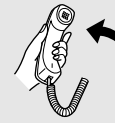

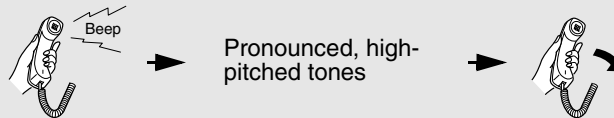

- 2** If you hear a soft fax tone, wait until your fax responds (you will hear pronounced, high-pitched tones), then hang up.



- 3** If the fax doesn't respond, or if the other party first talks to you and then wants to send a fax, set the phone done (do not hang up), walk over to the fax, lift the fax's handset, and press **START/MEMORY** .

- The above step is necessary if you have set the Fax Signal Receive setting to NO.









### **Putting a call on hold**

To put the other party on hold during a phone conversation, press **HOLD** . When this is done, they cannot hear you. You can put the handset back in the cradle without breaking the connection. When you are ready to speak with the other party again, pick up the handset. If you did not put the handset back in the cradle, press **HOLD**  again to resume conversation.

## Optional Reception Settings

### Fax Signal Receive

Your fax will automatically begin reception if you hear a soft fax tone after answering a call on your fax or an extension phone. If you use a computer fax modem to send documents on the same line, you must turn this function off in order to prevent your fax from mistakenly attempting to receive documents from the computer fax modem. Follow the steps below to change the setting.

<b>1</b> Press  once and  once.	Display: <input type="text" value="OPTION SETTING"/>
<b>2</b> Press  once and  4 times.	<input type="text" value="FAX SIGNAL RX"/>
<b>3</b> Press  once.	<input type="text" value="1=YES, 2=NO"/>
<b>4</b> Press  to turn on the function, or  to turn it off.	The display briefly shows your selection, then: <input type="text" value="CALLER-ID"/>
<b>5</b> Press  to return to the date and time display.	

### Reception Ratio

The fax has been set at the factory to automatically reduce the size of received documents to fit the size of the printing paper. This ensures that data on the edges of the document are not cut off. If desired, you can turn this function off and have received documents printed at full size.

- ◆ If a document is too long to fit on the printing paper, the remainder will be printed on a second page. In this case, the cut-off point may occur in the middle of a line.
- ◆ Automatic reduction may not be possible if the received document is too large, contains too many fine graphics or images, or is sent at high resolution. In this case, the remainder of the document will be printed on a second page.

<p><b>1</b> Press <b>FUNCTION</b> once and <b>▲</b> once.</p>	<p>Display: OPTION SETTING <b>↕</b></p>
<p><b>2</b> Press <b>▶</b> once and <b>▲</b> 4 times.</p>	<p>RECEIVE RATIO <b>↕</b></p>
<p><b>3</b> Press <b>▶</b> once.</p>	<p>1=AUTO, 2=100%</p>
<p><b>4</b> Press <b>1</b> to select AUTO, or <b>2</b> to select 100%.</p>	<p>The display briefly shows your selection, then: PRINT CONTRAST <b>↕</b></p>
<p><b>5</b> Press <b>STOP</b> to return to the date and time display.</p>	

## Substitute Reception to Memory

### ***Substitute Reception to Memory***

In situations where printing is not possible, such as when your fax runs out of paper, the imaging film needs replacement, or the paper jams, incoming faxes will be received to memory.

When you have received a document in memory, FAX RX IN MEMORY will appear in the display, alternating with ADD PAPER & PRESS START KEY or CHECK FILM / CHECK COVER / CHECK PAPER JAM. When you add paper (and press **START/MEMORY** ) , replace the imaging film, or clear the jam, the stored documents will automatically print out.

- ◆ If you received documents in memory because the fax ran out of paper, be sure to add paper which is the same size as the paper previously used. If not, the document print-out size may not match the size of the printing paper.

#### **Caution!**

When documents are stored in memory, do not turn the power off. This will erase all of the contents.



## 4. Making Copies

Your fax machine can also be used to make copies. Single and multiple copies (up to 99 per original) can be made, enabling your fax to double as a convenience office copier.

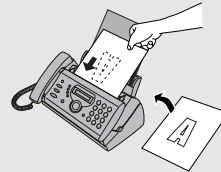

### 1 Load the document(s) face down. (Maximum of 10 pages.)

- If desired, press  to set the resolution and/or contrast. (The default resolution setting for copying is FINE.)



READY TO SEND

### 2 If desired, select an enlarge/reduce setting, and/or select the number of copies per original:

- ENLARGE/REDUCE: Press  or  until the desired setting appears in the display. Settings are 100%, 125%, 135%, 50%, 73%, 88%, 94%, and AUTO. (The default setting is 100%.)

Example: Press  twice →

- Number of copies per original: Press the number keys to enter a number from 1 to 99. (The default setting is 1.)

Example: Press  for five copies →

### 3 When you are ready to begin copying, press .











#### If MEMORY IS FULL appears...

If the memory becomes full while a document is being scanned, MEMORY IS FULL and SEE MANUAL will alternately appear in the display and the document will automatically feed out. This may happen if the resolution is set to SUPER FINE, or if you selected an enlarge/reduce setting, or if you are making more than one copy per original. To avoid using memory, use STANDARD or FINE for the resolution, 100% for the enlarge/reduce setting, and make only one copy per original.

## Making Copies

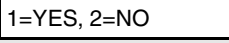
### Copy Cut-off

When making a copy of a document that is longer than the printing paper, use the copy cut-off setting to select whether the remaining part of the document will be cut off or printed on a second page. The initial setting is YES (cut off the remainder). To change the setting, follow the steps below.

<b>1</b> Press  once and  once.	Display: 
<b>2</b> Press  once and  once.	
<b>3</b> Press  once.	
<b>4</b> Press  to set copy cut-off to YES (the remaining part of the document will not be printed), or  to set copy cut-off to NO (the remaining part will be printed on a second page).	The display briefly shows your selection, then: 
<b>5</b> Press  to return to the date and time display.	

---









## 5. Special Functions

### Caller ID (Requires Subscription to Service)

If you subscribe to a caller identification service from your telephone company, you can set your fax machine to display the name and number of the caller while the fax rings.

**Important:**

- ◆ To use this function, you must subscribe to a caller identification service from your telephone company. Note that the machine may not be compatible with some caller identification services.
- ◆ **Area Code mode:** This step is needed if your telephone exchange cannot dial a local phone number (within your calling area code) when the area code is dialed with the phone number (see Step 5).

<b>1</b> Press  once and  once.	Display: <input type="text" value="OPTION SETTING"/>
<b>2</b> Press  once and  5 times.	<input type="text" value="CALLER-ID"/>
<b>3</b> Press  once.	<input type="text" value="1=YES, 2=NO"/>
<b>4</b> Press  (YES) to turn on Caller ID. (To turn off Caller ID, press  and go to Step 8.)	<input type="text" value="AREA CODE # MODE"/> ↑ ↓ <input type="text" value="1=SET, 2=CLEAR"/>
<b>5</b> Press  to select SET. (To clear a previously set area code, press  and go to Step 8.)	<input type="text" value="ENTER AREA CODE"/>

**Note:** Entering your area code in this step causes it to be automatically removed from local numbers in the Caller ID list (page 51). This is only required if you need to eliminate dialing of the area code when dialing a local number from the list. Example (using the area code "123"): If Step 5 is skipped, the Caller ID display will show 123-444-1234, and the number that will dial from the Caller ID list is 123-444-1234. If the area code 123 is entered in Step 5, the Caller ID display will show 444-1234, and the number that will dial from the Caller ID list is 444-1234.

## Caller ID (Requires Subscription to Service)

**6** Enter the three digits of your area code.

**7** Press  to store your area code.



**8** Press  to return to the date and time display.

### ***How Caller ID operates***

When you receive a call, the name and phone number of the caller will alternately appear in the display, beginning just before the second ring. The information will continue to be displayed until the line is disconnected.

**Note:** Some caller ID services may not provide the name of the caller. In this case, only the phone number will appear.

Display example

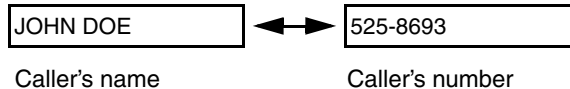

### ***Display messages***

One of the following messages will appear while the fax rings if caller information is not available.

NO SERVICE	No caller information was received from your telephone company. Make sure that the telephone company has activated your service.
CALLER-ID ERROR	Noise on the telephone line prevented reception of caller information.
OUT OF AREA	The call was made from an area which does not have a caller identification service, or the caller's service is not compatible with that of your local phone company.
PRIVATE CALL	Caller information was not provided by the telephone company at the caller's request.

## Caller ID (Requires Subscription to Service)

### Viewing the Caller ID list



If you subscribe to a Caller ID service and have turned on the Caller ID function, your fax machine will keep information on the most recent 30 calls and faxes you have received. You can view this information, which consists of the name and number of each caller, in the Caller ID List.

- ◆ After you have received 30 calls, each new call will delete the oldest call.
- ◆ All calls will be erased if you unplug the fax or a power failure occurs.

Follow the steps below to view the Caller ID List in the display. If desired, you can immediately dial a number when it appears.

**1** Press  twice.





**2** Press  or  to scroll through the list.

**3** If you want to dial one of the numbers in the list, scroll through the list until the number appears in the display.

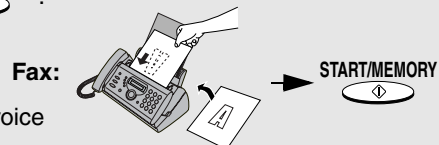
- **Fax:** If you want to send a fax, load the document and then press . Dialing and transmission begin.



- **Voice call:** If you want to make a voice call, pick up the handset (or press ). Dialing begins automatically.

(If you pressed , pick up the handset when the other party answers.)



**4** Press  when you have finished viewing the list.

## Caller ID (Requires Subscription to Service)

### To delete calls from the Caller ID list

If you want to delete a single call from the caller list, press **#** while the call appears in the display. If you want to delete all calls from the list, hold **#** down for at least 3 seconds while you are viewing any number in the list.

### Priority Call

With Caller ID turned on, you can set your fax to make a special ringing sound when you receive a call from a designated phone number. This lets you know immediately who is calling without having to look at the display.

To use this function, enter the desired phone number by following the steps below (only one phone number can be entered).

<b>1</b> Press <b>FUNCTION</b> once and <b>▼</b> twice.	Display: <b>ENTRY MODE</b>
<b>2</b> Press <b>▶</b> once and <b>▲</b> once.	<b>PRIORITY #</b>
<b>3</b> Press <b>▶</b> once.	<b>1=SET, 2=CLEAR</b>
<b>4</b> Press <b>1</b> to store a number. (To clear a previously stored number, press <b>2</b> and go to Step 6.)	
<b>5</b> Enter the number by pressing the number keys (max. 20 digits).	
<b>6</b> Press <b>START/MEMORY</b> to store (or clear) the number.	<b>OWN NUMBER SET</b>
<b>7</b> Press <b>STOP</b> to return to the date and time display.	

Caller ID (Requires Subscription to Service)

### ***Blocking voice calls***

With Caller ID turned on, you can use the Anti Junk Fax function described in *Blocking Reception of Unwanted Faxes* in this chapter to block voice calls as well as faxes from your specified Anti Junk Number.

In this case, when a voice call or a fax transmission comes in from the number you have specified as a "Junk Number", your fax will break the connection as soon as it receives the calling phone number from the caller ID service (before the second ring).

To use this function, enter the number that you wish to block as explained in *Blocking Reception of Unwanted Faxes* (see page 56). Only one number can be blocked.

**Note:** This function cannot be used if you are using the Distinctive Ring function.

Distinctive Ring (Requires Subscription to Service)

## ***Distinctive Ring (Requires Subscription to Service)***







**Important:**

- ◆ **To use distinctive ring, you must subscribe to a distinctive ring service from your local phone company. Do not turn on this function if you do not subscribe to a distinctive ring service.**
- ◆ Your fax may not be compatible with some distinctive ring services.

Distinctive ring is a service offered by some local telephone companies whereby they assign an additional second number to your regular single line. The second number rings differently from your normal number.

If you subscribe to a distinctive ring service, you can set the fax machine to automatically answer when your second number is called. This allows you to use the second number as an exclusive fax number.

To have your fax automatically answer when your second number is called, follow the steps below:

<b>1</b> Press  <b>once</b> and  <b>once.</b>	Display: 
<b>2</b> Press  <b>once</b> and  <b>3 times.</b>	
<b>3</b> Press  <b>once.</b>	



Distinctive Ring (Requires Subscription to Service)

**4** Press a number from 1 to 3 (1 to 5 in Canada) to select the ring pattern below that matches your second number's ring pattern. Or, press 6 to have your fax automatically answer your normal telephone number. Press 7 to turn off the distinctive ring function.

- |   |                                 |  |
|---|---------------------------------|--|
| ① | RING PATTERN 1                  | Two short rings.                         |
| ② | RING PATTERN 2                  | One short, one long, and one short ring. |
| ③ | RING PATTERN 3                  | Two short rings and one long ring.       |
| ④ | RING PATTERN 4<br>(Canada only) | Three very short rings.                  |
| ⑤ | RING PATTERN 5<br>(Canada only) | Two very short rings.                    |
| ⑥ | STANDARD RING                   | Your standard (normal) ring pattern.     |
| ⑦ | OFF SETTING                     | Turn distinctive ring off.               |

The display briefly shows your selection, then:

FAX SIGNAL RX 

**5** Press  to return to the date and time display.

**6** Set the reception mode to FAX.

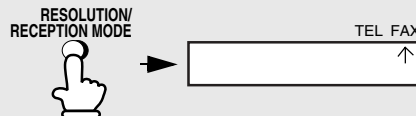









- ◆ When using distinctive ring, you must set the reception mode of your fax to FAX. When your designated fax number is dialed, your fax will automatically answer and begin reception after two rings. Note that other devices on the same line will also ring until your fax answers. If one of your other numbers is dialed, the fax will ring; however, it will not answer.

## Blocking Reception of Unwanted Faxes

### ***Blocking Reception of Unwanted Faxes***

The Anti Junk Fax function allows you to block reception of faxes from a party that you specify. This saves paper by not printing out unwanted "junk" faxes. To use this function, follow the steps below to enter the fax number from which you do not wish to receive faxes. One fax number can be entered.



<b>1</b> Press  once and  twice.	Display: <input type="text" value="ENTRY MODE"/>
<b>2</b> Press  once and  twice.	<input type="text" value="ANTI JUNK #"/>
<b>3</b> Press  once.	<input type="text" value="1=SET, 2=CLEAR"/>
<b>4</b> Press  to store an Anti Junk number, or  to clear a previously stored number (if you are clearing a number, go to Step 6).	
<b>5</b> Enter the fax number by pressing the number keys (max. 20 digits).	
<b>6</b> Press  and then press  to return to the date and time display.	

## ***Polling (Requesting a Fax Transmission)***

Polling allows you to call another fax machine and have it send a document (previously loaded in its feeder) to your machine without assistance from the operator of the other machine.

- ◆ **Hint:** Polling is useful when you want the receiving fax machine, not the transmitting fax machine, to bear the cost of the call. To use the polling function, the other machine must be capable of being polled.
- ◆ To use the polling function, the other machine must be capable of being polled.
- ◆ Before polling, make sure the other machine is set up to receive your polling request.
- ◆ Your machine is not capable of being polled.

### **1 Dial the fax machine you want to poll using one of the following methods:**

- Enter the full number using the numeric keys.
- Pick up the handset (or press  ) and dial the full number. Wait for the fax answerback tone.
- Press  or  until the name (or number) of the other party appears in the display.









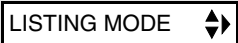

### **2 Press .**

- If you used the handset, replace it when POLLING appears in the display. Reception will begin.

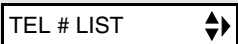
---

## 6. Printing Lists

You can print lists showing settings and information entered in the fax machine. The lists are described below. To print a list, follow these steps.

<b>1</b> Press  once and  once.	Display: 
<b>2</b> Press  once.	
<b>3</b> Press  or  until the desired list appears in the display.	
<b>4</b> Press  once.	
<b>5</b> Press  to print the list.	

### **Telephone Number List**

This list shows the fax and phone numbers that have been stored for automatic dialing.

### **Setup List**

This list shows your current selections for the **FUNCTION** key settings. The list also shows your name and fax/telephone number as entered in the machine, and a sample of the header printed at the top of every page you transmit (**HEADER PRINT**).

### **Caller-ID List**

This list shows information about your 30 most recent calls. (This list is only available if you are using the Caller ID function.)

## Transaction Report

This report is printed out automatically after an operation is completed to allow you to check the result. Your fax machine is set at the factory to print out the report only when an error occurs.

- ◆ The Transaction report cannot be printed on demand.

### Headings in Transaction Report

**SENDER/  
RECEIVER** The name or fax number of the other machine involved in the transaction. If that machine does not have an ID function, the communication mode will appear (for example, "G3").

**START** The time at which transmission/reception started.

**TX/RX TIME** Total time taken for transmission/reception.

**PAGES** Number of pages transmitted/received.

**NOTE** (One of the following notes will appear under **NOTE** in the report to indicate whether the transaction was successful, and if not, the reason for the failure.)

**OK** - Transmission/reception was successful.

**P.FAIL** - A power failure prevented the transaction.

**JAM** - The printing paper or document jammed, preventing the transaction.

**BUSY** - The fax was not sent because the line was busy.



**COM.E-0 to COM.E-7** - A telephone line error prevented the transaction. See *Line error* on page 64.

**CANCEL** - The transaction was cancelled because the **STOP** key was pressed, no document was in the feeder, or the other machine requested transmission using a function which your fax machine does not have. If you were attempting to fax, make sure a document is in the feeder. If you were receiving, contact the faxing party to see how they are trying to send to you.

## Printing Lists

### **Transaction Report print condition**

You can change the condition under which a Transaction Report is printed out. Follow the steps below.

<b>1</b> Press <b>FUNCTION</b> once and <b>▲</b> once.	Display: OPTION SETTING 
<b>2</b> Press <b>▶</b> once and <b>▼</b> once.	TRANSACTION 
<b>3</b> Press <b>▶</b> once.	1:ALWAYS PRINT (Selections appear alternately)
<b>4</b> Press a number from <b>①</b> to <b>⑤</b> to select the condition for printing.	
<b>①</b> ALWAYS PRINT	A report will be printed after each transmission, reception, or error.
<b>②</b> ERROR/MEMORY	A report will be printed after an error or a memory operation.
<b>③</b> SEND ONLY	A report will be printed after each transmission.
<b>④</b> ERROR ONLY	A report will be printed only when an error occurs.
<b>⑤</b> NEVER PRINT	A report will never be printed.
	The display briefly shows your selection, then: DIAL MODE 
<b>5</b> Press <b>STOP</b> to return to the date and time display.	

---

## 7. Maintenance

### Print head

Clean the print head frequently to ensure optimum printing performance.

**Note:** Remove the paper from the paper tray before cleaning the print head.

- 1** Unplug the power cord, and open the operation panel (press **1**).

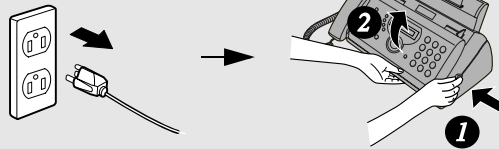

- 2** Take the imaging film out of the print compartment and place it on a sheet of paper.

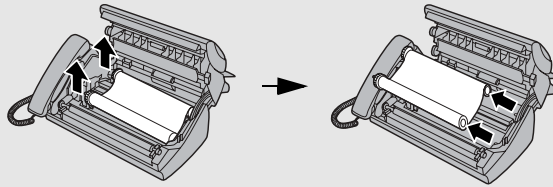

- 3** Wipe the print head with isopropyl alcohol or denatured alcohol.

**Caution!**

- Do not use benzene or thinner. Avoid touching the print head with hard objects.
- The print head may be hot if your fax machine has just received a large number of documents. If this is the case, allow the print head to cool prior to cleaning.

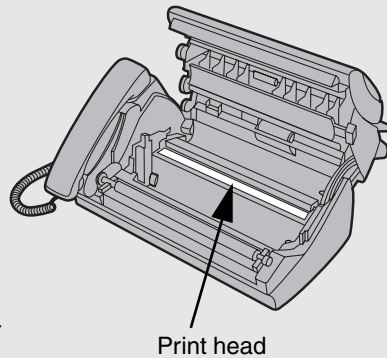

## Maintenance

- 4** Place the imaging film back in the print compartment.

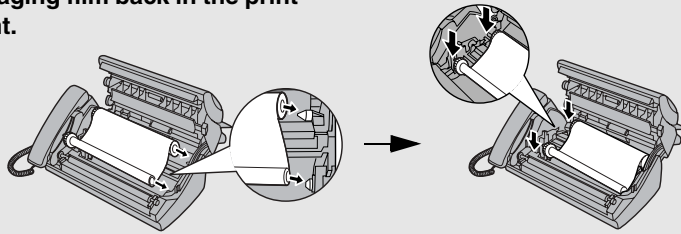

- 5** Rotate the front gear until the film is taut, and then close the operation panel (press down on both sides to make sure it clicks into place).

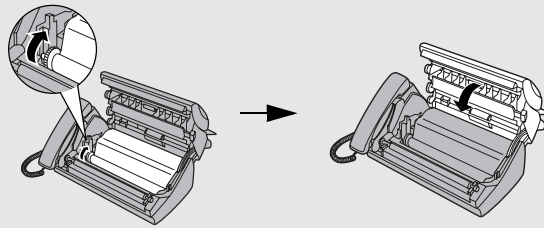

## Scanning glass and rollers

Clean the scanning glass and rollers frequently to ensure the quality of transmitted images and copies.

**Note:** Remove the paper from the paper tray before cleaning the scanning glass and rollers.

- 1** Open the operation panel (press **1**).

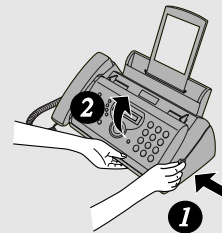



- 2** Flip up the green levers on each side of the white roller.

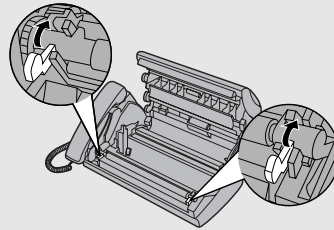

- 3** Wipe the scanning glass (under the white roller) and rollers with a cotton swab.

- Make sure that all dirt and stains (such as correcting fluid) are removed. Dirt and stains will cause vertical lines on transmitted images and copies.

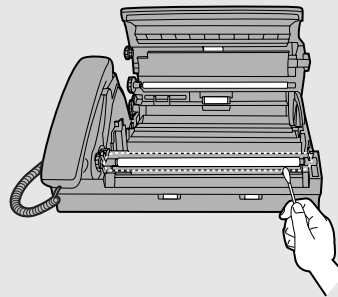

**If the scanning glass is difficult to clean**

If you find it difficult to remove dirt from the scanning glass, you can try moistening the swab with isopropyl alcohol or denatured alcohol. Take care that no alcohol gets on the rollers.

- 4** Flip down the green levers on each side of the white roller. Rotate the front gear until the film is taut, and then close the operation panel (press down on both sides to make sure it clicks into place).

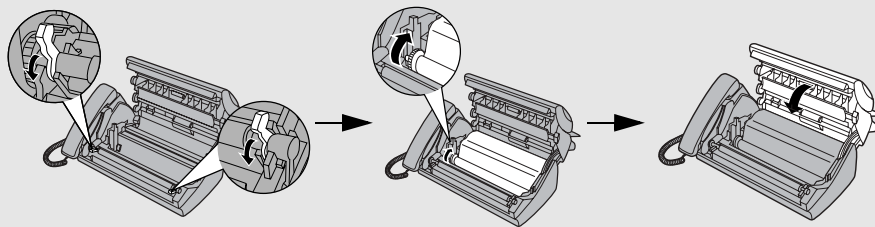

**The housing**

Wipe the external parts and surface of the machine with a dry cloth.

**Caution!**

Do not use benzene or thinner. These solvents may damage or discolor the machine.

---

## 8. Troubleshooting

### Problems and Solutions

If you have any problems with your fax, first refer to the following troubleshooting guide. If you cannot solve the problem, call Sharp's Customer Assistance Center at 1-800-BE SHARP.

#### Line error

Problem	Solution
LINE ERROR appears in the display.	<p>Try the transaction again. If the error persists, check the following:</p> <ul style="list-style-type: none"><li>• Check the connection. The cord from the <b>TEL. LINE</b> jack to the wall jack should be no longer than six feet.</li><li>• Make sure there are no modem devices sharing the same telephone line.</li><li>• Check with the other party to make sure their fax machine is functioning properly.</li><li>• Have your telephone line checked for line noise.</li><li>• Try connecting the fax machine to a different telephone line.</li><li>• If the problem still occurs, your fax machine may need service.</li></ul>

**Dialing and transmission problems**

Problem	Solution
No dial tone when you pick up the handset or press the <b>SPEAKER</b> key.	<ul style="list-style-type: none"> <li>• Make sure the handset cord is connected to the correct jack. See <i>Connecting the handset</i> on page 9.</li> </ul>
Dialing is not possible.	<ul style="list-style-type: none"> <li>• Make sure the power cord is properly plugged into a power outlet.</li> <li>• Make sure that the telephone line is properly connected to both the <b>TEL. LINE</b> jack and the wall jack.</li> <li>• Make sure that the fax machine is set to the correct dialing mode for your telephone line. See <i>Dial mode</i> on page 10.</li> </ul>
The power is on, but no transmission takes place.	<ul style="list-style-type: none"> <li>• Make sure that the receiving machine has paper.</li> <li>• If the receiving machine is in manual mode with no attendant, reception will not be possible.</li> <li>• Check the display for error messages.</li> <li>• Pick up the handset and check for a dial tone.</li> </ul>
Nothing is printed at the receiving end.	<ul style="list-style-type: none"> <li>• Make sure that the document for transmission is placed face down in the feeder.</li> </ul>
A distorted image is received at the other end.	<ul style="list-style-type: none"> <li>• Noise on the telephone line may cause distortion. Try sending the document again.</li> <li>• Make a copy of the document on your fax machine. If the copy is also distorted, your fax machine may need service.</li> </ul>

## Problems and Solutions

### ***Reception and copying problems***

<b>Problem</b>	<b>Solution</b>
The fax machine doesn't receive documents automatically.	<ul style="list-style-type: none"><li>• Make sure that the reception mode is set to FAX. If you subscribe to a distinctive ring service, make sure that the Distinctive Ring function is set to the correct ring pattern. If you do not subscribe to a distinctive ring service, make sure that Distinctive Ring is set to OFF SETTING. (See <i>Distinctive Ring</i> on page 54.)</li></ul>
The printing paper comes out blank when you try to receive a document.	<ul style="list-style-type: none"><li>• Make sure that the document is loaded properly in the feeder of the transmitting machine. Make a copy or print a report to confirm the printing ability of your machine.</li></ul>
General print quality is poor.	<ul style="list-style-type: none"><li>• It is important to select a paper that is appropriate for the thermal transfer printer in your fax. We recommend using laser quality paper that has a very smooth finish. Copier paper will work, but it sometimes tends to yield a lighter print quality.</li></ul>
The received document is faint.	<ul style="list-style-type: none"><li>• Ask the other party to send higher contrast documents. If the contrast is still too low, your fax machine may need service. Make a copy or print a report to check your machine's printing ability.</li></ul>
Received images are distorted.	<ul style="list-style-type: none"><li>• Noise on the telephone line may cause distortion. Have the other party try sending the document again.</li><li>• The print head may be dirty. See <i>Print head</i> on page 61.</li><li>• Make a copy or print a report on your fax machine. If the copy or report is also distorted, your fax machine may need service.</li></ul>
A received document or copy prints out in strips.	<ul style="list-style-type: none"><li>• Make sure the operation panel is completely closed (press down on both sides of the panel).</li></ul>

The quality of copies is poor and/or dark vertical lines appear.	<ul style="list-style-type: none"> <li>Any dirt or material on the scanning glass will cause spots to appear on copies and transmitted faxes. Clean the scanning glass as explained on page 62.</li> </ul>
Reception/copying is interrupted.	<ul style="list-style-type: none"> <li>If reception or copying takes place continuously for a long time, the print head may overheat. Turn off the power and let it cool down. If overheating frequently occurs, try changing the print contrast setting to LIGHT (see page 15).</li> </ul>
Dark vertical lines appear on copies and received faxes.	<ul style="list-style-type: none"> <li>Try changing the print contrast setting to LIGHT (see page 15).</li> </ul>

### **General problems**

<b>Problem</b>	<b>Solution</b>
Auto-dial numbers cannot be stored in the fax.	<ul style="list-style-type: none"> <li>Make sure the fax is plugged in and the imaging film has been loaded. (Auto-dial numbers cannot be stored if the imaging film has not been loaded.) See <i>Loading the Imaging Film</i> on page 12.</li> </ul>
Nothing appears in the display.	<ul style="list-style-type: none"> <li>Make sure the power cord is properly plugged into a power outlet.</li> <li>Connect another electrical appliance to the outlet to see if it has power.</li> </ul>
The machine does not respond when you press any of its keys.	<ul style="list-style-type: none"> <li>If a beep sound is not made when you press the keys, unplug the power cord and then plug it in again several seconds later.</li> </ul>
Automatic document feeding does not work for transmission or copying.	<ul style="list-style-type: none"> <li>Check the size and weight of the document (see <i>Transmittable Documents</i> on page 23).</li> </ul>

## ***Messages and Signals***

### ***Display messages***

**Note:** If you have turned on the Caller ID function, see page 50 for display messages related to Caller ID.

ADD PAPER & / PRESS START KEY (alternating messages)	Check the printing paper. If the tray is empty, add paper and then press the <b>START/MEMORY</b> key. If there is paper in the tray, make sure it is inserted correctly (take out the stack, align the edges evenly, and then reinsert it in the tray) and then press the <b>START/MEMORY</b> key.
CHECK FILM/ CHECK COVER/ CHECK PAPER JAM (alternating messages)	These alternating messages appear when there is a problem in the print compartment that prevents printing. Check to see if the imaging film is not loaded properly or if it has been used up and needs replacement. Make sure the operation panel is completely closed (press down on both sides). If a paper jam has occurred, clear the jam as explained in the following section, <i>Clearing Paper Jams</i> .
CHECK PAPER SIZE	The paper size setting is incorrect. Change the paper size setting as explained on page 15.
DOCUMENT JAMMED	The original document is jammed. See the following section, <i>Clearing Paper Jams</i> . Document jams will occur if you load more than 10 pages at once or load documents that are too thick (see page 23).
FAX RX IN MEMORY	A fax has been received in memory because the imaging film needs replacement, you have run out of printing paper, or the paper is jammed. The fax will print out automatically when the problem is fixed.
FUNCTION MODE	The <b>FUNCTION</b> key has been pressed.
LINE ERROR	Transmission or reception was not successful. Press the <b>STOP</b> key to clear the message and then try again. If the error persists, see <i>Line Error</i> on page 64.

MEMORY IS FULL/ SEE MANUAL (alternating messages)	The memory is full. This may occur during fax reception if too much data is received before the pages can be printed out. If faxes have been received to memory because printing is not possible (an additional message will indicate the problem), resolve the problem so that printing can continue (see <i>Substitute Reception to Memory</i> on page 46). If you are attempting to transmit from memory, see <i>If the memory becomes full</i> on page 39. If you are copying, see <i>If MEMORY IS FULL appears</i> on page 47.
MEMORY PRINTING	The fax is preparing to or printing out a document from memory.
NO DATA	This appears if you attempt to search for an auto-dial number when none have been stored.
OFF HOOK	This appears if you forgot to replace the handset after using it to dial and send a fax. Replace the handset or press the <b>STOP</b> key to clear the message.
ON HOOK DIAL	The <b>SPEAKER</b> key has been pressed and the fax machine is waiting for you to dial.
OVER HEAT	The print head has overheated. Operation can be continued after it cools. If overheating frequently occurs, try changing the print contrast setting to LIGHT (see page 15).
PRINT HEAD FAIL/ YOU NEED SERVICE (alternating messages)	The print head has failed and requires service.
READY TO SEND	A document has been loaded and the fax machine is waiting for you to begin faxing or copying.
RECALLING	This appears if you attempt to send a fax by automatic dialing and the line is busy or the receiving fax machine does not answer. Your fax machine will automatically reattempt the call. (See <i>Automatic redialing</i> on page 36.)
TOTAL PAGE(S) 01	Number of pages transmitted, received, or copied.

## Messages and Signals

### ***Audible signals***

Continuous tone	3 seconds	Indicates the end of transmission, reception, or copying.
Intermittent tone (3 beeps)	5 seconds (1 second on, 1 second off)	Indicates incomplete transmission, reception, or copying.
Rapid intermittent tone	35 seconds (0.7 seconds on, 0.3 seconds off)	Indicates that the handset is off hook.



## Clearing Paper Jams

### Clearing a jammed document

If the original document doesn't feed properly during transmission or copying, or DOCUMENT JAMMED appears in the display, first try pressing



. If the document doesn't feed out, remove it as explained below.

#### Important:

Do not try to remove a jammed document without releasing it as explained below. This may damage the feeder mechanism.

- 1 Press **1** and slowly open the operation panel until it is half open.

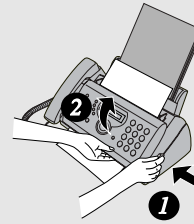

- 2 Flip up the green levers on each side of the white roller.

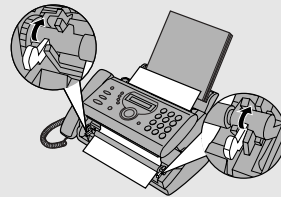

- 3 Gently and remove the document.

- Be careful not to tear the document.

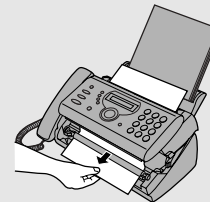

## Clearing Paper Jams

- 4** Flip down the green levers on each side of the white roller. Rotate the front gear until the film is taut, and then close the operation panel (press down on both sides to make sure it clicks into place).

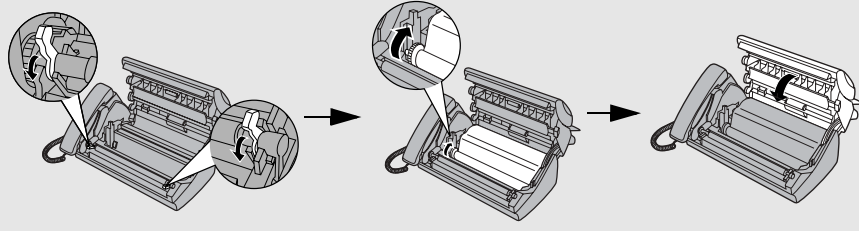

## Clearing jammed printing paper

- 1** Open the operation panel (press ❶).

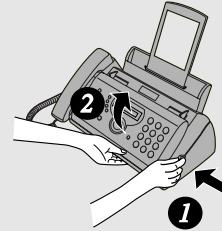

- 2** Gently pull the jammed paper out of the machine, making sure no torn pieces of paper remain in the print compartment or rollers.

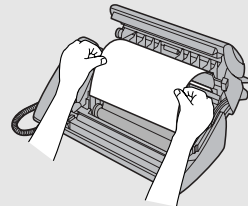

- 3** Rotate the front gear until the film is taut, and then close the operation panel (press down on both sides to make sure it clicks into place).

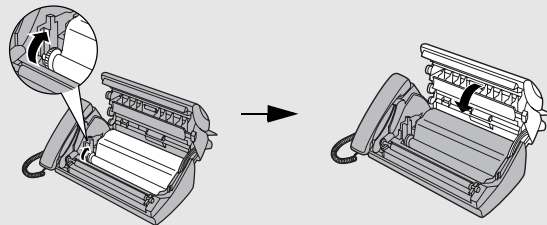

## **Ordering Parts**

To order parts, contact the parts distribution center located nearest you. When ordering a part, use the part order number shown below.

Operation manual	TINSE4463XHTZ
Setup Guide	TCADZ3744XHZZ
Handset cord	QCNWG209BXHOW
Telephone line cord	QCNWG370BXHZZ
Hand set	DUNTK497CXHFW
Paper tray	CPLTP3183XHRF
Paper tray extension	CPLTP3222XHR2
Gears	CGERH2566XH01 NGERH2568XHZZ

### **Part distribution centers**

Tritronics, Inc. 1306 Continental Drive Abingdon, MD 21009	Tel: 1-800-638-3328 Fax: 1-800-888-FAXD
--	--

Tritronics, Inc. 1015 NW 52nd Street Ft. Lauderdale, FL 33309	Tel:1-800-365-8030 Fax: 1-800-999-FAXD
---	---

Fox International, Ltd. 23600 Aurora Road Bedford Heights, OH 44146	Tel: 1-800-321-6993 Fax: 1-800-445-7991
---	--

Andrews Electronics 25158 Avenue Stanford Santa Clarita, CA 91355	Tel: 1-800-274-4666 Fax: 1-805-295-5126
---	--

Sharp Accessories and Supply Center 2130 Townline Road Peoria, IL 61615	Tel: 1-800-642-2122
--	---------------------

## FCC Regulatory Information

### ***FCC Regulatory Information***

This equipment complies with Part 68 of the FCC rules and the requirements adopted by the ACTA. On the rear of this equipment is a label that contains, among other information, a product identifier in the format US:AAAEQ##TXXXX. If requested, this number must be provided to the telephone company.

A plug and jack used to connect this equipment to the premises wiring and telephone network must comply with the applicable FCC Part 68 rules and requirements adopted by the ACTA. A compliant telephone cord and modular plug is provided with this product. It is designed to be connected to a compatible modular jack that is also compliant. See installation instructions for details. This equipment connects to the telephone network through a standard USOC RJ-11C network interface jack.

The REN is used to determine the number of devices that may be connected to a telephone line. Excessive RENs on a telephone line may result in the devices not ringing in response to an incoming call. In most but not all areas, the sum of RENs should not exceed five (5.0). To be certain of the number of devices that may be connected to a line, as determined by the total RENs, contact the local telephone company. For products approved after July 23, 2001, the REN for this product is part of the product identifier that has the format US:AAAEQ##TXXXX. The digits represented by ## are the REN without a decimal point (e.g., 03 is a REN of 0.3). For earlier products, the REN is separately shown on the label.

If this equipment causes harm to the telephone network, the telephone company will notify you in advance that temporary discontinuance of service may be required. But if advance notice isn't practical, the telephone company will notify the customer as soon as possible. Also, you will be advised of your right to file a complaint with the FCC if you believe it is necessary.

The telephone company may make changes in its facilities, equipment, operations or procedures that could affect the operation of the equipment. If this happens the telephone company will provide advance notice in order for you to make necessary modifications to maintain uninterrupted service.

If trouble is experienced with this equipment, or for repair or warranty information, please contact Sharp's Customer Assistance Center. The number is 1-877-794-8675. If the equipment is causing harm to the telephone network, the telephone company may request that you disconnect the equipment until the problem is resolved.

This equipment may not be used on coin service provided by the telephone company. Connection to party line service is subject to state tariffs. Contact the state public utility commission, public service commission or corporation commission for information.

If your home has specially wired alarm equipment connected to the telephone line, ensure the installation of this equipment ID does not disable your alarm equipment. If you have questions about what will disable alarm equipment, consult your telephone company or a qualified installer.

This equipment is hearing-aid compatible.

When programming and/or making test calls to emergency numbers:

- ◆ Remain on the line and briefly explain to the dispatcher the reason for the call.
- ◆ Perform such activities in the off-peak hours, such as early morning or late evening.

# S H A R P

Date Revised: \_\_\_\_\_

Date Issued : July. 3. 2001

## MATERIAL SAFETY DATA SHEET (1/2)

MSDS No. B-1026

### Section 1. Product and Company Identification

**Product Name :** IMAGING FILM UX-5CR

**Supplier Identification :** Sharp Corporation

22-22 Nagaïke-cho, Abeno-ku, Osaka, Japan

**Manufacturer :** DAINIPPON PRINTING CO. LTD.

591-2, Kamihirose, Higashikubo, Sayamashi, Saitama, 350-1321 JAPAN

**Emergency telephone number :** +81-42-952-9666

Local suppliers are listed below. Please contact the nearest supplier for additional information.

(Country)	(Name and Telephone Number)
U.S.A.	Sharp Electronics Corporation Telephone number for information: 1-800-237-4277
Canada	Sharp Electronics of Canada Ltd. Telephone number for information : 905-890-2100 Emergency telephone number : 1-800-255-3924

### Section 2. Ingredients

<u>Ingredients</u>	<u>CAS No.</u>	<u>Proportion</u>	<u>OSHA PEL</u>	<u>ACGIH TLV</u>	<u>Other</u>
Polyethylene terephthalate film	25038-59-9	47 ~ 52%	-	-	None
<b>Coating layer substances</b>					
Carbon Black	1333-86-4	7 ~ 10%	3.5 mg/m <sup>3</sup>	3.5 mg/m <sup>3</sup>	None
Ester wax	8015-86-9	2 ~ 7%	-	-	None
Parraffin Wax	8002-74-2	10 ~ 14%	-	2.0 mg/m <sup>3</sup>	None
Microcrystalline wax	63231-60-7	16 ~ 22%	-	-	None
Ethylene Vinyl Acetate Copolymer	24937-78-8	1 ~ 5%	-	-	None
Others		1 ~ 6%	-	-	None

### Section 3. Hazardous Identification

**Route(s) of Entry:** Inhalation? NO Skin? NO Ingestion? Possible but very unusual

**Signs and Symptoms of Exposure:** None

**Medical Conditions Aggravated by Exposure:** None

#### POTENTIAL HEALTH EFFECTS:

**Inhalation:** None

**Skin Contact:** None

**Eye Contact:** None

**Ingestion:** None

### Section 4. First-Aid Measures

**Inhalation:** No applicable

**Skin Contact:** In case of contact, usually special care is not necessary. If it dirties skin, clear with water and soap.

**Eye Contact:** In case of contact, immediately flush eyes with plenty of water. If necessary, then care for medical attention.

**Ingestion:** Immediately make vomit it and rinse mouth with water. If necessary, then care for medical attention.

### Section 5. Fire-Fighting Measures

**Flash Point:** about 250°C for ink

**Autoignition:** None

**Flammability Limits:** Not applicable

**Extinguishing Media:** CO<sub>2</sub>, Water, Dry chemicals, Foam

**Firefighting:** None

**Fire and Explosion Hazard:** None

**Hazardous Combustion Products:** None

# S H A R P

Date Revised: \_\_\_\_\_

Date Issued : July. 3. 2001

## MATERIAL SAFETY DATA SHEET (2/2)

MSDS No. B-1026

### Section 6. Accidental Release Measures

Rumpling the product may cause the wax layer to peel off. Sweep up or vacuum. When sweeping, avoid raising film or dust. If a vacuum is used, motor should be rated as dust tight. Wash any residue off skin with soap and water. Garments may be washed or dry cleaned after removal of loose film or dust.

### Section 7. Handling and Storage

No special precautions for safety reason.  
Store in cool, dry place, avoid direct sunlight.

### Section 8. Exposure Control/Personal Protection

**Ventilation:** None  
**Eye Protection:** None  
**Protective Clothing:** None  
**Gloves:** None

### Section 9. Physical and Chemical Properties

**Description:** Not applicable  
**Melting Point:** 71°C  
**Pressurized:** None  
**pH:** None  
**Evaporation Rate:** Negligible  
**Volatility:** None  
**Freezing Point:** None  
**Boiling Point:** None  
**Specific Gravity (H2O = 1):** about 1.2  
**Water Solubility:** Not applicable

### Section 10. Stability and Reactivity

**Stability:** Stable  
**Conditions to Avoid:** None  
**Incompatibility (Materials to Avoid):** None  
**Hazardous Decomposition or Byproducts:** CO, CO<sub>2</sub>, NO<sub>x</sub> and H<sub>2</sub>O  
**Hazardous Polymerization:** Will not occur

### Section 11. Toxicological Information

**Acute Toxicity:** None  
**Chronic Toxicity:** None

### Section 12. Ecological Information

No environmental effect at normal use.

### Section 13. Disposal Consideration

Dispose by the same method of ordinary plastic products in accordance with all applicable regulations. Any disposal practice must be in compliance with local, state and federal laws and regulations. If necessary, contact government office and ensure conformity with disposal regulations.

### Section 14. Transport Information

No specific precautionary transport measure for safety reasons.  
As to storage conditions, see section 7.

### Section 15. Regulatory Information

None

### Section 16. Other Information

The information herein is given in good faith, but no warranty, if used any process.  
Final determination of suitability of any material is the sole responsibility of the user.  
Although certain information are described herein, we cannot guarantee, that these are the only hazard, which exist.  
Information on this data sheet represents our current data and best opinion as to the proper use in handling of this product under normal conditions.  
**Restrictions:** This information relates only to the specific material designated as supplied by the manufacturer. This information is supplied to us by the manufacturer and Sharp offers no warranties as to its accuracy and accepts no responsibilities for any typographical errors which may appear on these sheets. It is the responsibility of the user to determine the suitability of this product for each particular use.

# Quick Reference Guide

## Sending Faxes

Place your document (up to 10 pages) face down in the document feeder.

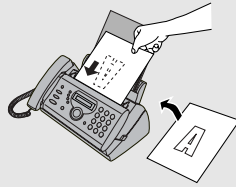

### Normal Dialling

1. Lift the handset or press **SPEAKER**.
2. Dial the fax number.
3. Wait for the reception tone (if a person answers, ask them to press their Start key).

4. Press **START/MEMORY**.

### Speed Dialling

1. Press **SPEED**.
2. Enter the 2-digit Speed Dial number.

3. Press **START/MEMORY**.

### Search Dialling

1. Press **▶** or **◀** until the name of the other party appears in the display (if no name was stored, the number will appear).

2. Press **START/MEMORY**.

## Receiving Faxes

Press **RESOLUTION/RECEPTION MODE** until the arrow in the display points to the desired reception mode.

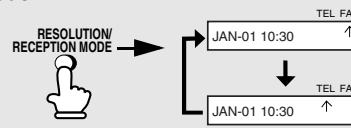

**FAX mode:** The fax machine automatically answers and receives the incoming document.

**TEL mode:** Answer all calls (even faxes) by picking up the handset. To begin fax reception, press **START/MEMORY**.

## Storing Auto Dial Numbers

1. Press **FUNCTION** once and **▶** once.

2. Enter a 2-digit Speed Dial number (01 to 30).

3. Enter the fax number and press **START/MEMORY**.

4. Enter a name by pressing number keys. (To enter two letters in succession that require the same key, press **▶** after entering the first letter.)

SPACE = 1	G = 4	N = 6 6	U = 8 8
A = 2	H = 4 4	O = 6 6 6	V = 8 8 8
B = 2 2	I = 4 4 4	P = 7	W = 9
C = 2 2 2	J = 5	Q = 7 7	X = 9 9
D = 3	K = 5 5	R = 7 7 7	Y = 9 9 9
E = 3 3	L = 5 5 5	S = 7 7 7 7	Z = 9 9 9 9
F = 3 3 3	M = 6	T = 8	

5. Press **START/MEMORY** and then **STOP**.

# Guía de referencia rápida

## Transmisión de documentos

Coloque el documento (hasta 10 páginas) mirando hacia abajo en el alimentador.

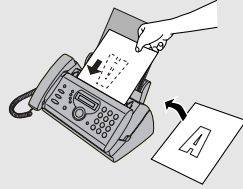

### Marcación normal

1. Levante el auricular o pulse **SPEAKER**.
2. Marque el número de telefax.
3. Espere a escuchar el tono de recepción (si alguien contesta el teléfono, pídale que pulse su tecla Inicio).

4. Pulse **START/MEMORY**.

### Marcación abreviada

1. Pulse **SPEED**.
2. Introduzca el número de 2 dígitos de marcación abreviada.
3. Pulse **START/MEMORY**.

### Marcación por búsqueda

1. Oprima la tecla de flecha **▶** o **◀** hasta que en el visor aparezca el destino deseado.
2. Pulse **START/MEMORY**.

## Recepción de documentos

Pulse **RESOLUTION/RECEPTION MODE** hasta que la flecha del display señale el modo de recepción deseado.

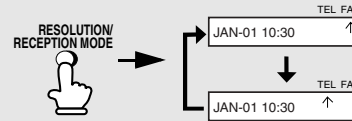

**Modo FAX:** El aparato de telefax contestará y recibirá documentos automáticamente.

**Modo TEL:** Contesta todas las llamadas (incluso las de telefax) levantando el auricular. Para que comience la recepción del documento, pulse **START/MEMORY**.

## Programación de números de marcación automática

1. Pulse **FUNCTION** una vez y **▶** una vez.
2. Introduzca un número de 2 dígitos de Marcación abreviada (01 a 30).
3. Introduzca el número de telefax y pulse **START/MEMORY**.
4. Introduzca un nombre pulsando las teclas numéricas. (Para introducir dos letras sucesivas que requieran la misma tecla, pulse **▶** después de introducir la primera letra).

SPACE = 0	G = 4	N = 6 6	U = 8 8
A = 2	H = 4 4	O = 6 6 6	V = 8 8 8
B = 2 2	I = 4 4 4	P = 7	W = 9
C = 2 2 2	J = 5	Q = 7 7	X = 9 9
D = 3	K = 5 5	R = 7 7 7	Y = 9 9 9
E = 3 3	L = 5 5 5	S = 7 7 7 7	Z = 9 9 9 9
F = 3 3 3	M = 6	T = 8	

5. Pulse **START/MEMORY** y, a continuación, **STOP**.



---

## ***Index***

### **A**

Anti Junk Fax, 56  
Audible signals, 70  
Auto-dial numbers  
    Storing, 29  
    Using, 33, 34

### **C**

Caller ID, 49-53  
Caller ID List, 58  
Contrast, 26  
Copies, 47  
Copy cut-off setting, 48

### **D**

Date, setting, 18  
Daylight Saving Time, 19  
Dial mode, 10  
Dialing  
    Direct Keypad, 35  
    Normal, 27  
    Search, 34  
    Speed, 33  
Direct Keypad Dialing, 35  
Display messages, 68  
Distinctive ring, 54  
Document feeder, 24  
Document guides, 24  
Document restrictions, 24  
Document sizes, 23  
Document, maximum scanning size, 23

### **E**

Extension telephone  
    Using, 43

### **F**

FAX reception mode, 20, 40  
Fax Signal Receive, 44

### **H**

Halftone setting, 25  
Handset, 9  
Handset receiver volume, 22  
Hold, 43  
Housing, cleaning, 63

### **I**

Imaging film, replacing, 12

### **J**

Jams, clearing, 71-72

### **L**

Letters, entering, 17, 30  
Line error, 64  
Loading paper, 14  
Loading the document, 24

### **M**

Memory transmission, 38  
Memory, substitute reception to, 46

### **N**

Normal Dialing, 27  
Number of rings in FAX reception mode,  
    40

### **O**

Ordering parts, 73

### **P**

Paper jams, clearing, 71-72  
Paper size setting, 15  
Paper, loading, 14  
Polling, 57  
Power cord, 9  
Print contrast setting, 15

## Index

Print head, cleaning, 61-62  
Priority Call, 52

## R

Reception mode  
    FAX mode, 20, 40  
    TEL mode, 20, 41  
Reception Ratio setting, 45  
Redialing, 36  
Resolution, 25  
Ringer volume, 22

## S

Scanning glass, cleaning, 62  
Search Dialing, 34

Sender's name and number, entering,  
    16-17

Setup List, 58  
Speaker volume, 21  
Speed Dialing, 33

## T

TEL reception mode, 20, 41  
TEL. LINE. jack, 10  
Telephone line cord, 10  
Telephone Number List, 58  
Time, setting, 18  
Transaction Report, 59  
    Setting print condition, 60

## LIMITED WARRANTY

SHARP ELECTRONICS CORPORATION warrants to the first end user purchaser that this Sharp brand product (the "Product"), when shipped in its original container, will be free from defective workmanship and materials, and agrees that it will, at its option, either repair the defect or replace the defective Product or part thereof with a new or remanufactured equivalent at no charge to the purchaser for parts or labor for the period(s) set forth below.

This warranty does not apply to any appearance items of the Product nor to the additional excluded item(s) set forth below nor to any product the exterior of which has been damaged or defaced, which has been subjected to misuse, abnormal service or handling, or which has been altered or modified in design or construction.

In order to enforce the rights under this limited warranty, the purchaser should follow the steps set forth below and provided proof of purchase to the servicer.

To the extent permitted by applicable state law, the warranties set forth herein are in lieu of, and exclusive of, all other warranties, express or implied. Specifically, ALL OTHER WARRANTIES OTHER THAN THOSE SET FORTH ABOVE ARE EXCLUDED. ALL EXPRESS AND IMPLIED WARRANTIES INCLUDING THE WARRANTIES OF MERCHANTABILITY, FITNESS FOR USE, AND FITNESS FOR A PARTICULAR PURPOSE ARE SPECIFICALLY EXCLUDED. If, under applicable state law, implied warranties may not validly be disclaimed or excluded, the duration of such implied warranties is limited to the period(s) from the date of purchase set forth below.

Neither the sales personnel of the seller nor any other person is authorized to make any warranties other than those described above, or to extend the duration of any warranties beyond the time period described above on behalf of Sharp.

The warranties described herein shall be the sole and exclusive warranties granted by Sharp and shall be the sole and exclusive remedy available to the purchaser. Correction of defects, in the manner and for the period of time described herein, shall constitute complete fulfillment of all liabilities and responsibilities of Sharp to the purchaser with respect to the Product, and shall constitute full satisfaction of all claims, whether based on contract, negligence, strict liability or otherwise. In no event shall Sharp be liable, or in any way responsible, for any damages or defects in the Product which were caused by repairs or attempted repairs performed by anyone other than an authorized servicer. Nor shall Sharp be liable or in any way responsible for any incidental or consequential economic or property damage. Some states do not allow limits on warranties or on remedies for breach in certain transactions; in such state the limits herein may not apply.

<u>Your Product:</u>	Personal Facsimile
<u>Warranty Period for this Product:</u>	Ninety (90) days parts and labor from date of purchase.
<u>Additional items excluded from warranty coverage:</u>	Any consumable items such as paper supplied with the Product.
<u>Where to obtain service:</u>	At a Sharp Authorized Servicer located in the United States. To find out the location of the nearest Sharp Authorized Servicer, call Sharp toll free at 1-800-BE-SHARP.
<u>What to do to obtain service:</u>	Ship (prepaid) or carry in your Product to a Sharp Authorized Servicer. Be sure to have proof of purchase available. If you ship or mail the Product, be sure it is packaged carefully.

For product information or customer assistance, please visit <http://www.sharpusa.com> on the World Wide Web or call **1-800-BE SHARP**.

**SHARP ELECTRONICS CORPORATION**  
Sharp Plaza,  
Mahwah, New Jersey 07430-1163

**SHARP®**

**SHARP ELECTRONICS CORPORATION**

**Sharp Plaza, Mahwah, New Jersey 07430-1163**

**SHARP CORPORATION**

PRINTED IN THAILAND  
(TINSE4463XHTZ)