

MODEL TI150

**S H A R P E R I M A G E™**

**Wrinkle-Free Steamer**

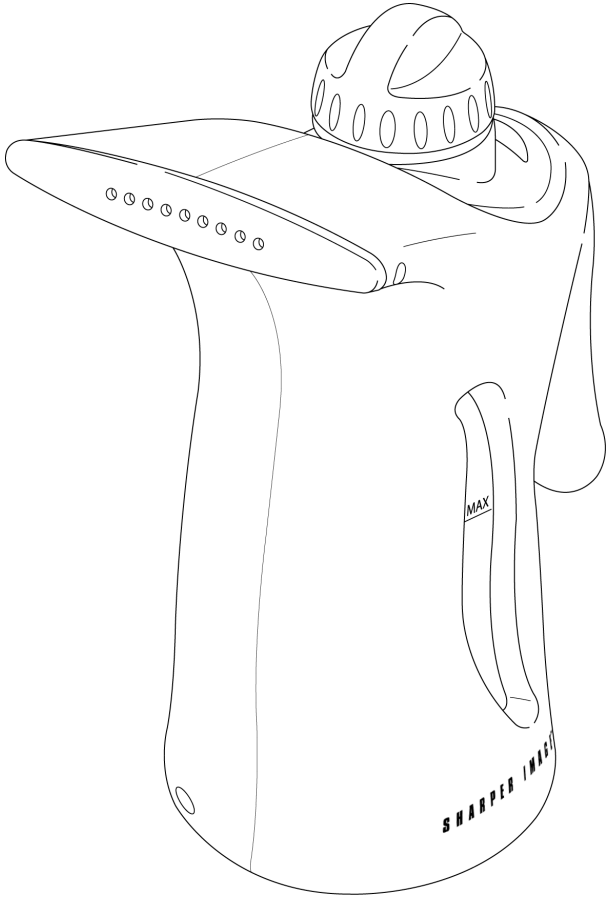

**S H A R P E R I M A G E™**

350 The Embarcadero, Sixth Floor  
San Francisco, CA 94105-1218  
Tel: 1-800-344-4444  
[www.sharperimage.com](http://www.sharperimage.com)



**Please read all instructions before use.**

*Dear Sharper Image Customer,*

*Thank you for your purchase of a Sharper Image product. We appreciate your business very much.*

*Our goal is that you will be completely satisfied with this product's quality and performance. We offer generous return privileges and excellent warranties on all our products.*

*Since 1977, The Sharper Image has shared the fun of discovering innovative products that make life better and more enjoyable. We've been in business a long time because we are an exciting place to shop and — just as importantly — we strive to deliver outstanding customer service that exceeds your expectations.*

*Enjoy your purchase!*

---

*Call 1-800-344-4444 for ordering and customer service, or visit **www.sharperimage.com**, our award-winning Website.*

PROBLEM	POSSIBLE CAUSE	SOLUTION
Unit fails to heat up.	Unit is not plugged in.	Plug into electrical outlet.
	Household Circuit Breaker / Ground Fault Interrupter has tripped or blown a fuse.	Reset Circuit Breaker / Ground Fault Interrupter, or replace fuse. If you need assistance, contact a licensed electrician.
Unit heats up, but fails to steam.	Water Reservoir is empty.	Refill Water Reservoir using procedures on page 7 of this manual.
	Mineral build-up in unit.	Follow <b>Removing Mineral Build-Up</b> procedure on page 9 of this manual.
Steam output is intermittent.	Mineral build-up in unit.	It is normal for unit to periodically stop steaming for a few seconds. If steam stays off for longer periods, follow <b>Removing Mineral Build-Up</b> procedure on page 9 of this manual.



**WARNING:** To reduce the risk of fire, electrical shock, or injury, the following basic safety precautions should always be followed when using an electrical appliance.

### READ ALL INSTRUCTIONS BEFORE USING YOUR FABRIC STEAMER

- DO NOT overfill unit with water.** Fill to MAX mark only (7 oz.). Overfilling may result in burns from spilling water, or possible electrical shock.
- DO NOT leave your TI150 Wrinkle-Free Steamer unattended when plugged in or not in use. Use only for its intended purpose as indicated in this manual.
-  **This unit is not a toy. Close supervision is required when using unit near children, pets, and plants. Steam produced by unit is hot and pressurized. Care must be taken to avoid burns or other injuries. Never point nozzle at people or pets.**
- To reduce the risk of contact with hot water emitting from steam vents, hold appliance away from body and check for signs of condensation or leakage.
- DO NOT use this unit if electrical cord or outlet is damaged. DO NOT use unit if it is not working properly or has been dropped, damaged or left outdoors. If such damage occurs, DO NOT disassemble or attempt repairs, take unit to a qualified service person for examination and repair. Incorrect reassembly or repair could cause a risk of fire, electrical shock, or injury to persons when steamer is used.
- To reduce risk of electrical shock, DO NOT immerse in water or other liquids. DO NOT use electrical cord as a handle. DO NOT allow cord to be crimped by closing it in doors. DO NOT pull or stretch cord around sharp corners or edges.
- Do not allow cord to touch hot surfaces. Let appliance cool completely before putting away. Loop cord loosely around appliance when storing.
- DO NOT use this unit with extension cords or electrical outlets that have inadequate current capacity. A three-prong outlet or a properly grounded adapter is necessary when using TI150 Wrinkle-Free Steamer.

**SAVE THESE INSTRUCTIONS!**  
FOR HOUSEHOLD USE ONLY

**IMPORTANT SAFEGUARDS**

**WARNING:** To reduce the risk of electrical shock, this appliance has a three-pronged plug. This plug will fit in a polarized wall outlet only one way. If the plug does not fit fully in the outlet, contact a licensed electrician to install a proper outlet. **DO NOT** attempt to modify the plug or defeat this safety feature.

9. In order to unplug TI150 Wrinkle-Free Steamer, grasp plug and pull smoothly and firmly from outlet. **DO NOT** attempt to unplug unit by pulling or tugging on cord.
10. Use care when using TI150 Wrinkle-Free Steamer at an angle. Tilting unit more than 35 degrees in any direction may cause excess water to spray out of steam nozzle.
11. Burns could occur from touching hot metal parts, hot water or steam. Use care when you turn a steam appliance upside down - there may be hot water in Water Reservoir.
12. TI150 Wrinkle-Free Steamer is only meant to be used with recommended TI150 accessories. Other types of attachments are not to be used with Wrinkle-Free Steamer. Doing so may cause injuries or damage to unit.
13. Nozzle and attachments become hot during use. To avoid injuries, **DO NOT** touch nozzle while using this appliance. **DO NOT** attempt to change attachments while unit is emitting steam.
14. When filling your Wrinkle-Free Steamer with water, **DO NOT** fill Water Reservoir with more than 7 oz. of water. Only water should be used in unit. Other cleaning agents will damage unit and can cause injuries.
15. Always disconnect appliance from electrical outlet when filling with water or emptying, and when not in use.
16. **DO NOT** operate unit if steam opening is blocked. Should this occur, immediately cease usage and unplug from electrical outlet.
17. Store your TI150 Wrinkle-Free Steamer in a cool, dry place.

**SAVE THESE INSTRUCTIONS!**  
FOR HOUSEHOLD USE ONLY

**CARE AND STORAGE GUIDELINES****PROPER STORAGE**

Preparing your Wrinkle-Free Steamer for storage is quick and simple. When you have finished your steaming tasks, follow the steps listed below.

1. Unplug grounded power cord from electrical outlet.
2. Allow unit to cool completely (at least 30 minutes).
3. Remove all attachments from unit.
4. Drain any remaining water in Water Reservoir into a sink or tub to minimize potential mineral build-up. Loosely reattach Water Reservoir Cap. Do not tighten cap, as it may be difficult to remove the next time you use the unit.
5. Store all attachments, preferably near Wrinkle-Free Steamer.
6. Store Wrinkle-Free Steamer in a cool, dry location.

**REMOVING MINERAL BUILD-UP**

A common problem with steam appliances is mineral build-up caused by high mineral content in many municipal water supplies. **The best way to avoid this is to use de-mineralized or distilled water in unit.** If you are unable to use de-mineralized or distilled water, we recommend you use this procedure monthly to help avoid mineral build-up:

1. Unplug grounded power cord from electrical outlet and allow unit to completely cool.
2. Remove all attachments from unit.
3. Remove Water Reservoir Cap and drain water from Water Reservoir into sink or tub.
4. Using a measuring cup, make a mixture of 4 oz. vinegar and 4 oz. water.
5. Slowly pour water-vinegar solution into Water Reservoir.
6. Allow to stand for 40 minutes.
7. Drain water-vinegar solution from Water Reservoir.
8. Rinse Water Reservoir with fresh water, drain and repeat until vinegar odor dissipates.
9. Replace Water Reservoir Cap.

## STEAMING LINENS & FABRICS

**NOTE:** Be sure that Water Reservoir has already been filled before following these steps. Also be sure that Rubber Accessory Housing is connected along with the Fabric Brush or Lint Remover, to reduce excessive water spitting from the Steam Nozzle.

1. Plug grounded power cord into a convenient electrical outlet. Heater Indicator Light will immediately illuminate to indicate that unit is heating up.

**CAUTION:** This unit uses a grounded (3-prong) electrical plug. Use only in properly installed 3-prong electrical outlets. Do not attempt to alter plug or circumvent this safety feature in any way.

2. After approximately 2 minutes of heating time, unit will begin emitting steam.
3. Direct Steam Nozzle (and any attachments) towards material you wish to steam.

**CAUTION:** Always be sure that Steam Nozzle and any other attachments are pointed in a safe direction (away from yourself, other people, pets and plants) when steam is being emitted.

4. Keep the flow of steam focused on the material you are steaming. Using a slight back-and-forth motion over the area you are steaming will further enhance the process.

### Steaming Tips:

- Curtains and draperies can be steamed while still hanging.
- To remove wrinkles from towels, handkerchiefs and napkins, drape them over a rod or towel rack and gently steam them.
- Heavier fabrics may require repeated steaming to achieve desired results.
- To remove exceptionally stubborn wrinkles, steam both sides of fabric.
- Be especially careful when steaming delicate fabrics and those likely to be damaged by water spotting.

## STEAMING GARMENTS

1. Place garment on a clean, rust-free hanger.
2. Direct Steam Nozzle towards bottom of garment. Steam will rise along inside and outside of fabric, removing wrinkles. Slowly slide Steam Nozzle upward from bottom to top of garment.
3. Direct Steam Nozzle away from garment and smooth fabric with your free hand.
4. Repeat as necessary until garment is wrinkle-free.

When you are finished using the Wrinkle-Free Steamer, immediately unplug grounded power cord from electrical outlet. Refer to **Care and Storage Guidelines** on page 9 of this manual for proper cleaning and storage procedures.

The following features and accessories are included with your Fabric Steamer. Carefully inspect packaging material for all parts and accessories before discarding.

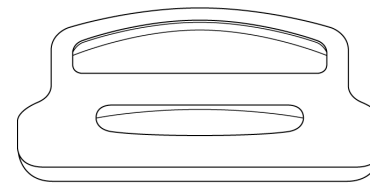
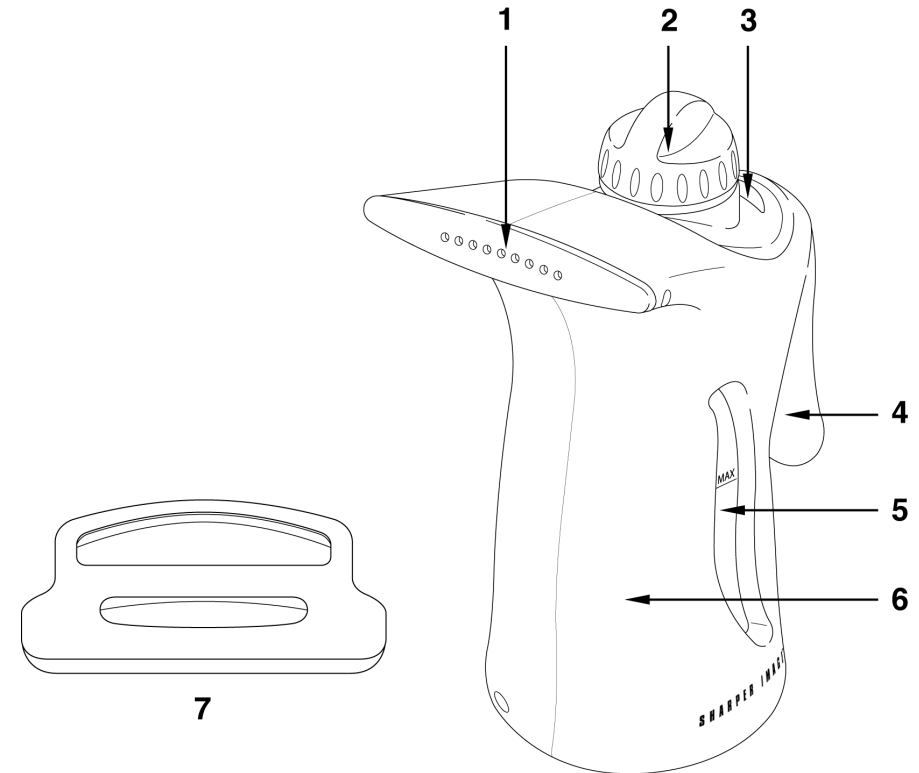

7

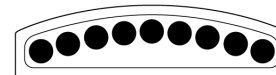

8



9

### UNIT FEATURES & ACCESSORIES

1. Steam Nozzle
2. Water Reservoir Cap
3. Heater Indicator Light
4. Handle
5. Reservoir Level Window
6. Water Reservoir
7. Rubber Accessory Housing
8. Fabric Brush
9. Lint Remover

## WRINKLE-FREE STEAMER PRODUCT INFORMATION

- The *Steam Nozzle* (1) emits a flow of hot, penetrating steam.
- The *Water Reservoir Cap* (2) safely contains steam within the *Water Reservoir*, and must be removed in order to fill the unit with water.
- The *Heater Indicator Light* (3) illuminates when the unit's heater is active.
- The *Handle* (4) is designed to stay relatively cool while providing the optimum amount of safety and user comfort.
- The *Reservoir Level Window* (5) lets the user clearly see how much water is in the *Water Reservoir*. It should not be filled above the MAX (7 oz.) fill line.
- The *Water Reservoir* (6) is the tank in which water is stored for use by the unit.
- The *Rubber Accessory Housing* (7) is used for connecting the *Lint Remover* and *Fabric Brush* to the *Steam Nozzle*. Connecting the *Rubber Accessory Housing* along with the *Fabric Brush* or *Lint Remover* is required and will reduce excessive water spitting from the *Steam Nozzle*.
- The *Fabric Brush* (8) fits into the *Rubber Accessory Housing* and delicately smooths wrinkles from fabrics.
- The *Lint Remover* (9) fits into the *Rubber Accessory Housing*, and is useful for removing lint and loose threads from fabrics.

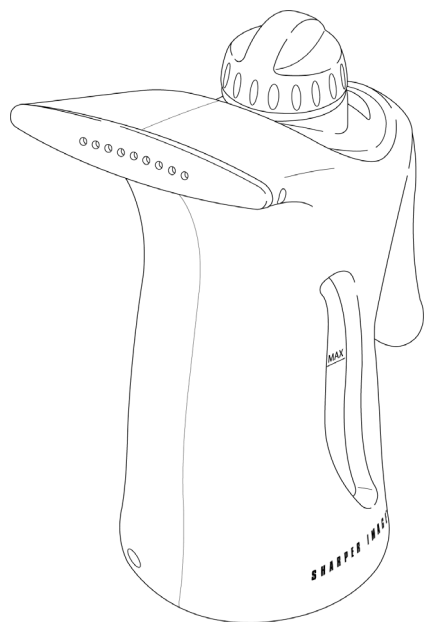

## USING THE WRINKLE-FREE STEAMER

### FILLING WATER RESERVOIR WITH WATER

1. Place Wrinkle-Free Steamer on a flat, level surface.
2. Make sure grounded power cord is unplugged from electrical outlet.
3. If unit has been in use, allow it to cool for at least 5 minutes.  
**WARNING: Always allow unit to cool before adding water. Cold water added to a hot boiler may cause hot water and steam to shoot out of fill hole.**
4. Cautiously unscrew and remove Water Reservoir Cap.
5. Carefully fill Water Reservoir with water from a faucet or cup. Pay attention to water level in Water Reservoir using Reservoir Level Window on side of unit, and fill up to the MAX (7 oz.) fill line.

**NOTE: To prolong the life of your Wrinkle-Free Steamer, we recommend using distilled or de-mineralized water.**

**WARNING: Extreme caution should be used when pouring water into the Water Reservoir. Do not look directly down into fill hole when filling. Keep your free hand and any children or pets at a safe distance.**

**NOTE: Do not exceed the MAX fill line. Too much water in the Water Reservoir may cause excess water spitting in steam.**

9. Replace Water Reservoir Cap, using care not to over-tighten it.

### ATTACHING ACCESSORIES

1. Choose either the Lint Remover or Fabric Brush and insert it into Rubber Accessory Housing as shown (FIGURE 1).
2. Slide Rubber Accessory Housing (with inserted accessory) onto Steam Nozzle as shown (FIGURE 2). Make sure that holes on Steam Nozzle are aligned with open slot on Rubber Accessory Housing so that steam is not blocked.

**NOTE: The steamer should only be used with these accessories attached to help reduce water spitting.**

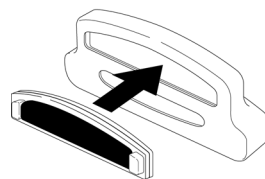

FIGURE 1

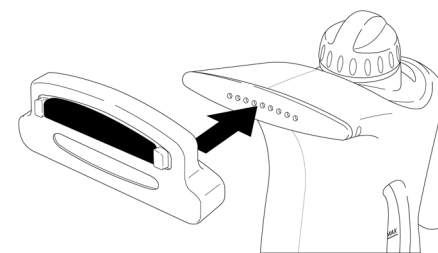

FIGURE 2