

# AMTC

## LCD TV



**MSAV3230Y-35531** (32" class/ 31.51 diagonal)

### INSTRUCTIONS

ENGLISH



Please read the important notice for energy efficiency on page 5.

#### ATTENTION

If you purchase a universal remote control from your local retailer, please contact the remote manufacturer for the required programming code.

#### AIR/CABLE MODE SELECTION

When shipped from the factory, the Signal Type option is set to the "Cable" (Cable Television) mode. If not using Cable TV, set this menu option to the "Air" position.

IF CONTACT WITH CUSTOMER SERVICE IS REQUIRED  
PLEASE HAVE THE MODEL NUMBER READY PRIOR TO THE CALL



**CUSTOMER SERVICE - 1-800-289-0984**

FOR RECYCLING INFORMATION, PLEASE CONTACT CUSTOMER SERVICE.

**CUSTOMER SERVICE -1-800-289-0984**

Before operating the unit, please read this manual thoroughly.



	<b>CAUTION</b> <b>RISK OF ELECTRIC SHOCK</b> <b>DO NOT OPEN!</b>	
<b>CAUTION:</b> TO REDUCE THE RISK OF ELECTRIC SHOCK, DO NOT REMOVE COVER (OR BACK). NO USER SERVICEABLE PARTS INSIDE. REFER SERVICING TO QUALIFIED SERVICE PERSONNEL.		



The lightning flash with arrowhead symbol, within an equilateral triangle is intended to alert the user to the presence of uninsulated dangerous voltage within the product's enclosure that may be of sufficient magnitude to constitute a risk of electric shock.



The exclamation point within an equilateral triangle is intended to alert the user to the presence of important operating and maintenance (servicing) instructions in the literature accompanying the appliance.

<p><b>WARNING:</b> TO PREVENT FIRE OR SHOCK HAZARD, DO NOT EXPOSE THIS APPLINACE TO RAIN OR MOISTURE. TO PREVENT THE SPREAD OF FIRE, KEEP CANDLES OR OPEN FLAMES AWAY FROM THIS PRODUCT AT TIMES.</p> <p><b>CAUTION:</b> TO PREVENT ELECTRIC SHOCK. DO NOT USE THIS POLARIZED PLUG WITH AN EXTENSION CORD, RECEPTACLE OR OTHER OUTLET UNLESS THE BLADES CAN BE FULLY INSERTED TO PREVENT BLADE EXPOSURE.</p>
--

**WARNING:** This equipment has been tested and found to comply with the limits for a Class B digital device, pursuant to Part 15 of the FCC Rules. These limits are designed to provide reasonable protection against harmful interference in a residential installation. This equipment generates, uses and can radiate radio frequency energy and, if not installed and used in accordance with the instructions, may cause harmful interference to radio communications. However, there is no guarantee that interference will not occur in a particular installation. If this equipment does cause harmful interference to radio or television reception, which can be determined by turning the equipment off and on, the user is encouraged to try to correct the interference by one or more of the following measures:

- Reorient or relocate the receiving antenna.
- Increase the separation between the equipment and receiver.
- Connect the equipment into an outlet on a circuit different from that to which the receiver is connected.
- Consult the dealer or an experienced radio/TV technician for help.

**CAUTION:** Changes or modifications not expressly approved by the party responsible for compliance with the FCC Rules could void the user's authority to operate this equipment.

**Location of the required marking**

The rating sheet and the safety caution are on the rear of the unit.

**BATTERY PRECAUTIONS:**

- Batteries should not be exposed to excessive heat such as sunshine, fire or the like.
- The remote control unit uses infrared beams to transmit signals, so sunlight or fluorescent light on the remote sensor may shorten operating distance.
- Incorrect use of batteries may cause them to leak or burst. Read the battery warnings and use the batteries properly.
- Do not mix old and new batteries.
- Do not mix alkaline, standard (carbon-zinc), or rechargeable, (Ni-Cd, Ni-MH, etc.) batteries.
- Remove batteries if the remote control will not be operated for an extended period of time.

**Important Note:**

In the spaces below, enter the model and serial number of your television (located at the rear of the television cabinet). Staple your sales receipt or invoice to the inside cover of this guide. Keep this user's guide in a convenient place for future reference. Keep the carton and original packaging for future use.

**Serial number:** \_\_\_\_\_

**Model number:** \_\_\_\_\_

**IMPORTANT SAFETY INSTRUCTION**

Important Safety Instructions

- 1) Read these instructions.
- 2) Keep these instructions.
- 3) Heed all warnings.
- 4) Follow all instructions.
- 5) Do not use this apparatus near water.
- 6) Clean only with dry cloth.
- 7) Do not block any ventilation openings, install in accordance with the instructions.
- 8) Do not install near any heat sources such as radiations, heat registers, stoves, or other apparatus (including amplifiers) that produce heat.
- 9) Do not defeat the safety purpose of the polarized plug. If the provided plug does not fit into your outlet, consult an electrician for replacement of the obsolete outlet.
- 10) Protected the power cord from being walked on or pinched particularly at plugs, convenience receptacles, and the point where they exit from the apparatus.
- 11) Only use attachments/accessories specified by the manufacturer.
- 12) Unplug this apparatus during lighting storms or when unused for long periods of time.
- 13) Refer all servicing to qualified service personnel. Servicing is required when the apparatus has been damaged in any way, such as power-supply cord or plug is damaged, liquid has been spilled or objects have fallen into the apparatus, the apparatus has been exposed to rain or moisture, does not operate normally, or has been dropped.
- 14) Mains plug is used as the disconnect device, the disconnect device shall remain readily operable.
- 15) The ventilation should not be impeded by covering the ventilation openings with items, such as newspapers, table-cloth, curtains, etc.
- 16) No naked flame sources, such as lighted candles, should be placed on the apparatus.
- 17) Attention should be drawn to the environmental aspects of battery disposal.
- 18) The use of apparatus in moderate climate.
- 19) The apparatus shall not be exposed to dripping or splashing and that no objects filled with liquids, such as vases, shall be placed on the apparatus.
- 20) Use only with a cart , stand, tripod, bracket, or table specified by the manufacturer, or sold with the apparatus. When a cart is used, use caution when moving the cart/apparatus combination to avoid injury from tip-over.



The symbol indicates that dangerous voltages constituting a risk of electric shock are present within this unit.



The symbol indicates that there are important operating and maintenance instructions in the literature accompanying this unit.

**WARNING:**  
To reduce the risk of fire or electric shock, do not expose this apparatus to rain or moisture.

**WARNING:**  
The batteries shall not be exposed to excessive heat such as sunshine, fire or the like.

**WARNING:**  
The excessive sound pressure from earphones and headphones can cause hearing loss.



This symbol indicates that this product incorporates double insulation between hazardous mains voltage and user accessible parts. When servicing use only identical replacement parts.



This marking indicates that this product should not be disposed with other household wastes throughout the EU. To prevent possible harm to the environment or human health from uncontrolled waste disposal, recycle it responsibly to promote the sustainable reuse of material resources. To return your used device, please use the return and collection systems or contact the retailer where the product was purchased. They can take this product for environmental safe recycling.

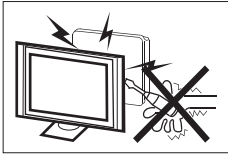

High voltages are used in the operation of this television receiver. Do not remove the cabinet back from your set. Refer servicing to qualified service personnel.

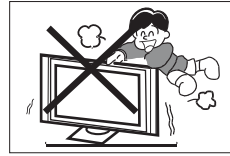

Never stand on, lean on, or suddenly push the television or its stand. You should pay special attention to children. Serious injury may result if it falls.

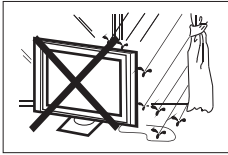

To prevent fire or electrical shock hazard, do not expose the television receiver to rain or moisture.

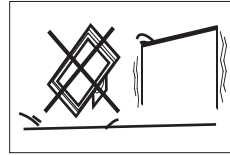

Do not place your television on an unstable cart, stand, shelf or table. Serious injury to an individual, and damage to the television, may result if it falls.

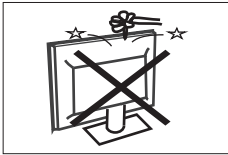

Do not drop or push objects into the television cabinet slots or openings. Never spill any kind of liquid on the television receiver.

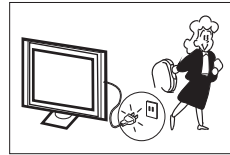

When the television receiver is not used for an extended period of time, it is advisable to disconnect the AC power cord from the AC outlet.



Do not block the ventilation holes in the back cover. Adequate ventilation is essential to prevent failure of electrical components.

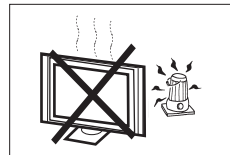

Avoid exposing the television receiver to direct sunlight and other sources of heat. Do not stand the television receiver directly on other products which give off heat, e.g. video cassette players and audio amplifiers. Do not place naked flame sources, such as lighted candles on the television.

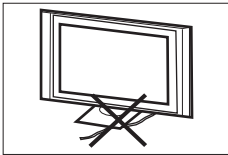

Do not trap the power supply cord under the television receiver.

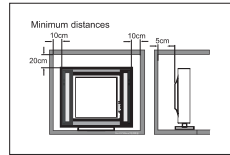

If the television is to be built into a compartment or similar enclosure, the minimum distances must be maintained. Heat build-up can reduce the service life of your television, and can also be dangerous.

# Contents

Safety and warnings.....	1-3
Introduction.....	5
Installation.....	6-9
Wall Mount.....	10
Remote Control.....	11-12
Operation.....	13-16
Trouble Shooting.....	17

**Main features**

- 32" wide screen for a complete home theater experience
- Super slim LCD TV with LED backlight
- 1366 x 768 native resolution for HD performance
- Integrated ATSC TV tuner for HDTV broadcast reception
- Beautiful color depth with a dynamic contrast ratio of 1200:1
- Triple HDMI® inputs for true digital connections
- VGA port for connection to PC

**Accessories**

Power Cable.....	1
Infrared Remote Control.....	1
User's Manual .....	1
Battery(AAA).....	2
Screws.....	4
Base stand.....	2
AV adapter cable.....	1

**Specifications**

Viewing Picture Size(diagonal)	31.51 inches
Resolution:	1366x768
Aspect Ratio:	16:9
TV System:	ATSC Digital system and NTSC Analog system
Video Signal System:	NTSC/PAL
Receiving Channel:	Cable :1-135/ Air: 2-69(ATV&DTV)
Maximum Power Consumption:	45W
Input Power Voltage:	AC 100-240V 50/60Hz
Audio Output Power(THD ≤ 7%):	2 x 8W
High-Definition Multimedia Interface(HDMI) Input	x 3
YCb(Pb)Cr(Pr) Input	x 1
Composite Video Input	x 1
Analog RGB(VGA) Input	x 1
Audio Input	x 1
Headphone Output	x 1
Optical Output	x 1
USB Input	x 1
AV Out	x 1
Dimensions (approx) with stand fitted(W.H.D)	732 x 200 x 472 mm 28.8 x 7.9 x 18.6 inch
Net weight	5.0kg (11 lbs) with STAND
Horizontal definition(TV line)	Composite Video Input ≥350 Component (YPbPr) Video Input ≥400 Others (HDMI1,HDMI2,VGA) ≥400



The terms HDMI and HDMI High-Definition Multimedia Interface, and the HDMI Logo are trademarks or registered trademarks of HDMI Licensing LLC in the United States and other countries.

Manufactured under license from Dolby Laboratories. Dolby, Dolby Audio and the double-D symbol are trademarks of Dolby Laboratories.



Enabling certain features and functionality in this TV(Picture Mode "Personal/Vivid/Standard/Sports/Theater") may increase its energy consumption, possibly beyond the limits required for ENERGY STAR qualification.

**Front panel**

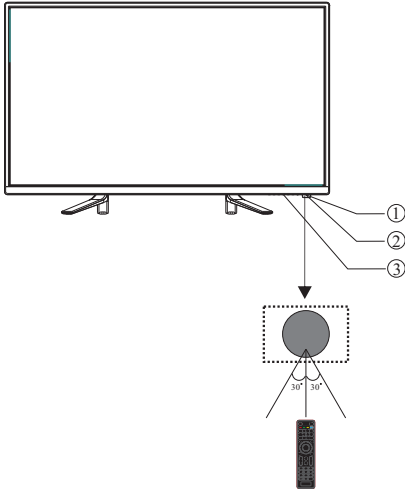

1. Remote control sensor.
2. Indicator LED:  
RED ● STAND BY.
3. Key board.

**Panel keys**

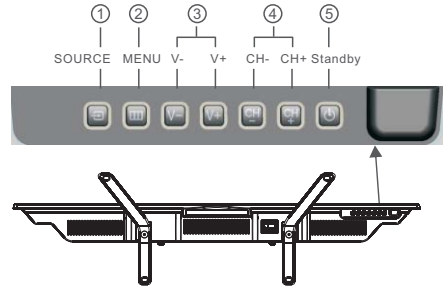

1. **SOURCE:**  
Display the input source menu. In MENU mode, press "SOURCE" to confirm the selected item.
2. **MENU:**  
Display main MENU.
3. **V+/V-**  
Adjust sound level.  
In MENU mode, press "V+" or "V-" to adjust the item that you selected.
4. **CH+/CH-**  
In TV mode, press "CH+" or "CH-" to change the channel up and down. In MENU mode, press "CH+" or "CH-" to select items.
5. **STANDBY**  
Press this button to turn the unit ON from STANDBY mode.  
Press it again to turn the set back to STANDBY.

**REAR Connections**



All the terminals are (from left to right):  
POWER SOCKET, HEADPHONE, OPTICAL, AUDIO INPUT,  
AV/YPbPr(COMPONENT)INPUT, HDMI3.

**SIDE Connections**



All the terminals are (from left to right):  
HDMI2(ARC), HDMI1, VGA, AV OUT, RF, USB.

Note: When HDMI has an input signal coming from a DVI source then the audio input signal must be connected to the PC audio input.

**Antenna**

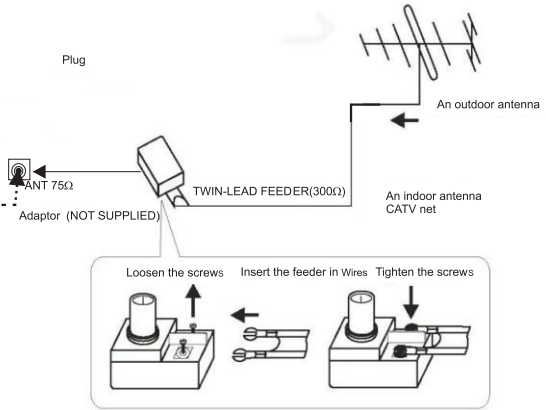
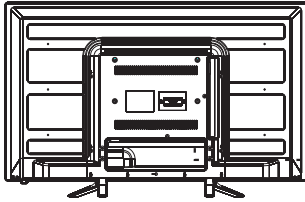

Note:  
Aerial connections: IEC (female).  
Input impedance: 75Ω unbalanced

**PC**

**STEPS:**

Be sure both the TV and computer are set to Power off.

1. Connect VGA and audio cable.
2. Connect the power cord.
3. Power on the TV, switch to PC mode.
4. Power on the PC.

This sequence is very important.

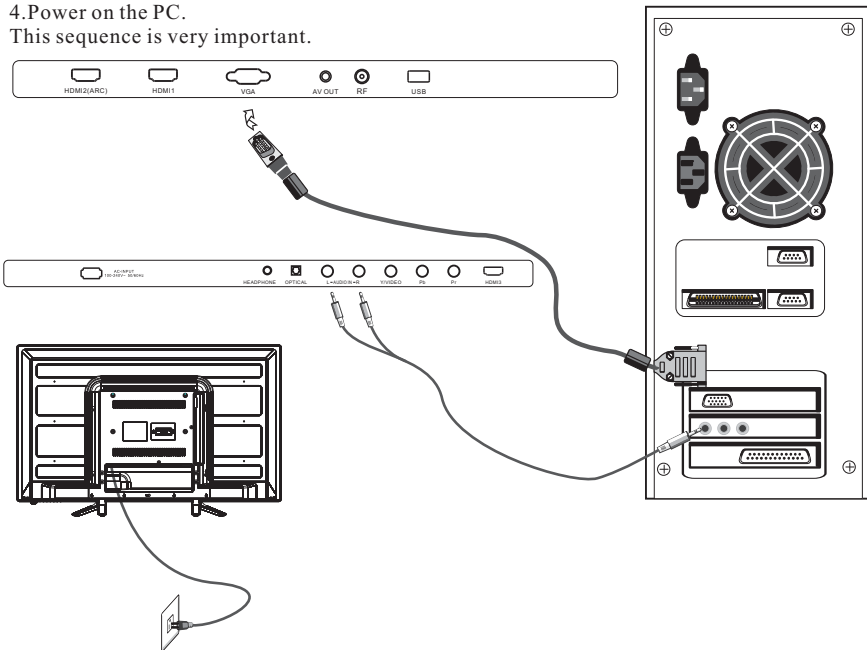



**Base Stand Assembly Instruction**

**the base stand**

Prepare to place the TV with the display side down on a flat surface. Due to the size and weight of this TV, the use of 2 people is recommended when moving it. Ensure the table or desk you use provides a flat, totally clean surface, and use a soft cloth between the face of the TV and the table to protect the TV's screen.

1. Locate the 2PCS of the base stand into the gap in the bottom of the TV , and check that it is securely held in place as per a) below.

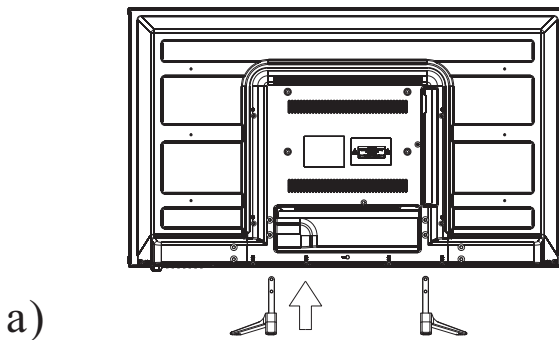

2. Lock 4PCS screws in the designated location as per b) below and check each screw is firmly tightened

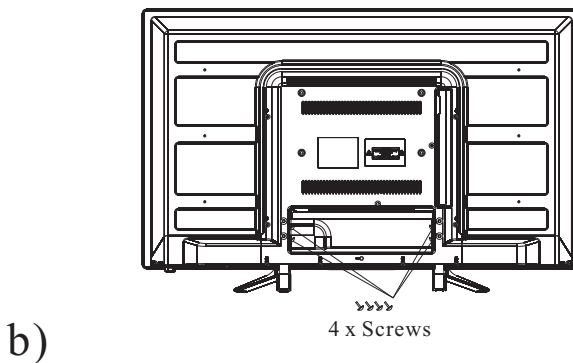

AV Equipment

You can use the input terminals on TV set rear as follows.

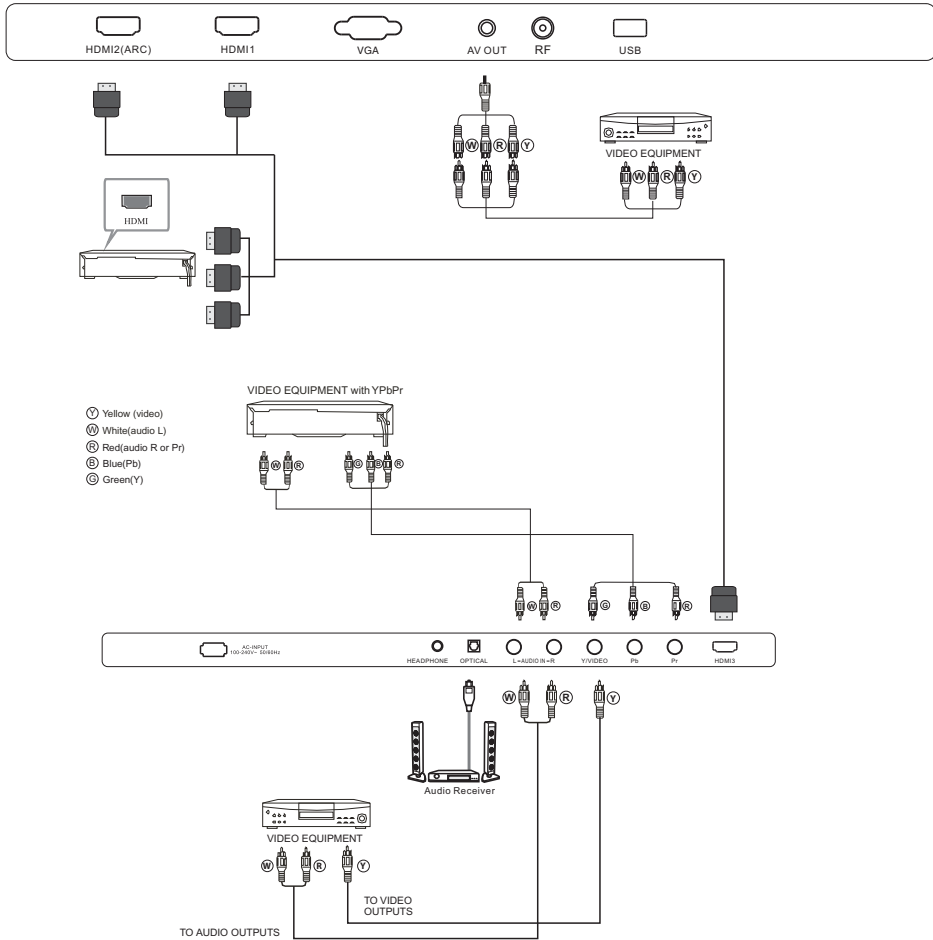

It can be connected to the following appliances: VCR, multi disc player, DVD, camcorder, video game or stereo system, etc.....

YPbPr can support these video formats:480i,576i,480p,576p,720p,1080i.

**Instruction for Wall Mount**

A wall mount kit (purchased separately) would allow you to mount your **JVC** TV on the wall. For detailed information on installing the wall mount, refer to the instructions provided by the wall mount manufacturer. It is strongly recommended to contact a technician for professional assistance for wall mount installation. **JVC** is not responsible for any damage to the product or injury to yourself or others resulting from the wall-mounting.

ENGLISH

**Dimensions for Mounting Hole Pattern**

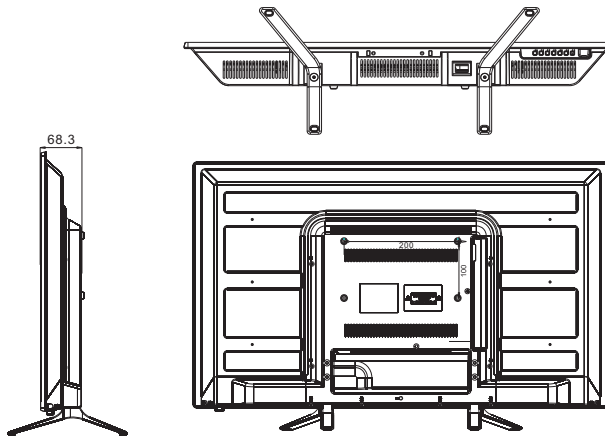

- This **JVC** TV is compatible with a 200mm x 100mm mounting hole pattern.
- 4 pcs of type **M4** screws are required for installing the wall mount bracket to your **JVC** TV. Do not use screws that are longer than 10 mm. Screws that are too long may cause damage to the inside of the TV set.
- Do not fasten the screws too tight for this may damage the TV or cause the TV to fall, resulting in personal injury. **JVC** is not liable for these kinds of incidents.
- Do not mount your **JVC** TV at more than a 15 degree tilt.
- Always use two people to mount the TV to a wall.
- Do not install your Wall Mount Kit while your TV is turned on. It may result in personal injury due to electric shock.

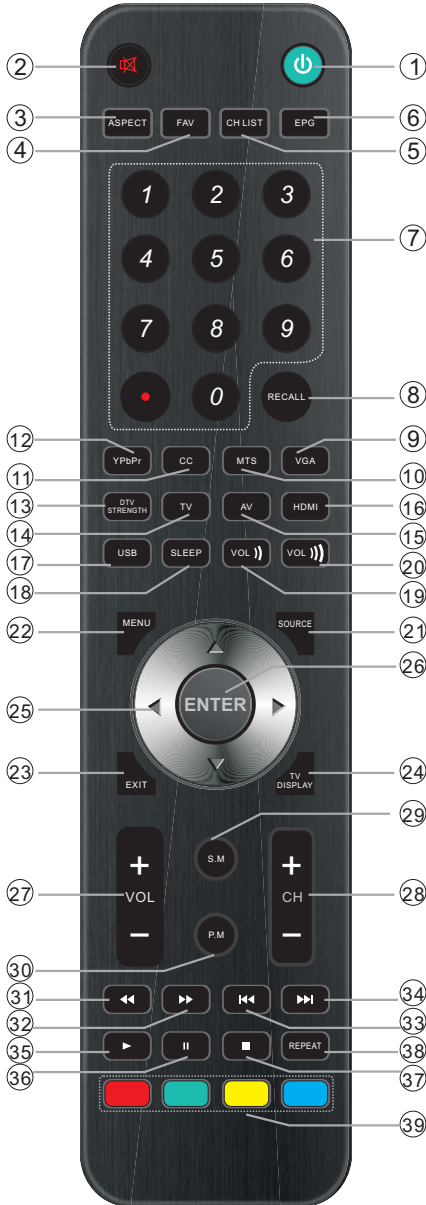

1. **POWER** To set the TV standby or on.
2. **MUTING** Press to disable or enable the sound output.
3. **ASPECT** To change picture aspect .
4. **FAV** Used to access your favourite channels in digital TV mode.
5. **CH LIST** Used to display the channel list.
6. **EPG** Display all the information of DTV programs.
7. **NUMBER KEY** For direct access to program.
8. **RECALL** To access the previously viewed program.
9. **VGA** Hot key directly go to VGA source.
10. **MTS** Switch the sound stereo.
11. **CC** Enable or disable the CC function.
12. **YPbPr** Hot key directly go to YPbPr source.
13. **DTV STRENGTH** Used to display the DTV signal strength menu.
14. **TV** Hot key directly go to TV source.
15. **AV** Hot key directly go to AV source.
16. **HDMI** Hot key directly go to HDMI source.
17. **USB** Press to launch the USB multimedia mode
18. **SLEEP** Press to display the sleep timer option.
19. **VOL**  Adjust volume to 50.
20. **VOL**  Adjust volume to 75.
21. **SOURCE** Press to display the Input Source List, to switch between the different inputs to the television.
22. **MENU** Press to display the TV main menu.
23. **EXIT** Used to exit menu.
24. **TV DISPLAY** Displays/removes the program Information.
25. **CURSOR** To move within the menu.
26. **ENTER** Confirms selection.

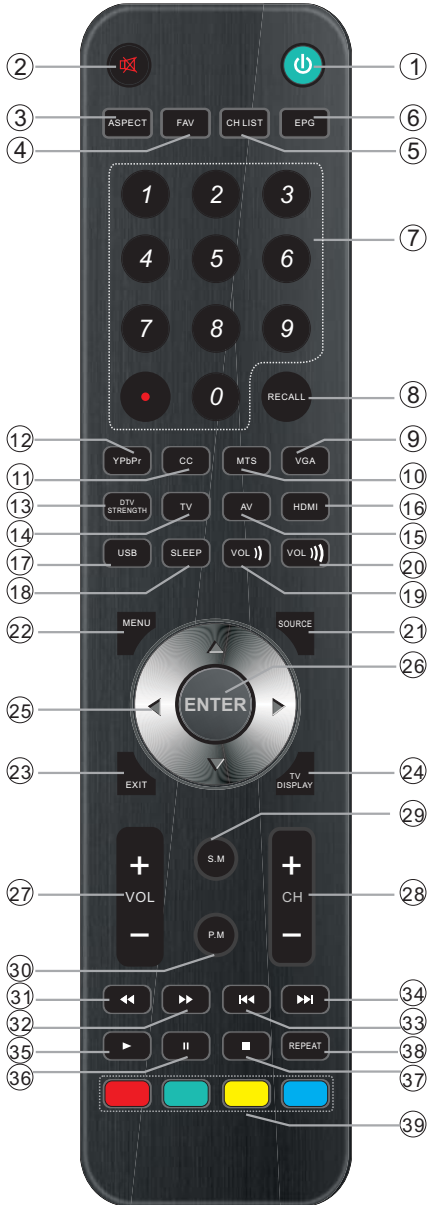

- 27. **VOL+/-**  
To adjust sound level.
- 28. **CH+/CH-**  
To access the next or previous Program.
- 29. **S.M**  
To switch sound mode.
- 30. **P.M**  
To switch picture mode.
- 31. **REWIND ◀◀**  
Reserved keys.
- 32. **FAST FORWARD ▶▶**  
Reserved keys.
- 33. **SKIP BACKWARD ◀◀**  
Press to skip the previous file or Track in USB Mode.
- 34. **SKIP FORWARD ▶▶**  
Press to skip the next file or track in USB Mode.
- 35. **PLAY ▶**  
Press the Play Button in USB Mode to begin or continue Playback.
- 36. **PAUSE ||**  
Press the Pause Button to pause play in USB Mode.
- 37. **STOP ■**  
Press to Stop play in USB Mode.
- 38. **REPEAT**  
Repeat play photo.
- 39. **COLOR KEYS**  
Reserved keys.

### 1. PICTURE MENU

In this menu, you can adjust the picture effect here, such as contrast, brightness, etc.  
Press ▼▲ to select, press ENTER to adjust.

\* Only under TV source, menu will show ⚙️, Under AV/Component/HDMI1/HDMI2/HDMI3/VGA/USB, menu will not show ⚙️.

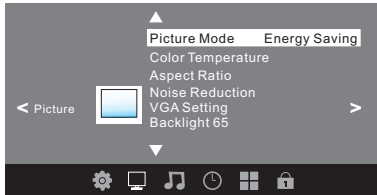

Note: The TV may not conform to the Energy Star standard after Picture Mode is changed except Energy Saving.

#### 1.1 VGA Setting

When PC Mode is available.

- Press ENTER button to select PC advanced setting
- 1) H-Pos: Adjust the horizontal position of the screen.
  - 2) V-Pos: Adjust the vertical position of the screen.
  - 3) Size: Fine tune the screen width.
  - 4) Phase: Fine tune the phase of the screen. Usually don't adjust this item.
  - 5) Auto: Auto adjust to fit the screen.

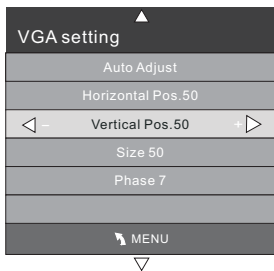

Note:

- 1) If you want to adjust contrast, brightness, color, and sharpness, the picture mode must return to personal status.
- 2) Tint is available in NTSC system only.
- 3) There are three color temperature modes can be selected: Normal, Warm and Cool.

### 2. AUDIO MENU

In this menu, you can adjust the sound effect here.  
Press ▼▲ to select, press ENTER to adjust.



Note:

- 1) There are five Sound Modes can be selected: Standard, Music, Movie, Sports and Personal
- 2) Audio language is available in ATSC/TV Programming only.
- 3) Auto volume is available only when the input signal volume is too large or there is distortion.

### 3. TIME MENU

In this menu, you can adjust the sleep timer, time zone, etc. Press ▼▲ to select, press ENTER to adjust.



Note:

- 1) Time zone, DST and the clock are available in ATSC programming only, and the Clock can't be adjust.

### 4. OPTION MENU

In this menu, you can adjust the Menu language, Close Caption, Restore Default etc.  
Press ▼▲ to select, press ENTER to adjust.

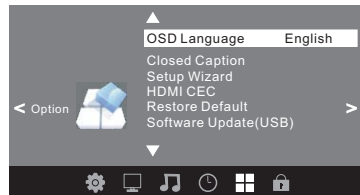

#### 4.1 Closed Caption

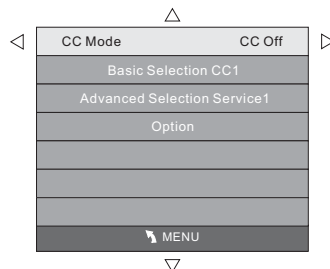

- 1) CC Mode: Switching close caption mode.
- 2) Advanced selection: only ATSC program is available.
- 3) Option: Used to edit CC font.

Note:

- 1) Restore Default: Restore Default will clear all the programs and reset all the settings to default value.

### 5.LOCK MENU

In this menu, you can change the password and adjust the V-chip setting.  
Enter the password, it will go into the lock menu.  
Factory default password is 0000.

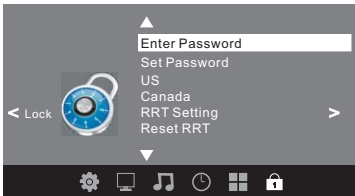

#### 5.1 Enter Password

When the System Lock switch is ON, the below options listed below can be adjusted.

#### 5.2 Set Password

- 1) Enter old password: Input the old password.
- 2) Enter new password: Input the new password.
- 3) Confirm password: Input the new password again.

#### 5.3 US

Press **ENTER** button the screen will display as follow.

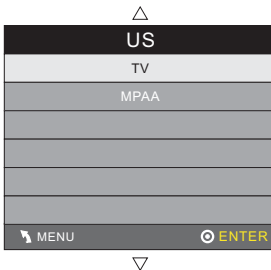

- 1) TV: Press **ENTER** button, the screen will display as follows:

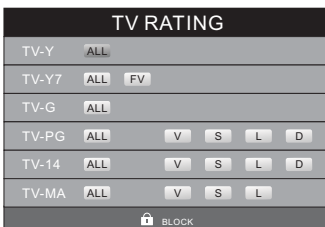

Rating	Content	Content				
		FV (Fantasy violence)	V (Violence)	S (Sexual situation)	L (Adult language)	D (Sexually suggestive dialog)
Suggested age	TV-Y (All children)					
	TV-Y7(Direct to order children)	X				
	TV-G(General audience)					
	TV-PG(Parental Guidance suggested)		X	X	X	X
	TV-14(Parents strongly cautioned)		X	X	X	X
TV-MA(Mature audience only)		X	X	X		

And use the **ENTER** key to switch lock/ unlock Parental Control feature.

- 2) MPAA: Switching the movie-rating control level; N/A, G, PG, PG-13, R, NC-17, X.

Rating	Description	
Age	G	General audiences, All Ages admitted
	PG	Parental Guidance suggested. Some material may not be Suitable for children.
	PG-13	Parents strongly cautioned. Some material .may be inappropriate for children under 13.
	R	Restrict. Under 17 requires accompanying parent or adult guardian(age varies in some jurisdictions)
	NC-17	No one 17 and under admitted.
X	X is an order rating that is unified with NC-17 but may be encoded in the data of order movies.	

#### 5.4 Canada

Press **ENTER** button, the screen will be displayed as follow:

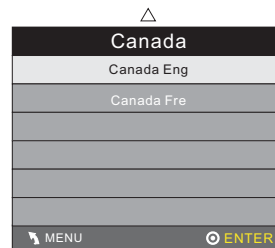

- 1) Canada English: Switching the English rating control level: C, C8+, G, PG, 14+, 18+.





## 7. Displaying JPEG files by using USB Port

You can display the JPEG files by using the USB port that is located on the rear panel:

7.1 Connect the USB DEVICE that contains the JPEG files.

7.2 Press **SOURCE** to enter inputsource menu.

7.3 In the inputsource menu, Press **▼▲◀▶** to select USB, and then press **ENTER**.

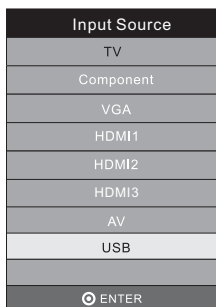

7.4 Press **▼▲◀▶** to select Photo, and then press enter









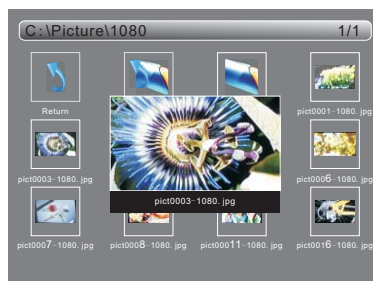









7.5 Press **▼▲◀▶** to select folder which contains JPEG picture .

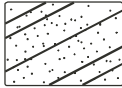

7.6 Press **ENTER** to display the picture in the folder.



Trouble phenomenon Symptom				Inspection Check
Picture		Audio		
 Snow		 Noise		antenna position, direction or connection
 Ghost		 Normal audio		antenna position, direction or connection
 Interference		 Noise		electronic equipment, car/ motorcycle, fluorescent light
 Normal Picture		 No Sound		Volume (check if muting function is activated or if the audio system connections are not correct)
 No picture		 No Sound		Power cord is not inserted Power switch is not opened Contrast and brightness/volume setup Press standby key on the remote control for inspecting
 No Color		 Normal audio		Color control
 Picture breaking up		 Normal audio or weak		retune channel
 No Color		 Noise		TV system

The LED TV panel is built with very high precision technology giving you fine picture details in vibrant color. Occasionally, a few non-active pixels may appear on the screen as a fixed point of red, green, blue, black or white. Please note this does not affect the performance of the product.

