



# LED TV

USER MANUAL  
MUA503 Y-34580

Please read this User Manual carefully to ensure use of this product and keep this manual for future reference



**IMPORTANT SAFETY INSTRUCTION**

- 1) Read these instructions.
  - 2) Keep these instructions.
  - 3) Heed all warnings.
  - 4) Follow all instructions.
  - 5) Do not use this apparatus near water.
  - 6) Clean only with dry cloth.
  - 7) Do not block any ventilation openings, install in accordance with the instructions.
  - 8) Do not install near any heat sources such as radiations, heat registers, stoves, or other apparatus (including amplifiers) that produce heat.
  - 9) Do not defeat the safety purpose of the polarized plug. If the provided plug does not fit into your outlet, consult an electrician for replacement of the obsolete outlet.
  - 10) Protected the power cord from being walked on or pinched particularly at plugs, convenience receptacles, and the point where they exit from the apparatus.
  - 11) Only use attachments/accessories specified by the manufacturer.
  - 12) Unplug this apparatus during lightning storms or when unused for long periods of time.
  - 13) Refer all servicing to qualified service personnel. Servicing is required when the apparatus has been damaged in any way, such as power-supply cord or plug is damaged, liquid has been spilled or objects have fallen into the apparatus, the apparatus has been exposed to rain or moisture, does not operate normally, or has been dropped.
  - 14) Mains plug is used as the disconnect device, the disconnect device shall remain readily operable.
  - 15) The ventilation should not be impeded by covering the ventilation openings with items, such as newspapers, table-cloth, curtains, etc.
  - 16) No naked flame sources, such as lighted candles, should be placed on the apparatus.
  - 17) Attention should be drawn to the environmental aspects of battery disposal.
  - 18) The use of apparatus in moderate climate.
  - 19) The apparatus shall not be exposed to dripping or splashing and that no objects filled with liquids, such as vases, shall be placed on the apparatus.
- Warning:** To avoid any injury caused by lean of the product, please always ensure the whole product was placed within the table surface in horizontal.

**WARNING**

Never place a television set in an unstable location. A television set may fall, causing serious personal injury or death. Many injuries, particularly to children, can be avoided by taking simple precautions such as:

- Using cabinets or stands recommended by the manufacturer of the television set.
- Only using furniture that can safely support the television set.
- Ensuring the television set is not overhanging the edge of the supporting furniture.
- Not placing the television set on tall furniture (for example, cupboards or bookcases) without anchoring both the furniture and the television set to a suitable support.
- Not placing the television set on cloth or other materials that may be located between the television set and supporting furniture.
- Educating children about the dangers of climbing on furniture to reach the television set or its controls.

If your existing television set is being retained and relocated, the same considerations as above should be applied.

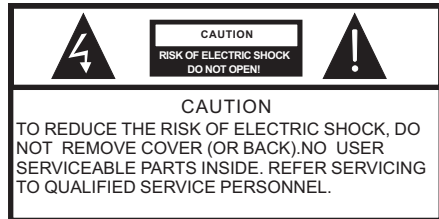

The symbol indicates that dangerous voltages constituting a risk of electric shock are present within this unit.



The symbol indicates that there are important operating and maintenance instructions in the literature accompanying this unit.

**WARNING:**

To reduce the risk of fire or electric shock, do not expose this apparatus to rain or moisture.

**WARNING:**

The batteries shall not be exposed to excessive heat such as sunshine, fire or the like.



This symbol indicates that this product incorporates double insulation between hazardous mains voltage and user accessible parts. When servicing use only identical replacement parts.



This marking indicates that this product should not be disposed with other household wastes throughout the EU. To prevent possible harm to the environment or human health from uncontrolled waste disposal, recycle it responsibly to promote the sustainable reuse of material resources. To return your used device, please use the return and collection systems or contact the retailer where the product was purchased. They can take this product for environmental safe recycling.

**Step one:** Use the expansion bolts(4\*36PWA) to fix the wall mount brackets into the wall

**Step Two:** Fix the wall mount screws (M6x8mm/4pcs) into the rear side of the LCD TV, using the tongue of 8kgf.cm.

\* The TV appearance subject to material object.

**Step Three:** Put the LCD TV with wall mount screws onto the wall mount brackets.

**Warning:** the angle between the TV and wall must not be bigger than 3°.

**Warning:** Changes or modifications to this unit not expressly approved by the party responsible for compliance could void the user's authority to operate the equipment.

**NOTE:** This equipment has been tested and found to comply with the limits for a Class B digital device, pursuant to Part 15 of the FCC Rules. These limits are designed to provide reasonable protection against harmful interference in a residential installation. This equipment generates, uses and can radiate radio frequency energy and, if not installed and used in accordance with the instructions, may cause harmful interference to radio communications.

However, there is no guarantee that interference will not occur in a particular installation. If this equipment does cause harmful interference to radio or television reception, which can be determined by turning the equipment off and on, the user is encouraged to try to correct the interference by one or more of the following measures:

- o Reorient or relocate the receiving antenna.
  - o Increase the separation between the equipment and receiver.
  - o Connect the equipment into an outlet on a circuit different from that to which the receiver is connected.
- Consult the dealer or an experienced radio/TV technician for help.

This device complies with Part 15 of the FCC Rules. Operation is subject to the following two conditions:

- (1) this device may not cause harmful interference, and
- (2) this device must accept any interference received, including interference that may cause undesired operation.

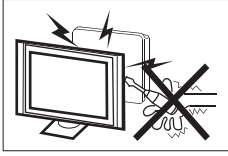

High voltages are used in the operation of this television receiver. Do not remove the cabinet back from your set. Refer servicing to qualified service personnel.

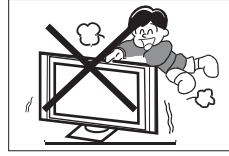

Never stand on, lean on, or suddenly push the television or its stand. You should pay special attention to children. Serious injury may result if it falls.

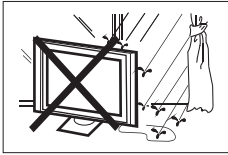

To prevent fire or electrical shock hazard, do not expose the television receiver to rain or moisture.

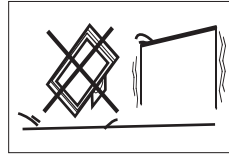

Do not place your television on an unstable cart, stand, shelf or table. Serious injury to an individual, and damage to the television, may result if it falls.

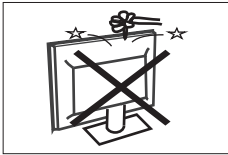

Do not drop or push objects into the television cabinet slots or openings. Never spill any kind of liquid on the television receiver.

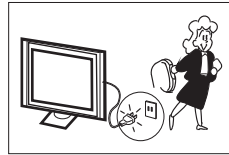

When the television receiver is not used for an extended period of time, it is advisable to disconnect the AC power cord from the AC outlet.

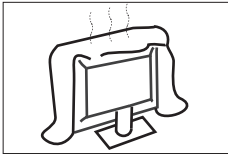

Do not block the ventilation holes in the back cover. Adequate ventilation is essential to prevent failure of electrical components.

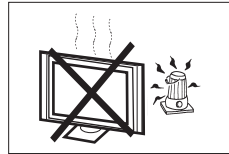

Avoid exposing the television receiver to direct sunlight and other sources of heat. Do not stand the television receiver directly on other products which give off heat, e.g. video cassette players and audio amplifiers. Do not place naked flame sources, such as lighted candles on the television.

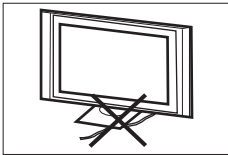

Do not trap the power supply cord under the television receiver.

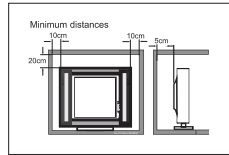

If the television is to be built into a compartment or similar enclosure, the minimum distances must be maintained. Heat build-up can reduce the service life of your television, and can also be dangerous.

# Contents

Safety and warnings.....	1-3
Introduction.....	5
Installation.....	6-9
Wall Mount.....	10
Remote Control.....	11-12
Operation.....	13-16
Trouble Shooting.....	17

**Main features**

- 52" wide screen for a complete home theater experience
- Super slim LCD TV with LED backlight
- 3840 x 2160 native resolution for UHD performance
- Integrated ATSC TV tuner for HDTV broadcast reception
- Beautiful color depth with a dynamic contrast ratio of 1200:1
- Triple HDMI® inputs for true digital connections

**Accessories**

Power Cable.....	1
Infrared Remote Control.....	1
User's Manual .....	1
Battery(AAA).....	2
Screws.....	4
Base stand.....	2
Component adaptor cable.....	1

**Specifications**

Viewing Picture Size(diagonal)	52" class (52" diagonal)
Resolution:	3840 x 2160
Aspect Ratio:	16:9
TV System:	ATSC Digital system and NTSC Analog system
Video Signal System:	NTSC/PAL
Receiving Channel:	Cable :1-135/ Air: 2-69(ATV&DTV)
Maximum Power Consumption:	165W
Input Power Voltage:	AC 100-240V 50/60Hz
Audio Output Power(THD ≤ 7%):	2 x 10W
High-Definition Multimedia Interface(HDMI) Input	x 3
YCb(Pb)Cr(Pr) Input	x 1
Composite Video Input	x 1
Audio Input	x 1
Headphone Output	x 1
Optical	x 1
USB Input	x 1
Dimensions (approx) with stand fitted(WxDxH)	1349 x 27; x 8; 8mm
Net weight	12.9kg with STAND
Horizontal definition(TV line)	Composite Video Input ≥350 Component (YPbPr) Video Input ≥400 Others (HDMI1,HDMI2,HDMI3,VGA) ≥400



The terms HDMI and HDMI High-Definition Multimedia Interface, and the HDMI Logo are trademarks or registered trademarks of HDMI Licensing LLC in the United States and other countries.

Manufactured under license from Dolby Laboratories. Dolby and the double-D symbol are trademarks of Dolby Laboratories.

**Front panel**

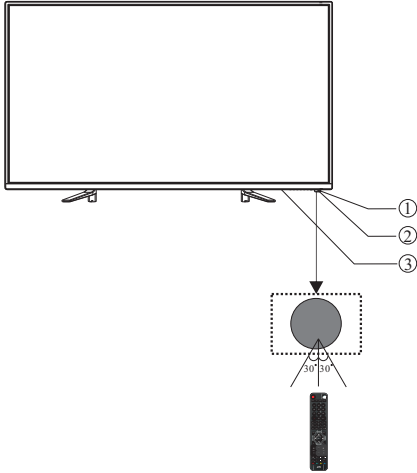

1. Remote control sensor.
2. Indicator LED:  
RED ● STAND BY.
3. Key board.

**Panel keys**

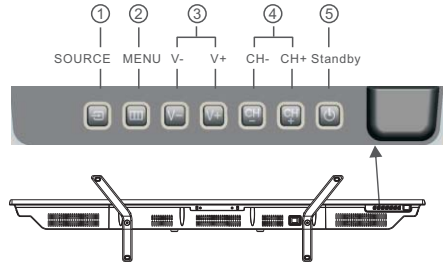

1. **SOURCE:**  
Display the input source menu. In MENU mode, press "SOURCE" to confirm the selected item.
2. **MENU:**  
Display main MENU.
3. **V+/V-**  
Adjust sound level.  
In MENU mode, press "V+" or "V-" to adjust the item that you selected.
4. **CH+/CH-**  
In TV mode, press "CH+" or "CH-" to change the channel up and down. In MENU mode, press "CH+" or "CH-" to select items.
5. **STANDBY**  
Press this button to turn the unit ON from STANDBY mode.  
Press it again to turn the set back to STANDBY.

**REAR Connections**



All the terminals are (from left to right): Power Socket, OPTICAL, VIDEO INPUT, AUDIO INPUT.

**SIDE Connections**



All the terminals are (from left to right): HDMI1, HDMI2, HDMI3, Headphone, YPbPr, USB, RF.

Antenna

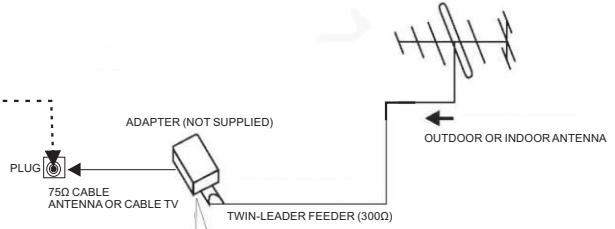
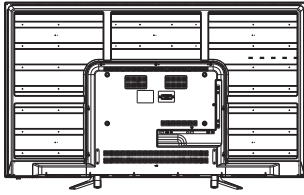

Note:  
Aerial connections:F connector.  
Input impedance:75Ω unbalanced

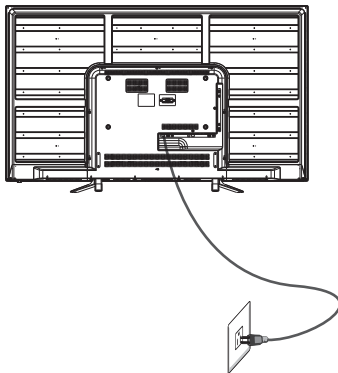
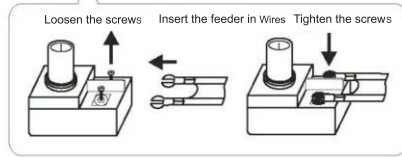

PRESET MODE (HDMI)

	RESOLUTION	V.Freq.(Hz)	H.Freq.(KHz)
1	800*600	60	37.88
2	1024*768	60	48.36
3	1366*768	60	47.7
4	1280*768	60	47.3
5	1920*1080	60	67.5
6	3840*2160	30	67.5
7	3840*2160	50	112.5
8	3840*2160	60	135



**Base Stand Assembly Instruction**

**the base stand**

Prepare to place the TV with the display side down on a flat surface. Due to the size and weight of this TV, the use of 2 people is recommended when moving it. Ensure the table or desk you use provides a flat, totally clean surface, and use a soft cloth between the face of the TV and the table to protect the TV's screen.

1. Locate the 2PCS of the base stand into the gap in the bottom of the TV , and check that it is securely held in place as per a) below.

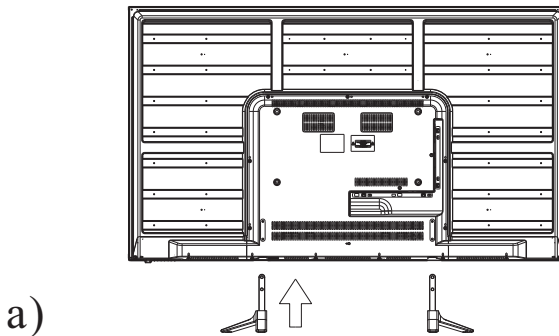

2.Lock 4PCS screws in the designated location as per b) below and check each screw is firmly tightened

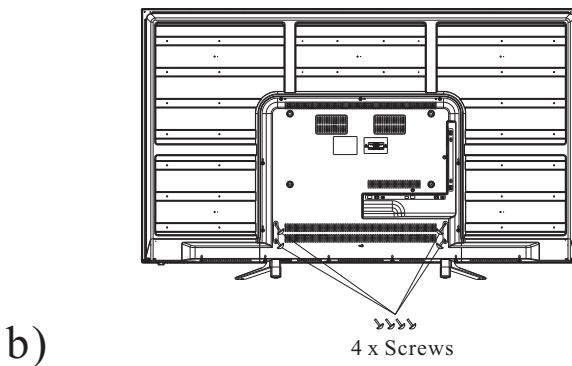

AV Equipment

You can use the input terminals on TV set rear as follows.

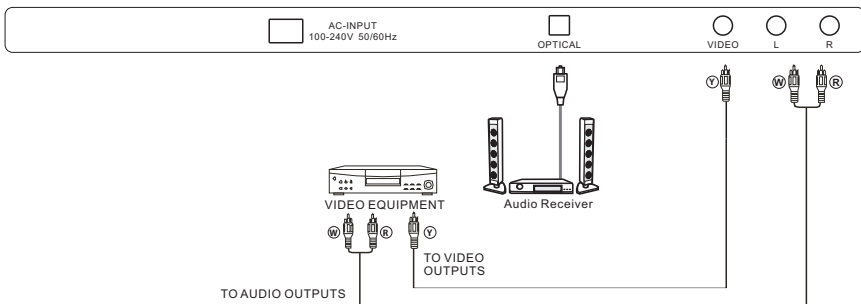
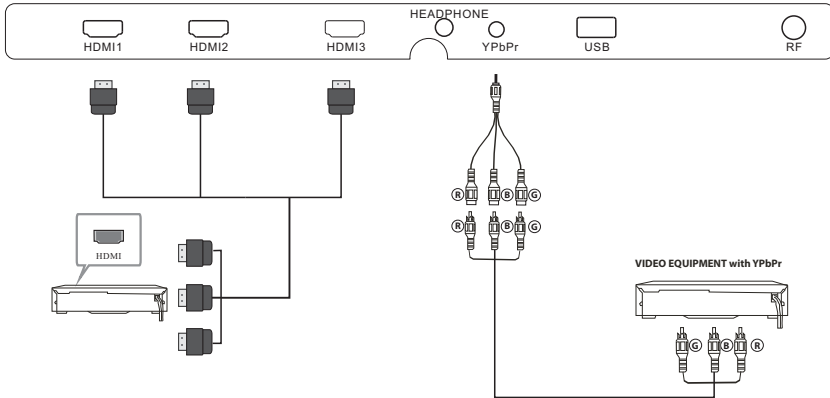

Video Equipments: VCR, Multi Disc Player, DVD Player, Camcorder, Video Game, etc.  
 Video format that YpPr supports: 480i, 576i, 480p, 720p, 1080i

**Instruction for Wall Mount**

A wall mount kit (purchased separately) would allow you to mount your **JVC** TV on the wall. For detailed information on installing the wall mount, refer to the instructions provided by the wall mount manufacturer. It is strongly recommended to contact a technician for professional assistance for wall mount installation. **JVC** is not responsible for any damage to the product or injury to yourself or others resulting from the wall-mounting.

**Dimensions for Mounting Hole Pattern**

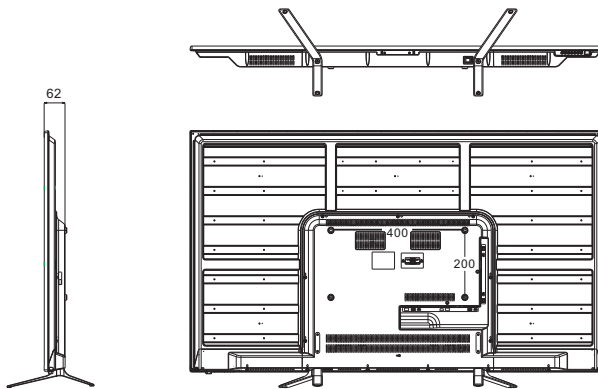

- This **JVC** TV is compatible with a 400mm x 200mm mounting hole pattern.
- 4 pcs of type M6 screws are required for installing the wall mount bracket to your **JVC** TV. Do not use screws that are longer than 10 mm. Screws that are too long may cause damage to the inside of the TV set.
- Do not fasten the screws too tight for this may damage the TV or cause the TV to fall, resulting in personal injury. **JVC** is not liable for these kinds of incidents.
- Do not mount your **JVC** TV at more than a 15 degree tilt.
- Always use two people to mount the TV to a wall.
- Do not install your Wall Mount Kit while your TV is turned on. It may result in personal injury due to electric shock.



1. **POWER** To set the TV standby or on.
2. **MUTING** Press to disable or enable the sound output.
3. **ASPECT** To change picture aspect .
4. **FAV** Used to access your favourite channels in digital TV mode.
5. **CH LIST** Used to display the channel list.
6. **EPG** Display all the information of DTV programs.
7. **NUMBER KEY** For direct access to program.
8. **RECALL** To access the previously viewed program.
9. **V-chip** Set up parental control.
10. **MTS** Switch the sound stereo.
11. **CC** Enable or disable the CC function.
12. **YPbPr** Hot key directly go to YPbPr source.
13. **DTV STRENGTH** Used to display the DTV signal strength menu.
14. **TV** Hot key directly go to TV source.
15. **AV** Hot key directly go to AV source.
16. **HDMI** Hot key directly go to HDMI source.
17. **USB** Press to launch the USB multimedia mode
18. **SLEEP** Press to display the sleep timer option.
19. **VOL**  Adjust volume to 50.
20. **VOL**  Adjust volume to 75.
21. **SOURCE** Press to display the Input Source List, to switch between the different inputs to the television.
22. **MENU** Press to display the TV main menu.
23. **EXIT** Used to exit menu.
24. **TV DISPLAY** Displays/removes the program Information.
25. **CURSOR** To move within the menu.
26. **OK** Confirms selection.



- 27. **VOL+/-**  
To adjust sound level.
- 28. **CH+/CH-**  
To access the next or previous Program.
- 29. **S.M**  
To switch sound mode.
- 30. **P.M**  
To switch picture mode.
- 31. **REWIND ◀◀**  
Reserved keys.
- 32. **FAST FORWARD ▶▶**  
Reserved keys.
- 33. **SKIP BACKWARD ◀◀**  
Press to skip the previous file or Track in USB Mode.
- 34. **SKIP FORWARD ▶▶**  
Press to skip the next file or track in USB Mode.
- 35. **PLAY ▶**  
Press the Play Button in USB Mode to begin or continue Playback.
- 36. **PAUSE ||**  
Press the Pause Button to pause play in USB Mode.
- 37. **STOP ■**  
Press to Stop play in USB Mode.
- 38. **REPEAT**  
Repeat play photo.
- 39. **COLOR KEYS**  
Reserved keys.

### 1. PICTURE MENU

In this menu, you can adjust the picture effect here, such as contrast, brightness, etc. Press ▼▲ to select, press OK to adjust.

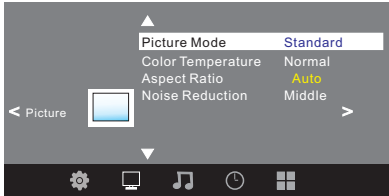

Note:

- 1). If you want to adjust contrast, brightness, color, and sharpness, the picture mode must return to personal status.
- 2). Tint is available in NTSC system only.
- 3). There are three color temperature modes can be selected: Normal, Warm and Cool.

### 2. AUDIO menu

In this menu, you can select the sound effect. Press ▼▲ to select, press OK to select.

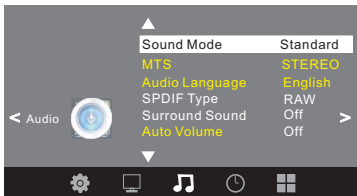

Note:

- 1). Five selectable sound modes: Standard, Music, Movie, Sports, and Personal.
- 2). Audio language is available in ATSC/TV Programming only.
- 3). Auto Volume is effective when input signal level is too high or distortion of input signal is too high.

### 3. TIMER MENU

In this menu, you can adjust the sleep timer, time zone, etc. Press ▼▲ to select, press OK to adjust.

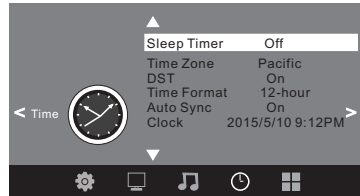

Note:

- 1). Time zone, DST and the clock are available in ATSC programming only.

### 4. Setup menu

In this menu, you can select the Menu language, Close Caption, Restore Default etc. Press ▼▲ to select, press OK to adjust.

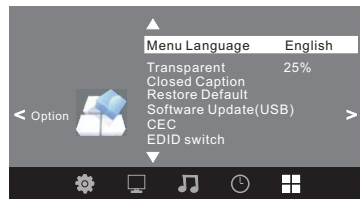

#### 4.1 Closed Caption

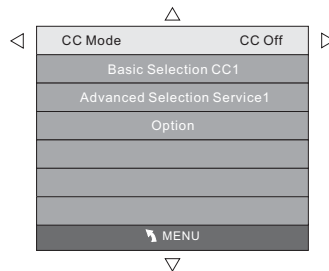

- 1).CC Mode: Switching close caption mode.
- 2). Advanced selection: Available only for ATSC program.
- 3).Option: Used to edit CC font.

Note:

- 1).Restore Default: Restore Default will clear all the programs and reset all the settings to default value.

**5. Channel MENU**

In this menu, you can select digital and analog TV Channels.

Press ▼▲ to select,press OK to adjust.

\* Only under TV source, menu will show ⚙️, other menu will not show ⚙️.

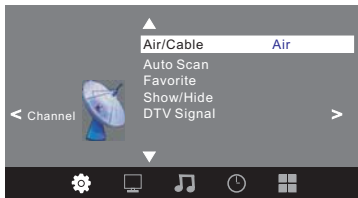

**5.1 Air/Cable:**

Select Air TV signal and cable TV signal.

**5.2 Auto Scan:** If this is the first time you turn on the TV, you should scan all the TV channels first, Press OK button to confirm, and the following menu will be displayed.

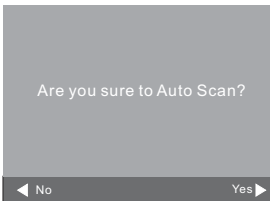

Press OK button to select a scan type,you will see the message below which indicates auto search is in process.

Auto Scan	DTV+ATV
Found: 0	Programme(S)
Analog: 0	Programme(S)
Digital: 0	Programme(S)
1%... RF CH 2 DTV+ATV	
██	

**5.3 Favorite:**

Press OK button to choose/delete the favorite channel.

**5.4 Show/Hide**

Press OK button to display or hide current channel.

**5.5 DTV signal**

Display DTV strength signal. No selection or adjustment is allowed.

**6.LOCK MENU**

In this menu, you can change the password and adjust the V-chip setting.

Enter the password, it will go into the lock menu.

Factory default password is 0000.

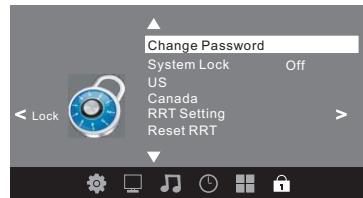

**6.1 Change Password**

- 1) Enter old password: Input the old password.
- 2) Enter new password: Input the new password.
- 3) Confirm password: Input the new password again.

**6.2 System Lock**

When the System Lock switch is ON, the below options listed below can be adjusted.

**6.3 US**

Press OK button the screen will display as follow.

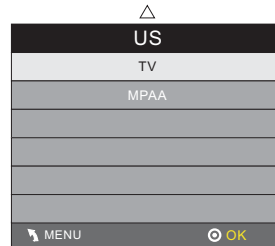

1) TV: Press OK button, the screen will display as follows:

TV RATING	
TV-NONE	ALL
TV-Y	ALL
TV-Y7	ALL FV
TV-G	ALL
TV-PG	ALL V S L D
TV-14	ALL V S L D
TV-MA	ALL V S L
BLOCK	

Rating	Content	Content				
		FV (Fantasy violence)	V (Violence)	S (Sexual situation)	L (Adult language)	D (Sexually suggestive dialog)
Suggested age	TV-Y (All children)					
	TV-Y7 (Direct to order children)	X				
	TV-G (General audience)					
	TV-PG (Parental Guidance suggested)		X	X	X	X
	TV-14 (Parents strongly cautioned)		X	X	X	X
	TV-MA (Mature audience only)		X	X	X	

And use the OK key to switch lock/ unlock Parental Control feature.

2) MPAA: Switching the movie-rating control level; N/A, G, PG, PG-13, R, NC-17, X.

Rating	Description	
Age	G	General audiences, All Ages admitted
	PG	Parental Guidance suggested. Some material may not be Suitable for children.
	PG-13	Parents strongly cautioned. Some material .may be Inappropriate for children under 13.
	R	Restrict. Under 17 requires accompanying parent or adult guardian(age varies in some jurisdictions)
	NC-17	No one 17 and under admitted.
	X	X is an order rating that is unified with NC-17 but may be encoded in the data of order movies.

**6.4 Canada**

Press **OK** button, the screen will be displayed as follow:



1) Canada English: Switching the English rating control level: EXEMPT, C, C8+, G, PG, 14+, 18+.

Rating	Description	
Age	C	Children: Intended for younger children under the age of 8 years. Pays careful attention to themes that could threaten their sense of security and well-being.
	C8+	Children over 8 years old: Contains no portrayal of violence as the preferred, acceptable, or only way to resolve conflict; nor encourage children to imitate dangerous acts which they may see on the screen.
	G	General: Considered acceptable for all age groups. Appropriate viewing for the entire family, contains very little violence, physical, verbal or emotional.
	PG	Parental Guidance: Intended for a general audience, but may not be suitable for younger children (under the age of 8) because it could contain controversial themes or issues.
	14+	Over 14 Years: Could contain themes where violence is one of the dominant elements of the storyline But it must be integral to the development of plot or character. Language usage could be profane and nudity , present within the context of theme.
	18+	Adults: Intended for viewers 18 years and older and might contain depictions of violence, which while related to the development of plot, character or themes, are intended for adult viewing. Could contain graphic language and portrayals of secretary and nudity.

2) Canada French: Switching the French-rating control level: G, 8ANS+, 13 ANS+, 16ANS+, 18ANS+.

Rating	Description	
Age	G	General : All ages and children, contains minimal direct violence, but may be integrated into the plot in a humorous or unrealistic manner .
	8ans+	General but inadvisable for young children :May be viewed by a wide public audience, but could contain scenes disturbing to children under 8 who cannot distinguish between imaginary and real situations. Recommended for viewing with paren.
	13ans+	Over 13 years: Could contain scenes of frequent violent scenes and in tense violence.
	16ans+	Over 16 years: Could contain frequent violent scenes and violence.
	18ans+	Over 18 years: Only for adult viewing. Could contain frequent violent scenes and extreme violence.

**6.5 RRT setting**

It can be adjusted when the TV is in ATSC digital mode and the TV stream have RRT information.

**6.6 Reset RRT**

It can be adjusted when the TV is in ATSC digital mode and the TV stream have RRT information.



**7. Displaying JPEG files by using USB Port**

You can display the JPEG files by using the USB port that is located on the rear panel:

7.1 Connect the USB DEVICE that contains the JPEG files.

7.2 Press **ENTER** to enter inputsource menu.

7.3 In the inputsource menu, Press **▲▶◀▶** to select USB, and then press OK.

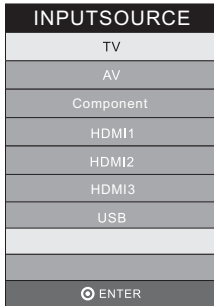

7.4 Press **▲▶◀▶** to select Photo, and then press enter









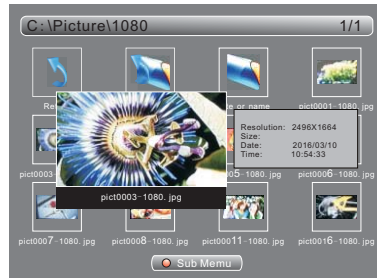







7.5 Press **▼▲▶◀▶** to select folder which contains JPEG picture .



7.6 Press **OK** to display the picture in the folder to the play list.

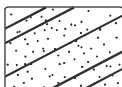

7.6 Press **▶** the play the picture full screen.

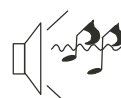
Trouble phenomenon Symptom		Inspection Check	
Picture	Audio		
 Snow	 Noise	antenna position, direction or connection	
 Ghost	 Normal audio	antenna position, direction or connection	
 Interference	 Noise	electronic equipment, car/ motorcycle, fluorescent light	
 Normal Picture	 No Sound	Volume (check if muting function is activated or if the audio system connections are not correct)	
 No picture	 No Sound	Power cord is not inserted Power switch is not opened Contrast and brightness/volume setup Press standby key on the remote control for inspecting	
 No Color	 Normal audio	Color control	
 Picture breaking up	 Normal audio or weak	retune channel	
 No Color	 Noise	TV system	

The LED TV panel is built with very high precision technology giving you fine picture details in vibrant color. Occasionally, a few non-active pixels may appear on the screen as a fixed point of red, green, blue, black or white. Please note this does not affect the performance of the product.