

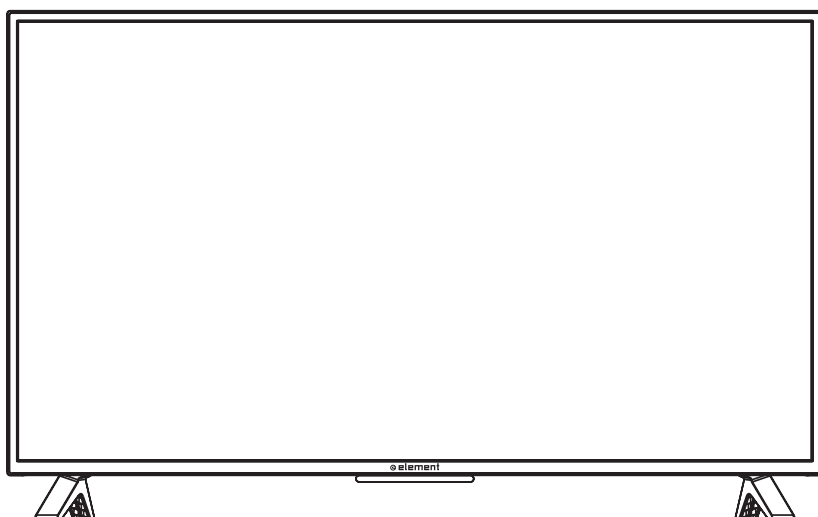

Digital LED TV

Please refer to the actual product



INSTRUCTION MANUAL

Please read all the instructions carefully before using this TV,
and keep the manual for future reference.



CONTENTS

Important Safety Instructions	2
Additional Safety Information	3
Preparations	4
What's Included	4
Front View	5
Rear View	6
Wall Mounting	6
Remote Control	7
Connecting External Devices	8
Customizing TV Settings	9
Turning On/Off Your TV	9
Initial Setup	9
Source	11
Channel Selection	11
Volume Adjustment	11
Streaming	12
Media	13
Viewing Photos	13
Listening To Music	14
Watching Videos	14
TV Settings	15
General	16
Picture Settings	18
Audio Settings	19
Network Settings	19
Channel Settings	20
Time Settings	20
Lock Settings	21
APP Settings	21
Parental Control	22
Troubleshooting	24
FCC Notes	27
OTT APP Service	28

IMPORTANT SAFETY INSTRUCTIONS

- **Read these instructions** – All the safety and operating instructions should be read before this product is operated.
- **Keep these instructions** – The safety and operating instructions should be retained for future reference.
- **Heed all warnings** – All warnings on the appliance and in the operating instructions should be adhered to.
- **Follow all instructions** – All operating and use instructions should be followed.
- **Do not use this apparatus near water** – The appliance should not be used near water or moisture – for example, in a wet basement or near a swimming pool, and the like.
- Clean only with dry cloth.
- **Do not block any ventilation openings.** Install in accordance with the manufacturer's instructions.
- **Do not install near any heat sources** such as radiators, heat registers, stoves, or other apparatus (including amplifiers) that produce heat.
- **Do not defeat the safety purpose of the polarized or grounding-type plug.** A polarized plug has two blades with one wider than the other. A grounding-type plug has two blades and a third grounding prong. The wide blade or the third prong are provided for your safety. If the provided plug does not fit into your outlet, consult an electrician for replacement of the obsolete outlet.
- Protect the power cord from being walked on or pinched particularly at plugs, convenience receptacles, and the point where they exit from the apparatus.
- Only use attachments/accessories specified by the manufacturer.
- Use only with the cart, stand, tripod, bracket, or table specified by the manufacturer, or sold with the apparatus. When a cart is used, use caution when moving the cart/apparatus combination to avoid injury from tip-over.



- Unplug this apparatus during lightning storms or when unused for long periods of time.

- Refer all servicing to qualified service personnel. Servicing is required when the apparatus has been damaged in any way, such as the power-supply cord or plug is damaged, liquid has been spilled or objects have fallen into the apparatus, the apparatus has been exposed to rain or moisture, does not operate normally, or has been dropped.
- Please keep the unit in a well-ventilated environment.

WARNING: To reduce the risk of fire or electric shock, do not expose this apparatus to rain or moisture. The apparatus should not be exposed to dripping or splashing. Objects filled with liquids, such as vases should not be placed on apparatus.

WARNING: The batteries shall not be exposed to excessive heat such as sunshine, fire or the like.

WARNING: The main plug is used as disconnect device, the disconnect device shall remain readily operable.

WARNING: To reduce the risk of electric shock, do not remove cover (or back) as there are no user-serviceable parts inside. Refer servicing to qualified personnel.



This lightning flash with arrowhead symbol within an equilateral triangle is intended to alert the user to the presence of non-insulated "dangerous voltage" within the product's enclosure that may be of sufficient magnitude to constitute a risk of electric shock.



The exclamation point within an equilateral triangle is intended to alert the user to the presence of important operating and maintenance instructions in the literature accompanying the appliance.



This equipment is a Class II or double insulated electrical appliance. It has been designed in such a way that it does not require a safety connection to electrical earth.

HDMI[®]
HIGH-DEFINITION MULTIMEDIA INTERFACE

The terms HDMI and HDMI High-Definition Multimedia Interface, and the HDMI Logo are trademarks or registered trademarks of HDMI Licensing Administrator, Inc in the United States and other countries

ADDITIONAL SAFETY INFORMATION

To ensure reliable and safe operation of this equipment, please read carefully all the instructions in this user guide, especially the safety information below.

Electrical Safety

- The TV set should only be connected to a main power supply with voltage that matches the label at the rear of the product.
- To prevent overload, do not share the same power supply socket with too many other electronic components.
- Do not place any connecting wires where they may be stepped on or tripped over.
- Do not place heavy items on them, which may damage the leads.
- Hold the main plug, not the wires, when removing from a socket.
- During a thunderstorm, or when not using the television for extended period of time, turn off the power switch on the back of the television.
- Do not allow water or moisture to enter the TV or power adapter. Do NOT use in wet, moist areas, such as bathrooms, steamy kitchens or near swimming pools.
- Pull the plug out immediately, and seek professional help if the main plug or cable is damaged, liquid is spilt onto the set, if accidentally exposed to water or moisture, if anything accidentally penetrates the ventilation slots or if the set does not work normally.
- Do not remove the safety covers. There are no user serviceable parts inside. Trying to service the unit yourself is dangerous and may invalidate the product's warranty. Qualified personnel must only service this apparatus.
- To avoid battery leakage, remove exhausted batteries from the remote control, or when not using for long period.
- Do not break open or throw exhausted batteries on a fire.
- Do not mix old and new batteries.
- Do not mix Alkaline, Standard (Carbon-Zinc) or Rechargeable (Nickel Cadmium) or (Nickel Metal Hydride) batteries.

Physical Safety

- Do not block ventilation slots in the back cover. You may place the TV in a cabinet, but ensure at least 5cm (2") clearance all around.
- Do not tap or shake the TV screen, or you may damage the internal circuits. Take good care of the remote control.
- To clean the TV use a soft dry cloth. Do not use solvents or petroleum based fluids.
- Do not install near any heat sources such as radiators, heat registers, stoves or other apparatus (including amplifiers) that produce heat.
- Do not defeat the safety purpose of the polarized or grounding-type plug. A polarized plug has two blades with one wider than the other. A grounding type plug has two blades and a third grounding prong, the wide blade, or the third prong is provided for your safety. If the provided plug does not fit into your outlet, consult an electrician for replacement of the obsolete outlet.
- Protect the power cord from being walked on or pinched particularly at plugs.
- Unplug the apparatus during lightning storms or when unused for long periods.
- Refer all servicing to a qualified service personnel. Servicing is required when the apparatus has been damaged in any way, such as power-supply cord or plug is damaged, liquid has been spilled, or objects have fallen into the apparatus, has been exposed to rain or moisture, does not operate normally, or has been dropped.
- Please always connect your television to a power outlet with protective ground connection.

PREPARATIONS

What is Included?

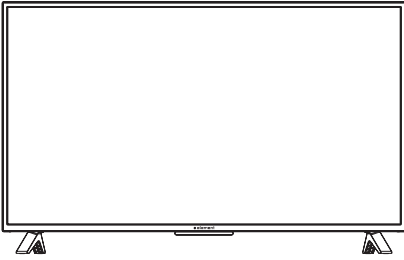

TV Set

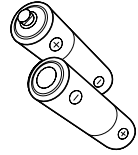

Remote Control with Batteries

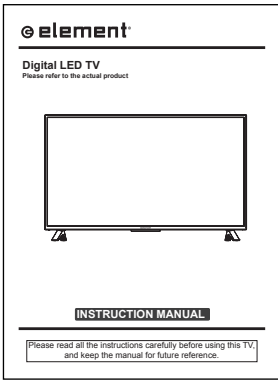

User Manual

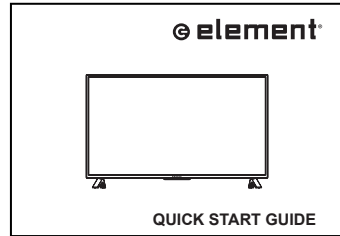

Quick Start Guide

PREPARATIONS

Front View

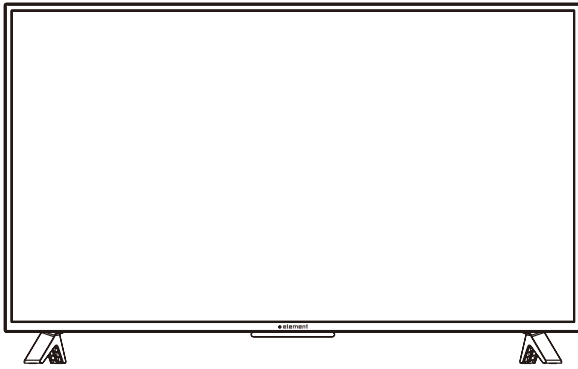

- **⏻**
Switch the TV between On / Standby mode.
- **SOURCE**
Press to select among different input signal sources.
- **MENU**
Display the OSD (on screen display) menu.
- **CH +/-**
Press to select a channel.
- **VOL +/-**
Press to adjust the volume.
- **LED**
The LED light indicates when the TV is activated.
- **IR**
Infrared Receiver.

PREPARATIONS

Rear View

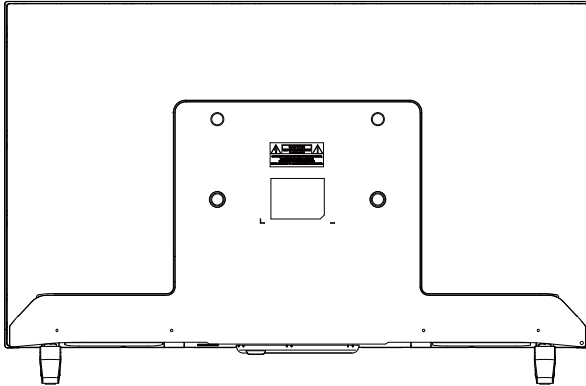

AUDIO OUT

Headphone Output



HDMI

HDMI Input



RF (75 Ω)

Antenna Input(75 Ω VHF/UHF)



OPTICAL

Optical Output



USB
5V \Rightarrow 500mA

USB Input



AV/Component Input



VGA Input/PC Audio Input

Wall Mounting

WARNING

Never place a television set in an unstable location. A television set may fall, causing serious personal injury or death. Many injuries, particularly to children, can be avoided by taking simple precautions such as:

- Using cabinets or stands recommended by the manufacturer of the television set.
- Ensuring the television set is not overhanging the edge of the supporting furniture.
- Not placing the television set on tall furniture(for example, cupboards or bookcases) without anchoring both the furniture and the television set to a suitable support.
- Not placing the television set on cloth or other materials that may be located between the television set and supporting furniture.
- Educating children about the dangers of climbing on furniture to reach the television set or its controls.If your existing television set is being retained and relocated, the same considerations as above should be applied.



Your new TV is heavy, please consult with professional wall mount installer to perform this installation.

PREPARATIONS

Remote Control

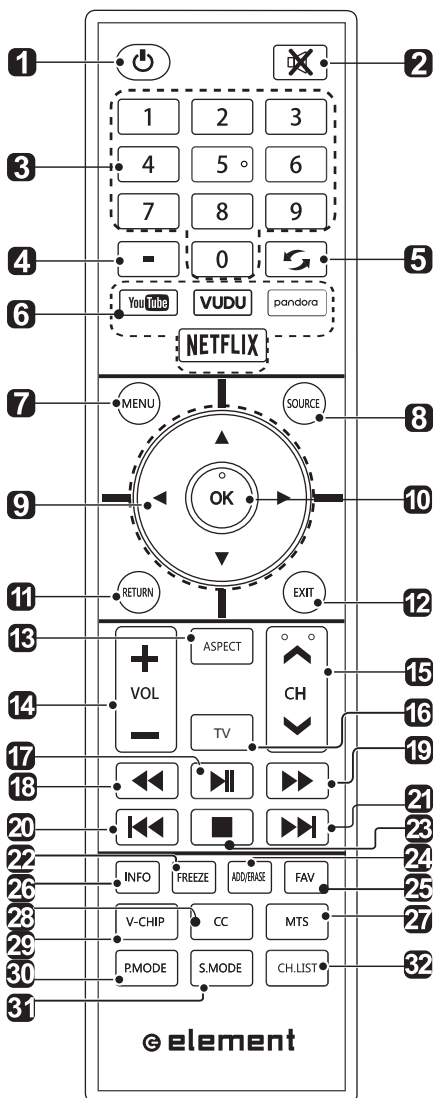

1. : Switch the TV between On and Standby mode.
2. : Mute and restore TV sound.
3. 0-9: Select a program. (ATV/DTV mode)
4. : Enter multiple program channel number such as 2-1.
5. : Return to the previous viewing channel.
6. APP: Press to select the desired APP.
7. MENU: Display the main menu.
8. SOURCE: Select among the different input signal sources: TV/AV/COMPONENT/HDMI1/HDMI2/HDMI3/VGA/USB.
9. : Allows you to navigate the on screen display menus and adjust the system settings to your preference.
10. OK: Confirm the selection.
11. RETURN: Return to previous menu.
12. EXIT: Exit the on screen display menu.
13. ASPECT: Select the aspect ratio. settings: standard/wide/wide zoom/zoom/Just Scan (HDMI)/Dot by Dot(VGA).
14. VOL +/-: Adjust the volume.
15. CH +/-: Select the channel.
16. TV: Into the TV channel.
17. : Start playback or pause.
18. : Reverse playback rapidly.
19. : Advance playback rapidly.
20. : Skip to the beginning of the previous chapter/track/photo.
21. : Skip to the beginning of the next chapter/track/photo.
22. FREEZE: Freeze the picture.
23. : Stop the playback.
24. ADD/ERASE: Add or delete Favorite channels.
25. FAV: Display the favorite channel list.
26. INFO: Display the present screen information such as the current channel and input source.
27. MTS: Switch among different audio channels: STEREO/MONO/SAP.
28. CC: Closed Caption selection: ON/OFF/CC On Mute.
29. V-CHIP: Set up parental control.
30. P.MODE: Select picture mode: dynamic/movie/user/standard.
31. S.MODE: Select sound mode: standard/music/movie/user.
32. CH.LIST: Display program list.

CONNECTING EXTERNAL DEVICES

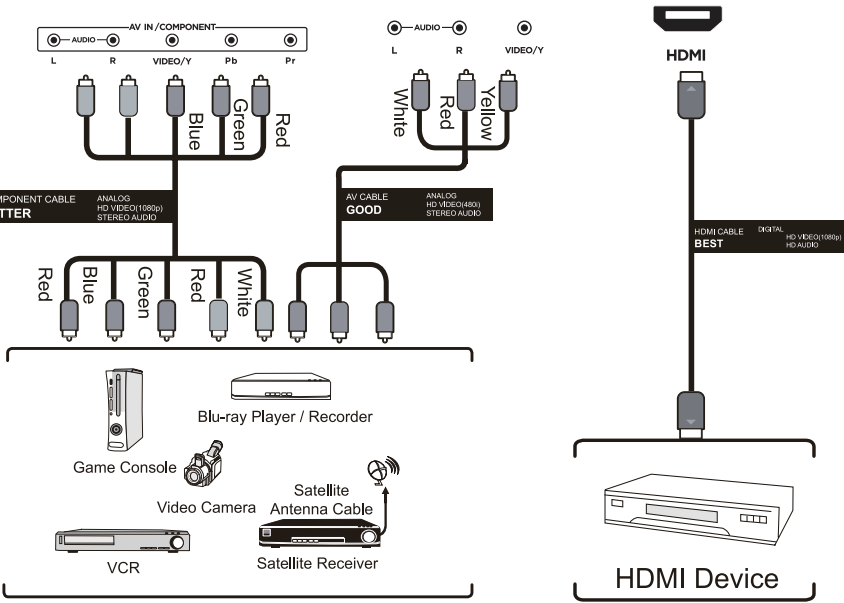

Match colored connectors to colored ports on back side of the TV.

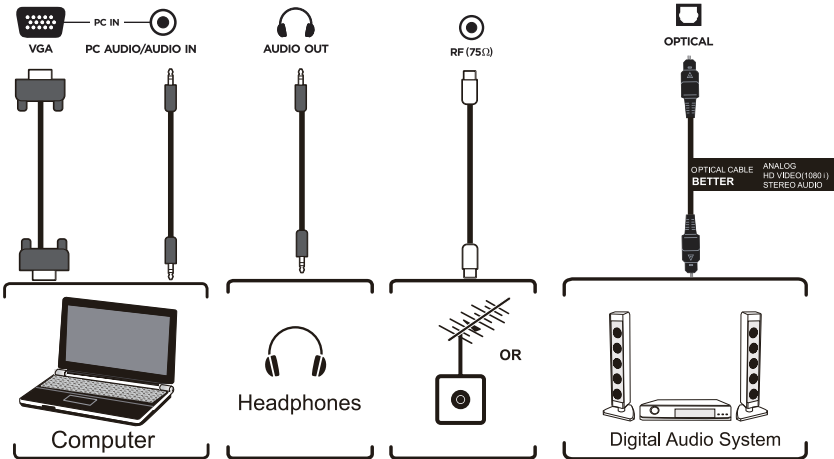

CUSTOMIZING TV SETTINGS

Turning On/Off Your TV

- Connect the power cord to the power socket after you have completed all the physical connections. At this stage, the TV will enter Standby Mode and the red LED indicator will illuminate.
- In Standby Mode, press the  button on the main unit or on the remote control to turn the TV on. The red LED indicator will turn blue.



The **POWER** button on the main unit or on the remote control can only switch the TV into standby. To completely turn off the TV, please disconnect the power cord from the power socket.

Initial Setup

LANGUAGE

ENGLISH Welcome to the ELEMENT TV Setup Wizard.

FRENCH

SPANISH

Follow this guide to help setup your TV to scan channels or access your external devices like your Antenna, Set-Top Box, Blu-ray/DVD, Gaming systems or other devices.

Use the UP or DOWN arrows on your remote control or TV keypad to select the language on screen menu.

1

- The first time you turn the TV on, it will go into the Setup Wizard. Press the **Arrow** buttons to highlight and select your desired mode and press **OK** to confirm.

DATA COLLECTION AND FIRMWARE UPDATES NOTICE

When this television is connected to the internet, it will collect limited, non-personally identifiable information which will be sent to MStar Semiconductor Inc. ("MStar") and its service providers. Certain of this information may be aggregated and shared with third party partners for business and product analysis purposes. By clicking "Accept" you acknowledge and agree to the collection and sharing of this information as described in more detail in the "View Additional Details" section, as well as the automatic download of essential firmware/software updates.

[VIEW ADDITIONAL DETAILS] [ACCEPT]

2

TIME ZONE

HAWAII

ALASKA

PACIFIC

MOUNTAIN

CENTRAL

EASTERN

ATLANTIC

NEWFOUNDLAND

< BACK

Use the UP and DOWN arrows on your remote control or TV keypad to select your local time zone.

3

CUSTOMIZING TV SETTINGS

Initial Setup

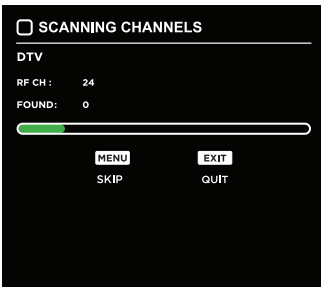
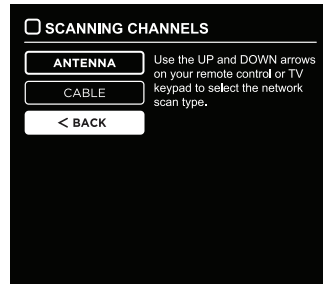
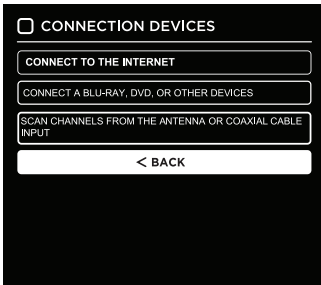

CUSTOMIZING TV SETTINGS

Source

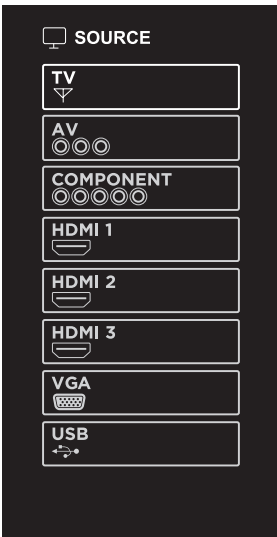

- Press **SOURCE** on the remote control or on the main unit to display the source menu, then use the **Arrow** buttons to cycle among the different input sources: TV/AV/COMPONENT/HDMI/VGA/USB, then use the **Arrow** buttons to highlight the desired source and press **OK** to confirm.

Channel Selection

- Press the **CH[^]/CH^v** buttons on the main unit or on the remote control repeatedly to select the channel.
- Press the **0-9** buttons on the remote control to select the channel directly.



Press "4", and then press **OK** button to select channel 4.

Press "4" and "5", and then press **OK** button to select channel 45.

Press "1", "2" and "3", and then press **OK** button to select channel 123.

Volume Adjustment

- Press the **VOL+/-** buttons on the main unit or on the remote control to adjust the volume.
- If you wish to switch the sound off, press the **MUTE** button again or the **VOL+** button to resume the sound.

CUSTOMIZING TV SETTINGS

Streaming

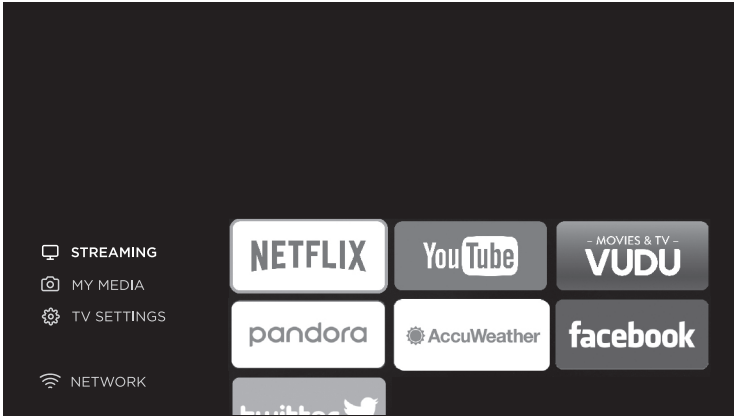

- Press **MENU** button on the main unit or on the remote to display the main interface. Then use the Arrow buttons to select **STREAMING** and press **OK** to enter. Use the **Arrow** buttons to select the desired APP and press **OK** button to view. Or press the hotkey on the remote control to enter the desired APP directly. For full listing of available Apps, please visit elementelectronics.com.

NETFLIX	Enjoys TV shows & movies streamed instantly over the Internet.
YouTube	YouTube your way on the best screen in your house.
VUDU	Discover, watch and collect the latest movies and TV shows in high quality 1080p. Free to sign up. No subscriptions, late fees or commitments.
Pandora	Free personalized radio that offers effortless and endless music enjoyment and discovery. Just start with the name of one of your favorite artists, songs, genres or composers and Pandora will do the rest. It's easy to create personalized stations that play only music you'll love.
AccuWeather	Displays the current weather conditions and the temperature anywhere in the world in centigrade or Fahrenheit.

CUSTOMIZING TV SETTINGS

Media

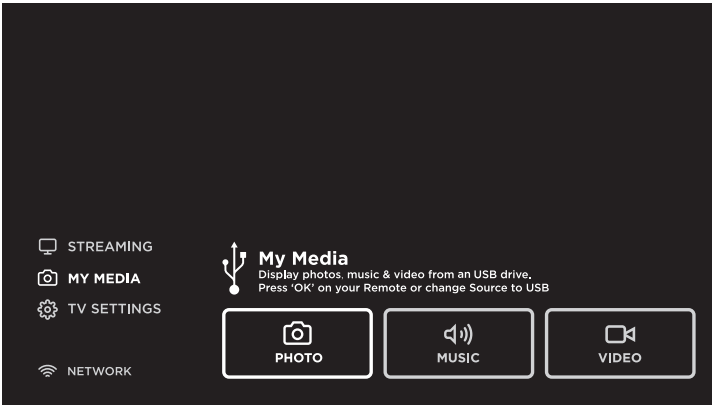

- Press **MENU** button to display the main interface, then use the **Arrow** buttons to highlight **MY MEDIA** and press **OK** to confirm. Select among Photos, Music and Video to view what you like.

Note: Portable drives should be inserted before entering **MY MEDIA** menu.

Viewing Photos

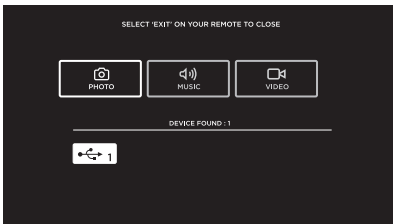

- Use the **Arrow** buttons to highlight the **PHOTOS** option and press **OK**, then it will jump to confirm the inserted drive, press **OK** to enter. After entering **PHOTOS**, use the **Arrow** buttons to select the picture file and press **OK** to enter.

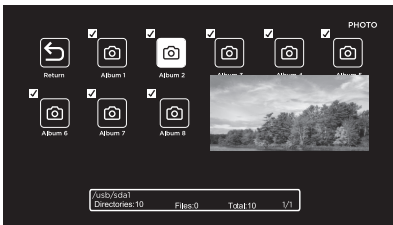

- After entering the picture file, use the **Arrow** buttons to select the desired picture, then press the **▶||** to display. When the picture is playing, the picture Function Bar will be displayed. Use the **Arrow** buttons to select the desired function available on the bar.

CUSTOMIZING TV SETTINGS

Listening To Music

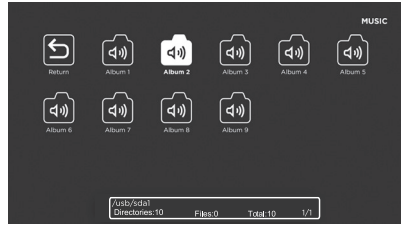
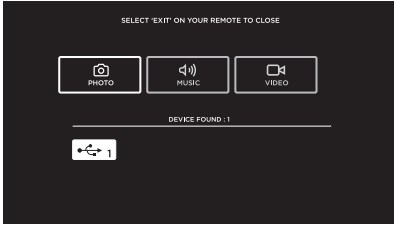

- Use the **Arrow** buttons to highlight the **MUSIC** option and press **OK**, then it will jump to confirm the inserted drive, press **OK** to enter. After entering **MUSIC**, use the **Arrow** buttons to select the audio file and press **OK** to enter.

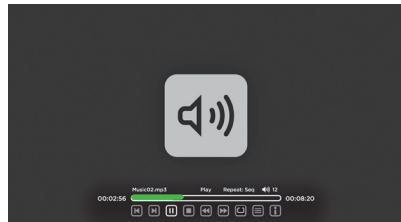

- After entering the audio file, use the **Arrow** buttons to select the desired music, then press the **Play** button to display. When the music is playing, the music Function Bar will be displayed. Use the **Arrow** buttons to select the desired function available on the bar.

Watching Videos

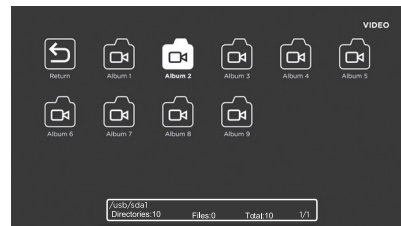
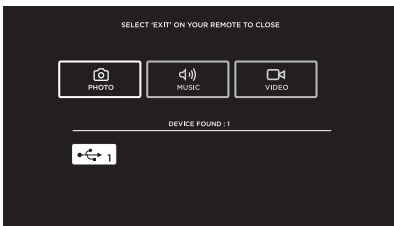

- Use the **Arrow** buttons to highlight the **VIDEOS** option and press **OK**, then it will jump to confirm the inserted drive, press **OK** to enter. After entering **VIDEOS**, use the **Arrow** buttons to select the video file and press **OK** to enter.

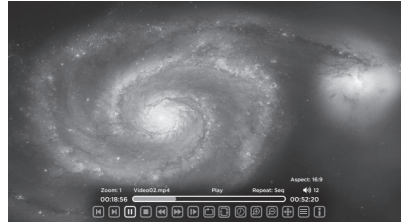
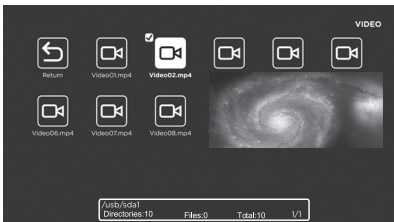

- After entering the video file, use the **Arrow** buttons to select the desire video, then press the **Play** button to display. When the video is playing, the video function bar will be displayed. Use the **Arrow** buttons to select the desired function available on the bar.

CUSTOMIZING TV SETTINGS

TV Settings

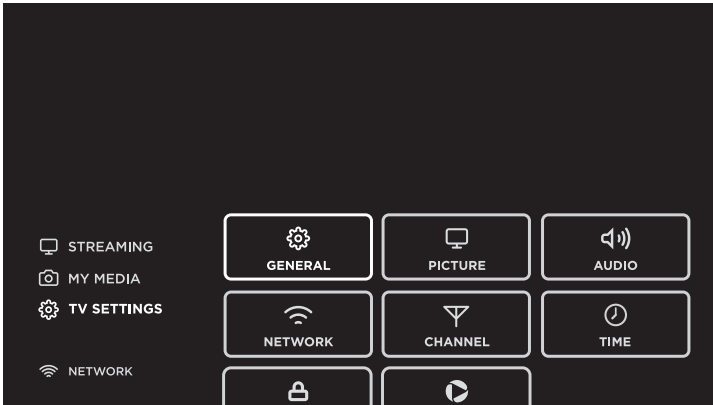

- Press the **MENU** button on the main unit or on the remote control to display the main interface. Then use the **Arrow** buttons to highlight **TV Settings** and press **OK** to enter. Then use the **Arrow** buttons to cycle among the following options and select the desired one to enter.

CUSTOMIZING TV SETTINGS

General

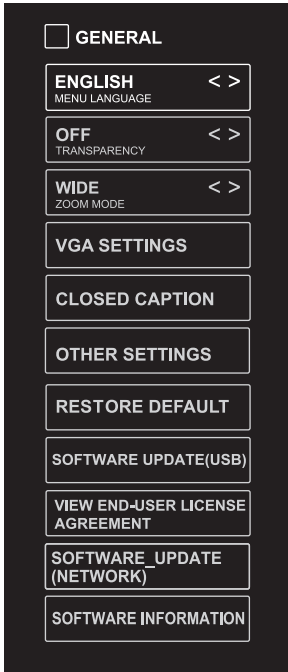

- Press **MENU** to display the main interface, then use the **Arrow** buttons to highlight **TV Settings** and press **OK** to confirm. Use the **Arrow** buttons to cycle among different options and select **General** to enter and adjust each option setting.

MENU LANGUAGE	Select the menu language among English, Français or Español. The default on-screen menu language is English.	
TRANSPARENCY	Select to turn On/Off transparency function.	
ZOOM MODE	Select zoom mode: Wide/Wide Zoom/Zoom/Standard/Just Scan(at HDMI mode)/Dot by Dot(at VGA mode). Note: With a different input source, the zoom mode options may differ.	
VGA SETTINGS	<i>Adjust advanced option's setting: H-POS, V-POS, Clock, Phase or Auto. (only available in VGA mode)</i>	
CLOSED CAPTION	CC mode	On/Off/CC on Mute.
	Basic Selection	CC1, CC2, CC3, CC4, TEXT1, TEXT2, TEXT3, TEXT4, OFF.
	Advanced Selection	Service1/Service2.../Service6.
	Option	Mode, Font Style, Font Size, Font Edge Style, Font Edge Color, FG_ Color, BG_ Color, FG_ Opacity, BG_ Opacity.



OTHER SETTINGS	<p>INLINK: LINLINK CONTROL,DEVICE POWER OFF,TV Auto Power On,AUDIO RECEIVER,LINLINK DEVICE LIST,ROOT MENU.</p> <p>Accessibility TTS: Voice Guide,VERBOISITY,RATE SUPPORT,PITCH SUPPORT,VOICE,Video Description,VD VOLUME DLC:Select to turn On/Off DLC.</p>
RESTORE DEFAULT	Restore the TV to factory default settings.
SOFTWARE UPDATE (USB)	Software Update In the case of a USB device.
VIEW END-USER LINCENSE AGREEMENT	Choose "I have read the user agreement" to select Accept or Decline .
SOFTWARE _ UPDATE (NETWORK)	Software Update In the case of a NETWORK device.
SOFTWARE INFORMATION	Check Module Software Version NetReady Device ID.

How to turn the Text-to-Speech (TTS) voice guide on or off?

- Press "MENU" key on the remote control
- Turn the GENERAL menu.
- Select "OTHER SETTING"
- Select "Accessibility"
- Select "Voice Guide" and turn it on or off.

www.elementelectronics.com

CUSTOMIZING TV SETTINGS

Picture Settings

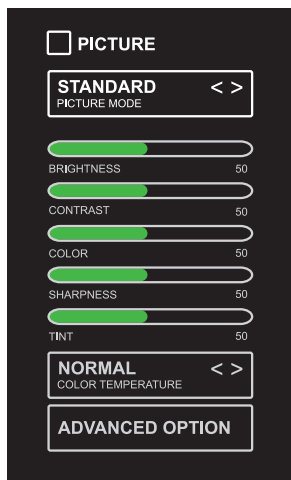

- Press **MENU** to display the main interface, then use the **Arrow** buttons to highlight **TV Settings** and press **OK** to confirm. Use the **Arrow** buttons to cycle among different options and select **Picture** to enter and adjust each option setting.

PICTURE MODE	<i>Cycle among picture modes: Dynamic/Standard/Movie/User. Alternative: Press P.MODE button on remote control to set the picture mode directly.</i>
BRIGHTNESS	<i>Increase or decrease the amount of white in the picture.</i>
CONTRAST	<i>Adjust the difference between light and dark levels in the pictures.</i>
COLOR	<i>Control the color intensity.</i>
SHARPNESS	<i>Adjust crispness level in edges between light and dark areas of the picture.</i>
TINT	<i>Adjust the balance between red and green levels.</i>
COLOR TEMPERATURE	<i>Cycle among color temperatures: Normal/Warm/COOL.</i>
ADVANCED OPTION	<i>Set the following options: Noise Reduction: Reduce the noise level of the connected device: OFF/WEAK/MEDIUM/STRONG. White Balance: To set the different options of white balance. Red Gain/Green Gain/Blue Gain/Red Offset/Green Offset/Blue Offset. Backlight: To set the value of backlight.</i>

CUSTOMIZING TV SETTINGS

Audio Settings

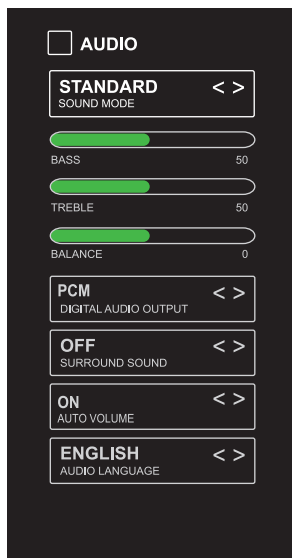

- Press **MENU** to display the main interface, then use the **Arrow** buttons to highlight **TV Settings** and press **OK** to confirm. Use the **Arrow** buttons to cycle among different options and select **Audio** to enter and adjust each option setting.

SOUND MODE	Allow the selection of an audio-enhancement technique: Standard/Music/Movie/User.
BASS	Control the relative intensity of lower-pitched sounds.
TREBLE	Control the relative intensity of higher-pitched sounds.
BALANCE	Adjust the relative volume of the speaker in a multiple speaker system.
DIGITAL AUDIO OUTPUT	Select the digital audio output mode between PCM/RAW.
SURROUND SOUND	Turn On/Off to provide an enhanced listening experience.
AUTO VOLUME	Turn On/Off to automatically control volume levels.
AUDIO LANGUAGE	Select audio language among: English, French, Spanish.

Network Settings

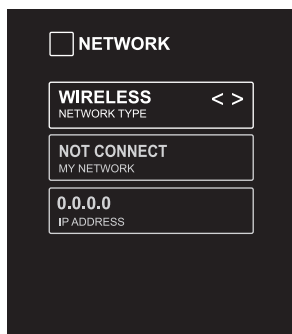

- Press **MENU** to display the main interface, use the **Arrow** buttons to highlight **TV SETTINGS** and press **OK** to confirm. Then Use the **Arrow** buttons to select **NETWORK** to enter and adjust each option setting.

NETWORK TYPE	Select Wired and Wireless network, then connect the TV to the wired network or search the wireless network through searching available Wifi.
MY NETWORK	Display the current network which you connect to.
IP ADDRESS	Display the current IP information.

CUSTOMIZING TV SETTINGS

Channel Settings

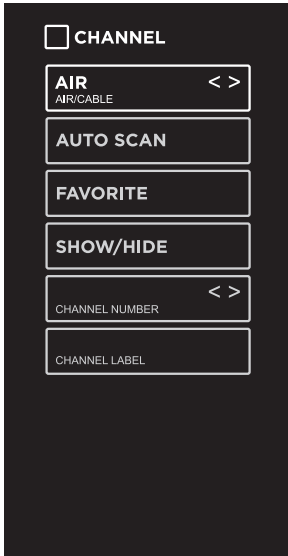

- Press **MENU** to display the main interface, then use the **Arrow** buttons to highlight **TV Settings**. Use the **Arrow** buttons to cycle among different options and select **Channel** to enter and adjust each option setting.

AIR/CABLE	Select antenna between Air and Cable.
AUTO SCAN	Select the Auto Scan feature to scan your available Air and cable channels.
FAVORITE	Set the selected channel as a favorite channel.
SHOW/HIDE	Show/Hide the selected channel.
CHANNEL NUMBER	Display the current channel number.
CHANNEL LABEL	Display the current channel label.

Time Settings

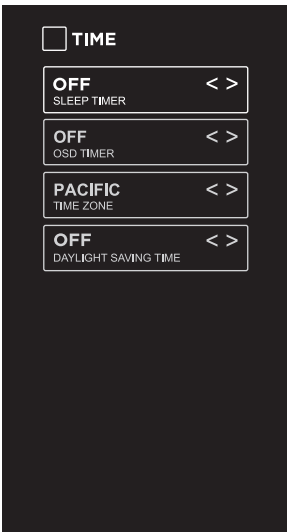

- Press **MENU** to display the main interface, then use the **Arrow** buttons to highlight **TV Settings** and press **OK** to confirm. Use the **Arrow** buttons to cycle among different options and select **Time** to enter and adjust each option setting.

SLEEP TIMER	Select a period of time after which the TV automatically switches to standby mode: Off/5/10/.../180/240 min.
OSD TIMER	Set the OSD timer: Off/15s/30s/60s/120s/240s.
TIME ZONE	Select a Time Zone: PACIFIC/ALASKA/HAWAII/NEWFOUNDLAND/ATLANTIC/EASTERN/CENTRAL/MOUNTAIN.
DAYLIGHT SAVING TIME	Select to turn daylight saving time On/Off.

CUSTOMIZING TV SETTINGS

Lock Settings

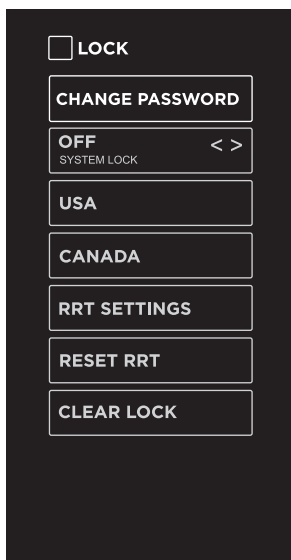

- Press **MENU** to display the main interface, then use the **Arrow** buttons to highlight **TV Settings**. Use the **Arrow** buttons to cycle among different options and select **Lock** to enter and adjust each option setting.

Note: the default password is "0000".

CHANGE PASSWORD	Use 0-9 buttons to input the old password and then input the new 4-digit password. Re-enter new password for confirmation.	
SYSTEM LOCK	Select to turn On/Off system lock. The following options (USA, Canada, RRT Setting and Reset RRT) will only be accessible when you turn the system lock on.	
USA	TV	TV RATING: Press OK button to lock or unlock TV rating.
	MPAA	Select MPAA rating : N/A,G, PG, PG-13, R, NC-17,or X.
CANADA	Canada English	Select MPAA rating for English-speaking Canada : E, C, C8+, G, PG, 14+, 18+.
	Canada French	Select MPAA rating for Quebec Canada : E, G, 8 ans+, 13 ans+, 16 ans+, 18 ans+.
RRT SETTING	Set Rating Region Table.	
RESET RRT	Select to reset the RRT setting.	
CLEAR LOCK	Clear all lock settings.	

APP Settings



- Press **MENU** to display the main interface, then use **Arrows** to highlight **TV Settings**. Use **Arrows** to cycle among different options and select **App Settings** to enter and adjust each option setting.

DEACTIVATE APP	Deactivate Netflix and clear the account information.
DEACTIVATE APP	Deactivate Vudu and clear the account information.
ESN	Electronic Serial Number.
NETFLIX VERSION	Show Netflix Version

CUSTOMIZING TV SETTINGS

Parental Control

Press the **MENU** button on the main unit or on the remote control and then press the **▲/▼** buttons to select **LOCK** menu. Use the **0-9** buttons to input 4-digit password to enter the **LOCK** menu. If used, this option feature can "block" undesirable programming from appearing on the TV. Parental Control offers the user a wide variety of options and settings that restrict or "block" the programming that can appear on the TV. Parental Control allows the user the capability of defining which program rating they consider acceptable to the younger more sensitive viewer. It can be preset and turned either on or off by the user who specifies the secret 4-number code, the password. The number of hours blocked are specified. General audiences and children blocks should be both programmed into the TV's memory. Viewer ratings are specified for both TV and the motion picture Industry; both rating systems should be used, for complete coverage. The ratings are based on the ages of children.

Overview

To ensure complete coverage for all TV programs, (movies and regular TV shows) choose a rating for MPAA, from the selections below, as well as ratings from the TV Parental Guidelines Rating Systems below, using the Age Block option for General Audiences, and for children. In addition to those, you may wish to add additional restrictions from the content block menu, and submenus examples below.

Things to Consider before Setting up Parental Control

Determine which rating you consider acceptable to the viewer. (For example, if you choose TV-PG, more restrictive ratings will be automatically blocked; the viewer will not be able to see: TV-PG, TV-14, or TV-MA rated programming.) Do you want to block the auxiliary video source entirely? (Blocks the signal sent by the equipment, such as VCR, connected to the TV Audio/Video Input Jacks) Or leave unblocked, then choose allowable ratings. Block program "Content" based on individual parameters such as: Strong Dialog, Bad Language, Sex Scenes, Violence Scenes, or Fantasy. Violent Scenes; in Content Blk option. Select a secret password, in the Set Password option, using the numbers keys on the remote control. Do not forget the password, it is the only way you can access the Parental Control menu and change rating selections, or turn Parental Control off. Do you want the Parental Control to be active at all times? If not, you can turn it on or off with the Lock On/Off option.

- You can set different Parental Control viewing restrictions for general audiences and for children, both can be active at the same time.
- Simply specifying one content block such as Sex Scenes, will not automatically restrict the programming that appears from the video sources.
- Even if you choose to leave the AUX Inputs unblocked, the ratings you specify will automatically restrict the programming that appears from the video sources.
- You can not disable Parental Control by disconnecting the TV from power. Block hours will be automatically reset to the original block time setting specified if power is disconnected.

CUSTOMIZING TV SETTINGS

Motion Picture Association of America (MPAA) Rating System

	Grade	Meaning
G	General Audiences	Content not offensive to most viewers.
PG	Parental Guidance Suggested	Content is such that parents may not want their children to view the program.
PG-13	Parents Strongly Cautioned	Program is inappropriate for pre-teens, with a greater degree of offensive material suggested than a PG rated program.
R	Restricted	Not for children under 17, strong element of sex and/or violence.
NC-17	No children under age 17	Not for children under 17 under any circumstances. Strong sexual content.
X	Hard Core Films	Same as NC-17 rating.
No Rating	No Rating	MPAA Not Rated

TV Parental Guideline Rating System

	Grade	Meaning
TV-Y	All Children	Content not offensive to most viewers.
TV-Y7	Directed to Older Children	Considered suitable for children over 7, may contain fantasy violence scenes.
TV-G	General Audience	Considered suitable for all audience; children may watch unattended.
TV-PG	Parental Guidance Suggested	Suggested unsuitable for younger children, may contain suggestive language, bad language, sex and violence scenes.
TV-14	Parents Strongly Cautioned	unsuitable for children under 14, may contain strong language, bad language, sex and violence scenes.
TV-MA	Mature Audience Only	Adults only, may contain strong language, bad language, sex and violence scenes.

Canadian Rating:

- Canadian English is used throughout all English-speaking Canada (C, C8+, G, PG, 14+, 18+).
- Canadian French is used in Quebec (G, 8 ans+, 13 ans+, 16 ans+, 18 ans+).



The V-Chip will automatically block certain categories that are "more restrictive". If you block TV-Y category, then TV-Y7 will be automatically blocked. Similarly, if you block TV-G category, then all the categories in the "young adult" will be blocked (TV-G, TV-PG, TV-14, and TV-MA).

TROUBLESHOOTING

If your TV does not operate normally or cannot be turned on, please check the following troubleshooting questions. Remember also to check any other connected electronic device, such as DVD or blu-ray player to pinpoint the problem. If the TV still fails to operate normally, please contact technical support (Refer to Warranty page).

SYMPTOM	POSSIBLE CAUSE	REMEDY
Dead. No LED lit	No power to the TV.	<ul style="list-style-type: none"> Check all connections to the TV's AC socket.
Dead. No LED lit red	Set in standby mode.	<ul style="list-style-type: none"> Press either the Power button or the Standby button on the remote control.
Blue screen	No signal.	<ul style="list-style-type: none"> Press the SOURCE button to select the correct source.
	Incorrect source selected.	
Noisy, snowy, ghosting picture (TV)	Poor antenna signal.	<ul style="list-style-type: none"> If using an indoor antenna, try adjusting the antenna position. Check antenna connections.
No sound	Sound "Mute".	<ul style="list-style-type: none"> Turn sound "Mute" off.
	Volume set too low.	<ul style="list-style-type: none"> Check volume settings.
	External leads not connected "if used".	<ul style="list-style-type: none"> Check that all external leads are connected properly.
PASSWORD		
Lost password	Select the SET Password setting in the LOCK menu, then enter the following master password "8899". The master password clears your previous password and allows you to enter a new password.	

TROUBLESHOOTING

Before contacting the service technician, perform the following simple checks. If any problem still persists, unplug the LED TV and call for assistance.

PROBLEM	POSSIBLE SOLUTIONS
No sound and picture	<ul style="list-style-type: none"> • Check that the main plug has been connected to a wall outlet. • Check that you have pressed the POWER on the front of the TV set. • Check the picture contrast and the brightness setting.
Red LED indicator lights	<ul style="list-style-type: none"> • Set in standby mode. Press either the Power button or the Standby button on the remote control.
Normal picture but no sound	<ul style="list-style-type: none"> • Check the volume. • Sound muted? Press the MUTE button. • Try another channel, the problem may be with the broadcast. • Are the audio cables installed properly?
The remote control does not work	<ul style="list-style-type: none"> • Check to see if there are any objects between the TV and remote control causing obstruction. • Are batteries installed with correct polarity (+/-)? • Correct remote operating mode set: TV, VCR, etc? • Install new batteries.
Power suddenly turns off	<ul style="list-style-type: none"> • Is the sleep timer set? • Check the power connection, power may be interrupted. • No broadcast on the station tuned.
Picture appears slowly after switching on	<ul style="list-style-type: none"> • This is normal, the image is muted during the product start up process. Please contact a service provider if the picture has not appeared after 5 minutes.
Poor color or picture	<ul style="list-style-type: none"> • Adjust the color in Menu option. • Keep a sufficient distance between the product and the VCR. • Try another channel, the problem may be with the broadcast. • Are the VIDEO cables installed properly? • Activate any function to restore the brightness of the picture.
Horizontal/vertical bars or picture shaking	<ul style="list-style-type: none"> • Check for local interference, such as an electrical appliance or power tool.
Blue screen	<ul style="list-style-type: none"> • Press the SOURCE button to select correct source.
Poor reception on some channels	<ul style="list-style-type: none"> • Station or cable experiencing problems. Tune to another station. • Station signal is weak, reorient antenna for better reception. • Check for sources of possible interference.
Lines or streaks in pictures	<ul style="list-style-type: none"> • Check the antenna (change the direction of the antenna).
No output from one of the speakers	<ul style="list-style-type: none"> • Adjust balance in the Menu option.

TROUBLESHOOTING

Note: When there is a problem in VGA mode (only when VGA mode is applied).

PROBLEM	POSSIBLE SOLUTIONS
The signal is out of range	<ul style="list-style-type: none">• Adjust resolution, horizontal or vertical frequency.• Check whether the signal cable is connected or loose.• Check the input source.
Vertical bar or strip on the background, horizontal noise and incorrect position	<ul style="list-style-type: none">• Set the auto configure or adjust clock, phase, or H/V position.
Screen color is unstable or is a single color	<ul style="list-style-type: none">• Check the signal cable.• Reinstall the PC video card.

Maintenance

Early malfunction can be prevented. Careful and regular cleaning can extend the amount of time you will have with your new TV. Be sure to turn the power off and unplug the power cord before you begin any cleaning.

Do not use your TV in areas that are too hot or too cold, because the cabinet may warp or the screen may malfunction. Your TV works best in temperatures that are comfortable to you.

Storage temperatures are 32° to 122°F(0° to 50°C).

Working temperatures are 32° to 95°F(0° to 35°C).

Do not place your TV in direct sunlight or near a heat source.

-minimum 5cm distances around the apparatus for sufficient ventilation;

-the ventilation should not be impeded by covering the ventilation openings with items, such as newspapers, table-cloths, curtains, etc.;

-no naked flame sources, such as lighted candles, should be placed on the apparatus;

-attention should be drawn to the environmental aspects of battery disposal.

Clean the screen

A great tip to dust off your screen: wet a soft cloth in a mixture of lukewarm water and a little fabric softener or dish washing detergent. Wring the cloth until it's almost dry, and then use to wipe the screen.

Make sure the excess water is off the screen, then let air-dry before you turn on the TV.

Cleaning the cabinet

To remove dirt or dust, wipe the cabinet with a soft, dry, line-free cloth. Please be sure not to use a wet cloth.



FCC STATEMENT

This device complies with Part 15 of the FCC Rules. Operation is subject to the following two conditions:

- (1) This device may not cause harmful interference, and
- (2) This device must accept any interference received, including interference that may cause undesired operation.

Changes or not expressly approved by the party responsible for compliance could void the user's authority to operate the equipment.

NOTE: This equipment has been tested and found to comply with the limits for a Class B digital device, pursuant to Part 15 of the FCC Rules. These limits are designed to provide reasonable protection against harmful interference in a residential installation.

This equipment generates uses and can radiate radio frequency energy and, if not installed and used in accordance with the instructions, may cause harmful interference to radio communications. However, there is no guarantee that interference will not occur in a particular installation. If this equipment does cause harmful interference to radio or television reception, which can be determined by turning the equipment off and on, the user is encouraged to try to correct the interference by one or more of the following measures:

Reorient or relocate the receiving antenna.

Increase the separation between the equipment and receiver.

Connect the equipment into an outlet on a circuit different from that to which the receiver is connected.

Consult the dealer or an experienced radio/TV technician for help.

FCC Radiation Exposure Statement

This equipment complies with FCC radiation exposure limits set forth for an uncontrolled environment. This equipment should be installed and operated with minimum distance 20cm between the radiator & your body.

For customer support: 1-888-842-3577

Please send all correspondence to:

Element TV Company, LP. Customer Service

customerservice@elementelectronics.com

www.elementelectronics.com

OTT APP SERVICE

If you want to know about these APP information or get more service. Please refer to following content.

- Netflix



You can call the following telephone for more help: [866-579-7172](tel:866-579-7172)

If your matter is regarding customer service, please refer to <https://contactus.netflix.com/help> for alternative contact information.

- YouTube



You can browse the following website for more help:

<https://productforums.google.com/forum/#!categories/youtube/smart-tvs>

- VUDU



You can call the following telephone for more help: [888-554-8838](tel:888-554-8838)

- Pandora



You can send E-mail to Pandora for more help: pandora-support@pandora.com

- AccuWeather



You can send E-mail to AccuWeather for more help: CustomerService@AccuWeather.com



This product contains electrical or electronic materials. The presence of these materials may, if not disposed of properly, have potential adverse effects on the environment and human health. Presence of this label on the product means it should not be disposed of as unsorted waste and must be collected separately. As a consumer, you are responsible for ensuring that this product is disposed of properly.