

OPERATING INSTRUCTIONS

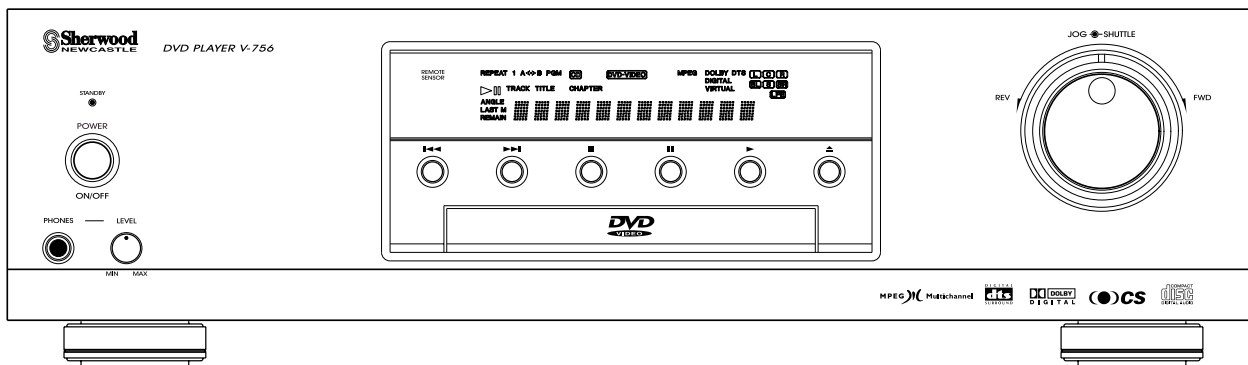

V-756

DVD PLAYER

Introduction

UNPACKING AND INSTALLATION

Congratulations on Your Purchase!

Your new DVD Player is designed to deliver maximum enjoyment and years of trouble free service. Please take a few moments to read this manual thoroughly. It will explain the features and operation of your unit and help ensure a trouble free installation.

Please unpack your unit carefully. We recommend that you save the carton and packing material. They will be helpful if you ever need to move your unit and may be required if you ever need to return it for service. Your unit is designed to be placed in a horizontal position and it is important to allow at least two inches of space behind your unit for adequate ventilation and cabling convenience.

To avoid damage, never place the unit near radiators, in front of heating vents, in direct sunlight, in excessively humid, dusty locations or near sources of strong magnetic fields. Connect your complementary components as illustrated in the following section.

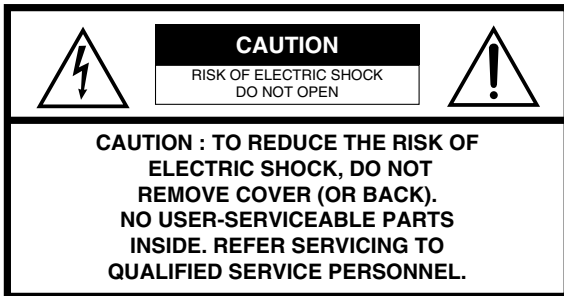

This symbol is intended to alert the user to the presence of uninsulated "dangerous voltage" within the product's enclosure that may be of sufficient magnitude to constitute a risk of electric shock to persons.



This symbol is intended to alert the user to the presence of important operating and maintenance (servicing) instructions in the literature accompanying the appliance.

WARNING

To prevent fire or shock hazard, do not expose this unit to rain or moisture.

**CLASS 1
LASER PRODUCT**

CAUTION

Invisible laser radiation when the unit is open. Do not stare into beam

CAUTION : USE OF ANY CONTROLS, ADJUSTMENTS, OR PROCEDURES OTHER THAN THOSE SPECIFIED HEREIN MAY RESULT IN HAZARDOUS RADIATION EXPOSURE.

FOR U.S.A.

■ FCC INFORMATION

This equipment has been tested and found to comply with the limits for a Class B digital device, pursuant to Part 15 of the FCC Rules. These limits are designed to provide reasonable protection against harmful interference in a residential installation. This equipment generates, uses and can radiate radio frequency energy and, if not installed and used in accordance with the instructions, may cause harmful interference to radio communications. However, there is no guarantee that interference will not occur in a particular installation. If this equipment does cause harmful interference to radio or television reception, which can be determined by turning the equipment off and on, the user is encouraged to try to correct the interference by one or more of the following measures:

- Reorient or relocate the receiving antenna.
- Increase the separation between the equipment and receiver.
- Connect the equipment into an outlet on a circuit different from that to which the receiver is connected.
- Consult the dealer or an experienced radio/TV technician for help.

CAUTION: Any changes or modifications in construction of this device which are not expressly approved by the party responsible for compliance could void the user's authority to operate the equipment.

PRECAUTIONS

- **Moisture condensation**
Moisture may form on the lens in the following conditions.
 - Immediately after a heater has been turned on.
 - In a steamy or very humid room.
 - When this unit is moved from a cold place to a warm one.
If moisture forms inside this unit, it may not operate properly.
In this case, turn on the power and wait about one hour for the moisture to evaporate.
- If there is noise interference on the TV while a broadcast is being received.
Depending on the reception condition of the TV, interference may appear on the TV screen while you are watching a TV broadcast and this unit is left on. This is not a malfunction of this unit or the TV. To watch a TV broadcast, turn off this unit.
- Do not transport this unit with a disc left in it.

READ THIS BEFORE OPERATING YOUR UNIT

FOR U.S.A. AND CANADA 120 V

FOR YOUR SAFETY

Units shipped to the U.S.A. and Canada are designed for operation on 120 V AC only.

Observe all safety precautions with use of a polarized AC plug.

However, some products may be supplied with a nonpolarized plug.

CAUTION : To prevent electric shock, match wide blade of plug to wide slot, insert fully.

FOR CHINA, EUROPE AND AUSTRALIA 220V/230V/240 V

FOR YOUR SAFETY

Units shipped to China are designed for operation on 220 V AC only.

Units shipped to Australia are designed for operation on 240 V AC only.

To ensure safe operation, the three-pin plug supplied must be inserted only into a standard three-pin power point which is effectively earthed through the normal household wiring. Extension cords used with the equipment must be three-core and be correctly wired to provide connection to earth. Improper extension cords are a major cause of fatalities. The fact that the equipment operates satisfactorily does not imply that the power point is earthed and that the installation is completely safe. For your safety, if in any doubt about the effective earthing of the power point, consult a qualified electrician.

PAN-EUROPEAN UNIFIED VOLTAGE

All units are suitable for use on supplies 230-240 V AC.

FOR OTHER COUNTRIES 115 V/230 V

FOR YOUR SAFETY

Units shipped to countries other than the above countries are equipped with an AC voltage selector switch on the rear panel. Refer to the following paragraph for the proper setting of this switch.

AC VOLTAGE SELECTION

This unit operates on 115 / 230 V AC. The AC voltage selector switch on the rear panel is set to the voltage that prevails in the area to which the unit is shipped. Before connecting the power cord to your AC outlet, make sure that the setting position of this switch matches your line voltage. If not, it must be set to your voltage in accordance with the following direction.

AC voltage selector switch

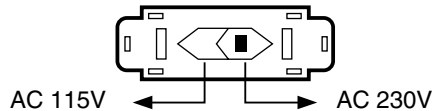

Move switch lever to match your line voltage with a small screwdriver or other pointed tool.

CONTENTS

Introduction

- UNPACKING AND INSTALLATION 2
- READ THIS BEFORE OPERATING YOUR UNIT 3

System Connections

- CONNECTING TO A/V AMPLIFIER OR RECEIVER 5
- CONNECTING TO TV WITH AUDIO AND VIDEO INPUTS 7
- CONNECTING TO ADDITIONAL COMPONENT WITH VIDEO AND DIGITAL OUTS 7
- CONNECTING SYSTEM CONTROL 8
- CONNECTING TO TV AND VCR WITH SCART CONNECTORS (Regional Option) 9

Front Panel & Remote Controls 10

- REMOTE CONTROL OPERATION RANGE 12
- LOADING BATTERIES 12

Preliminary Knowledge About Discs

- PLAYABLE DISC TYPES 13
- NOTES ON DVD VIDEOS 13
- NOTES ON COPYRIGHT 13
- SYMBOL AND MESSAGE ABOUT INVALID OPERATION 14
- CARE AND HANDLING OF DISCS 14

Operartions

- BASIC PLAYBACK 15
- GENERAL INFORMATION ABOUT ON-SCREEN SYMBOLS 18
- PLAYING THE DESIRED SECTION OF DISC (TITLE/CHAPTER/TRACK/TIME SEARCH) 19
- PLAYING A SPECIFIC ITEM [DVD Video only] 20
- REPEAT PLAYBACK 21
- INTROSCAN PLAYBACK [CD only] 22
- CHANGING THE TIME DISPLAY DURING PLAYBACK 22
- CHANGING THE CAMERA ANGLE [DVD Video only] 23
- CHANGING THE AUDIO LANGUAGE [DVD Video only] 23
- CHANGING THE SUBTITLE LANGUAGE [DVD Video only] 24
- PLAYING A SCENE CLOSE-UP [DVD Video only] 25
- LISTENING WITH HEADPHONES 26

Initial Settings 27

- SETTING THE SYSTEM 29
- SETTING THE LANGUAGE 30
- SETTING THE TV SCREEN 31
- SETTING THE AUDIO SETUP 32
- SETTING THE CUSTOM SETUP 36
- SETTING THE RATING LEVEL 39
- SETTING THE DISC SETUP 40

Definition Of Terms 44

Troubleshooting Guide 45

Specifications 46

DVD Language Code List 47

System Connections

- Please make all connections to this DVD player **before** plugging in the AC cord.
- Since different components may have different names for the same inputs and outputs, carefully read the operating instructions of any component to be connected to this player.
- Please follow all color coding when making the audio and video connections.
- The video output of this player can be optimized to fit your TV screen. Please select either 4:3 or 16:9. (refer to "SETTING THE TV SCREEN" on page 31.)

CONNECTING TO AN A/V AMPLIFIER OR RECEIVER

- The Sherwood Newcastle V-756 DVD Player/Decoder is a very versatile unit.
- Because it has built-in decoding for DTS, Dolby Digital, Dolby Pro Logic, Dolby Virtual, Circle Surround, MPEG Multichannel and 6.1 Extended surround it can be used with 5.1 (or 6.1) ready amplifiers and receivers that do not have their own decoders built-in.
- Because it also has coaxial and optical digital outputs, it can also pass the digital data stream to an external decoder or to amplifier or receiver that has built-in digital decoders.
- It can even be used as a high quality multi-channel digital decoder for other source components such as satellite TV receiver or HDTV tuner.
- Follow the enclosed instructions to add the V-756 to your system.

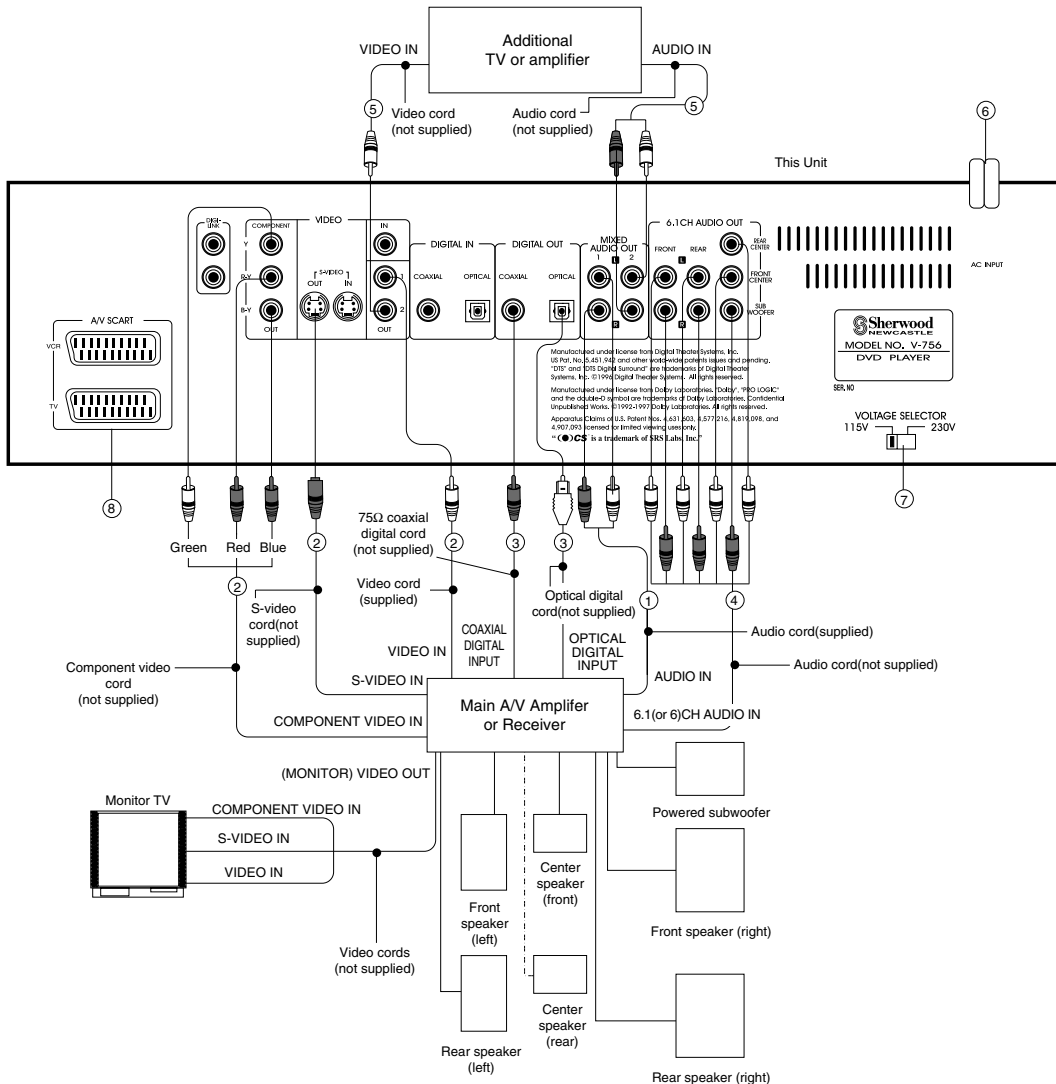

1. Connecting MIXED AUDIO OUTs 1

Connect these jacks to the DVD (, AUX, etc.) IN jacks of your amplifier or receiver.

Notes :

- While playing back a disc containing multi-channel signal format such as DTS, Dolby Digital and MPEG Multichannel with this connection, the 5 discrete channels (front L, center, front R, rear L and rear R) are mixed down to these front and headphone channels.
- If the MIXED AUDIO OUT connection is made, only two front speakers are required.

2. Connecting VIDEO OUT's

This DVD Player has 3 kinds of Video Outputs :
Component Video, S-Video and Composite Video.

If your receiver or amplifier has both VIDEO INPUT jacks and VIDEO (MONITOR) OUTPUT jacks, connect these VIDEO OUTS to the corresponding VIDEO IN jacks of your amplifier or receiver and the receiver' MONITOR OUTPUT jacks to the corresponding input jacks on your TV. If your amplifier or receiver does not have the necessary input and output jacks, connect these jacks directly to the VIDEO IN jacks of the TV. (Refer to "CONNECTING TO TV WITH AUDIO AND VIDEO INPUTS" on the next page.)

- When making COMPONENT VIDEO connections, connect "Y" to "Y", "R-Y" to "R-Y" (or "P_R"), "B-Y" to "B-Y" (or "P_B")
- For your reference, video picture quality is usually rated as follows :
"COMPONENT" > "S-VIDEO" > "COMPOSITE"

NOTE : Do not connect this unit to your TV through a VCR. The copy protection function built into DVD software may interfere with the picture.

3. Connecting DIGITAL OUTs

If your amplifier or receiver has built-in digital decoders or if you wish to make direct connection to an MD or CD recorder, connect the COAXIAL and/or OPTICAL DIGITAL OUTPUTS to the corresponding DIGITAL INPUTS of the associated device(s).

Notes :

- You must select the appropriate digital output mode on this DVD player before trying to use it with an outboard amplifier or receiver via the digital connections. Otherwise, operation with the incorrect digital mode may result in a loud noise through your speakers that could damage the speakers and/or our hearing. (For details, refer to "When selecting the DIGITAL OUTPUT" on page 32.)
- Recordings of DVD software made via the digital connection on an MD or CD recorder may not be made properly.
- When making the COAXIAL DIGITAL connections, use 75 Ohm coaxial cable not standard audio patch cords.
- Not all of the commercially available optical cables are suitable for use with audio equipment. If you have any questions regarding the appropriateness of any cable, please consult your dealer or a professional service organization.
- Remove the protective cap before making any OPTICAL DIGITAL connections. Re-install the cap when you will not be using the OPTICAL INS or OUTS.

4. Connecting the 6.1 CH AUDIO OUTs

This DVD player has built-in multi-channel digital decoders for DTS, Dolby Digital, Dolby Pro Logic, MPEG Multichannel and Circle Surround including the 6.1 Extended Surround versions of both DTS and Dolby Digital so you can enjoy high-quality audio and surround sound without the need for an external decoder.

Connect these jacks to the corresponding 6.1 (or 6) channel inputs of your amplifier or receiver.

Notes :

- If your amplifier or receiver has only 6 channel direct inputs, do not hook up the REAR CENTER OUTPUT.
- In that case, you can run the REAR CENTER OUTPUT to a separate amplifier or powered speaker. With such a hook-up, however, you will have limited ability to control the rear center speaker level as this DVD player does not have a master volume control. Center Rear volume trim is limited to +/- 12 dB compared to the other channels. If you need more volume adjustment capability, it should come from the associated amplifier or powered speaker.
- When using the 6.1 CH Audio Outs, adjustments for speaker set-up, bass management, dynamic range control, and surround sound mode should be made from this DVD player and not from your amplifier or receiver. (Refer to "When selecting the Dynamic Range Control", when selecting the SURROUND" and "When selecting the SPEAKER OPTIONS" on pages 33-34.)

5. Connecting to an additional amplifier or TV set

This unit incorporates additional audio and video outputs such as (composite) VIDEO OUT 2 and MIXED AUDIO OUT 2 for use with a second TV or amplifier.

- To connect these jacks correctly, refer to "Connecting MIXED AUDIO OUT's 1" and Connecting VIDEO OUTs" described above.

6. AC INPUT CORD

When all connections are made, plug this cord into an AC outlet.

7. VOLTAGE SELECTOR SWITCH (Optional by region)

In some countries, this unit operates on AC 115V or AC 230V. If your unit has this capability, set the VOLTAGE SELECTOR switch to match your line voltage before connecting the AC input cord to an AC outlet.

8. A/V SCART CONNECTORS (Regional Option)

Refer to "CONNECTING TO TV AND VCR WITH SCART CONNECTORS (Regional Option)" on page 9.

CONNECTING TO TV WITH AUDIO AND VIDEO INPUTS

- You can enjoy DVD Videos by simply connecting this unit to a TV. To hear improved audio sound quality, connect the MIXED AUDIO OUTs 1 to your amplifier or receiver.
- To connect these jacks correctly, refer to “Connecting MIXED AUDIO OUTs 1” and “Connecting VIDEO OUTs” on the previous page.

Note :

- If your TV has only a monaural audio input instead of stereo, you will need to use an optional audio cord which converts stereo audio output to monaural.
- Do not connect the VIDEO OUTs of the unit to the TV through a VCR. Otherwise the image may be disturbed due to the copy protection built into the DVD software.

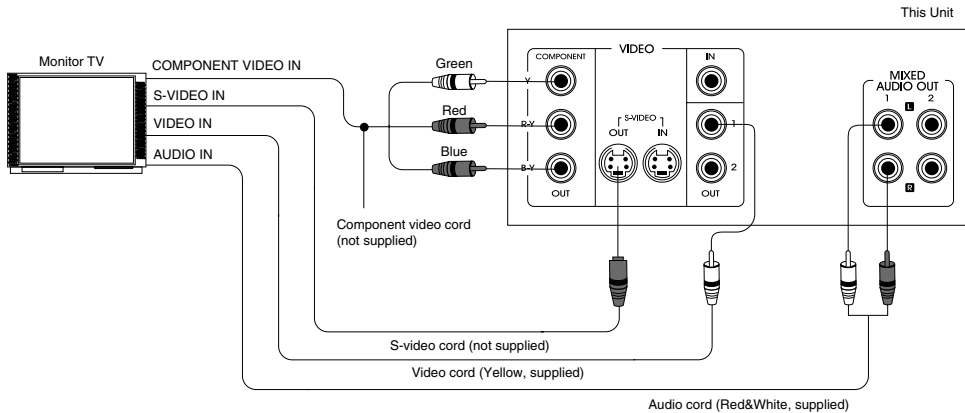

CONNECTING TO ADDITIONAL COMPONENT WITH VIDEO AND DIGITAL OUTS

- When these VIDEO and DIGITAL INs are connected to the corresponding VIDEO and DIGITAL OUTs of additional DVD player, etc., you can also enjoy high-quality audio and surround by using the built-in DTS/Dolby Digital/MPEG Multichannel decoder of this unit. If this is the case, be sure to connect the 6.1 CH AUDIO OUTs (and MIXED AUDIO OUTs) to your amplifier or receiver.
- When you connect the additional equipment with a digital output, before using, change the SYSTEM setting according to the type of the DIGITAL OUT jack of the equipment connected. (Refer to “SETTING THE SYSTEM” on page 29.)
- The digital audio signal from either the OPTICAL or the COAXIAL DIGITAL IN can be directly transferred to both of the DIGITAL OUTs of this unit. If this is the case, be sure to connect these DIGITAL OUTs to your amplifier, etc.
- A signal from the S-VIDEO IN can be directly transferred to only the S-VIDEO OUT and a signal from the regular VIDEO IN to only the regular VIDEO OUTs 1 and 2.
- Depending on your use, the unit’s settings should be set properly. With DIGITAL OUT connections, the DIGITAL OUTPUT setting should be made from this unit and with 6.1 CH AUDIO OUT connections, settings for “D · R · C”, “SURROUND” and “SPEAKER OPTIONS” on the AUDIO SETUP menu should be made.
- For correct connection and use, refer to “Connecting DIGITAL OUTs” and “Connecting 6.1 CH AUDIO OUTs” on the previous page.
- The audio component such as CD player, etc. can be also connected to these DIGITAL INs only, not the VIDEO INs.

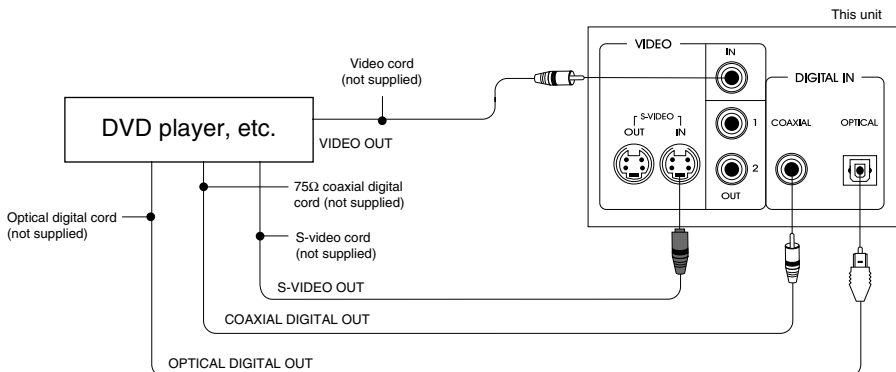

CONNECTING SYSTEM CONTROL

- Connect this jack to the DIGI LINK jack of some Sherwood receivers such as RV-5106/R, RD-6106/R, RD-7106/R, R-756/R, R-956/R, etc. that uses the DIGI LINK III remote control system.
(For details, refer to the operating instructions of that unit.)
- When connecting this jack to the DIGI LINK jack of some Sherwood receivers such as RV-5106/R, RD-6106/R, RD-7106/R, R-756/R, R-956/R, etc., only this unit does not respond to system power control due to the auto play feature.

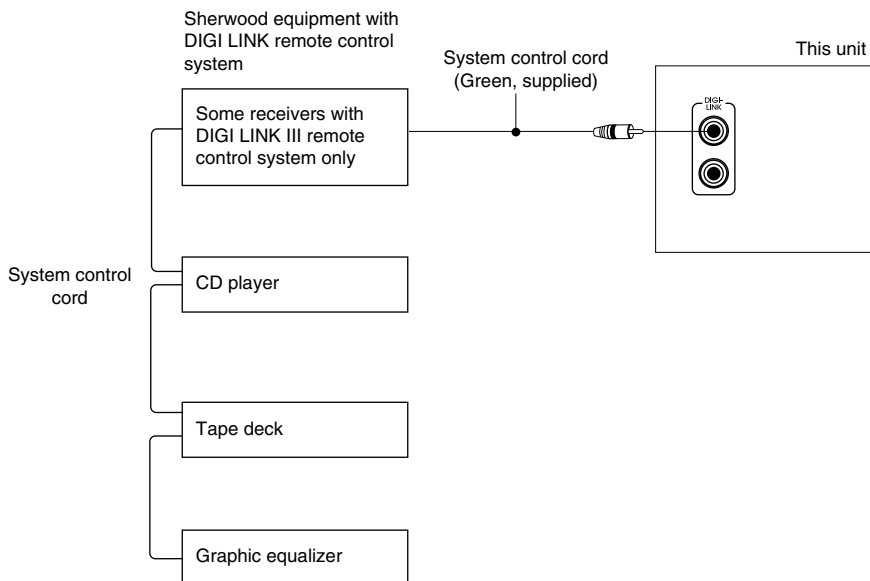

CONNECTING TO TV AND VCR WITH SCART CONNECTORS (Regional Option)

- For some countries like Europe, the unit incorporates the TV and VCR SCART connectors.
- You can connect the unit to TV and VCR easily using the SCART connections without other cumbersome audio and video connections.
- During operation of the unit, these connectors can deliver either the regular video and RGB signals or the S-video (Y and C) signals as well as the mixed audio L and R signals.
- To obtain the highest picture quality, you can make the COMPONENT VIDEO connections between the unit and TV.
- Depending on the video signal(s) to be used, adjust the COMPONENT VIDEO and SCART OUTPUT settings to your preference and set your TV and VCR to the corresponding one to match the selected settings of the unit.
(Refer to “When selecting the COMPONENT VIDEO (Regional Option)” on page 37, “When selecting the SCART OUTPUT (Regional option)” on page 38 and the operating instructions of the component(s) connected.)

Note

- In this connection, do not connect the unit to the TV through a VCR. Otherwise the image may be disturbed due to the copy protection function.

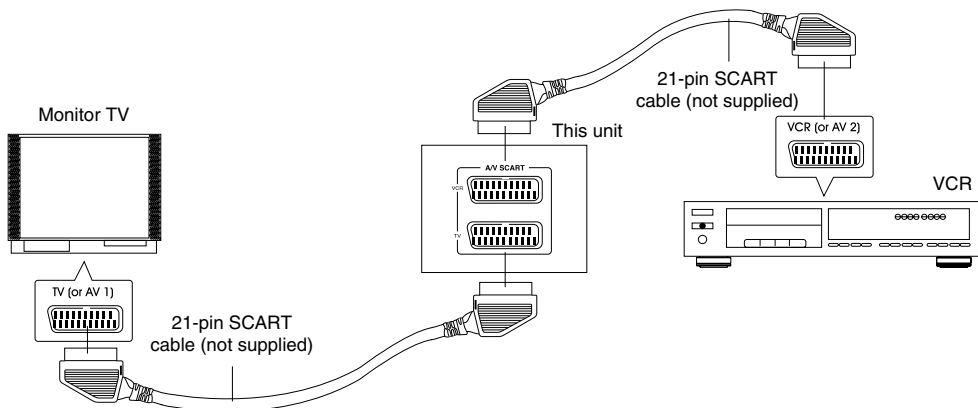

- In this connection, to view a program source from the VCR on the TV screen or to record a TV broadcast onto the VCR, be sure to turn the unit off to enter the standby mode.

Front Panel & Remote Controls

ENGLISH

Front Panel Controls

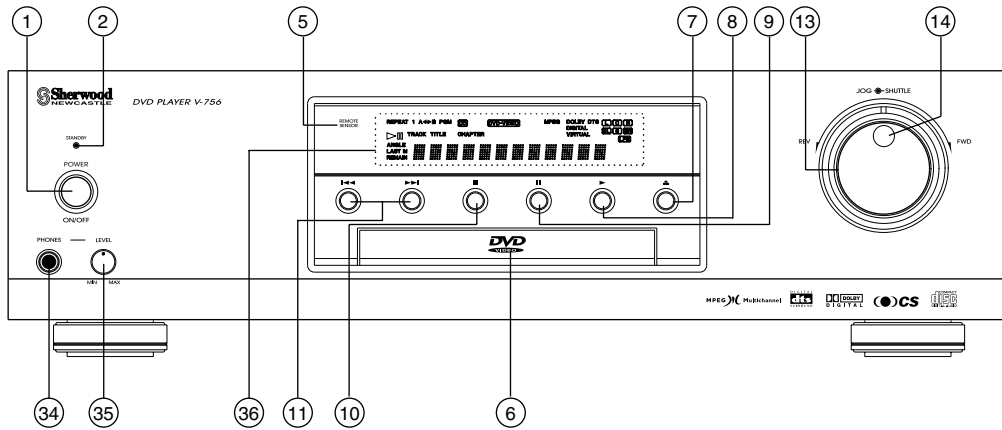

Remote Controls

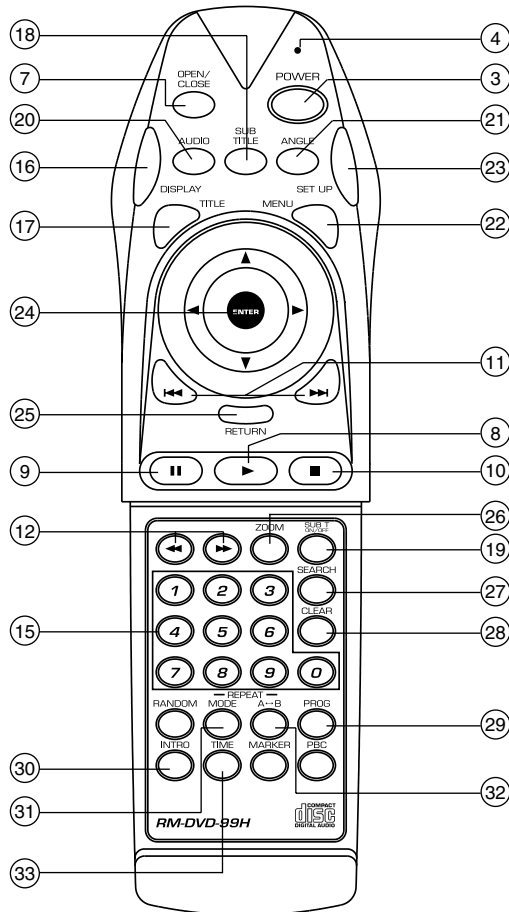

1. POWER SWITCH

Press to turn the power of the unit between the standby and off modes.

2. STANDBY indicator.

Lights up in the standby mode and goes off in power on mode.

3. POWER BUTTON

Press to turn the power of the unit from power on to standby or vice versa.

4. LED LAMP**5. REMOTE SENSOR****6. DISC TRAY**

Load the disc to be played on the tray.

7. OPEN/CLOSE (▲) BUTTON

Press to open or close the disc tray.

8. PLAY (▶) BUTTON

Press to start playback.

9. PAUSE (||) BUTTON

Press to pause playback temporarily.

- In the pause mode, press to advance the picture of DVD Videos frame by frame.

10. STOP (■) BUTTON

Press to stop playback.

11. FORWARD/BACKWARD (▶▶/◀◀) SKIP BUTTONS

Press either button to skip chapters/tracks or locate the beginning of a chapter/track.

12. FORWARD/BACKWARD (▶▶/◀◀) SEARCH BUTTONS

Press either button to fast forward or reverse a chapter or track and to play back DVD Videos slowly.

13. SHUTTLE RING

Rotate in either direction to fast forward or reverse a chapter or track.

14. JOG DIAL

In the still picture mode, rotate in either direction to advance or reverse the picture of DVD Video frame by frame.

15. NUMERIC (0~9) BUTTONS

Press to enter a title, chapter or track number, etc. for direct input.

16. DISPLAY BUTTON

Press to display the on-screen symbols meaning information about the disc and the unit on the TV screen.

17. TITLE BUTTON

Press to display the DVD Video title menu on the TV screen.

18. SUBTITLE BUTTON

Press to select the subtitle language on the TV screen during DVD Video playback .

19. SUBTITLE ON/OFF BUTTON

Press to switch the subtitle display on or off during DVD video playback.

20. AUDIO BUTTON

Press to select the audio language or sound during DVD Video playback.

21. ANGLE BUTTON

Press to select the camera angle during playback of a DVD Video that contains multiple camera angles.

22. MENU BUTTON

Press to display the DVD menu on the TV screen.

23. SETUP BUTTON

In the stop mode, press to adjust the initial settings of the unit on the TV screen .

24. CURSOR (▲/▼/▶/◀) / ENTER BUTTON

Tilt in the desired direction to select an item in the on-screen display or in any displayed menus and press down to execute or select that item.

25. RETURN BUTTON

Press to return to the previous menu.

26. ZOOM BUTTON

Press to enlarge a part of the scene during playback of a DVD video .

27. SEARCH BUTTON

Press to perform a title / chapter / time search during playback of a DVD Video or a track / time search during playback of a CD.

28. CLEAR BUTTON

Press to delete the current selection on the title, chapter, track, time, setup menu, etc.

29. PROGRAM BUTTON

Press to program chapters / tracks in the desired sequence.

30. INTRO BUTTON

Press to play the first 10 seconds of each track on a CD.

31. REPEAT MODE BUTTON

Press to play a single chapter / title on a DVD Video or a single track / entire disc on a CD repeatedly.

32. REPEAT A↔B BUTTON

Press to play a specific part repeatedly.

33. TIME BUTTON

Press to display the elapsed / remaining time of the title or chapter on a DVD Video or the elapsed / remaining time of the track or disc on a CD.

34. HEADPHONE JACK

Insert headphones for private listening.

35. HEADPHONE LEVEL CONTROL KNOB

Rotate to adjust the volume level of the headphones.

36. FLUORESCENT DISPLAY

For details, see the next page.

Note :

On the remote control, the RANDOM, MARKER and PBC buttons are not available for this unit.

■ FLUORESCENT DISPLAY

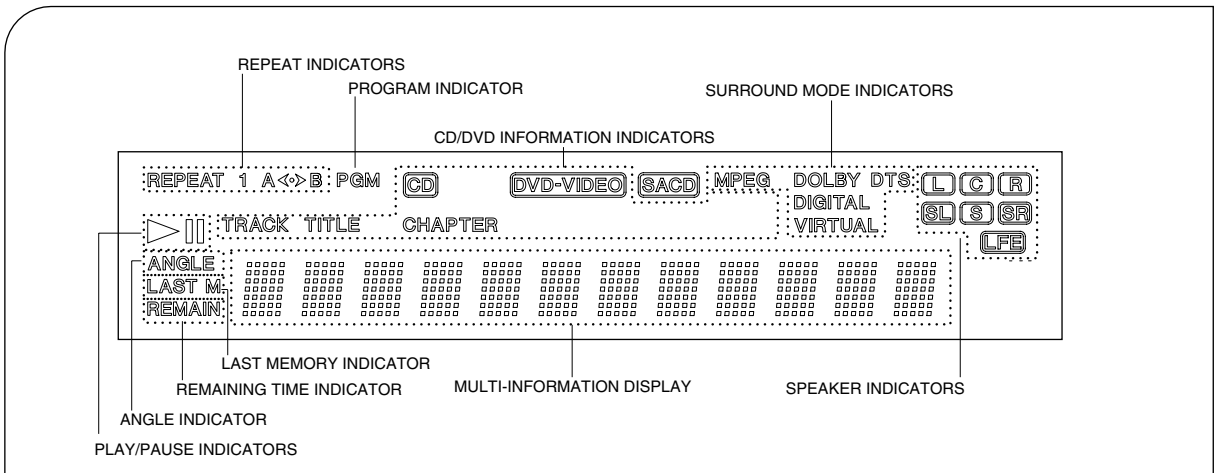

REMOTE CONTROL OPERATION RANGE

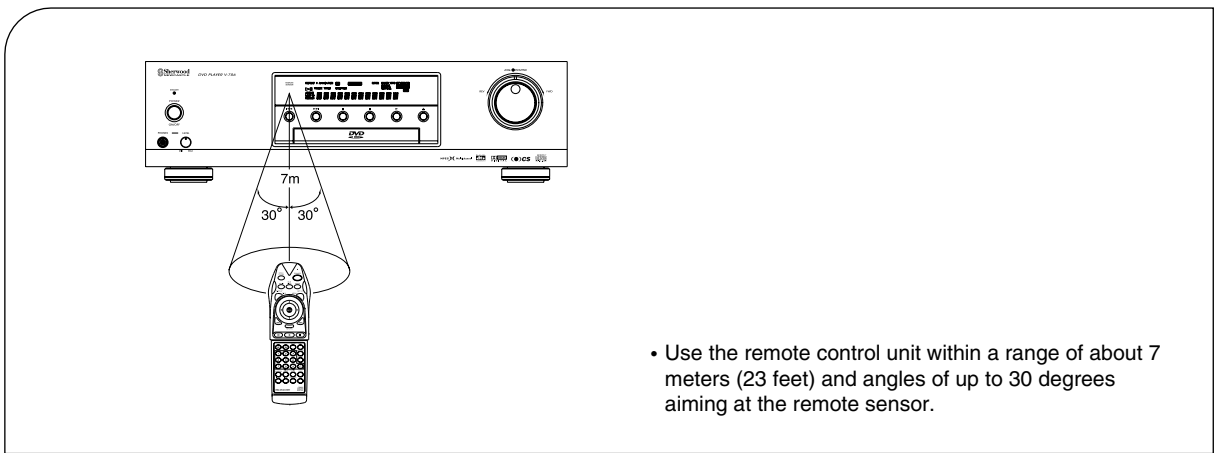

LOADING BATTERIES

1 Remove the cover.

2 Load two size "AAA" batteries matching the polarity.

- Remove the batteries when they are not used for a long time.
- Do not use rechargeable batteries(Ni-Cd type).

Preliminary Knowledge About Discs

PLAYABLE DISC TYPES

This unit can play back discs bearing any of the following marks :

	DVD VIDEO	CD
Logo mark		
Disc size	3" (8 cm) / 5" (12 cm)	3" (8 cm) / 5" (12 cm)
Played sides	One or both	One side only
Contents	Audio + Video	Audio

Notes :

- When you play back discs other than those listed above, playing back them may generate noise and damage speakers.
- Depending on the countries, this unit conforms to either the NTSC color system for U.S.A., Canada, etc. or the PAL for Europe, Australia, China, etc. It cannot play back discs with the other color systems.

NOTES ON DVD VIDEOS

■ Region code

- DVD players and DVD Videos have their own Region Code numbers which are assigned to each country or area as shown below. DVD players are set to your Region Code number at the factory. As a result, if the region code number of this DVD player is different from that of the DVD Video, playback of the DVD Video will not be allowed by the DVD player. (In this case, "WRONG REGION CODE" is displayed on the TV screen)

Major countries or area	All regions	North America	Europe, Japan, Middle East	Southeast Asia	Oceania, South America	Russia	China
Playable Region code							

Examples of playable DVD Videos :

- In U.S.A



- In Europe



■ Markings on the DVD Videos



Mark	Description
	Indicates the region code where the disc can be played back.
	Number of audio languages recorded with multiple audio languages. The number in the mark indicates the number of audio languages. (Up to 8 languages)
	Number of subtitle languages recorded with the multiple subtitle languages. The number in the mark indicates the number of subtitle languages. (Up to 32 languages)
	Number of angles recorded from the multiple camera angles. The number in the mark indicates the number of angles. (Up to 9 angles)
	Aspect ratio and TV screen type. "16:9", "4:3", etc. stands for aspect ratio, "LB" for letter box, "PS" for pan-scan, "WIDE" for wide screen.

NOTES ON COPYRIGHT

- Please check the copyright laws in your country before attempting to record from DVD Video or CD. Recording copyrighted material may infringe on copyright laws.
- DVD Video is protected by the copyguard system.
- If you connect the unit directly, to your VCR the copyguard system activates and the picture may not play back correctly.

This product incorporates copyright protection technology that is protected by method claims of certain U.S. patents and other intellectual property rights owned by Macrovision Corporation and other right owners. Use of this copyright protection technology must be authorized by Macrovision Corporation, and is intended for home and other limited viewing uses only unless otherwise authorized by Macrovision Corporation. Reverse engineering or disassembly is prohibited.

SYMBOL AND MESSAGE ABOUT INVALID OPERATION

- When you press a button, if the unit does not accept that operation,  appears on the TV screen. Operations are occasionally unacceptable even if  is not displayed.
- During operation, if the “WRONG REGION CODE” is displayed on the TV screen, it means the region code number of the unit is different from that of the DVD Video and playback will not be allowed.
- During operation, if the “WRONG DISC FORMAT” is displayed, it means the color system of the unit is different from that of the DVD Video. In case a disc is not playable, this message will be also displayed.
- During operation, if “BAD PARENTAL LEVEL” is displayed, it means the rating level function is operating. In this case, select the preferred rating level. (For details, refer to “SETTING THE RATING LEVEL” on page 39.)

CARE AND HANDLING OF DISCS

- In handling a disc, hold it carefully by the edges.



- Do not stick paper or write anything on the printed surface.



- Fingermarks and dust on the recorded surface should be carefully wiped off with a soft cloth. Wipe straight from the inside to the outside of the disc.

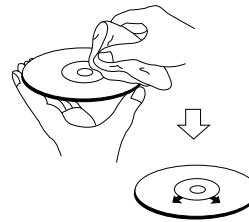

- Always keep the discs in their cases after use to protect them from dust and scratches.

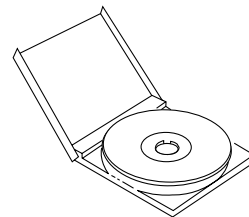

Notes:

- Do not expose discs to direct sunlight, high humidity or high temperature for a long time.
- When loading or unloading a disc in the disc tray, always place it with the printed side up.

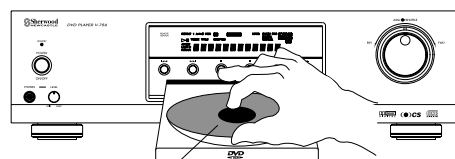

Printed side

Operations

BASIC PLAYBACK

■ Preparations

- Turn on the TV and select the video input source connected to the unit.
- To enjoy the sound of the disc from your audio system, turn on the audio system and select the input source connected to the unit.
- Set the TV screen type correctly to match your TV.

1 Before operation, enter the standby mode.



- The STANDBY indicator lights up. This means that the unit is connected to the AC mains and a small amount of current is retained to support operational readiness.
- To switch the power off, push the POWER switch again. Power is cut off and the STANDBY indicator goes off.

2 In the standby mode, turn the power on.

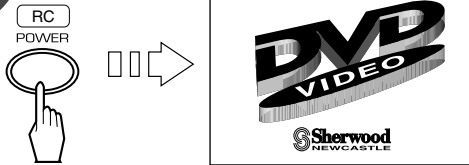

- Each time the POWER button on the remote control is pressed, the unit is turned on to enter the operating mode or off to enter the standby mode.
- In the standby mode, if the OPEN/CLOSE button is pressed, the unit can be also turned on (and when there is a disc in the unit, the disc is automatically played back).

3 Open the disc tray, then load a disc with the printed side up.

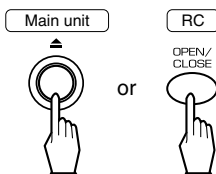

- 8 cm (3 inch) discs can be loaded on the inside circle of the tray, too.

4 Start playback.

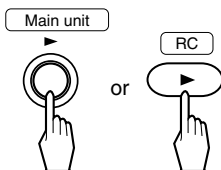

- The disc tray closes and playback starts.
- When the disc tray is closed by pressing the OPEN/CLOSE button, playback starts, too.

Note :

- When you play a DVD Video, the menu display may appear on the TV screen. In this case, see "To start playback from the menu" on the next page.

- Example of DVD Video

TITLE MENU	
Dogs	Cats
Cows	Horses

To start playback from the menu

- To select the preferred item, tilt the CURSOR/ENTER button in the desired direction and press the CURSOR/ENTER button (or PLAY button), or press the NUMERIC buttons.

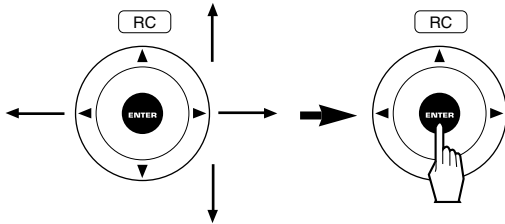

- In case of use of the NUMERIC buttons.

when selecting "3"



when selecting "12"

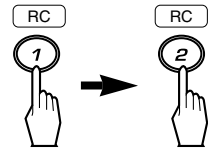

- Playback of the selected item starts.
- When using the NUMERIC buttons to select an item, it may be necessary, with some discs, to also press the PLAY (or ENTER) button to start playback of your selection.
- When the selected item contains the subitems, repeat the above step until the preferred item is selected.

■ To stop playback and return to the menu display

- In case of DVD Videos,
Press the TITLE, MENU or RETURN button on the remote control.
(Which button is pressed differs depending on the disc used.)
- Playback is suspended and the menu display appears.

Notes :

- The disc continues to rotate while the menu display appears even after the unit has finished playback of an item. When no further selections are to be played back, be sure to press the STOP button to clear the menu display.
- A TV screen may be burned in if a static picture is displayed for too long a time.
To prevent this, turn off the TV temporarily when a static picture, such as an on-screen display or menu, will be displayed for over 10 minutes.
- When you press a button, if the corresponding operation is prohibited by the unit or the disc,  will appear on your TV screen.

To stop playback

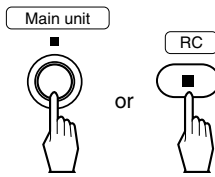

- When playback is stopped, the unit memorizes the point where the STOP button was pressed (RESUME function). Press the PLAY button again, and playback will resume from this point. When the disc tray is opened or the STOP button is pressed again, the RESUME function will be cleared.
- During playback of a disc, if either the OPEN/CLOSE button or the POWER button is pressed by mistake, etc., playback may also be resumed from the memorized point on the disc by pressing the corresponding button, again.

To skip ahead or back during playback

- To skip ahead

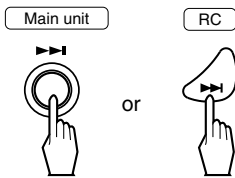

- Each time the button is pressed, a chapter (for DVD Videos) or a track (for CDs) is skipped.

- To skip back

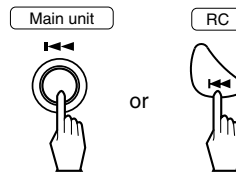

- When the button is pressed once midway through a chapter/track, playback returns to the start of that chapter/track. When it is pressed again, a chapter/track is skipped each time the button is pressed.

To pause playback during playback

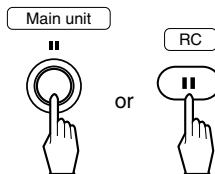

- DVD Video :
The unit will be in the still picture mode.
- CD :
The unit will be in the pause mode.
- To return to normal play, press the PLAY button.

Frame advance / reverse playback [DVD Video only]

- In the still picture mode,

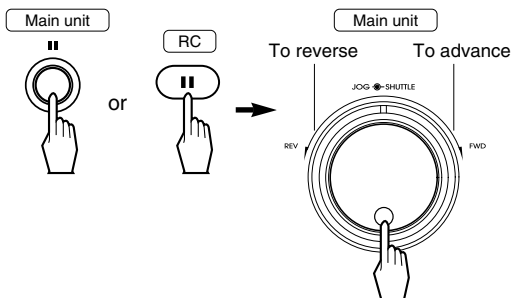

- Each time the PAUSE button is pressed, the disc is advanced by one frame.
- Each time the JOG dial is rotated in either direction, the disc is advanced or reversed by one frame.

Note : Only in U.S.A., Canada, etc. where this unit conforms to the NTSC color system, frame reverse playback can be available.

Rapid (/slow) advance / reverse playback during playback

You can play back discs at various speeds.

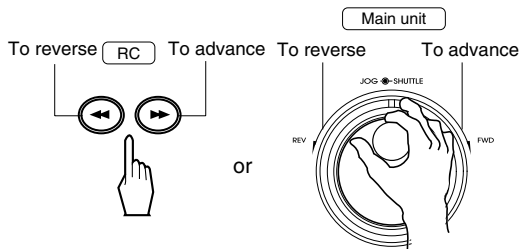

Note : Only in U.S.A., Canada, etc. where this unit conforms to the NTSC color system, slow reverse playback can be available.

- Each time the FORWARD SEARCH button is pressed, the speed increases by up to 5 steps depending on the discs as follows;

(1/8 x → 1/2 x → 2 x → 8 x → (16 x →) off)

- Each time the BACKWARD SEARCH button is pressed, the speed increases by up to 4 steps depending on the discs as follows;

(slower speed → 2 x → 8 x → (16 x →) off)

() : DVD Video only.

- Each time the SHUTTLE ring is rotated in either direction, the disc is advanced or reversed at a faster speed.

GENERAL INFORMATION ABOUT ON-SCREEN SYMBOLS

- The unit features on-screen symbols showing disc information (title/chapter/track number, elapsed/remaining time, subtitle/audio language and angle, etc.) and player information (repeat mode, program mode and operation status, etc.). Some symbols only show the indicated information. Other symbols allow the settings to be changed.

- Press the DISPLAY button during playback or in the stop mode.

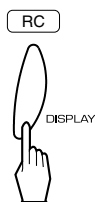

- Then the on-screen symbols are displayed on the TV screen.

- Each time this button is pressed, the on-screen symbols are changed depending on the discs as follows;

- DVD Video :

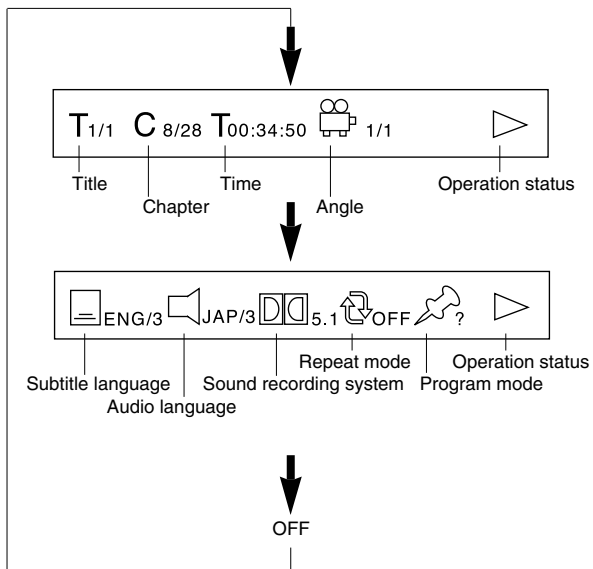

- CD :

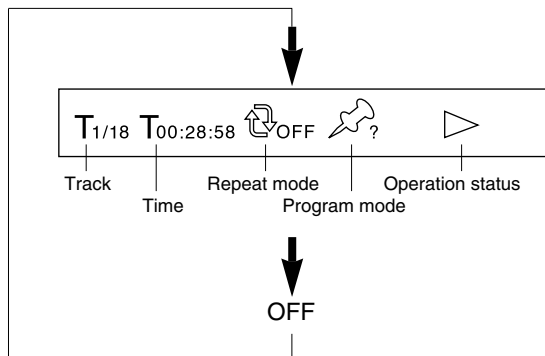

- Depending on the disc and operation status, the on-screen symbols may not be displayed, or may be partially or differently displayed on the TV screen.

PLAYING THE DESIRED SECTION OF DISC (TITLE/CHAPTER/TRACK/TIME SEARCH)

1

During playback, press the SEARCH button to select the preferred search mode.



- The on-screen symbols will be displayed automatically, even if the on-screen display is turned off or not already visible.
- Each time this button is pressed, the search mode changes depending on the disc as follows;

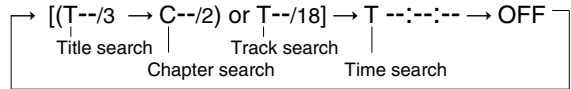

() : DVD Video only

- Some DVD videos do not have chapter numbers and searching by chapters is impossible.

2

Select the section to be played with the NUMERIC buttons.

Examples)

- When entering the title or chapter No. 2



- When searching the point at 8 min. 35 sec.

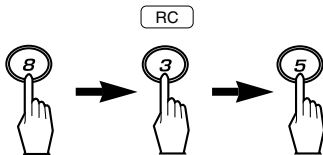

■ When correcting the numbers entered.

1. Press the CLEAR button.



- Each time this button is pressed, the numbers are cleared one by one.

- When entering the track No. 11

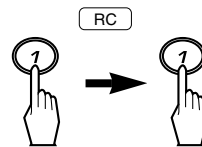

- You can playback a disc from the desired point of the current title or track by specifying the elapsed time from which to begin.

2. Enter the desired number again in the same way.

3

Start playback from the selected section.

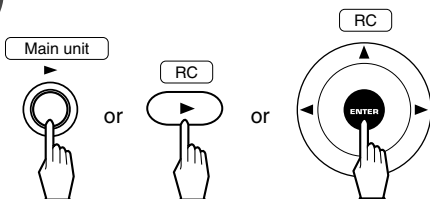

Notes :

- If the title, chapter, track, etc. you have selected is not contained in the disc, title, etc., appears on the TV screen, meaning searching for it is not possible.
- On some discs, search and playback will not operate or may operate in a different manner.

PLAYING A SPECIFIC ITEM [DVD Video only]

When using a title menu

- If some DVD Videos which contain more than one title may have the menu like as a list of the titles, the TITLE button can be used to select the desired title. (The details of operation differ depending on the disc used.)

1 During playback, press the TITLE button.

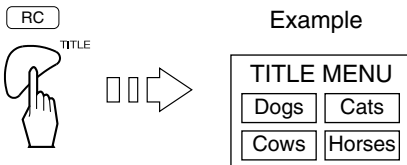

- Then a list of titles on the disc is displayed on TV screen.
- If the disc does not have a “list of titles” menu,  appears on the TV screen.

2 Tilt the CURSOR/ENTER button in the desired direction to select the desired title, then press the CURSOR/ENTER or PLAY button.

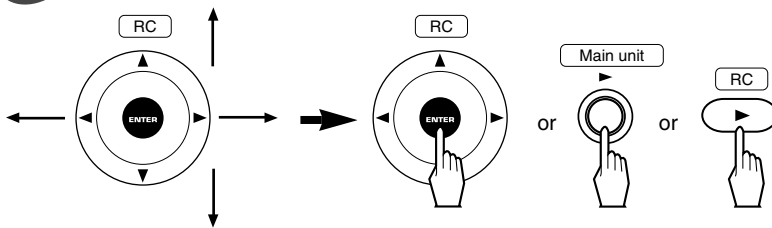



- The unit starts playback of the selected title.
- When the menu continues onto another screen, repeat this step until the desired title is selected.

When using a DVD menu

- Some DVD Videos have unique menu structures called DVD menus. For example, the discs programmed with complex contents provide guide menus, and those recorded with various languages provide menus for audio and subtitle language. Although the DVD menu’s contents and operation differ from disc to disc, the following explains the basic operation when this feature is used.

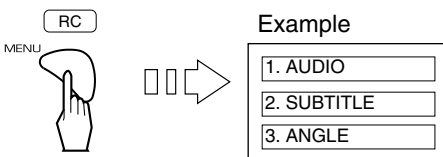
1 During playback, press the MENU button.



- Then the DVD menu available on the disc will be displayed on the TV screen.
- If the disc does not have the DVD menu,  appears on the TV screen.

2 Tilt the CURSOR/ENTER button in the desired direction to select the desired item, then press the CURSOR/ENTER or PLAY button.

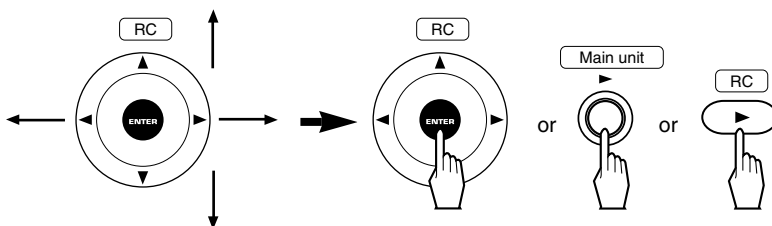

- The unit starts playback of the selected item.
- When the menu continues onto another screen, repeat this step until the desired item is selected.

REPEAT PLAYBACK

- You can play back a current title, chapter, track or section repeatedly. (Title repeat, entire disc repeat, chapter/track repeat, A-B repeat)

Note :

- Repeat playback may not work correctly on some DVD Videos.

Repeating a title, chapter or track

- During playback of the desired title, chapter or track, press the REPEAT MODE button.



- The on-screen symbols will be displayed automatically, even if the on-screen display is turned off or not already visible.

- Each time this button is pressed, the repeat mode changes depending on the disc as follows :

DVD Video :

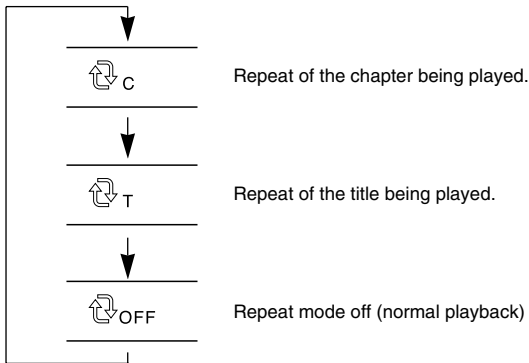

CD :

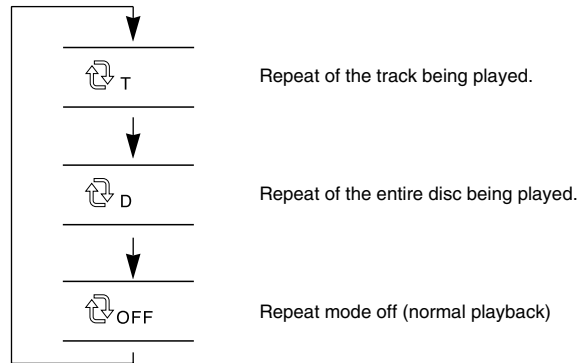

- To return to normal playback, press the REPEAT MODE button repeatedly until the “ OFF” is displayed.

Repeating the desired part

1

During playback at the beginning of the part you want to repeat, press the REPEAT A↔B button.

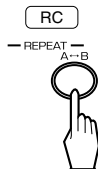

- Then “ A - ” is displayed on the TV screen.

2

At the end of the part, press the REPEAT A↔B button again.

- Then “ AB ” is displayed on the TV screen, and the part between points A and B will play back repeatedly.
- To return to normal playback, press the REPEAT A↔B button repeatedly until “ OFF ” is displayed.

Note :

You may not use repeat A↔B playback on any section that include multiple camera angles.

INTROSCAN PLAYBACK [CD only]

You can play back the first 10 seconds of each track.

- Start introscan playback.



- To return to normal playback, press this button again.

- Then “▶▶” is displayed on the TV screen, and the first 10 seconds of each track on a CD will play back in sequence repeatedly.
- During introscan playback, when the BACKWARD SKIP (◀◀) or the FORWARD SKIP (▶▶) button is pressed, the “◀◀” or “▶▶” is displayed and introscan playback operates in the corresponding direction.

CHANGING THE TIME DISPLAY DURING PLAYBACK

- Press the TIME button.



- The on-screen symbols will be displayed automatically, even if the on-screen display is turned off or not already visible.

- Each time this button is pressed, the time display changes depending on the disc as follows;

- DVD Video :

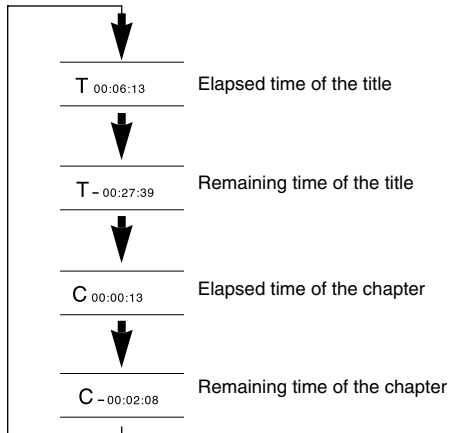

- CD :

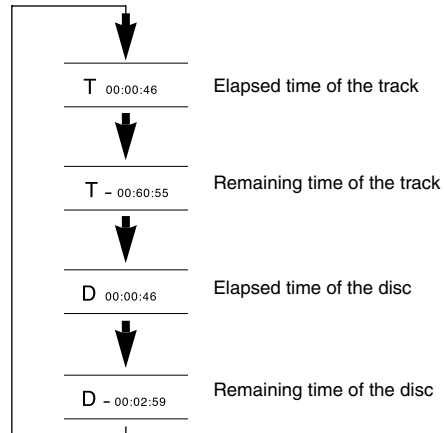

- Depending on the disc and the status of some operations such as playback of DVD Video by using a title or DVD menu, etc., the time display may not be displayed.

CHANGING THE CAMERA ANGLE [DVD Video only]

- Some DVD Videos contain scenes which have been shot simultaneously from multiple camera angles. For these discs, the same scene can be viewed from each of these different angles.
- The recorded angles differ depending on the disc used.
- During playback of the scene recorded from multiple camera angles, press the ANGLE button.



- Each time this button is pressed, the angle changes as follows :

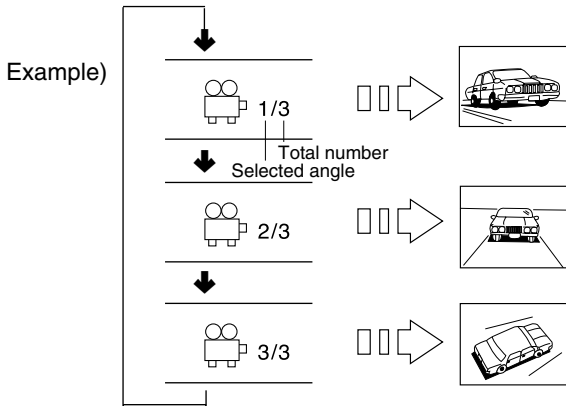

- During playback of the scene recorded from multiple camera angles, "ANGLE" is shown on the unit's display and the on-screen symbols reflect the total number of different views (angles) that are available.
- The on-screen symbols will be displayed automatically, even if the on-screen display is turned off or not already visible.

- Depending on the disc, up to 9 angle scenes can be included.

Notes :

- This function works only at scenes recorded from multiple angles.
- If the current scene is not recorded from multiple angles and this button is pressed, appears on the TV screen.

CHANGING THE AUDIO LANGUAGE [DVD Video only]

- It is possible to change the audio language to a different language from the one selected at the initial settings. (For details, refer to "SETTING THE LANGUAGE" on page 30.)
- This operation works only with discs on which multiple audio languages are recorded.
- During playback, press the AUDIO button.



- Each time this button is pressed, the audio language changes as follows;

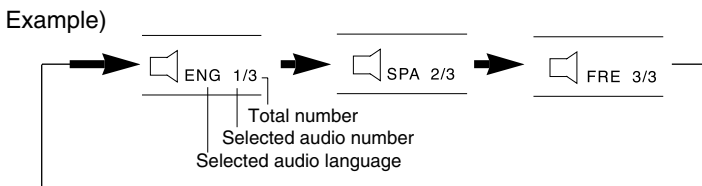

- The on-screen symbols will be displayed automatically, even if the on-screen display is turned off or not already visible.

- Depending on the disc, the audio language display may not be available, or may be differently displayed on the TV screen.
- If the language other than ENG, JAP, GER, SPA, FRE, HIN, HUN, ITA, POR, RUS, CHI is selected, DEF is displayed as the selected audio language on the TV screen.

Note :

- If the disc contains only one audio language and you press this button, appears on the TV screen.

CHANGING THE SUBTITLE LANGUAGE [DVD Video only]

- It is possible to change the subtitle language to a different language from the one selected at the initial settings. (For details, refer to "SETTING THE LANGUAGE" on page 30.)
- This operation works only with discs on which multiple subtitle languages are recorded.
- During playback, press the SUBTITLE button.



- The on-screen symbols will be displayed automatically, even if the on-screen display is turned off or not already visible.

- Each time this button is pressed, the subtitle language changes as follows;

Example)

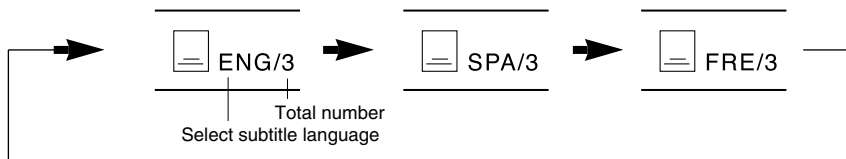

- Depending on the disc, the subtitle language display may not be displayed, or may be differently displayed on the TV screen.
- If the language other than ENG, JAP, GER, SPA, FRE, HIN, HUN, ITA, POR, RUS, CHI is selected, then DEF is displayed as the selected subtitle language on the TV screen.

Note :

- When you cannot select the subtitle language because the disc contains only one subtitle language,  appears on the TV screen.

■ To clear the subtitle.

- While the subtitle is being displayed, press the SUBTITLE ON/OFF button.



- Then subtitles disappear from the TV screen.
- Press this button to display the subtitles.

PLAYING A SCENE CLOSE-UP [DVD Video only]

- It is possible to zoom in on a part of the scene. You can select and view any part of the scene according to the initial settings. (For details, refer to “When selecting the ZOOM SETUP” on page 37.)

1 During playback or in the still pause mode, press the ZOOM button.



- Each time this button is pressed, the zoom scale changes as follows :

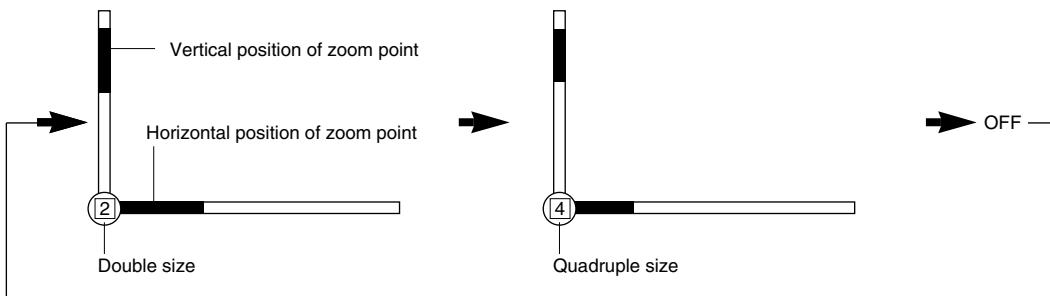

2 Tilt the CURSOR/ENTER button in the desired direction to shift the zoom point to the desired position.

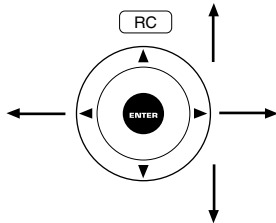

Note :

- Depending on the disc and the status of some operations such as playback of DVD Video by using a title or DVD menu, etc., zoom playback will not work.

- To return to the previous status, press the ZOOM button repeatedly until the zoom playback is canceled.

LISTENING WITH HEADPHONES

1

For private listening, connect the headphones.

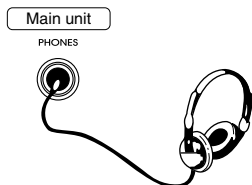

- Headphones with a 1/4 inch (6.3 mm) stereo plug can be connected.

2

Adjust the volume level of the headphones as desired.

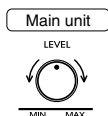
**Note :**

- Listening at extremely high levels may be harmful to your ears and headphones.

Initial Settings

The initial settings made to this unit at the factory are stored in memory and can be modified as desired, later.

- 1 While the unit is in the "STOP" mode, press the SETUP button to enter the SETUP mode.

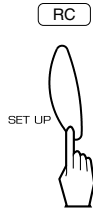

- The setup menu screen appears on the TV screen.
- If you press the SETUP button again while the SETUP menu is displayed, the menu will disappear.

SETUP menu mode

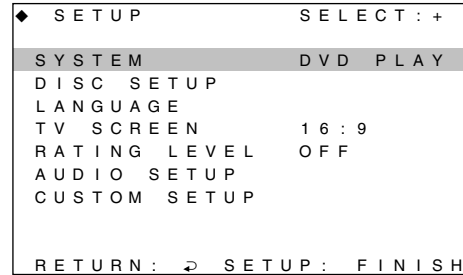

- On the menu screen, "SELECT" stands for the CURSOR /ENTER button, "↵" for the RETURN, "FINISH" for the SETUP and "PLAY" for the PLAY (▶).

- 2 Tilt the CURSOR/ENTER button upward or downward to select a category.

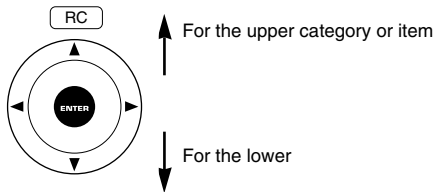

- The selected category or item is highlighted.

- 3 Press the CURSOR/ENTER button to confirm your selection.

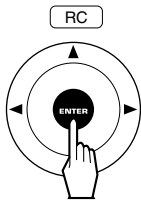

- The necessary details for the selected category will appear on succeeding screens.

■ When selecting SYSTEM

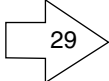
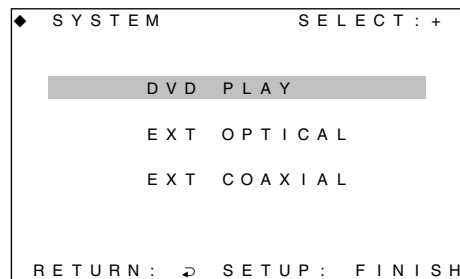

■ When selecting DISC SETUP

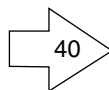
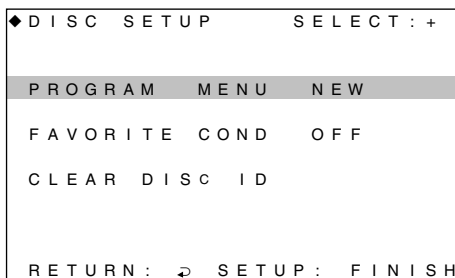

■ When selecting LANGUAGE

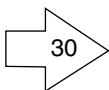
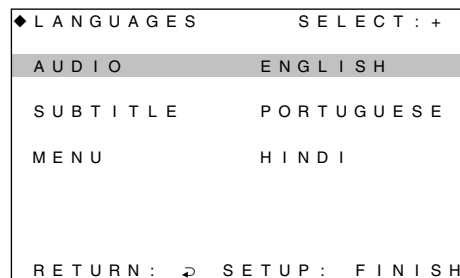

■ When selecting TV SCREEN

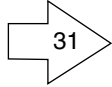
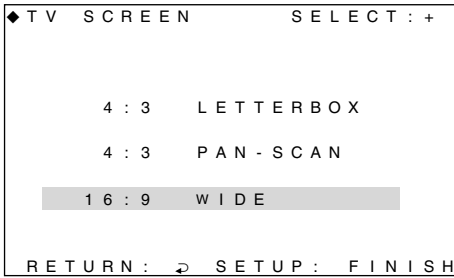

■ When selecting RATING LEVEL

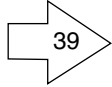
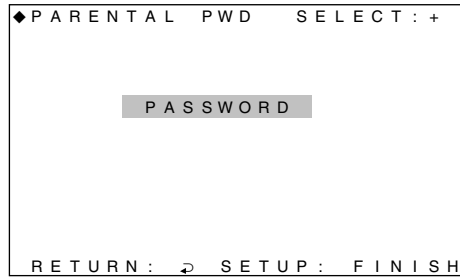

■ When selecting AUDIO SETUP

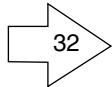
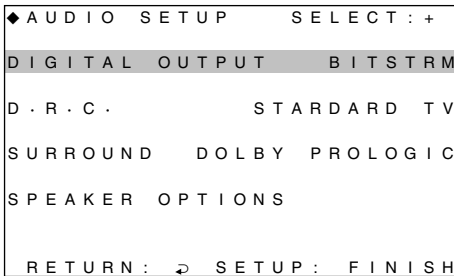

■ When selecting CUSTOM SETUP

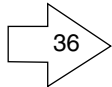
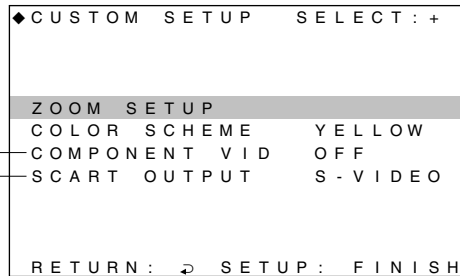

Regional Option for Europe, etc. only

- For the setting details, see the page number in ⇨ .
- Adjust the setting(s) in each category to your preference.

SETTING THE SYSTEM

- You can use the unit as DVD player or as a digital surround sound decoder (or both).
- For use as a surround sound decoder, be sure to connect the DIGITAL OUTs of the associated source unit to the DIGITAL INs of this unit.
(Refer to “CONNECTING TO ADDITIONAL COMPONENT WITH VIDEO AND DIGITAL OUTS” on page 7.)

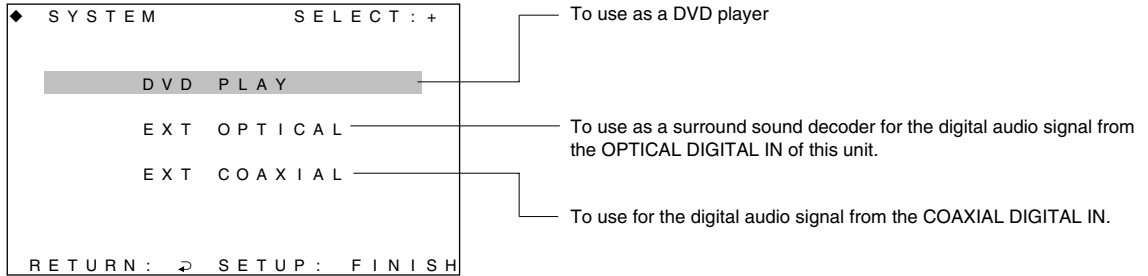

- Depending on your use, tilt the CURSOR/ENTER button upward or downward to select the item, then press the CURSOR/ENTER button.

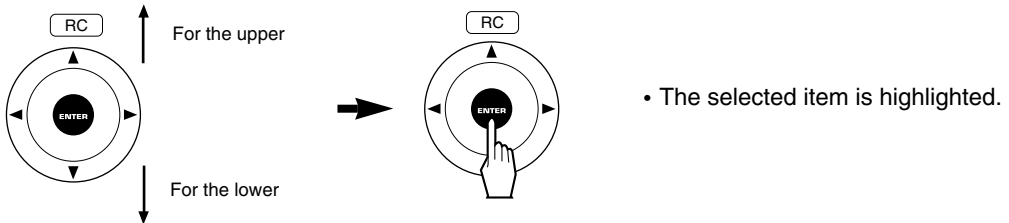

Note :

- When the “EXT OPTICAL” or “EXT COAXIAL” is selected to use this unit as a built-in decoder, only the AUDIO SETUP on the SETUP menu can be selected and most of the function buttons such as PLAY, OPEN/CLOSE, etc. for DVD player operation will not work.

SETTING THE LANGUAGE

◆ LANGUAGES	SELECT : +
AUDIO	ENGLISH
SUBTITLE	PORTUGUESE
MENU	HINDI
RETURN : ↵	SETUP : FINISH

To select a preferred audio language to be played from those included on the DVD Video.

To select a preferred subtitle language to be displayed from those included on the DVD Video.

To select a preferred menu language to be displayed from those included on the DVD Video.

1

Tilt the CURSOR/ENTER button upward or downward to select the item, then press the CURSOR/ENTER button.

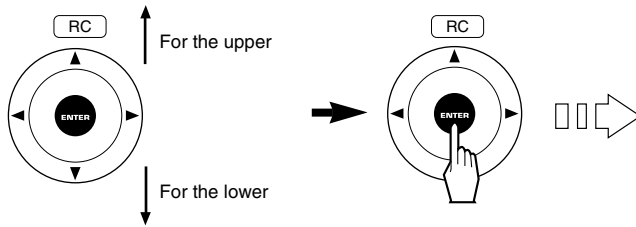

Example) When selecting AUDIO

◆ AUDIO	SELECT : +
ENGLISH	HUNGARIAN
JAPANESE	ITALIAN
GERMAN	YIDDISH
SPANISH	PORTUGUESE
FRENCH	RUSSIAN
HINDI	CHINESE
ORIGINAL	OTHERS O
RETURN : ↵	SETUP : FINISH

• Then the selected item is displayed.

2

Tilt the CURSOR/ENTER button in the desired direction to select the preferred language, then press the CURSOR/ENTER button.

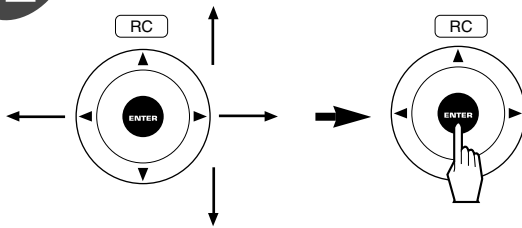

- The selected language is highlighted.
- When you select the "ORIGINAL" on the AUDIO setting display, the initial language among the audio languages recorded on the disc is played.
- When you select "AUTO" on the SUBTITLE setting display, the same language selected in the AUDIO setting is automatically selected.
- When you want to select a language other than the displayed languages, select "OTHERS".

■ When selecting "OTHERS"

OTHERS	----
--------	------

- Refer to the "DVD Language Code List" on page 47 to find the 4-digit language code for the preferred language and enter it with the NUMERIC buttons, then press the CURSOR/ENTER button.

Example) When entering "8076".

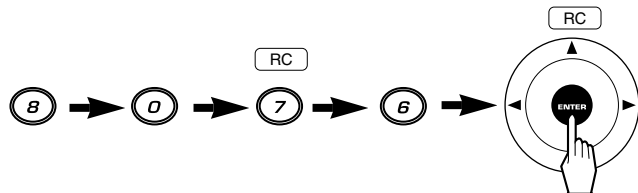

3

Repeat the above step 1 and 2 to adjust the other language settings to your preference.

Note :

- If the selected language is not recorded, the initial language on the disc is played or displayed.

SETTING THE TV SCREEN

- You can select the TV screen type to match your TV during playback of DVD Videos recorded for wide screen TVs.
- When you connect a normal TV with 4:3 aspect ratio to the unit, select either “4:3 LETTERBOX” or “4:3 PAN-SCAN” and when you connect a wide TV with 16:9 aspect ratio, select “16:9 WIDE”.

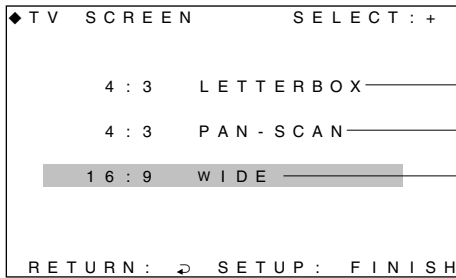

- Letter box screen with 4:3 aspect ratio.
 - DVD Video software recorded with the 16:9 aspect ratio is reproduced in the letter box screen which has black bands on the top and bottom.
- Pan-scan screen with 4:3 aspect ratio
 - DVD Video software recorded with the 16:9 aspect ratio and the pan-scan specification is reproduced in the pan-scan screen which automatically trims the left and right of the image.
 - The DVD video software recorded without the pan-scan specification is reproduced in the letter box screen.
- Wide screen with 16:9 aspect ratio
 - DVD Video software recorded with the 16:9 screen is reproduced by filling the TV screen.

- Depending on your TV, tilt the CURSOR/ENTER button upward or downward to select a TV screen type, then press the CURSOR/ENTER button.

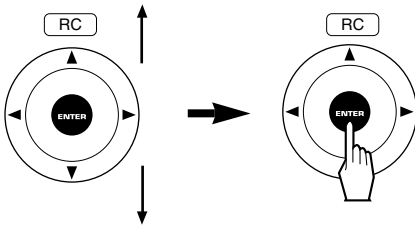

- The selected type is highlighted.

SETTING THE AUDIO SETUP

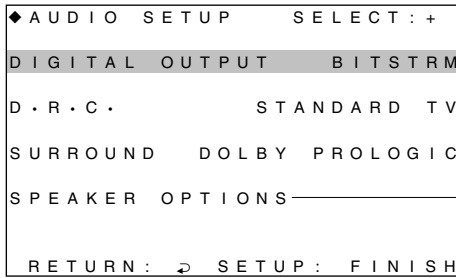

- To select the bitstream or linear PCM as digital audio signal format
- To select a preferred dynamic range control
- To select a preferred surround sound
- To select a preferred speaker option

When selecting the DIGITAL OUTPUT

When the DIGITAL OUTs of the unit are connected to the corresponding DIGITAL INs of an amplifier with built-in decoder, etc., this item should be set correctly.

Notes :

- When the DIGITAL OUT of this unit is connected to the DIGITAL IN of an amplifier which does not contain a Dolby Digital, DTS or MPEG Multichannel decoder, etc. (which processes the bitstream signal), you should set the DIGITAL OUT to LINEAR PCM. If not, loud noise may be heard from the speakers, that could be harmful to your ears and damage the speakers.
- When connecting to the DIGITAL IN of an MD or CD recorder for digital recording, you should set the DIGITAL OUT to LINEAR PCM. If not, the digital recording will not perform properly.
- When the DIGITAL OUT is set to LINEAR PCM, the multi-channel signal format (front L, center, front R, rear L and R) is mixed down to 2 channels and converted to a linear PCM signal.

1 Tilt the CURSOR/ENTER button upward or downward to select the DIGITAL OUTPUT, then press the CURSOR/ENTER button.

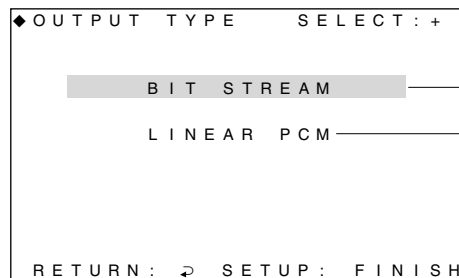
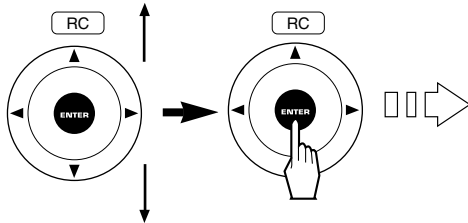

- To output the digital audio signal as it was recorded
- To convert the bitstream signal to the linear PCM signal and to output it

2 Tilt the CURSOR/ENTER button upward or downward to select the correct digital audio signal format, then press the CURSOR/ENTER button.

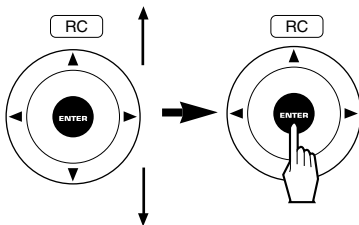

• For your reference, the following chart shows the relationship between types of playback discs and digital audio output signals.

Playback discs	Digital audio output	
	BITSTREAM	LINEAR PCM
DVD Video with 48 kHz, 16 bit linear PCM	48 kHz, 16 bit linear PCM	48 kHz, 16 bit linear PCM
DVD Video with 48 kHz, 20/24 bit linear PCM	48 kHz, 20/24 bit linear PCM	48 kHz, 20 bit linear PCM
DVD Video with 96 kHz, linear PCM	48 kHz, 24 bit linear PCM	48 kHz, 24 bit linear PCM
DVD Video with DTS	DTS bitstream	48 kHz, 20 bit linear PCM
DVD Video with Dolby Digital	Dolby Digital bitstream	48 kHz, 16 bit linear PCM
DVD Video with MPEG audio	MPEG bitstream	48 kHz, 16 bit linear PCM
Audio CD	44.1 kHz, 16 bit linear PCM	44.1 kHz, 16 bit linear PCM
Audio CD with DTS	DTS bitstream	44.1 kHz, 20 bit linear PCM

- The selected format is highlighted.

Continued

When selecting the Dynamic Range Control

- This function can be activated in the Dolby Digital mode only. (Refer to “When selecting SURROUND” on this page.)
- You can compress the dynamic range of the Dolby Digital sound if you need. Using this function, you can listen to sound at low volume levels easily.

1 Tilt the CURSOR/ENTER button upward or downward to select Dynamic Range Control, then press the CURSOR/ENTER button.

2 Tilt the CURSOR button upward or downward to select a preferred dynamic range, then press the ENTER button.

Note :

- In some Dolby Digital softwares, this function may not be available.

- The selected mode is highlighted.

When selecting the SURROUND

- The built-in decoder of the unit allows you to enjoy surround sound with various program sources; Dolby Digital, Dolby Pro Logic, Dolby Virtual, DTS, MPEG Multichannel, Circle Surround. For details on surround sound such as Dolby Digital, Dolby Pro Logic, etc., refer to “Definition Of Terms” on page 44.
- Depending on the program source recorded with multichannel audio such as Dolby Digital, Dolby Pro Logic, DTS and MPEG Multichannel, you can select a surround mode to match your program source.

1 Tilt the CURSOR/ENTER button upward or downward to select SURROUND, then press the CURSOR/ENTER button.

2 Tilt the CURSOR/ENTER button upward or downward to select a preferred surround mode, then press the CURSOR/ENTER button.

Note :

- When the selected surround sound does not match the program source being played back, the program source is played back as it was recorded.

- The selected mode is highlighted.

Continued

When selecting the SPEAKER OPTIONS

- When the 6.1 CH AUDIO OUTS of the unit are connected to the 6.1 (or 6) CH INs of your amplifier or receiver to enjoy high-quality audio and surround with the built-in decoder, these items should be set correctly.
- Tilt the CURSOR/ENTER button upward or downward to select SPEAKER OPTIONS, then press the CURSOR/ENTER button.

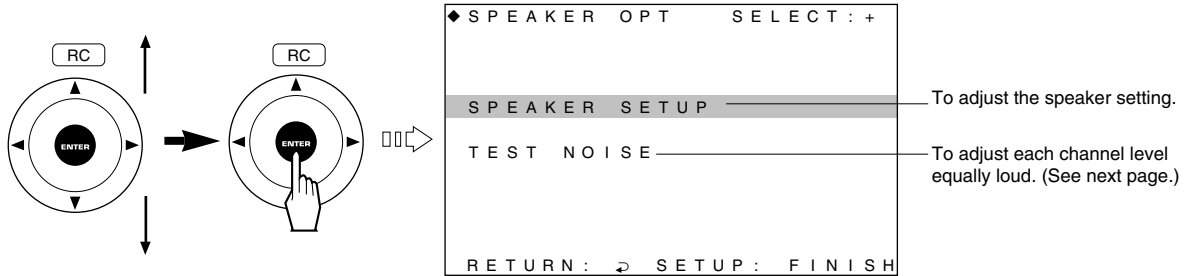

When selecting the SPEAKER SETUP

- 1 Tilt the CURSOR/ENTER button upward or downward to select SPEAKER SETUP, then press the CURSOR/ENTER button.

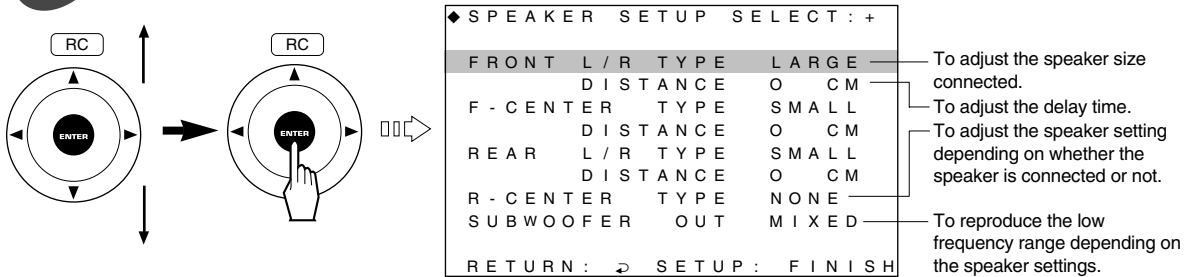

- 2 Tilt the CURSOR/ENTER button upward or downward to select the preferred item, then press the CURSOR/ENTER button.

Example) When selecting the FRONT L/R TYPE

FRONT L/R TYPE	LARGE
	SMALL

- Depending on your speaker type, you can select one of these following speaker types.
- LARGE** : Large speaker(s) which can fully reproduce the low frequency range.
- SMALL** : Small speaker(s) which cannot fully reproduce the low frequency range.
- NONE** : No speaker(s) connected. (It can be selected in the speaker types other than FRONT L/R TYPE.)
- PRESENT** : A speaker is connected. (It can be selected in the R-CENTER TYPE only.)
- LFE** : When reproducing only the separate low frequency range that be contained in multi-channel sound systems such as DTS, Dolby Digital, MPEG Multichannel, etc. (It can be selected in the SUBWOOFER OUT only.)
- MIXED** : When mixing the low frequency range of the speaker(s) which is set to "SMALL" with that of subwoofer and reproducing them. (It can be selected in the SUBWOOFER OUT only.)

- 3 Tilt the CURSOR button upward or downward to select the preferred speaker type, then press the CURSOR/ENTER button.

Example) When selecting the DISTANCE

DISTANCE	- - - CM
----------	----------

- You can enter up 999 cm as the distance between the speaker and prime listening position.
- One foot equals about 30 cm.

- 3 Enter the distance 17 cm with the NUMERIC button, then press the CURSOR/ENTER button.

Example) When entering "150"cm.

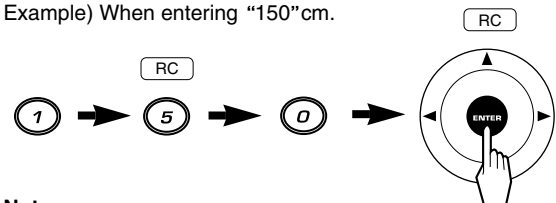

Notes :

- When the NONE is selected respectively for the front center and rear speaker types, the front distance cannot be entered.
- When the NONE is selected for the front center or the rear speaker type, the corresponding speaker distance cannot be entered.

Continued

4

Repeat the above steps 2 and 3 to adjust each speaker setting correctly.

Notes :

- The delay time(s) is (are) automatically adjusted, based on the distance entered.
- When “PRESENT” is selected for the rear center speaker type, the rear center signal is extracted from the rear left and right signals and reproduced during playback of 5.1 CH program sources such as Dolby Digital, DTS and MPEG Multichannel.
- When the front L/R, front center and rear L/R speakers are all set to “LARGE”, the subwoofer is automatically set to “LFE”.
- When the front L/R speakers are set to “SMALL”, the front center and rear L/R speakers are all set to “SMALL” (or “NONE”) and the subwoofer is set to “MIXED” automatically.
- When the front center or rear L/R speakers are set to “LARGE”, the front L/R speakers cannot be set to “SMALL”.
- When the rear L/R speakers are set to “NONE”, the rear center speaker is automatically set to “NONE”.
- When the front center or rear L/R speakers are set to “NONE”, the sound intended for these speaker(s) is redirected to other speakers.
- When the speaker(s) is (are) set to “SMALL”, the low frequency range of the speaker(s) is redirected to other speaker(s) which is (are) set to “LARGE” or “MIXED”.

■ When selecting the TEST NOISE (TEST TONES)

◆ TEST NOISE		SELECT : +
FRONT LEFT		0 dB
FRONT CENTER		0 dB
FRONT RIGHT		0 dB
REAR RIGHT		+ 3 dB
REAR CENTER		N / A
REAR LEFT		- 3 dB
SUBWOOFER		+ 5 dB
RETURN : ↩ SETUP : FINISH		

• No test noise

- The test noise will be heard from the speaker of each channel for 2 seconds.
- When the speaker type is adjusted to “NONE”, “N/A” is displayed at its channel, and the test noise will skip that channel.

1

Tilt the CURSOR/ENTER button upward or downward to select the preferred channel, then tilt the CURSOR/ENTER button left or right to adjust its level as preferred.

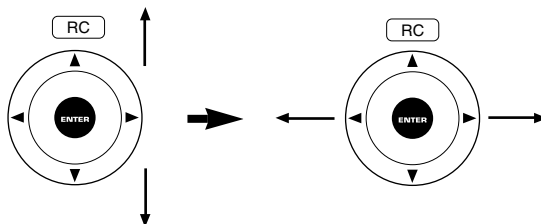

2

Repeat the step 1 until the sound level of each channel is heard to be equally loud.

SETTING THE CUSTOM SETUP

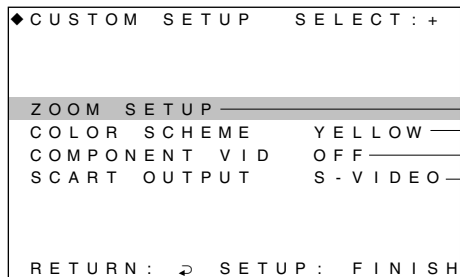

- To adjust the initial zoom settings.
- To adjust the color of the on-screen symbols
- To use the COMPONENT VIDEO OUTs (Regional Option for Europe,etc. only).
- To use the SCART OUTPUT (Regional Option for Europe,etc. only).

When selecting the COLOR SCHEME

- When you cannot distinguish the on-screen symbols from the background by color, adjust the color of the on-screen symbols to your preference.

1 Tilt the CURSOR/ENTER button upward or downward to select COLOR SCHEME, then press the CURSOR/ENTER button.

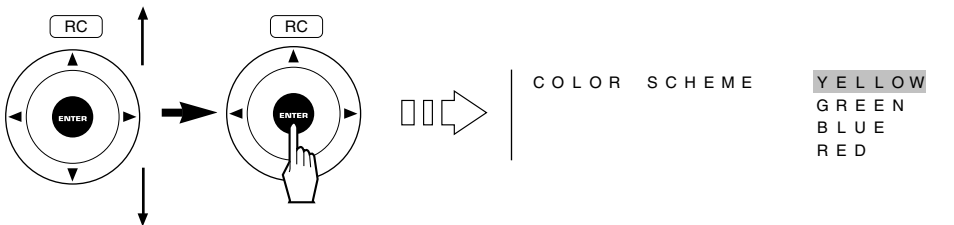

2 Tilt the CURSOR/ENTER button upward or downward to select the preferred color, then press the CURSOR/ENTER button.

- The selected color is highlighted.

Continued

When selecting ZOOM SETUP

- You can select the initial setting as preferred for zoom playback of DVD Video.

1 Tilt the CURSOR/ENTER button upward or downward to select the ZOOM SETUP, then press the CURSOR/ENTER button.

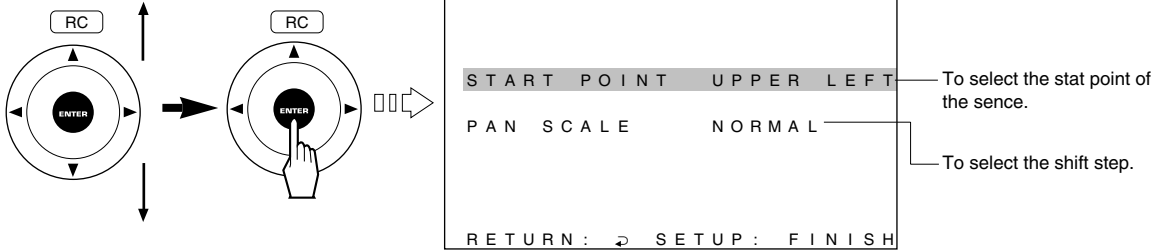

2 Tilt the CURSOR/ENTER button upward or downward to select the preferred item, then press the CURSOR/ENTER button.

Example) When selecting the START POINT

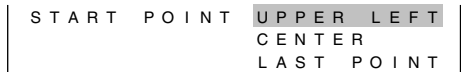

- UPPER LEFT : Upper left of the scene.
- CENTER : Center of the scene.
- LAST POINT : The zoom point shifted last.

Example) When selecting the PAN SCALE

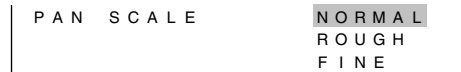

- NORMAL : Shiftable in 6 steps.
- ROUGH : Shiftable in 3 steps.
- FINE : Shiftable in 12 steps.

3 Tilt the CURSOR/ENTER button upward or downward to select to preferred mode, then press the CURSOR/ENTER button.

When selecting the COMPONENT VIDEO (Regional Option)

- For some countries like Europe, the unit incorporates the TV and VCR SCART connectors which can deliver either the regular video and RGB signals or the S-video (Y and C) signals as well as the mixed audio L and R signals for easy connection.
- When the SCART connections between the unit and video components are made, depending on whether the COMPONENT VIDEO OUTs of the unit is connected to TV or not, adjust the COMPONENT VIDEO to your preference.

1 Tilt the CURSOR/ENTER button upward or downward to select the COMPONENT VIDEO, then press the CURSOR/ENTER button.

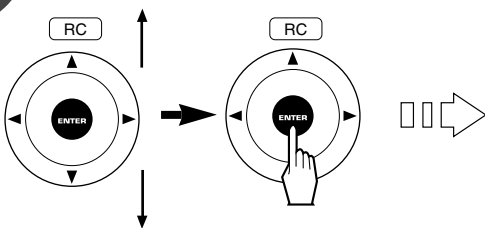

- ON : When using the video signals from the COMPONENT VIDEO OUTs
- OFF : When not using the video signals from the COMPONENT VIDEO OUTs for RGB signals from the TV and VCR SCART connectors of the unit.

2 Tilt the CURSOR/ENTER button upward or downward to select the preferred mode, then press the CURSOR/ENTER button.

Continued

When selecting the SCART OUTPUT (Regional Option)

- For some countries like Europe, the unit incorporates the TV and VCR SCART connectors which can deliver either the regular video and RGB signals or the S-video (Y and C) signals as well as the mixed audio L and R signals for easy connection.
- When the SCART connections between the unit and video components are made, depending on whether you use the regular video signal from the SCART connector or the S-video signals, you can select either the regular VIDEO or the S-VIDEO.

Note :

- Be sure to set your TV and VCR to the corresponding one of the regular video, S-video (Y and C) and RGB modes to match the SCART OUT setting of the unit. (Refer to the operating instructions of the component(s) connected.)

1

Tilt the CURSOR/ENTER button upward or downward to select the SCART OUTPUT, then press the CURSOR/ENTER button.

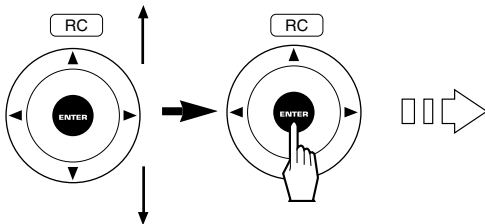

SCART OUTPUT VIDEO
S - VIDEO

- VIDEO : When using the regular video signal from the TV and VCR SCART connectors of the unit.
- S-VIDEO : When using the S-video signals only from the TV and VCR SCART connectors of the unit. (Only when the COMPONENT VIDEO is adjusted to OFF, you can use the RGB signals, too.)

2

Tilt the CURSOR/ENTER button upward or downward to select the preferred mode, then press the CURSOR/ENTER button.

SETTING THE RATING LEVEL

- This function restricts playback of DVD Video which contains violent and other scenes according to the level set by the user. For example, if a movie which includes violent scenes supports the parental lock feature, such scenes which you do not want to let children view can be cut or replaced with other scenes.



1 Press the CURSOR/ENTER button to enter a password.

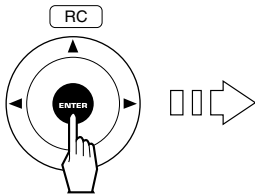

P A S S W O R D

The unit requires you to enter a 4-digit password.

2 Enter a 4-digit with the NUMERIC buttons, then press the CURSOR/ENTER button.

Example)
When entering "1 2 3 4"

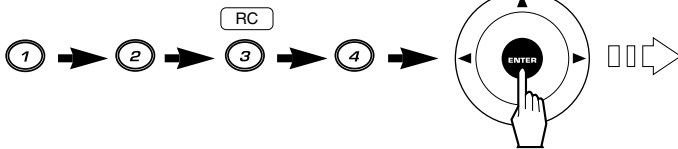

Rating level setting mode

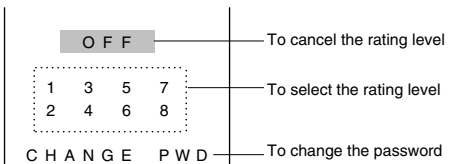

- When the 4-digit password entered is wrong, the SETUP menu mode is resumed. If this is the case, repeat the above steps ① and ② after selecting the RATING LEVEL in the SETUP menu mode.

Note :

- If a password has never been entered yet or you forget your password, enter "7 8 9 0"

- For your reference on the rating levels,
 8 : Level 8 : No restriction
 7 : Level 7 :
 6 : Level 6 : ↑ Lax
 5 : Level 5 :
 4 : Level 4 :
 3 : Level 3 : ↓ Strict
 2 : Level 2 :
 1 : Level 1 : Maximum restriction

3 Tilt the CURSOR/ENTER button upward or downward to select the preferred item, then press the CURSOR/ENTER button.

■ **When selecting either the OFF or a rating level.**

- The item is selected and the SETUP menu mode is resumed.

■ **Notes :**

- When you set the parental level strictly, some discs may not play back at all. If this is the case, set the rating level more laxly or to OFF mode.
- DVD Videos may or may not respond to the rating level setting. Make sure this function works with your DVD Videos.

■ **When selecting the CHANGE PWD.**

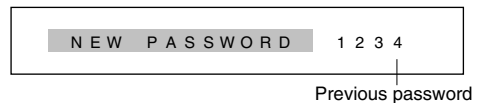

1. Press the CURSOR/ENTER button to enter a new password, then the previous password is changed into "----".
2. Enter a new password performing step ② above.
 - The new password is memorized and the rating level setting mode is resumed.

SETTING THE DISC SETUP

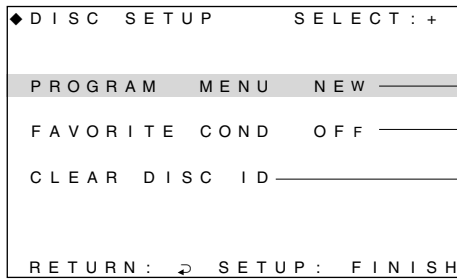

- To program chapters/tracks in the desired sequence.
- To memorize the favorite condition or select either the FACTORY DEFAULT or the RELOAD FC function.
- To clear the disc title.

When selecting the PROGRAM MENU

- Up to 20 chapters or tracks can be programmed to be played in any desired sequence.

Playing back your selections in the preferred sequence.

1 Tilt the CURSOR/ENTER button upward or downward to select the PROGRAM MENU, then press the CURSOR/ENTER button.

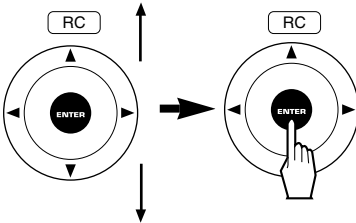

- Then the program menu screen is displayed.
- In the stop mode, if the "PROG" button on the remote control is pressed, the program menu mode can be entered directly, too. And if the "PROG" button is pressed again, the stop mode is entered.

Note :

- When a disc is not loaded, the program menu mode cannot be selected.

• When a DVD Video is loaded.

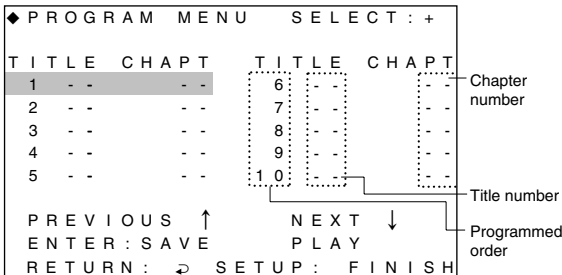

• When a CD is loaded.

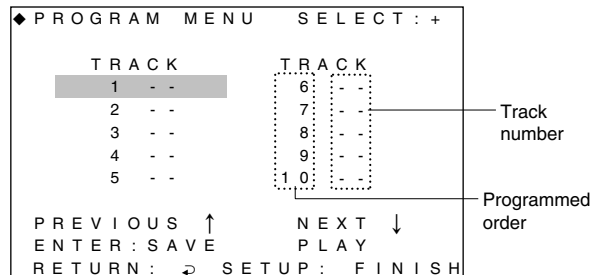

2 Press the CURSOR/ENTER button to enter either the preferred title for DVD Video or the preferred track for CD.

- The highlight on the item disappears and the range for selection appears (Example) "CHOOSE 1~12" appears.)

3 Enter the preferred number with the NUMERIC buttons, then press the CURSOR/ENTER button to store it. Example) When entering "11".

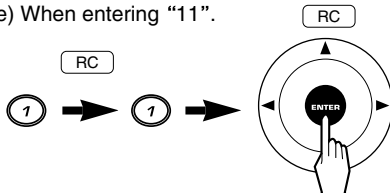

- The preferred number can be also entered by tilting the CURSOR/ENTER button, then press the CURSOR/ENTER button.
- In case of a DVD Video, after entering a title number, you should enter the preferred chapter number in the same way.
- The number entered is stored.

4 Tilt the CURSOR/ENTER button downward to move to the next order.

- When the preferred 10 items are programmed, if you move to "NEXT ↓" by tilting the CURSOR/ENTER button and then press the CURSOR/ENTER button to enter the latter program menu mode, the next 10 items can be programmed.
- On the contrary, if you move to "PREVIOUS ↑" by tilting the CURSOR/ENTER button in the latter program menu mode and press the CURSOR/ENTER button, the first program menu mode will be entered.

Continued

5

Repeat the above steps ②~④ until your selections is completed.

6

Start the programmed playback in the desired sequence.

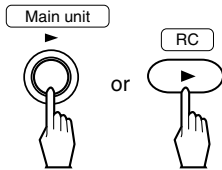

• If the programmed items are all played back, the program menu mode is resumed.

■ Correcting any wrong programmed item.

1

In the program menu mode, move to the program number you want by tilting the CURSOR/ENTER button repeatedly.

2

Replacing the wrong program item, performing the steps ② and ③ in “Playing back your selections in the preferred sequence” procedure on the previous page.

■ Clearing the programmed items.

▪ To clear a specific item

1

In the program menu mode, move to the program number you want by tilting the CURSOR/ENTER button repeatedly.

2

Clear the item you want.



• The item you want is cleared.

▪ To clear all programmed items.

• Open the disc tray or turn the power off to the standby mode.

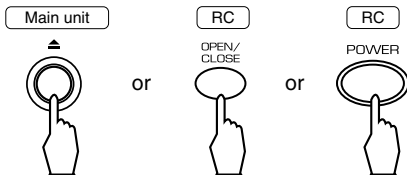

• Then all the programmed items are cleared.

Continued

When selecting the FAVORITE CONDITION

- Each time a DVD Video is loaded, the LANGUAGE, TV SCREEN and PROGRAM MENU settings should be adjusted to your favorite condition.
- However, once the LANGUAGE, TV SCREEN and PROGRAM MENU settings for a DVD Video are memorized using the SAVE FC (Favorite Condition), each time a disc is loaded, your chosen settings will be selected automatically.

1

After adjusting the LANGUAGE and TV SCREEN settings to your favorite condition, tilt the CURSOR/ENTER button upward or downward to select the FAVORITE CONDITION, then press the CURSOR/ENTER button.

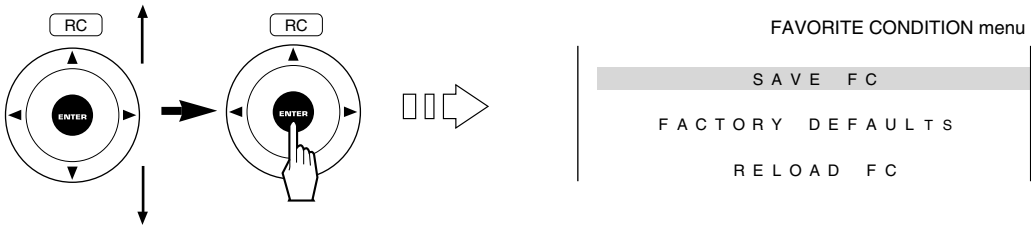

■ Memorizing the favorite condition for the LANGUAGE, TV SCREEN and PROGRAM MENU on the current disc.

- Each favorite condition for up to 30 DVD Videos can be memorized.

2

Tilt the CURSOR/ENTER button upward or downward to select the SAVE FC, then press the CURSOR/ENTER button.

- The EDIT TITLE mode that requires entering a disc title.

EDIT TITLE mode

EDIT TITLE
 █ - - - - -

3

Tilt the CURSOR/ENTER button upward or downward to enter the disc title as your preference.

- Each time the CURSOR/ENTER button is tilted upward or downward, the characters change as follows ;

→ 0 ↔ 1 ↔ 2 ↔ - - - - - ↔ A ↔ B - - - - - ↔ X ↔ Y ↔ Z ←

4

Tilt the CURSOR/ENTER button right or left to move to the next digit after a character is entered on the digit.

5

Repeat the above steps ③ and ④ until the preferred disc title is entered.

- Up to 8 characters can be entered.

Note : When the disc title is not entered, the favorite condition cannot be memorized.

6

Press the CURSOR/ENTER button to memorize the LANGUAGE, TV SCREEN and PROGRAM MENU settings along with the title entered.

- Then these are memorized and the "FAVORITE COND ON" is displayed on the DISC SETUP menu screen.
- After you change the favorite condition for the LANGUAGE, TV SCREEN and PROGRAM MENU on the same disc, if you perform the above steps ①~⑥, the changed condition is memorized.

■ Correcting a disc title

1. In the EDIT TITLE mode, tilt the CURSOR/ENTER button right or left to move to the character you want.
2. Tilt the CURSOR/ENTER button upward or downward repeatedly to select the preferred character.
 - On a character, if the CLEAR button on the remote control is pressed, the character is cleared.
3. Repeat the above steps 1 and 2 until the disc title is corrected as to your preference.

Continued

■ **Playing back a DVD Video in the factory settings for the LANGUAGE, TV SCREEN and PROGRAM MENU.**

- You can play back a DVD Video in the factory defaults for the LANGUAGE, TV SCREEN and PROGRAM MENU without clearing the favorite condition.

2 In the FAVORITE CONDITION menu, tilt the CURSOR/ENTER button upward or downward to select the FACTORY DEFAULTS, then press the CURSOR/ENTER button.

- Then FACTORY DEFAULTS is selected and the “FAVORITE COND OFF” is displayed on the DISC SETUP menu screen.

■ **Playing back a DVD Video in the favorite condition again.**

- In case FACTORY DEFAULTS is selected, if you select the RELOAD FC, the FACTORY DEFAULTS is canceled and you can play back a DVD Video in the favorite condition again.

2 In the FAVORITE CONDITION menu, tilt the CURSOR/ENTER button upward or downward to select the RELOAD FC, then press the CURSOR/ENTER button.

- Then the FAVORITE CONDITION is selected and the “FAVORITE COND ON” is displayed on the DISC SETUP menu screen.

When selecting the CLEAR DISC ID

- When a disc title is cleared, the memorized favorite condition is cleared, too.

1 Tilt the CURSOR/ENTER button upward or downward to select the CLEAR DISC ID, then press the CURSOR/ENTER button.

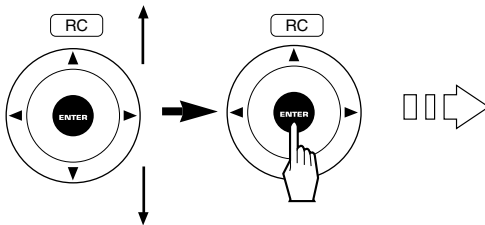

◆ DELETE ID	SELECT : +
DISC TITLE	DISC TITLE
ZORRO	BAT
ANT	HORSE
RABBIT	LION
COW	TIGER
MOUSE	ZEBRA
PAGE 1	
PREVIOUS ↑	NEXT ↓
RETURN : ↻	SETUP : FINISH

2 Tilt the CURSOR/ENTER button upward or downward to select the preferred disc title.

- To see the next page, move to “NEXT ↓” by tilting the CURSOR/ENTER button and then press the CURSOR/ENTER button and to see the previous page, move to “PREVIOUS ↑” by tilting the CURSOR/ENTER button and then press the CURSOR/ENTER button.

3 Clear the selected disc title.

- The favorite condition as well as the disc title is cleared.



4 Repeat the above steps ①~③ until the disc titles are cleared.

Definition Of Terms

DVD Video

This refers to a high-density optical disc on which high-quality pictures and sound have been recorded by means of digital signals. Incorporating a new video compression technology (MPEG II) and high-density recording technology. DVD Video enables esthetically pleasing full-motion video to be recorded over long periods of time (for instance, a whole movie can be recorded).

DVD Video has a structure consisting of two 0.6 mm thin discs which are adhered to each other. Since the thinner the disc, the higher the density at which the information can be recorded, a DVD Video has a greater capacity than a single 1.2 mm thick disc. Since the two thin discs are adhered to each other, there is the potential to achieve double-sided play sometime in the future for even longer duration play.

MPEG (DVD Video)

MPEG stands for Moving Picture Expert Group. It is regarded as an international standard for digital signal compression and restoration for media.

Track number (CD)

Track numbers are used to designate the various sections of a disc.

Title, Title number (DVD Video)

The title is the largest unit of the video/audio recording in DVD Videos. Usually, the title corresponds to a movie of video software or an album (or a piece) of music software. Title numbers are sequential numbers assigned to titles.

Chapter, Chapter number (DVD Video)

Chapters are divisions, which are smaller than the titles, of the contents recorded on DVD Videos. Every title is composed of more than one chapter. Chapter numbers are the sequential numbers assigned to the chapters in a DVD Video.

Aspect ratio (DVD Video)

The aspect ratio is the ratio between the vertical and horizontal size of the picture displayed on a TV screen. The aspect ratio of normal TV screen is 4:3 while that of the wide-screen TV and HDTV screens is 16:9.

Subtitle (DVD Video)

Some DVD Videos contain the recording of more than one subtitle languages. With these discs, this unit can select one of the subtitle languages as desired during playback.

Dolby Digital

This is the latest digital surround system developed by Dolby Laboratories. Discs bearing the "DOLBY DIGITAL" logo includes the recording of up to 5.1 channels of digital signals, which can reproduce much better sound quality, spatial expansion and dynamic range characteristics than the previous Dolby Surround effect.

Dolby Pro Logic

This is a specially encoded 2 channel surround format designed to provide theater-like surround sound from Dolby Pro Logic program sources bearing the "DOLBY SURROUND" logo.

Dolby Virtual

This employs sophisticated digital processing to create the illusion of five "phantom" speakers. Therefore, this allows you to experience a realistic multi-channel experience from the Dolby Digital, Dolby Pro Logic or 2 channel stereo digital audio (recorded in linear PCM) program source, through just a single pair of front speakers.

Manufactured under licence from Dolby Laboratories. "Dolby", "Pro Logic", and the double-D symbol are trademarks of Dolby Laboratories. Confidential Unpublished Works. © 1992-1997 Dolby Laboratories. All rights reserved.

DTS (Digital Theater Systems)

DTS is a newly-developed surround system which can handle more amount of data than Dolby Digital, providing better audio quality. Though the number of audio channels is 5.1 which is same as Dolby Digital, discs bearing the "DTS" logo provides fat sound and better signal-to-noise ratio, thanks to the lower audio compression ratio format. It also provides wide dynamic range and better separation, resulting in magnificent sound.

- Manufactured under license from Digital Theater Systems, Inc. US Pat. No. 5,451,942 and other world-wide patents issues and pending. "DTS" and "DTS Digital Surround" are trademarks of Digital Theater Systems, Inc. © 1996 Digital Theater Systems, Inc. All rights reserved.

MPEG Multichannel

This is a newly-developed surround system which faithfully reproduces the ambience and dynamics of movie soundtracks and music alike. Though the number of audio channels is 5.1 which is same as Dolby Digital, discs bearing the "MPEG Multichannel" logo is much better at locating individual sounds to the correct and stable position in the sound stage.

Circle Surround

This provides listeners with 5.1 discrete channels of surround sound from stereo recorded music or surround encoded movies.

- Circle Surround and the  symbol are trademarks of SRS Labs, Inc. in the United States and selected foreign countries. Circle Surround technology is incorporated under license from SRS Labs, Inc.

Troubleshooting Guide

If a fault occurs, run through the table below before taking your unit for repair. If the fault persists, attempt to solve it by switching the unit off and on again. If this fails to resolve the situation, consult your dealer. Under no circumstances should you repair the unit yourself as this could invalidate the warranty.

PROBLEM	POSSIBLE CAUSE	REMEDY
No power	<ul style="list-style-type: none"> The AC input cord is disconnected. Poor connection at AC wall outlet or the outlet is dead or off. 	<ul style="list-style-type: none"> Connect the cord securely. Check the outlet using a lamp or another appliance.
No playback	<ul style="list-style-type: none"> The disc is loaded upside down. The disc is not playable. The disc is dirty. The system setting is not adjusted correctly. The symbol or message about invalid operation is displayed. 	<ul style="list-style-type: none"> Reload the disc with the printed side up. Use a playable disc. Clean the disc. Adjust the system setting correctly. (Refer to "SETTING THE SYSTEM" on page 29.) Adjust the setting correctly. (Refer to "SYMBOL AND MESSAGE ABOUT INVALID OPERATION" on page 14.)
Malfunction	<ul style="list-style-type: none"> The disc is scratched or dirty badly. 	<ul style="list-style-type: none"> Press the POWER switch to switch the power off, press the POWER switch again and then unload the disc.
No picture	<ul style="list-style-type: none"> The video cords are disconnected. The incorrect selection of input source on the TV. The disc is not playable. 	<ul style="list-style-type: none"> Connect the cords correctly. Select the input source correctly. Use a playable disc.
Noisy or distorted picture	<ul style="list-style-type: none"> The unit is connected to a VCR directly and the copyguard function is activated. The disc is dirty. It is in rapid advance or reverse playback, or in frame advance or reverse playback. 	<ul style="list-style-type: none"> Connect the unit so that the picture signal is transferred directly to the TV. Clean the disc. Sometimes a small amount of picture distortion may appear. This is not a malfunction.
No sound	<ul style="list-style-type: none"> The audio cords are disconnected. The speakers are disconnected to the amplifier. The incorrect selection of input source on the amplifier. The audio setup is not adjusted correctly. 	<ul style="list-style-type: none"> Connect the cords correctly. Connect the speakers correctly. Select the input source correctly. Adjust the audio setup correctly. (Refer to "SETTING THE AUDIO SETUP" on page 32.)
No sound from the speaker(s) other than the front speakers.	<ul style="list-style-type: none"> The speaker(s) is (are) disconnected to the amplifier. The audio cord(s) is (are) disconnected. The SURROUND and SPEAKER OPTIONS are not adjusted correctly. 	<ul style="list-style-type: none"> Connect the speaker(s) correctly. Connect the cord(s) correctly. Adjust the settings correctly. (Refer to "SETTING THE AUDIO SETUP" on page 32.)
Noisy or distorted sound	<ul style="list-style-type: none"> The disc is dirty. Poor connections. 	<ul style="list-style-type: none"> Clean the disc. Check the connections and connect all cords securely.
Remote control unit does not operate.	<ul style="list-style-type: none"> Batteries are not loaded or are exhausted. The remote sensor is obstructed. 	<ul style="list-style-type: none"> Replace the batteries. Remove the obstacle.

Specifications

■ TYPE

- System DVD Video player system.
- Signal read system Semiconductor laser, wavelength 650 nm

■ D/A CONVERSION SECTION

- D/A conversion 24 bit
- Oversampling
Sampling frequency : 44.1, 48 kHz / 96 kHz 8 fs, 8 fs / 4 fs

■ AUDIO SECTION

- Frequency response
Sampling frequency : 44.1 kHz 4 Hz ~ 20 kHz
Sampling frequency : 48 kHz 4 Hz ~ 22 kHz
Sampling frequency : 96 kHz 4 Hz ~ 44 kHz
- Signal to noise ratio, A wtd.
CD 115 dB
- Dynamic range
16 / 20 / 24 bit More than 99 / 108 / 108 dB
- Total harmonic distortion, 1 kHz
CD Less than 0.003 %
- Wow and flutter Unmeasurable (less than $\pm 0.002\%$)
- Analog output level
MIXED AUDIO, 10k Ω 2.0 V
6.1 CH AUDIO : FRONT/CENTER/REAR/SUBWOOFER, 10K Ω 2.0 / 2.0 / 2.0 / 1.0 V
- Digital output / input level
COAXIAL, 75 Ω 0.5 Vp-p
OPTICAL, 660 nm - 21 ~ - 15 dBm

■ VIDEO SECTION

- Video compression, DVD Video MPEG 2
- Horizontal resolution 500 lines
- Signal to noise ratio More than 65 dB
- Output/input level, 75 Ω
VIDEO (regular, composite) 1.0 Vp-p
S-VIDEO : Y/C 1.0 / 0.286 Vp-p
COMPONENT : Y / R-Y / B-Y 1.0 / 0.7 / 0.7 Vp-p
R / G / B (For Europe only) 0.7 / 0.7 / 0.7 Vp-p

■ GENERAL

- Video format
U.S.A. and Canada NTSC
Europe and Australia PAL
China PAL
- Power supply
U.S.A. and Canada AC 120 V, 60 Hz
Europe and Australia AC 230 V / AC 240 V, 50 Hz
China AC 220 V, 50 Hz
Other countries AC 115 V / AC 230 V, 50 / 60 Hz
- Power consumption 40 W
- Dimension (W x H x D) 440 x 126 x 355 mm
(17-3/8 x 4-15/16 x 13-15/16 inches)
- Weight (Net) 6.2 kg (13.7 lbs)

Note : Design and specifications are subject to change without notice for improvements.

DVD Language Code List

Code No.	Language	Code No.	Language	Code No.	Language
6565	Afar	7473	Yiddish	8385	Sundanese
6566	Abkhazian	7487	Javanese	8386	Swedish
6570	Afrikaans	7565	Geogian	8387	Swahili
6577	Amharic	7575	Kazakh	8465	Tamil
6582	Arabic	7576	Greenlandic	8469	Telugu
6583	Assamese	7577	Cambodian	8471	Tajik
6588	Aymara	7578	Kannada	8472	Thai
6590	Azerbaijani	7579	Korean	8473	Tigrinya
6665	Bashkir	7583	Kashmiri	8475	Turkmen
6669	Byelorussian	7585	Kurdish	8476	Tagalog
6671	Bulgarian	7589	Kirghiz	8479	Tonga
6672	Bihari	7665	Latin	8482	Turkish
6678	Bengari ; Bangla	7678	Lingala	8484	Tatar
6679	Tibetan	7679	Laothian	8487	Twi
6682	Breton	7684	Lithuanian	8575	Ukrainian
6765	Catalan	7686	Latvian ; Lettish	8582	Urdu
6779	Corsican	7771	Malagasy	8590	Uzbek
6783	Czech	7773	Maori	8673	Vietnamese
6789	Welsh	7775	Macedonian	8679	Volapük
6865	Danish	7776	Malayalam	8779	Wolof
6869	German	7778	Mongolian	8872	Xhosa
6890	Bhutani	7779	Moldavian	8979	Yoruba
6976	Greek	7782	Marathi	9072	Chinese
6978	English	7783	Malay	9085	Zulu
6979	Esperanto	7784	Maltese		
6983	Spanish	7789	Burmese		
6984	Estonian	7865	Nauru		
6985	Basque	7869	Nepali		
7065	Persian	7876	Dutch		
7073	Finnish	7879	Nowegian		
7074	Fiji	7982	Oriya		
7079	Faroese	8065	Punjabi		
7082	French	8076	Polish		
7089	Frisian	8083	Pashto : Pushto		
7165	Irish	8084	Portuguese		
7168	Scots Gaelic	8185	Quechua		
7176	Galician	8277	Rhaeto-Romance		
7178	Guarani	8279	Romanian		
7185	Gujarati	8285	Russian		
7265	Hausa	8365	Sanskrit		
7273	Hindi	8368	Sindhi		
7282	Croatian	8372	Serbo-Croatian		
7285	Hungarian	8373	Singhalese		
7289	Armenian	8375	Slovak		
7365	Interlingua	8376	Slovenian		
7378	Indonesian	8377	Samoan		
7383	Icelandic	8378	Shona		
7384	Italian	8379	Somali		
7387	Hebrew	8381	Albanian		
7465	Japanese	8382	Serbian		



V-756

DVD PLAYER