

SHINDAIWA OWNER'S/OPERATOR'S MANUAL

**MULTIPURPOSE POLE
PRUNER ATTACHMENT 78701**

**For Models T230, T231, AH230, AH231,
PB230**



WARNING!

Minimize the risk of injury to yourself and others!
Read this manual and familiarize yourself with the
contents. Always wear eye and hearing protection
when operating this unit.

Introduction

The Shindaiwa Pole Pruner Attachment is designed and built to deliver superior performance and reliability without compromise to quality, comfort, safety or durability.

As an owner/operator, you'll soon discover for yourself why Shindaiwa is simply in a class by itself!

While every attempt has been made to provide the latest information about your Shindaiwa product, there may be some differences between your attachment and what is described here.

ECHO, Inc. reserves the right to make changes to products without prior notice, and without obligation to make alterations to units previously manufactured.

IMPORTANT!

The information contained in these instructions describes components available at the time of publication.

Contents

	PAGE		PAGE
Introduction	2	Specifications.....	5
Attention Statements	2	Maintenance	15
Safety	2	Sharpening the Chain	16
Product Description	5	Troubleshooting Guide	17
		Assembly	6
		Filling the Chain Oiler Reservoir.....	12
		Using the Pole Pruner	14

IMPORTANT!

The operational procedures described in this manual are intended to help you get the most from this unit as well as to protect you and others from harm. These procedures are guidelines for safe operation under most conditions, and are not intended to replace any safety rules and/or laws that may be in force in your area. If you have questions regarding your Shindaiwa hand held power equipment, or if you do not understand something in this manual, contact your local Shindaiwa dealer for assistance. You may also contact Shindaiwa at the address printed on the back of this Manual.

Attention Statements

Throughout this manual are special "attention statements".

DANGER!

A statement preceded by the triangular attention symbol and the word "DANGER" contains information that should be acted upon to prevent serious injury or death.

WARNING!

A statement preceded by the triangular attention symbol and the word "WARNING" contains information that should be acted upon to prevent serious bodily injury.

CAUTION!

A statement preceded by the word "CAUTION" contains information that should be acted upon to prevent mechanical damage.

NOTE:

A statement preceded by the word "NOTE" contains information that is handy to know and may make your job easier.

IMPORTANT!

A statement preceded by the word "IMPORTANT" is one that possesses special significance.

International Symbols

READ OPERATOR'S MANUAL Read and follow this manual, make sure anyone using the trimmer does likewise. Failure to do so could result in serious personal injury or machine failure. Keep this manual for future reference.

WEAR PROTECTION Always wear a hard hat to reduce the risk of head injuries during operation of this machine. In addition, always wear eye and hearing protection. Shindaiwa recommends wearing a face shield as additional face and eye protection.

Wear heavy duty, non-slip gloves.

Never operate this tool or any other power equipment if you are tired, ill, or under the influence of alcohol, drugs, or any substance that could affect your ability or judgement.

This product conducts electricity. Keep the product and/or operator a minimum distance of 15 feet (4.5 meters) away from electrical sources and power lines.

BYSTANDERS STAY CLEAR Keep bystanders at least 50 feet (15 meters) away from the operating trimmer to reduce the risk of being struck by falling objects or thrown debris.

Be aware of the danger of falling debris.

Safety

This machine operates at very high speeds and has the potential to do serious damage if misused, abused or mishandled. To reduce the risk of injury, you must maintain control at all times, and observe all safety precautions during operation. Never permit a person without training or instruction to operate this machine!

NOTE:

For specific maintenance and safety information about your T230/231, AH230/231, or PB230, consult the owner's manual provided with it. If it has been lost or misplaced, contact a Shindaiwa dealer for a replacement.



WARNING!

THE PRUNER IS NOT INSULATED AGAINST ELECTRICAL SHOCK!

Approaching or contacting electrical line with the pruner could cause death or serious injury. Keep the pruner at least 33 feet (10 meters) away from electrical lines or branches that contact electrical lines.

CAUTION!

- Always maintain the Pole Pruner Tool according to this owner's manual and follow the recommended scheduled maintenance.
- Never modify or disable any of the pruner's safety devices.
- Always use genuine Shindaiwa parts and accessories when repairing or maintaining this machine.
- Do not make unauthorized modifications to the pole pruner.
- When transporting the pole pruner in a vehicle, tie it down securely to prevent fuel spillage or damage to the machine.
- Always clear your work area of trash or hidden debris to help ensure good footing.
- Keep the chain sharp and properly adjusted.
- Keep the pole pruner as clean as possible. Keep it free of loose vegetation, mud, debris, etc.

Operating Precautions



WARNING!

- This Shindaiwa pole pruner attachment is specifically designed for use on the Shindaiwa T230/231 grass trimmers, AH230/231 articulating hedge trimmers, or PB230 power broom. Installation and/or use on any other model, brand or type of power tool is not approved by Shindaiwa. Attempts to use on non-approved models can damage the equipment and cause accidents, serious injury or death.
- Make sure the chain and sprocket are correctly adjusted before operating the pruner (see assembly for adjustment procedures). **Never attempt chain adjustment with the engine running!**
- Always make sure the cutting attachment is properly installed and firmly tightened before operation.
- Never use a cracked or warped guide bar: replace it with a serviceable one and make sure it fits properly.
- If a saw blade should bind fast in a cut, shut off the engine immediately. Push the branch or tree to ease the bind and free the blade.
- Before starting the engine, make sure the saw chain is not contacting anything.
- When cutting a limb that is under tension, be alert for springback so that you will not be struck by the moving limb.
- Always run at wide open throttle (WOT) before contacting material to be cut.
- Always stop the engine immediately and check for damage if you strike a foreign object or if the machine becomes tangled. Do not operate with broken or damaged equipment.
- Stop the machine immediately if it suddenly begins to vibrate or shake. Inspect for broken, missing or improperly installed parts or attachments.
- Never transport the pruner or set it down with the engine running. An engine that's running could be accidentally accelerated causing the chain to rotate.
- Make sure the scabbard is in place when transporting the pruner.
- When carrying by hand, the chain should be pointing backward.
- **ALWAYS** keep a Solid Stance. Maintain footing and balance at all times. Do not stand on slippery, uneven or unstable surfaces. Do not work in odd positions or on ladders. Do not over reach.

Operating the Pruner



WARNING!

To avoid the chance of serious injury or death, follow these safety precautions during operation:

Always wear a hard hat to reduce the risk of head injuries during operation of this machine.

Wear nonslip heavy-duty work gloves to improve your grip on the pole pruner handle. Wear snug-fitting clothes that also permit freedom of movement. NEVER wear shorts!

Keep a proper footing and do not overreach—maintain your balance at all times during operation.



Always wear eye and hearing protection. Shindaiwa recommends wearing a face shield as additional face and eye protection.

Keep bystanders at least 50 feet (15 meters) away from the operating pruner to reduce the risk of being cut by moving saw chain or struck by falling objects or thrown debris.

Never operate the pruner at an angle greater than 60° in order to reduce the risk of being struck by falling objects during operation.

Always operate with both hands firmly gripping the machine.

Wear sturdy footwear with nonslip soles to provide good footing. Steel-toed safety boots are recommended. Never operate this product barefoot.

Kickback and Pinching Safety Precautions



WARNING!

Both kickback and pinching may cause you to lose control of the pole pruner tool which could result in serious personal injury. **Do not rely exclusively on the safety device built into the pruner!** You must take several steps to keep your jobs free from accident or injury:

1. Understand kickback and pinching! You can reduce or eliminate the element of surprise. Sudden surprises contributes to accidents.

2. Keep a firm grip on the pole pruner with both hands whenever the engine is running. A firm grip will help you reduce the affects of kickback and pinching as well as maintain control of the machine.
3. Make sure the area in which you are cutting is free from obstructions. Do not let the nose of the guide bar contact a log, branch, or any other obstructions which could be hit while you operate the pole pruner tool.

4. Cut at high engine speeds.
5. Follow the manufacturer's instructions for sharpening and maintaining the chain.
6. Use only the replacement bar and chain or equivalent as specified by the manufacturer.

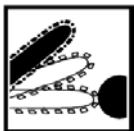

Beware of Kickback!

Kickback can occur whenever the tip of the guide bar touches an object while the saw is operating. Kickback may force the bar up and back toward the operator with lightning-like speed!

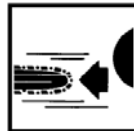

Beware of pinching.

Pinching the saw along the tip of the guide bar may force the bar back rapidly toward the operator. Pinching can occur whenever wood closes in around the moving chain.

Safety Labels

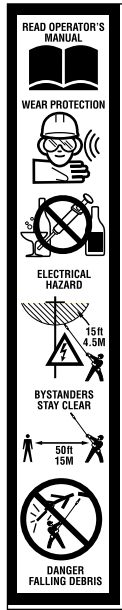

IMPORTANT!

Safety and Information Labels: Make sure all safety and information labels are undamaged, readable and up to date. Immediately replace damaged or missing labels.

This Attachment comes with safety labels shipped loose in the box. Attach these safety labels.

New labels are available through your local authorized Shindaiwa dealer.

Product Description

Using the illustration as a guide, familiarize yourself with your machine and its various components. Understanding your machine helps ensure top performance, long service life and safer operation.

- A - Gearcase
- B - Oil Filler Cap
- C - Guide Bar and Chain
- D - Bar Oil Reservoir

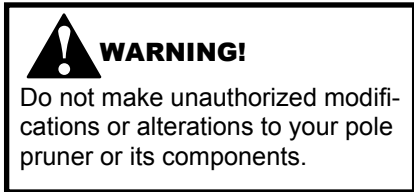
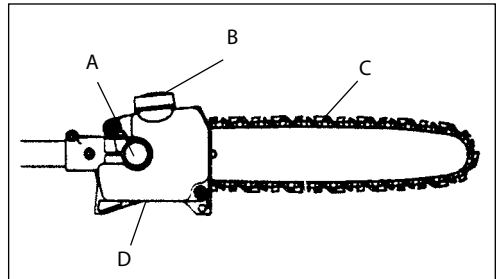

Specifications

Length mounted on T230 w/10 inch bar.....	1991 mm (78.4 in)	Sprockets.....	3/8-inch, fixed spur
Dry Weight (Tool only)with bar and chain.....	0.91 kg (2.0 lbs)	Gearcase Ratio.....	1.06 : 1
Guide Bar.....	3/8" pitch, .043" gauge, 10-inch Micro Lite™	Chain Lubrication.....	Automatic adjustable oiler
Chain Type.....	3/8" pitch Micro Lite™, .043" gauge	Oil Tank Capacity.....	100 ml./3.9 oz.

Specifications are subject to change without notice.

Prior To Assembly

Before assembling, make sure you have all the components required for a complete unit:

- Gearcase assembly
- Guide Bar
- Saw Chain
- Heat-shrink Collar

- Throttle Grip w/interlock
- Scabbard
- Owner's/Operator's manual
- Assembly Tool (s)
- Safety Labels

Carefully inspect all components making sure they are not damaged.

IMPORTANT!

The terms "left", "left-hand", and "LH"; "right", "right-hand", and "RH"; "front" and "rear" refer to directions as viewed by the operator during normal operation.

Assembly

Installing The Interlock Throttle Grip

NOTE:

The steps on pages 6 - 8 are not necessary for models AH230 and AH231 because they come equipped with an interlocking throttle grip assembly as standard equipment.

Remove Outer Tube From Powerhead

1. Place the T230 or PB230 on a clean flat surface, in an upright position.
2. Remove the cylinder cover as instructed in your unit owner's manual.
3. Loosen the inner throttle cable adjusting nut with a 10 mm wrench.
4. Lift the throttle cable housing out of the notch on the powerhead.
5. Remove the throttle cable from the carburetor by lifting the Z-shaped cable end (A) out of the hole.

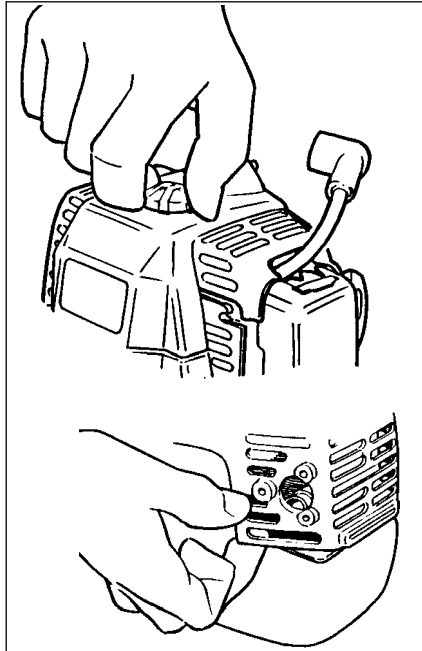

6. Disconnect the red stop switch wire (B) by unplugging the bullet connector.
7. Use the 4 mm hex wrench to loosen the tube clamp screw (C). Loosen, but don't remove the screw, or the D-shaped shim washer (D) will fall out.
8. Pull the tube assembly out of the clamp. Set the powerhead aside.

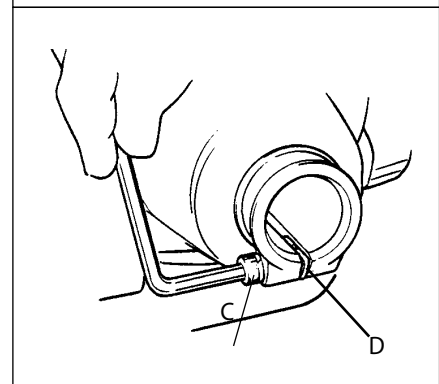
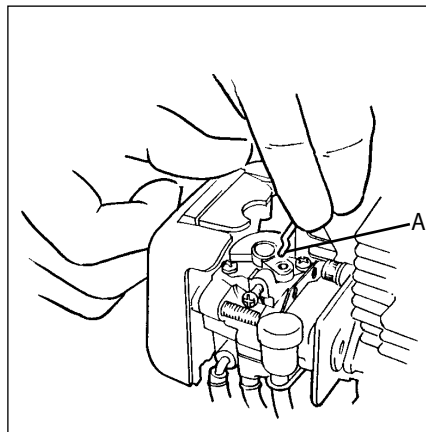
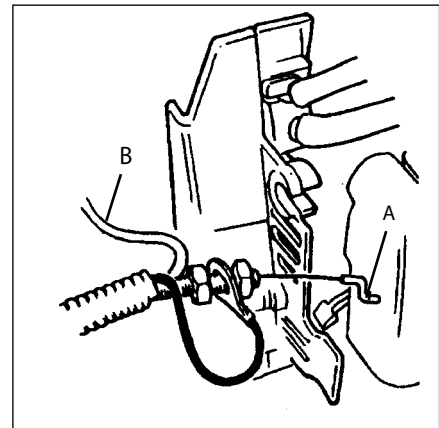

Installing Throttle Grip



WARNING!

- Failure to replace the standard throttle grip with the provided interlock throttle grip could permit unintentional acceleration, which could cause serious injuries or death.

1. Place the T230 or PB230 outer tube assembly on a clean, flat surface.
2. Loosen the three screws (A) that hold the throttle trigger assembly to the outer tube.
3. Slide the trigger assembly down the tube, several inches away from the rubber grip. Rotate the trigger assembly so it is flat against the work surface.
4. With a utility knife or similar tool (B), slit the rubber grip lengthwise to release it from the tube. Use gentle pressure to avoid scarring the outer tube.

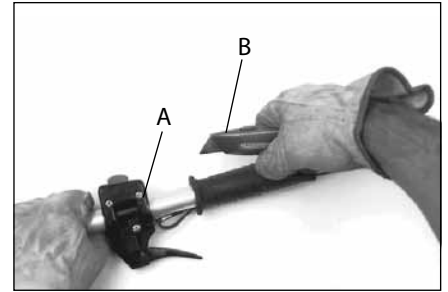

WARNING!

- To avoid serious injury, grip the outer tube securely with one hand and cut away from that hand when slitting the rubber throttle grip.

5. Remove the grip and slide the throttle trigger from the tube. Discard these parts.
6. Clean surface of tube in grip area.
7. Make a mark on the tube, 2 inches from the upper end. Slide the heat shrink collar (C) onto tube and align its upper end with the mark on the tube.
8. Using a heat gun or hair dryer, apply heat to the collar until it shrinks and forms a snug fit around the tube.
9. Slide the new interlock throttle grip assembly (D) onto the tube, and position it over the collar. Make sure the switch is facing up, and that the throttle cable and switch wires (E) are positioned toward the powerhead. Using a cross-head screwdriver, tighten the grip's four clamp screws (F).

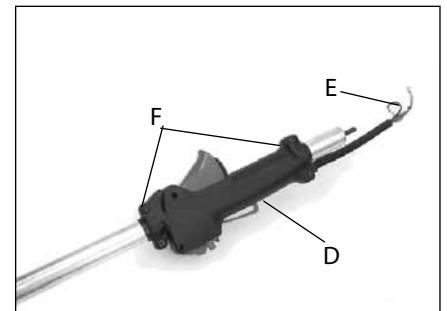
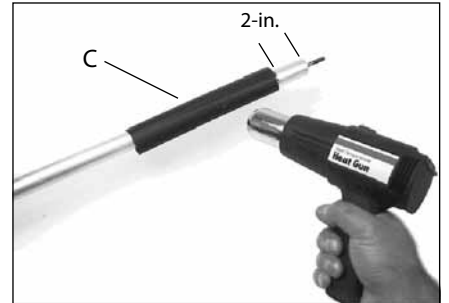

Powerhead Reinstallation

1. Place the powerhead on a clean, flat surface in an upright position.

CAUTION!

Do not remove the D-shaped shim washer! The shim washer prevents damage from overtightening the tube clamp screw.

2. Slide the outer tube (G) into the tube clamp (H) until the outer tube bottoms. It should go in about 1-1/2 in. (38 mm). If the outer tube stops before bottoming, rotate it until you feel the inner driveshaft (I) splines engage the powerhead. Then push the outer tube all the way in.

CAUTION!

Do not force the lower tube into the powerhead! Excessive force can damage the components.

3. Position the outer tube so the stop switch is facing up and the throttle cable/wire assembly (J) is on top.

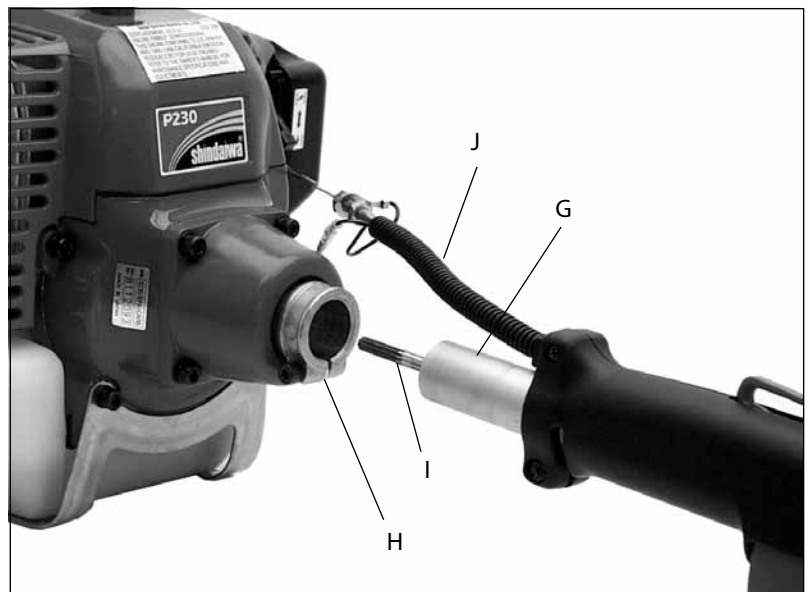

4. Use the hex wrench to tighten the clamp screw firmly. Make sure the D-shaped shim washer is in place.

Reconnecting the Throttle Cable, Switch Wires

Connect The Throttle Cable.

1. Loop the ribbed cable assembly to the top left side of the engine. Confirm that the black ground wire (A) (with an eyelet on the end) is located between the two cable adjuster nuts (B).
2. Connect the Z-shaped end of the throttle cable (C) to the throttle lever on top of the carburetor.
3. Turn the cable adjuster nuts sufficiently for the throttle cable to fit in the notch (D) on the fan cover. Make sure the ignition ground lead is located on the rearward side of the notch. Then, connect the male fitting of the red ignition wire into the female fitting of the red wire attached to the engine (E).

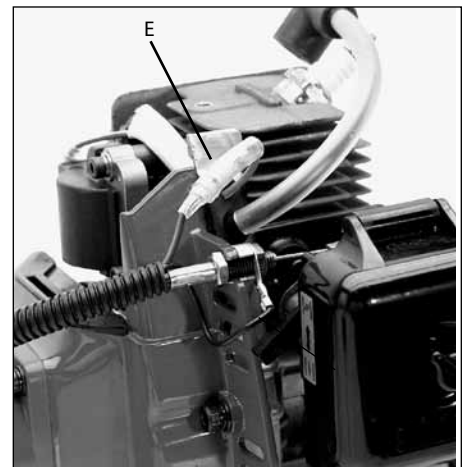
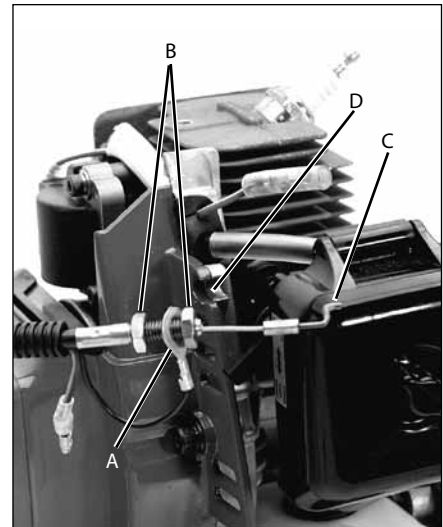
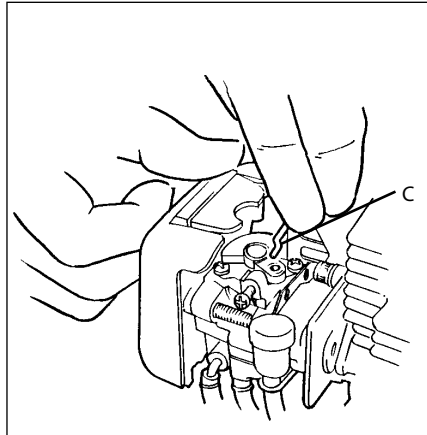

Adjusting the Throttle Cable

1. Loosen the two 10mm throttle cable nuts (B).



- Adjust the throttle cable nuts until you achieve a free play on the throttle trigger of about 1/4 inch.

IMPORTANT!

Make sure the stop switch wires do not interfere with throttle functions. Reposition wires if necessary.

- When 1/4-inch of free play is achieved, securely tighten the two 10mm throttle cable nuts. When the throttle cable is correctly adjusted, and the throttle trigger is fully depressed (full throttle), the throttle will contact the stop on the throttle body (F).

NOTE:

Apply anti-seize oil on the cylinder cover knob threads for easier removal.

- Replace the cylinder cover.
- Replace the spark plug boot.

Removing the Trimmer/PowerBroom Attachment

- Place the re-gripped T230, PB230, or AH230 on a clean, flat surface in an upright position.

For the T230/T231 Trimmers:

- Loosen, but don't remove the gearcase clamp screw (A) and nut using a 4 mm hex wrench and an 8 mm open end wrench.
- Use the 4 mm hex wrench to loosen the gearcase index screw (B) until it is almost free.
- Use the 4 mm hex wrench to loosen the four debris shield attachment screws (C). Loosen them only enough to free the debris shield assembly from the outer tube. This will make it easier to reattach the debris shield when converting back to a trimmer.
- Pull and rotate the debris shield, gearcase, and trimmer head assembly until it slides off the outer tube.

NOTE:

The gearcase and debris shield are connected by the clamp screw.

- The debris shield has two shims (D) located on either side of the outer tube and the debris shield bracket. Put the shims and the debris shield/gearcase assembly in a safe place, so that they can be reinstalled later if desired.

For the PB230 PowerBroom:

- Using a 5 mm hex wrench and a 10 mm open end wrench, loosen, but don't remove, the gearcase clamp screw.
- Using the 4 mm hex wrench, back out the index screw until it is almost free.
- Pull and rotate the gearcase/sweeper drum assembly until it slides off the outer tube.
- Remove the spacer from the outer tube if it did not slide off with gearcase/ sweeper drum assembly. Put the spacer and gearcase/sweeper drum assembly in a safe place, so they can be reinstalled later if desired.
- If your PB230 is equipped with the optional guard assembly, it must be removed. Use 4 mm hex wrench to remove its four clamp screws. Slide the protective collar off the outer tube.

For the AH230/AH231 Hedge Trimmers:

- Loosen, but don't remove the gearcase clamp screw using a 4 mm hex wrench.
- Use the 4 mm hex wrench to loosen the gearcase index screw until it is almost free.
- Pull and rotate the gearcase/articulating hedge trimmer assembly until it slides off the outer tube.

NOTE:

For help reinstalling the original gearcase and attachments, consult the owner's manual that came with your T230, T231, AH230, AH231, or PB230.

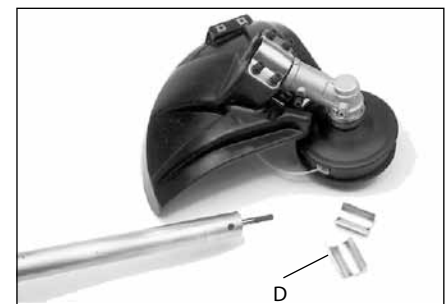
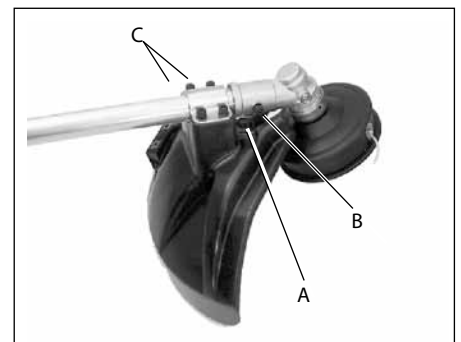
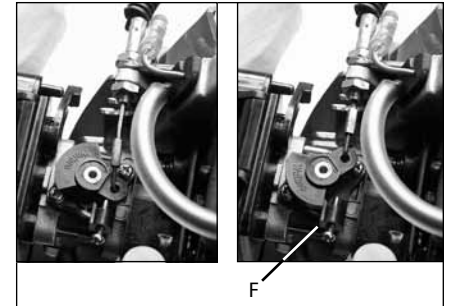

Installing the Caution Labels



WARNING!

- The provided labels offer important safety information about pole pruners. Do not operate, or allow others to operate, this machine unless the labels are properly installed.

1. Clean outer tube so the labels will adhere properly.
2. Peel the backing off the multiple warning label and attach below similar label on lower part of outer tube. Make sure label faces up and that it is legible from the operator's position.
3. Peel the backing off "The Electrical Shock Danger" label and attach it just ahead of the throttle grip. Make sure the label faces up and that it is legible from the operator's position.

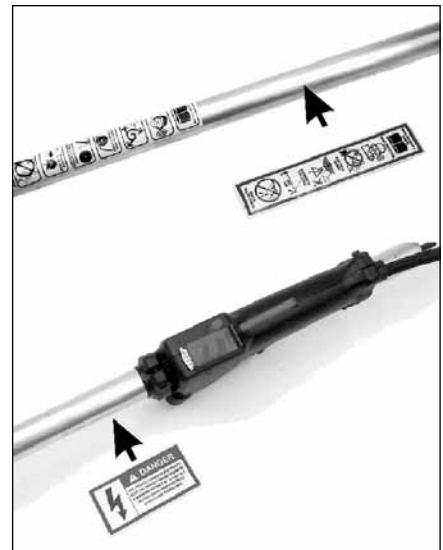

Installing the Cutting Head Assembly

1. Insert the end of the outer tube into the pole pruner gearcase clamp assembly and push until it bottoms. The outer tube should go into the gearcase about 1-1/2 in. (38 mm). If the outer tube stops before bottoming, rotate it until you feel the inner mainshaft (driveshaft) splines engage the gearcase. Then push the outer tube all the way in.
2. Rotate the gearcase assembly so that the index screw (A) aligns with hole in outer tube (B).
3. Use a 4 mm hex wrench to tighten the gearcase index screw first, then the gearcase clamp screw.

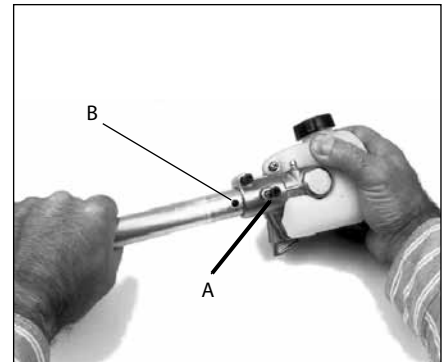

Adjust Loop Handle

1. Shindaiwa recommends leaving the T230 or PB230 loop handle on the outer tube. However, for maximum comfort and control, it may require adjustment. Use the 4 mm hex wrench to loosen the handle's four clamp screws (C). Move the handle along the tube to the point where the most comfort and control are observed. Retighten the clamp screws.

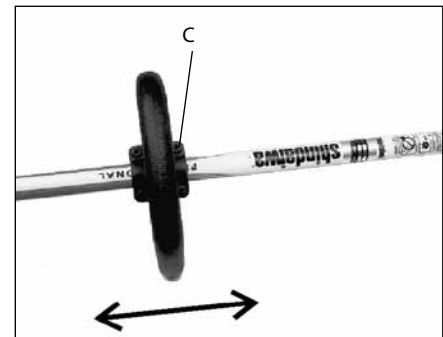

Installing and Adjusting the Bar and Chain

Installing The Chain



WARNING!

Never attempt to install, replace, or adjust the chain with the engine running.



WARNING!

The saw chain is very sharp. Wear gloves to protect your hands when handling.

NOTE:

For the longest chain life, let new or replacement chain loops soak in oil overnight before installation.

1. Using the small end of the plug wrench, remove the sprocket cover nut (A) (turn counterclockwise to remove) and remove the sprocket cover (B).

CAUTION!

Failure to align the guide bar and chain tensioning pin can cause serious damage to the sprocket cover, guide bar, chain tensioning pin and cutting head assembly.

2. Place the guide bar (C) over the guide bar adjustment stud (D) on the cutting head assembly. Align the chain tensioning pin (E) with the hole in the guide bar.
3. Install the chain loop over the drive links within the guide bar groove, and then align the chain over the drive sprocket. Make sure the cutters are properly oriented as shown. If the chain installation is difficult or if the chain appears too tight, refer to the section "Adjusting the Chain."



WARNING!

Never operate the pole pruner tool without the sprocket cover installed.

4. Install the sprocket cover over the bar stud. Using finger-pressure only, install the sprocket cover nut.
5. Refer to the next page for chain adjusting procedures.

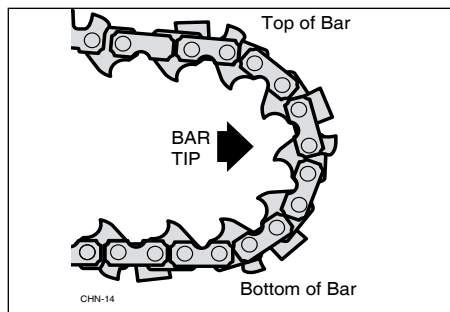
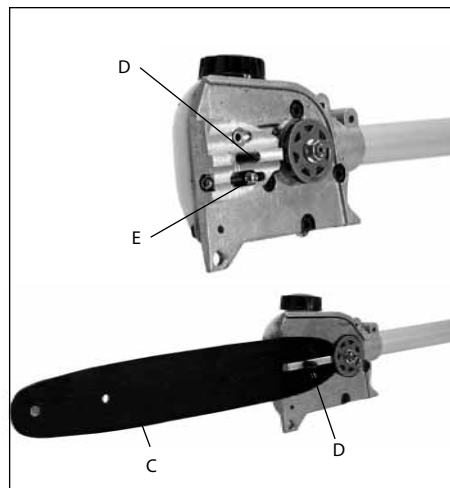
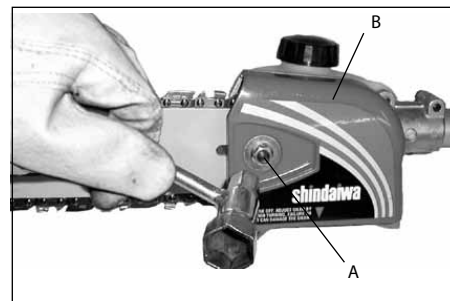

Adjusting the Chain



WARNING!

Never attempt to install, replace, or adjust the chain with the engine running.



WARNING!

The saw chain is very sharp. Wear gloves to protect your hands when handling.

CAUTION!

A loose chain can jump off the guide bar causing damage to the chain and associated equipment. Always make sure the chain is properly adjusted; check more often when you are breaking in a new chain.

IMPORTANT!

Proper chain adjustment is essential for maximum performance, long chain life, and operator safety. Always inspect chain tension before operating the pole pruner tool.

1. Place the pole pruner on a clean, flat surface. (For readjustment during operation, shut down the engine, then allow the guide bar and chain to cool before proceeding with the adjustment procedure).
2. Loosen the sprocket cover nut (A) with the plug wrench.
3. Lift the nose of the guide bar while turning the chain tensioning screw (B).
 - clockwise to tighten the chain
 - counter clockwise to loosen the chain.
4. Pull the chain by hand along the top of the guide bar several times from the engine to the bar's tip. The chain should feel snug but still pull freely.
5. Tighten the sprocket cover nut securely while lifting the tip of the guide bar.
6. Inspect the chain for the correct adjustment (more frequently with a new chain). The chain should feel snug but still pull freely.

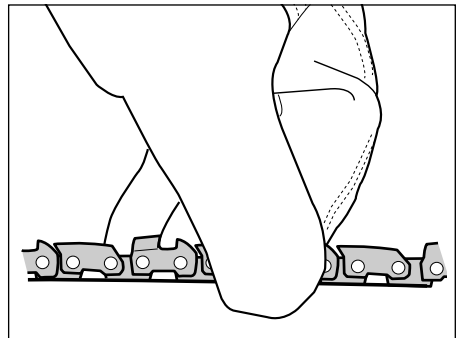
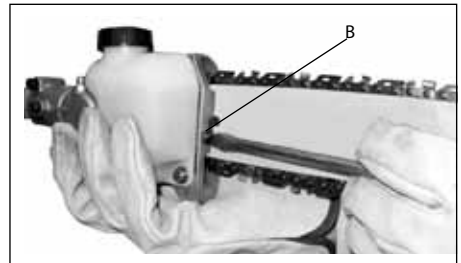
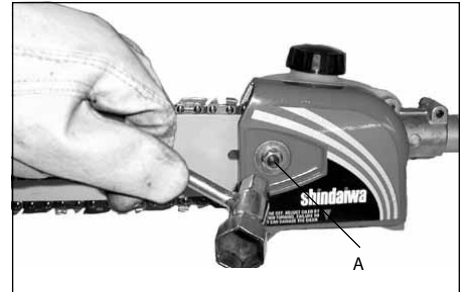

Filling the Chain Oiler Reservoir



WARNING!

Never fill the oil reservoir or adjust the oiler with the engine running.

IMPORTANT!

To prevent plastic deterioration, do not use synthetic or silicone based oil.

1. Place the pole pruner tool on a clean, flat surface with the oil filler cap (C) facing up. Wipe off any debris from the oil cap and from around the oil filler neck.
2. Remove the oil filler cap (C) and fill the reservoir with bar and chain oil, then replace the cap.
3. Wipe up any spilled oil from the unit before restarting the pole pruner.

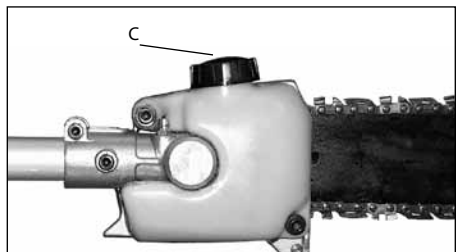

Adjusting Oil Flow Rate

NOTE:

The automatic oiler is preset to deliver a sufficient oil discharge volume during normal operating conditions. During heavy or dry cutting conditions, the oil discharge volume may be increased to assure adequate lubrication. If oil is leaking from the bar cover area, reduce the oil discharge volume. Refill the oil reservoir with each tank of fuel.

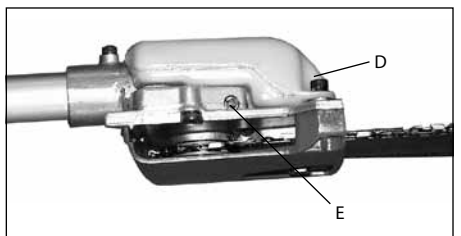

NOTE:

Very little visible oil on the saw chain will provide sufficient lubrication.

Adjust the pump as follows:

1. Stop the engine and make sure the stop switch is in the OFF position.
2. Place the unit on its side with the oil reservoir (D) up.
3. Using a screwdriver, turn the oil flow rate adjustment screw (E) in the desired direction:
 - clockwise—decrease lubrication.
 - counter clockwise—increase lubrication.

Starting Engine – Interlock Throttle Controls

IMPORTANT!

The engine ignition is controlled by a two-position ON-OFF switch mounted on the throttle grip assembly, typically labelled “I” for START and “O” for STOP.



WARNING!

The attachment will operate immediately when the engine starts, and could result in possible serious injury. Keep movable parts of the attachment away from objects that could become entangled or thrown, and surfaces that could cause loss of control.

Control Positions (cold engine)

1. Slide the ignition switch (A) to the “ON” position.
2. Set the throttle trigger to the “fast idle”:
 - a. Depress and hold the throttle lock (B), then squeeze the throttle trigger.
 - b. Depress and hold the fast idle button (C).
 - c. Release the throttle trigger and throttle lock, then release fast idle button.
3. Press the purge bulb (D) four or five times. You should be able to see fuel inside the bulb.
4. Choke the engine by moving the choke lever (E) up to the “closed” position.

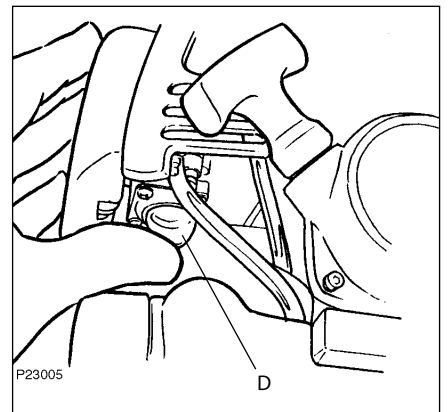
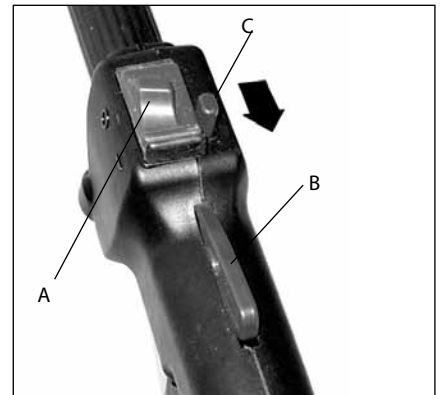

Control Positions (warm engine)

1. Set the throttle trigger to “fast idle”
2. Slide the ignition switch to the “I” (ON) position.
3. Moving the choke lever down to the “open” position.

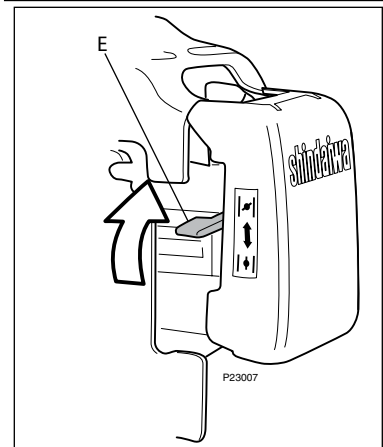

Using the Pole Pruner

This machine is designed especially for cutting branches.

Never use this machine for any other purpose. Never try to cut stones, metals, plastics, or any other hard objects.

Using for purposes other than cutting branches may damage the machine or cause serious injury.

Preparations

- Wear suitable protective clothing and equipment – see section “Safety Precautions”.
- Choose the best work position for safety against falling objects such as branches.
- Start the engine.
- Put on the strap.

Never stand directly underneath the branch you are cutting – be aware of falling branches. Note that a branch may spring back at you after it hits the ground.

Cutting Sequence:

To allow branches to fall freely, always cut the bottom branches first. Prune heavy branches (large in diameter) in several controllable pieces.

Working Position:

Hold the control handle with your right hand and the shaft with your left hand. Your left arm should be extended to the most comfortable position.

The shaft should always be held at an angle of 60° or less.

Standard Cut:

The most convenient working position is a tool angle of 60°, but any other angle may be used to suit the situation.

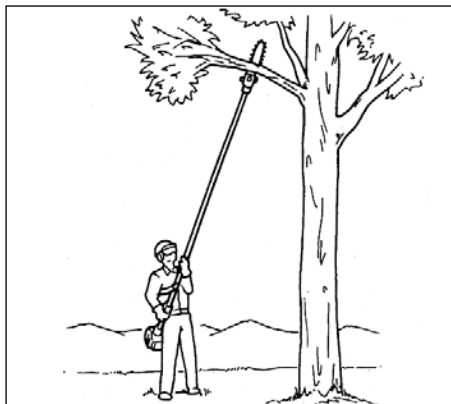

Cutting On A Work Platform:

The unit's long reach enables cutting to be performed next to the trunk without the risk of the work platform damaging other branches. Tool angle in this case depends on the position of the branch.

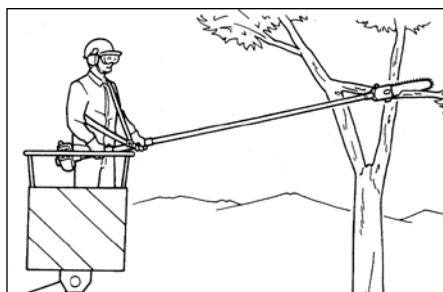

Relieving Cut:

To avoid tearing the bark, kickback or pinching the bar when pruning thick branches, always start by performing a relieving cut (1) on the underside of the branch.

To do this, apply the cutting attachment and pull it across the bottom of the branch as far as the bar nose. Perform the cross-cut (2).

Cutting Above Obstacles:

Thanks to the unit's long reach it is possible to prune branches that are overhanging obstacles such as rivers or lakes. The tool angle in this case depends on the position of the branch.

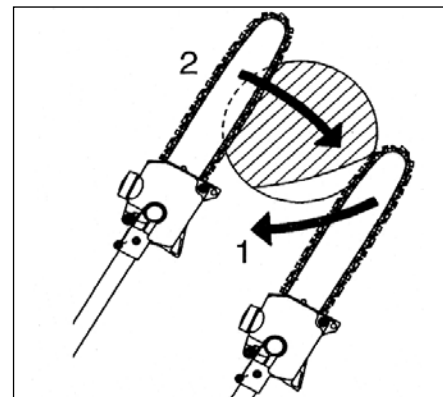
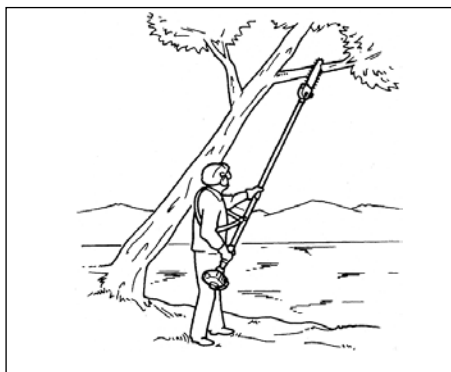

Flush-cutting Thick Branches:

If branch diameter is more than 10 cm, first perform undercut (3) and cross-cut at a distance (A) of about 25 cm from the final cut. Then carry-out the flush-cut (4), starting with a relieving cut and finishing with a cross-cut.

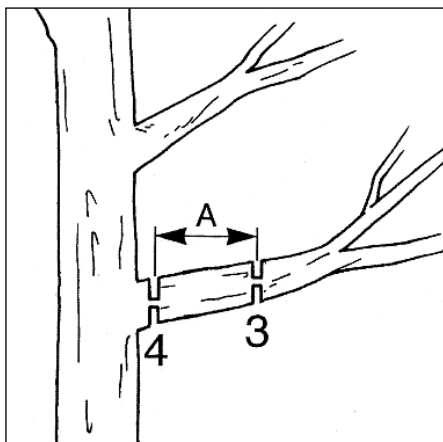

Maintenance

IMPORTANT!

For detailed maintenance information about your T230/231, AH230/231, or PB230, consult the owner's manual that was provided with it. If it has been lost or misplaced, contact Shindaiwa for a replacement.



WARNING!

Before performing any maintenance, repair, or cleaning work on the unit, make sure the engine and cutting attachment are completely stopped. Disconnect the spark plug wire before performing service or maintenance work.



WARNING!

Non-standard parts may not operate properly with your unit and may cause damage and lead to personal injury.

IMPORTANT!

Using non-standard replacement parts could invalidate your Shindaiwa warranty.

Daily Maintenance



WARNING!

The saw chain is very sharp. Wear gloves to protect your hands when working with or around the saw chain.

Prior to each work day, perform the following:

- Clean any debris or dirt from the cutting attachment. Check the bar and chain for damage or incorrect adjustment.

- Check for loose or missing screws or components.
- Check the entire machine for leaking fuel or grease.
- Make sure that nuts, bolts, and screws (except carburetor adjusting screws) are tight.

15-hour Maintenance

Every 15 hours of operation (more frequently in dusty or dirty conditions):

- Remove the sprocket cover and inspect the sprocket (A) for excessive dirt, debris, or wear. Remove the guide bar and clean out the guide bar groove. If the sprocket is excessively worn, replace it with a new one.

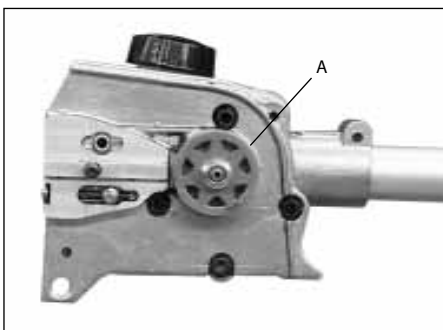

50-hour Maintenance

Every 50 hours of operation (more frequently in dusty or dirty conditions):

- Lubricate the gearcase. To perform this operation, first remove the gearcase from the upper outer tube as follows.

CAUTION!

Do not remove the D-shaped shim washer from the gearcase clamp! The shim washer prevents damage from overtightening the tube clamp screw.

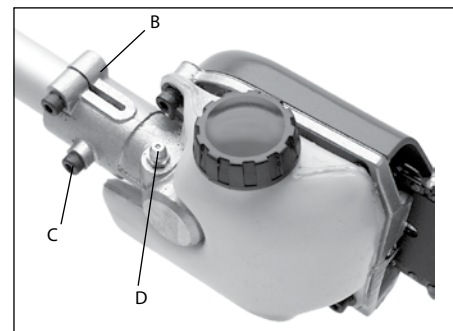

- loosen the gearcase clamp bolt (B).
- remove the index bolt (C) from the gearcase.
- slide the gearcase out of the tube.
- Using a lever-type grease gun, pump lithium-base grease (about 10 grams) into the grease fitting (D) until you see old grease being purged from the gearcase, which can be seen in the outer tube cavity. Clean up excess grease, then reassemble the gearcase onto the outer tube.

Sharpening the Chain

- When the cutting edges of the blade become dull, they can be re-sharpened with a few strokes of a file.
- In order to keep the blade in balance, all cutting edges must be sharpened equally.
- In addition, inspect the chain for correct adjustment (more frequently with a new chain). The chain should feel snug but still pull freely. Refer to adjustment procedures.

CAUTION!

Keep the chain sharp and properly adjusted.



WARNING!

The saw chain is very sharp. Wear gloves to protect your hands when working with or around the saw chain.

Sharpening Instructions

IMPORTANT!

File all the cutters to the same angle and depth! Unequal filing may cause the saw to vibrate or cut erratically!

1. Using a 4.5 mm round file, sharpen all cutters to a 30° angle. Make sure that one fifth (20%) of the file's diameter is always held above the cutter's top plate.
2. After all cutters are sharpened, use a depth gauge joiner (A) to measure the height of each depth gauge.
3. As required, lower the depth gauges to a height of 0.025 inch. Use a flat file.
4. After all depth gauges have been adjusted, use a flat file to round each depth gauge leading edge to its original curvature and angle.

NOTE:

For consistent filing angles, use a filing guide.

NOTE:

See specification page for replacement bar and chain specs.

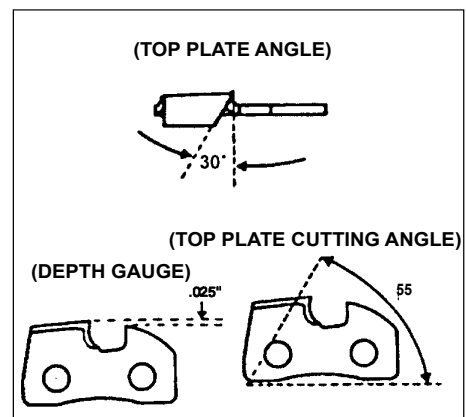
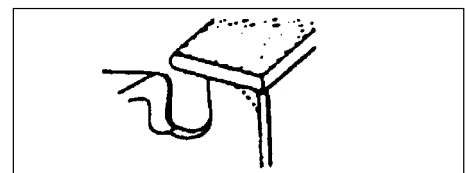
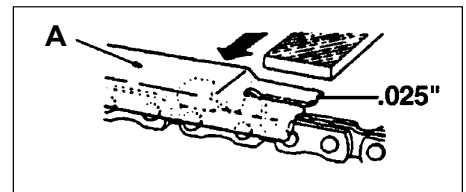
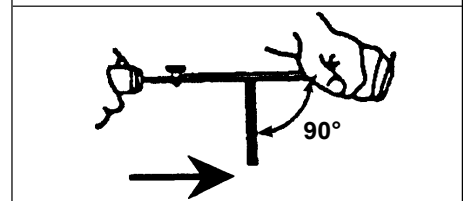
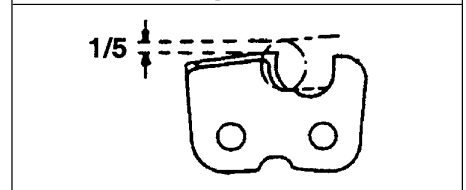
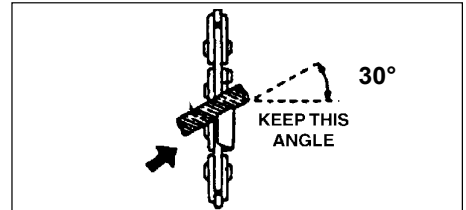
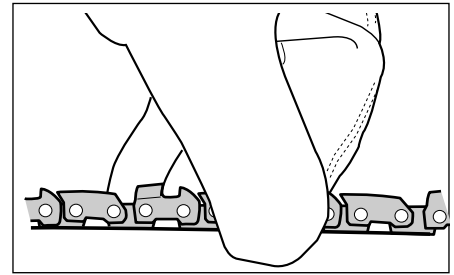

Troubleshooting Guide

ADDITIONAL PROBLEMS

Symptom	Possible Cause	Remedy
Excessive vibration.	Warped or damaged attachment. Loose gearcase. Bent main shaft/worn or damaged bushings.	Inspect and replace attachment as required. Tighten gearcase securely. Inspect and replace as necessary.
Cutting attachment will not move.	Shaft not installed in powerhead or gearcase. Broken shaft. Damaged gearcase.	Inspect and reinstall as required. Consult with an authorized Shindaiwa servicing dealer.
Cutting attachment moves at engine idle.	Engine idle too high. Broken clutch spring or worn clutch spring boss.	Adjust idle. Check Specifications page for correct idle speed. Replace spring/shoes as required, check idle speed.

Servicing Information

Parts/Serial Number

Genuine Shindaiwa Parts and Assemblies for your Shindaiwa products are available only from an Authorized Shindaiwa Dealer. When you do need to buy parts **always** have the Model Number, Type and Serial Number of the unit with you. You can find these numbers on the engine. For future reference, write them in the space provided below.

Model No. _____ SN. _____

Service

Service of this product during the warranty period must be performed by an Authorized Shindaiwa Service Dealer. For the name and address of the Authorized Shindaiwa Service Dealer nearest you, ask your retailer or call: 1-877-986-7783. Dealer information is also available on WWW.SHINDAIWA.COM. When presenting your unit for Warranty service/repairs, proof of purchase is required.

Consumer Product Support

If you require assistance or have questions concerning the application, operation or maintenance of this product you may call the Shindaiwa Consumer Product Support Department at 1-877-986-7783 from 8:30 am to 4:30 pm (Central Standard Time) Monday through Friday. Before calling, please know the model and serial number of your unit.

Warranty Registration

To ensure trouble free warranty coverage it is important that you register your Shindaiwa equipment by filling out the warranty registration card supplied with your unit. Registering your product confirms your warranty coverage and provides a direct link if we find it necessary to contact you.

Additional or Replacement Manuals

Replacement Operator and Parts Catalogs are available from your Shindaiwa dealer or at WWW.SHINDAIWA.COM or by contacting the Consumer Product Support Department (1-877-986-7783). Always check WWW.SHINDAIWA.COM for updated information.

shindaiwa[®]

ECHO Incorporated.
400 Oakwood Road
Lake Zurich, IL 60047-1564 U.S.A.
Telephone: 1-877-986-7783
Fax: 1-847-540-8416
www.shindaiwa.com

Yamabiko Corporation
7-2 Suehirocho 1-Chome, Ohme,
Tokyo, 198-8760, Japan
Phone: 81-428-32-6118
Fax: 81-428-32-6145