

SHURE

LEGENDARY
PERFORMANCE™



MXW Wireless Conference System



10/02/12

IMPORTANT SAFETY INSTRUCTIONS

1. READ these instructions.
2. KEEP these instructions.
3. HEED all warnings.
4. FOLLOW all instructions.
5. DO NOT use this apparatus near water.
6. CLEAN ONLY with dry cloth.
7. DO NOT block any ventilation openings. Allow sufficient distances for adequate ventilation and install in accordance with the manufacturer's instructions.
8. DO NOT install near any heat sources such as open flames, radiators, heat registers, stoves, or other apparatus (including amplifiers) that produce heat. Do not place any open flame sources on the product.
9. DO NOT defeat the safety purpose of the polarized or grounding type plug. A polarized plug has two blades with one wider than the other. A grounding type plug has two blades and a third grounding prong. The wider blade or the third prong are provided for your safety. If the provided plug does not fit into your outlet, consult an electrician for replacement of the obsolete outlet.
10. PROTECT the power cord from being walked on or pinched, particularly at plugs, convenience receptacles, and the point where they exit from the apparatus.
11. ONLY USE attachments/accessories specified by the manufacturer.
12. USE only with a cart, stand, tripod, bracket, or table specified by the manufacturer, or sold with the apparatus. When a cart is used, use caution when moving the cart/apparatus combination to avoid injury from tip-over.
13. UNPLUG this apparatus during lightning storms or when unused for long periods of time.



14. REFER all servicing to qualified service personnel. Servicing is required when the apparatus has been damaged in any way, such as power supply cord or plug is damaged, liquid has been spilled or objects have fallen into the apparatus, the apparatus has been exposed to rain or moisture, does not operate normally, or has been dropped.
15. DO NOT expose the apparatus to dripping and splashing. DO NOT put objects filled with liquids, such as vases, on the apparatus.
16. The MAINS plug or an appliance coupler shall remain readily operable.
17. The airborne noise of the Apparatus does not exceed 70dB (A).
18. Apparatus with CLASS I construction shall be connected to a MAINS socket outlet with a protective earthing connection.
19. To reduce the risk of fire or electric shock, do not expose this apparatus to rain or moisture.
20. Do not attempt to modify this product. Doing so could result in personal injury and/or product failure.
21. Operate this product within its specified operating temperature range.



This symbol indicates that dangerous voltage constituting a risk of electric shock is present within this unit.



This symbol indicates that there are important operating and maintenance instructions in the literature accompanying this unit.

WARNING: This product contains a chemical known to the State of California to cause cancer and birth defects or other reproductive harm.

INSTRUCCIONES IMPORTANTES DE SEGURIDAD

1. LEA estas instrucciones.
2. CONSERVE estas instrucciones.
3. PRESTE ATENCION a todas las advertencias.
4. SIGA todas las instrucciones.
5. NO utilice este aparato cerca del agua.
6. LIMPIE ÚNICAMENTE con un trapo seco.
7. NO obstruya ninguna de las aberturas de ventilación. Deje espacio suficiente para proporcionar ventilación adecuada e instale los equipos según las instrucciones del fabricante.
8. NO instale el aparato cerca de fuentes de calor tales como llamas descubiertas, radiadores, registros de calefacción, estufas u otros aparatos (incluyendo amplificadores) que produzcan calor. No coloque artículos con llamas descubiertas en el producto.
9. NO anule la función de seguridad del enchufe polarizado o con clavija de puesta a tierra. Un enchufe polarizado tiene dos patas, una más ancha que la otra. Un enchufe con puesta a tierra tiene dos patas y una tercera clavija con puesta a tierra. La pata más ancha o la tercera clavija se proporciona para su seguridad. Si el tomacorriente no es del tipo apropiado para el enchufe, consulte a un electricista para que sustituya el tomacorriente de estilo anticuado.
10. PROTEJA el cable eléctrico para evitar que personas lo pisen o estrujen, particularmente en sus enchufes, en los tomacorrientes y en el punto en el cual sale del aparato.
11. UTILICE únicamente los accesorios especificados por el fabricante.
12. UTILICE únicamente con un carro, pedestal, trípode, escuadra o mesa del tipo especificado por el fabricante o vendido con el aparato. Si se usa un carro, el mismo debe moverse con sumo cuidado para evitar que se vuelque con el aparato.



13. DESENCHUFE el aparato durante las tormentas eléctricas, o si no va a ser utilizado por un lapso prolongado.
14. TODA reparación debe ser llevada a cabo por técnicos calificados. El aparato requiere reparación si ha sufrido cualquier tipo de daño, incluyendo los daños al cordón o enchufe eléctrico, si se derrama líquido sobre el aparato o si caen objetos en su interior, si ha sido expuesto a la lluvia o la humedad, si no funciona de modo normal, o si se ha caído.
15. NO exponga este aparato a chorros o salpicaduras de líquidos. NO coloque objetos llenos con líquido, tales como floreros, sobre el aparato.
16. El enchufe de alimentación o un acoplador para otros aparatos deberá permanecer en buenas condiciones de funcionamiento.
17. El nivel de ruido transmitido por el aire del aparato no excede de 70 dB(A).
18. Los aparatos de fabricación CLASE I deberán conectarse a un tomacorriente de ALIMENTACION con clavija de puesta a tierra protectora.
19. Para reducir el riesgo de causar un incendio o sacudidas eléctricas, no exponga este aparato a la lluvia ni a humedad.
20. No intente modificar este producto. Hacerlo podría causar lesiones personales y/o la falla del producto.
21. Utilice este producto únicamente dentro de la gama de temperaturas de funcionamiento especificadas.



Este símbolo indica que la unidad contiene niveles de voltaje peligrosos que representan un riesgo de choques eléctricos.



Este símbolo indica que la literatura que acompaña a esta unidad contiene instrucciones importantes de funcionamiento y mantenimiento.

ISTRUZIONI IMPORTANTI PER LA SICUREZZA

1. LEGGETE queste istruzioni.
2. CONSERVATELE.
3. OSSERVATE tutte le avvertenze.
4. SEGUITE tutte le istruzioni.
5. NON usate questo apparecchio vicino all'acqua.
6. PULITE l'apparecchio SOLO con un panno asciutto.
7. NON ostruite alcuna apertura per l'aria di raffreddamento. Consentite distanze sufficienti per un'adeguata ventilazione e installate l'apparecchio seguendo le istruzioni del costruttore.
8. NON installate l'apparecchio accanto a fonti di calore, quali fiamme libere, radiatori, aperture per l'efflusso di aria calda, forni o altri apparecchi (amplificatori inclusi) che generano calore. Non esponete il prodotto a fonti di calore non controllate.
9. NON modificate la spina polarizzata o con spinotto di protezione per non alterarne la funzione di sicurezza. Una spina polarizzata è dotata di due lame, una più ampia dell'altra. Una spina con spinotto è dotata di due lame e di un terzo polo di messa a terra. La lama più ampia ed il terzo polo hanno lo scopo di tutelare la vostra incolumità. Se la spina in dotazione non si adatta alla presa di corrente, rivolgetevi ad un elettricista per far eseguire le modifiche necessarie.
10. EVITATE di calpestare il cavo di alimentazione o di comprimerlo, specie in corrispondenza di spine, prese di corrente e punto di uscita dall'apparecchio.
11. USATE ESCLUSIVAMENTE i dispositivi di collegamento e gli accessori specificati dal costruttore.
12. USATE l'apparecchio solo con carrelli, sostegni, treppiedi, staffe o tavoli specificati dal produttore o venduti unitamente all'apparecchio stesso. Se usate un carrello, fate attenzione quando lo spostate con l'apparecchio collocato su di esso, per evitare infortuni causati da un eventuale ribaltamento del carrello stesso.



13. Durante i temporali o in caso di inutilizzo prolungato dell'apparecchio, SCOLLEGATELO dalla presa di corrente.
14. Per qualsiasi intervento, RIVOLGETEVI a personale di assistenza qualificato. È necessario intervenire sull'apparecchio ogniqualvolta è stato danneggiato, in qualsiasi modo; ad esempio la spina o il cavo di alimentazione sono danneggiati, si è versato liquido sull'apparecchio o sono caduti oggetti su di esso, l'apparecchio è stato esposto alla pioggia o all'umidità, non funziona normalmente o è caduto.
15. NON esponete l'apparecchio a sgocciolamenti o spruzzi. NON appoggiate sull'apparecchio oggetti pieni di liquidi, ad esempio vasi da fiori.
16. La spina ELETTRICA o l'accoppiatore per elettrodomestici deve restare prontamente utilizzabile.
17. Il rumore aereo dell'apparecchio non supera i 70 dB (A).
18. L'apparecchio appartenente alla CLASSE I deve essere collegato ad una presa elettrica dotata di messa a terra di protezione.
19. Per ridurre il rischio di incendio o folgorazione, non esponete questo apparecchio alla pioggia o all'umidità.
20. Non tentate di modificare il prodotto. Tale operazione può causare infortuni e/o il guasto del prodotto stesso.
21. Utilizzate questo prodotto entro la gamma di temperatura operativa specificata.



Questo simbolo indica la presenza di alta tensione all'interno dell'apparecchio, che comporta il rischio di folgorazione.



Questo simbolo indica la presenza di istruzioni importanti per l'uso e la manutenzione nella documentazione in dotazione all'apparecchio.

ВАЖНЫЕ ИНСТРУКЦИИ ПО ТЕХНИКЕ БЕЗОПАСНОСТИ

1. ПРОЧИТАЙТЕ эти инструкции.
2. СОХРАНИТЕ эти инструкции.
3. ОБРАЩАЙТЕ ВНИМАНИЕ на все предупреждения.
4. СЛЕДУЙТЕ всем инструкциям.
5. НЕ пользуйтесь этим прибором вблизи воды.
6. ЧИСТИТЕ ТОЛЬКО сухой тканью.
7. НЕ закрывайте никакие вентиляционные отверстия. Оставляйте расстояния, нужные для достаточной вентиляции, и выполняйте установку в соответствии с инструкциями изготовителя.
8. НЕ устанавливайте вблизи каких бы то ни было источников тепла — открытого пламени, радиаторов, обогревателей, печей или других приборов (включая усилители), выделяющих тепло. Не помещайте на изделие источники открытого пламени.
9. НЕ пренебрегайте защитными свойствами поляризованной или заземляющей вилки. Поляризованная вилка имеет два ножевых контакта, из которых один шире другого. Заземляющая вилка имеет два ножевых контакта и третий, заземляющий, штырь. Более широкий контакт или третий штырь предусматриваются для безопасности. Если вилка прибора не подходит к вашей розетке, обратитесь к электрику для замены розетки устаревшей конструкции.
10. ЗАЩИТИТЕ силовой шнур, чтобы на него не наступали и чтобы он не был пережат, особенно в местах подсоединения к вилкам, розеткам и в месте выхода из прибора.
11. ИСПОЛЬЗУЙТЕ ТОЛЬКО те принадлежности и приспособления, которые предусмотрены изготовителем.
12. ИСПОЛЬЗУЙТЕ только с тележкой, стендом, штативом, кронштейном или столом, которые предусмотрены изготовителем или наглухо прикреплены к прибору. При использовании тележки будьте осторожны, когда передвигаете тележку вместе с прибором — переворачивание может привести к травме.



13. ОТСОЕДИНЯЙТЕ прибор ОТ СЕТИ во время грозы или если он не используется длительное время.
14. ПОРУЧИТЕ все обслуживание квалифицированному техническому персоналу. Обслуживание требуется при каком-либо повреждении прибора, например, при повреждении шнура питания или вилки, если на прибор была пролита жидкость или на него упал какой-либо предмет, если прибор подвергся воздействию дождя или сырости, не функционирует нормально или если он падал.
15. НЕ допускайте попадания на прибор капель или брызг. НЕ ставьте на прибор сосуды с жидкостью, например, вазы.
16. Вилка электропитания или штепсель прибора должны быть легко доступны.
17. Уровень воздушного шума этого аппарата не превышает 70 дБ (А).
18. Аппараты конструкции КЛАССА I необходимо подсоединять к СЕТЕВОЙ розетке с защитным соединением для заземления.
19. Чтобы уменьшить риск возгорания или поражения электрическим током, не допускайте попадания на этот аппарат дождя или влаги.
20. Не пытайтесь вносить изменения в это изделие. Это может привести к травме и (или) выходу изделия из строя.
21. Эксплуатируйте это изделие в указанном диапазоне рабочих температур.



Этот знак показывает, что внутри прибора имеется опасное напряжение, создающее риск электрического удара.



Этот знак показывает, что в сопроводительной документации к прибору есть важные указания по его эксплуатации и обслуживанию.

IMPORTANTES INSTRUÇÕES DE SEGURANÇA

1. LEIA estas instruções.
2. GUARDE estas instruções.
3. PRESTE ATENÇÃO a todas as instruções.
4. SIGA todas as instruções.
5. NÃO use este aparelho perto de água.
6. LIMPE SOMENTE com um pano seco.
7. NÃO bloqueie nenhuma das aberturas de ventilação. Deixe distâncias suficientes para ventilação adequada e instale de acordo com as instruções do fabricante.
8. NÃO instale próximo de nenhuma fonte de calor, tais como fogo aceso, radiadores, bocais de aquecimento, fornos ou outros aparelhos que produzam calor (inclusive amplificadores). Não coloque fontes de chamas sobre o produto.
9. NÃO inutilize as características de segurança do conector polarizado ou com pino de aterramento. Um conector polarizado possui duas lâminas com uma mais larga do que a outra. Um conector com pino de aterramento possui duas lâminas e um terceiro pino de aterramento. É fornecida uma lâmina mais larga ou o terceiro pino para a sua segurança. Se por acaso o conector não se encaixar na tomada, chame um electricista para substituir a tomada obsoleta.
10. PROTEJA o cabo de alimentação, evitando que seja pisado ou que enrosque, especialmente nos conectores, nas tomadas elétricas de emprego geral e no ponto onde elas saem do aparelho.
11. USE SOMENTE acessórios/apetrechos especificados pelo fabricante.
12. USE somente com um carrinho, pedestal, tripé, suporte ou mesa especificados pelo fabricante ou vendidos com o aparelho. Quando utilizar um carrinho, tenha cuidado ao movimentar o conjunto aparelho/carrinho para evitar danos com a queda do mesmo.



13. DESLIGUE este aparelho da tomada elétrica durante tempestades com relâmpagos ou quando não seja utilizado por longo período.
14. DEIXE toda a manutenção sob a responsabilidade de uma equipe de manutenção qualificada. É necessário realizar a manutenção quando por algum motivo o aparelho tiver sido danificado de alguma forma, como por exemplo por dano do cabo de alimentação elétrica ou do seu conector, por derramamento de líquido ou queda de objetos no aparelho, se o aparelho tiver sido exposto à chuva ou à umidade, não esteja operando normalmente ou tenha sofrido queda.
15. NÃO exponha o aparelho a respingos ou goteiras. NÃO coloque objetos cheios de líquidos, tais como vasos, sobre o aparelho.
16. O plugue MAINS (rede elétrica) ou um acoplador de aparelho deve estar sempre pronto para operação.
17. O ruído aéreo do Aparelho não ultrapassa 70 dB (A).
18. O aparelho com construção CLASSE I deve estar conectado à tomada da rede elétrica com ligação à terra.
19. Para reduzir o risco de incêndio ou choque elétrico, não exponha este aparelho à chuva ou umidade.
20. Não tente alterar este produto. Isso poderá resultar em lesão pessoal e/ou falha do produto.
21. Opere este produto dentro da faixa de temperatura de operação especificada.



Este símbolo indica que existe nesta unidade tensão perigosa que apresenta risco de choque elétrico.



Este símbolo indica que existem instruções de operação e manutenção importantes na literatura que acompanha esta unidade.

CONSIGNES DE SÉCURITÉ IMPORTANTES

1. LIRE ces consignes.
2. CONSERVER ces consignes.
3. OBSERVER tous les avertissements.
4. SUIVRE toutes les consignes.
5. NE PAS utiliser cet appareil à proximité de l'eau.
6. NETTOYER UNIQUEMENT avec un chiffon sec.
7. NE PAS obstruer les ouvertures de ventilation. Laisser des distances suffisantes pour permettre une ventilation adéquate et effectuer l'installation en respectant les instructions du fabricant.
8. NE PAS installer à proximité d'une source de chaleur telle qu'une flamme nue, un radiateur, une bouche de chaleur, un poêle ou d'autres appareils (dont les amplificateurs) produisant de la chaleur. Ne placer aucune source à flamme nue sur le produit.
9. NE PAS détériorer la sécurité de la fiche polarisée ou de la fiche de terre. Une fiche polarisée comporte deux lames dont l'une est plus large que l'autre. Une fiche de terre comporte deux lames et une troisième broche de mise à la terre. La lame la plus large ou la troisième broche assure la sécurité de l'utilisateur. Si la fiche fournie ne s'adapte pas à la prise électrique, demander à un électricien de remplacer la prise hors normes.
10. PROTÉGER le cordon d'alimentation afin que personne ne marche dessus et que rien ne le pince, en particulier au niveau des fiches, des prises de courant et du point de sortie de l'appareil.
11. UTILISER UNIQUEMENT les accessoires spécifiés par le fabricant.
12. UTILISER uniquement avec un chariot, un pied, un trépied, un support ou une table spécifié par le fabricant ou vendu avec l'appareil. Si un chariot est utilisé, déplacer l'ensemble chariot-appareil avec précaution afin de ne pas le renverser, ce qui pourrait entraîner des blessures.



13. DÉBRANCHER l'appareil pendant les orages ou quand il ne sera pas utilisé pendant longtemps.
14. CONFIER toute réparation à du personnel qualifié. Des réparations sont nécessaires si l'appareil est endommagé d'une façon quelconque, par exemple : cordon ou prise d'alimentation endommagé, liquide renversé ou objet tombé à l'intérieur de l'appareil, exposition de l'appareil à la pluie ou à l'humidité, appareil qui ne marche pas normalement ou que l'on a fait tomber.
15. NE PAS exposer cet appareil aux égouttements et aux éclaboussures. NE PAS poser des objets contenant de l'eau, comme des vases, sur l'appareil.
16. La prise SECTEUR ou un coupleur d'appareil électrique doit rester facilement utilisable.
17. Le bruit aérien de l'appareil ne dépasse pas 70 dB (A).
18. L'appareil de construction de CLASSE I doit être raccordé à une prise SECTEUR dotée d'une protection par mise à la terre.
19. Pour réduire les risques d'incendie ou de choc électrique, ne pas exposer cet appareil à la pluie ou à l'humidité.
20. Ne pas essayer de modifier ce produit. Cela risque de causer des blessures et/ou la défaillance du produit.
21. Utiliser ce produit dans sa plage de températures de fonctionnement spécifiée.



Ce symbole indique la présence d'une tension dangereuse dans l'appareil constituant un risque de choc électrique.



Ce symbole indique que la documentation fournie avec l'appareil contient des instructions d'utilisation et d'entretien importantes.

WICHTIGE SICHERHEITSHINWEISE

1. Diese Hinweise LESEN.
2. Diese Hinweise AUFBEWAHREN.
3. Alle Warnungen BEACHTEN.
4. Alle Hinweise BEFOLGEN.
5. Dieses Gerät NICHT in Wassernähe VERWENDEN.
6. NUR mit einem sauberen Tuch REINIGEN.
7. KEINE Lüftungsöffnungen verdecken. Hinreichende Abstände für ausreichende Belüftung vorsehen und gemäß den Anweisungen des Herstellers installieren.
8. NICHT in der Nähe von Wärmequellen wie zum Beispiel offenen Flammen, Heizkörpern, Wärmespeichern, Öfen oder anderen Hitze erzeugenden Geräten (einschließlich Verstärkern) installieren. Keine Quellen von offenen Flammen auf dem Produkt platzieren. Die Schutzfunktion des Schukosteckers NICHT umgehen. Ein Schukostecker verfügt über zwei Steckerzinken sowie Schutzleiter. Bei dieser Steckerausführung dienen die Schutzleiter Ihrer Sicherheit. Wenn der mitgelieferte Stecker nicht in die Steckdose passt, einen Elektriker mit dem Austauschen der veralteten Steckdose beauftragen.
10. VERHINDERN, dass das Netzkabel gequetscht oder darauf getreten wird, insbesondere im Bereich der Stecker, Netzsteckdosen und an der Austrittsstelle vom Gerät.
11. NUR das vom Hersteller angegebene Zubehör und entsprechende Zusatzgeräte verwenden.
12. NUR in Verbindung mit einem vom Hersteller angegebenen oder mit dem Gerät verkauften Transportwagen, Stand, Stativ, Träger oder Tisch verwenden. Wenn ein Transportwagen verwendet wird, beim Verschieben der Transportwagen/Geräte-Einheit vorsichtig vorgehen, um Verletzungen durch Umkippen zu verhüten.
13. Bei Gewitter oder wenn das Gerät lange Zeit nicht benutzt wird, das Netzkabel HERAUSZIEHEN.



14. ALLE Reparatur- und Wartungsarbeiten von qualifiziertem Kundendienstpersonal durchführen lassen. Kundendienst ist erforderlich, wenn das Gerät auf irgendwelche Weise beschädigt wurde, z. B. wenn das Netzkabel oder der Netzstecker beschädigt wurden, wenn Flüssigkeiten in das Gerät verschüttet wurden oder Fremdkörper hineinfließen, wenn das Gerät Regen oder Feuchtigkeit ausgesetzt war, nicht normal funktioniert oder fallen gelassen wurde.
15. Dieses Gerät vor Tropf- und Spritzwasser SCHÜTZEN. KEINE mit Wasser gefüllten Gegenstände wie zum Beispiel Vasen auf das Gerät STELLEN.
16. Der Netzstecker oder eine Gerätesteckerverbindung muss leicht zu betätigen sein.
17. Der Luftschall des Geräts überschreitet 70 dB (A) nicht.
18. Das Gerät mit Bauweise der KLASSE I muss mit einem Schukostecker mit Schutzleiter in eine Netzsteckdose mit Schutzleiter eingesteckt werden.
19. Dieses Gerät darf nicht Regen oder Feuchtigkeit ausgesetzt werden, um das Risiko von Bränden oder Stromschlägen zu verringern.
20. Nicht versuchen, dieses Produkt zu modifizieren. Ansonsten könnte es zu Verletzungen und/oder zum Produktausfall kommen.
21. Dieses Produkt muss innerhalb des vorgeschriebenen Temperaturbereichs betrieben werden.



Dieses Symbol zeigt an, dass gefährliche Spannungswerte, die ein Stromschlagrisiko darstellen, innerhalb dieses Geräts auftreten.



Dieses Symbol zeigt an, dass das diesem Gerät beiliegende Handbuch wichtige Betriebs- und Wartungsanweisungen enthält.

Table of Contents

User Manual	3	Networking	24
IMPORTANT SAFETY INSTRUCTIONS	3	Networking Best Practices	25
SAFETY PRECAUTIONS	3	Network Topologies	25
CAUTION	3	Multiple Ethernet Switch Setup #1	25
WARNING	3	Multiple Ethernet Switch Setup #2	26
WARNING	3	Multiple Ethernet Switch (Wi-Fi) Setup #3	26
WARNING	3	Configuring Firewalls for Mac or Windows Operating Systems	27
		Mac OS Native Firewall	27
		Windows XP or Vista Firewall	27
		Windows 7 Firewall	27
System Overview	4	Configuring Wi-Fi for Wireless Networking	27
General Description and Features	5	Troubleshooting	28
Theory of Operation	6	Factory Reset	28
Groups and Audio Channels	6	Set Appropriate Latency Settings	28
Network	6	Dedicate a Device for Master Clock	28
Wireless Audio	6		
		Software Introduction	29
System Setup	8	Shure Device Discovery Application	30
Install and Power the Hardware	9	Opening the MXW GUI	30
Additional Equipment Requirements	9	MXW System Graphical User Interface (GUI)	31
Rackmount the ANI	9	GUI Description	31
Mount the APT	9	Control Bar	33
Power the Hardware	9	Inputs/Outputs Tab	33
Connect the Components to Form a Network	10	Preferences Tab	33
Single Group System (Automatic Configuration)	10	Dante Software by Audinate	34
Multiple Group System	10	Dante Controller	34
Access the MXW System Interface	11	Dante Virtual Soundcard	34
Assign Components to a Group	12		
Set Up Microphones	13	Optimizing the System	35
Microphone Placement	15	Site Survey: RF Spectrum Scan	36
		Performing a Scan	36
		Setting RF Gain for Installation	37
		Dynamic RF Power Control	37
		Manually Setting RF Power	37
		Adjacent Room Freq. Coordination	37
		Average Battery Runtime per Power Level	37
		Removing/Exchanging a Component from the Group	38
Hardware Interface Description	16		
Access Point Transceiver (APT)	17	Firmware Updates	39
Audio Network Interface (ANI)	18	Troubleshooting	40
Front Panel	18	Audio	40
Back Panel	19	Networking	40
4-Port Network Interface	19	Control Software	40
Networked Charger (NCS)	20	Control Command Strings	40
Microphones	21	Safety Information	41
Description	21	Certifications	41
Microphone Types and Applications	22	Specifications	42
Microphone States	22		
Rechargeable Microphone Batteries	23		
Recharging the Battery	23		
Monitoring the Battery Information	23		
Replacing the Battery	23		



10/02/12

IMPORTANT SAFETY INSTRUCTIONS

1. READ these instructions.
2. KEEP these instructions.
3. HEED all warnings.
4. FOLLOW all instructions.
5. DO NOT use this apparatus near water.
6. CLEAN ONLY with dry cloth.
7. DO NOT block any ventilation openings. Allow sufficient distances for adequate ventilation and install in accordance with the manufacturer's instructions.
8. DO NOT install near any heat sources such as open flames, radiators, heat registers, stoves, or other apparatus (including amplifiers) that produce heat. Do not place any open flame sources on the product.
9. DO NOT defeat the safety purpose of the polarized or groundingtype plug. A polarized plug has two blades with one wider than the other. A grounding type plug has two blades and a third grounding prong. The wider blade or the third prong are provided for your safety. If the provided plug does not fit into your outlet, consult an electrician for replacement of the obsolete outlet.
10. PROTECT the power cord from being walked on or pinched, particularly at plugs, convenience receptacles, and the point where they exit from the apparatus.
11. ONLY USE attachments/accessories specified by the manufacturer.
12. USE only with a cart, stand, tripod, bracket, or table specified by the manufacturer, or sold with the apparatus. When a cart is used, use caution when moving the cart/apparatus combination to avoid injury from tip-over.
13. UNPLUG this apparatus during lightning storms or when unused for long periods of time.
14. REFER all servicing to qualified service personnel. Servicing is required when the apparatus has been damaged in any way, such as power supply cord or plug is damaged, liquid has been spilled or objects have fallen into the apparatus, the apparatus has been exposed to rain or moisture, does not operate normally, or has been dropped.
15. DO NOT expose the apparatus to dripping and splashing. DO NOT put objects filled with liquids, such as vases, on the apparatus.
16. The MAINS plug or an appliance coupler shall remain readily operable.
17. The airborne noise of the Apparatus does not exceed 70dB (A).
18. Apparatus with CLASS I construction shall be connected to a MAINS socket outlet with a protective earthing connection.
19. To reduce the risk of fire or electric shock, do not expose this apparatus to rain or moisture.
20. Do not attempt to modify this product. Doing so could result in personal injury and/or product failure.
21. Operate this product within its specified operating temperature range.

SAFETY PRECAUTIONS

The possible results of incorrect use are marked by one of the two symbols—"WARNING" and "CAUTION"—depending on the imminence of the danger and the severity of the damage.

	WARNING: Ignoring these warnings may cause severe injury or death as a result of incorrect operation.
	CAUTION: Ignoring these cautions may cause moderate injury or property damage as a result of incorrect operation.

CAUTION

- Never disassemble or modify the device, as failures may result.
- Do not subject to extreme force and do not pull on the cable or failures may result.
- Keep the product dry and avoid exposure to extreme temperatures and humidity.

WARNING

- If water or other foreign objects enter the inside of the device, fire or electric shock may result.
- Do not attempt to modify this product. Doing so could result in personal injury and/or product failure.

This device is able to produce sound volume higher than 85 dB SPL. Please check your maximum allowed continuous noise exposure level based on your national employment protection requirements.

WARNING

LISTENING TO AUDIO AT EXCESSIVE VOLUMES CAN CAUSE PERMANENT HEARING DAMAGE. USE AS LOW A VOLUME AS POSSIBLE. Over exposure to excessive sound levels can damage your ears resulting in permanent noise-induced hearing loss (NIHL). Please use the following guidelines established by the Occupational Safety Health Administration (OSHA) on maximum time exposure to sound pressure levels before hearing damage occurs.

90 dB SPL at 8 hours	95 dB SPL at 4 hours	100 dB SPL at 2 hours	105 dB SPL at 1 hour
110 dB SPL at ½ hour	115 dB SPL at 15 minutes	120 dB SPL Avoid or damage may occur	

WARNING

- Battery packs may explode or release toxic materials. Risk of fire or burns. Do not open, crush, modify, disassemble, heat above 140°F (60°C), or incinerate
- Follow instructions from manufacturer
- Never put batteries in mouth. If swallowed, contact your physician or local poison control center
- Do not short circuit; may cause burns or catch fire
- Do not charge or use battery packs with other than specified Shure products
- Dispose of battery packs properly. Check with local vendor for proper disposal of used battery packs
- Batteries (battery pack or batteries installed) shall not be exposed to excessive heat such as sunshine, fire or the like

WARNING: Danger of explosion if battery incorrectly replaced. Operate only with Shure compatible batteries.

Note: Use only with the included power supply or a Shure-approved equivalent.

System Overview

10/02/12

General Description and Features

The Microflex Wireless Series (MXW) is a complete solution for meeting room and presentation applications. Developed with Audinate's Dante technology, the system routes digital audio over standard IP equipment across a network of access points, digital-to-analog converters and computers. Access points mount to a ceiling or wall to communicate wirelessly with the microphones, distributing audio to the Dante network. RF coordination is automatic and continuous, offering worry-free wireless audio transmission for up to 32 channels.

Dante Digital Audio Networking

Digital audio is carried over standard Ethernet using shielded Cat5e (or higher) cables. Dante provides low latency, tight clock synchronization, and high Quality-of-Service (QoS) to provide reliable audio transport to a variety of Dante devices. Dante audio can coexist safely on the same network as IT and control data, or can be configured to use a dedicated network.

Encryption

The MXW transmits secure, encrypted audio using Advanced Encryption Standard (AES-256), which conforms to the US Government National Institute of Standards and Technology (NIST) publication FIPS-197.

Automatic Frequency Coordination

The MXW Series uses automatic frequency coordination to achieve worry-free, solid wireless communication. Frequencies are shared and time-divided between multiple transmitters. A highly accurate time-sync allows multiple APTs to work together for up to 32 channels of wireless transmitters.

Microphones are assigned to channels by arranging them in the charger and pressing the link button. The APT assigns the microphones to a channel according to the charger slot number.

Remote Control and Monitoring

The system can connect to a computer or 3rd party control system (AMX, Crestron, Extron, etc) for remote control and monitoring. The web browser-based graphical user interface (GUI) enables RF spectrum management, audio routing, and microphone behavior.

Rechargeable Microphones

The MXW series microphones feature an internal rechargeable battery. Microphones charge directly in the charger without the battery removal. During a charging cycle, the GUI displays battery information (battery runtime, charge cycle count and battery capacity). Up to xx hours of continuous use.

Built-In RF Spectrum Scanner

The MXW APT has the ability to scan the entire RF spectrum for a duration of time. The scan provides an accurate xx insight xx to a location's spectrum availability during typical event hours.

Shure Legendary Audio Quality

Groups and Audio Channels

The MXW system uses Groups to organize the audio and control data transport between components. Each Group is comprised of a single access point, charger(s) and audio output device(s). Groups have four or eight channels, depending on the access point model.

Once the group is formed, microphones can be linked to the channels from the charging station. Each slot on the charging station corresponds to channels in the group.

Automatic Group

Dante's self-discovery feature enables a Group to automatically form when the network is comprised of a single APT, ANI and charger. These components must be the same channel count for the automatic association to occur (forming a group of 4 or 8 channels). Setup through the GUI is not necessary for this configuration

Network

The network is core communication pathway of the MXW system. It transports Dante digital audio with Shure control data over standard IP/Ethernet equipment. When an MXW device joins the network, it automatically configures to compatible IP settings.

Gigabit Switch with DHCP

For systems with more than eight channels, a gigabit switch is required to create a network of additional access points, chargers and audio output devices. Connecting all components on the same network will ensure the most reliable RF management and digital clock synchronization.

In some cases, computer settings or programs may interfere with the network. The majority of these connection issues can be solved by using a DHCP-enabled router. Most routers include a DHCP server, while switches do not.

Wireless Audio

MXW microphones transmit digital audio in the DECT

In the US, wireless audio transmits in the unlicensed 1920-1930 MHz frequency band

The following is an overview of each component and its function in the MXW system:

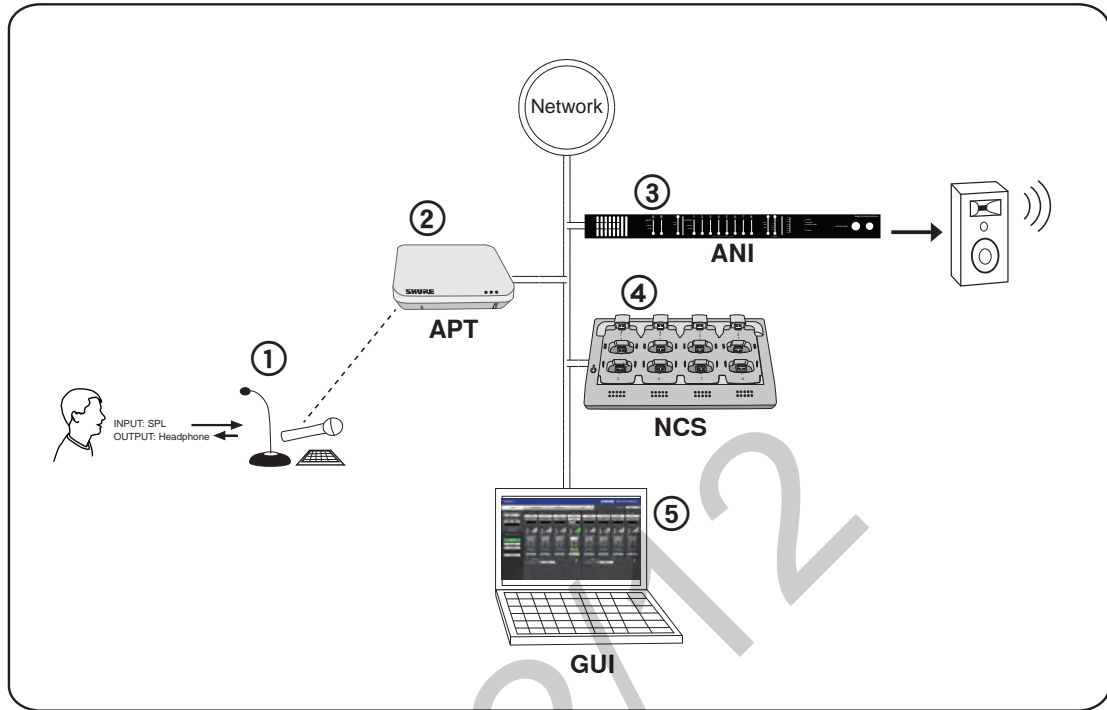

① MXW Microphones

- Convert audio into a digital RF signal that transmits wirelessly to the APT.
- Available in a variety of form factors to accommodate any event.
- Boundary and gooseneck models feature a headphone jack for monitoring audio from the network.

② Access Point Transceiver (APT)

- Transports encrypted, wireless audio between the microphones and the Dante network.
- Maintains stable audio transmission through advanced interference detection and automatic frequency coordination.
- Requires only a single Cat5e cable for power (via PoE), system time-sync management, and the communication of networked audio and control data.
- Hosts the web browser-based GUI for remote system management.

③ Audio Network Interface (ANI)

- Converts 24-bit/48k digital audio from the network into analog direct outputs.
- Four-port gigabit switch enables the ANI to be

the networking hub of an eight-channel MXW system.

- Network Port 4 (Uplink) can be configured to restrict audio and provide protected data uplink to a corporate network.
- Input channels add audio to the network for monitoring at the microphone headphone output.

Note: The ANI can be substituted with the Shure SCM820 Digital IntelliMix Mixer.

④ Networked Charging Station (NCS)

- Recharges microphone batteries by connecting to the USB port of the microphone.
- Links up to eight microphones at a time to channels in a group.
- Transmits detailed battery information to the network.
- LEDs display microphone battery charge status.

⑤ Graphical User Interface (GUI)

The MXW System is managed from the graphical user interface (GUI). The computer must be networked to the APT to access the GUI from a web browser. Use the software interface for the following system functions:

- Assign components to groups to determine the routing of digital audio and control data.
- Perform an RF spectrum scan to accurately survey a site's spectrum activity over a duration of time.
- Monitor microphone battery statistics during the charge.
- Control microphone activity state, gain setting and EQ filters.
- Customize the function of LED and mute/active button of the microphone.
- Configure IP settings.

System Setup

10/02/12

Install and Power the Hardware

Additional Equipment Requirements

- ① **Network Cables**
Ensure all network cables are shielded Cat5e or higher and do not exceed 100 m between network devices.
- ② **Audio Cables**
Reference the guide supplied with the MXWANI Hardware Kit to assemble the output cables to the connectors and strain relief tabs.
- ③ **Gigabit DHCP Router**
DHCP routers provide the most reliable networking hub for the system.

Rackmount the ANI

Use the screws and washers supplied in the Hardware Kit to mount the ANI.

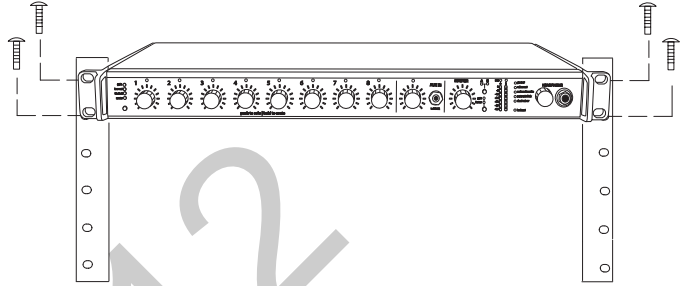

Mount the APT

① Position the Access Point

The access point contains multiple directional antennas to provide steady, reliable wireless communication. The cardioid radiation pattern is strongest from the top of the face plate.

Use the following guidelines when mounting the access point:

- Direct the antenna toward the intended coverage area.
- Position access point so there is nothing obstructing a line of sight to the microphones.
- Keep antennas away from large metal objects.
- Mount access points at least four feet apart.

Important: Always perform a "walk around" test to verify coverage before using a wireless system during a speech or performance. Experiment with antenna placement to find the optimum location. If necessary, mark "trouble spots" and ask presenters or performers to avoid those areas.

② Mount the Unit

Secure the unit to a ceiling or wall using the supplied mounting screws.

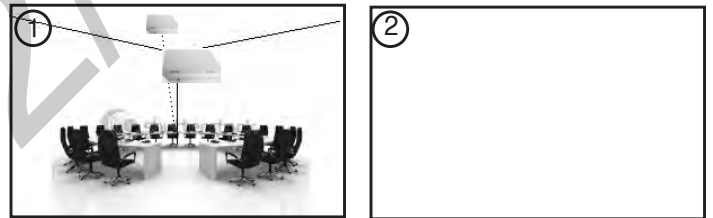

Power the Hardware

① ANI

Connect the IEC power cable from the back panel to an AC power source. Turn on the power switch.

② APT

The APT requires PoE to operate. Use a Cat5e cable to connect the APT to the ANI port 1 or to a gigabit switch with PoE. There is no power switch.

③ Charger

Connect the PS45 external power supply from the charger to an AC power source. Turn on the power switch.

④ Gigabit Ethernet Router or Switch

Connect the router or switch to an AC power source. Turn on the power switch.

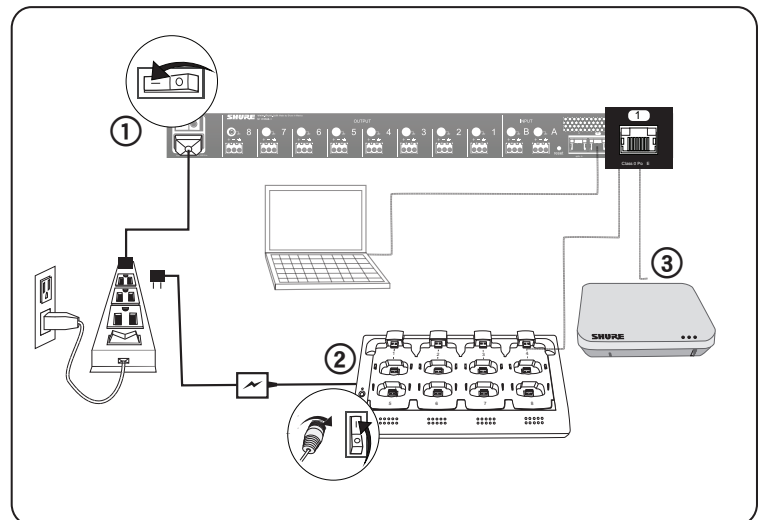

Connect the Components to Form a Network

The following are two setup examples for the MXW system. See Networking section for more details on Dante digital audio and networking best practices.

Single Group System (Automatic Configuration)

Use a Cat5e cable to connect the charger and APT to one of four ports of the ANI network interface. Reference the table for connecting to the ports:

Port	To Component
① Port 1 (PoE)	APT
② Port 2	Charger
④ Port 4 (Uplink)	Computer (optional)

Requirements:

- Cat 5e (or higher) Shielded Ethernet Cables (≤ 100 m)

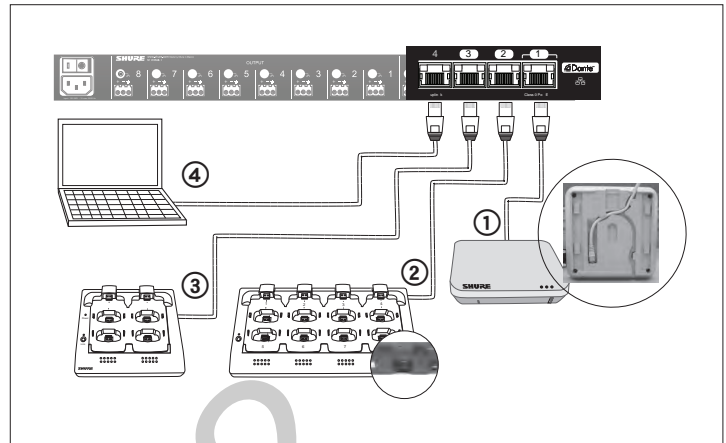

Single-Group System

Multiple Group System

Follow these steps for connecting a multiple-group system:

1. Connect a DHCP enabled router to a computer.
2. Connect each charger and audio output device to the router with network cables
3. Connect each access point to the network via a PoE source.

Requirements:

- Cat 5e (or higher) Shielded Ethernet Cables (≤ 100 m)
- Gigabit Ethernet switch (DHCP-enabled router recommended)
- Computer

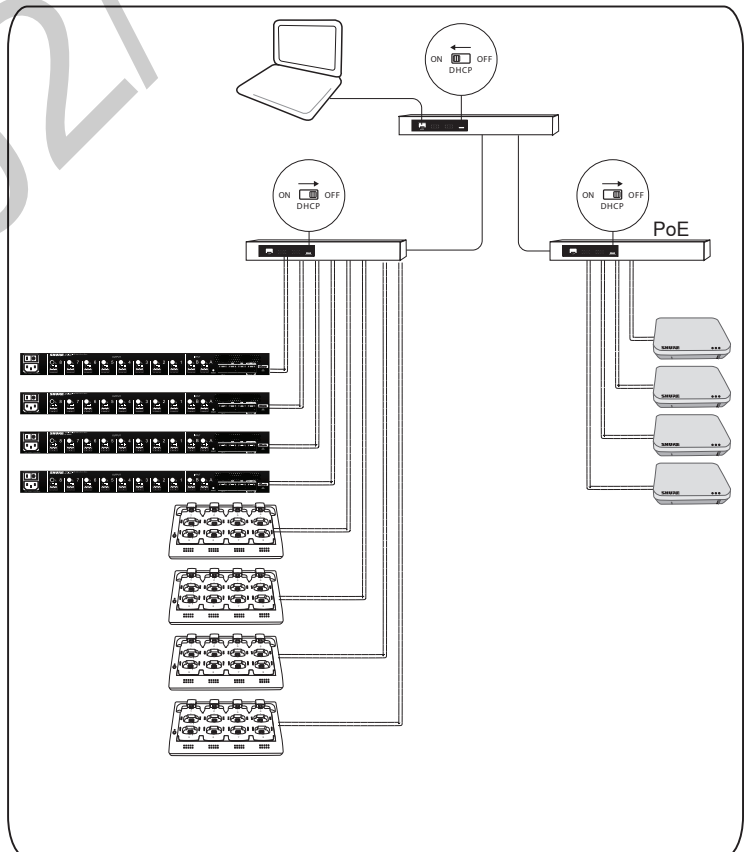

Four-Group System

Access the MXW System Interface

The MXW System is controlled and monitored on a graphical user interface (GUI) that opens in a web browser. The computer must be networked to the APT to access the GUI.

1. Load and install the Discovery Application.

This automatically installs the required Bonjour device discovery tool to the computer.

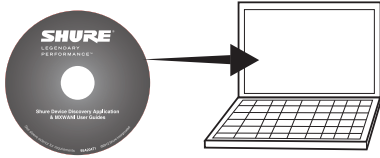

2. Launch the application.

The app displays all Shure devices on the network.

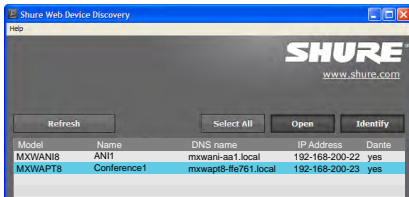

3. Select and open the APT.

The MXW System Interface opens in a web browser.



4. Bookmark the device's DNS name.

The DNS name is used to access the interface without the Discovery App.

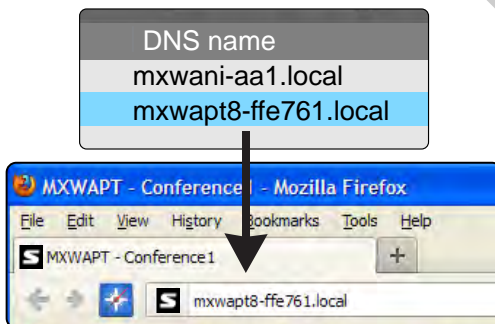

Assign Components to a Group

Components must be assigned to a group to form the communication link of audio and control data. On the Configuration tab, select the following components to form a group of up to 8 channels:

1. Select an APT for Group 1

The pop-up menu will display all APTs on the network. This determines if the group has four or eight channels (APT4 or APT8).

2. Select the charger(s).

When using gooseneck microphones, it is necessary to use two chargers for 8 microphones. (Gooseneck microphones take up front and back slots.)

3. Select the Audio Output Device(s).

This can be an ANI4, ANI8 or SCM820 IntelliMix® Mixer.

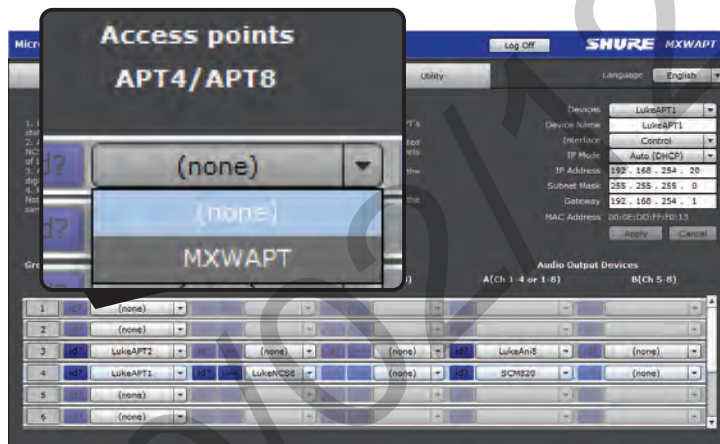

id? Button flashes the LEDs of the selected device for easy identification during setup.

Set Up Microphones

1. Arrange microphones in the charger.

Microphones are linked to channels according to the arrangement in the charger.

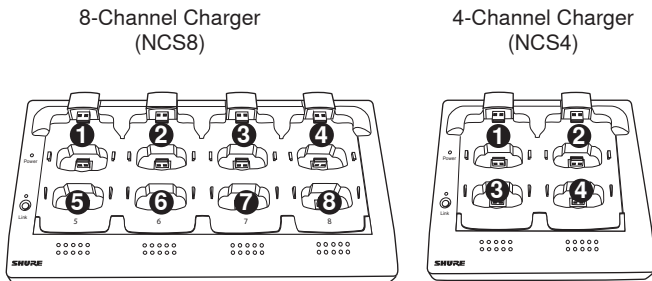

Charger Slots Correspond to Channels

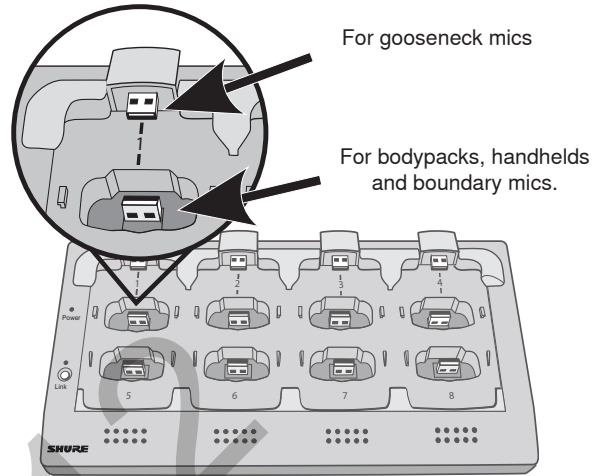

Connecting the Microphone to the Charger Slot

2. Link the microphones to channels.

The Link procedure can be done from two places:

- **Charger:** Press and hold the Link button for 6 seconds. The LEDs flash during the process and turn solid green once the link is successful.
- **GUI:** From the Configuration page, press the Link button in the group row.

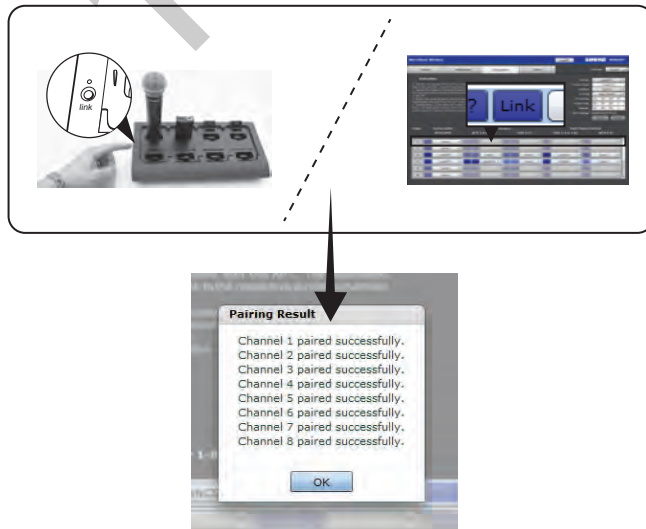

3. Remove mics from the charger.

The microphone status LEDs will flash, and will remain steady once the audio is ready.



4. Set mic gain

Mic gain is adjusted on the Monitor tab of the GUI.



Monitor Tab

Microphone Placement

For best low-frequency response and rejection of background noise, place the microphone on a large, flat surface, such as a floor, table, or lectern. To reduce reverberance, avoid reflective surfaces above or to the side of the microphone, such as beveled sides of pulpits or overhanging shelves.

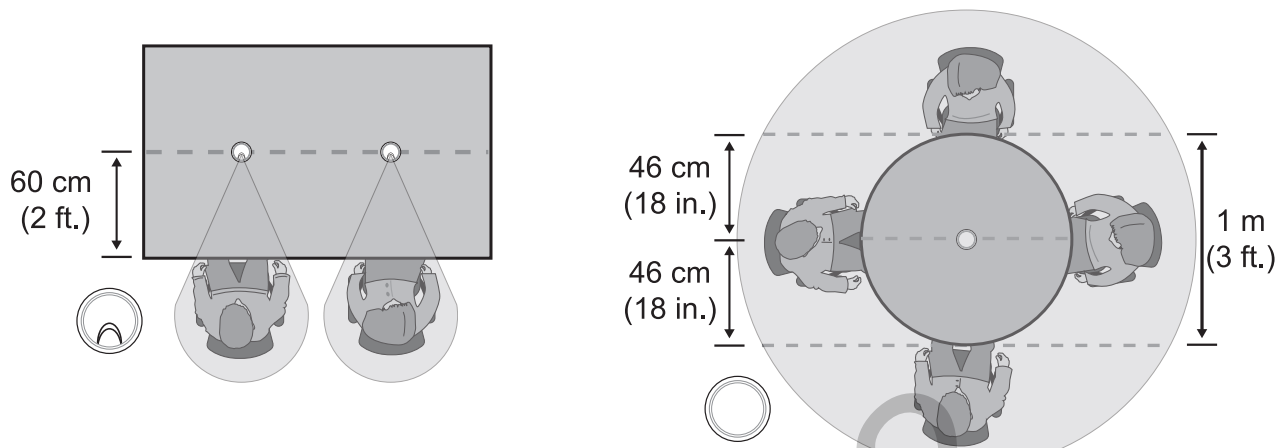

10102112

Hardware Interface Description

10102112

Access Point Transceiver (APT)

① **Power LED**

Illuminates green when Power over Ethernet (PoE) is provided.

② **Network Audio LED**

- **Solid Green:** Sending or receiving a digital audio signal.
- **Flashing Green:** Cannot establish a connection.

③ **RF Link LED**

Color	Status
Green	≥1 linked microphone is powered on in the Active or Mute state.
Solid Yellow	≥1 linked microphone is in the Standby or Off state.
Flashing Yellow	The ID button in the GUI has been pressed.
Solid Red	Problem with RF connection ???
Flashing Red	No microphones are linked to the unit.

④ **Reset Button**

Press and hold the reset button for 10 seconds to hard reset the MXW system to factory default settings.

Note: Performing a reset will delete system configurations made in the GUI, including device association and microphone link.

⑤ **Ethernet Jack**

Connects a Cat5e (or higher) cable to a PoE source and the network.

⑥ **Network Status LED (Green)**

Off = no network link
On = network link established
Flashing = network link active

⑦ **Network Speed LED (Amber)**

Off = 10/100 Mbps
On = 1 Gbps

⑧ **Cable Routing Path**

Routes the Ethernet cable to enable a flush-mount to the surface.

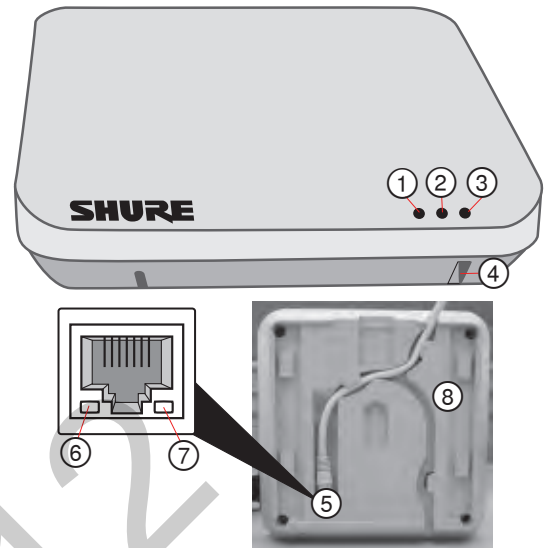

Audio Network Interface (ANI)

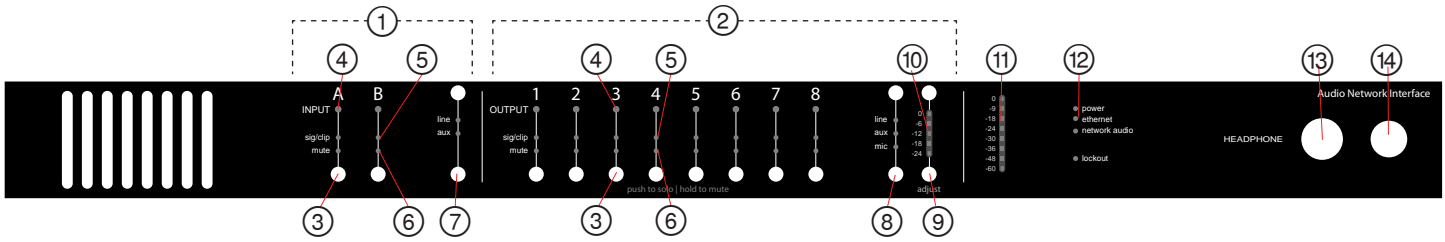

Front Panel

① Input Channels

Adds analog line- or aux-level signals to the digital network. When associated to the APT, inputs are automatically routed to linked microphone channels (Input A to channels 1-4; Input B to 5-8). Typical applications include sending translated audio or a mix for personal monitoring at the microphone headphone jack.

② Output Channels

Sends analog audio out from the digital audio network. When connected to the MXW system, the outputs are automatically routed from the associated MXWAPT.

③ Channel Select Button

Selects a channel and performs the following functions:

Action	Function
Single Press	<ul style="list-style-type: none"> Listen to the channel at the headphone jack Display and adjust channel gain Monitor output signal level on the ⑪ Level Meter
Press and Hold (3 seconds)	Mute/unmute a channel. Mute is indicated by the ⑥ Mute LED.

④ Selected Channel LED

Illuminates when a channel is selected.

⑤ Signal Strength LED (sig/clip)

Indicates audio signal strength for each channel:

Green = Normal

Amber = Strong

Red = Clipping (to eliminate clipping, attenuate the signal level at the audio source)

⑥ Mute LED

Illuminates red when the Channel Select button is held for 3 seconds, muting the channel. A muted channel is still routed to the **HEADPHONE** jack for monitoring or troubleshooting.

⑦ Input Level Select Buttons

Set the selected channel to line- or aux-level to match the input signal.

⑧ Output Level Select Buttons

Set the selected channel to an output level that matches the connecting device:

line: +4 dBu

aux: -10 dBV

mic: -30 dBV

⑨ Output Gain Control

Use the up/down buttons to adjust the channel gain attenuation from 0 dB (no attenuation) to -24 dB.

⑩ Output Gain Setting

Displays the attenuation made from the Output Gain Control.

⑪ Level Meter

Displays a selected channel's audio level in dBFS. It is good practice to use -18 dBFS on the output meter as an approximation of 0 VU on an analog meter.

⑫ Hardware Status LEDs

Illuminate to indicate the status of the hardware:

LED	Color	Status
power	Green	Unit is powered on.
Ethernet	Green	Connected to an Ethernet device.
network audio	Green	Sending or receiving a digital audio signal.
	Flashing Green	Cannot establish a connection.
lockout	Red	Front panel gain and mute controls are locked. The LED will blink when a button is pressed while the hardware is locked. A channel can still be selected for headphone monitoring.

⑬ Headphone Volume Knob

Adjusts the volume to the headphone output.

⑭ Headphone Output

1/4" (6.35 mm) output jack for monitoring a selected channel.

Back Panel

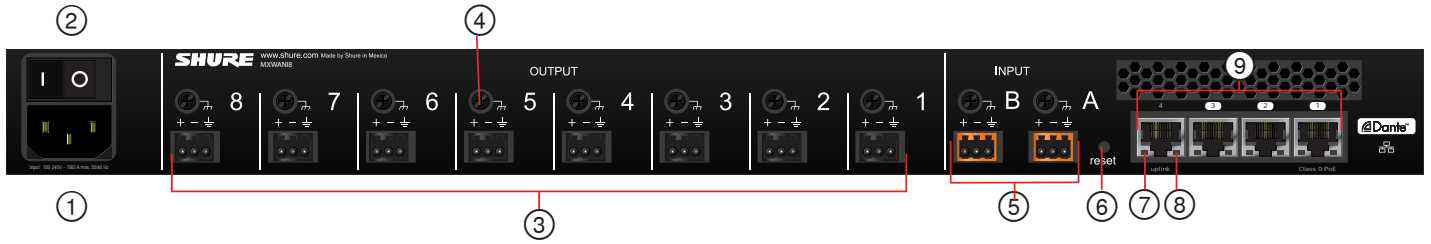

① AC Power

IEC connector 100 - 240 V AC.

② Power Switch

Powers the unit on or off.

③ Output Block Connectors (1-8)

Three-pin, low-voltage connector provides a direct output for each channel.

④ Chassis Ground

Use to directly ground the cable shield to the chassis.

⑤ Input Block Connectors (A,B)

Three-pin, low-voltage connector adds line- or aux-level analog signals to the digital network.

⑥ Reset Button

Press and hold the button for five seconds to reboot the device with factory default settings.

⑦ Network Status LED (Green)

Off = no network link
On = network link established
Flashing = network link active

⑧ Network Speed LED (Amber)

Off = 10/100 Mbps
On = 1 Gbps

⑨ Network Interface

Digital Audio connection and networking capabilities with shielded Cat-5e (or higher) cable.

4-Port Network Interface

Port	Description
Port 1 (PoE)	Provides Power over Ethernet (PoE) for the Shure MXWAPT Access Point.
Ports 2 and 3	Connects to an additional ANI for clock synchronization, to an MXW charger, or to a control system.
Port 4 (Uplink)	By default, this port functions the same as ports 2 and 3. However, it can be configured to provide password protected uplink to corporate LAN without network audio traffic. When Port 4 Uplink is enabled from the GUI, it only provides access to the GUI, blocking data to the Shure Discovery Application, Dante Controller and Dante Virtual Soundcard.

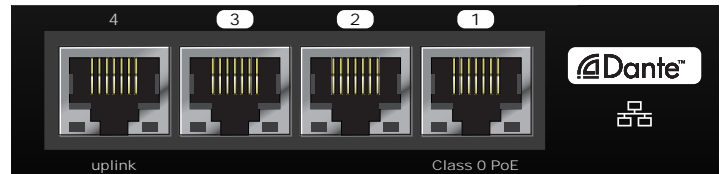

Networked Charger (NCS)

① Charging Slots (USB 2.0 Type A Plug)

Store, recharge and link microphones in the USB slots. Slots are associated to channels in an APT according to the system setup in the GUI.

② Power LED

Illuminates when the unit powered on.

③ Link LED

Illuminates after a successful link.

④ Link Button

Press and hold for 10 seconds to link all microphones in the charger to channels of the associated APT.

⑤ Battery Status LEDs

Monitor microphone battery status during a charge, in increments of 10, 25, 50, 75, 100%

⑥ Locking DC Power Supply Jack

Screw the PS45 power supply to the input, illuminating the POWER LED.

⑦ Power Switch

Powers the unit on or off

⑧ Ethernet Port

Connects to the MXW system using a Cat5e (or higher) cable.

⑨ Network Status LED (Green)

- Off = no network link.
- On = sending or receiving digital audio over the network.
- Flashing = cannot establish a connection.

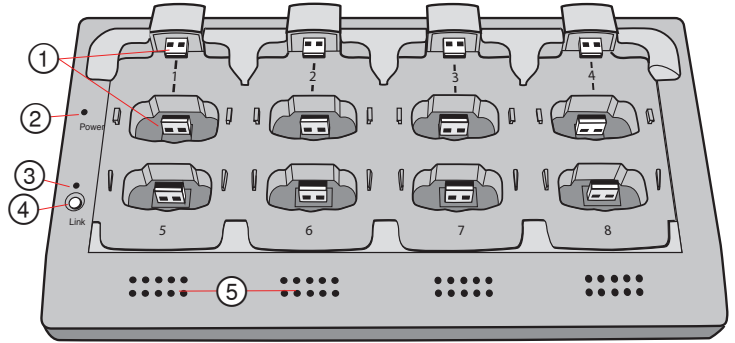

⑩ Network Speed LED (Amber)

- Off = 10 Mbps
- On = 100 Mbps

Charger Slots Correspond to Audio Channels

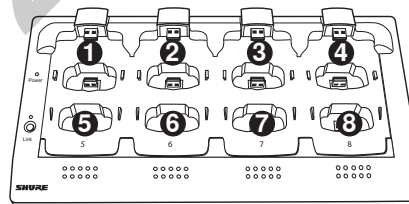

8-Channel Charger (NCS8)

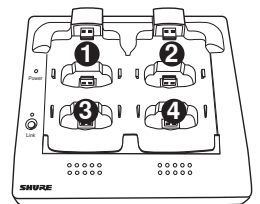

4-Channel Charger (NCS4)

Microphones



Description

① Power Button

Press button to turn the microphone on; the microphone LED will flash green and red until turning a solid color (color depends on state specified in GUI). Press and hold for 3 seconds to power off.

Note: The bodypack does not have a dedicated power button.

② Mute/Active Button

Changes the microphone state to Active or Mute. Each microphone type can be set to toggle or push-and-hold from the Preferences tab of the GUI. The following describes the function of each setting:

- **Toggle:** Press and release the button to change the status to Active or Mute.
- **Push-to-talk:** Hold button to pass audio.
- **Push-to-mute:** Hold button to mute the audio.

③ Microphone State LED

Indicates the microphone state. Pulsing Red = Standby mode; Off = microphone is off.

Customize the indication of Active and Mute for each transmitter type from the Preferences tab of the GUI. These options are displayed in the following table:

Mute	Active
Solid Red	Solid Green
Flashing Red	Solid Red
Solid Red	Off
Off	Solid Red
Flashing Green	Solid Green

Standby mode is always represented with a pulsing red LED.

④ Low Battery LED (Gooseneck and Boundary only)

Gooseneck and boundary microphones only.

Color	Status
Off	>10% battery runtime remains
Solid Red	≤10% battery runtime remains
Flashing Red	Battery is too low to transmit an RF signal. Recharge the microphone.

⑤ Earphone Jack

1/8" (3.5 mm) jack for monitoring the return channel signal, such as translated audio.

⑥ Charge Connector (USB 2.0 Type A Jack)

Connects to the NCS charger slot or to the optional (?? model) USB adapter cable.

Microphone Types and Applications

Choosing a Microphone Type

For each event, select microphones that will best serve the arrangement of participants and presenters. The following is a chart of each microphone and its primary use:

Type	Use	Placement Notes
Gooseneck	Sits on a desk or podium with an extended neck for close talking	
Boundary	Sits flat on a table or desk to provide coverage for one or two people.	
Bodypack	Connects to a lavalier microphone for placement on a speaker's clothing. When no lavalier is connected, an internal omnidirectional microphone is activated.	

Microphone States

After a microphone has been linked to the network, it is in one of four states (or, levels of activity). The following is a summary of each state:

Active

Ready to pass audio to network.

Mute

Audio is muted.

Standby

Audio is muted and the microphone is in a hibernation state to conserve the battery.

Off

No connection to the network. The microphone must be turned on using the power button on the mic.

Initial States After Removing from Charger

Each microphone type can be assigned to a specified state whenever it is removed from the charger. Go to the Preferences tab of the GUI to set the initial state for each microphone type.

When the Initial State is set to Standby, pressing the microphone's mute button will return it to one of two states as defined in the Switch behavior:

- Push-to-talk
- Active toggle

For example, an installer may prefer to have the handheld microphones exit the charger with a Mute status to avoid transmitting any handling noise to the audience.

Rechargeable Microphone Batteries

MXW microphones feature the Shure rechargeable Lithium-ion battery. Lithium-Ion chemistry and intelligent Shure battery circuitry results in a rechargeable battery with no memory effect. It can be recharged at any time; a complete discharge is not necessary.

Recharging the Battery

There are two ways to recharge the microphone battery:

Using the NCS Charger

Use the charger slots to recharge and store the microphones. Handheld, bodypacks, and boundary microphones use the vertical slots; gooseneck microphones use the back horizontal slots.

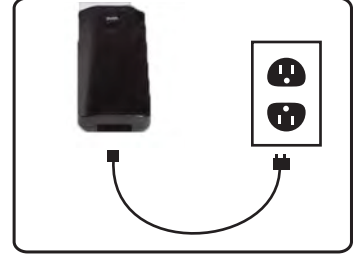

?? Model USB Power Adapter

The USB adapter allows the microphone to charge during operation.

Monitoring the Battery Information

Charge to Full Indicators

When the microphone is charging in the NCS charging station, the charger LEDs display battery in increments of 10, 25, 50, 75, 100%. For further detail, the Monitor page displays the time to full charge in hours:minutes.

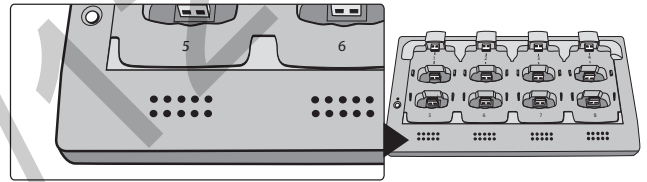

Battery Runtime Remaining

When the microphone is out of the charger, the Monitor tab will display the runtime remaining in hours:minutes.

Battery Life Statistics

On the Utility tab of the GUI, two battery life statistics that are displayed:

- **% Battery Capacity:** Percentage of charge capacity compared to a new battery
- **Cycle Count:** Number of charge cycles logged by the battery.

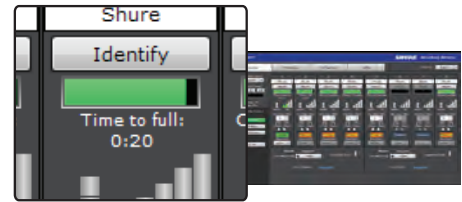

Replacing the Battery

Caution! Danger of exploding if battery is incorrectly replaced. Use only with the same or equivalent type.

Use the following guidelines for replacing the battery:

1. Unscrew and open the battery door.
2. Disconnect the battery from the microphone. Properly dispose of the old battery.
3. Plug the new battery to the jack on the microphone.
4. Replace the battery door and screw it shut.



% Batt Cap	Cycle Ct.
---	---
96	2

Networking

Dante technology uses standard IP over Ethernet and safely coexists on the same network as IT and control data. It provides an integrated solution to transport two types of data over the same network cable: Shure Control, and Dante Audio and Controller.

Shure Control: GUI and 3rd Party Control

The Shure Control carries data for the GUI operation, firmware updates and 3rd party control systems (AMX, Crestron, Extron). This data is transmitted over all MXW components connected to the network.

Dante Audio and Controller

This network carries both the Dante digital audio and the control data for Dante Controller. This data is transmitted between the APT and the ANI.

10/02/12

Networking Best Practices

Use the following best practices when setting up a network to ensure reliable communication:

- Always use a "star" network topology
- Use only 1 DHCP enabled server per network. Disable DHCP addressing on additional servers
- When using an AXT620 Ethernet Switch, turn on the switch first before turning on additional components connected to the network
- To expand the network, use multiple Ethernet switches in a star topology
- Connect each device directly to the port of an Ethernet switch. Avoid "daisy-chaining" Ethernet port connections between devices for larger networks.
- Do not loop network connections
- All networked devices must be set to the same subnet mask
- All devices must be at the same firmware revision level, with the exception of the AXT620 Ethernet Switch

Network Topologies

There are several ways to configure a network of devices. In general, you should always use a "star" network topology where each device uses one connection to an Ethernet switch port. If multiple switches are used, each switch is individually connected to one connection to the next level of Ethernet switch.

Below are three example configurations of large networks of devices.

Multiple Ethernet Switch Setup #1

- Any AXT620 switch (but only one) can be set as the DHCP server
- Each networked device needs an individual connection to the switch
- Connect them via any port

Server

AXT620 with front panel DHCP switch set to
OFF

Client

AXT610 ShowLink Access Point

Client

AXT620 with front panel DHCP switch set to
OFF

AXT620 with front panel DHCP switch set to ON

Multiple Ethernet Switch Setup #2

Each networked device needs an individual connection to the switch.

AXT620 with front panel DHCP switch set to ON

Ethernet Switch

Server

AXT610 ShowLink Access Point

Client

Multiple Ethernet Switch (Wi-Fi) Setup #3

Each networked device needs an individual connection to the switch.

Wi-Fi Router (DHCP enabled)

AXT620 with front panel DHCP switch set to OFF

Server

AXT620 with front panel DHCP switch set to OFF

Client

AXT610 ShowLink Access Point

Client

Configuring Firewalls for Mac or Windows Operating Systems

Mac OS Native Firewall

1. Open System Preferences.
2. Select Security, and then select the Firewall tab.
3. To enable editing, make sure the lock icon at the bottom of the window is unlocked before entering your password.
4. If the firewall is on, select Advanced. For each of the following applications, select "Allow Incoming Connections":
 - Wireless Workbench 6.app
 - slpd
 - snetDameon
 - acnproxy

Windows 7 Firewall

1. From the Start menu, select Control Panel.
2. Select Systems and Security.
3. Select Windows Firewall.
4. Select Allow a program or feature through Windows Firewall.
5. To view the list of applications, select Change Settings.
6. Select the following applications to allow them:
 - WWB6.exe
 - SLPD.exe
 - SNETDAMEON.exe

Windows XP or Vista Firewall

1. From the Start menu, select Control Panel.
2. Select Windows Firewall.
3. In the Windows Firewall window, if the firewall is set to On, select the Exceptions tab and add the following applications to the exceptions list:
 - WWB6.exe
 - SLPD.exe
 - SNETDAMEON.exe

Configuring Wi-Fi for Wireless Networking

When using Wireless Workbench over Wi-Fi, it's important to set up the wireless router properly for best performance. Wireless Workbench employs 'multicast' data protocols to communicate to the Axient and PSM1000 devices. Wi-Fi treats broadcast and multicast packets differently than general packets for backward compatibility reasons. In some cases, the Wi-Fi router will limit the multicast packet transmission rate to a value that is too slow for Wireless Workbench to properly operate.

By default, most Wi-Fi routers are configured to operate in 'b/g-mode', which tells the router to allow both 802.11g and older 802.11b devices to operate over the network. In this configuration, some routers will automatically limit the multicast data rates (or sometimes referred to as 'basic rate', or 'management rate') to 1-2Mbps. For small wireless microphone configurations of less than 20-30 channels, this Wi-Fi setting should not cause any problems with Wireless Workbench.

Tip: For larger wireless microphone configurations of greater than 30 channels, it's recommended to configure the Wi-Fi router to operate in 'g-mode' only. Most routers will increase the multicast transmission rate to 6Mbps when operating in 'g-mode' thereby providing adequate bandwidth to Wireless Workbench.

Important: For best performance, use a Wi-Fi router that does not limit the multicast rate to 1-2 Mbps.

Shure recommends the following Wi-Fi router brands:

- Cisco
- Linksys
- Apple

Factory Reset

If a device isn't appearing on the network, perform a hard reset to return the device to default settings. Factory default settings are designed for automatic compatibility with other Shure networked devices.

Use following instructions to reset each device:

Access Point Transceiver

Press and hold the reset button for 10 seconds. The network audio status LED will briefly turn off to indicate the unit is rebooting.

Note: Factory resets delete system configurations made in the GUI, including device association and microphone linking.

Audio Network Interface

Press and hold the reset button for 5 seconds. The front panel LEDs will flash to indicate the unit is rebooting.

Networked Charging Station

Press and hold the link button while powering up the charger. Continue to hold the link button for 10 seconds. The LEDs will flash to indicate the unit is rebooting.

Set Appropriate Latency Settings

Latency settings determine the amount of time that a device can spend processing data packets. When a receiver is overloaded with traffic, audible clicks and pops may occur. Increasing the latency setting will improve performance for large networks.

Number of Switch Hops*	Recommended Latency Setting

* Each device is represents one switch hop.

Dedicate a Device for Master Clock

Dante uses the IEEE 1588 Precision Time Protocol (PTP) to automatically determine a single access point to act as the master clock for the network. This is typically the first APT that connects to the network (if several connect simultaneously, the master defaults to the APT with the lowest MAC address). The remaining Dante audio components slave to the master.

When a master device shuts down or goes offline, the system will automatically begin selecting another master. During this selection time (up to xx seconds), the entire system will **NOT** pass audio.

If the network or building management requires that devices are periodically shut down, you can manually select an access point as the Preferred Master device from Dante Controller software. This allows the installer to set up the system to ensure that the master access point never shuts down during events.

Software Introduction

MXW hardware networks to a computer to operate with several software programs, augmenting the system with additional features and comprehensive remote management.

The following software components are used with the MXW series:

- **Shure Device Discovery Application:** Uses Bonjour networking technology to display all Shure devices on the network that include a graphical user interface (GUI).
- **MXW Series GUI:** Hosted from the APT webserver and accessed from a typical web browser, this GUI is used to manage the network of MXW components.
- **MXWANI GUI:** Hosted from the ANI webserver and accessed from a typical web browser, this GUI is used to monitor the ANI's analog inputs/outputs and network configuration.
- **Dante Controller:** Dante Controller (DC) is a free software by Audinate that is used to configure and manage a network of Dante devices.
- **Dante Virtual Soundcard:** An audio driver used to monitor and record digital audio without additional equipment.

Shure Device Discovery Application

The Device Discovery application finds all Shure devices on the same network that have an embedded web server. These devices network with a computer to access the The Discovery app is included on the CD-Rom supplied with the APT and can be downloaded from the Shure website.

Device Discovery with Bonjour: Bonjour software is bundled with the installation of the Shure Device Discovery application. Bonjour technology provides zero configuration networking, allowing devices to automatically discover each other and configure to compatible settings.

Opening the MXW GUI

To access the MXW system GUI, follow these steps:

1. Load the Shure Device Discovery CD to a computer and install the application. Bonjour will install automatically to the computer.
2. Connect the PC to the same network as the APT.
3. Turn off the PC's WiFi to force the wired network interface.
4. Open the Discover app to view all Shure devices on the network.
5. Double-click on a unit to open its GUI in a browser.

Note: When Port 4 Uplink mode is enabled on the ANI, the Discovery app will not find the GUI. However, the GUI can still be opened by the bookmark or manually typing in the DNS name into the browser.

Recommended: Bookmark the GUI

The Discovery app uses Bonjour technology to open a device's GUI using its DNS name (Domain Name System). The DNS name is unique for each device and will never change (unlike IP addresses). Bookmark the GUI using the DNS name allows reliable access to the GUI without going through the Device Discovery app.

10102112

MXW System Graphical User Interface (GUI)

A graphical user interface (GUI) is software that allows comprehensive system control and monitoring from a computer. It is hosted from an embedded server built into the APT, and is accessible when properly networked to a computer or 3rd party control device. All hardware functions can be adjusted using the GUI.

GUI Description

The following is a description of each tab of the GUI:

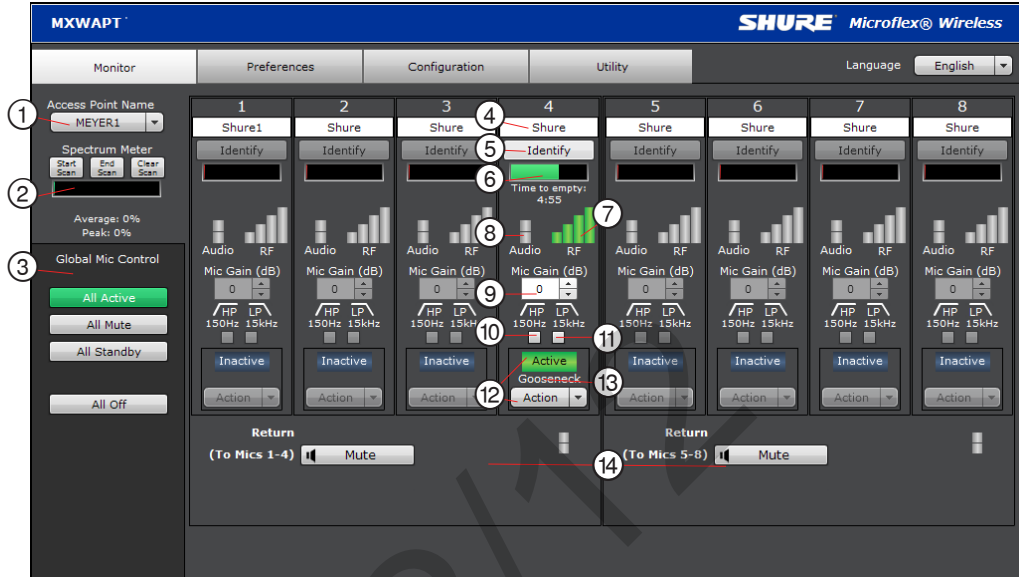

Monitor Tab

① APT Selection

Selects an APT for monitoring channel and RF spectrum information.

② Spectrum Meter

Displays the RF spectrum availability from a scan from the APT. See Spectrum Scan section for more details.

③ Global Mic Control

Controls the status of all microphones linked to the APT.

④ Microphone Name

Microphone names can be customized with up to 31 any characters in length except '=', ',', or '@'.

⑤ Identify Button

When clicked, this commands the microphone to beep and its LED to flash. Microphones must be removed from the charger for this function.

⑥ Battery Status

While charging: Displays the remaining time until the microphone battery is fully charged.

Not charging: Displays the remaining battery runtime of the microphone.

⑦ RF Signal Strength

⑧ Audio Input Meter

Indicate the average input signal level.

LED	Audio Signal Level	Description
Red (6)	-0.1 dBFS	Overload
Yellow (5)	-6 dBFS	Normal peaks
Yellow/ Green (4)	-12 dBFS	
Green (3)	-20 dBFS	Signal Present
Green (2)	-30 dBFS	
Green (1)	-40 dBFS	

⑨ Mic Gain

Adjusts microphone gain from -25 dB to +15 dB gain in 1 dB steps.

⑩ High Pass Filter

Engages a 6 dB-per-octave filter below 150 Hz for attenuating undesired low frequencies, sometimes caused by table vibrations or air-conditioning rumble.

⑪ Low Pass Filter

Engages a 6 dB-per-octave filter above 15 kHz for attenuating undesired high frequencies, sometimes caused by sibilant vocals or paper rustling.

⑫ Microphone State

Microphones are in one of four states:

- **Active:** Microphone is on and passing audio to the network.
- **Mute:** Microphone is on but the signal is muted.
- **Standby:** Conserves battery charge and allows the GUI to change the state to Active or Mute.
- **Off (Inactive):** The microphone is powered off. A microphone in this state cannot be controlled by the GUI (it can only be turned on using the power button on the mic).

⑬ Microphone Type

Displays the microphone type:

- Gooseneck
- Bodypack
- Boundary
- Handheld

⑭ Return Channels

Monitor the signal level and mute/unmute the audio of the return channel.

Preferences Tab

① Switch Behavior

Customize the switch for each microphone type.

- **Toggle:** Press and release the button to change the status to Active or Mute.
- **Push-to-talk:** Hold button to pass audio.
- **Push-to-mute:** Hold button to mute the audio.
- **Disabled:** The button does not affect the audio.

② Initial State from Charger

Assigns the initial state for each microphone type after removal from the charger:

- **Active:** Microphone is on and passing audio to the network.
- **Mute:** Microphone is on but the signal is muted.
- **Standby:** Conserves battery charge and allows the GUI to change the state to Active or Mute.
- **Off (Inactive):** The microphone is powered off. A microphone in this state cannot be controlled by the GUI (it can only be turned on using the power button on the mic).

③ LED Behavior

Set the behavior of the mute/active LED for each microphone type:

Mute	Active
Solid Red	Solid Green
Flashing Red	Solid Red
Solid Red	Off
Off	Solid Red
Flashing Green	Solid Green

Standby mode is always represented with a pulsing red LED.

④ Mute Preference

- **Local Mute - Individual:** Each microphone is muted individually.
- **Local Mute - All:** All microphones mute when any microphone is muted.
- **External Mute:** Microphones are muted by a 3rd-party control device.

⑤ RF Power Max

Determines the maximum distance that an APT will transmit.

- **Low:** ??'
- **Medium:** ??'
- **Medium High:** ??'
- **High:** ??'

⑥ Out of Range Alarm

⑦ Back in Range Action

⑧ Linking Preference

⑨ Language

⑩ Save/Load Preferences

⑪ Password Setup

⑫ Register the Product Link

Configuration Tab

① Device List

Customize the switch for each microphone type.

② Device Name

Device names can be customized with up to 31 any characters in length except '=', '!' or '@'.

③ Network Interface Selection

Determines which network interface's IP settings are displayed.

- **Control:**
- **Network Audio:**

④ IP Mode

Sets IP mode of the selected network interface:

- **Auto (DHCP):** For automatic DHCP or Link-Local IP addresses.
- **Manual (Static):** For Static IP addresses.

⑤ IP Settings

Displays the IP Address, Subnet Mask, and Gateway for each network interface.

⑥ MAC Address

The network interface's unique identification.

⑦ Group Row

Assign APTs, chargers, and audio output devices to form each group.

⑧ id? Button

Commands the selected device's LEDs to flash for easy identification.

⑨ Link Button

Links microphones to channels for the selected charger.

Utility Tab

① Export

Exports the data table to a text file that can be saved to a computer.

② Group

Indicates to which group the device is assigned/linked.

③ Device

The device type or microphone channel.

④ Type

The device model number.

⑤ Name

Displays name as defined in ____??

⑥ IP Address Control

Displays the IP Address of the control network interface (Shure GUI control).

⑦ IP Address Network Audio

Displays the IP Address of the Network Audio network interface (Dante audio and control).

⑧ S/N

Displays the device's serial number.

⑨ % Battery Capacity

Percentage of charge capacity compared to a new battery.

⑩ Cycle Count

Number of charge cycles logged by the battery.

⑪ Current Version

Displays the device's firmware version.

Control Bar

① Identify Button

This button sends a command to the hardware to flash front-panel LEDs for easy identification.

② Log Off

Logs the user out of the GUI. This appears only when a password has been set for Admin or Tech level.

③ Language Selection

Selects the language for the GUI. This setting will be saved to the computer.

Inputs/Outputs Tab

Inputs (Return Channels)

① Channel Name

Channel name is customizable by clicking in the text box. Names can be up to 12 characters long.

② Input Gain Setting (A, B)

Sets the analog input gain level.

③ Audio Meter

Displays input audio levels prior to the analog-to-digital converter.

④ Mute Button

Mutes or unmutes the channel's audio. The button illuminates red when a channel is muted.

Outputs (1-8, or 1-4)

⑤ Channel Name

Channel name is customizable by clicking in the text box. Names can be up to 12 characters long.

⑥ Output Gain

Sets the output gain level.

⑦ Audio Meter

Displays output audio levels prior to the digital-to-analog converter.

⑧ Attenuation

Output attenuation is adjustable in 1 dB increments.

⑨ Mute Button

Mutes or unmutes the channel's audio. The button illuminates red when a channel is muted.

Various

⑩ Network Audio Status

- Green = Sending or receiving a digital audio signal.
- Flashing green = Cannot establish a connection.

⑪ Notes

Save project notes here, such as installation dates or IP information.

Preferences Tab

① Language

Selects the language for the GUI when the ANI is in Standalone Network Mode. In Normal mode, this is defined in the APT GUI.

② Device Serial Number

Displays the device's serial number.

③ Firmware Version

Displays the current firmware version of the device.

④ Reset Button

Reboots the device with factory default settings.

⑤ Register This Product Link

Click to register the device at shure.com to receive product and software updates.

⑥ Networking Mode

- **Normal:** Enables automatic Dante channel routing with an APT.
- **Standalone:** Channels must be routed manually with Dante Controller software.

⑦ Device Name

Device name is customizable by clicking in the text box. Names can be up to 12 characters long (alphanumeric and a limited set of special characters are allowed).

⑧ Addressing Mode

Auto: IP settings are Link-Local or automatically accepted from a DHCP server.

Manual: IP settings (IP Address, Subnet Mask, and Gateway) are static and are entered manually.

⑨ MAC Address

⑩ Port 4 Mode

Configures the Port 4 of the network interface:

- **Switched (default):** Full Ethernet support.
- **Uplink:** Only control data for the GUI is transported. Multicast traffic for Dante and the Shure Device Discovery is restricted.

⑪ Front Panel Lockout

Disables the front panel controls on the hardware. Channels can still be selected for monitoring at the headphone jack.

⑫ Password

By default, the GUI has no password or security levels. Setting a password for the Admin will automatically generate a Guest-level logon. An additional, Tech-level logon can be created. The following describes the access rights of each logon type:

Admin: Full editing rights. The Admin can enable or disable a Tech-level logon.

Tech: Rights are limited to the functions that are also editable from the hardware: gain, mute, solo, and reset.

Guest: Monitoring only.

Dante Software by Audinate

Audinate software provides additional function and control of the Dante digital audio network. Visit Audinate's website for instructions for download and installation.

Dante Controller

Dante Controller (DC) is a free software by Audinate that is used to configure and manage a network of Dante devices. Use it to route channels between Dante-enabled devices and to monitor the status of the device, clock, and network.

Note: DC software is not required for routing audio within the MXW system. Use caution when using DC, as changing settings may interfere with MXW system functionality.

Dante Virtual Soundcard

Dante Virtual Soundcard (DVS) acts as an audio driver used to monitor and record digital audio without additional equipment. DVS uses a computer's standard Ethernet ports to transmit and receive up to 64 channels from any Dante enabled device on the same network.

10/02/12

Optimizing the System

10/02/12

Site Survey: RF Spectrum Scan

The APT features a scanning tool to survey the RF spectrum prior to the installation. It should be conducted during typical hours of activity to identify the availability of the RF spectrum. The channel count limit will be determined by the availability of clear spectrum.

During a scan, the APT turns off all associated microphones in order to survey the spectrum of the room for interference from devices such as cordless phones, walkie-talkies, or intercoms.

Performing a Scan

The following steps are used to perform the RF scan:

1. Connect the APT and computer to the same network.
2. Open the Monitor tab of the GUI and press the Start Scan button.
3. Run the scan for the entire time that an event may take place.

10/02/12

Setting RF Gain for Installation

Dynamic RF Power Control

By default, the MXW system automatically adjusts the RF power level based on the distance between an APT and the microphones. This prevents signal dropout if a microphone is taken outside of the radius of the coverage of the current RF level.

Note: Greater RF coverage uses more battery power and decreases the battery runtime. Additionally it increases the required distance between systems.

RF Level and Coverage Area

Level 3: 100'

Level 2: 50'

Level 1: 25'

Manually Setting RF Power

You can limit the RF gain in order to maximize RF efficiency of a fixed space and save microphone battery life.

There are three stages of RF gain in the APT for coverage over a range of installation sizes: Level 3: 100' radius, Level 2: 50' radius, Level 1: 25' radius. RF setting affects the microphone battery (higher level uses more power, reducing battery runtime) and the system ability to reuse channels in a space. Using a lower gain level decreases space the needed between systems to avoid conflicting DECT frequency allotment.

Adjacent Room Freq. Coordination

Average Battery Runtime per Power Level

The following table displays the average runtime of the transmitter for each RF power level:

RF Power Level	Microphone Runtime
Low	? hours
Medium	? hours
Medium High	? hours
High	? hours

Removing/Exchanging a Component from the Group

To exchange a microphone, place the new microphone in the charger slot that corresponds to the desired channel. Press and hold the link button for 10 seconds to link the microphone to the channel. The old microphone will no longer be a part of the system and no change will occur for the remaining channels.

Important: Always note the charger slot and channel when replacing microphones. The link will immediately override the existing microphone's audio and RF connection to the system.

10/02/12

Firmware Updates

Firmware is embedded software in each component that controls functionality. Periodically, new versions of firmware are developed to incorporate additional features and enhancements. To take advantage of design improvements, new versions of the firmware can be uploaded and installed using the Firmware Manager tool. Software is available for download from <http://www.shure.com>.

Perform the following steps to update the firmware for the MXWANI:

CAUTION! Ensure the device has a stable network connection during the update. Do not turn off the device until the update is complete.

1. Download Firmware Update Manager from <http://www.shure.com> and install the software.
2. Open the software.
3. Click **Check Now** to view new versions available for download.
4. Select the updates and click **download**.
5. Connect the device and computer to the same network. If Port 4 is used, ensure Port 4 Mode is set to Switched mode (default) on the Preferences tab.
6. Download the latest firmware to the device.

Once the download is complete, the device automatically begins the firmware update, which overwrites the existing firmware.

10/02/12

Troubleshooting

Audio

Networking

Control Software

Control Command Strings

10/02/12

Safety Information

MXW1

Bodypack Microphone Transmitters:

These transmitters have been tested and found to comply with international radiation exposure limits set forth for an uncontrolled environment. This equipment is in direct contact with the body of the user under normal operating conditions. These transmitters must not be co-located or operating in conjunction with any other antenna or transmitter.

MXW6, MXW8, MXWAPT4, MXWAPT8

Tabletop Gooseneck Microphone Transmitters, Tabletop Boundary Microphone Transmitters, Wireless Access Point Transmitters:

These mobile transmitters are intended for use at distances greater than 20 centimeters from the human body. These mobile transmitters are exempt from the testing requirements of international radiation exposure standards due to their proximity to the body of the user in their intended use case and their low power output. These mobile transmitters shall be placed or installed at least 20 cm from any person and must not be co-located or operating in conjunction with any other antenna or transmitter.

Important Product Information

The equipment is intended to be used in professional audio applications.

EMC conformance testing is based on the use of supplied and recommended cable types. The use of other cable types may degrade EMC performance.

Changes or modifications not expressly approved by Shure Incorporated could void your authority to operate this equipment.

Please follow your regional recycling scheme for batteries, packaging, and electronic waste.

Note: This device is not intended to be connected directly to a public internet network.

Information to the user

This equipment has been tested and found to comply with the limits for a Class B digital device, pursuant to Part 15 of the FCC Rules. These limits are designed to provide reasonable protection against harmful interference in a residential installation. This equipment generates uses and can radiate radio frequency energy and, if not installed and used in accordance with the instructions, may cause harmful interference to radio communications. However, there is no guarantee that interference will not occur in a particular installation. If this equipment does cause harmful interference to radio or television reception, which can be determined by turning the equipment off and on, the user is encouraged to try to correct the interference by one or more of the following measures:

Reorient or relocate the receiving antenna.

- Increase the separation between the equipment and the receiver.
- Connect the equipment to an outlet on a circuit different from that to which the receiver is connected.
- Consult the dealer or an experienced radio/TV technician for help.

Certifications

This device complies with Industry Canada licence-exempt RSS standard(s). Operation of this device is subject to the following two conditions: (1) this device may not cause interference, and (2) this device must accept any interference, including interference that may cause undesired operation of the device. Le présent appareil est conforme aux CNR d'Industrie Canada applicables aux appareils radio exempts de licence. L'exploitation est autorisée aux deux conditions suivantes : (1) l'appareil ne doit pas produire de brouillage, et (2) l'utilisateur de l'appareil doit accepter tout brouillage radioélectrique subi, même si le brouillage est susceptible d'en compromettre le fonctionnement.

Conforms to electrical safety requirements based on IEC 60065.

This product meets the Essential Requirements of all relevant European directives and is eligible for CE marking.

The CE Declaration of Conformity can be obtained from Shure Incorporated or any of its European representatives. For contact information please visit www.shure.com

The CE Declaration of Conformity can be obtained from: www.shure.com/europe/compliance

Authorized European representative:

Shure Europe GmbH
Headquarters Europe, Middle East & Africa
Department: EMEA Approval
Jakob-Dieffenbacher-Str. 12
75031 Eppingen, Germany
Phone: 49-7262-92 49 0
Fax: 49-7262-92 49 11 4
Email: EMEAsupport@shure.de

MXWNCS4, MXWNCS8

Authorized under the FCC verification provision per Part 15b.

This Class B digital apparatus complies with Canadian ICES-003. Cet appareil numérique de la classe B est conforme à la norme NMB-003 du Canada.

Note: See the label located on the bottom side of the charger enclosure for the FCC marking, the CE marking, the C-Tick marking, and the electrical ratings.

MXW1, MXW2, MXW6, MXW8, MXWAPT4, MXWAPT8

Certified under FCC Part 15.

FCC: DD4MXW1, DD4MXW2, DD4MXW6, DD4MXW8, DD4MXWAPT4, DD4MXWAPT8.

Meets applicable requirements of RSS-213.

IC: 616A-MXW1, 616A-MXW2, 616A-MXW6, 616A-MXW8, 616A-MXWAPT4, 616A-MXWAPT8.

Specifications

10/02/12

10/02/12



United States, Canada, Latin America, Caribbean:

Shure Incorporated
5800 West Touhy Avenue
Niles, IL 60714-4608 USA

Phone: 847-600-2000
Fax: 847-600-1212 (USA)
Fax: 847-600-6446
Email: info@shure.com

Europe, Middle East, Africa:

Shure Europe GmbH
Jakob-Dieffenbacher-Str. 12,
75031 Eppingen, Germany

Phone: 49-7262-92490
Fax: 49-7262-9249114
Email: info@shure.de

Asia, Pacific:

Shure Asia Limited
22/F, 625 King's Road
North Point, Island East
Hong Kong

Phone: 852-2893-4290
Fax: 852-2893-4055
Email: info@shure.com.hk