

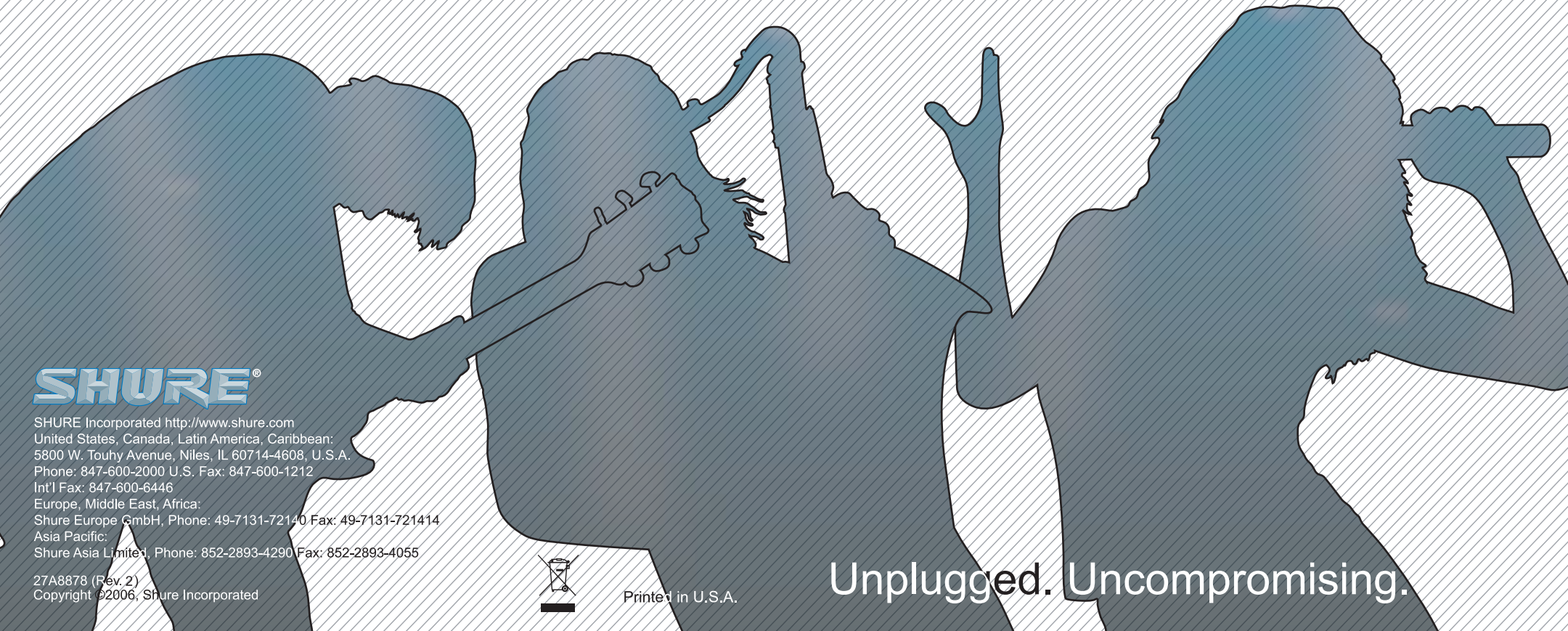

SHURE®

PGX Wireless User Guide

Shure PGX Wireless User Guide



SHURE®

SHURE Incorporated <http://www.shure.com>
United States, Canada, Latin America, Caribbean:
5800 W. Touhy Avenue, Niles, IL 60714-4608, U.S.A.
Phone: 847-600-2000 U.S. Fax: 847-600-1212
Int'l Fax: 847-600-6446
Europe, Middle East, Africa:
Shure Europe GmbH, Phone: 49-7131-72140 Fax: 49-7131-721414
Asia Pacific:
Shure Asia Limited, Phone: 852-2893-4290 Fax: 852-2893-4055

27A8878 (Rev. 2)
Copyright ©2006, Shure Incorporated



Printed in U.S.A.

Unplugged. Uncompromising.

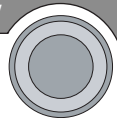

Shure PGX Wireless

The New Breed of Shure Wireless Systems

Created for active musicians and presenters who also manage their own sound, Shure PGX Wireless improves your performance and simplifies your setup.

Innovations such as automatic frequency selection and automatic transmitter setup make wireless quicker and completely worry free. PGX systems now feature Shure's patented Audio Reference Companding, delivering the crystal clear sound quality that pro audio engineers trust.

PGX gives you 9 systems to choose from and tour-tested wireless for guitars, instruments, and vocal mics — including the legendary SM58[®] vocal microphones. It's the best-sounding, simplest choice in wireless, from the leader in live performance sound.

Table of Contents

System Components	2
PGX4 Receiver Features	3
Front Panel	3
Back Panel	3
PGX2 Handheld Transmitter	4
Changing Batteries	4
Adjusting Gain	4
PGX1 Bodypack Transmitter	5
Wearing the Bodypack Transmitter	5
Changing Batteries	5
Adjusting Gain	5
Single System Setup	6
Multiple System Setup	7
Manual Frequency Selection (receiver only)	7
Troubleshooting	8
Locking and Unlocking Controls	8
Specifications	9
Replacement Parts	10

Patent numbers 6,597,301, 5,794,125, and 5,692,057.

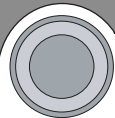

System Components

All systems include

- PGX4 receiver
- 2 AA batteries
- Power supply
- User guide

Vocalist systems include

- Microphone Head (choice of PG58, SM58®, SM86, or Beta 58A®)
- PGX2 handheld transmitter
- Microphone clip

Lavalier, Headworn, and Instrument systems include

- PGX1 bodypack transmitter
- Microphone (choice of WL93, WL185, PG30 or Beta 98H/C™)

Guitar systems include

- PGX1 bodypack transmitter
- 1/4" to mini 4-pin guitar cable

PGX4 Receiver Features

Front Panel

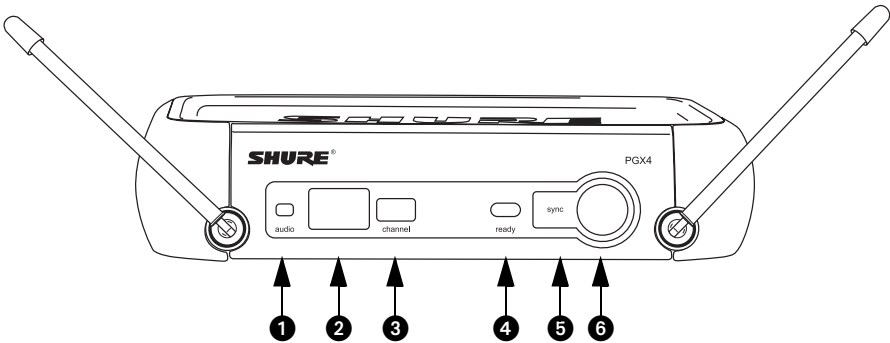

- 1 audio LED**
Indicates strength of incoming audio signal: green for normal, amber for strong, red for peak.
- 2 LED screen**
See “Single System Setup” on page 6.
- 3 channel button**
See “Single System Setup” on page 6.
- 4 ready LED**
Green light indicates system is ready for use.
- 5 Infrared (IR) port**
Broadcasts IR signal to transmitter.
- 6 sync button**
Press to synchronize transmitter and receiver frequencies.

Back Panel

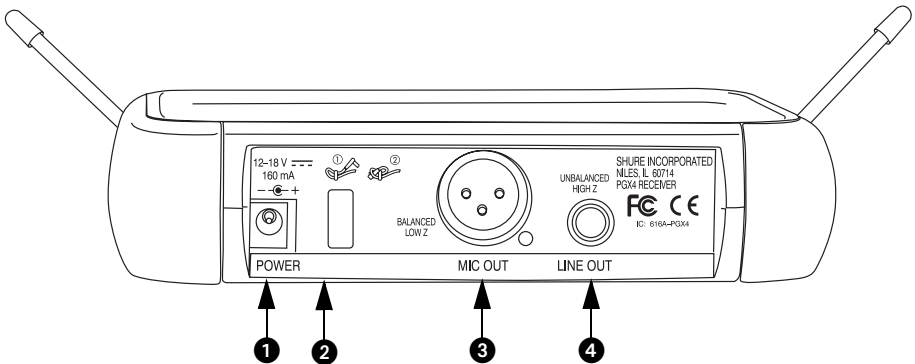

- 1 AC adapter jack**
- 2 Adapter cord tie-off**
- 3 XLR balanced microphone output jack**
- 4 1/4" unbalanced output jack**

PGX2 Handheld Transmitter

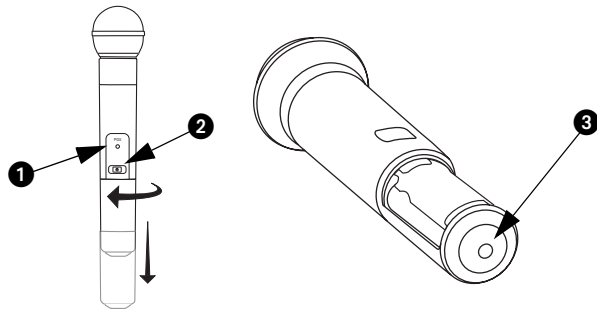

1 Power / Infrared (IR) / Mute indicator

Green	Ready
Flashing green	Controls locked (see page 8)
Amber	Mute on
Flashing red	IR transmission in process
Glowing red	Battery power low
Pulsing red on startup	Batteries dead (transmitter cannot be turned on until batteries are changed)
Pulsing red after synchronization	Transmitter and receiver incompatible; contact your Shure reseller

2 On-off / mute switch

Press and hold to turn on or off. Press and release to mute or unmute.

3 IR port

Receives infrared beam to synchronize frequencies. **When using multiple systems, only one transmitter IR port should be exposed at a time.**

Changing Batteries

- Expected life for alkaline batteries is approximately 8 hours.
- When the transmitter light glows red, the batteries should be replaced immediately, as shown on the right.

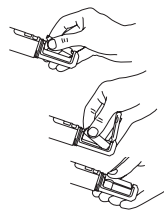

Adjusting Gain

- Access the gain adjustment switch by unscrewing the head of the microphone.
- Two gain settings ① are available on the PGX2. Use the tip of a pen or a small screwdriver to move the switch.

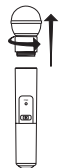

- **0dB:** For quiet to normal vocal performance.
- **-10dB:** Use only if audio is distorted due to high vocal levels.

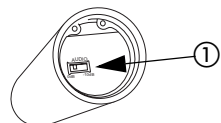

PGX1 Bodypack Transmitter

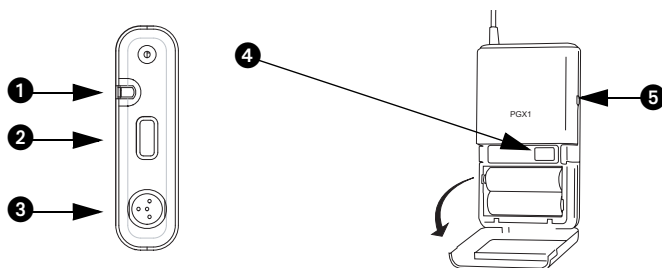

- 1 Power / Infrared (IR) / Mute indicator

Green	Ready
Flashing green	Controls locked (see page 8)
Amber	Mute on
Flashing red	IR transmission in process
Glowing red	Battery power low (transmitter cannot be turned off until batteries are changed)
Pulsing red on startup	Batteries dead (transmitter cannot be turned on until batteries are changed)
Pulsing red after synchronization	Transmitter and receiver incompatible; contact your Shure reseller

- 2 On-off / mute switch
Press and hold to turn on or off. Press and release to mute or unmute.
- 3 4-Pin Microphone Input Jack
- 4 IR port
Receives infrared beam to synchronize frequencies. **When using multiple systems, only one transmitter IR port should be exposed at a time.**
- 5 Gain adjustment switch (see below)

Wearing the Bodypack Transmitter

- Clip the transmitter to a belt ① or slide a guitar strap through the transmitter clip ② as shown. If using a belt, slide the transmitter until the belt is pressed against the base of the clip.

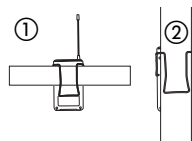

Changing Batteries

- Expected life for alkaline batteries is approximately 8 hours.
- When the transmitter light glows red, the batteries should be replaced immediately, as illustrated.

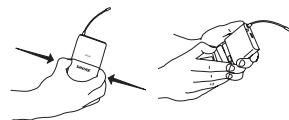

Adjusting Gain

- Three gain settings are available on the PGX1:
 - mic**: Microphone
 - 0**: Guitar
 - 10**: Use only if audio is distorted due to high input level

Single System Setup

In any wireless setup, each transmitter and receiver pair must be tuned to the same frequency, or channel. The PGX wireless system uses *automatic transmitter setup* to synchronize the transmitter and receiver channels.

Note: transmitting devices such as cellular phones and two-way radios, and digital devices such as CD players and effects processors, may interfere with wireless audio transmissions. Keep your PGX transmitters and receivers away from these and other potential sources of interference.

Single System Setup

1. Automatic Frequency Selection

Press and release the **channel** button. This scans for a clear channel and sets the receiver to that channel.

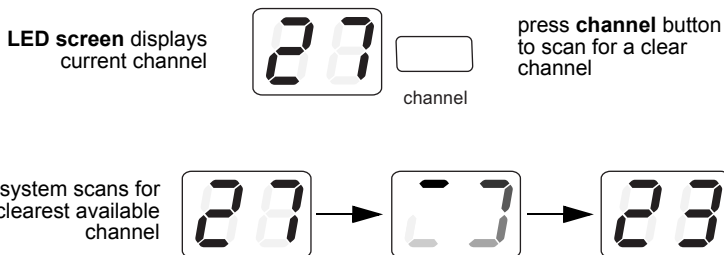

2. Automatic Transmitter Setup

Turn On the transmitter.

Open the transmitter battery compartment to display the infrared (IR) port (see pages 4 and 5).

With the transmitter IR port exposed to the receiver, press **sync**.

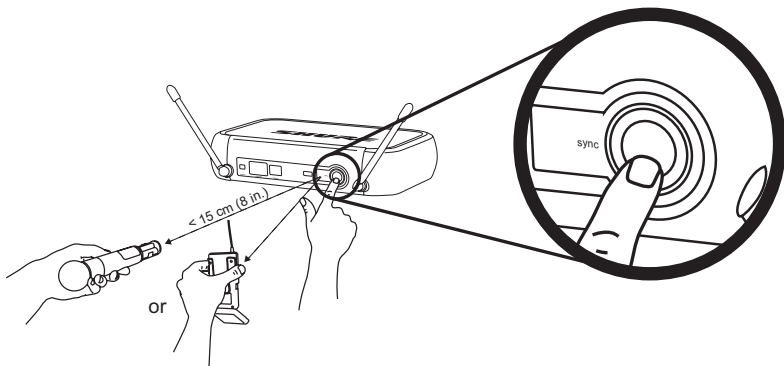

Hold the **sync** button until the red light stops flashing on both receiver and transmitter.

When the receiver **ready** light glows, the system is ready for use. Close the transmitter battery compartment.

Multiple System Setup

See the included frequency and channel guide for information on compatible channels.

Multiple system setups require the use of *groups* and *channels*. In the LED panel, the left digit indicates the current *group*; the right digit indicates the current *channel*.

left digit is **group**

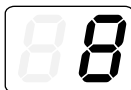
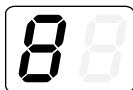

right digit is **channel**

Follow these steps when using multiple PGX systems in a single installation:

1. Turn all receivers **on** and all transmitters **off**.
2. Make sure the group number is the same for all receivers. If necessary, use Manual Frequency Selection (shown below) to set all receivers to a single group.
3. Perform **Automatic Frequency Selection** on the first receiver (see **page 6**).
4. Turn on the first transmitter.
5. Perform **Automatic Transmitter Setup** (see **page 6**).

Leave the transmitter turned on. Repeat for each system.

▶ **Be sure that only one transmitter's IR port is exposed when synchronizing a system.**

Manual Frequency Selection (receiver only)

To manually select a group or a channel, press and hold the **channel** button. The display alternates between the *group* number and the *channel* number.

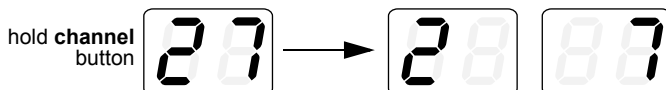

Releasing the **channel** button while either number is displayed makes the displayed number flash.

Pressing the **channel** button while either number is flashing increases the setting by one.

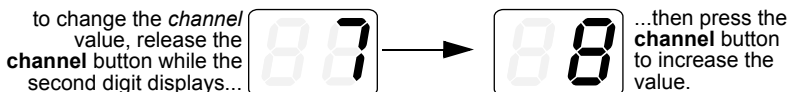
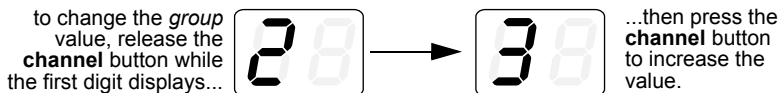

To activate a newly selected group or channel, simply wait until the number stops flashing.



Troubleshooting

Issue	Indicator Status	Solution
No sound or faint sound	Transmitter power light on, receiver LEDs on	<ul style="list-style-type: none"> • Perform automatic transmitter setup (see page 6) • Verify all sound system connections
	Receiver LED off	<ul style="list-style-type: none"> • Make sure AC adapter is securely plugged into electrical outlet and into DC input connector on rear panel of receiver • Make sure AC electrical outlet works and is supplying proper voltage
	Transmitter power light glowing or flashing red	<ul style="list-style-type: none"> • Replace transmitter batteries • If indicator continues flashing red after batteries are replaced, the transmitter and receiver may be from incompatible frequency bands. Contact your Shure reseller for assistance.
	Transmitter power light off	<ul style="list-style-type: none"> • Turn transmitter on • Make sure the +/- indicators on batteries match the transmitter terminals • Insert fresh batteries
Distortion or unwanted noise bursts		<ul style="list-style-type: none"> • Remove nearby sources of RF interference (CD players, computers, digital effects, in-ear monitor systems, etc.) • Change receiver and transmitter to a different frequency • Reduce transmitter gain • Replace transmitter batteries • If using multiple systems, change the frequency of one of the active systems
Distortion level increases gradually	Transmitter power light glowing or flashing red	<ul style="list-style-type: none"> • Replace transmitter batteries
Sound level different from cabled guitar or microphone, or when using different guitars		<ul style="list-style-type: none"> • Adjust transmitter gain as necessary
Cannot turn transmitter on	Transmitter light flashing red	<ul style="list-style-type: none"> • Replace transmitter batteries

Locking and Unlocking Controls

Locking the system controls prevents accidental muting or channel adjustment during performance.

Transmitter

To lock the controls: with the transmitter **off**, hold the **power**  button down until the green LED flashes (± 5 seconds).

To unlock the controls: with the transmitter **on**, hold the **power**  button down until the green LED flashes (± 5 seconds).



Receiver

To lock the channel: hold the **channel** button until the numbers flash (± 10 seconds).

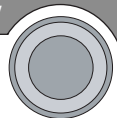
To unlock the channel: hold the channel button until the numbers flash (± 5 seconds).



Specifications

System	Working Range	100m (300 ft.) Note: actual range depends on RF signal absorption, reflection, and interference
	Audio Frequency Response +/- 2 dB	Minimum: 45 Hz Maximum: 15 kHz (Overall system frequency depends on microphone element.)
	Total Harmonic Distortion Ref. +/- 33 kHz deviation, 1 kHz tone	0.5%, typical
	Dynamic Range	>100 dB A-weighted
	Operating Temperature Range	-18°C (0°F) to +50°C (+122°F) Note: battery characteristics may limit this range
	Transmitter Audio Polarity	Positive pressure on microphone diaphragm (or positive voltage applied to tip of WA302 phone plug) produces positive voltage on pin 2 (with respect to pin 3 of low impedance output) and the tip of the high impedance 1/4-inch output.
PGX1 Bodypack Transmitter	Audio Input Level	-10 dBV maximum at "mic" gain position +10 dBV maximum at 0dB gain position +20 dBV maximum at -10dB gain position
	Gain Adjustment Range	30 dB
	Input Impedance	1 MΩ
	RF Transmitter Output	30 mW maximum (dependent on applicable country regulations)
	Dimensions	108 mm H x 64 mm W x 19 mm D (4.25 x 2.50 x 0.75 in.)
	Weight	81 grams (3 oz.) without batteries
	Housing	Molded polycarbonate case
	Power Requirements	2 "AA" size alkaline or rechargeable batteries
	Battery Life	>8 hours (alkaline)
PGX2 Handheld Transmitter	Audio Input Level	+2 dBV maximum at -10dB position -8 dBV maximum at 0dB position
	Gain Adjustment Range	10dB
	RF Transmitter Output	30 mW maximum (dependent on applicable country regulations)
	Dimensions including SM58 cartridge	254 mm x 51 mm dia. (10 x 2 in.)
	Weight	290 grams (10.2 oz.) without batteries
	Housing	Molded PC/ABS handle and battery cup
	Power Requirements	2 "AA" size alkaline or rechargeable batteries
	Battery Life	>8 hours (alkaline)
PGX4 Receiver	Dimensions	40 mm H x 181 mm W x 104 mm D (1.6 x 7.125 x 4.1 in.)
	Weight	327 g (11.5 oz.)
	Housing	ABS
	Audio Output Level Ref. +/- 33 kHz deviation with 1 kHz tone	XLR connector (into 600 Ω load): -19 dBV 1/4 inch connector (into 3000 Ω load): -5 dBV
	Output Impedance	XLR connector: 200 Ω 1/4 inch connector: 1kΩ
	XLR output	Impedance balanced Pin 1: Ground (cable shield) Pin 2: Audio Pin 3: No Audio
	Sensitivity	-105 dBm for 12 dB SINAD, typical
	Image Rejection	>70 dB, typical
	Power Requirements	12-18 Vdc at 150 mA, supplied by external power supply



Replacement Parts

All Systems	Microphone Stand Adapter (PGX2)	WA371
	Carrying Case	94B8429
System-Specific	AC Adapter (120 VAC, 60 Hz)	PS20
	AC Adapter (220 VAC, 50 Hz, Argentina)	PS20AR
	AC Adapter (230 VAC, 50/60 Hz, Europlug)	PS20E
	AC Adapter (230 VAC, 50/60 Hz, UK)	PS20UK
	AC Adapter (100 VAC, 50/60 Hz)	PS20J
	AC Adapter (220 VAC, 50 Hz, China)	PS20CHN
	PG58 Head with Grille	RPW108
	SM58 Head with Grille (PGX2/SM58)	RPW112
	SM86 Head with Grille (PGX2/SM86)	RPW114
	BETA 58 Head with Grille (PGX2/BETA 58)	RPW118
	Matte Silver Grille (PGX2/SM58)	RK143G
	Matte Silver Grille (PGX2/SM86)	RPM226
	Matte Silver Grille (PGX2/BETA 58)	RK265G
	Belt Clip	44A8030
	Optional Accessories	Black Grille (PGX2/BETA 58)
Zipper Bag (PGX1)		26A13
Zipper Bag (PGX2)		26A14
Universal Rack Tray		URT

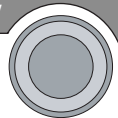

Regulatory and Licensing Information

PGX1 & PGX2 Transmitters:

Type Accepted under FCC Parts 74 (FCC ID: "DD4SLX1" & "DD4SLX2"). Certified by IC in Canada under RSS-123 and RSS-102 ("IC: 616A-SLX1" and "IC: 616A-SLX2"). Meets the essential requirements of the European R&TTE Directive 99/5/EC (ETSI EN 300-422 Parts 1 & 2, EN 301 489 Parts 1 & 9) and is eligible to carry the CE marking. **CE** 0682 ⓘ

PGX4 Receiver:

Authorized under the Declaration Of Conformity provision of FCC Part 15B. Certified under Industry Canada to RSS-123 ("IC: 616A-PGX4"). Meets the essential requirements of the European R&TTE Directive 99/5/EC (EN 301 489 Parts 1 & 2, EN 300 422 Parts 1 & 2) and is eligible to carry the CE marking. **CE**

PS 20 Series Power Supplies:

Conforms to Safety Standard IEC 60065. PS20E and PS20UK are eligible to bear CE marking.

PS20AR: Conforms to Safety Standard IEC 60065. Certified TÜV Rheinland, Argentina S.A., No. RA2681022.

A ministerial license may be required to operate this equipment in certain areas. Consult your national authority for possible requirements.

This radio equipment is intended for use in musical professional entertainment and similar applications.

Les transmetteurs modèle Shure PGX1 et PGX2 :

Type accepté sous FCC partie 74 (FCC ID : « DD4SLX1 » et « DD4SLX2 »). Certifié par IC au Canada sous RSS-123 et RSS-102 (« IC : 616A-SLX1 » et « IC: 616A-SLX2 »). Conforme aux exigences essentielles de la directive européenne R&TTE 99/5/CE (ETSI EN 300 422, partie 1 et 2, ETSI EN 301 489, partie 1 et 9) et sont autorisés à porter la marque CE.

Le récepteur modèle Shure PGX4 :

Autorisé aux termes de la clause de Déclaration de conformité de la FCC section 15B. Certifié par IC au Canada sous RSS-123 (« IC: 616A-PGX4 »). Conforme aux exigences essentielles de la directive européenne R&TTE 99/5/CE (ETSI EN 300 422, partie 1 et 2, ETSI EN 301 489, partie 1 et 9) et sont autorisés à porter la marque CE.

Les blocs d'alimentation PS20E et PS20UK :

Conforme aux spécifications IEC 60065 et sont autorisés à porter la marque CE.

PS20AR: Conforme aux spécifications IEC 60065. Certifié TÜV Rheinland, Argentina S.A.

Autorisation d'utilisation : Une licence officielle d'utilisation de ce matériel peut être requise dans certains pays. Consulter les autorités compétentes pour les exigences possibles.

Ce matériel radio est prévu pour une utilisation en spectacles musicaux professionnels et applications similaires.

Die Senders Modells PGX1 und PGX2:

Typenzulassung unter FCC Teil 74 (FCC ID: „DD4SLX1“ und „DD4SLX2“). Zugelassen durch die IC in Kanada unter RSS-123 und RSS-102 („IC: 616A-SLX1“ und „IC: 616A-SLX2“). Entsprechen den Grundanforderungen der europäischen R&TTE-Richtlinie 99/5/EC (ETSI-Normen EN 300 422, Teile 1 und 2, ETSI-Normen EN 301 489, Teile 1 und 9) und sind zum Tragen des CE-Zeichens berechtigt.

Der Empfänger Modell PGX4:

Zugelassen unter der Übereinstimmungserklärung der FCC, Teil 15B. Zugelassen durch die IC in Kanada unter RSS-123 („IC: 616A-PGX4“). Entsprechen den Grundanforderungen der europäischen R&TTE-Richtlinie 99/5/EC (ETSI-Normen EN 300 422, Teile 1 und 2, ETSI-Normen EN 301 489, Teile 1 und 9) und sind zum Tragen des CE-Zeichens berechtigt.

Der netzteilen Modells PS20E und PS20UK:

Entsprechen den Grundanforderungen IEC 60065 und sind zum Tragen des CE-Zeichens berechtigt.

PS20AR: Entsprechen den Grundanforderungen IEC 60065. Zulassung TÜV Rheinland, Argentina S.A., No. RA2681022.

Zulassung: In einigen Gebieten ist für den Betrieb dieses Geräts u.U. eine behördliche Zulassung erforderlich. Wenden Sie sich bitte an die zuständige Behörde, um Informationen über etwaige Anforderungen zu erhalten.

Diese Funkausrüstung ist zum Gebrauch bei professionellen Musikveranstaltungen und ähnlichen Anwendungen vorgesehen.

Los transmisores modelos PGX1 y PGX2:

Aceptado por espécimen bajo las normas de la FCC (Comisión Federal de Comunicaciones de los EE.UU.) (FCC ID: "DD4SLX1" y "DD4SLX2"). Certificados en Canadá por la IC bajo la norma RSS-123 y RSS-102 ("IC: 616A-SLX1" y "616A-SLX2"). Cumple con los requisitos esenciales de la directriz europea 99/5/EC de RTTE (ETSI EN 300-422, partes 1 y 2, ETSI EN 301 489, partes 1 y 9) y califican para llevar la marca CE.

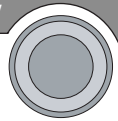

El receptor modelo PGX4:

Autorizado según la cláusula de Declaración de homologación de la parte 15B. Certificados en Canadá por la IC bajo la norma RSS-123 ("IC: 616A-PGX4"). Cumple con los requisitos esenciales de la directriz europea 99/5/EC de RTTE (ETSI EN 300-422, partes 1 y 2, ETSI EN 301 489, partes 1 y 9) y califican para llevar la marca CE.

Las fuentes de alimentación modelos PS20E y PS20UK:

Cumple la norma IEC 60065 y califican para llevar la marca CE.

PS20AR: Cumple la norma IEC 60065. Certificado TÜV Rheinland, Argentina S.A., No. RA2681022.

Licencia de uso: Se puede requerir una licencia ministerial para utilizar este equipo en algunas áreas. Consulte a la autoridad nacional sobre los posibles requisitos.

Este equipo de radio está destinado para uso en presentaciones musicales profesionales y situaciones similares.

I trasmettitori Shure modelli PGX1 e PGX2:

Di tipo approvato secondo le norme FCC Parte 74 (FCC ID: "DD4SLX1" e "DD4SLX2"). Omologato dalla IC in Canada a norma RSS-123 e RSS-102 ("616A-SLX1" e "616A-SLX2"). Conforme ai requisiti essenziali specificati nella direttiva europea R&TTE 99/5/EC (ETSI specificati nella norma EN 300 422, Parte 1 e Parte 2, ETSI specificati nella norma EN 301 489, Parte 1 e Parte 9) e possono essere contrassegnati con il marchio CE.

Il ricevitore Shure modello PGX4:

Omologato secondo la clausola di Dichiarazione di conformità delle norme FCC, Parte 15B. Omologato dalla IC in Canada a norma RSS-123 ("IC: 616A-PGX4"). Conforme ai requisiti essenziali specificati nella direttiva europea R&TTE 99/5/EC (ETSI specificati nella norma EN 300 422, Parte 1 e Parte 2, ETSI specificati nella norma EN 301 489, Parte 1 e Parte 9) e possono essere contrassegnati con il marchio CE.

Di alimentatori PS20E e PS20UK:

Conforme alle norme IEC 60065 e possono essere contrassegnati con il marchio CE.

PS20AR: Conforme alle norme IEC 60065. Certificado TÜV Rheinland, Argentina S.A., No. RA2681022.

Concessione della licenza all'uso: per usare questo apparecchio, in certe aree può essere necessaria una licenza ministeriale. Per i possibili requisiti, rivolgersi alle autorità competenti.

Questo apparecchio radio è inteso per intrattenimento a livello professionale ed applicazioni simili.

FCC DECLARATION OF CONFORMITY

We,
of

Shure Incorporated
222 Hartrey Avenue
Evanston, IL 60202-3696, U.S.A
(847) 866-2200

Declare under our sole responsibility that the following product

Model: PGX4 Description: UHF Receiver

Has been tested and found to comply with the limits for an unintentional radiator device, and approved under the Declaration of Conformity provision of the Part 15 of the FCC rules.

Operation is subject to the following two conditions:

1. This device may not cause harmful interference.
2. This device must accept any interference received, including interference that may cause undesired operation.

Signed
Name, Title

Craig Kozokar

Date SEPTEMBER 22, 2004

EMC Project Engineer, Corporate Quality, Shure Incorporated

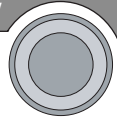

EU DECLARATION OF CONFORMITY

We,
of
Shure Incorporated
5800 Touhy Ave
Niles, Illinois, 60714-4608 U.S.A
(847) 600-2000

Declare under our sole responsibility that the following product

Model: PGX4 Description: UHF FM Receiver

PS20E, PS20UK

to which this Declaration relates

is in conformity to European R&TTE Directive 1999/5/EC

The product complies with the following product family, harmonized or national standards:

SLX4: EN 301 489-1 V1.4.1 (2002-08) EN 301 489-9 V1.3.1 (2002-08)

EN 300 422-1 V1.2.2 (2000-08) EN 300 422-2 V1.1.1 (2000-08)

PS20E, PS20UK: EN60065, EN61000-3-2, EN 61000-3-3

Manufacturer: Shure Incorporated

Signed *Craig Kozokar* Date September 22, 2004

Name, Title Craig Kozokar

European Contact: EMC Project Engineer, Corporate Quality, Shure Incorporated

Wannacker Str. 28, 74078 Heilbronn, Germany

Phone: 49-7131-7214-0, Fax: 49-7131-7214-14