

SHURE®

LEGENDARY
PERFORMANCE™

WIRELESS SYSTEM

ULX-D® USER GUIDE



ULX-D Digital Wireless Microphone System

Système de microphone sans fil numérique ULX-D

Digitales drahtloses Mikrofonsystem ULX-D

Sistema de micrófonos inalámbricos digitales ULX-D

Sistema radiomicrofonico digitale ULX-D

Sistema de Microfone Sem Fio Digital ULX-D

Цифровая беспроводная микрофонная система ULX-D

ULX-D Digital Wireless-systemen



FREQUENCIES FOR EUROPEAN COUNTRIES

ULXD-G51 470 - 534 MHz, max. 20 mW	
Country Code	Frequency Range
Code de Pays	Gamme de frequences
Codice di paese	Gamme di frequenza
Código de país	Gama de frecuencias
Länder-Kürzel	Frequenzbereich
A, B, BG, CH, CY, CZ, D, EST	470 - 534 MHz *
F, GB, GR, H, I, IS, L, LT	470 - 534 MHz *
NL, P, PL, S, SK, SLO	470 - 534 MHz *
DK, FIN, M, N	*
HR, E, IRL, LV, RO, TR	*
All other countries	*

ULXD-H51 534 - 598 MHz, max. 20 mW	
Country Code	Frequency Range
Code de Pays	Gamme de frequences
Codice di paese	Gamme di frequenza
Código de país	Gama de frecuencias
Länder-Kürzel	Frequenzbereich
A, B, BG, CH, CY, CZ, D, EST	534 - 598 MHz *
F, GB, GR, H, I, IS, L, LT	534 - 598 MHz *
NL, P, PL, S, SK, SLO	534 - 598 MHz *
DK, FIN, M, N	*
HR, E, IRL, LV, RO, TR	*
All other countries	*

ULXD-K51 606 - 670 MHz, max. 20 mW	
Country Code	Frequency Range
Code de Pays	Gamme de frequences
Codice di paese	Gamme di frequenza
Código de país	Gama de frecuencias
Länder-Kürzel	Frequenzbereich
A, B, BG, CH, CY, CZ, D, EST	606 - 670 MHz *
F, GB, GR, H, I, IS, L, LT	606 - 670 MHz *
NL, P, PL, S, SK, SLO	606 - 670 MHz *
RO	646-647; 654-655; 662-663 MHz*
DK, E, FIN, HR, IRL, LV, M, N, TR	*
All other countries	*

ULXD-P51 710 - 782 MHz, max. 20 mW	
Country Code	Frequency Range
Code de Pays	Gamme de frequences
Codice di paese	Gamme di frequenza
Código de país	Gama de frecuencias
Länder-Kürzel	Frequenzbereich
A, B, BG, CH, CY, CZ, D, EST, F, GB,	710 - 782 MHz *
GR, H, I, IS, L, LT, NL, P, PL, S, SK, SLO	710 - 782 MHz *
RO	718-719; 726-727; 734-743; 750-751; 758-759 MHz*
DK, E, FIN, HR, IRL, LV, M, N, TR	*
All other countries	*

ULXD-Q51 794 - 806 MHz, max. 20 mW	
Country Code	Frequency Range
Code de Pays	Gamme de frequences
Codice di paese	Gamme di frequenza
Código de país	Gama de frecuencias
Länder-Kürzel	Frequenzbereich
A, B, BG, CH, CY, CZ, D, DK, E, EST	*
F, FIN, GB, GR, H, HR, I, IRL, IS, L, LT	*
LV, M, N, NL, P, PL, S, SK, SLO, TR	*
All other countries	*

ULXD-R51 800 - 810 MHz, max. 20 mW	
Country Code	Frequency Range
Code de Pays	Gamme de frequences
Codice di paese	Gamme di frequenza
Código de país	Gama de frecuencias
Länder-Kürzel	Frequenzbereich
N	800 - 810 MHz*
A, B, BG, CH, CY, CZ, D, DK, E, EST	*
F, FIN, GB, GR, H, HR, I, IRL, IS, L, LT	*
LV, M, N, NL, P, PL, S, SK, SLO, TR	*
All other countries	*

ULXD-V51 174 - 216 MHz, max. 20 mW	
Country Code	Frequency Range
Code de Pays	Gamme de frequences
Codice di paese	Gamme di frequenza
Código de país	Gama de frecuencias
Länder-Kürzel	Frequenzbereich
A, B, BG, CH, CY, CZ, D, DK, E, EST	*
F, FIN, GB, GR, H, HR, I, IRL, IS, L, LT	*
LV, M, N, NL, P, PL, S, SK, SLO, TR	*
All other countries	*

* **NOTE:** This Radio equipment is intended for use in musical professional entertainment and similar applications. This Radio apparatus may be capable of operating on some frequencies not authorized in your region. Please contact your national authority to obtain information on authorized frequencies and RF power levels for wireless microphone products.

* **REMARQUE :** Ce matériel radio est prévu pour une utilisation en spectacles musicaux professionnels et applications similaires. Il est possible que cet appareil radio soit capable de fonctionner sur certaines fréquences non autorisées localement. Se mettre en rapport avec les autorités compétentes pour obtenir les informations sur les fréquences et niveaux de puissance HF autorisés pour les systèmes de microphones sans fil.

* **HINWEIS:** Diese Funkausrüstung ist zum Gebrauch bei professionellen Musikveranstaltungen und ähnlichen Anwendungen vorgesehen. Dieses Gerät kann möglicherweise auf einigen Funkfrequenzen arbeiten, die in Ihrem Gebiet nicht zugelassen sind. Wenden Sie sich bitte an die zuständige Behörde, um Informationen über zugelassene Frequenzen und erlaubte Sendeleistungen für drahtlose Mikrofonprodukte zu erhalten.

* **NOTA:** Este equipo de radio está destinado para uso en presentaciones musicales profesionales y usos similares. Este aparato de radio puede ser capaz de funcionar en algunas frecuencias no autorizadas en su región. Por favor comuníquese con las autoridades nacionales para información sobre las frecuencias autorizadas y los niveles de potencia de radiofrecuencia para micrófonos inalámbricos.

* **NOTA:** questo apparecchio radio è concepito per l'intrattenimento musicale a livello professionale ed applicazioni simili. Questo apparecchio radio può essere in grado di funzionare a frequenze non autorizzate nel Paese in cui si trova l'utente. Rivolgetevi alle autorità competenti per ottenere le informazioni relative alle frequenze ed ai livelli di potenza RF autorizzati nella vostra regione per i prodotti radiomicrofonici.

* **OPMERKING:** Deze radioapparatuur is bedoeld voor gebruik bij professionele muzikale amusementsproducties en soortgelijke toepassingen. Dit radioapparaat kan mogelijk werken op bepaalde frequenties die niet zijn toegestaan in uw regio. Raadpleeg de autoriteiten in uw land voor informatie over goedgekeurde frequenties en RF-vermogensniveaus voor draadloze microfoons.

* **ПРИМЕЧАНИЕ.** Данная радиоаппаратура предназначена для использования в профессиональных музыкальных представлениях и аналогичных приложениях. Может оказаться, что эта радиоаппаратура в состоянии работать на некоторых частотах, не разрешенных в вашем регионе. За информацией о разрешенных частотах и уровнях РЧ мощности для беспроводных микрофонных систем обращайтесь в национальные органы власти.

ULX-D® Digital Wireless Microphone System

IMPORTANT SAFETY INSTRUCTIONS

1. READ these instructions.
2. KEEP these instructions.
3. HEED all warnings.
4. FOLLOW all instructions.
5. DO NOT use this apparatus near water.
6. CLEAN ONLY with dry cloth.
7. DO NOT block any ventilation openings. Allow sufficient distances for adequate ventilation and install in accordance with the manufacturer's instructions.
8. DO NOT install near any heat sources such as open flames, radiators, heat registers, stoves, or other apparatus (including amplifiers) that produce heat. Do not place any open flame sources on the product.
9. DO NOT defeat the safety purpose of the polarized or grounding type plug. A polarized plug has two blades with one wider than the other. A grounding type plug has two blades and a third grounding prong. The wider blade or the third prong are provided for your safety. If the provided plug does not fit into your outlet, consult an electrician for replacement of the obsolete outlet.
10. PROTECT the power cord from being walked on or pinched, particularly at plugs, convenience receptacles, and the point where they exit from the apparatus.
11. ONLY USE attachments/accessories specified by the manufacturer.
12. USE only with a cart, stand, tripod, bracket, or table specified by the manufacturer, or sold with the apparatus. When a cart is used, use caution when moving the cart/apparatus combination to avoid injury from tip-over.
13. UNPLUG this apparatus during lightning storms or when unused for long periods of time.
14. REFER all servicing to qualified service personnel. Servicing is required when the apparatus has been damaged in any way, such as power supply cord or plug is damaged, liquid has been spilled or objects have fallen into the apparatus, the apparatus has been exposed to rain or moisture, does not operate normally, or has been dropped.
15. DO NOT expose the apparatus to dripping and splashing. DO NOT put objects filled with liquids, such as vases, on the apparatus.
16. The MAINS plug or an appliance coupler shall remain readily operable.
17. The airborne noise of the Apparatus does not exceed 70dB (A).
18. Apparatus with CLASS I construction shall be connected to a MAINS socket outlet with a protective earthing connection.
19. To reduce the risk of fire or electric shock, do not expose this apparatus to rain or moisture.
20. Do not attempt to modify this product. Doing so could result in personal injury and/or product failure.
21. Operate this product within its specified operating temperature range.



This symbol indicates that dangerous voltage constituting a risk of electric shock is present within this unit.



This symbol indicates that there are important operating and maintenance instructions in the literature accompanying this unit.

WARNING: Voltages in this equipment are hazardous to life. No user-serviceable parts inside. Refer all servicing to qualified service personnel. The safety certifications do not apply when the operating voltage is changed from the factory setting.

Important Product Information

LICENSING INFORMATION

Licensing: A ministerial license to operate this equipment may be required in certain areas. Consult your national authority for possible requirements. Changes or modifications not expressly approved by Shure Incorporated could void your authority to operate the equipment. Licensing of Shure wireless microphone equipment is the user's responsibility, and licensability depends on the user's classification and application, and on the selected frequency. Shure strongly urges the user to contact the appropriate telecommunications authority concerning proper licensing, and before choosing and ordering frequencies.

Information to the user

This equipment has been tested and found to comply with the limits for a Class B digital device, pursuant to Part 15 of the FCC Rules. These limits are designed to provide reasonable protection against harmful interference in a residential installation. This equipment generates uses and can radiate radio frequency energy and, if not installed and used in accordance with the instructions, may cause harmful interference to radio communications. However, there is no guarantee that interference will not occur in a particular installation. If this equipment does cause harmful interference to radio or television reception, which can be determined by turning the equipment off and on, the user is encouraged to try to correct the interference by one or more of the following measures:

- Reorient or relocate the receiving antenna.
- Increase the separation between the equipment and the receiver.
- Connect the equipment to an outlet on a circuit different from that to which the receiver is connected.
- Consult the dealer or an experienced radio/TV technician for help.

This device complies with Industry Canada licence-exempt RSS standard(s). Operation of this device is subject to the following two conditions: (1) this device may not cause interference, and (2) this device must accept any interference, including interference that may cause undesired operation of the device.

Le présent appareil est conforme aux CNR d'Industrie Canada applicables aux appareils radio exempts de licence. L'exploitation est autorisée aux deux conditions suivantes : (1) l'appareil ne doit pas produire de brouillage, et (2) l'utilisateur de l'appareil doit accepter tout brouillage radioélectrique subi, même si le brouillage est susceptible d'en compromettre le fonctionnement.

WARNING: Danger of explosion if battery incorrectly replaced. Operate only with Shure compatible batteries.

Note: Use only with the included power supply or a Shure-approved equivalent.

WARNING

- Battery packs may explode or release toxic materials. Risk of fire or burns. Do not open, crush, modify, disassemble, heat above 140°F (60°C), or incinerate.
- Follow instructions from manufacturer
- Only use Shure charger to recharge Shure rechargeable batteries
- **WARNING:** Danger of explosion if battery incorrectly replaced. Replace only with same or equivalent type.
- Never put batteries in mouth. If swallowed, contact your physician or local poison control center
- Do not short circuit; may cause burns or catch fire
- Do not charge or use battery packs other than Shure rechargeable batteries
- Dispose of battery packs properly. Check with local vendor for proper disposal of used battery packs.
- Batteries (battery pack or batteries installed) shall not be exposed to excessive heat such as sunshine, fire or the like

WARNING: This product contains a chemical known to the State of California to cause cancer and birth defects or other reproductive harm.

This is the quick-reference version of the user guide.

For information on the following topics, visit www.shure.com to download the comprehensive manual:

- High Density mode
- Frequency Diversity
- Audio Summing
- Encryption
- Dante digital audio
- Multiple systems setup
- RF and hardware presets
- Networking details
- Warning Messages
- AMX and Crestron connections
- Firmware updates
- Troubleshooting
- Product specifications and wiring diagrams
- Compatible frequencies chart



General Description

Shure ULX-D™ Digital Wireless offers uncompromising audio quality and RF performance, with intelligent, encryption-enabled hardware, flexible receiver options, and advanced rechargeability options for professional sound reinforcement.

A breakthrough in wireless audio quality, Shure digital processing enables ULX-D to deliver the purest reproduction of source material ever available in a wireless system, with a wide selection of trusted Shure microphones to choose from. Extended 20 Hz – 20 KHz frequency range and totally flat response captures every detail with clarity, presence, and incredibly accurate low end and transient response. At greater than 120 dB, ULX-D delivers wide dynamic range for excellent signal-to-noise performance. For added convenience, proprietary Shure Gain Ranging optimizes the system's dynamic range for any input source, eliminating the need for transmitter gain adjustments.

In RF performance, ULX-D sets the bar for spectral efficiency and signal stability. The intermodulation performance of ULX-D is an incredible advancement in wireless performance, enabling a dramatic increase in the number of simultaneous active transmitters on one TV channel. Rock-solid RF signal with no audio artifacts extends over the entire 100-meter line-of-sight range, even using standard dipole antennas. For applications where secure transmission is required, ULX-D offers Advanced Encryption Standard (AES) 256-bit encrypted signal for unbreachable privacy.

For scalability and modular flexibility, ULX-D receivers come in dual and quad channel versions providing rack-ready conveniences such as RF cascade, internal power supply, audio output channel summing, and DANTE™ digital networking, which delivers multi-channel audio over Ethernet. All receivers offer High-Density mode for closer-range applications where high channel counts are needed, greatly increasing the amount of simultaneous channels possible over one frequency band.

Advanced Lithium-ion rechargeability provides extended transmitter battery life over alkaline batteries, battery life metering in hours and minutes accurate to within 15 minutes, and detailed tracking of battery health status.

Combined with the suite of features and benefits ULX-D™ Digital Wireless Systems offer, the ULXD4D and ULXD4Q receivers are truly generations ahead of any other digital receivers in their class, and bring a new level of performance to professional sound reinforcement.

Dual and Quad Receiver Models

The ULXD4 receiver is available in dual channel and quad channel models. Both models share the same feature set and functionality, but differ in the number of channels available and the number of audio outputs.

The descriptions and procedures in this guide are applicable to either the dual or the quad receiver.

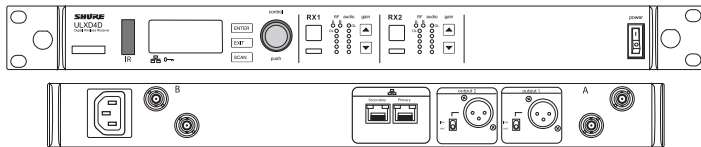

ULXD4D Dual Receiver

Supports 2 channels of wireless audio.

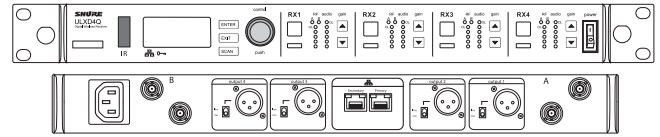

ULXD4Q Quad Receiver

Supports 4 channels of wireless audio.

Receiver

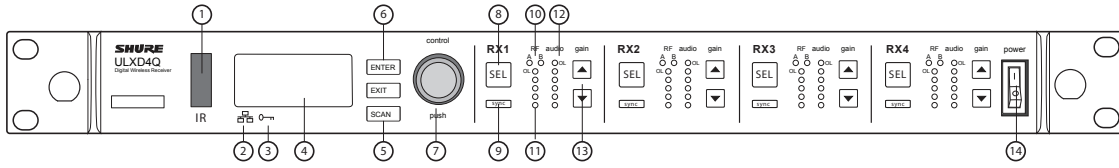

Front Panel

① Infrared (IR) Sync Window

Sends IR signal to the transmitter for sync.

② Network Icon

Illuminates when the receiver is connected with other Shure devices on the network. IP Address must be valid to enable networked control.

③ Encryption Icon

Illuminates when AES-256 encryption is activated.

④ LCD Panel

Displays settings and parameters.

⑤ Scan Button

Press to find the best channel or group.

⑥ Menu Navigation Buttons

Use to navigate and select parameter menus.

⑦ Control Wheel

- Push to select a channel or menu item
- Turn to scroll through menu items or to edit a parameter value

⑧ Channel Select Button

Press to select a channel.

⑨ Sync Button

Press the **sync** button while the receiver and transmitter IR windows are aligned to transfer settings from the receiver to the transmitter.

⑩ RF Diversity LEDs

Indicate antenna status:

- Blue = normal RF signal between the receiver and transmitter
- Red = interference detected
- Off = No RF connection between the receiver and transmitter

Note: the receiver will not output audio unless one blue LED is illuminated.

⑪ RF Signal Strength LEDs

Indicate the RF signal strength from the transmitter:

- Amber = Normal (-90 to -70 dBm)
- Red = Overload (greater than -25 dBm)

⑫ Audio LEDs

Indicate average and peak audio levels:

LED	Audio Signal Level	Description
Red (6)	-0.1 dBFS	Overload/ limiter
Yellow (5)	-6 dBFS	Normal peaks
Yellow (4)	-12 dBFS	
Green (3)	-20 dBFS	Signal Present
Green (2)	-30 dBFS	
Green (1)	-40 dBFS	

Note: In Frequency Diversity mode, simultaneous blinking of the red and yellow audio LEDs indicates that diversity audio has been routed to this channel.

⑬ Gain Buttons

Press the **▲ ▼ gain** buttons on the front of the receiver to incrementally adjust gain from -18 to +42 dB.

⑭ Power Switch

Powers the unit on or off.

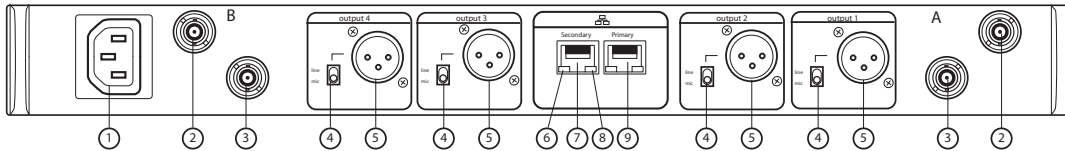

Back Panel

① AC Power Input

IEC Connector, 100 - 240 V AC.

② RF Antenna Diversity Input Jack (2)

For antenna A and antenna B.

③ RF Cascade Jack (2)

Passes the RF signal from Antenna A and Antenna B to one additional receiver.

④ Mic/Line Switch (one per channel)

Applies a 30 dB pad in **mic** position.

⑤ Balanced XLR Audio Output (one per channel)

Connect to a mic or line level input.

⑥ Network Status LED (Green)

One per network port.

- Off = no link
- On = network link
- Flashing = network link active

⑦ Ethernet/Dante Network Secondary Port

Connect to an Ethernet network to enable remote device control via WWB6 software. Also carries Dante digital audio and control signals for audio distribution, monitoring, and recording - see Dante Network topic.

⑧ Network Speed LED (Amber)

One per network port.

- Off = 10/100 Mbps
- On = 1 Gbps

⑨ Ethernet/Dante Network Primary Port

Connect to an Ethernet network to enable remote device control via WWB6 software. Also carries Dante digital audio and control signals for audio distribution, monitoring, and recording - see Dante Network topic.

Receiver Home Screen

The home screen displays the following information for each receiver channel:

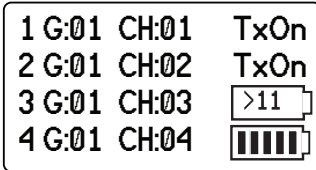

- Group and Channel
- Transmitter Status: **NoTx** or **TxOn**, battery icon/remaining battery life

Press the **SEL** button to access a channel menu screen.

Receiver Output Level

The following table describes the typical total system gain from the audio input to the receiver outputs:

Receiver Output Gain

Output Jack	System Gain (gain control = 0dB)
XLR (line setting)	+24 dB
XLR (mic setting)	-6 dB*

*This setting matches a typical wired SM58 audio signal level.

Transmitters

① Power LED

- Green = unit is powered on
- Red = low battery or battery error (see Troubleshooting)
- Amber = power switch is disabled

② On/Off Switch

Powers the unit on or off.

③ SMA Connector

Connection point for RF antenna.

④ LCD Display:

View menu screens and settings. Press any control button to activate the backlight.

⑤ Infrared (IR) Port

Align with the receiver IR port during an IR Sync for automated transmitter programming.

⑥ Menu Navigation Buttons

Use to navigate through parameter menus and change values.

- exit** Acts as a 'back' button to return to previous menus or parameters without confirming a value change
- enter** Enters menu screens and confirms parameter changes
- ▼▲** Use to scroll through menu screens and to change parameter values

⑦ Battery Compartment

Requires Shure SB900 rechargeable battery or 2 AA batteries.

⑧ AA Battery Adapter

- Handheld: rotate and store in the battery compartment to use a Shure SB900 battery
- Bodypack: remove to accommodate a Shure SB900 battery

⑨ Bodypack Antenna

For RF signal transmission.

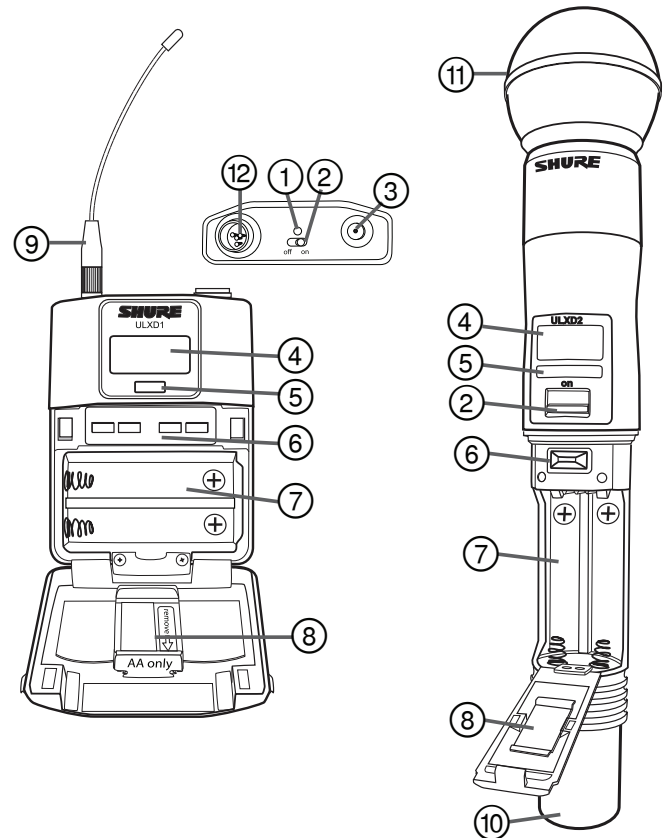

⑩ Integrated Antenna

For RF signal transmission.

⑪ Microphone Cartridge

See Optional Accessories for a list of compatible cartridges.

⑫ TA4M Input Jack

Connects to a 4-Pin Mini Connector (TA4F) microphone or instrument cable.

Locking Controls and Settings

Use the **LOCK** feature to prevent accidental or unauthorized changes to the hardware.

Receiver

Menu path: **DEVICEUTILITIES > LOCK**

Use the control wheel to select and lock any of the following receiver functions.

- **MENU:** All menu paths are inaccessible
- **GAIN:** Gain adjustment is locked
- **POWER:** Power switch is disabled
- **SCN/SYC:** Cannot perform a Scan and Sync

Tip: To unlock, press the **EXIT** button, turn the control wheel to select **UNLOCKED**, and then press **ENTER** to save.

Transmitter

Menu path: **UTILITY > LOCK**

Use the transmitter controls to select and lock any of the following transmitter functions.

- **MENU LOCK:** All menu paths are inaccessible.
- **POWER LOCK:** Power switch is disabled

Quick-Lock Option: To turn on the transmitter with its power and menu navigation buttons locked, press and hold the **▲** button during power-on until the **locked** message is displayed.

Tip: To unlock the **MENU LOCK**, press the **ENTER** button 4 times to pass through the following screens: **UTILITY > LOCK > MENUUNLOCK**

To unlock the **POWER LOCK**, set the power switch to the **off** position, then press and hold the **▲** button while resetting the power switch to the **on** position.

Menu Screens

Receiver Channel

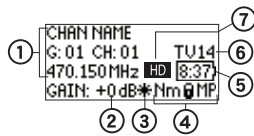

① Receiver Information

Use **DEVICE UTILITIES > HOME INFO** to change the home screen display.

② Gain Setting

-18 to +42 dB, or Mute.

③ Mic. Offset Indicator

Indicates offset gain is added to the transmitter.

④ Transmitter Settings

The following information cycles when a transmitter is tuned to the receiver's frequency:

- Transmitter Type
- Input Pad (Bodypack only)
- RF Power Level
- Transmitter Lock Status
- Transmitter Mute Status

⑤ Battery Runtime Indicator

Shure SB900 battery: runtime is displayed in minutes remaining.

AA batteries: runtime is displayed with a 5-bar indicator.

Transmitter

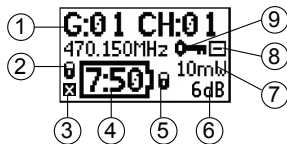

① Transmitter Information

Scroll **▲▼** at the home screen to change the display

② Power Lock Indicator

Indicates power switch is disabled

③ Transmitter Audio Muted Indicator

Displayed when the transmitter audio is set to off using the **MUTE MODE** feature.

⑥ TV Channel

Displays the TV channel that contains the tuned frequency.

⑦ High Density Mode Icon

Displayed when High Density mode is enabled.

Transmitter Status

The following text or icons report transmitter status to the receiver screen:

Display Icon	Transmitter Status
	Bodypack input is attenuated 12 dB
	Offset gain is added to the transmitter
Lo	1 mW RF power level
Nm	10 mW RF power level
Hi	20 mW RF power level
M	Menu is locked
P	Power is locked
TxMuted	Displayed when the transmitter audio is set to off using the MUTE MODE feature
-No Tx-	No RF connection between a receiver and transmitter or transmitter OFF

④ Battery Runtime Indicator

- Shure SB900 battery: runtime is displayed in hours:minutes remaining
- AA Batteries: runtime is displayed with a 5-bar indicator

⑤ Menu Lock Indicator

Indicates menu navigation buttons are disabled

⑥ Mic. Offset

Displays microphone offset gain value

⑦ RF Power

Displays RF power setting

⑧ Bodypack Input Pad

The input signal is attenuated 12 dB

⑨ Encryption Icon

Indicates encryption is enabled on the receiver and has been transferred to the transmitter from a sync

Audio Signal Encryption

When encryption is enabled, the receiver generates a unique encryption key which is shared with a the transmitter during an IR sync. Transmitters and receivers that share an encryption key form a protected audio path, preventing unauthorized access from other receivers.

Encrypting a Single Transmitter to a Single Receiver

1. From the receiver menu: **DEVICE UTILITIES > ENCRYPTION > ON (Auto)**
2. Press **ENTER**.
3. Perform an IR Sync to share the encryption key with the selected transmitter.

Encrypting Multiple Transmitters to a Single Receiver

Multiple transmitters can share the same encryption key, allowing them access to a single receiver. Use this method if you have multiple instruments or wish to use a combination of handheld and bodypack transmitters.

1. From the receiver menu: **DEVICE UTILITIES > ENCRYPTION > ON (Manual) > KEEP KEYS**.
2. Press **ENTER**.
3. Perform an IR Sync to share the encryption key with the first transmitter.
4. Turn off the transmitter and perform an IR Sync to share the key additional transmitters.

Caution! Make sure only one transmitter is turned on during an IR sync or a performance to avoid causing cross interference between transmitters.

Regenerating Encryption Keys

Periodically regenerating the encryption key maintains security for transmitters and receivers that are paired for extended periods.

1. From the receiver menu: **DEVICE UTILITIES > ENCRYPTION > ON (Manual) > REGENERATE KEYS**.
2. Press **ENTER**.
3. Perform an IR Sync to share the encryption key with the first transmitter.
4. Turn off the transmitter and perform an IR Sync to share the key additional transmitters.

Caution! Make sure only one transmitter is turned on during an IR sync or a performance to avoid causing cross interference between transmitters.

Removing Encryption

1. From the receiver menu: **DEVICE UTILITIES ENCRYPTION OFF**
2. Press **ENTER**.
3. IR Sync the transmitter and receiver to clear the encryption key.

Note: If multiple transmitters are encrypted to a single receiver, each transmitter must be IR synced to clear the encryption key.

ULXD Specifications

Working Range

100 m (330 ft)

Note: Actual range depends on RF signal absorption, reflection and interference.

Audio Frequency Response

ULXD1	20 – 20 kHz (±1 dB)
ULXD2	Note: Dependent on microphone type

Audio Dynamic Range

System Gain @ +10

>120 dB, A-weighted, typical

System Audio Polarity

Positive pressure on microphone diaphragm produces positive voltage on pin 2 (with respect to pin 3 of XLR output) and the tip of the 6.35 mm (1/4-inch) output.

Operating Temperature Range

-18°C (0°F) to 50°C (122°F)

Note: Battery characteristics may limit this range.

Housing

ULXD4D/ULXD4Q	ULXD1	ULXD2
Steel; Extruded aluminum	Cast aluminum	Machined aluminum

ULXD4 Power Requirements

ULXD4D	100 to 240 V AC, 50-60 Hz, 0.26 A max.
ULXD4Q	100 to 240 V AC, 50-60 Hz, 0.32 A max.

Battery Type

Shure SB900 Rechargeable Li-Ion or LR6 AA batteries 1.5 V

Battery Life

	SB900		alkaline	
	1/10 mW	20 mW	1/10 mW	20 mW
470 to 940	11 hours	7 hours	11 hours	5:30 hours
174 to 216	9:50 hours	7 hours	9 hours	5:45 hours
1240 to 1260	8:40 hours	6:45 hours	7:30 hours	5:30 hours

The values in this table are typical of fresh, high quality batteries. Battery runtime varies depending on the manufacturer and age of the battery.

ULXD1, ULXD2, ULXD4D, ULXD4Q

This product meets the Essential Requirements of all relevant European directives and is eligible for CE marking.

ULXD1, ULXD2

Certified under FCC Part 74.

Certified by IC in Canada under RSS-102 and RSS-210.

IC: 616A-ULXD1 G50, 616A-ULXD1 H50, 616A-ULXD1 J50, 616A-ULXD1 L50; 616A-ULXD2 G50, 616A-ULXD2 H50, 616A-ULXD2 J50, 616A-ULXD2 L50.

FCC: DD4ULXD1G50, DD4ULXD1H50, DD4ULXD1J50, DD4ULXD1L50; DD4ULXD2G50, DD4ULXD2H50, DD4ULXD2J50, DD4ULXD2L50.

IC: 616A-ULXD1X52, 616A-ULXD2X52

FCC: DD4ULXD1X52, DD4ULXD2X52

IC: 616A-ULXD1V50, 616A-ULXD2V50

FCC: DD4ULXD1V50, DD4ULXD2V50

ULXD4D, ULXD4Q

Approved under the Declaration of Conformity (DoC) provision of FCC Part 15.

Conforms to electrical safety requirements based on IEC 60065.

Frequency Range and Transmitter Output Power

Band	Frequency Range (MHz)	Power (mW RMS) (Lo/Nm/Hi)
G50	470 to 534	1/10/20
G51	470 to 534	1/10/20
G52	479 to 534	1/10
H50	534 to 598	1/10/20
H51	534 to 598	1/10/20
H52	534 to 565	1/10
J50	572 to 636	1/10/20
J51	572 to 636	1/10/20
K51	606 to 670	1/10
L50	632 to 696	1/10/20
L51	632 to 696	1/10/20
L53	632 to 714	1/10/20
P51	710 to 782	1/10/20
R51	800 to 810	1/10/20
JB (Tx only)	806 to 810	1/10
AB (Rx and Tx)	770 to 810	'A' Band (770-805): 1/10/20
		'B' Band (806-809): 1/10
Q51	794 to 806	1/10/20
V50	174 to 216	1/10/20
V51	174 to 216	1/10/20
X50	925 to 932	1/10
X51	925 to 937.5	10
X52	902 to 928	0.25/10/20
X53	902 to 907.500, 915 to 928	0.25/10/20
X54	915 to 928	0.25/10/20
Z16	1240 to 1260	1/10/20

Note: Frequency bands might not be available for sale or authorized for use in all countries or regions.

The CE Declaration of Conformity can be obtained from: www.shure.com/europe/compliance

Authorized European representative:
 Shure Europe GmbH
 Headquarters Europe, Middle East & Africa
 Department: EMEA Approval
 Jakob-Dieffenbacher-Str. 12
 75031 Eppingen, Germany
 Phone: 49-7262-92 49 0
 Fax: 49-7262-92 49 11 4
 Email: info@shure.de

Australia Warning for Wireless

This device operates under an ACMA class licence and must comply with all the conditions of that licence including operating frequencies. Before 31 December 2014, this device will comply if it is operated in the 520-820 MHz frequency band. **WARNING:** After 31 December 2014, in order to comply, this device must not be operated in the 694-820 MHz band.