

S

The cordless digital
DECT telephone system
expandable to 6 handsets

Gigaset 2011
Comfort



Operating instructions

! Please read the safety precautions outlined in these operating instructions before putting the equipment into service

ACHTUNG! Schnittkante ggf. auf Titelseite U1 nach außen versetzen wg. Falz-Ausklappseite



Gigaset® 2011

Your guide to this manual

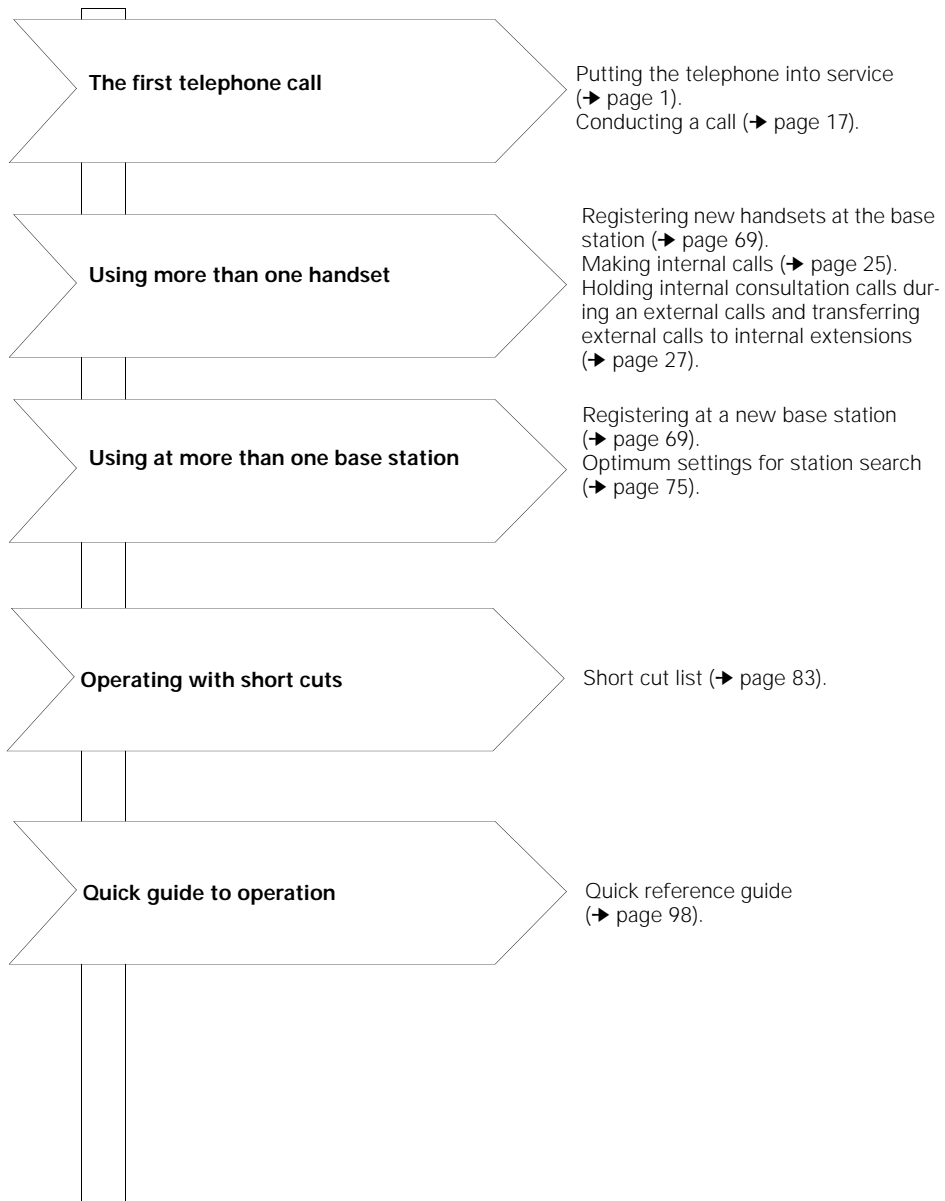

Overview: Gigaset 2011

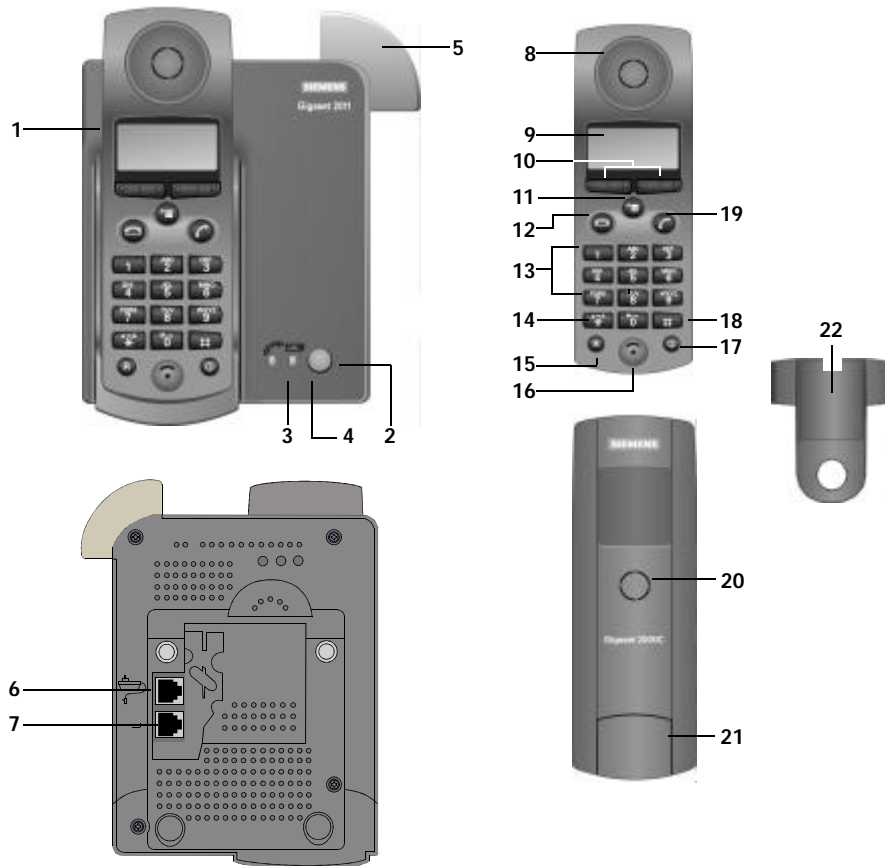

- | | |
|---|---|
| <ul style="list-style-type: none"> 1 Handset rest/charging unit 2 Paging key (calling registered handsets) 3 Trunk LED (lights up when dial-up line is seized) 4 Battery LED (lights up when charging batteries) 5 Antenna 6 Jack for power cord 7 Jack for telephone cord | <ul style="list-style-type: none"> 8 Earphone 9 Display 10 Display keys 11 Menu key 12 On-hook key 13 Dialling keypad 14 Star key 15 Recall key (flash) 16 Microphone 17 On/off/protected key 18 Pound key 19 Talk key 20 Ringer loudspeaker 21 Battery compartment (cover for removal) 22 Carrying clip |
|---|---|

Overview: keys

Base station keys









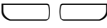

Green paging key for calling all registered handsets and for registering handsets.

Display keys assignments













	Activates additional menu
	Selects call number from the directory
	Sets up internal connection
	Redials one of the five last numbers dialed
or	Selects menu item or entry
or	Adjusts (larger or smaller)
	Confirms
	Exits a menu level, cancels an action
	Scrolls back to the previous menu level
	Deletes characters
	Saves setting and exits
	Starts internal collective call
	Accepts queued external call
	Deactivates ringer for incoming call
	Deactivates feature
	Activates feature
	Redials the last call number
	Inserts pause
	Dialog key for using Select Services

Overview: keys

-  Menu-dependent keys (display keys)
-  Menu key
-  **1** - **0**, ***** and **#**
-  Dialling keys for call numbers and input keys for procedures and entering characters ("." = blank, "." = full stop, "-" = hyphen, "a → A" = change from lower-case to upper-case) in the telephone directory
-  Recall key (flash) for transmitting a signal to the public telephone network or to telephone systems
-  Key for activating/deactivating the handset or for switching on the protect feature
-  Talk key for setting up external connections
-  On-hook key for clearing down connections, switching to the basic menu or, if necessary, cancelling a function (panic function)

Overview: display symbols

Operating actions and statuses are graphically displayed on the Gigaset 2000C handset.

Symbol	Explanation
	Incoming call
	Set the ringer volume
	Ringer is deactivated
	Set the ringer tone
	Set the ringer melody
	Set the handset volume
	The signal tone is activated/deactivated
	Range warning symbol
	Battery charging status
	Input cursor
	Automatic backlight on/off
	Handset lock on/off

Safety precautions



! Only use approved nickel-cadmium (NiCd) batteries or nickelmetalhydride batteries (NiMH)! (→ page 86).

Never use other batteries or ordinary (non-rechargeable) batteries. These can short circuit or destroy the battery unit (dangerous). The following labels are found on the battery compartments of the handset and charging unit:

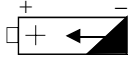

Only use rechargeable batteries with the poles aligned as shown.

Type as indicated in these installation instructions.

- Avoid contact with water and fire.
- Do not dispose of old, defective batteries with ordinary household refuse.
- During charging, batteries heat up. This is normal and is not dangerous.
- Do not use non-Siemens charging units. This could damage the batteries.
- Only use the plug-in power unit supplied (number C39280-Z4-C67).
- If possible, do not cross the base station plugs. Otherwise the voltage applied to the charging contacts may surge during storms, for example.
- Do not operate the handset in environments where there is danger of explosion.

! Research has shown that in certain cases, medical equipment can be affected by activated cordless telephones (DECT). A distance of at least one metre should therefore be maintained between the telephone and the medical equipment. When using cordless telephones in the vicinity of medical equipment, the regulations of the relevant institution must be observed.

Approval and conformity

Your Gigaset 2010 has been certified by the "British Approvals Board for Telecommunications", the British office for telecommunications certification. It has been approved according to EU guideline 91/263/EEG (CTR6, CTR10) for telecommunications terminals. Anyone is permitted to connect this telephone to a telephone socket and use it at the Public Telecommunications Network in the UK. This telephone fulfils the requirements of the following EU guidelines:



CE Compliant to

89/336/EEC (EMC Directive) and
73/23/EEC (Low Voltage Directive)

The CE marking confirms that the telephone is in compliance with the above-mentioned guidelines (CE 0188 X).

Contents

Overview: keys	V
Overview: display symbols	VI
Step by step guide to putting into service	1
Step 1: Observe the safety precautions	1
Step 2: Check the contents of the package	1
Step 3: Connect the base station	2
Step 4: Insert the batteries into the handset	3
Step 5: Charge the batteries	3
Step 6: Check the signalling method	4
Menu-driven operation	5
On-line menu	8
Principal menus	9
Operating modes	11
On/off/protected mode	11
Signalling method	13
Incoming calls	14
Call number display	14
Accepting calls	15
External call-waiting during internal calls	16
Ending a call	16
Deactivating the microphone (mute function)	16
External outgoing calls	17
Calling external parties	17
Suppressing secret numbers for redial	18
Suppressing call number display at the called party	18
No answer or line busy	18
Redial	19
Dialling with the directory	19
Dialling from the call list	20
Controlling devices with dual-tone multifrequency signalling (DTMF)	23
Ending a call	24
Collective ringing and internal calls	25
Making collective calls to all handsets from the base station	25
Making collective calls from one handset to all handsets	25
Making internal calls	25
Ending an internal call	26
Internal consultation calls and transferring calls	27
Consultation calls	27
Transferring calls	28
Allowing internal parties to listen in on a call	29
Creating and managing the directory	30
Entering/copying/editing/deleting call numbers/names	31
Copying numbers	32
Deleting the directory	33
Available memory	34
Copying an entry/directory	34
Administering the redial memory	35

Contents

Input function	37
Entering names and numbers	37
Entering letters, special characters, and digits	41
Important basic settings	43
Changing the base code/PIN	43
Resetting the base station to the factory defaults	45
Resetting the Gigaset 2000C handset to the factory defaults	46
Operating in a telephone system	47
Individual base station settings	50
Switching the base station ringer off and setting the ringer volume	50
Activating/deactivating music on hold	51
Setting the base station ringer tone	51
Individual handset settings	52
Setting the handset volume	52
Ringer settings	53
Activating/deactivating automatic backlight	54
Automatic call acceptance	54
ISDN configuration	54
Activating/deactivating notification and warning tones	55
Baby alarm	57
Baby alarm level	58
Selecting a language	58
Select services	59
Displaying call duration	60
Activating/deactivating call duration display	60
Gigaset 2011 lock functions	61
Activating/deactivating the lock for outgoing calls	61
Emergency calls when the system is locked	61
Barred numbers for handsets	63
Activating/deactivating the call number lock	65
Setting trunk access for the handset	66
Lock functions on the handset	67
Activating/deactivating the handset lock	67
Handset display with active lock	68
Registering/de-registering more than one handset at the base station	69
Registering a Gigaset 2000C handset at a base station	69
De-registering a handset from a base station	70
Operating more than one handset	71
Call allocation for incoming calls	71
Naming handsets	73
Operating at more than one base station	74
Selecting the best station	75
Setting the preferred or fixed station	75
Base station names	76
De-registering a base station	76

Contents

Short cuts	77
Descriptions with example	77
Short cut menu	77
New entry	78
Editing an entry	80
Deleting an entry	80
Displaying an entry	81
Deleting all entries	81
Available memory	81
Copying an entry/memory	82
Starting a short cut	83
Default short cuts	83
Short cut list	84
Important notes on putting into service and operation	85
Installing the base station	85
Notes on operating the handset	86
Operating with the Gigaset 2000S (1000S) handset	89
Maintenance	89
Connecting the telephone socket	90
Technical data	91
Third party use/disposal	92
Warranty	92
Procedure in the case of malfunctions	93
Contact person	94
Overview: signal tones	95
Special accessories	96
Quick reference guide handset Gigaset 2000C	98
Index	99

Step by step guide to putting into service

Step by step guide to putting into service

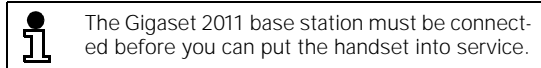

Please follow the step-by-step instructions for putting the handset into service.

Step 1: Observe the safety precautions

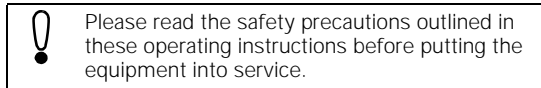

Step 2: Check the contents of the package

The default package contains:

- a Gigaset 2011 base station (see label with CE symbol on the underside of the base station),
- enhanced Gigaset 2000C handset (see imprint on the rear of the handset),
- a telephone cord with Mini-Western plug,
- a power cord with Mini-Western plug and BT plug C39280-Z4-C67,
- a cover for the handset's battery compartment,
- a carrying clip for the handset,
- two batteries,
- operating instructions.

Step by step guide to putting into service

Step 3: Connect the base station

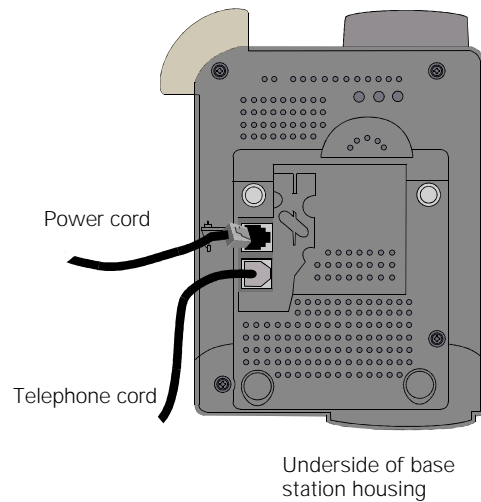

Telephone cord

Insert the Mini-Western plug on your telephone cord into the base station. The jack on the underside of the base station is identified by the following symbol:



Insert the plug on your telephone cord into the telephone socket.

Power cord

Insert the Mini-Western plug on your power cord into the base station. The jack on the underside of the base station is identified by the following symbol:



Insert the power cord on your power supply unit into a mains socket (220/230 V).

Step by step guide to putting into service

Step 4: Insert the batteries into the handset

The handset is powered by two batteries.

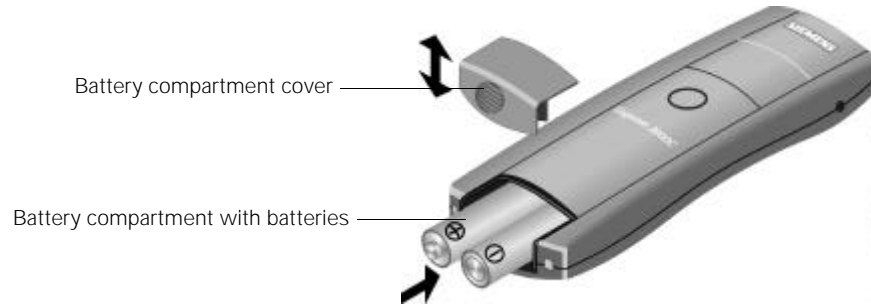

Hold the handset with the keypad facing downwards.

Insert the batteries into the battery compartment.



Make sure that the +/- battery poles are aligned correctly. The +/- marks on the label in the battery compartment must be aligned with the +/- marks on the batteries.

The handset will not work and may even be damaged if the batteries are incorrectly inserted.

Slide the cover of the battery compartment downwards into the grooves on the handset and close the compartment. For more information on charging/operating times and battery use, see → page 86.

Step 5: Charge the batteries

To charge the batteries place the handset in the rest on the base station. The charging contacts on the base of the handset must touch the contacts in the base station. It does not matter whether the keypad is facing up or down.

If you have correctly inserted the handset, the LED below the battery symbol on the base station will light up.



You must charge the batteries before you can make any telephone calls or define settings. We recommend that the batteries be charged for 16 hours without interruption, e.g. overnight, for the initial start-up.

For more information on the use of batteries (→ page 86).

Step by step guide to putting into service

Step 6: Check the signalling method

Telecom telephone lines can operate with the following signalling methods:

- Dial pulsing (DP)
- Dual-tone multifrequency signalling (DTMF)

Your Gigaset 2011 is set to DTMF signalling by default.

Checking your own telephone's signalling method



Press the Talk key. You will hear the dial tone (on-hook signal).



Press any digit, e.g. 2. If you can still hear the **dial tone** (on-hook signal), you must set the signalling method to **dial pulsing (DP)**.

Setting dial pulsing



Press the menu key on the keypad.
Press the left display key until Service is displayed.
Press the right display key for OK to confirm your selection.



1

Initiate the procedure.



Enter the four-digit base code; (factory default: "0000")
(→ page 43).



Set dial pulsing (DP).



The settings "**DTMF/Flash**" or "DP" are only needed to operate your Gigaset 2011 at the **main station telephone**.
The other signalling method settings are intended for operating Gigaset 2011 in **telephone systems** (→ page 47).

Gigaset 2011 is ready for operation.

Menu-driven operation



Menu-driven operation



Press the  key to activate the local menu of the enhanced Gigaset 2000C handset (off-line).



The first menu level appears when the menu has been activated with . Three lines of available menu items are shown in the display. The first menu item is highlighted. This menu item is selected.



Use  to scroll down to the next menu item. The broken line indicates the end of the menu. If this line is selected, you can return to the start of the menu by pressing .

Press  to confirm the selected menu item. Press  to jump back from a sub-menu to the original menu item selected. Press  to quit the menu from the top level. The off-line display appears.

For an overview of the main menu and sub-menus, [→ page 9.](#)

Menu structure

The menu structure is hierarchical.







If you select **Settings** in the main menu, for example, you will access a sub-menu with settings options.



Menu-driven operation

Moving to higher menu levels and exiting a menu

When you are in the top menu level, you can exit the menu by pressing . If you are at a lower menu level, you can move up one level by pressing  without saving any settings made. When you reach the end of a menu (indicated by a broken line) the  and  keys merge and become the  key. Press this key to exit the menu level. When you return to the higher menu, the activating menu is displayed in reverse video in the first place on the display.



Use the on-hook key  to exit all functions without saving changes and return to the off-line display (panic function).













Activating the additional menu

An additional menu is available in some menus (e.g. redial menu). This can be activated by pressing .

Menu-driven operation

Displays in the operating instructions

The selection of a function in one of the menus or sub-menus is depicted using symbols. The following inputs, for example, must be made to deactivate the confirmation beep:

-  Press the menu key.
-   Scroll to **Settings** and confirm.
-   Scroll to **Handset Settings** and confirm.
-   Scroll to **Beeps** and confirm.
-   Scroll to **Confirm Beep** and confirm.
-  Exit menu without saving changes.
-   Press **OFF / ON** to deactivate/activate the key confirmation beep.

Abbreviated presentation

When describing procedures in these operating instructions, the route to the "target menu item" is abbreviated.

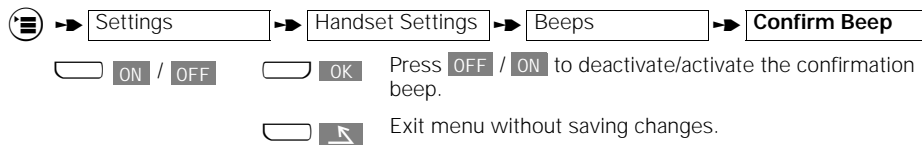

Abbreviated presentation when activating the menu with a display key

If you want to activate New Entry, for example, in the directory menu using the **≡+** display key, the presentation is as follows:



Menu-driven operation

On-line menu

Once you have seized a line (☎ key), an on-line menu is displayed when you press (☰). You can select the following menu items:

Menu
Select Services
Directory
Internal Call
Short Cut
Switch to Tone
Handset Volume
Service

Display keys assignment is controlled by the base station in on-line mode. Dual key assignment is deactivated during a call.

Example of menu operation during a telephone call

You can set the handset volume to one of three levels via the on-line menu during a call:

Level 1 ... level 3 = handset volume low ... high

Factory default: level 1 (normal/low).

(➡ means: scroll with ◀ ▼, confirm with ◀ OK)

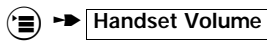

The following is displayed:



(Example: handset volume is set at level 2)

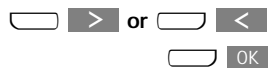

Set the handset volume and confirm.

or



Exit the menu without saving changes.

Menu-driven operation

Principal menus

If an arrow in the diagram points directly to a menu or a function with a name, you can select this item by

- pressing **OK** or
- automatically by entering a character

Menus or functions that contains the character **☰+** in the header can be reached by pressing **☰+**.

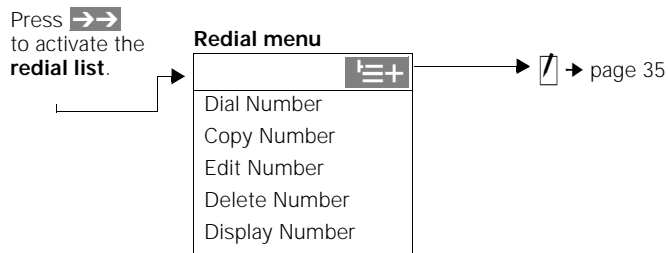
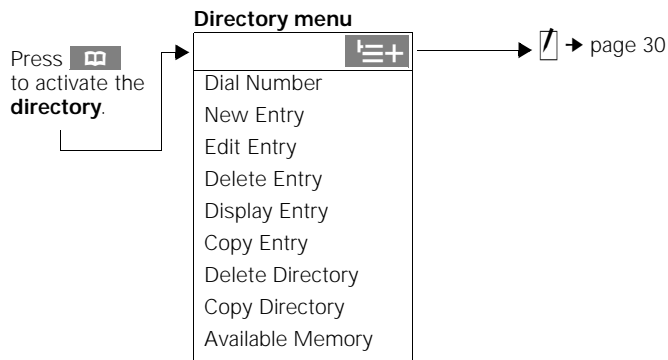
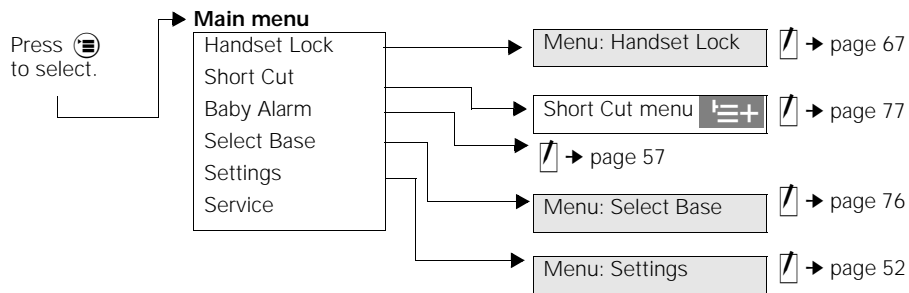

Menu-driven operation

Settings

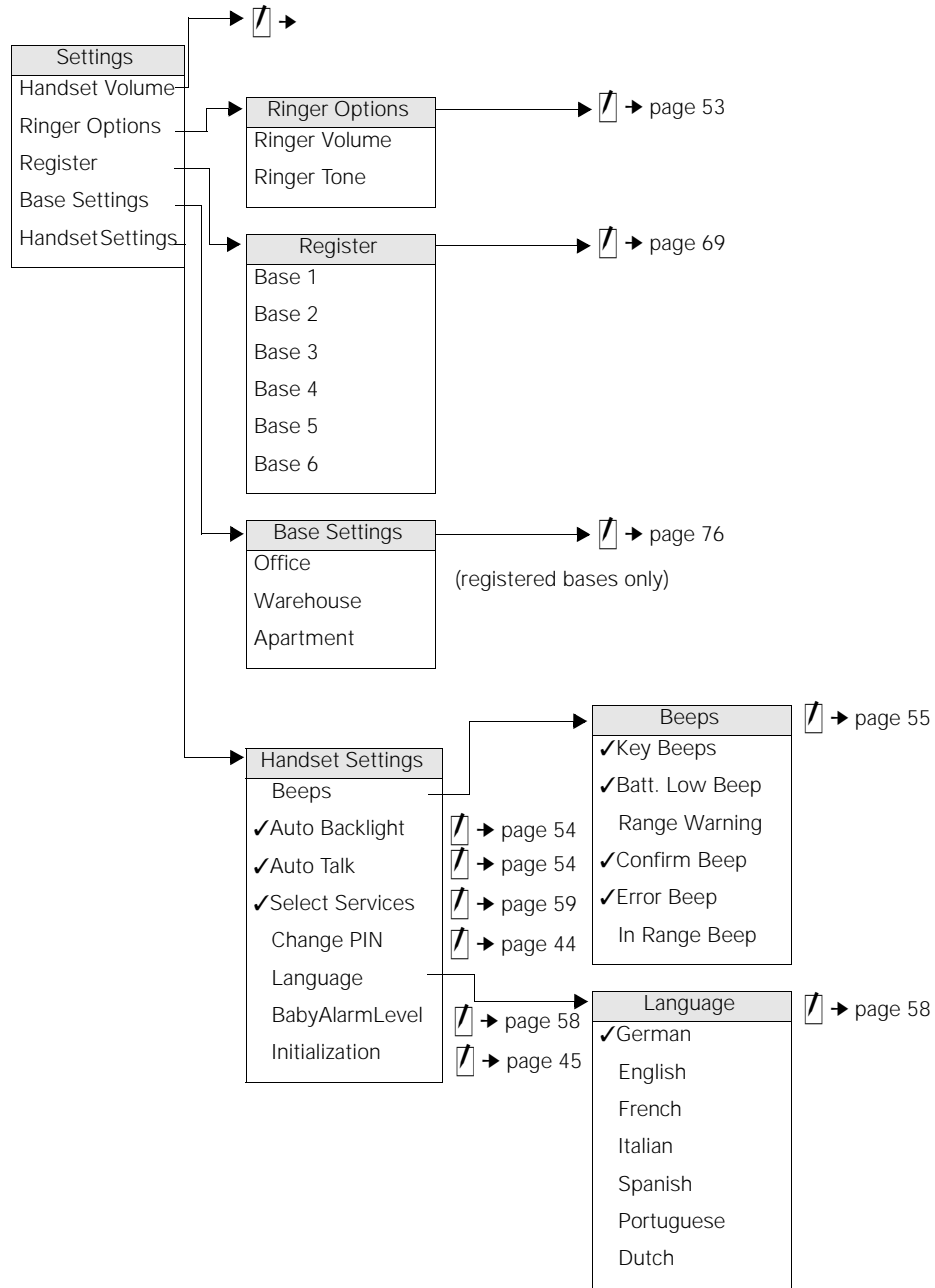

Operating modes

Operating modes

On/off/protected mode

You can switch your handset

- to protected mode,
- off,
- and on (again).

When the handset is in protected mode, it is protected against inadvertent use. The handset switches on automatically to receive incoming calls. If you want to make an outgoing call, you will have to switch the handset on first.

When the handset is switched off, incoming calls are **not** signalled. If you want to make an outgoing call, you will have to switch the handset on first.



Protected mode is useful, for example, if you carry your handset in your pocket.

To preserve the batteries, we recommend that you switch off the handset if you move outside the base station radio range.

If your handset was switched on and outside the radio range for an extended period of time, you can speed up the process of "finding" the base station again by switching it off for a moment and then on again.

Switching the handset to protected mode

- ① Press the handset button **briefly**. You will hear a positive confirmation beep. If the handset is in protected mode, the following message appears on the display:

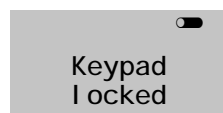

Operating modes

Switching on the handset

When the handset is in protected mode:

- ① Press the handset button **briefly**. You will hear the positive confirmation beep. The following message appears on the display when the handset is switched on:



When the handset is switched off:

- ① Press the handset button briefly. You will hear the positive confirmation beep. The symbol ☺ flashes on the display. Wait until the symbol stops flashing. The handset is activated.

or

Replace the handset in the base station charging unit. The symbol ☺ is displayed. The handset is activated.

Switching off the handset

- ① Press the handset button **until** the display goes out completely. You will hear the positive confirmation beep.

Operating modes

Signalling method

Telecom telephone lines can operate with the following signalling methods:

- Dial pulsing (DP)
- Dual-tone multifrequency signalling (DTMF)

Your Gigaset 2011 is set to DTMF signalling by default.

 If your telephone line is connected to a digital switch, you can use both dial pulsing and DTMF signalling. In this case, leave the default DTMF setting or reset it, for example, after relocating your handset.

Checking the signalling method of your telephone line



Press the Talk key. You will hear the dial tone.



Press any digit, e.g. 2. If you still hear the same dial tone, you must switch the signalling method to dial pulsing (DP).

Setting the signalling method

(➔ means: scroll with , confirm with  OK)

 ➔ Service

Initiate the procedure.

 1

Initiate the base function.



Enter the four-digit base code (factory default: "0000") (➔ page 43).

 REDIAL  0  3  3  SET

Set to dial pulsing.

or

 REDIAL  0  3  7  SET

Set to DTMF.

Incoming calls

Incoming calls

Call number display

An incoming call is indicated by the ringer (bell symbol) and appears on the display. If the network carrier supports call number display (CLIP), the external caller's number is shown on your handset display. The following messages can be displayed

- **The call number is displayed**



- **A name is displayed**

If the external caller's number is entered in the handset's directory, the name associated with the number is displayed. In this case, the number stored must be identical to the call number (national and international prefix included).



- **Special case**

If the external caller suppresses his/her call number (CLIR), the following entry is displayed:

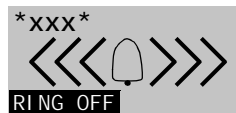

- **Call number display is not supported**

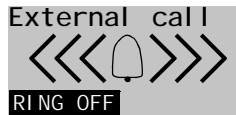

Incoming calls

- **Internal call**

The following example shows a call from mobile unit 2.

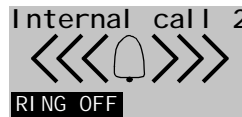

Accepting calls

Calls can be accepted as long as the call symbol is displayed.



You can switch off the ring tone.

When the handset is in the base station or charging unit:

Remove the handset from the charging unit. You are connected.



Automatic call acceptance by removing the handset from the charging unit is an adjustable setting (→ page 54). If you have switched this function off, you must press the  button when you remove the handset from the charging unit.

When the handset is not in the base station or charging unit:





Press the Talk key on the handset. You are connected

Incoming calls

External call-waiting during internal calls

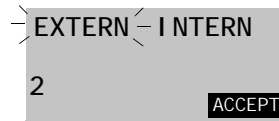
The call waiting beep signals an external call while an internal call is in progress. Your internal connection is cleared down if you accept the external call. The external call is signalled on the display:



 **ACCEPT** You accept the external call immediately.

or



Disconnect the internal call. You will hear the ring tone.



Accept the external call.

Ending a call

Replace the handset in the base station or charging unit. The line is disconnected.

or



Clear down the connection.



If the handset was in protected mode, it remains in this mode after you press .

Deactivating the microphone (mute function)

You can deactivate the microphone while an external call is in progress. This allows you to consult other people in the room while the external party is on hold. The external party cannot hear what you are saying and will hear music.



Set up a connection.

The microphone is deactivated. Hold consultation with people in the room.





Activate the microphone. You are reconnected with the external party.

External outgoing calls

External outgoing calls

Calling external parties

 Press the Talk key. You will hear the on-hook signal.

 Enter the required call number using the dialling keypad. The number you have entered is shown on the display, e.g.:

EXTERN
0043123456
INT ✉ PAUSE

You will hear the ring tone.

Suffix dialling

If you have dialled the call number of a switch, for example, you can now suffix-dial an extension manually. You can also suffix dial a call number from the directory or the call list.

Dialling with call number checking (en-bloc dialling)

En-bloc dialling allows you to check and correct the external call number (max. 32 digits) entered before it is dialled. The **input function** is activated with call number checking (→ page 37).

 Enter the required call number. The number you have entered is shown on the display, e.g.:



0043P123456 
< > ↩ ⌂

You can correct the number entered with the input function,

 Press the Talk key within 30 seconds to seize the line. The call number is dialled. You will then hear the ring tone.

or

(→ means: scroll with , confirm with  OK)

  → Dial

The call number is dialled. You can leave the additional menu without dialling by pressing .

External outgoing calls

Manually inserting a pause

If you repeatedly get the busy signal after entering the country code, for example, when dialling en-bloc, insert a pause (3 seconds) between the country code and the call number:

(→ means: scroll with , confirm with )

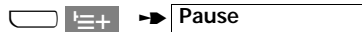

The pause "P" appears **on the display**.

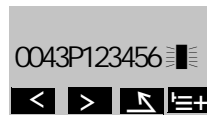

Suppressing secret numbers for redial

Call numbers dialled are stored in a redial list. Suffix-dialled numbers, e.g. extensions, and any secret "service numbers" that may follow are also entered in the redial list along with the call numbers. To avoid transferring secret numbers, activate "TempSwitchToTone", for example, after entering the extension (→ page 23). Your telephone is then set to DTMF signalling.

Suppressing call number display at the called party

To suppress call number display at the called party's telephone, use a T-Net services sequence. Your telephone must be set to DTMF signalling.

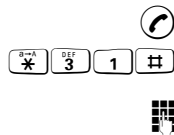

Press the Talk key.

Enter the T-Net service sequence for call number suppression, wait until you hear the dial tone and then

enter the call number.

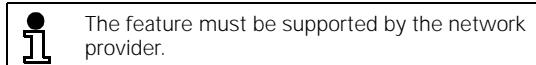

No answer or line busy

Replace the handset in the base station or charging unit. The connection is cleared down.



Clear down the connection.

External outgoing calls

Redial

Repeating the last number dialled

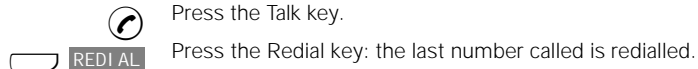

Repeating one of the last five call numbers

You can call up a list of numbers for redial by pressing . You will be presented with a list of the last five different numbers you called, including numbers which were dialled from the directory.

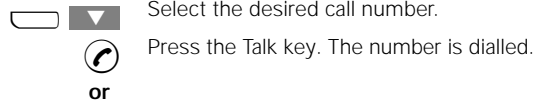

or

(means: scroll with , confirm with)

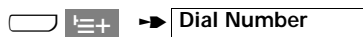

or

Quit the additional menu and the redial list by pressing .

For information on further options for editing the redial list, see the chapter on administering redial on [page 19](#).

Dialling with the directory

You can store up to 100 call numbers with corresponding names in your handset directory ([page 30](#)). You can search for names and dial numbers directly from the directory.

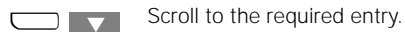
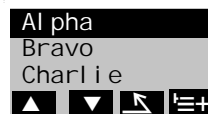

or

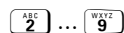

Enter a letter
e.g. "B" – press digit key "2" twice.
The directory jumps to the first entry starting with the letter "B". If there is no such entry in the directory, the directory will stay on the current entry and you will hear the error beep.

External outgoing calls



Press the Talk key within 30 seconds. The call number is dialled. You will hear the ring tone.

or

(➔ means: scroll with , confirm with **OK**)

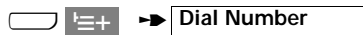

The number is dialled. You can quit the additional menu without dialling by pressing .

Dialling from the call list

If a call attempt is unsuccessful, e.g. if the party called is absent, the calling party's number is stored in a call list, provided this feature is supported by the network operator. This feature enables you to call back the party that was unable to reach you. You can select the call numbers from the list and set up the connection.

The call list has the following properties:

- it can contain up to 10 call numbers which are saved in chronological order. The 11th call number is positioned at the top of the list, thus deleting the last entry
- a counter tells you how many call attempts were made
- it replaces the call number with a name if the call number is entered in the handset's directory
- the left base station LED flashes when a new call number is entered and the icon appears on the display of the Gigaset 2000C handset
- it marks call numbers that were called back (either successfully or unsuccessfully)

You can activate the call list at any time. Entries that are no longer required can be deleted from the list. The flashing base station LED is deactivated and the icon disappears from the handset display as soon as all numbers in the list have been called back.

External outgoing calls

Activating the call list

The left LED on the base station blinks and the  icon appears on the handset display when "unanswered" calls are entered. To check the call list or initiate a callback, proceed as follows:



Press the display key to activate the call list.



If there are no more "unanswered" calls in the list, seize the line first and then activate the call list with the display key.



Selecting and calling back a caller

When a caller is selected, the current date, time, number and/or name of the caller are indicated on the display provided that there is an entry for him in the phonebook of the handset. The asterisk indicates that you are dealing with a callback from your own mailbox.



Search for the party you want to call back from the list. In the example opposite, the call number is replaced by a name.

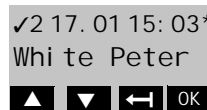

In this example, the "2" in the first line indicates that "Peter White" has already made two attempts to reach you. The symbol ✓ means that one callback attempt has already been made.



Dial the selected call number by pressing the display key.

or



Press the on-hook key if you only want to check the calls.





If the call list is empty, you will see the display shown opposite.



External outgoing calls

Deleting a callback party from the call list

-  Search for a callback party
-  Delete an entry from the list.





 A callback number is not incorporated in the re-dial list.

Call list in the Gigaset 2000S/1000C handset



Activating the call list

New calls are only signalled at the base station.

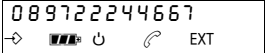
Gigaset 2000S





-  Press the Talk key.
-    Activate the call list.
- The call number of the last caller is displayed. 

Searching for and dialling a callback number

-  Search for a call number in the list.
-  Dial the call number.
- or
-  Press the on-hook key if you only want to check the calls.

Gigaset 1000C

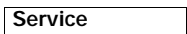
( means: scroll with , confirm with )
Select the Service menu item.

-   
-   Activate the call list.

Display change in the call list

An entry in the call list is composed of three pieces of information:

- call number of the calling party
- counter for calls to the same call number
- code for callback attempt "L" or "R"

These specifications are not displayed simultaneously but rather in two separate screens. Use the star key to switch from one screen to another.

External outgoing calls

Deleting a callback party from the call list

Display after activating the call list.

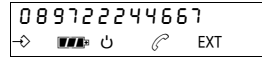

Change to the second display line of the entry. In this example, there were three calls to this number and one callback attempt.

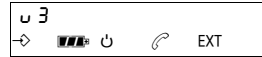

Search for a call number in the list.



Delete the entry.

Controlling devices with dual-tone multifrequency signalling (DTMF)

Your telephone must be set to dual-tone multifrequency signalling (DTMF) for certain connections, for example, if you want to check an answering machine or a voice in-box or avail of telecom services such as CityRuf or Scall (paging services available in Germany).

If your Gigaset 2011 is connected to a line with DTMF signalling, every connection is automatically set up using DTMF signalling mode. If this is the case, you do need the function to switch to DTMF signalling.

If the device is connected to a line with dial pulsing (DP), you can switch to DTMF signalling once the connection has been set up.

You can check which signalling method is set if you are unsure (→ page 13). DTMF signalling is set by default.

Prerequisite: an external connection exists.

(→ means: scroll with , confirm with **OK**)

Activate temporary DTMF via the menu.

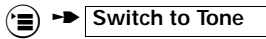

Once you have switched to DTMF, you can switch between the two signalling methods during the connection using the **R** recall key. When the line is disconnected, the telephone will automatically return to the original signalling method.

Any digits or symbols that you enter after switching signalling methods are not copied to the redial memory.

External outgoing calls

Ending a call

Replace the handset in the charging unit. The line is cleared down.

or



Clear down the connection.

Collective ringing and internal calls

Collective ringing and internal calls

Making collective calls to all handsets from the base station

It can be useful to make a collective call from the base station, for example, to locate mislaid handsets. It is not possible to make internal calls during a collective call from the base station.



It is also possible to make collective calls from the base station if you only have one handset.



Press the green paging key on the base station. All accessible handsets will be called for approximately 30 seconds.

End call prematurely



Press the green paging key on the base station.

or



Clear down the connection at the handset.

Making collective calls from one handset to all handsets

If your phone has several handsets, you can make a collective call from each handset to all of the other accessible handsets. The first internal party to accept the call is connected to you. You can also use this function to locate missing handsets.



Set up a connection .



Press the display key shown. You will hear the internal ring tone. All accessible handsets and ancillary devices are called .

Making internal calls

If your telephone has more than one handset (→ page 71), you can call the other handsets free of charge.



Initiate the connection.



Enter the number of the handset you wish to call (1 to 6). You will hear the internal ring tone. The handset you dialled is called.

Collective ringing and internal calls

Checking your own internal number

 **INT** Initiate the connection.

The internal call number of the handset is displayed.



I NTERN
2
SET COLL. CALL

Ending an internal call

Replace the handset in the base station or charging unit.
The line is disconnected.

or
 Clear down the connection.

Internal consultation calls and transferring calls

Internal consultation calls and transferring calls

During a external call it is possible to:

- hold a consultation call with an internal party,
- transfer the external call to the internal party.



Consultation calls and call transfer are only possible if

- more than one handset is in operation (→ page 71).

Consultation calls

When more than one handset is in operation

If more than one handset is in operation (→ page 71), you can conduct a consultation call with an internal party during a call with an external party. The external party cannot hear your conversation with the internal party and will hear music while on hold.



INT

Set up a connection.



Enter the number of the handset which you wish to call (1 to 6). You will hear the internal ring tone. The handset is being called. The external call is put on hold.

End consultation/resume external call



End the internal consultation call. You are now reconnected to the external party.

When a telephone system is in operation

You can conduct a consultation call with a party in your telephone system during an external call. Please check the operating instructions for the telephone system.



Set up a consultation call. You will hear the dial tone. The external call is put on hold.



Enter the desired extension number. The relevant party is called.

End consultation/resume external call



End the internal consultation call. You are now reconnected to the external party.

Internal consultation calls and transferring calls

Transferring calls

When more than one handset is in operation

If more than one handset is in operation it is possible to transfer an external call to an internal party (→ page 71).



Set up a connection.

Enter the number of the handset to which you want to transfer the call (1 to 6). You will hear the internal ring tone. The handset is called. The external call is put on hold.

either

Wait until the internal party answers and inform him/her about the external call you are about to transfer.



Transfer the external call.

or



Do not wait until the internal party answers. Transfer the external call directly.



Instead of pressing , you can also replace your handset in the charging unit.

If you have transferred the external call directly and the internal party does not accept the call within 30 seconds, an automatic recall is carried out.

If you have transferred the external call directly and the internal party is busy, an automatic recall is carried out immediately.

If you accept the recall, you will be reconnected to the external party. A recall is accepted in the same way as all other calls (→ page 14).

When a telephone system is in operation

If a telephone system is in operation, you can transfer an external call to an internal party. Please check the operating instructions for the telephone system.



Set up a consultation call. You will hear the dial tone. The external call is put on hold.



Enter the desired extension number. The party in question is called. Wait until the party answers and inform him/her about the external call you are about to transfer.



Transfer the external call.

Internal consultation calls and transferring calls

Allowing internal parties to listen in on a call

An internal party can be allowed to listen in on a call with an external party with his/her handset.

Prerequisite: an external connection has been set up.



An external connection has been set up.



Set up a connection .



Dial the internal party (1.. 6). The external call is put on hold. The internal party answers. Conduct the consultation call.



Press the key shown. The external call is resumed and the internal party can listen in.

Disconnect the internal party



Press the key shown. The internal party is disconnected and hears the busy tone.

or



The internal party hangs up.



Creating and managing the directory

Creating and managing the directory

You can store up to 100 entries in the electronic directory. The entries comprise:

- call numbers (maximum 32 digits), and
- names (maximum 16 characters).

When you activate the directory, the names are presented in alphabetical order. You can scroll through it at your ease and dial directly from it (→ page 19).

You can call up the directory and its entries by pressing . To manage the directory (e. g. change or delete entries) call up the directory menu in the directory by pressing .

The following menu items are available in the directory menu:

- Dial Number
- New Entry
- Edit Entry
- Delete Entry
- Display Entry
- Copy Entry
- Delete Directory
- Copy Directory
- Available Memory

The activation of the individual menu items is abbreviated as follows:

(→ means: scroll with , confirm with  **OK**)

    → e.g. New Entry

Creating and managing the directory

Entering/copying/editing/deleting call numbers/names

New Entry



To add a new entry to the directory, select New Entry in the directory menu.

(→ means: scroll with , confirm with  OK)



When you select New Entry, the **input function** is active. The name and number are entered as described in the chapter "Input function" → page 37.



The names are sorted in alphabetical order. Press  or  on the first letter of the name to move entries to the top of the directory list.

Additional menus are available for the **Name** and **Contents** fields. You can reach these menus by pressing .

Saving an entry or cancelling an operation

To save entries in the Name and Contents fields or to cancel the operation, activate the relevant functions (Save Entry or Cancel) in the additional menu.

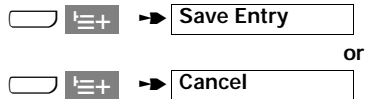

Inserting a pause

You can insert a pause, e.g. after the international code when entering call numbers in the Contents field.

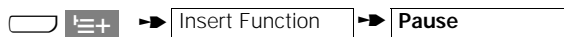

A "P" is inserted into the call number.

Creating and managing the directory

Displaying a special character

You can display the meaning of any special character in the call number, e.g. "P". Place the cursor on the character:

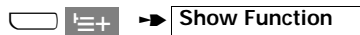

The explanation is shown on the display: Di gi t "P": Pause.

Checking an entry

To prevent an entry appearing in the directory more than once, it is possible to have new entries checked.

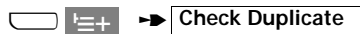

If there is an identical number in the directory, the name of the double entry is shown on the display.

Copying numbers

You can copy the last number dialled into the directory.



Call up redial by pressing the display key shown.



Select the desired number from the five available redial numbers.

Activate the Copy Number in the additional menu.

(➔ means: scroll with , confirm with )

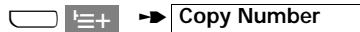

Continue as described under "Directory", "New Entry" ➔ page 31 and add a name to the selected number.

Edit Entry

It is possible to edit existing entries.



Call up the directory and



select the entry to be edited.

Call up the "Edit Entry" option in the additional menu.

(➔ means: scroll with , confirm with )

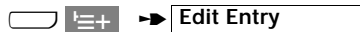

The input function is active. Correct the name or number as described in the input function rules ➔ page 37.

Creating and managing the directory

Processing and saving an entry

The options available under New Entry are also available in the additional menu.



Entries in the directory can be selected using the search function. Enter the first letter of the name. The first entry starting with this letter is displayed.



It is not possible to add new entries if the directory is full. You must first delete an existing entry.

Delete Entry

You can delete individual entries from the directory.



Activate the directory and select the entry to be deleted.

Activate the Delete Entry menu item in the additional menu.

(➔ means: scroll with , confirm with )

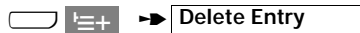

The entry is deleted when you press OK. A confirmation beep is sounded and the message "Entry has been deleted" appears on the display.

Deleting the directory

The Delete Directory menu item allows you to delete all of the directory data from the memory.

(➔ means: scroll with , confirm with )



Enter the PIN (➔ page 44) and confirm. The message "Delete all entries?" appears on the display.



If you confirm by pressing **YES**, all entries are deleted. The message "All entries deleted" is shown on the display. You can cancel the procedure by pressing **NO**.

Creating and managing the directory

Available memory

It is possible to show the percentage of memory available for your entries.

(➔ means: scroll with , confirm with  **OK**)



The message "Memory: 70% available", for example, is displayed for approximately two seconds.

Copying an entry/directory

Directory entries can be copied between enhanced Gigaset 2000T or 2000C telephones or enhanced handsets. This feature is supported by the Gigaset 2011 base station.

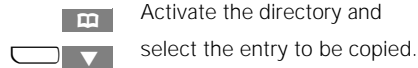

Activate the directory and select the entry to be copied.

Activate Copy Entry in the additional menu.

(➔ means: scroll with , confirm with  **OK**)

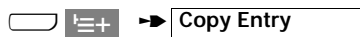

Enter the internal extension of the telephone or handset receiving the entries in response to the request "Copy entry to internal". **Start** the copy operation as follows:



The receiving telephone is called. When the call is answered, the called party is requested to enter the PIN. The copy operation begins if the PIN is correct.

The Copy Directory function is performed in the same way as the Copy Entry function:

(➔ means: scroll with , confirm with  **OK**)



The receiving telephone is called. When the call is answered, the called party is requested to enter the PIN. The copy operation begins if the PIN is correct.

Administering the redial memory

Administering the redial memory

Editing the redial number

You can call up a list of redial numbers by pressing **→→**.
Select one of the last five different numbers called by pressing **▼**.

You can edit a **selected call number** in the redial list:

(**→** means: scroll with **◀ ▼**, confirm with **◀ OK**)

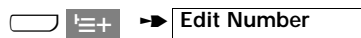

The input function is activated. For information and rules on the input function, see from **→** page 37.

Additional menu from the input function

Another additional menu can be activated from the input function: This menu contains the following menu items:

- Save Entry
 - The edited call number is saved in the same position in the redial list.
- Insert Function
 - You can insert a pause in the call number.
- Show Function
 - You can show the meaning of a special character selected with the cursor.
- Cancel
 - Exit the additional menu.

The menu items are selected with the button **▼** and activated by pressing **OK**.

Deleting a call number from the redial memory

You can delete a **selected call number** from the redial list:

(**→** means: scroll with **◀ ▼**, confirm with **◀ OK**)

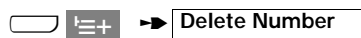

The call number is deleted.

Administering the redial memory

Copying a redial number to the directory

You can copy a **selected call number** to the directory.

(➔ means: scroll with ▼, confirm with OK)

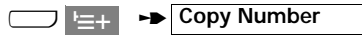

The input function is activated. Proceed as described under "New entry" in the chapter entitled "Creating and managing the directory" ➔ page 30.

Displaying the call number

Up to 16 digits of a call number can be displayed in the redial list. You can display a longer call numbers completely:

(➔ means: scroll with ▼, confirm with OK)

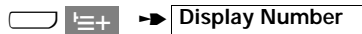

The selected call number is displayed in full.



Return to the redial list.

Input function

Input function

The input function is always active when names or call numbers are entered or edited, e.g.

- New Entry, Edit Entry (directory, short cut, base settings)
- Enter Number, Edit Number (redial)
- DSS Number
- BabyAlarm
- En-bloc Dialling, PIN

Entering names and numbers

The three display lines are divided as follows:

- Line 1 for name (16 characters)
- Lines 2 and 3 for contents (32 characters)

In the following diagrams, "□" marks a **blank space**.

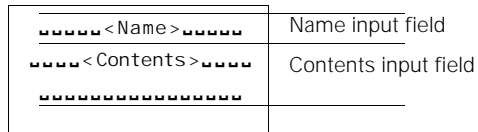

The number of fields available for input depend on the input type, i.e. both are available for the directory, for example, and only the second field for en-bloc dialling.

If data is entered or edited only in the Contents fields, the Name field remains empty or contains information such as the redial number.

Input function

Exception

The Name field is generally used for entering names. An exception to this occurs when editing base names in the Base Settings – edit names menu. In this instance, the name is edited in the Contents field.

Inserting, deleting, and moving characters

Inserting

Characters are always inserted to the **left** of the cursor.

Deleting

Characters to the **left** of the cursor are deleted by pressing the  display key.

Moving

The cursor is moved using the  and  display keys.

Moving from the Name field to the Content field

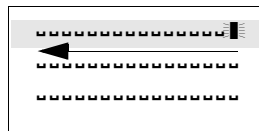

To move to the Name field, shift the cursor to the left of the first place in the Contents field.

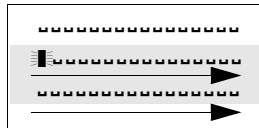

To move to the Contents field, shift the cursor to the right of the last place in the Name field.

Input function

Example: making a new directory entry

Select New Entry in the directory menu to obtain the following output on the display:

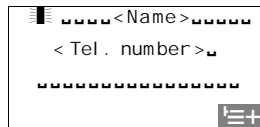

No characters have been entered yet.

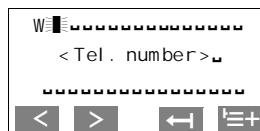

The first character (in this case an "W") has been entered.

For information on entering data see → page 41.

If you have entered the name in full and wish to **add the corresponding telephone number**, move the cursor to the second field (Contents) using the > display key and enter the number.

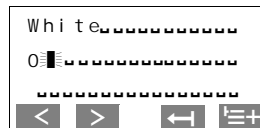

The first digit (in this case a "0") has been entered.

You can also make corrections while making new entries.

Examples: changing an entry

The following display appears, for example, if you have already selected "Edit Entry" in the directory menu:

Making changes in the Name field

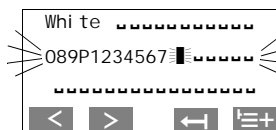

The field containing the cursor flashes until you press the delete key or enter a character.

Input function

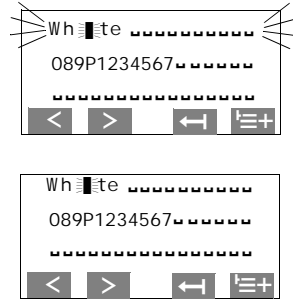

Change the name, e.g. from White to Whyte.

Procedure:

Using the < button, move the cursor to the letter "t" in the Name field. Press to delete the letter "i" and enter the new letter "y".

Making changes in the Contents field

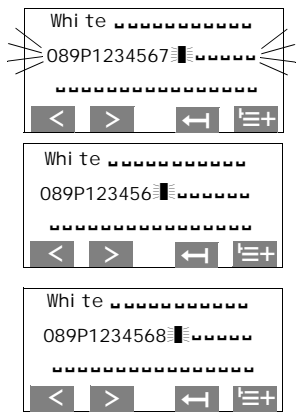

For example, replace the last digit with an "8".

Procedure:

Press > to place the cursor after the digit "7" in the Contents field: Press to delete this digit and enter "8".

Input function

Example: field boundaries

If you enter characters in fields that are already fully assigned (16 in the Name field and 32 in the Contents field), the last character in the relevant field is shifted to the right and thereby lost.

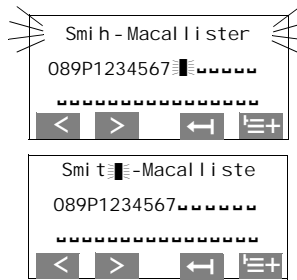

For example, in the case of the double-barrel name Smith-Macallister, if the missing "t" is inserted in Smith, the last "r" of Macallister will disappear.

If, in this example, the last "e" were to be replaced by an "l", the entry mark would have to be set to this place because the next place is in the second line and does not belong to the Name field.

Entering letters, special characters, and digits

The **Contents** fields are reserved for entering digits (e.g. call numbers). An additional menu is available for entering **special characters** (e.g. pause).



To make entries in the **Name** field, use the digit keys as an alphanumeric keypad. The letters are assigned to the digit keys in groups of three or four. Special characters, such as é, ò, ñ etc. are entered by pressing the key for the relevant letter group several times. To enter a space, full stop, and hyphen, press the 0 digit key.



You can shift from **lower case to upper case** by pressing the "*" key. The shift will apply to one character, after which the default lower case setting is restored

a, b, c, d...x, y, z

Depending on the position of the digit key, letters are input by briefly pressing the key (less than 1 second). For example, if you wish to enter the letter "r", you must press the key three times in succession, as "r" is the third letter assigned to this key.

For example, for key press the following keys repeatedly: "a", "o", "u", "B", "1", " , ,".

Input function

Character set

The following table shows how often a key has to be pressed to enter a specific character (letter, digit, and special character).

Default setting = lower case

key	Press x 1	Press x 2	Press x 3	Press x 4	Press x 5	Press x 6	Press x 7	Press x 8
1	ä	ö	ü	ß	1	,		
2	a	b	c	2	ä	à	â	ç
3	d	e	f	3	ë	é	è	ê
4	g	h	i	4	ï	î		
5	j	k	l	5				
6	m	n	o	6	ö	ñ	ó	ô
7	p	q	r	s	7	ß		
8	t	u	v	8	ü	ú	û	ü
9	w	x	y	z	9			
0	·	.	_	0	+	:	?	!
*	a→A	*	/	()	=	&	@
#	#							

Shift to upper case by pressing " * "

key	Press x 1	Press x 2	Press x 3	Press x 4	Press x 5	Press x 6	Press x 7	Press x 8
1	Ä	Ö	Ü	1				
2	A	B	C	2	Ä	À	Â	Ç
3	D	E	F	3	Ë	É	È	Ê
4	G	H	I	4	Ï	Î		
5	J	K	L	5				
6	M	N	O	6	Ö	Ñ	Ó	Ô
7	P	Q	R	S	7			
8	T	U	V	8	Ü	Ú	Û	Ü
9	W	X	Y	Z	9			
0	·	.	_	0	+	:	?	!
*	a→A	*	/	()	=	&	@
#	#							

Important basic settings

Important basic settings

Changing the base code/PIN

In order to protect basic and individual settings, your Gigaset 2011 has two four-digit "key numbers", the base code and the handset PIN (personal identification number). The factory default for both numbers is "0000".

The **base code** must be known if you want to perform important **basic settings** or lock the handset for outgoing calls. The base code is the main key to your Gigaset 2011.

The **PIN** is used to protect settings that mainly affect the **handset or the handsets**, and have no influence on the basic operation of the base station. For security reasons, you should set a new base code and a new PIN.

The same base code applies to all handsets if more than one is used (→ page 71).

Changing the base code

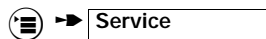

(→ means: scroll with , confirm with  OK)

Select the Service menu item.



Start the setting procedure.



Enter the old base code (factory default: "0000").

Enter the new, four-digit base code and note carefully the number entered.



Re-enter the new base code to confirm.



Save the setting.

Important basic settings

Changing the handset PIN

The PIN (personal identification number) for your handset can have up to 8 digits. The factory default for the handset PIN is 4 x "0". Changing the PIN prevents unauthorised persons from clearing entries from your directory, for example.

(→ means: scroll with , confirm with  **OK**)

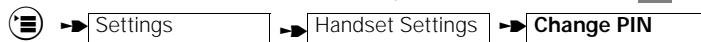

Once "Change PIN" has been confirmed, you are requested to enter the current PIN.



Enter the new PIN and note carefully the number entered.



Re-enter the new PIN to confirm.



Store the new PIN. The message "New PIN stored!" appears on the screen.



Incorrect entries can be modified. Do do this, follow the input function rules described from → page 37.

If you forget your base code or PIN

When entering a new base code or PIN, you must **not forget** the number entered. Otherwise, it may be necessary to open up the device. If this happens, please contact the manufacturer (for call number, see → page 94 of these operating instructions).

Important basic settings

Resetting the base station to the factory defaults

You can use this function to reset the following settings to factory defaults:

- Signalling method (→ page 13)
- Pause length following analog trunk/MSI (→ page 49)
- Call allocation (→ page 71)
- Call charge factor (not available in the UK)

The following stored data can be deleted:

- Call list
- Analog trunk/MSI
- Call units/charges

 The base code stored (→ page 43) is not deleted.
All registered handsets remain registered.

(→ means: scroll with , confirm with  **OK**)

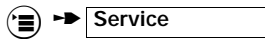

Select the Service menu item.



Start the setting procedure.



Enter the four-digit base code (factory default: "0000") (→ page 43).



Reset the base station to the factory default.

Important basic settings

Resetting the Gigaset 2000C handset to the factory defaults

You can use this procedure to reset the following settings to the factory defaults:

- Ringer volume **6**
- Ringer tone **1**
- Handset volume **1**
- Range warning, in-range beep **OFF**
- Key beep, battery warning beep, confirmation beep, error beep **ON**
- Automatic call acceptance, automatic backlighting **EIN**
- Baby alarm level **2**
- Language setting **German**
- DSS number, redial, ISDN configuration **Deleted**
- Select Services **ACTIVE**

 The handset PIN stored (→ page 44) is not deleted.

(→ means: scroll with  , confirm with )

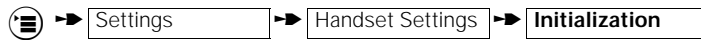

You are requested to enter the current PIN (factory default: "0000").



The settings are reset to the factory defaults when you confirm your entry.

Important basic settings

Operating in a telephone system

To be able to operate your Gigaset 2011 in a telephone system, you must first

1. check the signalling method,
2. enter the analog trunk or MSI
3. enter the pause lengths after the analog trunk or MSI.



Call number display (CLIP) can only be used if supported by the telephone system.

Possible signalling method settings

The factory default for the signaling method is

- DTMF/Flash.

You must **first** reset this setting to one of the following in order to operate your handset in telephone systems:

- DP

or

- DTMF/Flash.

Please also consult the instructions for use supplied with your telephone system.

(➔ means: scroll with , confirm with **OK**)

Activate the Service menu item.

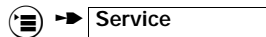

Start the setting procedure.



1

Enter the four-digit base code (factory default: "0000") (➔ page 43).



Set dial pulsing (DP)

or



Dual-tone multifrequency signalling DTMF/Flash

Important basic settings

Analog trunks

For operating your Gigaset 2011 in a telephone system for through connection to the public telephone network you must set:

- the analog trunk
- the pause length after the analog trunk (if a pause is necessary after entry of the analog trunk)

If the telephone system is connected as a subsystem to a main system, you must set the:

- the analog trunk
- the MSI
- the pause length after the analog trunk/MSI



For the pause length to be entered after the analog trunk/MSI, please consult the documentation supplied with your telephone system.

Entering the analog trunk and the MSI

The analog trunk and MSI have one to three characters and can comprise the digits $\overline{0}$ to $\overline{9}$ and the $\overline{*}$, $\overline{\#}$, and \overline{R} keys.

(\rightarrow means: scroll with $\overline{\downarrow}$, confirm with \overline{OK})

\rightarrow Service

Activate the Service menu item

$\overline{\#}$ $\overline{0}$

Start the setting procedure.



Enter the four-digit base code (factory default: "0000") (\rightarrow page 43).

$\overline{\leftarrow}$ REDIAL

Select the analog trunk.

or

$\overline{\leftarrow}$ REDIAL $\overline{\leftarrow}$ REDIAL

Select the MSI.



Enter the analog trunk or the MSI. If more than one analog trunk or MSI is available, you can enter the next analog trunk/MSI by pressing $\overline{\leftarrow}$ REDIAL.

$\overline{\leftarrow}$ SET

Save the setting.

Important basic settings

Modify the pause length after the analog trunk/MSI

Possible pause lengths are:

- 1 second
- 2 seconds
- 3 seconds (factory default)
- 6 seconds

(➔ means: scroll with , confirm with )

 ➔ Service

Activate the Service menu item.

 1

Save the setting.

Enter the four-digit base code (factory default: "0000").

 REDIAL    

Select pause length of 1 second.

or

 REDIAL    

Select pause length of 2 seconds.

or

 REDIAL    

Select pause length of 3 seconds (factory default).

or

 REDIAL    

Select pause length of 6 seconds.



The first analog trunk is appended to the incoming call when saving calls to the call list. This facilitates callback beyond the telephone system.

Deleting the analog trunk/MSI

(➔ means: scroll with , confirm with )

 ➔ Service

Select the Service menu item.

 1

Start the setting procedure.

Enter the four-digit base code (factory default: "0000").

 REDIAL    

Delete analog trunk/MSI.

Individual base station settings

Individual base station settings

You can program your Gigaset 2011 to suit your own individual requirements. The settings are made from a registered handset.

Switching the base station ringer off and setting the ringer volume

It is possible to define whether the ringers should be signalled at the base station or only on the handset. You can set the ringer volume for the ringer at the base station.

There are seven volume levels available:

Level 0 = Switch off base station ringer. Calls will only be signalled on the handset.

Level 1 ... Level 6 = Ringer volume low ... high

The factory default is level 6 (loud/high).

 It is also possible to set the ringer volume on the handset (→ page 53).

(→ means: scroll with , confirm with  OK)

Activate the Service menu item.

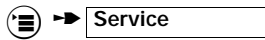

Start setting procedure. The ringer setting is sounded. The set volume is indicated on the display:



(Example: ringer volume 6 is set)



Press the digit for the desired volume (1 to 6) or 0 to switch the ringer off and save the setting.

Individual base station settings

Activating/deactivating music on hold

You are connected to an external party who has been placed on hold while you conduct an internal consultation or you have activated the mute function. The external party will hear music while on hold. Music on hold is activated by default.

(➔ means: scroll with  , confirm with  **OK**)

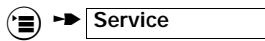

Service

Activate the Service menu item.



Start the setting procedure.



Enter the four-digit base code: (factory default: "0000") (➔ page 43).

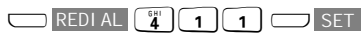

The current setting is displayed after the first digit **1**: 41 1 = activated, 41 0 = deactivated. Music on hold is activated the next time the digit **1** is entered (factory default)

or



Deactivate music on hold.

Setting the base station ringer tone

It is possible to define the tone used to signal calls at the base station. You can choose from a range of six tones. The factory default is level 1.



To set the ringer tone, the base station ringer must be switched on.

It is easier to distinguish between calls signalled at the base station and the handset if different ringer tones are set for each. The ringer tone can also be set for the handset (➔ page 53).

(➔ means: scroll with  , confirm with  **OK**)



Service

Activate the Service menu item.



Start setting procedure. The selected ringer tone is sounded. The set tone level is indicated on the display:

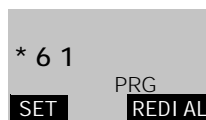

(Example: tone level 1 is set)



Enter the applicable digit for the required ringer tone (1 to 6) and save.

Individual handset settings

Individual handset settings

You can program your handset to suit your own individual requirements. All settings are made directly on the handset. When operating with more than one handset, the handset must be registered at the base station (→ page 69).

Setting the handset volume

The handset has three volume settings:

Level 1 ... Level 3 = handset volume normal ... loud

The factory default is level 1 (normal).

 This setting can also be adjusted during a call.

(→ means: scroll with  , confirm with  **OK**)

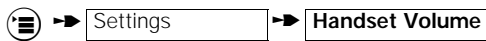

The following appears on your display:



(Example: handset volume is set to level 2)

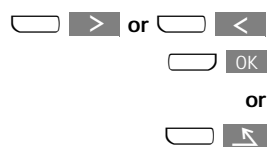

Set handset volume and confirm

or
Quit the function without saving any changes.

 The handset volume is displayed when the handset is on hook.

Individual handset settings

Ringer settings

You can set the ringer on your handset to suit your individual requirements. The ringer volume and tone can be modified using the ringer options menu.

Setting the ringer volume

You can set the ringer volume on your handset to one of seven settings:

Level 0 ... Level 6 = Ringer volume off ... loud

The factory default is level 6 (loud).

(➔ means: scroll with , confirm with  OK)

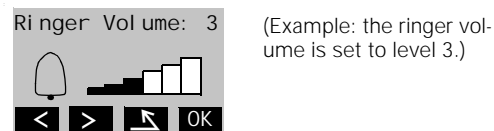
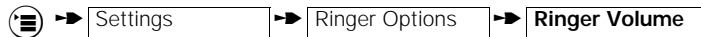

(Example: the ringer volume is set to level 3.)

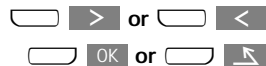

Modify ringer volume.

Store the setting or quit the function without saving any changes.

If the ringer volume is switched off (level 0), the symbol  is shown on the display.

Setting the ringer tone

You can set the ringer tone on your handset to one of ten levels.

The factory default is level 1.

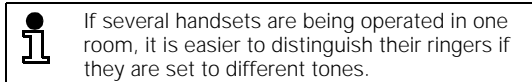

(➔ means: scroll with , confirm with  OK)

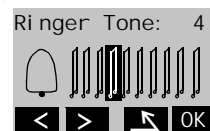
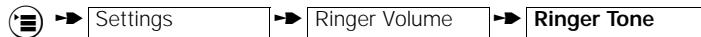

(Example: the ringer tone is set to level 4.)

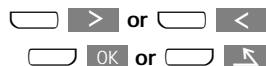

Change the ringer tone.

Store the setting or quit the function without saving any changes.

Individual handset settings

Activating/deactivating automatic backlight

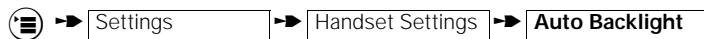

If the automatic backlight is set (✓ beside the menu item), the display backlight is activated automatically when you press a key or when a call is signalled (factory default).

(→ means: scroll with , confirm with  OK)



 ON / OFF

 OK

Switch the automatic backlight off or on by pressing OFF / ON and save. Symbol for ON = , symbol for OFF = .

or

 

Quit the function without saving any changes.

Automatic call acceptance

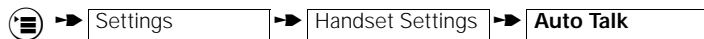

If the automatic call acceptance function is active, (✓ beside the menu item), calls are accepted by removing the handset from the charging unit (factory default).

(→ means: scroll with , confirm with  OK)



 ON / OFF

 OK

Switch the automatic call acceptance function off or on by pressing OFF / ON and save. Symbol for ON = , symbol for OFF = .

or

Quit the function without saving any changes.

ISDN configuration



This menu item is not available with the Gigaset 2011 base telephone.

Individual handset settings

Activating/deactivating notification and warning tones

You can switch the following notification tones on and off in the base station menu:

- Key beeps
- Battery low beep
- Range warning
- Confirm beep
- Error beep
- In range beep

A ✓ beside the menu item indicates that this function is activated.

Activating/deactivating the key beep

If the key beep is switched on, each keystroke is confirmed acoustically. You can switch the key beep on (factory default) or off.

(➔ means: scroll with  , confirm with  **OK**)

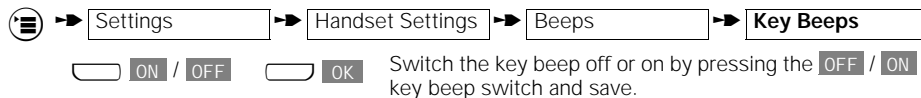

or

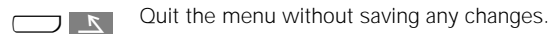

Activating/deactivating the battery low beep

If the battery low beep is switched on, a beep is sounded when the battery charge is too low. You can switch the battery low beep on (factory default setting) or off.

(➔ means: scroll with  , confirm with  **OK**)

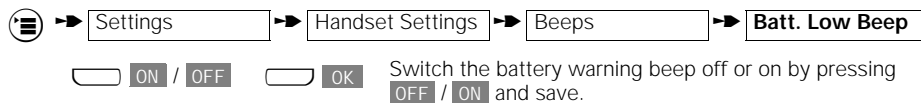

or

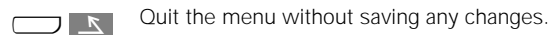



Individual handset settings

Activating/deactivating the range warning beep



If the range warning beep is switched on, a beep sounds if the handset is too far from the base station during a call. You can switch the range warning beep on or off (factory default).

(➔ means: scroll with  , confirm with  **OK**)



 **ON** / **OFF**  **OK** Switch the range warning beep off or on by pressing **OFF** / **ON** and save.

or



  Quit the menu without saving any changes.

Activating/deactivating the positive confirmation beep



The confirm beep is sounded when settings are completed correctly. You can switch the confirm beep on (factory default) or off.

(➔ means: scroll with  , confirm with  **OK**)



 **ON** / **OFF**  **OK** Switch the confirm beep off or on by pressing **OFF** / **ON** and save.

or



  Quit the menu without saving any changes.

Activating/deactivating the error beep



If the error beep is switched on it is sounded when an incorrect entry is made. You can switch the error beep on (factory default) or off.

(➔ means: scroll with  , confirm with  **OK**)



 **ON** / **OFF**  **OK** Switch the error beep off or on by pressing **OFF** / **ON** and save.

or

  Quit the menu without saving any changes.

Individual handset settings

Activating/deactivating the in range beep

If the in range beep is switched on, it is sounded when a handset that was too far from the base station moves back into range. You can switch the in range beep on or off (factory default: off).

(➔ means: scroll with , confirm with  **OK**)



 **ON / OFF**

 **OK**

Switch the in range beep off or on by pressing **OFF / ON** and save.

or

Quit the menu without saving any changes.

Baby alarm



If this function is switched on, an internal call is made to a second handset if noise above a specified volume is detected. An internal call is conducted with the baby alarm handset when the call is answered. If the call is not answered, or if you have already hung up, a new baby alarm call is set up as soon as the volume exceeds the set level. The baby alarm feature is not available in combination with a telephone lock.

Activating/deactivating the baby alarm

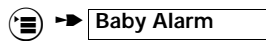

(➔ means: scroll with , confirm with  **OK**)



Enter the internal number of the internal party to be called.

  **Store**

or

  **Cancel**

To deactivate the baby alarm function, press the **OFF** display key.



Please switch off all warning beeps before using the baby alarm. When using your handset as a baby alarm, we recommend that you only operate it with fully charged batteries and not while it is standing in the charging unit.

Individual handset settings

Baby alarm level

You can set the baby alarm level to one of three levels.

(➔ means: scroll with , confirm with  OK)

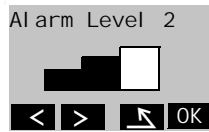

(Example: alarm level 2 is set)

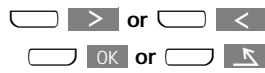

Change the level.

Save the setting or quit the function without saving any changes.

Selecting a language

You can choose from seven languages for the displays: German, English, French, Italian, Spanish, Portuguese and Dutch.

(➔ means: scroll with , confirm with  OK)

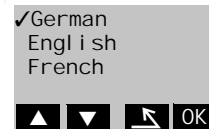
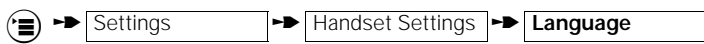

(Example: German is set)

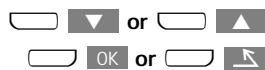

Select a language.

Save the setting or leave the active language.

You can reset inadvertent language changes using the following table:

Language version	Settings	Handset Settings	Language	English
D	Einstellungen	Lokale Einst.	Sprache	Englisch
GB	Settings	Handset Settings	Language	English
F	Réglages	Réglages combiné	Langue	Anglais
I	Impostazioni	Impostaz. Telef.	Lingua	Inglese
E	Ajustes	Ajuste local	Idioma	Inglés
P	Programações	Program. local	Língua	Inglês
NL	Instellingen	Lokale instell.	Taal	Engels

Individual handset settings

Select services

Some of the functions required for the select services offered by Deutsche Telekom are preprogrammed on your handset. You can activate the select services by pressing **SVC** or from the on-line menu (→ page 8) after pressing the Talk key. Select services are activated by default and the a list of the available select services is provided.

Select services list

Name	Keys	Meaning
Enquiry Call	R	Initiate an enquiry call/consultation
End active	R1	End the active connection
End inactive	R0	End the call that is on hold
Toggle	R2	Toggle between 2 external calls
3-Way Calling	R3	Initiate a 3-way conference
Call waiting off	#43#QE	Deactivate call waiting
Call waiting on	*43#QE	Activate call waiting

Activating and deactivating select services

(→ means: scroll with , confirm with  **OK**)

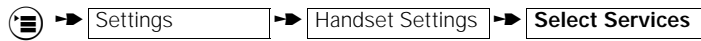

Press **OFF** or **ON** to deactivate or activate select services, press **OK** to save them or  to quit the menu without saving any changes.

Loading the select services list provided

The select services list is loaded via the additional menu (select services menu).

 Only load the select services list once, otherwise the entries will be duplicated. If you want to update the list with "Reload", you should first delete all existing select service entries.

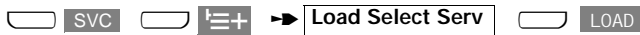

Select services menu

For information on administering the select services list, see the chapter on short cuts → page 77.

Displaying call duration

Displaying call duration

 In the following routines, you can use the key sequence **[INT] [SET]** instead of activating the Service menu item.

Activating/deactivating call duration display

In the case of external connections (→ page 17), the call duration display appears approximately 12 seconds after the last digit is dialled. The display remains visible for approximately 4 seconds after the call has been ended.

 Call duration display is activated by default.

(→ means: scroll with **[DOWN]**, confirm with **[OK]**)

Select the Service menu item.

 → **Service**

[#] [1]

Start the setting procedure.



Enter the four-digit base code (factory default: "0000").

[REDIAL] [9] [6]

The current setting appears on the handset display: **96** = activated, **96 0** = deactivated.

[0] [SET]

Deactivate call duration display.

or

[1] [SET]

Activate call duration display.

Gigaset 2011 lock functions

Gigaset 2011 lock functions

Activating/deactivating the lock for outgoing calls

It is possible to lock the Gigaset 2011 for outgoing calls.

If emergency numbers are stored, they can be dialled even if the lock is active.

It is possible to receive calls while the lock function is on.

The factory default for this function is deactivated.

 You can also lock individual handsets for outgoing external calls (→ page 67).

(→ means: scroll with  , confirm with  **OK**)

Select the Service menu item.

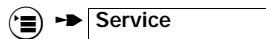

Start the setting procedure.



Enter the four-digit base code (factory default: "0000").



Switch on the lock.

or



Switch off the lock.

Emergency calls when the system is locked

You can program up to four emergency call numbers. Emergency call numbers can be dialled from each registered handset,



- even if the Gigaset 2011 is locked for outgoing calls, or (→ page 61), or
- if the handset is only set for outward-restricted trunk access (→ page 66).
- if the handset lock is switched on (→ page 67).

Emergency call numbers can have up to 16 digits.

 The emergency numbers 999, 112 and 9112 are preset in the base station.

Gigaset 2011 lock functions

Displaying and storing emergency numbers

(➔ means: scroll with , confirm with  **OK**)

Select the Service menu item.

Start the setting procedure.

Enter the four-digit base code (factory default: "0000"). (➔ page 43). The current entry for the first emergency number is displayed:

1 

SET

SET REDI AL

(Example: no emergency number stored)

1 110

SET

SET REDI AL

(Example: emergency number 110 stored)

 **REDI AL** Display the next emergency number.

or

 **SET** Quit the display.

or



 Enter the emergency number for the displayed entry (1 to 4). If a number is already stored there, the new number will overwrite the old one.

 **REDI AL** Display the next number. The emergency numbers you have entered are programmed for storage.

or

 **SET** End procedure. Store all entries.

Deleting all emergency numbers

(➔ means: scroll with , confirm with  **OK**)

Select the Service menu item.

Start the setting procedure.

Enter the four-digit base code (factory default: "0000").

Delete all emergency numbers.

Gigaset 2011 lock functions

Barred numbers for handsets

By storing barred numbers for each registered handset, you can prevent certain external call numbers or types of number from being dialled if the call number lock is activated (→ page 65).

You can store up to three barred numbers for each handset. Barred numbers can have up to eight digits.

Displaying or storing barred numbers

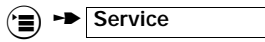

(▶ means: scroll with , confirm with )

Select the Service menu item.



Start the setting procedure.

Enter the four-digit base code (factory default: "0000"). (→ page 43). The registered handsets or their internal extensions are shown on the display:

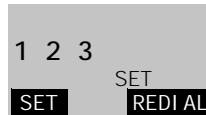

(Example: handsets 1, 2, and 3 are registered)



Enter the internal extension of the desired handset (1 to 6).



Select the first barred number for the selected handset. The barred number is shown on the display:



(1st example: no barred number stored)

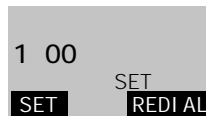

(2nd example: barred number 00 stored)



Display the next barred number.

or



Enter a barred number for the displayed memory slot (1 to 3). If a barred number is already stored, the new number overwrites the old one.



Display the next barred number. The barred number you entered is stored.

Gigaset 2011 lock functions

or



End procedure:

 The barred numbers only take effect if the call number lock is switched on

Deleting all barred numbers

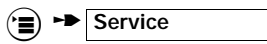

(➔ means: scroll with  , confirm with  **OK**)

Select the Service menu item.



Start the setting procedure.

Enter the four-digit base code (factory default: "0000"). (➔ page 43). The registered handsets or their internal extensions which have a barred number stored are shown on the display:

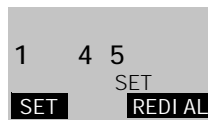

(Example: barred numbers are stored for handsets 1, 4, and 5)



Enter the internal extension of the desired handset (1 to 6).



Delete all barred numbers for the selected handset. The delete function must be repeated for each handset.

 The delete function must be repeated for each handset.

Gigaset 2011 lock functions

Activating/deactivating the call number lock

You can activate and deactivate the call number lock separately for each registered handset. Other handsets are not affected by the lock.

Calls can still be accepted on the handset even if the call number lock is switched on.

The factory default setting is off.

(➔ means: scroll with , confirm with  **OK**)

Select the Service menu item.

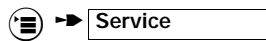

Start the setting procedure.

Enter the four-digit base code (factory default: "0000"). (➔ page 43). The registered handsets, i.e. their internal extensions, are shown on the display:

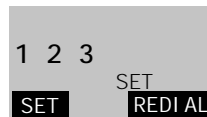

(Example: handsets 1, 2, and 3 are registered)



Enter the internal extension of the desired handset (1 to 6).



Switch on the call number lock for the selected handset.

or



Switch off the call number lock for the selected handset.

Gigaset 2011 lock functions

Setting trunk access for the handset

You can define for each registered handset whether or not external calls can be made. A distinction is made between:

- **Unrestricted trunk access** (factory default) – external calls allowed, and
- **Outward-restricted trunk access** – external calls cannot be made but incoming calls can be accepted. The call list cannot be activated with handsets with outward-restricted trunk access.

(➔ means: scroll with , confirm with  **OK**)

Select the Service menu item.

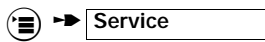

Start the setting procedure.



Enter the four-digit base code (factory default: "0000") (➔ page 43).



Prepare to select the required handset.



Enter the internal extension (1 to 6) of the handset. The current status of the selected handset is shown on the display:



(Example: handset **2** has **1** = unrestricted trunk access)



Set "Unrestricted trunk access"

or



Set "Outward-restricted trunk access"

Lock functions on the handset

Lock functions on the handset

It is possible to lock your handset against unauthorised use. Depending on the type of lock you select, emergency numbers can still be called from the handset.

Activating/deactivating the handset lock

You can lock your handset for outgoing calls to protect it against unauthorised use. Calls can be answered with locked handsets.

(→ means: scroll with ▼, confirm with OK)

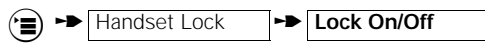

When you select the handset lock you will be requested to enter your **handset PIN**.



OK

Enter the PIN (factory default "0000") and confirm.

ON / OFF

OK

Switch the handset lock off or on by pressing the OFF / ON key and save.

or

↗

Quit the menu without saving any changes.

Barred numbers for handsets

Barred numbers are stored and displayed for handsets via the base station (→ page 63).

Lock functions on the handset

Handset display with active lock

Display with locked handset

The handset lock is switched on.

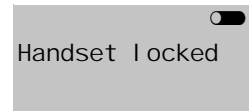

Display with system lock

The seizure of the line with or without prior call number entry results in the opposite display.

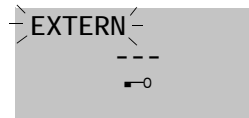

Display with call number lock

Any attempt to dial a barred number is rejected with an error tone.

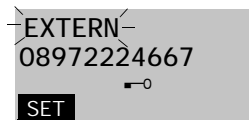

Display with outward-restricted trunk access or internal access

In the case of outward-restricted trunk access (→ page 66), an error tone is output.

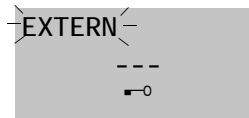

Registering/de-registering more than one handset at the base station

Registering/de-registering more than one handset at the base station

You can operate up to six handsets of the types Gigaset 2000S and/or Gigaset 2000C or Gigaset 2000T as well as the Gigaset 1000TAE cordless socket at a Gigaset 2011 base station.

The standard Gigaset 2000C handset supplied is already registered at the base station with the internal **call number 1** and **base number 1**.

Each additional handset that you purchase must be registered at the base station. We recommend that you keep the base number 1 for this base station when registering other handsets at the base station.

Registering a Gigaset 2000C handset at a base station

 If you want to operate your handset at more than one base station (up to six) (→ page 71), you must repeat the following procedure at each base station.

(→ means: scroll with  , confirm with )

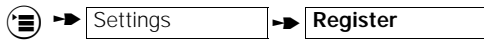

The available base stations are displayed (1 to 6). Select a base station (recommendation: Base 1)



Prepare the base station

 Press the green paging key on the base station until you hear the logon tone (after approximately ten seconds).

Register the handset



Enter the four-digit base telephone base code and confirm (factory default: "0000"). The handset is now registered at the base station.

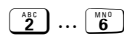
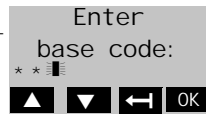

The unassigned internal numbers are displayed. Use the dialling keypad to select one of these numbers as the handset number.

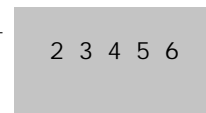



Registering/de-registering more than one handset at the base station



If you do not enter one of the numbers, the system automatically assigns the next free handset number after several seconds. Registration is complete when the station selected is displayed.

Registering the Gigaset 1000TAE cordless socket



You can connect a fax, modem or another telephone, for example, to the cordless socket. The device in question is registered at the base station in the same manner as a handset. Gigaset 1000TAE is not included in the Gigaset 2011 scope of supply. For more information, contact your specialist dealer.

De-registering a handset from a base station

- (➔ means: scroll with , confirm with  OK)
-  ➔

Activate the Service menu item.
 -   

Start the setting procedure.
 - 

Enter the four-digit base code (factory default: "0000") (➔ page 43). All registered handsets are shown on the display.
 -  

Enter the internal call number of the desired handset (1 to 6) and confirm by pressing  SET.

Operating more than one handset

Operating more than one handset

Call allocation for incoming calls

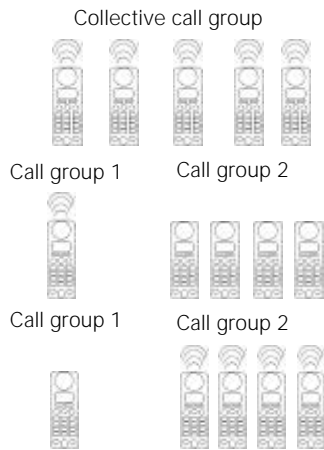



It is possible to set how incoming calls should be signalled when operating several handsets. A distinction is made between:

- **Collective call** (factory default) – incoming calls are signalled to all registered handsets. You can exclude individual handsets from the collective call group and reintegrate previously excluded handsets.
- **Ring priority** – incoming calls are first signalled at a preferred (prioritised) handset. If this party does not accept the call, the system automatically forwards it to the handsets assigned to the collective call group after an defined number of rings.

You can define which handset is assigned to the first group and which are assigned to the second group. Extensions that are not entered are excluded from ring priority.

Switching between collective call and ring priority

(→ means: scroll with , confirm with  **OK**)

Activate the "Service" menu item.

Start the setting procedure.

Enter the four-digit base code (factory default: "0000") (→ page 43).

The current setting is shown on the display:

*23 1
SET
REDIAL

(Example: ! = collective call is set)



1  **SET** Set collective call.

or

2  **SET** Set ring priority.



Operating more than one handset

Excluding or including a handset from/into collective call





(➔ means: scroll with , confirm with  **OK**)

Activate the Service menu item

 ➔

  Start the setting procedure.

 Enter the four-digit base code (factory default: "0000") (➔ page 43).



 **REDIAL**    The current setting is shown on the display. Handsets which are in collective call mode are indicated by their internal extensions and excluded handsets are indicated by a space:

*21 1 2 3 4
SET
REDIAL



(Example 1: handsets 1, 2, 3, 4 are in coll. ringing)

*21 1 2 4
SET
REDIAL

(Example 2: handset 3 is not in collective call)



  **SET** Enter the internal extension of the desired handset (1 to 6) and confirm. If the handset is already in collective call mode it is excluded. If it was previously excluded it is re-integrated into the collective call.

Selecting a handset for ring priority





(➔ means: scroll with , confirm with  **OK**)

Activate the Service menu item

 ➔



  Start the setting procedure.

 Enter the four-digit base code (factory default: "0000") (➔ page 43).

 **REDIAL**    The current setting is shown on the display:



*22 1
SET
REDIAL

(Example: handset 1 has ring priority)

  **SET** Enter the internal extension of the desired handset (1 to 6) and confirm.

Operating more than one handset

Setting the number of rings for ring priority



(→ means: scroll with , confirm with  **OK**)

Activate the Service menu item.

 → **Service**



 **1** Start the setting procedure.

 Enter the four-digit base code (factory default: "0000") (→ page 43).

 **REDI AL**  **6** The current setting is shown on the display:

(Example: 3 rings are set)

 ***6 3** **SET** **SET** **REDI AL**

  **SET** Enter the desired number of rings (two to nine) and confirm.

Naming handsets

The station at which the handset is registered is shown on the display. This is useful for identifying your handsets. The base station is assigned a different name for every handset.

For the first handset, call **Base 1** "Mobile1", for example, and call the second one "Mobile2".

For information on renaming stations, see → page 76.

Operating at more than one base station

Operating at more than one base station

You can register and operate your handset at up to 6 Gigaset base stations (as of Gigaset 1010 and Gigaset 2010 and higher).

This offers the following advantages:

- You can operate the same handset at base stations in different geographical locations (e.g. in the office and at home).
- You can extend the range or the area in which you can call with the same handset in large areas by placing the base stations in suitable locations.



Please note the following when operating at more than one base station:

- Ongoing calls are interrupted or cleared down when you move from one base station radio range to another.
- Internal calls can only be made within the radio range of a base station, i.e. not to handsets that are in another base station radio range.
- If you are out of range of a base station for several minutes, and your handset is switched on, then when you re-enter the range it may take up to 20 minutes to "find" the base station again. In such cases, switch the mobile unit off for a minute and then on again.

We recommend following the procedure below:

- Register your handset at the required base stations (→ page 69) and assign the required base station numbers (1 to 4). Register your handset at all base stations with the same internal call number, provided this is not yet assigned.

You can see which base station your handset is currently using at any time on your handset display. Note the instructions for naming handsets on → page 73.

Operating at more than one base station

Selecting the best station

The handset automatically selects the station to which it can set up the best radio connection.

(➔ means: scroll with , , confirm with  **OK**)

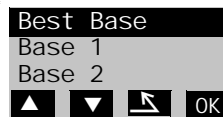
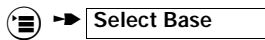

Select Best Base and press OK to confirm.

Setting the preferred or fixed station

In the case of "priority selection", the handset first searches for the required base station (identified by an "*" in the display). The handset only searches for an alternative station if it cannot find this. If "Fixed Selection" is set, the handset only searches for the required base station.

(➔ means: scroll with , , confirm with  **OK**)

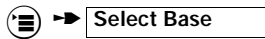

Select the base station.

Priority selection

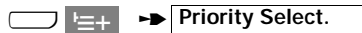

Fixed station

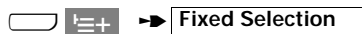

If the handset is unable to set up radio contact to the selected station, the handset automatically searches for the current base station. An "*" identifies the preferred station in the display, e.g. "*Base 2".



Operating at more than one base station

Base station names



You can change the preset base station names ("Base 1" to "Base 6"). In a company, one station can be called "Purchasing", for example, and another "Stock". You can also use this function to name handsets (→ page 73)

(→ means: scroll with , confirm with  **OK**)



 → Settings → Base Settings

  Select the base station you want to rename.

Activate Change Base Name in the additional menu.

  → Change Base Name

If you change a name (→ page 37), save it with "Save Entry".

  → Save Entry

You can exit the relevant menu levels at any time without saving any changes by pressing .





The menu item **ISDN Config.** does not apply to Gigaset 2011.



De-registering a base station

This menu option is for de-registering the handset if the base station is no longer available, i.e. if it is defective or at a remote location.

 → Settings → Base Settings

  Select the base station you want to de-register.

Activate De-register base in the additional menu.

  → De-register base



The registration data is **only** deleted in the handset if you perform this function on the handset. To ensure that your handset is de-registered at the base station, the de-registration must be performed at your base station (→ page 70).

Short cuts

Short cuts

Descriptions with example

A short cut is a series of commands that is stored under a short cut name and can be activated from the list of short cut names in the same way as a directory entry. Short cuts are very useful for base stations at which the Gigaset 2000C must be operated with key combinations. You can store operating sequences or inputs for base station settings.

If you want to check your own call allowance account, for example, the following inputs are necessary via the menu or keyboard:



In this case, a short cut would contain the following elements:

"S # 22BS"

A macro created with the input function could be entered in the short cut list under the name "Unit check", for example. It is activated with:

(→ means: scroll with , confirm with  **OK**)

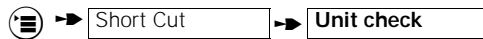

The balance of your handset account is displayed. This short cut is provided with the system macros (→ page 83).

Short cut menu

When you call up the short cut function, a list is available containing all of the available short cuts. If the list is empty, a broken line is shown. The short cut menu is activated by pressing the  display key. The following options are available:

- Start
- New Entry
- Edit Entry
- Delete Entry
- Display Entry
- Copy Entry
- Delete Memory
- Copy Memory
- DefaultShortCuts
- Available Memory

Short cuts

New entry

To create a short cut, call up the short cut function in the main menu. If no short cut has previously been created, the short cut list will contain a broken line. You can create a new short cut using the New Entry option in the short cut menu.

(➔ means: scroll with , confirm with )



When you select New Entry you can access a one-line Name field and a two-line Contents field. First give the new short cut a name.

Entries for a short cut follow the rules described in the chapter "Input function" ➔ page 37.

Function list

To make it possible to enter short cut elements (special characters) in the Content field in addition to digits, call up the Insert Function option in the additional menu.

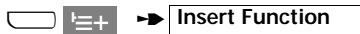

A list of functions is displayed from which you can choose. Each function which can occur in a command line is presented in this list as plain text. The available functions and their meanings are explained in the following table.

Function	Display
Request PIN Code	C
Request Number	N
Insert Pause	P
Request Acknowl.	Q
Base Prompt	B
INT Key	I
SET Key	S
Redial Key	W
End Call	E
TempSwitchToTone	M

In order to create the "Unit check" short cut, the special characters "C*BS" for Request PIN Code, Display base messages and SET Key are necessary. As these characters cannot be entered in the Contents field with the keyboard, they must be obtained from the function list.

Short cuts

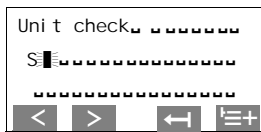
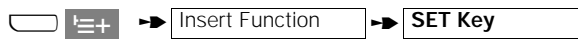
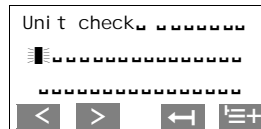

The numerical values and the *, # symbols are entered directly via the keypad.

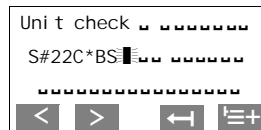
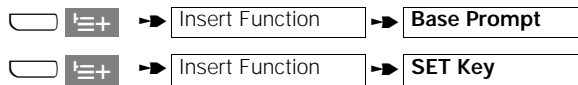
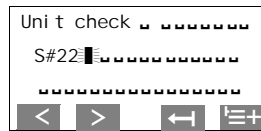

Displaying a function

To find out the meaning of a function (special character), place the cursor on the character and call up the Show Function menu item. An explanatory text appears on the display.

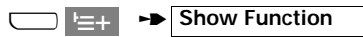

Saving a short cut

You can save the short cut when all of the values have been entered.

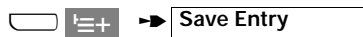

Short cuts

Cancelling a procedure

You can also delete the entry by selecting Cancel.

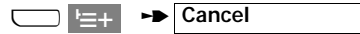

Checking for double entries

To avoid having a short cut feature several times in your list under different names, you can have the list checked automatically. As soon as an identical entry is found, it is indicated on the display. For this function, the cursor must be located in the Contents field.

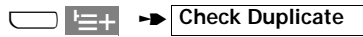

Editing an entry

You can edit any entry in the short cuts list at any time.

(➔ means: scroll with , confirm with )

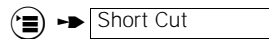

Select the entry to be edited and call up the Edit Entry menu option.

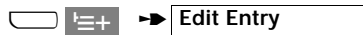

The input function is active. Proceed as for New Entry.

Deleting an entry

You can also delete entries from the short cuts list.

(➔ means: scroll with , confirm with )

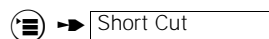

Select the entry to be deleted and call up the Delete Entry menu option.

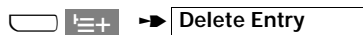

The entry is deleted and the short cuts list is displayed again.

Short cuts

Displaying an entry

Short cuts can be displayed for checking purposes.

(➔ means: scroll with , confirm with  **OK**)



Select the entry you wish to display from the list and call up the Display Entry menu option.

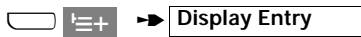

The short cut name and contents will be shown on the display. You can return to the short cuts list by pressing the **GO BACK** display key.

Deleting all entries

You can delete all entries from the short cuts list.

(➔ means: scroll with , confirm with  **OK**)



You will be requested to enter the PIN (factory default "0000 "). The rules for the input function apply ➔ page 37.



When you have entered the correct PIN, you can delete all entries by pressing **YES** and return to a blank short cuts list.

or



You can cancel the procedure by pressing **NO**, or by pressing the  menu key.

Available memory

You can display the percentage of memory available for further entries using this function.

(➔ means: scroll with , confirm with  **OK**)





A message with the requested information, for example "Memory: 70% available" is displayed.



Short cuts

Copying an entry/memory



Short cut entries can be copied between enhanced Gigaset 2000T or 2000C telephones/handsets. The Gigaset 2011 base station supports this feature.



(→ means: scroll with , confirm with )

 → Short Cut

  Select the required entry from the list.



Activate Copy Entry from the additional menu.

(→ means: scroll with , confirm with )

  → Copy Entry







Enter the internal extension of the telephone or handset receiving the entries in response to the request "Copy entry to internal". **Start** the copy operation as follows:

  → Copy

The receiving telephone is called. When the call is answered, the called party is requested to enter the PIN. The copy operations begins if the correct PIN is entered.

The Copy Memory function is performed in the same way as the Copy Entry function:

(→ means: scroll with , confirm with )

 → Short Cut   → Copy Memory

The receiving telephone is called. When the call is answered, the called party is requested to enter the PIN. The copy operations begins if the correct PIN is entered.

Short cuts

Starting a short cut

If one or more short cuts have been created, you can select them and start them when you are both off-line and on-line (after pressing the Talk key).

(➔ means: scroll with , confirm with  **OK**)



Select the desired short cut from the list and call up the Start menu option.

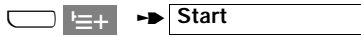

The active status is shown on the display until the short cut is executed. A typical message would read "Shortcut active: unit check".

The display message will only be interrupted if, for example, the user is requested to enter the PIN.

Default short cuts

A list of default (system) short cuts is already loaded in your short cuts list. The list contains the following short cuts:

Name	Sequence	Meaning
Total units	S#83C*BS	Check total call charges for all handsets
Unit check	S#22BS	Check call allowance account
Call Barring off	S#84CB0S	Switch off call barring
Call Barring on	S#84CB1S	Switch on call barring
Base lock	S#24CBS	Switch base lock on/off
Base Tone Ringer	S#*6BS	Change base ringer volume
Base Ringer Vol.	S#*5BS	Change base tone ringer

(➔ means: scroll with , confirm with  **OK**)

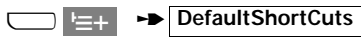

All of the default short cuts can be loaded into the short cuts list by pressing **LOAD**. You can quit the procedure by pressing **CANCEL**. The system short cuts are arranged in alphabetical order in an existing short cuts list.

Short cuts

Short cut list

for handset and base functions:

Suggested short cut name	Short cut	Meaning	Page reference
Change base code	S#8*CCCS	Change the base code	→ page 43
Call duration	S#1CW961BS	Call duration display on	→ page 60
Act call display	S#1CW962BS	Activate call charge display	not available in the UK
Dis handset charges	S#83CBNBS	Display total charges for one/all handsets	not available in the UK
Del handset charges	S#83CBN0BS	Delete total charges for one/all handsets	not available in the UK
Base lock on/off	S#24CBNS	Activate/deactivate base station lock	→ page 61
Dis/mod emerg nos	S#25CWBWBWBWBS	Display/save emergency numbers	→ page 62
Dis/mod barred nos	S#85CBNWBWBWBS	Display/save barred numbers	→ page 63
Del h/s barred nos	S#87CBNS	Delete all barred numbers for a handset	→ page 64
Act h/s trunk access	S#1CW*1N1BS	Activate unrestricted trunk access for a handset	→ page 66
Act h/s out-rest accss	S#1CW*1N0BS	Activate outward-restricted trunk access for a handset	→ page 66
Mod call allowance a/c	S#21CBBS	Edit the call allowance account	not available in the UK

Important notes on putting into service and operation

Important notes on putting into service and operation

Installing the base station

Installation site/installation area

- A 220/230 V AC power socket must be located at the installation site.
- In order to avoid interference, the base station should not be in the direct vicinity of other electronic equipment such as Hi-fi, office or microwave equipment.
- Place the base station on a flat, non-slip surface. Under normal circumstances, the rubber feet will not leave marks. However, due to the vast array of surface finishes applied to furniture, marks on the installation surface cannot be entirely ruled out.
- Radio transmission between the base station and handsets complies with the DECT standard. Gigaset 2011 thus observes all relevant European regulations. However, if there is interference to the picture or sound of your satellite equipment, consult your specialist satellite dealer.
- Depending on ambient conditions, the maximum radio range between the base station and the handset is approx. 300 m outdoors, and approx. 50 m indoors. If the range warning is activated for the handset (→ page 56), a signal will sound when you move outside the radio range.

Temperature/ambient conditions

- The base station is designed for operation in protected areas with a temperature range from +5 °C to +45° C.
- The base station should not be installed in damp areas (such as bathrooms or laundry rooms), close to heat sources or in direct sunlight.

Important notes on putting into service and operation

Notes on operating the handset

For users who wear hearing aids

If you wear a hearing aid, please note that radio signals can interfere with hearing aids, and if sufficiently loud, can cause a very unpleasant humming sound.

Using rechargeable batteries

The following should be noted when using rechargeable batteries:

- Only use the rechargeable battery types supplied (AA nickel-cadmium batteries).
- Nickel-metal-hydride (NiMH) rechargeable batteries can significantly increase the time for which Gigaset 2000S/2000C can be used.
- The following batteries are authorised:

Nickel-cadmium	Nickel-metal-hydride
Saft RC6	Sanyo HR-3 U (1300 mAh)
Panasonic P-60 AA/1P	GP GP120 AA HC
Philips R6 NC-P	Emmerich CE R 6
UCAR RC6	Energizer EMH-1100 AAC
Energizer Eveready RC 6	Varta VH 1101 AA
DAIMON ACCU 1000	
Varta Accu Plus Ni-Cd 1,2V No. 5006	
Sanyo N-3U	

Important notes on putting into service and operation



Once the NiMH rechargeable batteries have been inserted, the following should be observed to ensure maximum lasting power from your batteries: once the batteries have been fully charged for the first time, the handset prematurely indicates that the batteries are running low (▣). In order to deep discharge the batteries, continue to use the handset until the battery symbol □ appears and the batt. low beep sounds (caution: max. operating time remaining is 10 minutes). In this way the handset recognises the extended capacity of the rechargeable batteries and will in future display the correct battery charging status.



Opening the battery compartment resets the display to the capacity of the batteries delivered with the telephone.



Only use NiMH batteries with the Gigaset 2000S and 2000C handsets.
These batteries **cannot** be used with Gigaset 1000S and 1000C handsets!

- Using other battery types or non-rechargeable batteries may cause malfunctions or even damage the equipment. The manufacturer shall assume no liability in this case.



Never use ordinary batteries.

When installing and using the rechargeable batteries, please follow the rules below:

- The handset can be replaced in the rest each time a call is ended. Charging is controlled electronically. This ensures optimum and even charging of the batteries.
- Initially charge the batteries thoroughly. We recommend charging the batteries for approximately 16 hours without interruption (overnight for example). During the first week of operation, continually replace the handsets in the charging unit for recharging.
- New batteries do not usually reach their full capacity (i.e. maximum time when the telephone is in use and stand-by time) until they have been in normal use for several days. Although the battery LED indicates that the rechargeable batteries of a handset have been charged (LED off), you must assume during this initial phase that the capacity may not reach that of maximum time when the telephone is in use, or that of stand-by time.

Important notes on putting into service and operation

- After they have initially been thoroughly charged (proven charging time approx. 16 hours), the rechargeable batteries are fully operative. The rechargeable batteries should be discharged from time to time. **Caution:** partially discharged batteries only offer limited operating time.
- Make sure that the contacts do not touch metal or oily objects.
- The LED display lights up occasionally to indicate that float charging is taking place.

Handset battery life:

Battery type	Stand-by time (hours)	In use (use)
NiCd, 600 mAh	up to 70	up to 7 (8.5 [*])
NiMH, 1100 mAh	up to 110	up to 11 (13 [*])
NiMH, 1300 mAh	up to 130	up to 13 (16 [*])

*In use near the base station

Battery charging times:

Battery type	Charging time in the handset (hours)	Charging time in the batt. comp. (hours)
NiCd	4-5	24
NiMH, 1100 mAh	8-9	40

Fitting the carrying clip on the handset

If required, you can fit the carrying clip supplied with the handset, e.g. if you wish to carry the handset in your pocket.





























Hold the handset with the keypad facing the palm of your hand. You will see two small holes on the sides, level with the display. Place the clip in one hole and then insert it into the opposite hole until it clicks into place.

Important notes on putting into service and operation

Operating with the Gigaset 2000S (1000S) handset

The Gigaset 2000S (1000S) handset supports all Gigaset 2011 features.

Differences in operation

Gigaset 2000C (Gigaset 1000C)	Gigaset 2000S	Gigaset 1000S
 or 	 or 	
 → <input type="text" value="Service"/>		
<input type="text" value="SET"/>		
<input type="text" value="REDIAL"/>		
<input type="text" value="→"/>		
<input type="text" value="COLL. CALL"/>	<input type="text" value="INT"/> 	<input type="text" value="INT"/> 
<input type="text" value="ACCEPT"/>	 	 
<input type="text" value="LIST. ON"/>	 	 
<input type="text" value="LIST. OFF"/>	 	 

Maintenance

Simply wipe the handset and base station with a damp cloth or an antistatic wipe.

 Never use a dry cloth as this causes static discharge.

Important notes on putting into service and operation

Connecting the telephone socket

Only use a Siemens telephone cord. Non-Siemens cords may have a different pin assignment.

The telephone cord jack is connected on the underside of the base station as follows:

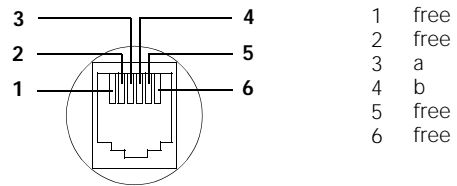

Important notes on putting into service and operation

Technical data

Standard:	DECT = D igital E nhanced C ordless T elecommunications GAP = G eneric A ccess P rofile (standard adhered to by most manufacturers for DECT radio transmission)
Number of channels:	120 duplex channels
Radio frequency range:	1880 MHz to 1900 MHz
Duplex method:	Time-division multiplexing, 10 ms frame length
Channel grid:	1728 kHz
Bit rate:	1152 kbit/s
Modulation:	GFSK
Voice coding:	32 kbit/s
Transmitted power:	10 mW, average output per channel
Range:	up to 300 m outdoors, up to 50 m indoors
Base station power supply:	Base station 220/230 V –/ 50 Hz (plug-in power unit)
Base station power consumption:	Stand-by: approx. 3 W In use: approx. 5 W
Operating and charging times	See → page 88
Permitted ambient conditions for operation:	+5 °C to +45 °C 20% to 75% relative humidity
Signalling method:	DP (dial pulsing) / DTMF (dual-tone multifrequency)
Recall key function:	Flash
Base station dimensions:	approx. 190 x 172 x 90 mm (L x W x H)
Handset dimensions:	approx. 160 x 55 x 25 mm (L x W x H)
Weight:	Base station 350 g Handset with rechargeable batteries approx. 165 g
Cable lengths:	Telephone cord approx. 3 m Power cord approx. 3 m
Plugs:	BT / TSV 6/4 (telephone cord) TSV 6/4 (power cord)

Important notes on putting into service and operation

Third party use/disposal

Your Gigaset 2011 telephone should only be passed onto third parties if the instructions for use are included.

When the system or batteries have reached the end of their service life, they should be disposed of in an environmentally friendly manner in accordance with relevant legislation.

Warranty

Siemens AG offers a six-month warranty for this device from the date of purchase from the dealer. Always retain receipts as proof of date of purchase.

Over this warranty period, Siemens AG will rectify all material or manufacturing defects by repairing or exchanging the defective terminal. Siemens AG reserves the right to fulfil the warranty conditions by repairing or replacing the defective terminal.

The warranty does not cover damage caused by incorrect use, wear and tear or third party access. The warranty does not cover consumables or defects which only have a minor effect on the value or operability of the terminal.

The Siemens product purchased complies with the technical requirements for connecting to the German public telephone network.

For warranty claims, please contact Siemens Service (for address and nationwide service telephone number, see ► page 94).

Important notes on putting into service and operation

Procedure in the case of malfunctions

Not every malfunction means that there is an actual defect in your telephone. In some situations you may save time and money if you can eliminate the cause of simple faults yourself. The information below will help you do this.

Symptom	Cause	Remedy
No display appears.	Handset is not switched on. Battery is empty.	Switch on the handset. Replace the battery with a backup battery or recharge it.
Cannot seize the dial-up line; no dial tone.	The plug on the power cord is not connected properly. The plug on the power cord is not connected properly. The plugs may have been switched. The dial-up line is being used by another handset.	Check the plug at the base station and telephone socket; if necessary remove it and plug it back in (→ page 2). Check the plug at the base station and the 220 V/230 V socket; if necessary remove it and plug it back in (→ page 2). Wait until the dial-up line is free.
Cannot set up a radio link to the base station - symbol on the handset flashes.	Handset is not registered. The plug on the power cord is not connected properly.	Register the handset at the base station (→ page 69). Check the plug at the base station and the 220 V/230 V socket; if necessary remove it and plug it back in.
Base station or handset does not ring.	Ringer volume is set to low. The call allocation is not set correctly.	Adjust the base station (→ page 50) or handset (→ page 53) ringer volume. Adjust the call allocation (→ page 71).
No connection after dialling a call number; dial tone can still be heard.	Wrong signalling method.	Reset the signalling method (→ page 13).
With telephone systems: no connection or wrong connection after dialling from a memory.	Analog trunk/MSI not entered.	Enter analog trunk/MSI (→ page 48).

Important notes on putting into service and operation

Symptom	Cause	Remedy
Base code entered is rejected.	Base code entered does not correspond with the changed code.	If you have forgotten your changed base code, please contact the manufacturer (for call number see under "Contact person").
PIN entered is rejected.	PIN entered does not correspond with the changed PIN.	If you have forgotten your changed PIN, please contact the manufacturer (for call number see under "Contact person").

Contact person



Siemens Service should only be contacted if problems develop with the device.
Your specialist dealer will be happy to answer any questions concerning unit operation.
Contact your network operator for questions concerning telephone connection.

Important notes on putting into service and operation

Overview: signal tones

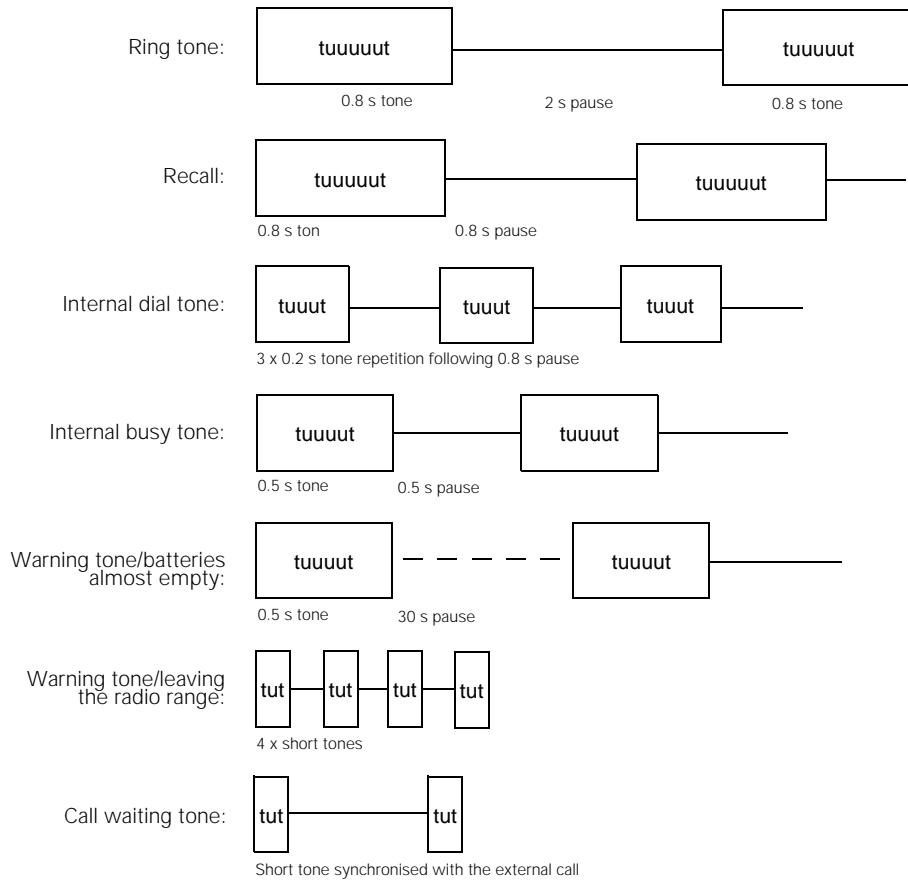

Special accessories

Special accessories

The devices described below are available from your specialist dealer.

Gigaset 1000TAE

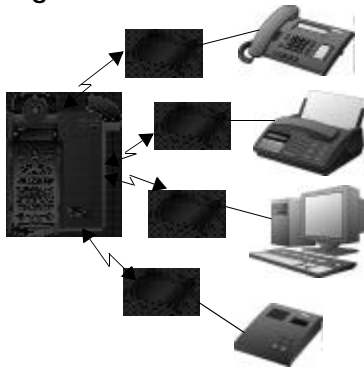

Cordless socket for operating corded terminals at base stations in the Gigaset 1000/2000 range.

In addition to mobile units, this cordless connecting box allows you to operate corded terminals, such as telephone, fax, answering machine or even a decoder (set-top box) for digital television at each Gigaset base station in the 1000/2000 range.

The advantage is not only the cordless operation of your terminals, but also the availability of internal Gigaset base station features, such as internal telephony.

Gigaset 2000L



When operating with several handsets, we recommend that you use additional charging units in order to guarantee continuous serviceability of the handset.

In addition to the handset, you can charge two reserve batteries in the charging unit.

Gigaset 2000C



Gigaset 2000C is equipped with a clear 4-line display and allows user-friendly user guidance.

Features that simplify telephoning:

- Directory for approx. 100 entries comprising names and call numbers.
- Baby alarm.
- Redial for the last five different call numbers.
- Illuminated display.

Special accessories

Gigaset 2000S



Gigaset 2000S offers the following features:

- 16-digit display for call numbers, operating statuses and battery charging status
- Speed-dialling memory for 10 call numbers
- Redial for last five call numbers
- En-bloc dialling with correction option

Gigaset 2000T



Gigaset 2000T is an enhanced telephone that supports handsfree talking/open listening and only requires a 230 V socket. It offers the same features as Gigaset 2000C as well as directory, short cut and DSS keys.

The Gigaset 2000T can be registered at all GAP-compatible bases and base stations in the Gigaset 2000/1000/910 ranges.

Headset





















The Gigaset 2000H headset (18 g) leaves your hands free when telephoning. Simply attach the headset to the Gigaset 2000C via the adapter supplied. This provides an additional listen-in option via the handset when the headset is in use.

To purchase the headset, contact your specialist dealer.

Quick reference guide handset Gigaset 2000C

Quick reference guide handset Gigaset 2000C

Switch handset to ON/OFF/PROTECTED:	
Accepting a call:	Call rings: remove the handset from the charging unit or press the Talk key  (automatic call acceptance can be set).
External call:	Press  , then dial the call number. Or:  dial call number, then press  .
Internal call:	Press INT . Then press 1..6 to dial internal call number.
Transferring an external call to an internal party:	Press INT . Then press 1..6 to dial internal call number. Press  before or after internal party answers.
Accepting an external call internally:	Call rings: remove the handset from the charging unit or press the Talk key  (automatic call acceptance can be set). Internal call: Press R to accept external queued call.
Internal consultation:	Press INT . Then press 1..6 to dial internal call number. Consult internal party. Press R to return to external call on hold.
Redial function:	Press  . Select desired number using  and then press  .
Accepting call waiting:	An internal call is in progress. You hear the call waiting tone. Press  ACCEPT . The external call is accepted and the internal call is cleared down.
Setting handset volume:	Press  . Select "Settings" and " Handset Volume " menu options and confirm. Regulate the volume using  or  and confirm by pressing  OK .
Activating open listening for internal subscribers:	An external call is in progress. Press  INT . Then press 1..6 to dial internal call number. The external call is placed on hold. Press  LIST. ON . The external call is resumed and the internal subscriber can listen in. Press  LIST. OFF to clear down the internal connection.

Index

A	Call list	20
Activating a short cut	Call number	
Additional menu, activating	displaying, CLIP	14
Alert character, number for ring priority	Call number checking	17
Alphanumeric keypad	Call number lock, activating/deactivating	65
Analog trunk	Call numbers	
Analog trunk/MSI, deleting	suppressing, CLIR	18
Automatic backlight, activate/deactivate	Callback from the call list	20
Automatic call acceptance	Calls	
Available memory, short cut	accepting (off-hook)	15
	connecting	28
	ending	26
	ending (on-hook)	16, 24
	external	15
	incoming	14
	internal	15
	outgoing	17
	transferring	28
	CLIP	14
	CLIR	18
	Collective call	71
	from a handset	25
	from the base station	25
	Connecting	28
	Consultation call	27
	Contact person	94
	Contents of the package	1
	Controlling devices	23
	D	
	DECT	91
	Deleting	
	analog trunk/MSI	49
	barred numbers	64
	directory	33
	emergency numbers	62
	entries from the directory	33
	Dial pulsing (DP)	4, 13
	Dialling	
	en-bloc dialling	17
	from the call list	20
	with call number checking	17
	with speed-dialling numbers	23
	with the directory	19
	Digits	41
	Directory	
	alphanumeric keypad	41
	copying	34
	copying call numbers	32, 33, 34
	creating/managing	30
	deleting	33
	deleting an entry	33
	editing an entry	32
	new entry	31
	saving an entry	31
	B	
Baby alarm, activating/deactivating		57
Barred numbers		
deleting		64
displaying		63
explanation		63
saving		63
Barred numbers, saving		67
Base code		
changing		43
explanations		43
if you forget your base code		44
Base station		
collective call		25
connecting		2
flashing for call list		20
flashing for call lists		20
individual settings		50
installation area		85
installation site		85
registering the handset		70
resetting to the factory defaults		45
ringer		50
ringer tone		51
ringer volume		50
Basic settings		43
base code		43
dial pulsing (DP)		4
dual-tone multifrequency		
signalling (DTMF)		4
PIN		43
signalling method		47
Battery warning beep, activating/ deactivating		55
Beeps, activating/deactivating		55
Best station, selecting		75
BZT approval		VIII
C		
Call allocation		71
Call allowance account		
setting up		66
Call duration display, activating/deactivating ..		60

Index

- Display with active locks 68
 Disposal 92
 DTMF (dual-tone multifrequency signalling) 4, 13, 23
- E**
 Emergency numbers
 deleting 62
 displaying 62
 explanation 61
 saving 62
 En-bloc dialling 17
 Ending a call 24
 Entry, copying 34, 82
 Error beep, activating/deactivating 56
- F**
 Factory default 45
 Fitting the carrying clip on the handset 88
 Functions, short cut 78
- G**
 GAP 91
- H**
 Handset
 activating 12
 collective call 25, 71
 deactivating 12
 listening in 29
 locking 67
 locks 67
 operating more than one 71
 PIN 44
 quick reference guide 98
 registering at the base station 70
 registering Gigaset 2000C
 at the base station 69
 ring priority 71
 saving barred numbers 67
 searching 25
 switching to protected mode 11
 Handset lock 67
 Handset operating modes 11, 45
 Handset volume, setting 52
- I**
 Incoming calls 14
 Individual settings
 base station 50
 Input function 37
 example 39
 input field 37
 letters, digits and special characters 41
 Internal call numbers, checking 26
- Internal function 25
 Internal trunk access 68
- K**
 Key confirmation beep, activating/
 deactivating 55
- L**
 Language, setting 58
 Letters 41
 Line busy 18
 Listen-in function 29
 Lock functions 61, 67
 Locks
 barred numbers 63
 base station 61
 call allowance account 66
 emergency numbers 61
 trunk access 66
 Locks, displays 68
- M**
 Maintenance notes 89
 Malfunctions, procedure in the case of 93
 Manual pause, inserting 18
 Memory, copying 82
 Menu
 display 7
 on-line 8
 overview 9
 Menu structure
 Gigaset 2000C handset 5
 Menu-driven operation 5
 Microphone, deactivating 27
 Mini-Western plug 2
 MSI 48
 Mute function 27
- N**
 New entry, directory 31
 Notes
 for users who wear hearing aids 86
 on keys V
 on symbols on the display VI
- O**
 Off-hook 15
 On-hook 15
 On-line menu 8
 Operating at more than one base station 74
 Operating in a telephone system 45
 Operating more than one handset 71
 Operating with
 Gigaset 1000C 89
 Gigaset 1000S 89
 Gigaset 2000S 89

Index

Outgoing calls, external	17	S	Safety precautions	VII	
Outward-restricted trunk access	66, 68	Searching for a handset	25	Secret numbers for redial, suppressing	18
Overview		Select services	59	Service	94
keys	V	Setting			
symbols on the display	VI	handset volume	52		
P		language	58		
Pause length according to analog trunk/MSI ..	49	ringer	53		
Pause, manual	18	Ringer tone	53		
Personal identification number	43	ringer volume	53		
PIN		Short cut	77		
changing	44	checking for duplicates	80		
explanations	43	copying an entry	82		
if you forget your PIN	44	deleting all entries	81		
Power supply connection cable	2	deleting an entry	80		
Power supply unit	2	displaying an entry	81		
Protected mode	11	displaying the available memory	81		
Putting into service		editing an entry	80		
important notes	85	explanation	77		
in 6 steps	1	function list	78		
Q		menu	77		
Quick reference guide	98	new entry	78		
R		starting	83		
Range warning beep, activating/deactivating	56	storing	79		
Range warning symbol	56	Signal tones	95		
Rechargeable batteries		Signalling method			
charging	3	at a telephone system	47		
inserting in the handset	3	checking	4, 13		
Redial	19	explanations	13		
administering	35	setting	13		
copying to the directory	36	Signalling methods			
deleting	35	setting	4		
displaying call numbers	36	Special accessories	96		
modifying	35	Special characters	41		
suppressing secret numbers	18	Speed-dialling numbers	23		
Registering		Starting a short cut	83		
at the base station	69	Station			
cordless connecting box	70	best, selecting	75		
Gigaset 2000C handset	69	preferred, defining	75		
preparing the base station	69	station selection	75		
Registering the handset	70	Synchronisation beep, activating/ deactivating	57		
Ring priority	71	T			
Ringer		Technical data	VI, 91		
base station	50	Telephone connection cable	2		
number of rings for ring priority	73	Telephone socket, assignment	90		
Ringer settings	53	Telephone system	47, 48		
Ringer tone		Third-party use	92		
base station	51	Transferring, calls	28		
Ringer tone, setting	53	Troubleshooting	93		
Ringer volume		Trunk access	66		
base station	50				
Ringer volume, setting	53				

Index

U

Unrestricted trunk access 66

Users

calling external parties 17

making internal calls 25

no answer 18

W

Warranty 92

Issued by Private Communication System Group
Hofmannstraße 51, D-81359 München

Siemens AG
<http://www.siemens.de>

© Siemens AG 1998. All rights reserved.
Subject to availability.
Right of modification reserved.

Ref. no.: A30852-X1106-B307-1-7619
Printed in Germany
06/98