

SIEMENS

SIMATIC NET

Industrial Ethernet Switches SCALANCE X-200

Operating Instructions

Preface

Safety notices	1
Network topologies / media redundancy	2
Product properties	3
Installation	4
Connection	5
Configuration / diagnostics using remote mechanisms	6
IRT technology with SCALANCE X-200	7
PROFINET IO functionality	8
Approvals and markings	9
Technical specifications	10
Accessories	11
References	12
Dimension drawings	13

Legal information

Warning notice system

This manual contains notices you have to observe in order to ensure your personal safety, as well as to prevent damage to property. The notices referring to your personal safety are highlighted in the manual by a safety alert symbol, notices referring only to property damage have no safety alert symbol. These notices shown below are graded according to the degree of danger.

⚠ DANGER
indicates that death or severe personal injury will result if proper precautions are not taken.
⚠ WARNING
indicates that death or severe personal injury may result if proper precautions are not taken.
⚠ CAUTION
with a safety alert symbol, indicates that minor personal injury can result if proper precautions are not taken.
CAUTION
without a safety alert symbol, indicates that property damage can result if proper precautions are not taken.
NOTICE
indicates that an unintended result or situation can occur if the relevant information is not taken into account.

If more than one degree of danger is present, the warning notice representing the highest degree of danger will be used. A notice warning of injury to persons with a safety alert symbol may also include a warning relating to property damage.

Qualified Personnel

The product/system described in this documentation may be operated only by **personnel qualified** for the specific task in accordance with the relevant documentation, in particular its warning notices and safety instructions. Qualified personnel are those who, based on their training and experience, are capable of identifying risks and avoiding potential hazards when working with these products/systems.

Proper use of Siemens products

Note the following:

⚠ WARNING
Siemens products may only be used for the applications described in the catalog and in the relevant technical documentation. If products and components from other manufacturers are used, these must be recommended or approved by Siemens. Proper transport, storage, installation, assembly, commissioning, operation and maintenance are required to ensure that the products operate safely and without any problems. The permissible ambient conditions must be complied with. The information in the relevant documentation must be observed.

Trademarks

All names identified by ® are registered trademarks of Siemens AG. The remaining trademarks in this publication may be trademarks whose use by third parties for their own purposes could violate the rights of the owner.

Disclaimer of Liability

We have reviewed the contents of this publication to ensure consistency with the hardware and software described. Since variance cannot be precluded entirely, we cannot guarantee full consistency. However, the information in this publication is reviewed regularly and any necessary corrections are included in subsequent editions.

Preface

Overview of the SCALANCE X product family

The SCALANCE X-200 product family is part of the SCALANCE X product family. Below, you will find a brief overview of this product family.

The SCALANCE X family comprises various product lines that complement each other and that are carefully tuned to specific automation tasks.

SCALANCE X005 and XB000 line, entry level

Unmanaged switch with five twisted-pair ports and optical diagnostics on the device for use in machine and system islands.

SCALANCE X-100 unmanaged

Switches with redundant power supply and signaling contact for use in applications in the immediate vicinity of machinery.

A variety of device variants with different numbers and designs of electrical and optical ports.

SCALANCE X-200 and XF-200 managed

The devices of the SCALANCE X-200 product line can be used universally – in machine-level applications as well as in networked plant sections, in electrical or electrical/optical linear, ring or star structures and with single mode up to 26 km.

Devices with a high degree of protection (IP65/67) can be installed outside the control cabinet.

Configuration and remote diagnostics functions are integrated in the STEP 7 engineering tool. This increases plant availability and has advantages during the engineering, commissioning and operational phases. The devices of the SCALANCE X-200 line also have standard remote diagnostics functions (SNMP, Web server).

The only difference between the devices of the SCALANCE XF-200 product line and the SCALANCE X-200 product is the flatter construction.

SCALANCE X-200IRT and XF204IRT managed

In subsystem networks with hard real-time requirements (real time and isochronous real time), the SCALANCE X-200IRT switches can be used. They include the enhanced real-time controller ERTEC. By using the "cut through" switching mechanism, the switches are ideal to meet the real-time requirements of PROFINET.

The standard data transmission (TCP/IP) can take place on the same network. Dual network structures are therefore not necessary.

Network installation, configuration and diagnostics involves the same procedures as for the other devices of the SCALANCE X-200 product line.

The only difference between the SCALANCE XF204IRT and the SCALANCE X-204IRT is the shape.

SCALANCE X-200 IRT PRO managed

In terms of functionality, the SCALANCE X200 IRT PRO switches are the same as the SCALANCE X-200 IRT managed switches listed above. The switch with degree of protection IP65/IP67 is designed for use outside a cabinet and has PROFINET-compliant connector technology (RJ-45 in compliance with IEC 61076-3-117 for X204 IRT PRO or SC RJ in compliance with IEC 61754-24-2 for X202-2P IRT PRO).

SCALANCE X-300

The main areas of application are high-speed plant networks with an interface to the Enterprise network. The SCALANCE X-300 managed plus product line combines the firmware functionality of the SCALANCE X-400 product line (without routing functions at the layer 3 level) with the compact design of the SCALANCE X-200 product line. The "managed plus" attribute means both enhanced management functions compared with the SCALANCE X-200 and enhanced firmware functionality.

SCALANCE X-400 modular

The switches of the SCALANCE X-400 product series are suitable for the construction of optical/electrical linear, ring and star topologies (10/100/1000 Mbps) for high-speed systems.

They have a modular structure, in which media modules and extender modules can be inserted in the switch as required. These expansions make as many as eight electrical and eight optical ports additionally available.

By supporting IT standards, for example, VLAN, RSTP, Layer 3, automation networks can be seamlessly connected to existing corporate networks.

The SCALANCE X-400 switches are ideally suited, for example, for process control systems such as PCS 7.

What is possible?

The devices of the SCALANCE X-200 product lines allow the cost-effective installation of Industrial Ethernet linear (bus), star and ring structures with switching functionality.

By using the "cut through" switching mechanism, the SCALANCE X-200IRT switches are ideal to meet the real-time requirements of PROFINET.

Cut through is not possible

- between a port set to 10 Mbps and a port set to 100 Mbps
- when two packets are to be sent at the same time on one port.

One particular advantage of the SCALANCE X-200IRT switches in PROFINET networks is the integrated ERTEC. This gives priority to PROFINET packets when forwarding.

 **WARNING**

When used under hazardous conditions (zone 2), the devices of the SCALANCE X-100 and SCALANCE X-200 product lines must be installed in an enclosure.

To comply with ATEX95 (EN 60079-15), this enclosure must meet the requirements of at least IP54 in compliance with EN 60529.

WARNING – EXPLOSION HAZARD: DO NOT DISCONNECT EQUIPMENT WHEN A FLAMMABLE OR COMBUSTIBLE ATMOSPHERE IS PRESENT.

Note

The specified approvals apply only when the corresponding mark is printed on the product.

Purpose of the Operating Instructions

These operating instructions support you when commissioning networks with the devices of the product line SCALANCE X-200.

Validity of the Operating Instructions

These operating instructions are valid for the following devices:

SIMATIC NET SCALANCE XF204	6GK5204-0BA00-2AF2
SIMATIC NET SCALANCE X208	6GK5208-0BA10-2AA3
SIMATIC NET SCALANCE XF208	6GK5208-0BA00-2AF2
SIMATIC NET SCALANCE X216	6GK5216-0BA00-2AA3
SIMATIC NET SCALANCE X224	6GK5224-0BA00-2AA3
SIMATIC NET SCALANCE X204-2	6GK5204-2BB10-2AA3
SIMATIC NET SCALANCE X204-2TS	6GK5204-2BB10-2CA2
SIMATIC NET SCALANCE XF204-2	6GK5204-2BC00-2AF2
SIMATIC NET SCALANCE X206-1	6GK5206-1BB10-2AA3
SIMATIC NET SCALANCE XF206-1	6GK5206-1BC00-2AF2
SIMATIC NET SCALANCE X212-2	6GK5212-2BB00-2AA3
SIMATIC NET SCALANCE X204-2LD	6GK5204-2BC10-2AA3
SIMATIC NET SCALANCE X206-1LD	6GK5206-1BC10-2AA3
SIMATIC NET SCALANCE X212-2LD	6GK5212-2BC00-2AA3
SIMATIC NET SCALANCE X202-2IRT	6GK5202-2BB00-2BA3
SIMATIC NET SCALANCE X204IRT	6GK5204-0BA00-2BA3
SIMATIC NET SCALANCE XF204IRT	6GK5204-0BA00-2BF2
SIMATIC NET SCALANCE X204 IRT PRO	6GK5204-0JA00-2BA6
SIMATIC NET SCALANCE X202-2P IRT PRO	6GK5202-2JR00-2BA6

SIMATIC NET SCALANCE X201-3P IRT PRO	6GK5201-3JR00-2BA6
SIMATIC NET SCALANCE X202-2P IRT	6GK5202-2BH00-2BA3
SIMATIC NET SCALANCE X201-3P IRT	6GK5201-3BH00-2BA3
SIMATIC NET SCALANCE X200-4P IRT	6GK5200-4AH00-2BA3

Names of the devices in these operating instructions

The descriptions in these operating instructions always apply to the devices of the SCALANCE X-200 product line listed under "Validity of the Operating Instructions" in this document unless the description relates to a specific device of the product line. In the remainder of the description, the devices are called **IE Switch X-200** or **X-200 IE switches**.

Further documentation

The "SIMATIC NET Industrial Ethernet Twisted Pair and Fiber Optic Networks" manual contains additional information on other SIMATIC NET products that you can operate along with the devices of the SCALANCE X-200 product line in an Industrial Ethernet network.

Finding information

To help you to find the information you require more quickly, the manual includes not only the table of contents but also the following sections in the Appendix:

- Index
- Glossary

Audience

These operating instructions are intended for persons involved in commissioning networks in which IE switches are used.

Standards and approvals

The devices of the SCALANCE X-200 product line meet the requirements for the CE mark. You will find detailed information in the section "Approvals and markings" in these operating instructions.

SIMATIC NET glossary

Explanations of the specialist terms used in this documentation can be found in the SIMATIC NET glossary.

You will find the SIMATIC NET glossary here:

- SIMATIC NET Manual DVD
The DVD ships with most SIMATIC NET products.
- On the Internet under the following entry ID:
50305045 (<http://support.automation.siemens.com/WW/view/en/50305045>)

Table of contents

	Preface	3
1	Safety notices	13
1.1	Important notes on using the device	13
2	Network topologies / media redundancy	17
2.1	Network topologies	17
2.2	Options of media redundancy	22
2.3	Media redundancy in ring topologies	23
2.4	MRP	25
2.5	MRPD.....	27
2.6	HSR.....	28
2.7	Redundant coupling of network segments.....	29
3	Product properties	31
3.1	Overview of the product characteristics	31
3.2	Components of the product.....	33
3.3	Unpacking and checking	34
3.4	SCALANCE XF204	35
3.4.1	SCALANCE XF204 product characteristics	35
3.4.2	SCALANCE XF204 TP ports	36
3.5	SCALANCE X208	38
3.5.1	SCALANCE X208 product characteristics	38
3.5.2	SCALANCE X208 TP ports.....	39
3.6	SCALANCE XF208	41
3.6.1	SCALANCE XF208 product characteristics	41
3.6.2	SCALANCE XF208 TP ports	42
3.7	SCALANCE X216	44
3.7.1	SCALANCE X216 product characteristics	44
3.7.2	SCALANCE X216 TP ports.....	45
3.8	SCALANCE X224	47
3.8.1	SCALANCE X224 product characteristics	47
3.8.2	SCALANCE X224 TP ports.....	48
3.9	SCALANCE X204-2 / SCALANCE X204-2TS	50
3.9.1	SCALANCE X204-2 / SCALANCE X204-2TS product features	50
3.9.2	SCALANCE X204-2 / SCALANCE X204-2TS TP interfaces	51
3.9.3	SCALANCE X204-2 / SCALANCE X204-2TS FO interfaces	53
3.10	SCALANCE XF204-2.....	54
3.10.1	SCALANCE XF204-2 product characteristics.....	54

3.10.2	SCALANCE XF204-2 TP ports	55
3.10.3	SCALANCE XF204-2 FO ports	57
3.11	SCALANCE X206-1	58
3.11.1	SCALANCE X206-1 product characteristics	58
3.11.2	SCALANCE X206-1 TP ports	59
3.11.3	SCALANCE X206-1 FO ports	61
3.12	SCALANCE XF206-1	62
3.12.1	SCALANCE XF206-1 product characteristics	62
3.12.2	SCALANCE XF206-1 TP ports	63
3.12.3	SCALANCE XF206-1 FO ports	65
3.13	SCALANCE X212-2	66
3.13.1	SCALANCE X212-2 product characteristics	66
3.13.2	SCALANCE X212-2 TP ports	67
3.13.3	SCALANCE X212-2 FO ports	69
3.14	SCALANCE X204-2LD	70
3.14.1	SCALANCE X204-2LD product characteristics	70
3.14.2	SCALANCE X204-2LD TP ports	71
3.14.3	SCALANCE X204-2LD TP ports	73
3.15	SCALANCE X206-1LD	75
3.15.1	SCALANCE X206-1LD product characteristics	75
3.15.2	SCALANCE X206-1LD TP ports	76
3.15.3	SCALANCE X206-1LD FO ports	78
3.16	SCALANCE X212-2LD	80
3.16.1	SCALANCE X212-2LD product characteristics	80
3.16.2	SCALANCE X212-2LD TP ports	81
3.16.3	SCALANCE X212-2LD FO ports	83
3.17	SCALANCE X202-2IRT	85
3.17.1	SCALANCE X202-2IRT product characteristics	85
3.17.2	SCALANCE X202-2IRT TP ports	86
3.17.3	SCALANCE X202-2IRT FO ports	88
3.18	SCALANCE X204IRT	89
3.18.1	SCALANCE X204IRT product characteristics	89
3.18.2	SCALANCE X204IRT TP ports	90
3.19	SCALANCE XF204IRT	92
3.19.1	SCALANCE XF204IRT product characteristics	92
3.19.2	SCALANCE XF204IRT TP ports	93
3.20	SCALANCE X204 IRT PRO	95
3.20.1	SCALANCE X204 IRT PRO product characteristics	95
3.20.2	SCALANCE X204 IRT PRO TP ports	96
3.21	SCALANCE X202-2P IRT PRO	98
3.21.1	SCALANCE X202-2P IRT PRO product characteristics	98
3.21.2	SCALANCE X202-2P IRT PRO TP ports	99
3.21.3	SCALANCE X202-2P IRT PRO FO ports	101
3.22	SCALANCE X201-3P IRT PRO	102
3.22.1	SCALANCE X201-3P IRT PRO product characteristics	102
3.22.2	SCALANCE X201-3P IRT PRO TP interfaces	103

3.22.3	SCALANCE X201-3P IRT PRO FO interfaces	105
3.23	SCALANCE X202-2P IRT	106
3.23.1	SCALANCE X202-2P IRT product characteristics	106
3.23.2	SCALANCE X202-2P IRT TP ports	107
3.23.3	SCALANCE X202-2P IRT FO ports	109
3.24	SCALANCE X201-3P IRT	110
3.24.1	SCALANCE X201-3P IRT product characteristics	110
3.24.2	SCALANCE X201-3P IRT TP ports	111
3.24.3	SCALANCE X201-3P IRT FO ports	113
3.25	SCALANCE X200-4P IRT	114
3.25.1	SCALANCE X200-4P IRT product characteristics	114
3.25.2	SCALANCE X200-4P IRT FO ports	115
3.26	C-PLUG (configuration plug)	116
3.27	Button	119
3.28	Displays	120
3.28.1	Fault indicator (red LED)	120
3.28.2	Power display	121
3.28.3	Port status indicator (green/yellow LEDs)	123
3.28.4	Redundancy manager indicator (green LED)	124
3.28.5	Standby functions (yellow LED)	125
3.28.6	FOC diagnostic display (yellow LED)	126
3.28.7	LED display during startup	127
4	Installation	129
4.1	Installation	129
4.2	Installation on a DIN rail	131
4.3	Installation on a standard rail	132
4.4	Wall mounting	133
5	Connection	135
5.1	Power supply	135
5.2	Signaling contact	140
5.3	Grounding	142
5.4	Fitting the IE FC RJ-45 Plug 180	143
5.5	Fitting the IE RJ 45 Plug Pro and IE SC RJ Plug Pro	145
6	Configuration / diagnostics using remote mechanisms	147
6.1	Assignment of an IP address	147
6.1.1	Introduction	147
6.1.2	Configuration with the Primary Setup Tool	147
6.1.2.1	Configuration with the Primary Setup Tool	147
6.1.2.2	Installing the Primary Setup Tool	148
6.1.2.3	The DLC protocol	149
6.1.2.4	Installing the DLC protocol	150
6.1.2.5	Working with the Primary Setup Tool	150
6.1.2.6	Configuring a module	151

6.1.3	Configuration with DHCP	154
6.2	Updating the firmware with the boot loader	155
6.3	Configuration using Web Based Management (WBM) and Command Line Interface (CLI)	156
6.3.1	Principle of Web Based Management.....	157
6.3.2	LED simulation.....	159
6.3.3	Working with WBM.....	159
6.3.4	Command Line Interface (CLI).....	161
6.3.5	WBM menus.....	163
6.3.5.1	Management menus - the Start menu	163
6.3.5.2	The "System" WBM menu.....	164
6.3.5.3	"System C-PLUG" WBM menu	166
6.3.5.4	The "System I&M" WBM menu	169
6.3.5.5	The "System Restart & Defaults" WBM menu	170
6.3.5.6	The "System Save & Load HTTP" WBM menu	172
6.3.5.7	The "System Save & Load TFTP" WBM menu.....	174
6.3.5.8	The "System Version Numbers" WBM menu.....	177
6.3.5.9	The "System Passwords" WBM menu.....	179
6.3.5.10	The "System Select/Set Button" WBM menu.....	180
6.3.5.11	The "System Event Log" WBM menu	180
6.3.5.12	The "X200" WBM menu	182
6.3.5.13	The "X200 Fault Mask" WBM menu	183
6.3.5.14	The "X200 Ring" WBM menu.....	185
6.3.5.15	The "X200 Standby" WBM menu.....	190
6.3.5.16	The "Agent" WBM menu	192
6.3.5.17	The "Ping" WBM menu	194
6.3.5.18	The "Agent SNMP Config" WBM menu	195
6.3.5.19	The "Agent SNMP Trap Config" WBM menu.....	197
6.3.5.20	The "Agent SNMP Config Groups" WBM menu	198
6.3.5.21	The "Agent SNMP Config Group Table" WBM menu	200
6.3.5.22	The "Agent SNMP Config Users" WBM menu.....	202
6.3.5.23	The "Agent SNMP Config User Table" WBM menu.....	203
6.3.5.24	The "Agent Event Config" WBM menu	204
6.3.5.25	The "Agent E-Mail Config" WBM menu	207
6.3.5.26	The "Agent Time Config" WBM menu.....	209
6.3.5.27	The "Switch" WBM menu	211
6.3.5.28	The "Switch Ports" WBM menu.....	213
6.3.5.29	The "Switch Port Diags" WBM menu	216
6.3.5.30	The "Switch FDB" WBM menu.....	217
6.3.5.31	The "Switch ARP Table" WBM menu	219
6.3.5.32	The "Switch LLDP" WBM menu	219
6.3.5.33	The "Switch DCP" WBM menu	222
6.3.5.34	The "Switch POF" WBM menu.....	224
6.3.5.35	The "Loop Detection Config" WBM menu.....	226
6.3.5.36	The "Statistics" WBM menu	230
6.3.5.37	The "Statistics Packet Size" WBM menu	232
6.3.5.38	The "Statistics Packet Type" WBM menu	234
6.3.5.39	The "Statistics Packet Error" WBM menu	236
6.3.6	SNMP.....	238
6.3.6.1	Configuration and diagnostics over SNMP	238
6.3.6.2	MIB variables	239
7	IRT technology with SCALANCE X-200.....	243

8	PROFINET IO functionality	245
8.1	Configuring with PROFINET IO	245
8.2	Settings in HW Config	249
8.2.1	Configuring alarms	249
8.2.2	Configuring MRP	250
8.2.3	Configuring the topology	254
8.3	HSR configuration in PROFINET IO	256
8.4	Structure of the data records	257
9	Approvals and markings	263
10	Technical specifications	275
11	Accessories	285
12	References	287
13	Dimension drawings	289
	Index.....	295

Safety notices

1.1 Important notes on using the device

Safety notices on the use of the devices

The following safety notices must be adhered to when setting up and operating the device and during all work relating to it such as installation, connecting up, replacing devices or opening the device.

General notices

 WARNING
Safety extra low voltage <p>The equipment is designed for operation with Safety Extra-Low Voltage (SELV) by a Limited Power Source (LPS). (This does not apply to 100 V...240 V devices.)</p> <p>This means that only SELV / LPS complying with IEC 60950-1 / EN 60950-1 / VDE 0805-1 must be connected to the power supply terminals. The power supply unit for the equipment power supply must comply with NEC Class 2, as described by the National Electrical Code (r) (ANSI / NFPA 70).</p> <p>There is an additional requirement if devices are operated with a redundant power supply:</p> <p>If the equipment is connected to a redundant power supply (two separate power supplies), both must meet these requirements.</p>

 WARNING
Opening the device <p>DO NOT OPEN WHEN ENERGIZED.</p>

General notices on use in hazardous areas

 WARNING
Risk of explosion when connecting or disconnecting the device <p>EXPLOSION HAZARD</p> <p>DO NOT CONNECT OR DISCONNECT EQUIPMENT WHEN A FLAMMABLE OR COMBUSTIBLE ATMOSPHERE IS PRESENT.</p>

1.1 Important notes on using the device

 **WARNING**

Replacing components

EXPLOSION HAZARD

SUBSTITUTION OF COMPONENTS MAY IMPAIR SUITABILITY FOR CLASS I, DIVISION 2 OR ZONE 2.

 **WARNING**

Requirements for the cabinet/enclosure

When used in hazardous environments corresponding to Class I, Division 2 or Class I, Zone 2, the device must be installed in a cabinet or a suitable enclosure.

 **WARNING**

WARNING - EXPLOSION HAZARD -

DO NOT DISCONNECT WHILE CIRCUIT IS LIVE UNLESS AREA IS KNOWN TO BE NON-HAZARDOUS.

 **WARNING**

Restricted area of application

This equipment is suitable for use in Class I, Division 2, Groups A, B, C and D or non-hazardous locations only.

 **WARNING**

Restricted area of application

This equipment is suitable for use in Class I, Zone 2, Group IIC or non-hazardous locations only.

General notices on use in hazardous areas according to ATEX

 **WARNING**

Requirements for the cabinet/enclosure

To comply with EU Directive 94/9 (ATEX95), this enclosure must meet the requirements of at least IP54 in compliance with EN 60529.

The fiber-optic bus connections labeled SCALANCE X-200/XF-200 (see type plate) may also be led through a hazardous area zone1 (see also Approvals and markings (Page 263), section "Explosion Protection Directive (ATEX)").

 **WARNING**

Suitable cables for temperatures in excess of 70 °C

If the cable or conduit entry point exceeds 70 °C or the branching point of conductors exceeds 80 °C, special precautions must be taken. If the equipment is operated in an air ambient in excess of 50 °C to 70 °C, only use cables with admitted maximum operating temperature of at least 80 °C.

 **WARNING**

Protection against transient voltage surges

Provisions shall be made to prevent the rated voltage from being exceeded by transient voltage surges of more than 40%. This criterion is fulfilled, if supplies are derived from SELV (Safety Extra-Low Voltage) only.

See also

Approvals and markings (Page 263)

Network topologies / media redundancy

2.1 Network topologies

Switching technology allows extensive networks to be set up with numerous nodes and simplifies network expansion.

Which topologies can be implemented?

Bus, ring, or star topologies can be implemented with the X-200 IE switches.

Note

Make sure that the maximum permitted cable lengths for the relevant devices are not exceeded. You will find the permitted cable lengths in the technical specifications.

For example, with the SCALANCE X202-2P IRT, X201-3P IRT, X200P IRT, X202-2P IRT PRO and X201-3P IRT PRO only 50 m POF or 100 m HCS cable may be used.

Bus topology

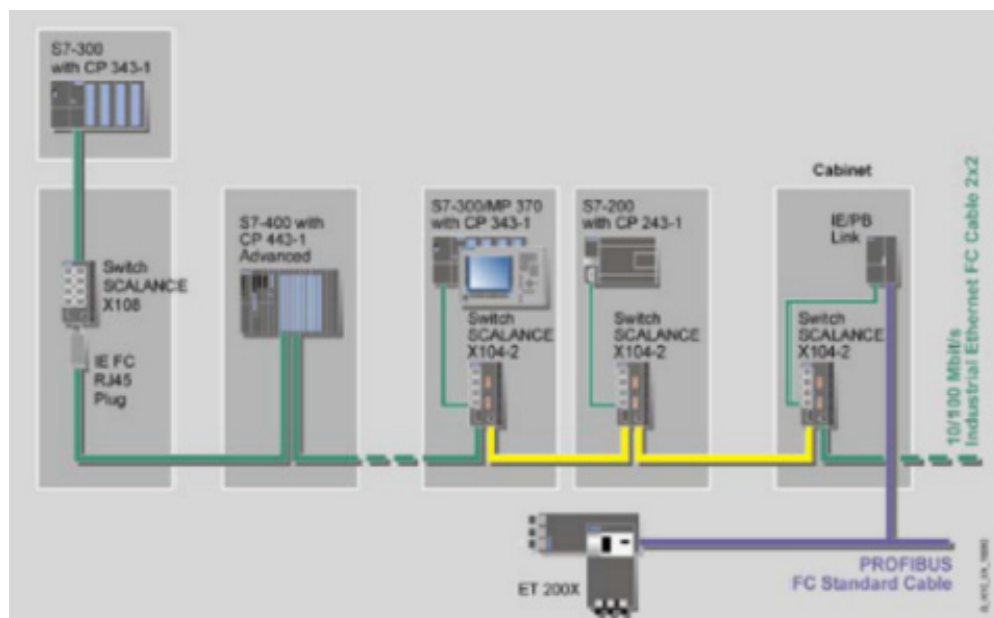

Figure 2-1 Electrical / optical linear topology with SCALANCE X-100

Star topology

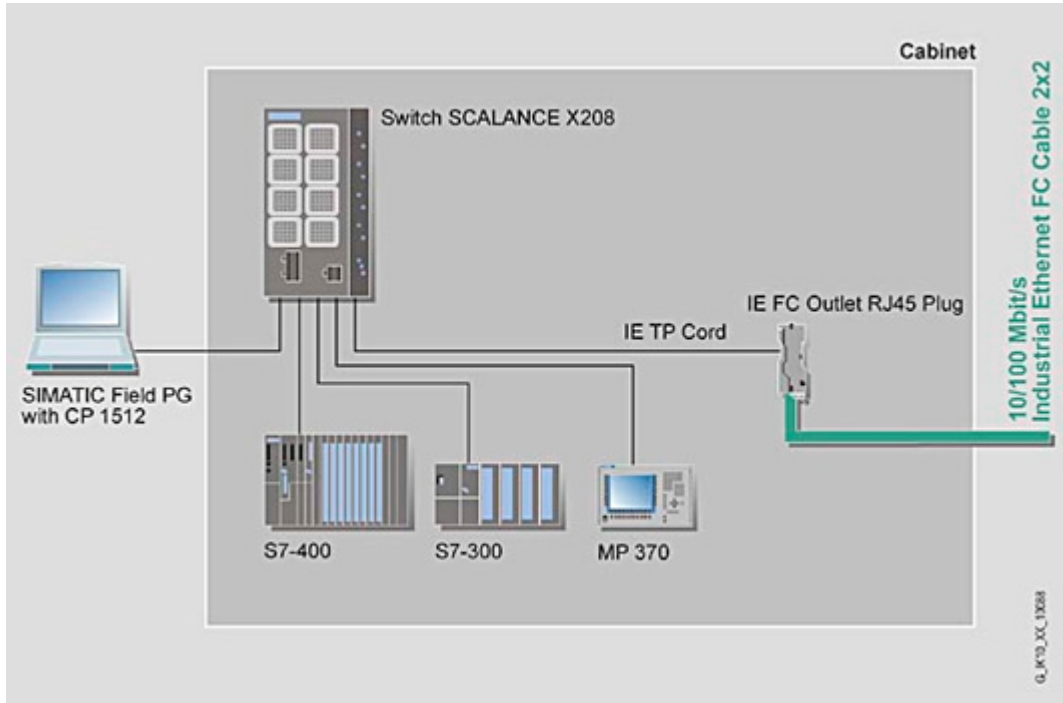

Figure 2-2 Electrical star topology. Example with SCALANCE X208

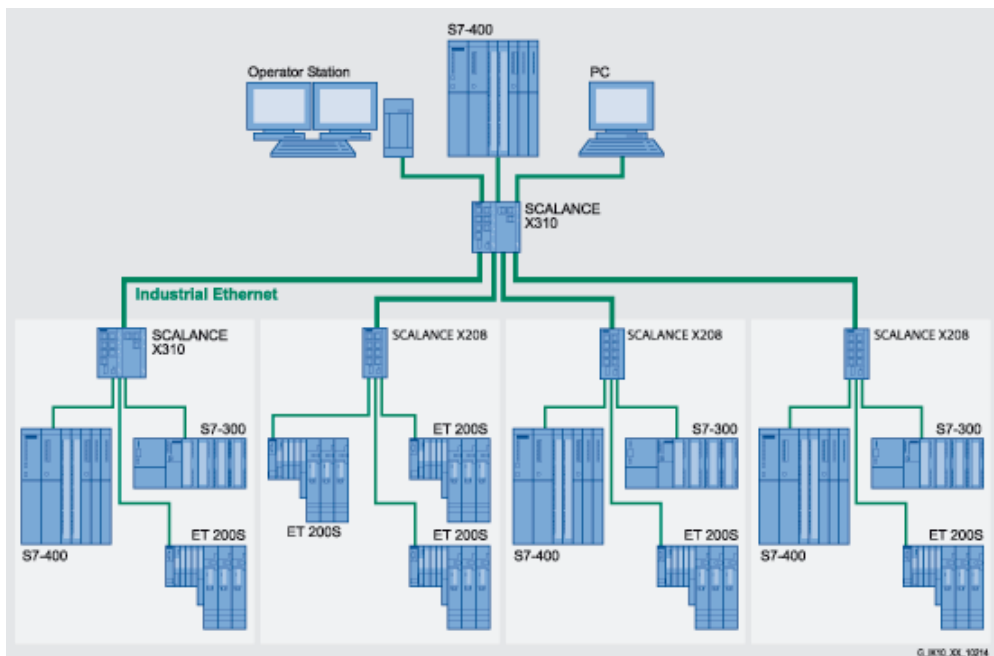

Figure 2-3 Star topology with X310 and X208

Ring topology

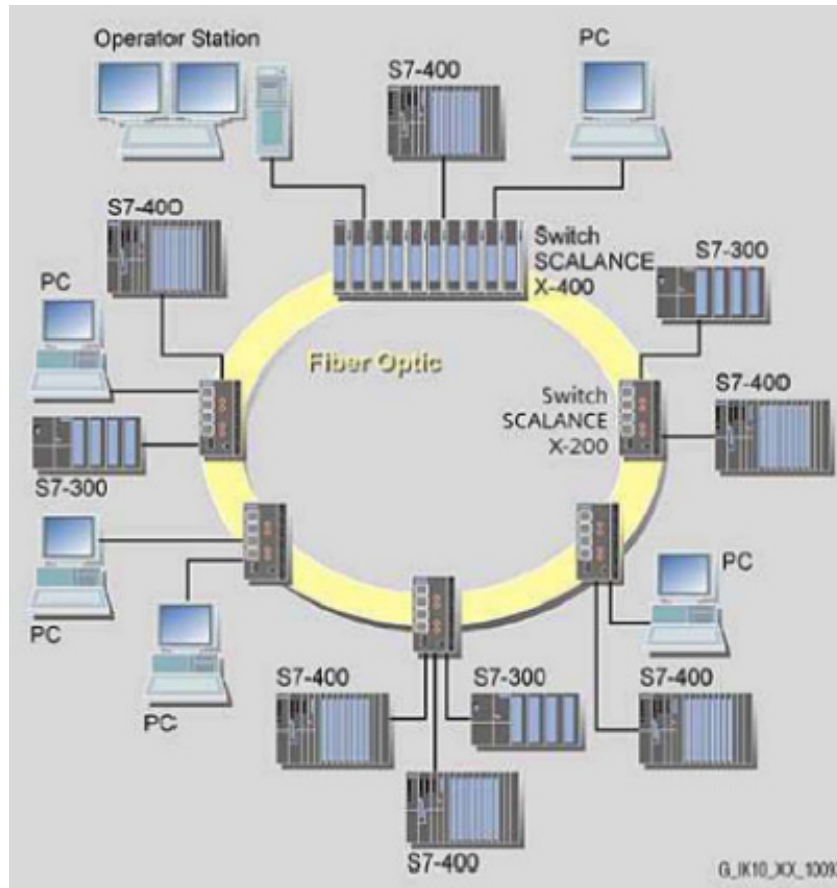

Figure 2-4 Optical ring topology, example with SCALANCE X-200 and SCALANCE X-400 as redundancy manager

2.1 Network topologies

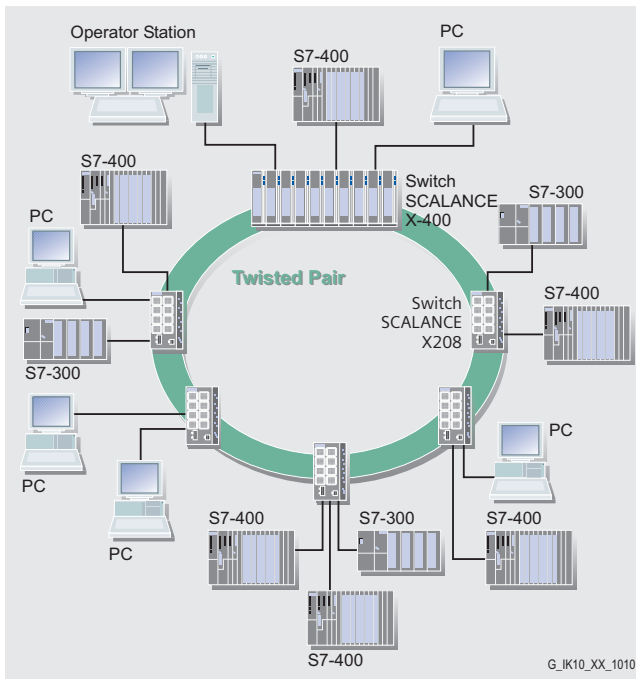

Figure 2-5 Electrical ring topology, example with SCALANCE X208 and SCALANCE X-400 as redundancy manager

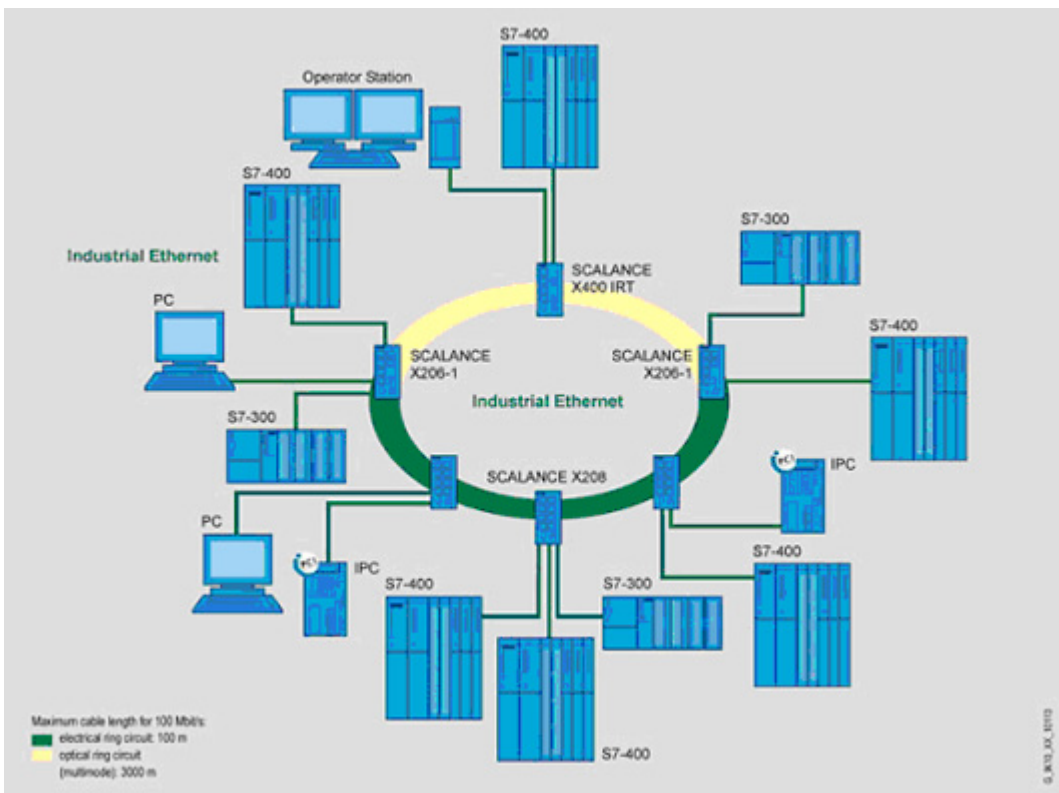

Figure 2-6 Ring topology with electrical and optical ring links, example with SCALANCE X206-1, SCALANCE X208, and SCALANCE X204-2 as redundancy manager

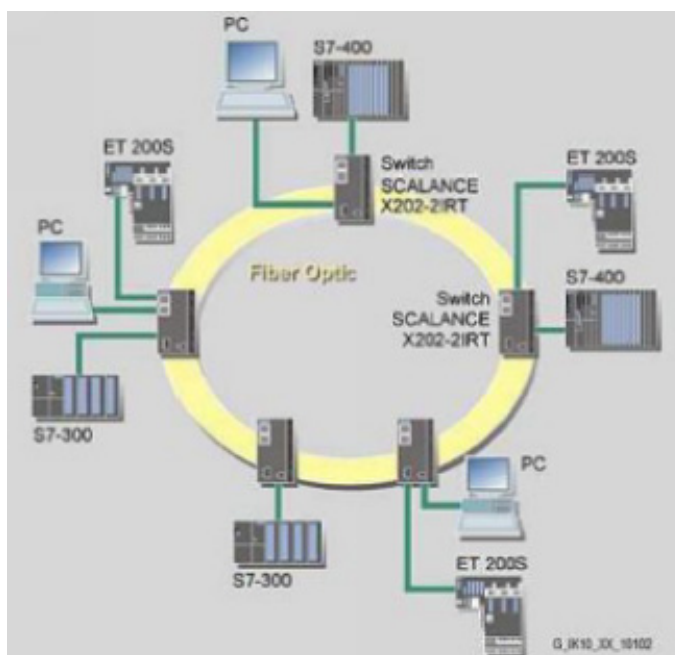

Figure 2-7 Ring topology with optical ring, example with SCALANCE X202-2IRT

To increase availability, optical or electrical bus topologies made up of X-200 IE Switches with an IE Switch X-200, IE Switch X-300, SCALANCE X414-3E, OSM version 2 or ESM version 2 configured as a redundancy manager can be closed to form a ring. The IE Switches X-200 are first connected over their ring ports to form a bus. The two ends of the bus are closed to form a ring by a switch operating in the redundancy manager mode. Devices of the IE switches X-200, X-300, X-400 product families, or OSMs / ESMs can be used as the redundancy manager. When a switch is used as the redundancy manager, the ring ports are isolated from each other if the network is operating problem-free.

The IE Switch X-200, IE Switch X-300, SCALANCE X414-3E, or OSM / ESM operating in the redundancy manager mode monitors the connected bus over its ring ports and switches the ring ports through if there is an interruption on the connected bus; in other words, it restores a functioning bus over this substitute path. Reconfiguration takes place within 0.3 seconds.

As soon as the problem has been eliminated, the original topology is restored; in other words, the ring ports in the redundancy manager are once again disconnected from each other.

2.2 Options of media redundancy

There are various options available to increase the network availability of an Industrial Ethernet network with optical or electrical linear bus topologies:

- Mesh networks
- Parallel connection of transmission paths
- Closing a linear bus topology to form a ring topology

2.3 Media redundancy in ring topologies

Structure of a ring topology

Nodes in a ring topology can be external switches and/or the integrated switches of communications modules.

To set up a ring topology with media redundancy, you bring together the two free ends of a linear bus topology in one device. Closing the linear bus topology to form a ring is achieved with two ports (ring ports) of a device in the ring. This device is the redundancy manager. All other devices in the ring are redundancy clients.

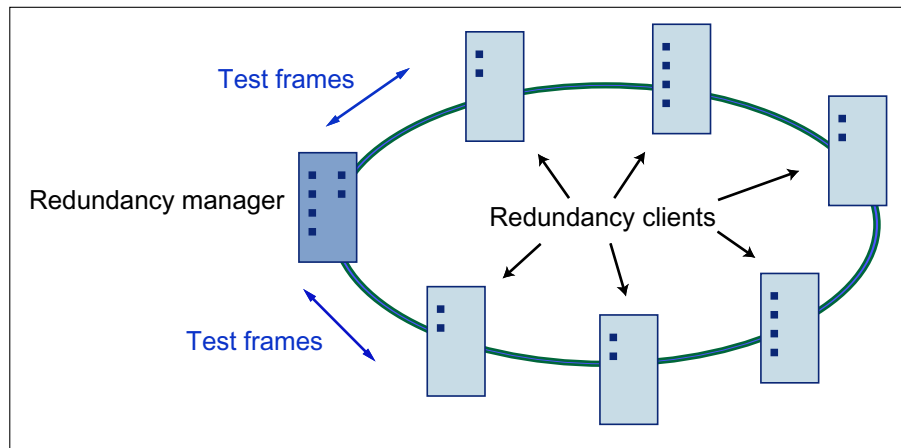

Figure 2-8 Devices in a ring topology with media redundancy

The two ring ports of a device are the ports that establish the connection to its two neighboring devices in the ring topology. The ring ports are selected and set in the configuration of the relevant device. On the S7 Ethernet CP modules, the ring ports are indicated by an "R" after the port number.

Note

Create the configuration of the devices to be connected to form a ring before you close the ring.

How media redundancy works in a ring topology

When using media redundancy, the data paths between the individual devices are reconfigured if the ring is interrupted at one point. Following reconfiguration of the topology, the devices can once again be reached in the resulting new topology.

In the redundancy manager, the 2 ring ports are disconnected from each other if the network is uninterrupted. This prevents circulating data frames. In terms of data transmission, the ring topology is a linear bus topology. The redundancy manager monitors the ring topology. It does this by sending test frames both from ring port 1 and ring port 2. The test frames run round the ring in both directions until they arrive at the other ring port of the redundancy manager.

2.3 Media redundancy in ring topologies

An interruption of the ring can be caused by loss of the connection between two devices or by failure of a device in the ring.

If the test frames of the redundancy manager no longer arrive at the other ring port, the redundancy manager connects its two ring ports. This substitute path once again restores a functioning connection between all remaining devices in the form of a linear bus topology.

The time between the ring interruption and restoration of a functional linear topology is known as the reconfiguration time.

As soon as the interruption is eliminated, the original transmission paths are established again, the two ring ports of the redundancy manager are disconnected and the redundancy clients informed of the change. The redundancy clients then use the new paths to the other devices.

If the redundancy manager fails, the ring becomes a functional linear bus.

Media redundancy methods

The following media redundancy methods are supported by SIMATIC NET products for ring topologies:

- HSR (High Speed Redundancy)
Reconfiguration time: 0.3 seconds
- MRP (Media Redundancy Protocol)
Reconfiguration time: 0.2 seconds
Automatic configuration of the ring

The mechanisms of these methods are similar. With both methods, up to 50 devices can participate in the ring. HSR and MRP cannot be used in the ring at the same time.

If you configure your plant using STEP 7, you can only select MRP as the media redundancy method.

If you configure your devices with Web Based Management, CLI or SNMP, you can choose either HSR or MRP.

Media redundancy with IRT

For ring topologies in which MRP is activated, the "MRPD" function is activated automatically for IRT devices capable of IRT, if this is supported by the device.

- MRPD (Media Redundancy with Path Duplication)

For use only with SCALANCE X-200IRT

This procedure allows redundancy with IRT. You will find details in the section MRPD (Page 27).

2.4 MRP

The "MRP" method conforms to the Media Redundancy Protocol (MRP) specified in the standard IEC 62439-2 Edition 1.0 2010-02.

The reconfiguration time after an interruption of the ring is a maximum of 0.2 seconds.

Requirements

The following requirements must be met for problem-free operation with the MRP media redundancy protocol:

- MRP is supported in ring topologies with up to 50 devices. Exceeding this number of devices can lead to a loss of data traffic.
- The ring in which you want to use MRP may only consist of devices that support this function. This applies, for example, to the following devices:
 - Industrial Ethernet switches
 - SCALANCE X-200 as of firmware version V4.0
 - SCALANCE X-200 IRT as of firmware version V4.0
 - SCALANCE X-300 as of firmware version V3.0
 - SCALANCE X-400 as of firmware version V3.0
 - Communications processors
 - CP 443-1 Advanced (6GK7 443-1GX20-0XE0) as of firmware version V2.0
 - CP 343-1 Advanced (6GK7 343-1GX30-0XE0) as of firmware version V1.0
 - CP 1616 (6GK1 161-6AA00) as of firmware version V2.2
 - CP 1604 (6GK1 160-4AA00) as of firmware version V2.2
 - Non-Siemens devices that support this functionality.
Further Siemens devices are planned that will support MRP.
- All devices must be interconnected via their ring ports.
- If you configure in STEP 7, MRP must be enabled on all devices in the ring (see "MRP configuration in PROFINET IO").
- If you configure with Web Based Management, CLI or SNMP, set all the devices in the ring to "MRP Client" or "Automatic Redundancy Detection". At least one device in the ring must have the setting "Automatic Redundancy Detection".
In their basic status, the "Automatic Redundancy Detection" mode is set on IE switches as default.
- The connection settings (transmission medium / duplex) must be set to full duplex and at least 100 Mbps for all ring ports. Otherwise there may be a loss of data traffic.
 - To do this, set all the ports involved in the ring to "Automatic settings" in the "Options" tab of the properties dialog during STEP 7 configuration.
 - If you configure with Web Based Management, the ring ports are set automatically to autonegotiation.

Topology

The following schematic shows a possible topology for devices in a ring with MRP.

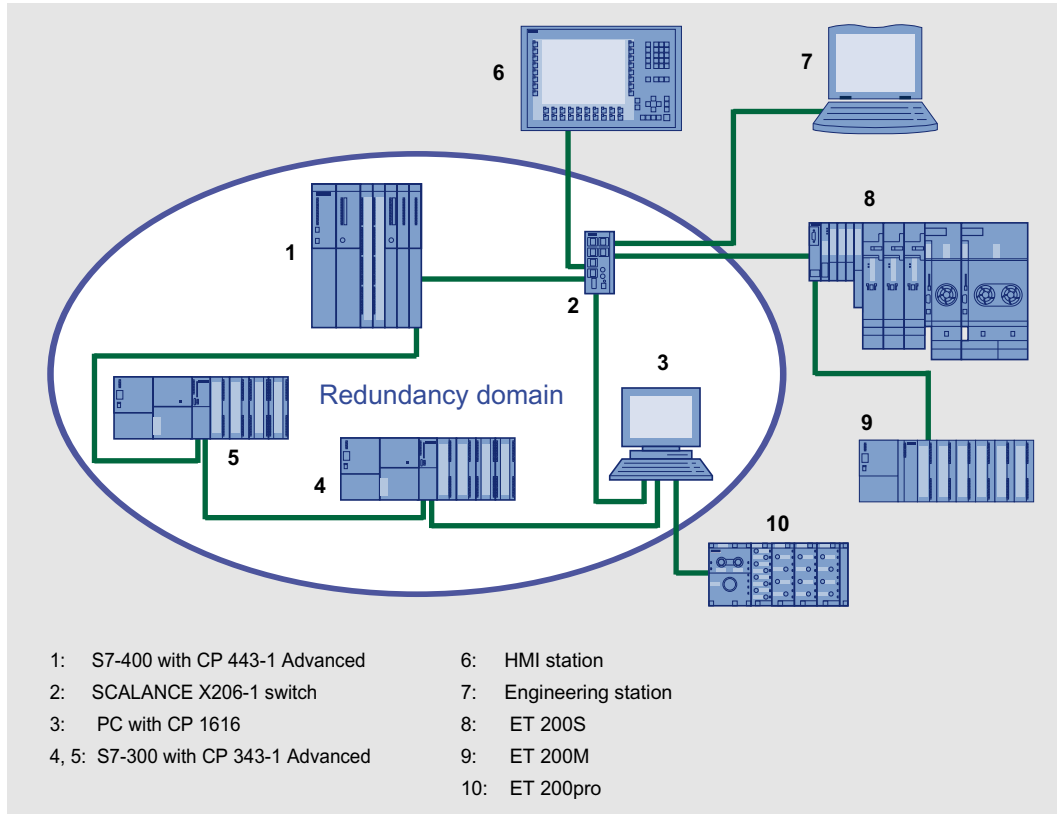

Figure 2-9 Example of a ring topology with the MRP media redundancy protocol

The following rules apply to a ring topology with media redundancy using MRP:

- All the devices connected within the ring topology are members of the same redundancy domain.
- One device in the ring is acting as redundancy manager.
- All other devices in the ring are redundancy clients.

Non MRP-compliant devices can be connected to the ring via a SCALANCE X switch or via a PC with a CP 1616.

Note

SCALANCE X-300 - modular devices (M)

Remember that in the modular switches the ring ports are located on MM900 media modules.

2.5 MRPD

The redundancy procedure MRPD (Media Redundancy with Path Duplication)

The MRPD procedure is specified in IEC 61158 Parts 5 and 6 type 10 "PROFINET". It allows redundancy for PROFINET IRT.

In MRPD, the cyclic IRT frames are duplicated and sent to the recipient via different paths. The two redundant paths are planned in STEP 7. Two different paths are then available if the entire network or part of it has a ring topology.

Requirements

- All devices involved must support IRT.
- All devices involved must support MRPD.
 - Among the Industrial Ethernet switches, this means the following devices:
 - SCALANCE X-200IRT as of firmware version 5.0
- STEP 7 as of version V5.5 SP1

Project engineering

MRPD can only be configured in STEP 7 and there are no alternative configuration options.

To prevent loops forming and to ensure redundancy for other types of communication, MRP is always required for MRPD. If you activate MRP in STEP 7, products capable of IRT and MRPD use MRPD automatically.

The "High Performance" version of IRT must be used and the topology of the network must be configured.

2.6 HSR

The "HSR" method allows a reconfiguration time of 0.3 seconds following an interruption in the ring.

Requirements

The following requirements must be met for problem-free operation with the HSR media redundancy method:

- HSR is supported in ring topologies with up to 50 devices. Exceeding this number of devices can lead to a loss of data traffic.
- The ring in which you want to use HSR may only consist of devices that support this function. This applies, for example, to the following devices: X-400 IE switches, X-300 IE switches, X-200 IE switches and OSM / ESM.
- All devices must be interconnected via their ring ports.
- A device in the ring must be configured as redundancy manager by selecting the "HSR Manager" setting. You can do this with the button on the front of the device, Web Based Management, CLI or SNMP.
- On all other devices in the ring, either the "HSR Client" or "Automatic Redundancy Detection" mode must be activated. You can do this with Web Based Management, CLI or SNMP.
- In the basic status, the "HSR Client" or "Automatic Redundancy Detection" mode is set as default.

2.7 Redundant coupling of network segments

Coupling option

The coupling of two network segments shown here as an example is possible with X-200IRT, X-300 and X-400 IE switches. This requires the standby function of these devices that can be set via the WEB interface or CLI.

If the standby function is enabled, this is signaled on X-200 IE switches by the RM-LED.

The SCALANCE X-200IRT can be operated either as an RM or in standby mode.

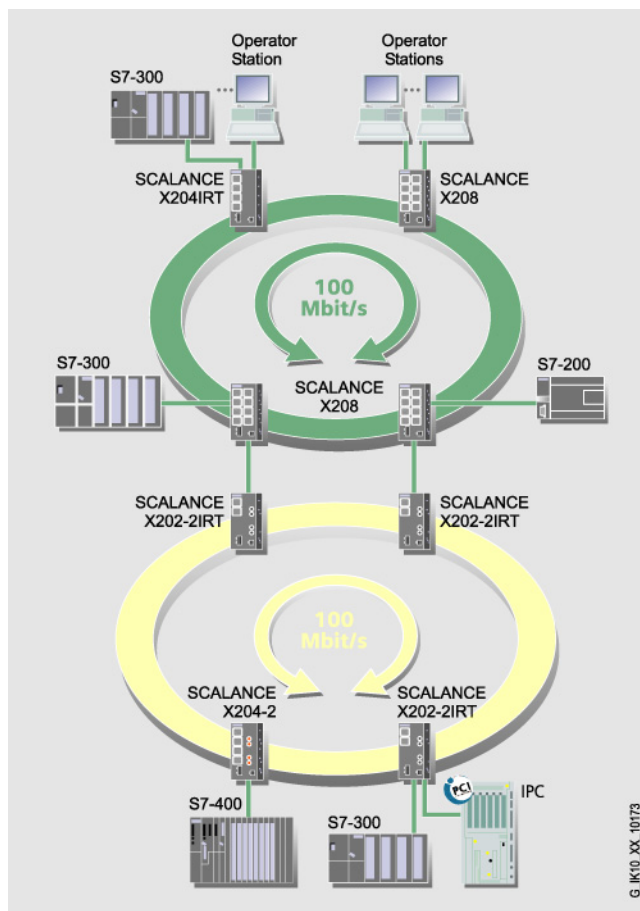

Figure 2-10 Redundant coupling of SCALANCE X-200 rings with 2 SCALANCE X-200 IRT devices

Product properties

3.1 Overview of the product characteristics

Table 3- 1 Overview of the product characteristics

	Device type SCALANCE	
	XF204 X208 XF208 X216 X224, X204-2 X204-2TS XF204-2 X206-1 XF206-1, X212-2 X204-2LD X206-1LD X212-2LD	X202-2 IRT X204IRT XF204 IRT X204 IRT PRO X202-2P IRT PRO X201-3P IRT PRO X202-2P IRT X201-3P IRT X200-4P IRT X202-2 IRT X204IRT
SIMATIC environment	•	•
Diagnostics LED	•	•
24 VDC	•	•
Compact housing (securing collar, etc.)	•	•
2x 24 V DC	•	•
Signaling contact + on-site operation	•	•
Diagnostics: Web, SNMP, PROFINET	•	•
C-PLUG	•	•
IRT capability	-	•
Fast learning	-	•
Passive listening	•	•
SNTP + SICLOCK	•	•
Cut through	-	•
Use in ring possible (as node and RM)	•	•
Standby manager	-	•

Note

IRT switches cannot be redundancy and standby manager at the same time.

Fast learning:

Fast recognition of MAC addresses on the device that change during operation (for example, when an end node is reconnected).

Product properties

3.1 Overview of the product characteristics

Table 3- 2 Overview of the connection options

Fast Ethernet 10/100 Mbps	Device type SCALANCE									
	XF204	X208 XF208	X216	X224	X204-2 X204-2TS XF204-2	X206-1 XF206-1	X212-2	X204-2LD	X206-1LD	X212-2LD
TP (RJ-45)	4	8	16	24	4	6	12	4	6	12
Fiber multimode (BFOC)	-	-	-	-	2	1	2	-	-	-
Fiber single mode (BFOC)	-	-	-	-	-	-	-	2	1	2
Fiber POF / PCF (SC-RJ)	-	-	-	-	-	-	-	-	-	-
The following ports are set as ring ports when supplied	P1, P2	P1, P2	P1, P2	P1, P2	P5, P6	P1, P2	P13, P14	P5, P6	P1, P2	P13, P14

Table 3- 3 Overview of the connection options for IRT devices

Fast Ethernet 10/100 Mbps	Device type SCALANCE									
	X202-2IRT	X204IRT	XF204IRT	X204IRT PRO	X202- 2P IRT PRO	X201- 3P IRT PRO	X202- 2P IRT	X201-3P IRT	X200-4P IRT	
TP (RJ-45)	2	4	4	-	-	-	2	1	-	
IE RJ-45 Plug PRO	-	-	-	4	2	1	-	-	-	
IE SC RJ Plug PRO	-	-	-	-	2	3	-	-	-	
Fiber multimode (BFOC)	2	-	-	-	-	-	-	-	-	
Fiber single mode (BFOC)	-	-	-	-	-	-	-	-	-	
Fiber POF / PCF (SC-RJ)	-	-	-	-	2	3	2	3	4	
The following ports are set as ring ports when supplied	P3, P4	P1, P2	P1, P2	P1, P2	P3, P4	P3, P4	P3, P4	P3, P4	P3, P4	

3.2 Components of the product

The following components ship with the device (except X204 IRT PRO, X202-2P IRT PRO, X201-3P IRT PRO):

- Device
- 2-pin plug-in terminal block
- 4-pin plug-in terminal block
- Operating Instructions (compact)
- CD (operating instructions, PST Tool, GSD file, SNMP OPC profile)

The following components ship with an X204 IRT PRO, X202-2P IRT PRO, X201-3P IRT PRO:

- Device
- 4 data connector protective covers
- 2 protective caps for power supply connectors
- 1 protective cap for the M12 signaling contact
- Operating Instructions (compact)
- CD (operating instructions, PST Tool, GSD file, SNMP OPC profile)

3.3 Unpacking and checking

Unpacking, checking

1. Make sure that the package is complete.
2. Check all the parts for transport damage.

 WARNING
--

Do not use any parts that show evidence of damage!
--

3.4 SCALANCE XF204

3.4.1 SCALANCE XF204 product characteristics

Possible attachments

The SCALANCE XF204 has four RJ-45 jacks for connecting end devices or other network segments.



Figure 3-1 SCALANCE XF204

3.4.2 SCALANCE XF204 TP ports

Connector pinout

On the SCALANCE XF204, the TP ports are implemented as RJ-45 jacks with the MDI-X assignment (Medium Dependent Interface Autocrossover) of a network component.

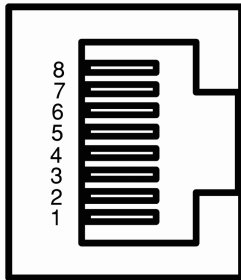

Figure 3-2 RJ-45 jack

Table 3-4 Pin assignment

Pin number	Assignment
Pin 8	n. c.
Pin 7	n. c.
Pin 6	TD-
Pin 5	n. c.
Pin 4	n. c.
Pin 3	TD+
Pin 2	RD-
Pin 1	RD+

NOTICE

TP cords or TP-XP cords with a maximum length of 10 m can be connected to the RJ-45 TP port.

With the IE FC cables and IE FC RJ-45 plug 180, an overall cable length of up to 100 m is permitted between two devices depending on the cable type.

Autonegotiation

Autonegotiation means the automatic detection of the functionality of the port at the opposite end. Using autonegotiation, repeaters or end devices can detect the functionality available at the port of a partner device allowing automatic configuration of different types of device. With autonegotiation, two components connected to a link segment can exchange parameters and set themselves to match the supported communication functionality.

NOTICE

If an IE switch port operating in autonegotiation mode is connected to a partner device that is not operating in autonegotiation mode, the partner device must be set permanently to half duplex mode.

If an IE switch port is set permanently to full duplex, the connected partner device must also be set to full duplex.

If the autonegotiation function is disabled, the MDI/MDI-X autocrossover function is also inactive. This means it may be necessary to use a crossover cable.

Note

The SCALANCE XF204 is a plug-and-play device that does not require settings to be made for commissioning.

MDI / MDIX autocrossover function

The advantage of the MDI / MDIX autocrossover function is that straight-through cables can be used throughout and external Ethernet crossover cables are unnecessary. This prevents malfunctions resulting from mismatching send and receive wires. This makes installation much easier for the user.

IE Switches XF-200 support the MDI / MDIX autocrossover function.

NOTICE

Please note that the direct connection of two ports on the switch or accidental connection over several switches causes an illegal loop. Such a loop can lead to network overload and network failures.

Auto polarity exchange

If the pair of receiving cables are incorrectly connected (RD+ and RD- swapped over), the polarity is reversed automatically.

3.5 SCALANCE X208

3.5.1 SCALANCE X208 product characteristics

Possible attachments

The SCALANCE X208 has eight RJ-45 jacks for the connection of end devices or other network segments.



Figure 3-3 SCALANCE X208

3.5.2 SCALANCE X208 TP ports

Connector pinout

On the SCALANCE X208, the TP ports are implemented as RJ-45 jacks with MDI-X assignment (Medium Dependent Interface–Autocrossover) of a network component.

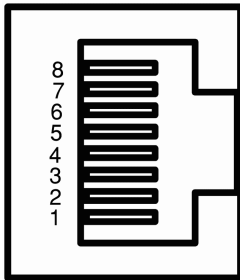

Figure 3-4 RJ-45 jack

Table 3- 5 Pin assignment

Pin number	Assignment
Pin 8	n. c.
Pin 7	n. c.
Pin 6	TD-
Pin 5	n. c.
Pin 4	n. c.
Pin 3	TD+
Pin 2	RD-
Pin 1	RD+

NOTICE

TP cords or TP-XP cords with a maximum length of 10 m can be connected to the RJ-45 TP port.

With the IE FC cables and IE FC RJ-45 plug 180, an overall cable length of up to 100 m is permitted between two devices depending on the cable type.

Autonegotiation

Autonegotiation means the automatic detection of the functionality of the port at the opposite end. Using autonegotiation, repeaters or end devices can detect the functionality available at the port of a partner device allowing automatic configuration of different types of device. With autonegotiation, two components connected to a link segment can exchange parameters and set themselves to match the supported communication functionality.

Note

If an IE switch port operating in autonegotiation mode is connected to a partner device that is not operating in autonegotiation mode, the partner device must be set permanently to half duplex mode.

If an IE switch port is set permanently to full duplex, the connected partner device must also be set to full duplex.

If the autonegotiation function is disabled, the MDI/MDI-X autocrossover function is also inactive. This means it may be necessary to use a crossover cable.

Note

The SCALANCE X208 is a plug-and-play device that does not require settings to be made for commissioning.

MDI /MDIX autocrossover function

The advantage of the MDI /MDIX autocrossover function is that straight-through cables can be used throughout and crossover Ethernet cables are unnecessary. This prevents malfunctions resulting from mismatching send and receive wires. This makes installation much easier for the user.

IE Switches X-200 support the MDI / MDIX autocrossover function.

NOTICE

Please note that the direct connection of two ports on the switch or accidental connection over several switches causes an illegal loop. Such a loop can lead to network overload and network failures.

Auto polarity exchange

If the pair of receiving cables are incorrectly connected (RD+ and RD- swapped over), the polarity is reversed automatically.

3.6 SCALANCE XF208

3.6.1 SCALANCE XF208 product characteristics

Possible attachments

The SCALANCE XF208 has eight RJ-45 jacks for the connection of end devices or other network segments.



Figure 3-5 SCALANCE XF208

3.6.2 SCALANCE XF208 TP ports

Connector pinout

On the SCALANCE XF208, the TP ports are implemented as RJ-45 jacks with the MDI-X assignment (Medium Dependent Interface Autocrossover) of a network component.

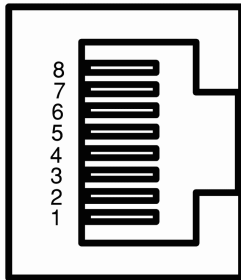

Figure 3-6 RJ-45 jack

Table 3- 6 Pin assignment

Pin number	Assignment
Pin 8	n. c.
Pin 7	n. c.
Pin 6	TD-
Pin 5	n. c.
Pin 4	n. c.
Pin 3	TD+
Pin 2	RD-
Pin 1	RD+

NOTICE

TP cords or TP-XP cords with a maximum length of 10 m can be connected to the RJ-45 TP port.

With the IE FC cables and IE FC RJ-45 plug 180, an overall cable length of up to 100 m is permitted between two devices depending on the cable type.

Autonegotiation

Autonegotiation means the automatic detection of the functionality of the port at the opposite end. Using autonegotiation, repeaters or end devices can detect the functionality available at the port of a partner device allowing automatic configuration of different types of device. With autonegotiation, two components connected to a link segment can exchange parameters and set themselves to match the supported communication functionality.

Note

If an IE switch port operating in autonegotiation mode is connected to a partner device that is not operating in autonegotiation mode, the partner device must be set permanently to half duplex mode.

If an IE switch port is set permanently to full duplex, the connected partner device must also be set to full duplex.

If the autonegotiation function is disabled, the MDI/MDI-X autocrossover function is also inactive. This means it may be necessary to use a crossover cable.

Note

The SCALANCE XF208 is a plug-and-play device that does not require settings to be made for commissioning.

MDI / MDIX autocrossover function

The advantage of the MDI / MDIX autocrossover function is that straight-through cables can be used throughout and external Ethernet crossover cables are unnecessary. This prevents malfunctions resulting from mismatching send and receive wires. This makes installation much easier for the user.

IE Switches XF-200 support the MDI / MDIX autocrossover function.

NOTICE
Please note that a direct connection of two ports on the switch or an accidental connection across several switches causes a forbidden loop. Such a loop can lead to network overload and network failures.

Auto polarity exchange

If the pair of receiving cables are incorrectly connected (RD+ and RD- swapped over), the polarity is reversed automatically.

3.7 SCALANCE X216

3.7.1 SCALANCE X216 product characteristics

Possible attachments

The SCALANCE X216 has 16 RJ-45 jacks for the connection of end devices or other network segments.



Figure 3-7 SCALANCE X216

3.7.2 SCALANCE X216 TP ports

Connector pinout

On the SCALANCE X216, the TP ports are implemented as RJ-45 jacks with MDI-X assignment (Medium Dependent Interface–Autocrossover) of a network component.

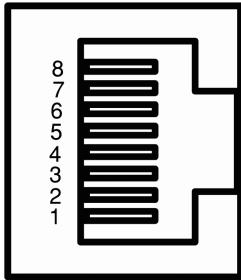

Figure 3-8 RJ-45 jack

Table 3- 7 Pin assignment

Pin number	Assignment
Pin 8	n. c.
Pin 7	n. c.
Pin 6	TD-
Pin 5	n. c.
Pin 4	n. c.
Pin 3	TD+
Pin 2	RD-
Pin 1	RD+

NOTICE

TP cords or TP-XP cords with a maximum length of 10 m can be connected to the RJ-45 TP port.

With the IE FC cables and IE FC RJ-45 plug 180, an overall cable length of up to 100 m is permitted between two devices depending on the cable type.

Autonegotiation

Autonegotiation means the automatic detection of the functionality of the port at the opposite end. Using autonegotiation, repeaters or end devices can detect the functionality available at the port of a partner device allowing automatic configuration of different types of device. With autonegotiation, two components connected to a link segment can exchange parameters and set themselves to match the supported communication functionality.

Note

If an IE switch port operating in autonegotiation mode is connected to a partner device that is not operating in autonegotiation mode, the partner device must be set permanently to half duplex mode.

If an IE switch port is set permanently to full duplex, the connected partner device must also be set to full duplex.

If the autonegotiation function is disabled, the MDI/MDI-X autocrossover function is also inactive. This means it may be necessary to use a crossover cable.

Note

The SCALANCE X216 is a plug-and-play device that does not require settings to be made for commissioning.

MDI /MDIX autocrossover function

The advantage of the MDI /MDIX autocrossover function is that straight-through cables can be used throughout and crossover Ethernet cables are unnecessary. This prevents malfunctions resulting from mismatching send and receive wires. This makes installation much easier for the user.

IE Switches X-200 support the MDI / MDIX autocrossover function.

NOTICE

Please note that the direct connection of two ports on the switch or accidental connection over several switches causes an illegal loop. Such a loop can lead to network overload and network failures.

Auto polarity exchange

If the pair of receiving cables are incorrectly connected (RD+ and RD- swapped over), the polarity is reversed automatically.

3.8 SCALANCE X224

3.8.1 SCALANCE X224 product characteristics

Possible attachments

The SCALANCE X224 has 24 RJ-45 jacks for the connection of end devices or other network segments.



Figure 3-9 SCALANCE X224

3.8.2 SCALANCE X224 TP ports

Connector pinout

On the SCALANCE X224, the TP ports are implemented as RJ-45 jacks with MDI-X assignment (Medium Dependent Interface–Autocrossover) of a network component.

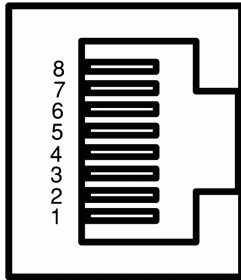

Figure 3-10 RJ-45 jack

Table 3- 8 Pin assignment

Pin number	Assignment
Pin 8	n. c.
Pin 7	n. c.
Pin 6	TD-
Pin 5	n. c.
Pin 4	n. c.
Pin 3	TD+
Pin 2	RD-
Pin 1	RD+

NOTICE

TP cords or TP-XP cords with a maximum length of 10 m can be connected to the RJ-45 TP port.

With the IE FC cables and IE FC RJ-45 plug 180, an overall cable length of up to 100 m is permitted between two devices depending on the cable type.

Autonegotiation

Autonegotiation means the automatic detection of the functionality of the port at the opposite end. Using autonegotiation, repeaters or end devices can detect the functionality available at the port of a partner device allowing automatic configuration of different types of device. With autonegotiation, two components connected to a link segment can exchange parameters and set themselves to match the supported communication functionality.

Note

If an IE switch port operating in autonegotiation mode is connected to a partner device that is not operating in autonegotiation mode, the partner device must be set permanently to half duplex mode.

If an IE switch port is set permanently to full duplex, the connected partner device must also be set to full duplex.

If the autonegotiation function is disabled, the MDI/MDI-X autocrossover function is also inactive. This means it may be necessary to use a crossover cable.

Note

The SCALANCE X224 is a plug-and-play device that does not require settings to be made for commissioning.

MDI /MDIX autocrossover function

The advantage of the MDI /MDIX autocrossover function is that straight-through cables can be used throughout and crossover Ethernet cables are unnecessary. This prevents malfunctions resulting from mismatching send and receive wires. This makes installation much easier for the user.

IE Switches X-200 support the MDI / MDIX autocrossover function.

NOTICE

Please note that the direct connection of two ports on the switch or accidental connection over several switches causes an illegal loop. Such a loop can lead to network overload and network failures.

Auto polarity exchange

If the pair of receiving cables are incorrectly connected (RD+ and RD- swapped over), the polarity is reversed automatically.

3.9 SCALANCE X204-2 / SCALANCE X204-2TS

3.9.1 SCALANCE X204-2 / SCALANCE X204-2TS product features

Possible attachments

The SCALANCE X204-2 and SCALANCE X204-2TS devices have four RJ-45 jacks and two BFOC interfaces for the connection of end devices or other network segments.

Note

The BFOC socket (Bayonet Fiber Optic Connector) corresponds to the ST socket. Note that the BFOC socket is a multimode interface.



Figure 3-11 SCALANCE X204-2

3.9.2 SCALANCE X204-2 / SCALANCE X204-2TS TP interfaces

Connector pinout

On the SCALANCE X204-2 and SCALANCE X204-2TS devices, the TP interfaces take the form of RJ-45 jacks with the MDI-X assignment (Medium Dependent Interface Autocrossover) of a network component.

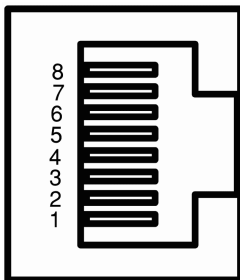

Figure 3-12 RJ-45 jack

Table 3-9 Pin assignment

Pin number	Assignment
Pin 8	n. c.
Pin 7	n. c.
Pin 6	TD-
Pin 5	n. c.
Pin 4	n. c.
Pin 3	TD+
Pin 2	RD-
Pin 1	RD+

NOTICE

TP cords or TP-XP cords with a maximum length of 10 m can be connected to the RJ-45 TP port.

With the IE FC cables and IE FC RJ-45 plug 180, an overall cable length of a maximum of 100 m is permitted between two devices depending on the cable type.

Autonegotiation

Autonegotiation means the automatic detection of the functionality of the port at the opposite end. Using autonegotiation, repeaters or end devices can detect the functionality available at the port of a partner device allowing automatic configuration of different types of device. With autonegotiation, two components connected to a link segment can exchange parameters and set themselves to match the supported communication functionality.

Note

If an IE switch port operating in autonegotiation mode is connected to a partner device that is not operating in autonegotiation mode, the partner device must be set permanently to half duplex mode.

If an IE switch port is set permanently to full duplex, the connected partner device must also be set to full duplex.

If the autonegotiation function is disabled, the MDI/MDI-X autocrossover function is also inactive. This means it may be necessary to use a crossover cable.

Note

The SCALANCE X204-2 and the SCALANCE X204-2TS are plug-and-play devices that require no settings during commissioning.

MDI / MDIX autocrossover function

The advantage of the MDI / MDIX autocrossover function is that straight-through cables can be used throughout and external Ethernet crossover cables are unnecessary. This prevents malfunctions resulting from mismatching send and receive wires. This makes installation much easier for the user.

IE Switches X-200 support the MDI / MDIX autocrossover function.

NOTICE

Please note that the direct connection of two ports on the switch or accidental connection over several switches causes an illegal loop. Such a loop can lead to network overload and network failures.

Auto polarity exchange

If the pair of receiving cables are incorrectly connected (RD+ and RD- swapped over), the polarity is reversed automatically.

3.9.3 SCALANCE X204-2 / SCALANCE X204-2TS FO interfaces

Transmission speed

The transmission speed of the optical Fast Ethernet ports is 100 Mbps.

Transmission mode

The transmission mode for 100Base-FX is specified in the IEEE 802.3 standard.

Since the full duplex mode and the transmission rate cannot be modified for optical transmission, autonegotiation cannot be selected.

Transmission medium

Data transmission is over multimode fiber-optic cable (FO cable). The wavelength is 1310 nm.

Multimode fiber-optic cables are used with a core of 50 or 62.5 μm ; the light source is an LED.

The outer diameter of the FO cable is 125 μm .

Transmission range

The maximum transmission range (segment length) is up to 5 km depending on the cable type.

Connectors

The cables are connected over BFOC sockets.

3.10 SCALANCE XF204-2

3.10.1 SCALANCE XF204-2 product characteristics

Possible attachments

The SCALANCE XF204-2 has four RJ-45 jacks and two BFOC ports for the connection of end devices or other network segments.

Note

The BFOC socket (Bayonet Fiber Optic Connector) corresponds to the ST socket.



Figure 3-13 SCALANCE XF204-2

3.10.2 SCALANCE XF204-2 TP ports

Connector pinout

On the SCALANCE XF204-2, the TP ports are implemented as RJ-45 jacks with MDI-X assignment (Medium Dependent Interface–Autocrossover) of a network component.

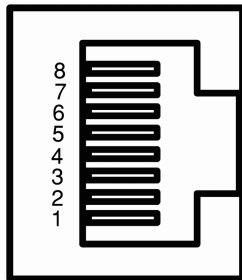

Figure 3-14 RJ-45 jack

Table 3- 10 Pin assignment

Pin number	Assignment
Pin 8	n. c.
Pin 7	n. c.
Pin 6	TD-
Pin 5	n. c.
Pin 4	n. c.
Pin 3	TD+
Pin 2	RD-
Pin 1	RD+

NOTICE

TP cords or TP-XP cords with a maximum length of 10 m can be connected to the RJ-45 TP port.

With the IE FC cables and IE FC RJ-45 plug 180, an overall cable length of a maximum of 100 m is permitted between two devices depending on the cable type.

Autonegotiation

Autonegotiation means the automatic detection of the functionality of the port at the opposite end. Using autonegotiation, repeaters or end devices can detect the functionality available at the port of a partner device allowing automatic configuration of different types of device. With autonegotiation, two components connected to a link segment can exchange parameters and set themselves to match the supported communication functionality.

Note

If an IE switch port operating in autonegotiation mode is connected to a partner device that is not operating in autonegotiation mode, the partner device must be set permanently to half duplex mode.

If an IE switch port is set permanently to full duplex, the connected partner device must also be set to full duplex.

If the autonegotiation function is disabled, the MDI/MDI-X autocrossover function is also inactive. This means it may be necessary to use a crossover cable.

Note

The SCALANCE XF204-2 is a plug-and-play device that does not require settings to be made for commissioning.

MDI / MDIX autocrossover function

The advantage of the MDI / MDIX autocrossover function is that straight-through cables can be used throughout and external Ethernet crossover cables are unnecessary. This prevents malfunctions resulting from mismatching send and receive wires. This makes installation much easier for the user.

IE Switches X-200 support the MDI / MDIX autocrossover function.

NOTICE

Please note that a direct connection of two ports on the switch or an accidental connection across several switches causes a forbidden loop. Such a loop can lead to network overload and network failures.

Auto polarity exchange

If the pair of receiving cables are incorrectly connected (RD+ and RD- swapped over), the polarity is reversed automatically.

3.10.3 SCALANCE XF204-2 FO ports

Transmission speed

The transmission speed of the optical Fast Ethernet ports is 100 Mbps.

Transmission mode

The transmission mode for 100Base-FX is specified in the IEEE 802.3 standard.

Since the full duplex mode and the transmission rate cannot be modified for optical transmission, autonegotiation cannot be selected.

Transmission medium

Data transmission is over multimode fiber-optic cable (FO cable). The wavelength is 1310 nm.

Multimode fiber-optic cables are used with a core of 50 or 62.5 μm ; the light source is an LED.

The outer diameter of the FO cable is 125 μm .

Transmission range

The maximum transmission range (segment length) is up to 5 km depending on the cable type.

Connectors

The cables are connected over BFOC sockets.

3.11 SCALANCE X206-1

3.11.1 SCALANCE X206-1 product characteristics

Possible attachments

The SCALANCE X206-1 has six RJ-45 jacks and a BFOC port for the connection of end devices or other network segments.

Note

The BFOC socket (Bayonet Fiber Optic Connector) corresponds to the ST socket.



Figure 3-15 SCALANCE X206-1

3.11.2 SCALANCE X206-1 TP ports

Connector pinout

On the SCALANCE X206-1, the TP ports are implemented as RJ-45 jacks with MDI-X assignment (Medium Dependent Interface–Autocrossover) of a network component.

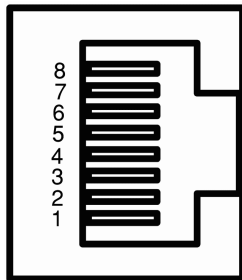

Figure 3-16 RJ-45 jack

Table 3- 11 Pin assignment

Pin number	Assignment
Pin 8	n. c.
Pin 7	n. c.
Pin 6	TD-
Pin 5	n. c.
Pin 4	n. c.
Pin 3	TD+
Pin 2	RD-
Pin 1	RD+

NOTICE

TP cords or TP-XP cords with a maximum length of 10 m can be connected to the RJ-45 TP port.

With the IE FC cables and IE FC RJ-45 plug 180, an overall cable length of a maximum of 100 m is permitted between two devices depending on the cable type.

Autonegotiation

Autonegotiation means the automatic detection of the functionality of the port at the opposite end. Using autonegotiation, repeaters or end devices can detect the functionality available at the port of a partner device allowing automatic configuration of different types of device. With autonegotiation, two components connected to a link segment can exchange parameters and set themselves to match the supported communication functionality.

Note

If an IE switch port operating in autonegotiation mode is connected to a partner device that is not operating in autonegotiation mode, the partner device must be set permanently to half duplex mode.

If an IE switch port is set permanently to full duplex, the connected partner device must also be set to full duplex.

If the autonegotiation function is disabled, the MDI/MDI-X autocrossover function is also inactive. This means it may be necessary to use a crossover cable.

Note

The SCALANCE X206-1 is a plug-and-play device that does not require settings to be made for commissioning.

MDI /MDIX autocrossover function

The advantage of the MDI /MDIX autocrossover function is that straight-through cables can be used throughout and crossover Ethernet cables are unnecessary. This prevents malfunctions resulting from mismatching send and receive wires. This makes installation much easier for the user.

IE Switches X-200 support the MDI / MDIX autocrossover function.

NOTICE

Please note that the direct connection of two ports on the switch or accidental connection over several switches causes an illegal loop. Such a loop can lead to network overload and network failures.

Auto polarity exchange

If the pair of receiving cables are incorrectly connected (RD+ and RD- swapped over), the polarity is reversed automatically.

3.11.3 SCALANCE X206-1 FO ports

Transmission speed

The transmission speed of the optical Fast Ethernet ports is 100 Mbps.

Transmission mode

The transmission mode for 100Base-FX is specified in the IEEE 802.3 standard.

Since the full duplex mode and the transmission rate cannot be modified for optical transmission, autonegotiation cannot be selected.

Transmission medium

Data transmission is over multimode fiber-optic cable (FO cable). The wavelength is 1310 nm.

Multimode fiber-optic cables are used with a core of 50 or 62.5 μm ; the light source is an LED.

The outer diameter of the FO cable is 125 μm .

Transmission range

The maximum transmission range (segment length) is up to 5 km depending on the cable type.

Connectors

The cables are connected over BFOC sockets.

3.12 SCALANCE XF206-1

3.12.1 SCALANCE XF206-1 product characteristics

Possible attachments

The SCALANCE XF206-1 has six RJ-45 jacks and a BFOC port for the connection of end devices or other network segments.

Note

The BFOC socket (Bayonet Fiber Optic Connector) corresponds to the ST socket.



Figure 3-17 SCALANCE XF206-1

3.12.2 SCALANCE XF206-1 TP ports

Connector pinout

On the SCALANCE XF206-1, the TP ports are implemented as RJ-45 jacks with MDI-X assignment (Medium Dependent Interface–Autocrossover) of a network component.

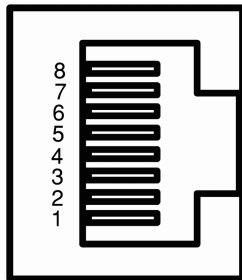

Figure 3-18 RJ-45 jack

Table 3- 12 Pin assignment

Pin number	Assignment
Pin 8	n. c.
Pin 7	n. c.
Pin 6	TD-
Pin 5	n. c.
Pin 4	n. c.
Pin 3	TD+
Pin 2	RD-
Pin 1	RD+

NOTICE

TP cords or TP-XP cords with a maximum length of 10 m can be connected to the RJ-45 TP port.

With the IE FC cables and IE FC RJ-45 plug 180, an overall cable length of a maximum of 100 m is permitted between two devices depending on the cable type.

Autonegotiation

Autonegotiation means the automatic detection of the functionality of the port at the opposite end. Using autonegotiation, repeaters or end devices can detect the functionality available at the port of a partner device allowing automatic configuration of different types of device. With autonegotiation, two components connected to a link segment can exchange parameters and set themselves to match the supported communication functionality.

Note

If an IE switch port operating in autonegotiation mode is connected to a partner device that is not operating in autonegotiation mode, the partner device must be set permanently to half duplex mode.

If an IE switch port is set permanently to full duplex, the connected partner device must also be set to full duplex.

If the autonegotiation function is disabled, the MDI/MDI-X autocrossover function is also inactive. This means it may be necessary to use a crossover cable.

Note

The SCALANCE XF206-1 is a plug-and-play device that does not require settings to be made for commissioning.

MDI / MDIX autocrossover function

The advantage of the MDI / MDIX autocrossover function is that straight-through cables can be used throughout and external Ethernet crossover cables are unnecessary. This prevents malfunctions resulting from mismatching send and receive wires. This makes installation much easier for the user.

IE Switches X-200 support the MDI / MDIX autocrossover function.

NOTICE

Please note that a direct connection of two ports on the switch or an accidental connection across several switches causes a forbidden loop. Such a loop can lead to network overload and network failures.

Auto polarity exchange

If the pair of receiving cables are incorrectly connected (RD+ and RD- swapped over), the polarity is reversed automatically.

3.12.3 SCALANCE XF206-1 FO ports

Transmission speed

The transmission speed of the optical Fast Ethernet ports is 100 Mbps.

Transmission mode

The transmission mode for 100Base-FX is specified in the IEEE 802.3 standard.

Since the full duplex mode and the transmission rate cannot be modified for optical transmission, autonegotiation cannot be selected.

Transmission medium

Data transmission is over multimode fiber-optic cable (FO cable). The wavelength is 1310 nm.

Multimode fiber-optic cables are used with a core of 50 or 62.5 μm ; the light source is an LED.

The outer diameter of the FO cable is 125 μm .

Transmission range

The maximum transmission range (segment length) is up to 5 km depending on the cable type.

Connectors

The cables are connected over BFOC sockets.

3.13 SCALANCE X212-2

3.13.1 SCALANCE X212-2 product characteristics

Possible attachments

The SCALANCE X212-2 has 12 RJ-45 jacks and two BFOC interfaces for connecting end devices or other network segments.

Note

The BFOC socket (Bayonet Fiber Optic Connector) corresponds to the ST socket



Figure 3-19 SCALANCE X 212-2

3.13.2 SCALANCE X212-2 TP ports

Connector pinout

On the SCALANCE X212-2, the TP ports are implemented as RJ-45 jacks with MDI-X assignment (Medium Dependent Interface–Autocrossover) of a network component.

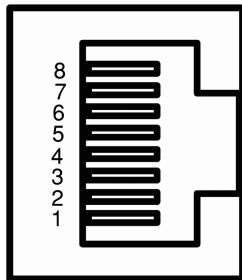

Figure 3-20 RJ-45 jack

Table 3- 13 Pin assignment

Pin number	Assignment
Pin 8	n. c.
Pin 7	n. c.
Pin 6	TD-
Pin 5	n. c.
Pin 4	n. c.
Pin 3	TD+
Pin 2	RD-
Pin 1	RD+

NOTICE

TP cords or TP-XP cords with a maximum length of 10 m can be connected to the RJ-45 TP port.

With the IE FC cables and IE FC RJ-45 plug 180, an overall cable length of up to 100 m is permitted between two devices depending on the cable type.

Autonegotiation

Autonegotiation means the automatic detection of the functionality of the port at the opposite end. Using autonegotiation, repeaters or end devices can detect the functionality available at the port of a partner device allowing automatic configuration of different types of device. With autonegotiation, two components connected to a link segment can exchange parameters and set themselves to match the supported communication functionality.

Note

If an IE switch port operating in autonegotiation mode is connected to a partner device that is not operating in autonegotiation mode, the partner device must be set permanently to half duplex mode.

If an IE switch port is set permanently to full duplex, the connected partner device must also be set to full duplex.

If the autonegotiation function is disabled, the MDI/MDI-X autocrossover function is also inactive. This means it may be necessary to use a crossover cable.

Note

The SCALANCE X212-2 is a plug-and-play device that does not require settings to be made for commissioning.

MDI /MDIX autocrossover function

The advantage of the MDI /MDIX autocrossover function is that straight-through cables can be used throughout and crossover Ethernet cables are unnecessary. This prevents malfunctions resulting from mismatching send and receive wires. This makes installation much easier for the user.

IE Switches X-200 support the MDI / MDIX autocrossover function.

NOTICE

Please note that the direct connection of two ports on the switch or accidental connection over several switches causes an illegal loop. Such a loop can lead to network overload and network failures.

Auto polarity exchange

If the pair of receiving cables are incorrectly connected (RD+ and RD- swapped over), the polarity is reversed automatically.

3.13.3 SCALANCE X212-2 FO ports

Transmission speed

The transmission speed of the optical Fast Ethernet ports is 100 Mbps.

Transmission mode

The transmission mode for 100Base-FX is specified in the IEEE 802.3 standard.

Since the full duplex mode and the transmission rate cannot be modified for optical transmission, autonegotiation cannot be selected.

Transmission medium

Data transmission is over multimode fiber-optic cable (FO cable). The wavelength is 1310 nm.

Multimode fiber-optic cables are used with a core of 50 or 62.5 μm ; the light source is an LED.

The outer diameter of the FO cable is 125 μm .

Transmission range

The maximum transmission range (segment length) is up to 5 km depending on the cable type.

Connectors

The cables are connected over BFOC sockets.

3.14 SCALANCE X204-2LD

3.14.1 SCALANCE X204-2LD product characteristics

Possible attachments

The SCALANCE X204-2LD has four RJ-45 jacks and two BFOC ports for the connection of end devices or other network segments.

Note

The BFOC socket (Bayonet Fiber Optic Connector) corresponds to the ST socket.



Figure 3-21 SCALANCE X204-2LD

3.14.2 SCALANCE X204-2LD TP ports

Connector pinout

On the SCALANCE X204-2LD, the TP ports are implemented as RJ-45 jacks with MDI-X assignment (Medium Dependent Interface–Autocrossover) of a network component.

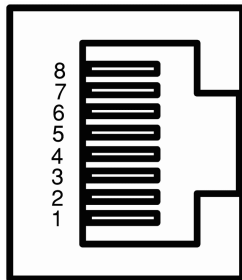

Figure 3-22 RJ-45 jack

Table 3- 14 Pin assignment

Pin number	Assignment
Pin 8	n. c.
Pin 7	n. c.
Pin 6	TD-
Pin 5	n. c.
Pin 4	n. c.
Pin 3	TD+
Pin 2	RD-
Pin 1	RD+

NOTICE

TP cords or TP-XP cords with a maximum length of 10 m can be connected to the RJ-45 TP port.

With the IE FC cables and IE FC RJ-45 plug 180, an overall cable length of a maximum of 100 m is permitted between two devices depending on the cable type.

Autonegotiation

Autonegotiation means the automatic detection of the functionality of the port at the opposite end. Using autonegotiation, repeaters or end devices can detect the functionality available at the port of a partner device allowing automatic configuration of different types of device. With autonegotiation, two components connected to a link segment can exchange parameters and set themselves to match the supported communication functionality.

Note

If an IE switch port operating in autonegotiation mode is connected to a partner device that is not operating in autonegotiation mode, the partner device must be set permanently to half duplex mode.

If an IE switch port is set permanently to full duplex, the connected partner device must also be set to full duplex.

If the autonegotiation function is disabled, the MDI/MDI-X autocrossover function is also inactive. This means it may be necessary to use a crossover cable.

Note

The SCALANCE X204-2LD is a plug-and-play device that does not require settings to be made for commissioning.

MDI /MDIX autocrossover function

The advantage of the MDI /MDIX autocrossover function is that straight-through cables can be used throughout and crossover Ethernet cables are unnecessary. This prevents malfunctions resulting from mismatching send and receive wires. This makes installation much easier for the user.

IE Switches X-200 support the MDI / MDIX autocrossover function.

NOTICE

Please note that the direct connection of two ports on the switch or accidental connection over several switches causes an illegal loop. Such a loop can lead to network overload and network failures.

Auto polarity exchange

If the pair of receiving cables are incorrectly connected (RD+ and RD- swapped over), the polarity is reversed automatically.

3.14.3 SCALANCE X204-2LD TP ports

Transmission rate

The transmission speed of the optical Fast Ethernet ports is 100 Mbps.

Transmission mode

The transmission mode for 100Base-FX is specified in the IEEE 802.3 standard.

Since the full duplex mode and the transmission rate cannot be modified for optical transmission, autonegotiation cannot be selected.

Transmission medium

Data transmission is over single mode fiber-optic cable (FOC). The wavelength is 1310 nm.

Single mode fiber-optic cables are used with a core of 9 μm ; the light source is an LED.

The outer diameter of the FOC is 125 μm .

Transmission range

The maximum transmission range (segment length) is 26 km.

Connectors

The cables are connected over BFOC sockets.

Note

The SCALANCE X204-2LD may only be coupled over its optical ports with

- SCALANCE X204-2LD
- SCALANCE X206-1LD
- SCALANCE X212-2LD
- SCALANCE X-400 with module type MM491-2LD
- SCALANCE X101-LD
- OMC TP11-LD
- OSM ITP62-LD

Coupling optical ports with

- SCALANCE X106-1
- SCALANCE X104-2
- SCALANCE X206-1
- SCALANCE XF206-1
- SCALANCE X204-2
- SCALANCE XF204-2
- SCALANCE X202-2IRT
- SCALANCE X212-2
- SCALANCE X-400 with module type MM491-2
- OMC TP11
- OSM ITP62
- OSM ITP53
- OSM TP62

is not permitted.

3.15 SCALANCE X206-1LD

3.15.1 SCALANCE X206-1LD product characteristics

Possible attachments

The SCALANCE X206-1LD has six RJ-45 jacks and a BFOC port for the connection of end devices or other network segments.

Note

The BFOC socket (Bayonet Fiber Optic Connector) corresponds to the ST socket.



Figure 3-23 SCALANCE X206-1LD

3.15.2 SCALANCE X206-1LD TP ports

Connector pinout

On the SCALANCE X206-1LD, the TP ports are implemented as RJ-45 jacks with MDI-X assignment (Medium Dependent Interface–Autocrossover) of a network component.

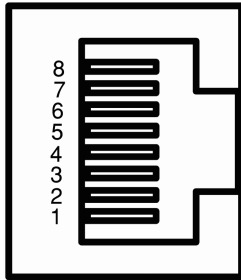

Figure 3-24 RJ-45 jack

Table 3- 15 Pin assignment

Pin number	Assignment
Pin 8	n. c.
Pin 7	n. c.
Pin 6	TD-
Pin 5	n. c.
Pin 4	n. c.
Pin 3	TD+
Pin 2	RD-
Pin 1	RD+

NOTICE

TP cords or TP-XP cords with a maximum length of 10 m can be connected to the RJ-45 TP port.

With the IE FC cables and IE FC RJ-45 plug 180, an overall cable length of a maximum of 100 m is permitted between two devices depending on the cable type.

Autonegotiation

Autonegotiation means the automatic detection of the functionality of the port at the opposite end. Using autonegotiation, repeaters or end devices can detect the functionality available at the port of a partner device allowing automatic configuration of different types of device. With autonegotiation, two components connected to a link segment can exchange parameters and set themselves to match the supported communication functionality.

Note

If an IE switch port operating in autonegotiation mode is connected to a partner device that is not operating in autonegotiation mode, the partner device must be set permanently to half duplex mode.

If an IE switch port is set permanently to full duplex, the connected partner device must also be set to full duplex.

If the autonegotiation function is disabled, the MDI/MDI-X autocrossover function is also inactive. This means it may be necessary to use a crossover cable.

Note

The SCALANCE X206-1LD is a plug-and-play device that does not require settings to be made for commissioning.

MDI /MDIX autocrossover function

The advantage of the MDI /MDIX autocrossover function is that straight-through cables can be used throughout and crossover Ethernet cables are unnecessary. This prevents malfunctions resulting from mismatching send and receive wires. This makes installation much easier for the user.

IE Switches X-200 support the MDI / MDIX autocrossover function.

NOTICE
Please note that the direct connection of two ports on the switch or accidental connection over several switches causes an illegal loop. Such a loop can lead to network overload and network failures.

Auto polarity exchange

If the pair of receiving cables are incorrectly connected (RD+ and RD- swapped over), the polarity is reversed automatically.

3.15.3 SCALANCE X206-1LD FO ports

Transmission rate

The transmission speed of the optical Fast Ethernet ports is 100 Mbps.

Transmission mode

The transmission mode for 100Base-FX is specified in the IEEE 802.3 standard.

Since the full duplex mode and the transmission rate cannot be modified for optical transmission, autonegotiation cannot be selected.

Transmission medium

Data transmission is over single mode fiber-optic cable (FOC). The wavelength is 1310 nm.

Single mode fiber-optic cables are used with a core of 9 µm; the light source is an LED.

The outer diameter of the FOC is 125 µm.

Transmission range

The maximum transmission range (segment length) is 26 km.

Connectors

The cables are connected over BFOC sockets.

Note

The SCALANCE X206-1LD may only be coupled over its optical ports with

- SCALANCE X212-2LD
- SCALANCE X204-2LD
- SCALANCE X206-1LD
- SCALANCE X-400 with module type MM491-2LD
- SCALANCE X101-LD
- OMC TP11-LD
- OSM ITP62-LD

Coupling optical ports with

- SCALANCE X106-1
- SCALANCE X104-2
- SCALANCE X206-1
- SCALANCE XF206-1
- SCALANCE X204-2
- SCALANCE XF204-2
- SCALANCE X202-2IRT
- SCALANCE X212-2
- SCALANCE X-400 with module type MM491-2
- OMC TP11
- OSM ITP62
- OSM ITP53
- OSM TP62

is not permitted.

3.16 SCALANCE X212-2LD

3.16.1 SCALANCE X212-2LD product characteristics

Possible attachments

The SCALANCE X212-2LD has twelve RJ-45 jacks and two BFOC ports for the connection of end devices or other network segments.

Note

The BFOC socket (Bayonet Fiber Optic Connector) corresponds to the ST socket.



Figure 3-25 SCALANCE X 212-2LD

3.16.2 SCALANCE X212-2LD TP ports

Connector pinout

On the SCALANCE X212-2LD, the TP ports are implemented as RJ-45 jacks with MDI-X assignment (Medium Dependent Interface–Autocrossover) of a network component.

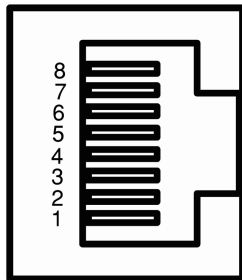

Figure 3-26 RJ-45 jack

Table 3- 16 Pin assignment

Pin number	Assignment
Pin 8	n. c.
Pin 7	n. c.
Pin 6	TD-
Pin 5	n. c.
Pin 4	n. c.
Pin 3	TD+
Pin 2	RD-
Pin 1	RD+

NOTICE

TP cords or TP-XP cords with a maximum length of 10 m can be connected to the RJ-45 TP port.

With the IE FC cables and IE FC RJ-45 plug 180, an overall cable length of up to 100 m is permitted between two devices depending on the cable type.

Autonegotiation

Autonegotiation means the automatic detection of the functionality of the port at the opposite end. Using autonegotiation, repeaters or end devices can detect the functionality available at the port of a partner device allowing automatic configuration of different types of device. With autonegotiation, two components connected to a link segment can exchange parameters and set themselves to match the supported communication functionality.

Note

If an IE switch port operating in autonegotiation mode is connected to a partner device that is not operating in autonegotiation mode, the partner device must be set permanently to half duplex mode.

If an IE switch port is set permanently to full duplex, the connected partner device must also be set to full duplex.

If the autonegotiation function is disabled, the MDI/MDI-X autocrossover function is also inactive. This means it may be necessary to use a crossover cable.

Note

The SCALANCE X212-2LD is a plug-and-play device that does not require settings to be made for commissioning.

MDI /MDIX autocrossover function

The advantage of the MDI /MDIX autocrossover function is that straight-through cables can be used throughout and crossover Ethernet cables are unnecessary. This prevents malfunctions resulting from mismatching send and receive wires. This makes installation much easier for the user.

IE Switches X-200 support the MDI / MDIX autocrossover function.

NOTICE

Please note that the direct connection of two ports on the switch or accidental connection over several switches causes an illegal loop. Such a loop can lead to network overload and network failures.

Auto polarity exchange

If the pair of receiving cables are incorrectly connected (RD+ and RD- swapped over), the polarity is reversed automatically.

3.16.3 SCALANCE X212-2LD FO ports

Transmission rate

The transmission speed of the optical Fast Ethernet ports is 100 Mbps.

Transmission mode

The transmission mode for 100Base-FX is specified in the IEEE 802.3 standard.

Since the full duplex mode and the transmission rate cannot be modified for optical transmission, autonegotiation cannot be selected.

Transmission medium

Data transmission is over single mode fiber-optic cable (FOC). The wavelength is 1310 nm.

Single mode fiber-optic cables are used with a core of 9 µm; the light source is an LED.

The outer diameter of the FOC is 125 µm.

Transmission range

The maximum transmission range (segment length) is 26 km.

Connectors

The cables are connected over BFOC sockets.

Note

The SCALANCE X212-2LD may only be coupled over its optical ports with

- SCALANCE X212-2LD
- SCALANCE X204-2LD
- SCALANCE X206-1LD
- SCALANCE X-400 with module type MM491-2LD
- SCALANCE X101-LD
- OMC TP11-LD
- OSM ITP62-LD

Coupling optical ports with

- SCALANCE X106-1
- SCALANCE X104-2
- SCALANCE X206-1
- SCALANCE XF206-1
- SCALANCE X204-2
- SCALANCE XF204-2
- SCALANCE X202-2IRT
- SCALANCE X212-2
- SCALANCE X-400 with module type MM491-2
- OMC TP11
- OSM ITP62
- OSM ITP53
- OSM TP62

is not permitted.

3.17 SCALANCE X202-2IRT

3.17.1 SCALANCE X202-2IRT product characteristics

Possible attachments

The SCALANCE X202-2IRT has two RJ-45 jacks and two BFOC ports for the connection of end devices or other network segments.

Note

The BFOC socket (Bayonet Fiber Optic Connector) corresponds to the ST socket.



Figure 3-27 SCALANCE X202-2IRT

3.17.2 SCALANCE X202-2IRT TP ports

Connector pinout

On the SCALANCE X202-2IRT, the TP ports are implemented as RJ-45 jacks with MDI-X assignment (Medium Dependent Interface–Autocrossover) of a network component.

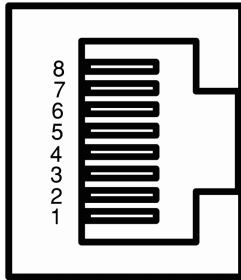

Figure 3-28 RJ-45 jack

Table 3- 17 Pin assignment

Pin number	Assignment
Pin 8	n. c.
Pin 7	n. c.
Pin 6	TD-
Pin 5	n. c.
Pin 4	n. c.
Pin 3	TD+
Pin 2	RD-
Pin 1	RD+

NOTICE

TP cords or TP-XP cords with a maximum length of 10 m can be connected to the RJ-45 TP port.

With the IE FC cables and IE FC RJ-45 plug 180, an overall cable length of a maximum of 100 m is permitted between two devices depending on the cable type.

Autonegotiation

Autonegotiation means the automatic detection of the functionality of the port at the opposite end. Using autonegotiation, repeaters or end devices can detect the functionality available at the port of a partner device allowing automatic configuration of different types of device. With autonegotiation, two components connected to a link segment can exchange parameters and set themselves to match the supported communication functionality.

Note

If an IE switch port operating in autonegotiation mode is connected to a partner device that is not operating in autonegotiation mode, the partner device must be set permanently to half duplex mode.

If an IE switch port is set permanently to full duplex, the connected partner device must also be set to full duplex.

If the autonegotiation function is disabled, the MDI/MDI-X autocrossover function is also inactive. This means it may be necessary to use a crossover cable.

Note

The SCALANCE X202-2IRT is a plug-and-play device that does not require settings to be made for commissioning.

MDI /MDIX autocrossover function

The advantage of the MDI /MDIX autocrossover function is that straight-through cables can be used throughout and crossover Ethernet cables are unnecessary. This prevents malfunctions resulting from mismatching send and receive wires. This makes installation much easier for the user.

IE Switches X-200 support the MDI / MDIX autocrossover function.

NOTICE
Please note that the direct connection of two ports on the switch or accidental connection over several switches causes an illegal loop. Such a loop can lead to network overload and network failures.

Auto polarity exchange

If the pair of receiving cables are incorrectly connected (RD+ and RD- swapped over), the polarity is reversed automatically.

3.17.3 SCALANCE X202-2IRT FO ports

Transmission speed

The transmission speed of the optical Fast Ethernet ports is 100 Mbps.

Transmission mode

The transmission mode for 100Base-FX is specified in the IEEE 802.3 standard.

Since the full duplex mode and the transmission rate cannot be modified for optical transmission, autonegotiation cannot be selected.

Transmission medium

Data transmission is over multimode fiber-optic cable (FO cable). The wavelength is 1310 nm.

Multimode fiber-optic cables are used with a core of 50 or 62.5 μm ; the light source is an LED.

The outer diameter of the FO cable is 125 μm .

Transmission range

The maximum transmission range (segment length) is up to 5 km depending on the cable type.

Connectors

The cables are connected over BFOC sockets.

3.18 SCALANCE X204IRT

3.18.1 SCALANCE X204IRT product characteristics

Possible attachments

The SCALANCE X204IRT has four RJ-45 jacks for connecting end devices or other network segments.



Figure 3-29 SCALANCE X204IRT

3.18.2 SCALANCE X204IRT TP ports

Connector pinout

On the SCALANCE X204IRT, the TP ports are implemented as RJ-45 jacks with MDI-X assignment (Medium Dependent Interface–Autocrossover) of a network component.

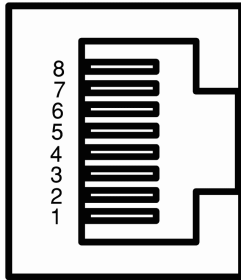

Figure 3-30 RJ-45 jack

Table 3- 18 Pin assignment

Pin number	Assignment
Pin 8	n. c.
Pin 7	n. c.
Pin 6	TD-
Pin 5	n. c.
Pin 4	n. c.
Pin 3	TD+
Pin 2	RD-
Pin 1	RD+

NOTICE

TP cords or TP-XP cords with a maximum length of 10 m can be connected to the RJ-45 TP port.

With the IE FC cables and IE FC RJ-45 plug 180, an overall cable length of up to 100 m is permitted between two devices depending on the cable type.

Autonegotiation

Autonegotiation means the automatic detection of the functionality of the port at the opposite end. Using autonegotiation, repeaters or end devices can detect the functionality available at the port of a partner device allowing automatic configuration of different types of device. With autonegotiation, two components connected to a link segment can exchange parameters and set themselves to match the supported communication functionality.

Note

If an IE switch port operating in autonegotiation mode is connected to a partner device that is not operating in autonegotiation mode, the partner device must be set permanently to half duplex mode.

If an IE switch port is set permanently to full duplex, the connected partner device must also be set to full duplex.

If the autonegotiation function is disabled, the MDI/MDI-X autocrossover function is also inactive. This means it may be necessary to use a crossover cable.

Note

The SCALANCE X204IRT is a plug-and-play device that does not require settings to be made for commissioning.

MDI /MDIX autocrossover function

The advantage of the MDI /MDIX autocrossover function is that straight-through cables can be used throughout and crossover Ethernet cables are unnecessary. This prevents malfunctions resulting from mismatching send and receive wires. This makes installation much easier for the user.

IE Switches X-200 support the MDI / MDIX autocrossover function.

NOTICE

Please note that the direct connection of two ports on the switch or accidental connection over several switches causes an illegal loop. Such a loop can lead to network overload and network failures.

Auto polarity exchange

If the pair of receiving cables are incorrectly connected (RD+ and RD- swapped over), the polarity is reversed automatically.

3.19 SCALANCE XF204IRT

3.19.1 SCALANCE XF204IRT product characteristics

Possible attachments

The SCALANCE XF204IRT has four RJ-45 jacks for connecting end devices or other network segments.



Figure 3-31 SCALANCE XF204IRT

3.19.2 SCALANCE XF204IRT TP ports

Connector pinout

On the SCALANCE XF204IRT, the TP ports are implemented as RJ-45 jacks with the MDI-X assignment (Medium Dependent Interface Autocrossover) of a network component.

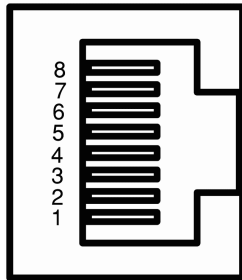

Figure 3-32 RJ-45 jack

Table 3- 19 Pin assignment

Pin number	Assignment
Pin 8	n. c.
Pin 7	n. c.
Pin 6	TD-
Pin 5	n. c.
Pin 4	n. c.
Pin 3	TD+
Pin 2	RD-
Pin 1	RD+

NOTICE

TP cords or TP-XP cords with a maximum length of 10 m can be connected to the RJ-45 TP port.

With the IE FC cables and IE FC RJ-45 plug 180, an overall cable length of up to 100 m is permitted between two devices depending on the cable type.

Autonegotiation

Autonegotiation means the automatic detection of the functionality of the port at the opposite end. Using autonegotiation, repeaters or end devices can detect the functionality available at the port of a partner device allowing automatic configuration of different types of device. With autonegotiation, two components connected to a link segment can exchange parameters and set themselves to match the supported communication functionality.

Note

If an IE switch port operating in autonegotiation mode is connected to a partner device that is not operating in autonegotiation mode, the partner device must be set permanently to half duplex mode.

If an IE switch port is set permanently to full duplex, the connected partner device must also be set to full duplex.

If the autonegotiation function is disabled, the MDI/MDI-X autocrossover function is also inactive. This means it may be necessary to use a crossover cable.

Note

The SCALANCE XF204IRT is a plug-and-play device that does not require settings to be made for commissioning.

MDI /MDIX autocrossover function

The advantage of the MDI /MDIX autocrossover function is that straight-through cables can be used throughout and crossover Ethernet cables are unnecessary. This prevents malfunctions resulting from mismatching send and receive wires. This makes installation much easier for the user.

IE Switches X-200 support the MDI / MDIX autocrossover function.

NOTICE

Please note that the direct connection of two ports on the switch or accidental connection over several switches causes an illegal loop. Such a loop can lead to network overload and network failures.

Auto polarity exchange

If the pair of receiving cables are incorrectly connected (RD+ and RD- swapped over), the polarity is reversed automatically.

3.20 SCALANCE X204 IRT PRO

3.20.1 SCALANCE X204 IRT PRO product characteristics

Possible attachments

The SCALANCE X204 IRT PRO has four RJ-45 push-pull interfaces (PROFINET-compliant in accordance with IEC 61076-3-117) with the high degree of protection IP65/67 for connection of end devices or further network segments.



Figure 3-33 SCALANCE X204 IRT PRO

3.20.2 SCALANCE X204 IRT PRO TP ports

Connector pinout

On the SCALANCE X204 IRT PRO, the TP ports are implemented as RJ-45 jacks with MDI-X assignment (Medium Dependent Interface–Autocrossover) of a network component.

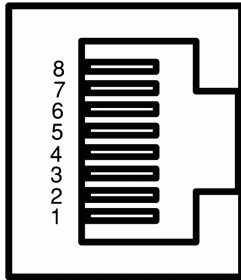

Figure 3-34 RJ-45 jack

Table 3-20 Pin assignment

Pin number	Assignment
Pin 8	n. c.
Pin 7	n. c.
Pin 6	TD-
Pin 5	n. c.
Pin 4	n. c.
Pin 3	TD+
Pin 2	RD-
Pin 1	RD+

NOTICE

TP cords or TP-XP cords with a maximum length of 10 m can be connected to the RJ-45 TP port.

With the IE FC cables and IE RJ-45 Plug PRO 180, an overall cable length of up to 100 m is permitted between two devices depending on the cable type.

Autonegotiation

Autonegotiation means the automatic detection of the functionality of the port at the opposite end. Using autonegotiation, repeaters or end devices can detect the functionality available at the port of a partner device allowing automatic configuration of different types of device. With autonegotiation, two components connected to a link segment can exchange parameters and set themselves to match the supported communication functionality.

Note

If an IE switch port operating in autonegotiation mode is connected to a partner device that is not operating in autonegotiation mode, the partner device must be set permanently to half duplex mode.

If an IE switch port is set permanently to full duplex, the connected partner device must also be set to full duplex.

If the autonegotiation function is disabled, the MDI/MDI-X autocrossover function is also inactive. This means it may be necessary to use a crossover cable.

Note

The SCALANCE X204 IRT PRO is a plug-and-play device that does not require settings to be made for commissioning.

MDI /MDIX autocrossover function

The advantage of the MDI /MDIX autocrossover function is that straight-through cables can be used throughout and crossover Ethernet cables are unnecessary. This prevents malfunctions resulting from mismatching send and receive wires. This makes installation much easier for the user.

IE Switches X-200 support the MDI / MDIX autocrossover function.

NOTICE

Please note that the direct connection of two ports on the switch or accidental connection over several switches causes an illegal loop. Such a loop can lead to network overload and network failures.

Auto polarity exchange

If the pair of receiving cables are incorrectly connected (RD+ and RD- swapped over), the polarity is reversed automatically.

3.21 SCALANCE X202-2P IRT PRO

3.21.1 SCALANCE X202-2P IRT PRO product characteristics

Possible attachments

The SCALANCE X202-2P IRT PRO has two RJ-45 push-pull interfaces (PROFINET-compliant in accordance with IEC 61076-3-117) with the high degree of protection IP65/67 and two SC RJ push-pull interfaces (PROFINET-compliant in accordance with IEC 61754-24-2) with the high degree of protection IP65/67 for the connection of the end devices or further network segments.

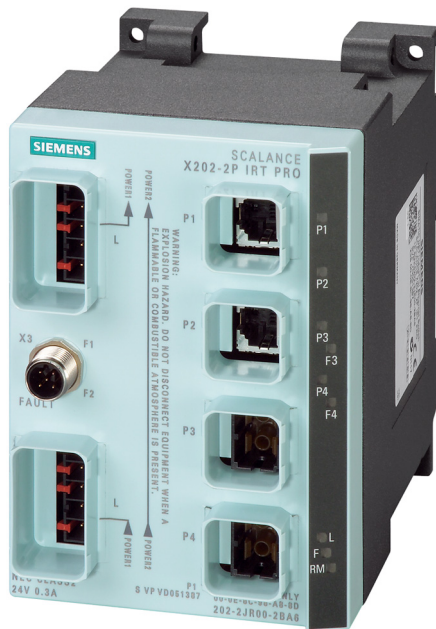

Figure 3-35 SCALANCE X202-2P IRT PRO

3.21.2 SCALANCE X202-2P IRT PRO TP ports

Connector pinout

On the SCALANCE X202-2P IRT PRO, the TP ports are implemented as RJ-45 ports with MDI-X assignment (Medium Dependent Interface–Autocrossover) of a network component.

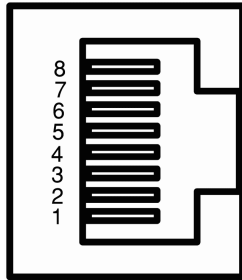

Figure 3-36 RJ-45 jack

Table 3- 21 Pin assignment

Pin number	Assignment
Pin 8	n. c.
Pin 7	n. c.
Pin 6	TD-
Pin 5	n. c.
Pin 4	n. c.
Pin 3	TD+
Pin 2	RD-
Pin 1	RD+

NOTICE

TP cords or TP-XP cords with a maximum length of 10 m can be connected to the RJ-45 TP port.

With the IE FC cables and IE RJ-45 Plug PRO 180, an overall cable length of a maximum of 100 m is permitted between two devices depending on the cable type.

Autonegotiation

Autonegotiation means the automatic detection of the functionality of the port at the opposite end. Using autonegotiation, repeaters or end devices can detect the functionality available at the port of a partner device allowing automatic configuration of different types of device. With autonegotiation, two components connected to a link segment can exchange parameters and set themselves to match the supported communication functionality.

Note

If an IE switch port operating in autonegotiation mode is connected to a partner device that is not operating in autonegotiation mode, the partner device must be set permanently to half duplex mode.

If an IE switch port is set permanently to full duplex, the connected partner device must also be set to full duplex.

If the autonegotiation function is disabled, the MDI/MDI-X autocrossover function is also inactive. This means it may be necessary to use a crossover cable.

Note

The SCALANCE X202-2P IRT PRO is a plug-and-play device that does not require settings to be made for commissioning.

MDI /MDIX autocrossover function

The advantage of the MDI /MDIX autocrossover function is that straight-through cables can be used throughout and crossover Ethernet cables are unnecessary. This prevents malfunctions resulting from mismatching send and receive wires. This makes installation much easier for the user.

IE Switches X-200 all support the MDI / MDIX autocrossover function.

NOTICE

Please note that the direct connection of two ports on the switch or accidental connection over several switches causes an illegal loop. Such a loop can lead to network overload and network failures.

Auto polarity exchange

If the pair of receiving cables are incorrectly connected (RD+ and RD- swapped over), the polarity is reversed automatically.

3.21.3 SCALANCE X202-2P IRT PRO FO ports

Transmission rate

The transmission rate of the optical Fast Ethernet ports is 100 Mbps.

Transmission mode

Since the full duplex mode and the transmission rate cannot be modified for optical transmission, autonegotiation cannot be selected.

Transmission medium

Data is transferred using plastic optical fiber (POF) or polymer cladded fiber (PCF). The wavelength is 650 nm.

POF cables with a core diameter of 980 µm as well as PCF cables with a core diameter of 200 µm are used. The light source is an LED.

Transmission range

The minimum cable length is 1 m. The maximum transmission distance (segment length) is 50 m for POF and 100 m for PCF cables.

Connectors

The cables are connected over SC-RJ sockets.

3.22 SCALANCE X201-3P IRT PRO

3.22.1 SCALANCE X201-3P IRT PRO product characteristics

Possible attachments

The SCALANCE X201-3P IRT PRO has an RJ-45 push pull interface (PROFINET-compliant according to IEC61076-3-117) with the high degree of protection IP65/67, and three SC RJ push pull interfaces (PROFINET-compliant according to IEC61754-24-2) with the high degree of protection IP65/67 for connection of end devices or other network segments.



Figure 3-37 SCALANCE X201-3P IRT PRO

3.22.2 SCALANCE X201-3P IRT PRO TP interfaces

Connector pinout

On the SCALANCE X201-3P IRT PRO, the TP interface is implemented as RJ-45 ports with MDI-X assignment (Medium Dependent Interface Crossover) of a network component.

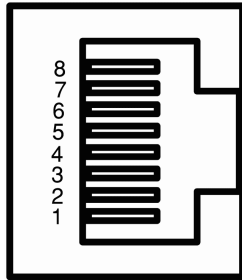

Figure 3-38 RJ-45 jack

Table 3- 22 Pin assignment

Pin number	Assignment
Pin 8	n. c.
Pin 7	n. c.
Pin 6	TD-
Pin 5	n. c.
Pin 4	n. c.
Pin 3	TD+
Pin 2	RD-
Pin 1	RD+

NOTICE

TP cords or TP-XP cords with a maximum length of 10 m can be connected to the RJ-45 TP port.

With the IE FC cables and IE RJ45 Plug PRO 180, an overall cable length of a maximum of 100 m is permitted between two devices depending on the cable type.

Autonegotiation

Autonegotiation means the automatic detection of the functionality of the port at the opposite end. Using autonegotiation, repeaters or end devices can detect the functionality available at the port of a partner device allowing automatic configuration of different types of device. With autonegotiation, two components connected to a link segment can exchange parameters and set themselves to match the supported communication functionality.

Note

If an IE switch port operating in autonegotiation mode is connected to a partner device that is not operating in autonegotiation mode, the partner device must be set permanently to half duplex mode.

If an IE switch port is set permanently to full duplex, the connected partner device must also be set to full duplex.

If the autonegotiation function is disabled, the MDI/MDI-X autocrossover function is also inactive. This means it may be necessary to use a crossover cable.

Note

The SCALANCE X201-3P IRT PRO is a plug-and-play device that does not require settings to be made for commissioning.

MDI/MDIX autocrossover function

The advantage of the MDI/MDIX autocrossover function is that straight-through cables can be used throughout and external Ethernet crossover cables are unnecessary. This prevents malfunctions resulting from mismatching send and receive wires. This makes installation much easier for the user.

All IE Switches X-200 support the MDI / MDIX autocrossover function.

NOTICE

Please note that a direct connection of two ports on the switch or an accidental connection across several switches causes a forbidden loop. Such a loop can lead to network overload and network failures.

Auto polarity exchange

If the pair of receiving cables are incorrectly connected (RD+ and RD- swapped over), the polarity is reversed automatically.

3.22.3 SCALANCE X201-3P IRT PRO FO interfaces

Transmission rate

The transmission rate of the optical Fast Ethernet ports is 100 Mbps.

Transmission mode

Since the full duplex mode and the transmission rate cannot be modified for optical transmission, autonegotiation cannot be selected.

Transmission medium

Data is transferred using plastic optical fiber (POF) or polymer cladded fiber (PCF). The wavelength is 650 nm.

POF cables with a core diameter of 980 µm as well as PCF cables with a core diameter of 200 µm are used. The light source is an LED.

Transmission range

The minimum cable length is 1 m. The maximum transmission distance (segment length) is 50 m for POF and 100 m for PCF cables.

Connectors

The cables are connected over SC-RJ sockets.

3.23 SCALANCE X202-2P IRT

3.23.1 SCALANCE X202-2P IRT product characteristics

Possible attachments

The SCALANCE X202-2P IRT has two RJ-45 jacks and two SC RJ interfaces for connecting end devices or other network segments.



Figure 3-39 SCALANCE X202-2P IRT

3.23.2 SCALANCE X202-2P IRT TP ports

Connector pinout

On the SCALANCE X202-2P IRT, the TP ports are implemented as RJ-45 jacks with MDI-X assignment (Medium Dependent Interface–Autocrossover) of a network component.

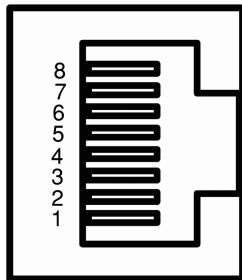

Figure 3-40 RJ-45 jack

Table 3- 23 Pin assignment

Pin number	Assignment
Pin 8	n. c.
Pin 7	n. c.
Pin 6	TD-
Pin 5	n. c.
Pin 4	n. c.
Pin 3	TD+
Pin 2	RD-
Pin 1	RD+

NOTICE

TP cords or TP-XP cords with a maximum length of 10 m can be connected to the RJ-45 TP port.

With the IE FC cables and IE FC RJ-45 plug 180, an overall cable length of a maximum of 100 m is permitted between two devices depending on the cable type.

Autonegotiation

Autonegotiation means the automatic detection of the functionality of the port at the opposite end. Using autonegotiation, repeaters or end devices can detect the functionality available at the port of a partner device allowing automatic configuration of different types of device. With autonegotiation, two components connected to a link segment can exchange parameters and set themselves to match the supported communication functionality.

Note

If an IE switch port operating in autonegotiation mode is connected to a partner device that is not operating in autonegotiation mode, the partner device must be set permanently to half duplex mode.

If an IE switch port is set permanently to full duplex, the connected partner device must also be set to full duplex.

If the autonegotiation function is disabled, the MDI/MDI-X autocrossover function is also inactive. This means it may be necessary to use a crossover cable.

Note

The SCALANCE X202-2P IRT is a plug-and-play device that does not require settings to be made for commissioning.

MDI /MDIX autocrossover function

The advantage of the MDI /MDIX autocrossover function is that straight-through cables can be used throughout and crossover Ethernet cables are unnecessary. This prevents malfunctions resulting from mismatching send and receive wires. This makes installation much easier for the user.

IE Switches X-200 all support the MDI / MDIX autocrossover function.

NOTICE

Please note that the direct connection of two ports on the switch or accidental connection over several switches causes an illegal loop. Such a loop can lead to network overload and network failures.

Auto polarity exchange

If the pair of receiving cables are incorrectly connected (RD+ and RD- swapped over), the polarity is reversed automatically.

3.23.3 SCALANCE X202-2P IRT FO ports

Transmission rate

The transmission rate of the optical Fast Ethernet ports is 100 Mbps.

Transmission mode

Since the full duplex mode and the transmission rate cannot be modified for optical transmission, autonegotiation cannot be selected.

Transmission medium

Data is transferred using plastic optical fiber (POF) or polymer cladded fiber (PCF). The wavelength is 650 nm.

POF cables with a core diameter of 980 µm as well as PCF cables with a core diameter of 200 µm are used. The light source is an LED.

Transmission range

The minimum cable length is 1 m. The maximum transmission distance (segment length) is 50 m for POF and 100 m for PCF cables.

Connectors

The cables are connected over SC-RJ sockets.

3.24 SCALANCE X201-3P IRT

3.24.1 SCALANCE X201-3P IRT product characteristics

Possible attachments

The SCALANCE X201-3P IRT has an RJ-45 jack and three SC RJ interfaces for connecting end devices or other network segments.



Figure 3-41 SCALANCE X201-3P IRT

3.24.2 SCALANCE X201-3P IRT TP ports

Connector pinout

On the SCALANCE X201-3P IRT, the TP port is implemented as an RJ-45 jack with MDI-X assignment (Medium Dependent Interface–Autocrossover) of a network component.

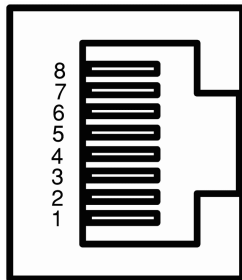

Figure 3-42 RJ-45 jack

Table 3- 24 Pin assignment

Pin number	Assignment
Pin 8	n. c.
Pin 7	n. c.
Pin 6	TD-
Pin 5	n. c.
Pin 4	n. c.
Pin 3	TD+
Pin 2	RD-
Pin 1	RD+

NOTICE

TP cords or TP-XP cords with a maximum length of 10 m can be connected to the RJ-45 TP port.

With the IE FC cables and IE FC RJ-45 plug 180, an overall cable length of a maximum of 100 m is permitted between two devices depending on the cable type.

Autonegotiation

Autonegotiation means the automatic detection of the functionality of the port at the opposite end. Using autonegotiation, repeaters or end devices can detect the functionality available at the port of a partner device allowing automatic configuration of different types of device. With autonegotiation, two components connected to a link segment can exchange parameters and set themselves to match the supported communication functionality.

Note

If an IE switch port operating in autonegotiation mode is connected to a partner device that is not operating in autonegotiation mode, the partner device must be set permanently to half duplex mode.

If an IE switch port is set permanently to full duplex, the connected partner device must also be set to full duplex.

If the autonegotiation function is disabled, the MDI/MDI-X autocrossover function is also inactive. This means it may be necessary to use a crossover cable.

Note

The SCALANCE X201-3P IRT is a plug-and-play device that does not require settings to be made for commissioning.

MDI /MDIX autocrossover function

The advantage of the MDI /MDIX autocrossover function is that straight-through cables can be used throughout and crossover Ethernet cables are unnecessary. This prevents malfunctions resulting from mismatching send and receive wires. This makes installation much easier for the user.

IE Switches X-200 support the MDI / MDIX autocrossover function.

NOTICE

Please note that the direct connection of two ports on the switch or accidental connection over several switches causes an illegal loop. Such a loop can lead to network overload and network failures.

Auto polarity exchange

If the pair of receiving cables are incorrectly connected (RD+ and RD- swapped over), the polarity is reversed automatically.

3.24.3 SCALANCE X201-3P IRT FO ports

Transmission rate

The transmission rate of the optical Fast Ethernet ports is 100 Mbps.

Transmission mode

Since the full duplex mode and the transmission rate cannot be modified for optical transmission, autonegotiation cannot be selected.

Transmission medium

Data is transferred using plastic optical fiber (POF) or polymer cladded fiber (PCF). The wavelength is 650 nm.

POF cables with a core diameter of 980 µm as well as PCF cables with a core diameter of 200 µm are used. The light source is an LED.

Transmission range

The minimum cable length is 1 m. The maximum transmission distance (segment length) is 50 m for POF and 100 m for PCF cables.

Connectors

The cables are connected over SC-RJ sockets.

3.25 SCALANCE X200-4P IRT

3.25.1 SCALANCE X200-4P IRT product characteristics

Possible attachments

The SCALANCE X200-4P IRT has four SC RJ interfaces for connecting end devices or other network segments.



Figure 3-43 SCALANCEX200 4PIRT

3.25.2 SCALANCE X200-4P IRT FO ports

Transmission rate

The transmission rate of the optical Fast Ethernet ports is 100 Mbps.

Transmission mode

Since the full duplex mode and the transmission rate cannot be modified for optical transmission, autonegotiation cannot be selected.

Transmission medium

Data is transferred using plastic optical fiber (POF) or polymer cladded fiber (PCF). The wavelength is 650 nm.

POF cables with a core diameter of 980 µm as well as PCF cables with a core diameter of 200 µm are used. The light source is an LED.

Transmission range

The minimum cable length is 1 m. The maximum transmission distance (segment length) is 50 m for POF and 100 m for PCF cables.

Connectors

The cables are connected over SC-RJ sockets.

3.26 C-PLUG (configuration plug)

Area of application

The C-PLUG is an exchangeable medium for storage of the configuration and project engineering data of the basic device. This means that the configuration data remains available if the basic device is replaced.

How it works

Power is supplied by the basic device. The C-PLUG retains all data permanently when the power is turned off.

If an empty C-PLUG (factory settings) is inserted, all configuration data of an IE Switch X-200 is saved to it when the device starts up. Changes to the configuration during operation are also saved on the C-PLUG without any operator intervention being necessary.

If a C-PLUG is inserted, the configuration stored internally on the basic device is no longer changed. All changes made to the configuration during ongoing operation are only stored on the C-PLUG.

A basic device with an inserted C-PLUG automatically uses the configuration data of the C-PLUG when it starts up. This is, however, only possible when the data was written by a compatible device type.

This allows fast and simple replacement of the basic device. If a device is replaced, the C-PLUG is taken from the failed component and inserted in the replacement device. The first time it is started up, the replacement device has the same configuration as the failed device except for the MAC address set by the vendor.

Compatible devices

As a general rule, the data on the C-PLUG is only compatible with devices having an identical order number and the same device name.

The device combinations shown in the following table are exceptions. With these devices, the exchange of the C-PLUG is possible in one direction.

Table 3- 25 Device combinations between which the C-PLUG can be exchanged:

Device type SCALANCE	C-PLUG created by device with order number		Compatible with device with order number
X208	6GK5208-0BA00-2AA3	➔	6GK5208-0BA10-2AA3
X204-2	6GK5204-2BB00-2AA3		6GK5204-2BB10-2AA3
X206-1	6GK5206-1BB00-2AA3		6GK5206-1BB10-2AA3
X204-1LD	6GK5204-2BC00-2AA3		6GK5204-2BC10-2AA3
X206-1LD	6GK5206-1BC00-2AA3		6GK5206-1BC10-2AA3

Note

Combinations other than those shown in the table are not compatible with each other.

Note

If a C-PLUG is adopted in a compatible device as shown in the table, the system name of the original device is adopted both in the system name and in the PNIO device name of the compatible device.

Using a previously written C-PLUG

If you want to insert a C-PLUG that has already been used and has been written to an IE Switch X-200 with a different configuration, the existing C-PLUG data must first be deleted.

Note

An IE Switch X-200 normally starts up with the configuration of the C-PLUG, assuming this was written to by a compatible device type. If the C-PLUG was written by an incompatible device type, the basic device will not start up fully and signals an error. The WBM menu "System C-PLUG" is displayed automatically. Here, you can use the "Modify C-PLUG" function to specify whether or not the device operates with a C-PLUG.

If you select operation with a C-PLUG, this can be initialized either with the factory defaults or with settings from the internal memory of the device.

Diagnostics

Inserting a C-PLUG that does not contain the configuration of a compatible device type, inadvertently removing the C-PLUG, or general malfunctions of the C-PLUG are indicated by the diagnostic mechanisms of an IE Switch X-200 (LEDs, PROFINET, SNMP, WBM, etc.).

Inserting in the C-PLUG slot

The C-PLUG is not supplied with the IE Switches X-200. It is available as an optional accessory.

The slot for the C-PLUG is located as follows:

- On the IE Switch X-200 on the back of the device
- On the IE Switch XF-200 on the left hand side of the device

3.26 C-PLUG (configuration plug)

To insert the C-PLUG, remove the screw cover. The C-PLUG is inserted in the receptacle. The screw cover must then be closed correctly.

NOTICE

The C-PLUG may only be inserted or removed when the power is off!

Removing the C-PLUG

It is only necessary to remove the C-PLUG if the IE Switch X-200 develops a fault.

The C-PLUG can be removed from the slot using flat pliers, tweezers, or a small screwdriver.

If a C-PLUG has been taken from a device, when the device is restarted, an error message is output in Web Based Management and in the Command Line Interface.

In this case, you will need to set the device to operation without C-PLUG. For further information, refer to the section "System C-PLUG WBM menu".



Figure 3-44 Removing the C-PLUG from the receptacle

3.27 Button

Button function

You can change various device settings with the button. Modified settings are retained after device power off/on.

Different settings are made depending on how long you hold down the button:

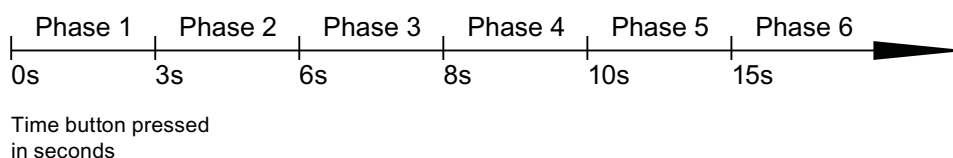

Phase	Description
1	The currently set fault mask is displayed. If no fault mask has been set, all ports flash one after the other. If you release the button in phase 1, this has no effect.
2	The LEDs of the ports at which there is currently a link flash at 2.5 Hz. If you release the button in phase 2, this has no effect.
3	The LEDs of the ports at which there is currently a link and the LEDs of the connected power supply are lit permanently. If you release the button in phase 3, the fault mask corresponding to the lit LEDs is adopted.
4	The RM LED flashes. Releasing the button in phase 4 turns off the redundancy manager. The redundancy function remains enabled. The device changes to "Automatic Redundancy Detect" mode.
5	The RM LED is lit permanently. If you release the button in phase 5, the redundancy function is enabled and the device is configured as HSR manager.
6	All LEDs flash. The device is reset to the factory defaults.

Note

On the SCALANCE X204 IRT PRO, SCALANCE X202-2P IRT PRO and SCALANCE X201-3P IRT PRO, the button is beneath the C-PLUG cover on the rear of the device.

On the SCALANCE XF-200, the button is below the front panel.

3.28 Displays

3.28.1 Fault indicator (red LED)

Fault indicator (red LED)

If the red LED is lit, the IE Switch X-200 has detected a problem.
The signaling contact opens at the same time provided that the behavior of the signaling contact was not configured differently.

The LED signals that the IE Switch X-200 can adopt the following statuses:

Device type SCALANCE	LED lit red	LED flashing red	LED not lit
XF204	1, 2, 3, 4, 5, 6, 10	9	11
X208	1, 2, 3, 4, 5, 6, 10	9	11
XF208	1, 2, 3, 4, 5, 6, 10	9	11
X216	1, 2, 3, 4, 5, 6, 10	9	11
X224	1, 2, 3, 4, 5, 6, 10	9	11
X204-2	1, 2, 3, 4, 5, 6, 10	9	11
X204-2TS	1, 2, 3, 4, 5, 6, 10	9	11
XF204-2	1, 2, 3, 4, 5, 6, 10	9	11
X206-1	1, 2, 3, 4, 5, 6, 10	9	11
XF206-1	1, 2, 3, 4, 5, 6, 10	9	11
X212-2	1, 2, 3, 4, 5, 6, 10	9	11
X204-2LD	1, 2, 3, 4, 5, 6, 10	9	11
X206-1LD	1, 2, 3, 4, 5, 6, 10	9	11
X212-2LD	1, 2, 3, 4, 5, 6, 10	9	11
X202-2IRT	1, 2, 3, 4, 5, 6, 7	9	11
X204IRT	1, 2, 3, 4, 5, 6, 7	9	11
XF204IRT	1, 2, 3, 4, 5, 6, 7	9	11
X204 IRT PRO	1, 3, 4, 5, 6, 7	9	11
X202-2P IRT PRO	1, 3, 4, 5, 6, 7, 8	9	11
X201-3P IRT PRO	1, 3, 4, 5, 6, 7, 8	9	11
X202-2P IRT	1, 2, 3, 4, 5, 6, 7, 8	9	11
X201-3P IRT	1, 2, 3, 4, 5, 6, 7, 8	9	11
X200-4P IRT	1, 2, 3, 4, 5, 6, 7, 8	9	11

1. Link down event on a monitored port.
2. Failure of one of the two redundant power supplies.

Note

The following devices do not have a redundant power supply:

- SCALANCE X204 IRT PRO
 - SCALANCE X202-2P IRT PRO
 - SCALANCE X201-3P IRT PRO
-

3. C-PLUG
4. Device startup, the LED is lit for approx. 20 seconds.
5. Device is in PROFINET mode:
 - a) There is no connection to the controller
 - b) There is a connection to the controller, there is also a configured diagnostic interrupt, for example power fail interrupt, C-PLUG interrupt etc.
6. Redundancy manager connected through.
7. Switchover of standby connection.
8. Maintenance request or maintenance requirement.
9. An internal fault was detected. Inform the maintenance personnel and, if necessary, send the device in for repair.
10. A loop was detected by the loop detection.
11. No fault detected by the IE Switch X-200.

3.28.2 Power display

Power display

The LEDs signal that the IE Switch X-200 can adopt the following statuses:

The status of the power supply is indicated by a green/yellow LED:

Device type SCALANCE	Yellow-green LED		LED not lit
	LED lit green	LED lit yellow	
XF204	1	2	3
X208	1	2	3
XF208	1	2	3
X216	1	2	3
X224	1	2	3
X204-2	1	2	3
X204-2TS	1	2	4
XF204-2	1	2	3
X206-1	1	2	3
XF206-1	1	2	3
X212-2	1	2	3
X204-2LD	1	2	3
X206-1LD	1	2	3
X212-2LD	1	2	3
X202-2IRT	1	2	3
X204IRT	1	2	3
XF204IRT	1	2	3
X204 IRT PRO	1	2	3
X202-2P IRT PRO	1	2	3
X201-3P IRT PRO	1	2	3
X202-2P IRT	1	2	3
X201-3P IRT	1	2	3
X200-4P IRT	1	2	3

1. Both L power supplies are connected (redundant supply).
2. One L power supply is connected (non-redundant supply).
3. Power supply L1 and L2 not connected or <14 V.
4. Power supplies L1 and L2 are not connected.

Note

SCALANCE X204 IRT PRO and SCALANCE X202-2P IRT PRO have no redundant power supply.

3.28.3 Port status indicator (green/yellow LEDs)

Port status indicator (green/yellow LEDs)

The LEDs signal that the IE Switch X-200 can adopt the following statuses.
The status of the interfaces is indicated by two-color LEDs:

Device type SCALANCE		LED lit green	LED lit yellow	LED flashes yellow	LED flashes green
	Number of port LEDs				
XF204	4 port LEDs	1	2, 3	4	5, 6
X208	8 port LEDs	1	2, 3	4	5, 6
XF208	8 port LEDs	1	2, 3	4	5, 6
X204-2	6 port LEDs	1	2, 3	4	5, 6
X204-2TS	6 port LEDs	1	2, 3	4	5, 6
XF204-2	6 port LEDs	1	2, 3	4	5, 6
X206-1	7 port LEDs	1	2, 3	4	5, 6
XF206-1	7 port LEDs	1	2, 3	4	5, 6
X204-2LD	6 port LEDs	1	2, 3	4	5, 6
X206-1LD	7 port LEDs	1	2, 3	4	5, 6
X202-2IRT	4 port LEDs	1	2, 3	4	5, 6
X204IRT	4 port LEDs	1	2, 3	4	5, 6
XF204IRT	4 port LEDs	1	2, 3	4	5, 6
X204 IRT PRO	4 port LEDs	1	2, 3	4	5, 6
X202-2P IRT PRO	4 port LEDs	1	2, 3	4	5, 6
X201-3P IRT PRO	4 port LEDs	1	2, 3	4	5, 6
X202-2P IRT	4 port LEDs	1	2, 3	4	5, 6
X201-3P IRT	4 port LEDs	1	2, 3	4	5, 6
X200-4P IRT	4 port LEDs	1	2, 3	4	5, 6
X216	16 port LEDs	1	2, 3	4	5, 6
X212-2	14 port LEDs	1	2, 3	4	5, 6
X212-2LD	14 port LEDs	1	2, 3	4	5, 6
X224	24 port LEDs	1	2, 3	4	5, 6

1. TP link exists, no data reception.
2. TP link, data received at TP port.
3. Device startup, the LED is lit for approx. 6 seconds.
4. Setting or display of the fault mask.
5. The "Show Location" function was enabled over Ethernet (for example, PST tool).
The button was pressed for longer than 15 seconds to reset the configuration.
6. PROFINET IO operation was started with the PN IO controller, the attempt to change the fault mask with the button was rejected by all the port LEDs flashing once.

3.28.4 Redundancy manager indicator (green LED)

Redundancy manager indicator (green LED)

The LED signals that the IE Switch X-200 can adopt the following statuses:

Device type SCALANCE	LED lit green	LED flashes green	LED not lit
XF204	1	2	3
X208	1	2	3
XF208	1	2	3
X216	1	2	3
X224	1	2	3
X204-2	1	2	3
X204-2TS	1	2	3
XF204-2	1	2	3
X206-1	1	2	3
XF206-1	1	2	3
X212-2	1	2	3
X204-2LD	1	2	3
X206-1LD	1	2	3
X212-2LD	1	2	3
X202-2IRT	1	2	3
X204IRT	1	2	3
XF204IRT	1	2	3
X204 IRT PRO	1	2	3
X202-2P IRT PRO	1	2	3
X201-3P IRT PRO	1	2	3
X202-2P IRT	1	2	3
X201-3P IRT	1	2	3
X200-4P IRT	1	2	3

1. The device is redundancy manager. The ring is closed.
2. The redundancy manager has switched over. The ring is interrupted.
3. The redundancy manager is disabled.

Note

The status of the redundancy manager and standby are displayed as a double function by a single multicolor LED. This is identified on the device by RM.

It changes its color depending on the function (redundancy function -> green, standby function -> yellow).

In Web Based Management, the LED is labeled differently depending on the function (redundancy function, basic status -> label RM, standby function -> label SB).

3.28.5 Standby functions (yellow LED)

Standby functions (yellow LED)

The LED signals that the IE Switch X-200IRT can adopt the following statuses:

Device type SCALANCE	LED lit yellow	LED flashes yellow (slowly)	LED flashes yellow (fast)	LED not lit
XF204	-	-	-	-
X208	-	-	-	-
XF208	-	-	-	-
X216	-	-	-	-
X224	-	-	-	-
X204-2	-	-	-	-
X204-2TS	-	-	-	-
XF204-2	-	-	-	-
X206-1	-	-	-	-
XF206-1	-	-	-	-
X212-2	-	-	-	-
X204-2LD	-	-	-	-
X206-1LD	-	-	-	-
X212-2LD	-	-	-	-
X202-2IRT	1	2	3	4
X204IRT	1	2	3	4
XF204IRT	1	2	3	4
X204 IRT PRO	1	2	3	4
X202-2P IRT PRO	1	2	3	4
X201-3P IRT PRO	1	2	3	4
X202-2P IRT	1	2	3	4
X201-3P IRT	1	2	3	4
X200-4P IRT	1	2	3	4

1. Standby function is enabled (IE Switch X-200 is in standby active mode).
2. Standby function is enabled (IE Switch X-200 is in standby passive mode).

3. Standby partner lost.
4. Standby function is disabled.

Note

When the device switches from active to passive mode because of a fault, the red fault LED is also activated. This is possible only when standby monitoring is enabled in the fault mask.

Note

The status of the redundancy manager and standby are displayed as a double function by a single multicolor LED. This is identified on the device by RM.

It changes its color depending on the function (redundancy function -> green, standby function -> yellow).

In Web-based Management, the LED is labeled differently depending on the function (redundancy function, basic status -> label RM, standby function -> label SB).

3.28.6 FOC diagnostic display (yellow LED)

Note

Only the following devices have a fiber-optic diagnostics display

- X202-2P IRT PRO
 - X201-3P IRT PRO
 - X202-2P IRT
 - X201-3P IRT
 - X200-4P IRT
-

FOC diagnostic display (yellow LED)

The diagnostic status of the SC RJ interfaces is signaled by an additional LED per port. The LED signals that the device can adopt the following statuses:

Device type SCALANCE	LED lit yellow	LED not lit
X202-2P IRT PRO	1	2
X201-3P IRT PRO	1	2
X202-2P IRT	1	2
X201-3P IRT	1	2
X200-4P IRT	1	2

1. Signaling maintenance is necessary. Maintenance should be performed to ensure problem-free operation.
2. Relevant only when the link exists:
The available link power margin is adequate for problem-free operation.

3.28.7 LED display during startup

LED display during startup

When a device starts up, the following displays light up in the order shown:

1. Power LEDs (green) light up immediately after turning on the power.
2. Port LEDs (yellow) light up for approx. 6 seconds, the red LED is off.
3. Port LEDs go off, the red error LED is lit for approx. 20 seconds.
4. After the port LEDs go off, the correct link status is displayed after approx. 2 seconds.
5. The IE Switch X-200 is now ready for operation.

Installation

4.1 Installation

Types of installation

IE Switches X-200 can be installed in various ways:

- Installation on a 35 mm DIN rail
- Installation on a SIMATIC S7-300 standard rail (not possible with XF-200 IE switches)
- Wall mounting (not possible with the XF-200 IE switches)

 WARNING
--

When used in shipbuilding, installation of SCALANCE X224, X216, X212-2, X212-2LD, X204IRT PRO, X202-2P IRT PRO and X201-3P IRT PRO on a 35 mm DIN rail is not permitted.
--

In ships, the 35 mm DIN rail does not provide adequate support.

Note

When installing and operating the device, keep to the installation instructions and safety-related notices as described here and in the manual SIMATIC NET Industrial Ethernet Twisted Pair and Fiber Optic Networks /1/.

Unless stated otherwise, the mounting options listed below apply to all X-200 IE switches.

Note

Provide suitable shade to protect the IE Switch X-200 against direct sunlight. This avoids unwanted warming of the IE Switch X-200 and prevents premature aging of the device and cabling.

 **WARNING**

If a

- SCALANCE X204 IRT PRO
- SCALANCE X204-2TS
- SCALANCE X204IRT

is operated at ambient temperatures between 60°C and 70°C, the housing temperature may exceed 70°C.

When installing the IE switch, select a location where only qualified service personnel or trained users have access to it.

Operation of the SCALANCE X-200 at ambient temperatures of 60 °C - 70°C is only permitted under these conditions.

 **WARNING**

If temperatures in excess of 70 °C occur on cables or at cable feed-in points, or the temperature at the branching point of the cables exceeds 80 °C, special measures need to be taken. If the equipment is operated at an ambient temperature of 50 °C - 60 °C, use cables with a permitted ambient temperature of at least 80 °C.

4.2 Installation on a DIN rail

Installation

Install the IE Switch X-200 on a 35 mm DIN rail complying with DIN EN 60715.

1. Place the upper catch of the device over the top of the DIN rail and then push in the lower part of the device against the rail until it clips into place.
2. Fit the connectors for the power supply.
3. Fit the connectors for the signaling contact.
4. Insert the terminal blocks or M12 cable connectors into the sockets on the device.



Figure 4-1 IE Switch X-200 removing from a DIN rail (35 mm)

Uninstalling

Removing an IE Switch X-200 from a DIN rail:

1. First disconnect all connected cables.
2. Use a screwdriver to release the lower DIN rail catch of the device and pull the lower part of the device away from the rail.

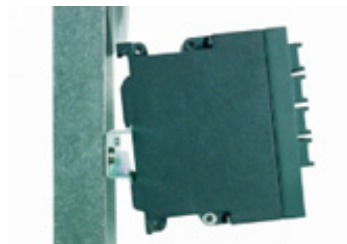

Figure 4-2 IE Switch X-200 removing from a DIN rail (35 mm)

4.3 Installation on a standard rail

Installing an IE Switch X-200 on a SIMATIC S7-300 standard rail

1. Place the upper guide at the top of the IE Switch X-200 housing in the S7 standard rail.
2. Screw the IE Switch X-200 to the underside of the standard rail.
3. Fit the connectors for the power supply.
4. Fit the connectors for the signaling contact.
5. Insert the terminal blocks or M12 cable connectors into the sockets on the IE Switch X-200.



Figure 4-3 IE Switch X-200 installation on a SIMATIC S7-300 standard rail

Uninstalling

Removing an IE Switch X-200 from a SIMATIC S7-300 standard rail

1. First disconnect all connected cables.
2. Loosen the screws on the underside of the S7 standard rail and lift the IE Switch X-200 away from the rail.

4.4 Wall mounting

Wall mounting

1. For wall mounting, use suitable mounting fittings for the wall (for example, for a concrete wall, four plugs 6 mm diameter and 30 mm long, 4 screws 3.5 mm diameter and 40 mm long).
2. Connect the electrical cable connecting cables.
3. Fit the connectors for the signaling contact.
4. Insert the terminal blocks or M12 cable connectors into the sockets on the IE Switch X-200.

For more exact dimensions, please refer to the section "Dimension drawings".

Note

The wall mounting must be capable of supporting at least four times the weight of the IE Switch X-200 (see "Technical specifications").

Connection

5.1 Power supply

Power supply

The power supply is connected using a 4-pin plug-in terminal block.

The power supply is connected over a high resistance with the enclosure to allow an ungrounded set up. The power supply is non-floating. The signal cables of the Ethernet TP ports are floating.

SCALANCE X204 IRT PRO, X202-2P IRT PRO and X201-3P IRT PRO

The power supply connector of the SCALANCE X204 IRT PRO, SCALANCE X202-2P IRT PRO and SCALANCE X201-3P IRT PRO is connected using a Power Plug PRO (PROFINET-compliant connector technology)

These two devices also have two 24 V power connectors, one for the switched mode and one for the unswitched 24 V power supply (two plug-in power connectors). Using these power interfaces (L1+, N1 and L2+, N2), it is possible to loop through the power for ET200 PRO with PROFINET-compliant connector technology. It is also possible to supply power to the module via an external T-piece (device supply over only one power interface).

SCALANCE X204 IRT PRO, X202-2P IRT PRO and X201-3P IRT PRO

Metal or plastic connectors (6GK1907-0AB10-6AA0) can be used for the power supply of the devices.

Note

If the devices are used in an ambient temperature in excess of 40 °C, or if currents higher than 6 A are conducted via the connector, metal connectors must be used.

Note

In areas subject to the National Electric Code (NEC), the Canadian Electric Code (CEC) and the EU directive 94/9 (ATEX), metal connectors must be used.

Note

The current through the power push-pull connector must not exceed a maximum of 16 A. You should therefore include a fuse that trips at a current higher than 16 A.

The fuse must meet the following requirements:

In areas subject to the NEC or CEC:

- Suitable for DC (min 60 V / max 16 A)
- Breaking current at least 10kA
- UL / CSA listed (UL 248-1 / CSA 22.2 No. 248.1)
- Classes R, J, L, T or CC.

Otherwise:

- Suitable for DC (min 60 V / max 16 A)
 - Breaking current at least 10 kA
 - Approved in compliance with IEC 60127-1 / EN 60127-1
 - Breaking characteristics: B or C for circuit breakers or slow-blow fuses.
-

Note

Removing or inserting the push pull power connector with power on is not permitted.

Note

Notes on operating under marginal conditions

If the power supply is looped through, the limit values must be taken into account. The maximum permitted current depending on the ambient temperature:

If the power is looped through by the push-pull power connectors under the marginal conditions described (see the table "Operation under marginal conditions"), the device may only be used when installed as shown in the following figure: "Mounting position for operation under marginal conditions".

If no power is looped through, any installation position is permitted.

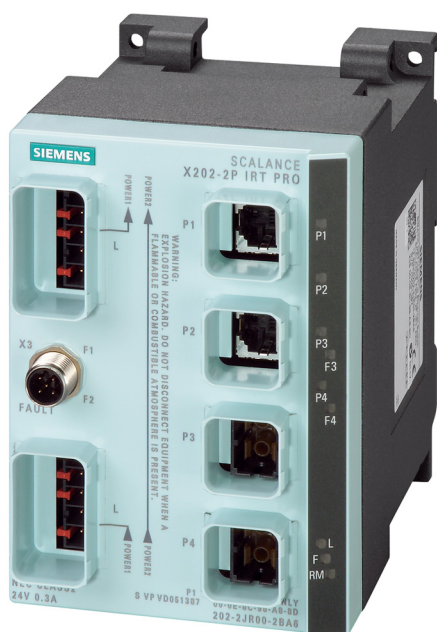

Figure 5-1 Mounting position for operation under marginal conditions

Table 5- 1 Operation under marginal conditions

Environment	Max Power 1 (L1+, N1)	Max Power 2 (L2+, N2)
+40°C	16 A	16 A
+50°C	12 A	12 A
+60°C	8 A	8 A
SCALANCE X204 IRT PRO only		
+70°C	6 A	6 A

5.1 Power supply

Table 5-2 Pin assignment

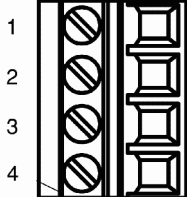
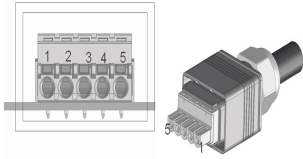
Pin number	Assignment (exceptions: SCALANCE X204 IRT PRO, X202-2P IRT PRO, X201-3P IRT PRO)	X204 IRT PRO X202-2P IRT PRO X201-3P IRT PRO
		
Pin 1	L1 +24 VDC X204-2TS: L1 +12 V ... +24 VDC	L1 +24 VDC
Pin 2	M1	N1
Pin 3	M2	L2 +24 VDC
Pin 4	L2 +24 VDC X204-2TS: L2 +12 V ... +24 VDC	N2
Pin 5	-	FE (Functional Earth)

Note

Because the SCALANCE X204 IRT PRO, the SCALANCE X202-2P IRT PRO and the SCALANCE X201-3P IRT PRO do not have a redundant power supply, the power supply must be connected to L1 and N1.

⚠ WARNING

IE Switches X-200 are designed for operation with SELV (Safety Extra Low Voltage). This means that only safety extra-low voltages (SELV) complying with IEC950/EN60950/VDE0805 can be connected to the power supply terminals.

Measures must be taken to prevent transient overvoltages of more than 40% of the rated voltage. This is the case if the devices are operated exclusively with SELV (Safety Extra Low Voltage).

Exception:

SCALANCE X204 IRT PRO, X202-2P IRT PRO and X201-3P IRT PRO:

When fused as described above

The power supply unit for the IE Switch X-200 power supply must meet NEC Class 2, as described by the National Electrical Code(r) (ANSI/NFPA 70).

The power of all connected power supply units must total the equivalent of a power source with limited power (LPS limited power source).

If the device is connected to a redundant power supply (two separate power supplies), both must meet these requirements.

The signaling contact can be subjected to a maximum load of 100 mA (safety extra-low voltage (SELV), 24 V DC). Note the exception: The signaling contact can be used for X204-2TS with a maximum load of 50 mA.

Never operate an IE Switch X-200 with AC voltage or DC voltage higher than 32 V DC.

CAUTION

If IE Switches X-200 are supplied over long 24 V power supply lines or networks, measures are necessary to prevent interference by strong electromagnetic pulses on the supply lines. These can result, for example, due to lightning or switching of large inductive loads.

One of the tests used to attest the immunity of devices of the IE Switches X-200 to electromagnetic interference was the "surge immunity test" according to EN61000-4-5. This test requires overvoltage protection for the power supply lines. A suitable device is, for example, the Dehn Blitzductor VT AD 24 V type no. 918 402 or comparable protective element.

Manufacturer: DEHN+SÖHNE GmbH+Co.KG, Hans-Dehn-Str.1, Postfach 1640, D-92306 Neumarkt, Germany.

5.2 Signaling contact



Signaling contact

The signaling contact (relay contact) is a floating switch with which error/fault states can be signaled by breaking the contact.

The signaling contact is connected to a 2-pin plug-in terminal block.

Exception:

The signaling contact on the SCALANCE X204 IRT PRO and SCALANCE X202-2P IRT PRO is connected using a 5-pin b-coded M12 socket.

IE Switches X-200		SCALANCE X204 IRT PRO, SCALANCE X202-2P IRT PRO, SCALANCE X201-3P IRT PRO	
Pin number	Assignment	Pin number	Assignment
1  2			
Pin 1	F1	Pin 1	F1
Pin 2	F2	Pin 2	n. c.
-	-	Pin 3	n. c.
-	-	Pin 4	F2
-	-	Pin 5	n. c.

The following errors/faults can be signaled by the signaling contact:

- The loss and the establishment of a link on a monitored port.
- The failure of one of the two redundant power supplies.
- The loss of the connection to the controller in PROFINET IO mode.
- The redundancy manager signals an error

Note

SCALANCE X204 IRT PRO, SCALANCE X202-2P IRT PRO and SCALANCE X201-3P IRT PRO have no redundant power supply

- Incompatible C-PLUG was inserted.

The connection or disconnection of a communication node on an unmonitored port does not lead to an error message.

The signaling contact remains activated until the error/fault is eliminated or until the current status is applied as the new desired status using the button.

When the IE Switch X-200 is turned off, the signaling contact is always activated (open).

5.3 Grounding

Installation on a DIN rail

The device is grounded over the DIN rail.

S7 standard rail

The device is grounded over its rear panel and the neck of the screw.

Wall mounting

The device is grounded by the securing screw in the unpainted hole.

Please note that X-200 IE switches must be grounded over one securing screw with minimum resistance.

If an IE Switch X-200 is mounted on a non-conducting base, a grounding cable must be installed. The grounding cable is not supplied with the device. Connect the paint-free surface of the device to the nearest grounding point using the grounding cable.

5.4 Fitting the IE FC RJ-45 Plug 180

Assembly of the IE FC RJ-45 Plug 180 on an IE FC Standard Cable

For information on assembling an IE FC RJ-45 Plug 180 on a SIMATIC NET Industrial Ethernet FastConnect cable, please refer to the instructions supplied with the IE FC RJ-45 Plug.



Figure 5-2 IE FC RJ-45 Plug 180

Inserting the IE FC RJ-45 Plug 180

1. Insert the IE FC RJ-45 Plug 180 into the twisted pair port of the IE Switch X-200 until it locks in place.



Figure 5-3 Inserting the IE FC RJ-45 Plug 180

The flush fit and locking mechanism of the PROFINET-compliant IE FC RJ-45 Plug 180 along with the securing collar on the TP port of the IE Switch X-200 guarantee a robust node connection suitable for industrial conditions providing tensile and bending strain relief for the twisted pair socket.

Removing the IE FC RJ-45 Plug 180

1. Press on the locking mechanism of the IE FC RJ-45 Plug 180 gently to remove the plug.



Figure 5-4 Releasing the RJ-45 Plug

If there is not enough space to release the lock with your hand, you can also use a 2.5 mm screwdriver. You can then remove the IE FC RJ-45 Plug 180 from the twisted pair socket.



Figure 5-5 Releasing the RJ-45 Plug with a screwdriver

5.5 Fitting the IE RJ 45 Plug Pro and IE SC RJ Plug Pro

IE RJ 45 Plug Pro and IE SC RJ Plug Pro

You will find the instructions for assembling a SIMATIC NET Industrial Ethernet cable with the industrial IE RJ-45 Plug Pro or IE SC RJ Plug Pro in the documentation supplied with the connectors.



Figure 5-6 IE RJ 45 Plug Pro or IE SC RJ Plug Pro

Inserting the IE RJ 45 Plug Pro or IE SC RJ Plug Pro

1. Insert the IE RJ 45 Plug Pro or IE SC RJ Plug Pro until they click in place in the IE Switches X-200.



Figure 5-7 IE RJ 45 Plug Pro or IE SC RJ Plug Pro inserted

Removing the IE RJ 45 Plug Pro or IE SC RJ Plug Pro

1. Remove IE RJ 45 Plug Pro or IE SC RJ Plug Pro from the socket of the IE Switches X-200.



Figure 5-8 Removing IE RJ 45 Plug Pro or IE SC RJ Plug Pro

Configuration / diagnostics using remote mechanisms

6

6.1 Assignment of an IP address

6.1.1 Introduction

Initial assignment of an IP address

Note

The initial assignment of an IP address for an IE Switch X-200 is not possible with Web Based Management because this configuration tool requires that an IP address is already available.

The IP address can only be assigned when the IE switch X-200 can be reached via Ethernet.

There are three ways of assigning an IP address to an unconfigured device, using:

- DHCP
- STEP 7 V 5.3 plus SP 1 or higher
If you want to assign an IP address using STEP 7, the forwarding of DCP frames to the relevant IE switch X-200 must not be disabled.
- Primary Setup Tool V3 or higher
If you want to assign an IP address using the PST tool, the forwarding of DCP frames to the relevant IE switch must not be disabled.

6.1.2 Configuration with the Primary Setup Tool

6.1.2.1 Configuration with the Primary Setup Tool

Primary Setup Tool (PST)

The Primary Setup Tool is on the CD supplied with the device.

6.1 Assignment of an IP address

Downloading the Primary Setup Tool

The Primary Setup Tool is available on the Internet at:

SIEMENS Automation and Drives Service & Support

Entry ID 19440762

<http://support.automation.siemens.com/WW/llisapi.dll?func=cslib.csinfo&lang=xx&objid=19440762&caller=view> (xx = German de, English en, French fr, Italian it, Spanish es)

Supported operating systems

The Primary Setup Tool can be installed and run under the following operating systems:

Windows XP Professional

Windows 2000 Professional SP2

6.1.2.2 Installing the Primary Setup Tool

Procedure

Follow the steps outlined below to install the Primary Setup Tool on your computer:

1. Double-click on the setup.exe file name in the Windows Explorer or start the program with the Windows menu Start > Run.
2. In the Choose Setup Language dialog box, select the language in which you want to make the installation.
3. The first dialog box of the Installation Wizard appears. Click on the Next button.
4. The dialog box for selecting the installation folder appears. Click on the Next button if you want to accept the default C:\Program Files\Siemens\Primary Setup Tool\ . If you want to specify a different folder, you can open a dialog box for selecting a folder by clicking the Browse button.

Start installation by clicking the Next button.

5. A final dialog box confirms successful installation. Click the Finish button to close this dialog box.
6. The Primary Setup Tool is now available in the installation folder under the name s7wnpstx.exe. Before you can use this program, the DLC protocol must be installed on the computer.

6.1.2.3 The DLC protocol

Checking

The Primary Setup Tool uses the DLC protocol for communication with the modules. This protocol is not supplied with Windows XP and is not installed automatically by the installation program of the Primary Setup Tool. This means that it must be installed separately with this operating system.

Procedure

Follow the steps below to check whether or not the DLC protocol is installed on a computer:

1. Select the menu Start > Settings > Control Panel > Network and Dial-up Connections.
2. Select the connection to your Ethernet communications module.
3. Open the Properties dialog using the context-sensitive menu (right mouse button). The General tab lists all the protocols and services. The DLC protocol should be listed and selected:

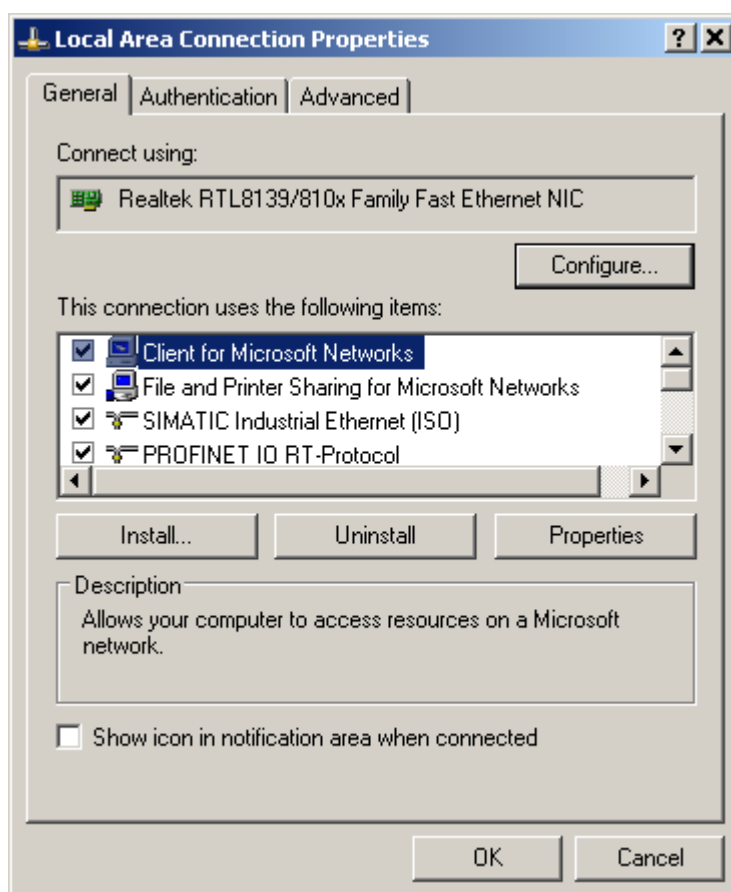

Figure 6-1 Properties of local area connection

6.1 Assignment of an IP address

6.1.2.4 Installing the DLC protocol

Procedure

Follow the steps below to install the DLC protocol on a computer:

1. Select the menu Start > Settings > Control Panel > Network and Dial-up Connections.
2. Select the connection to your Ethernet communications module.
3. Open the Properties dialog using the context-sensitive menu (right mouse button).
4. Click the Install... button in the General tab
5. In the Network Component Type dialog, select Protocol and click the Add... button.
6. In the Network Protocol dialog box, select the vendor Microsoft.
7. In the Network Protocol dialog box, select the DLC protocol.
8. Close the Properties dialog box by clicking the OK button.

6.1.2.5 Working with the Primary Setup Tool

Language selection

After starting the Primary Setup Tool for the first time, a dialog box opens in which you set the language for the program. You can also set the language separately in the Settings > Language menu.

Selecting the network adapter

If there is more than one network adapter in your computer, you can open the Settings > Network Adapter menu and specify which adapter is used by the Primary Setup Tool for network access. This menu displays a maximum of four network adapters, however only those for which the DLC protocol is activated are shown.

Browsing the Network

Before you assign IP addresses with the PST, you must first locate the configurable devices in the network. It is only possible to search for devices if the forwarding of DCP frames is not disabled.

Start this search with the steps outlined below:

- Select the Network > Browse menu command.
- Press the F5 function key.
- Click on the magnifier icon in the toolbar below the menu bar.

While the Primary Setup Tool browses the network, the Browse Network dialog is displayed with a progress bar. On completion of the search, the Primary Setup Tool displays a list with all the devices it has found in the left-hand pane.

6.1.2.6 Configuring a module

If you click an entry in the list, the Primary Setup Tool displays information on the selected device in the right-hand pane.

Procedure

Follow the steps below to configure a device:

1. Click on the plus symbol in front of the device symbol or double-click on the device symbol to display all interfaces of the device.
2. Click on the interface you want to configure. The Primary Setup Tool displays the input dialog for the configuration data in the right-hand pane of the program window. Depending on the selected settings, some text boxes or check boxes may be disabled. The MAC address box is always disabled because this address is a property of the device that cannot be modified. The Client ID parameter and DNS is also not supported by the IE Switch X-200.
3. Decide how the device will obtain its IP address:
 - Dynamically from a DHCP server:
Select the Obtain IP address from DHCP server option button.
 - Manual assignment by the user:
Select the Assign IP parameters option button.
4. Make the following entries if you have decided to assign the IP address manually:
 - Enter the IP address for the device in the IP Address box. In each subarea separated by periods, you can enter a number between 0 and 255, other entries are rejected by the program.
 - Enter the subnet mask in the subnet mask box.
 - When necessary, select the Router check box and enter the IP address of the router in the relevant text box. The information on the router is necessary if the computer with which you are creating the configuration is not in the same subnet as the device you are configuring.

6.1 Assignment of an IP address

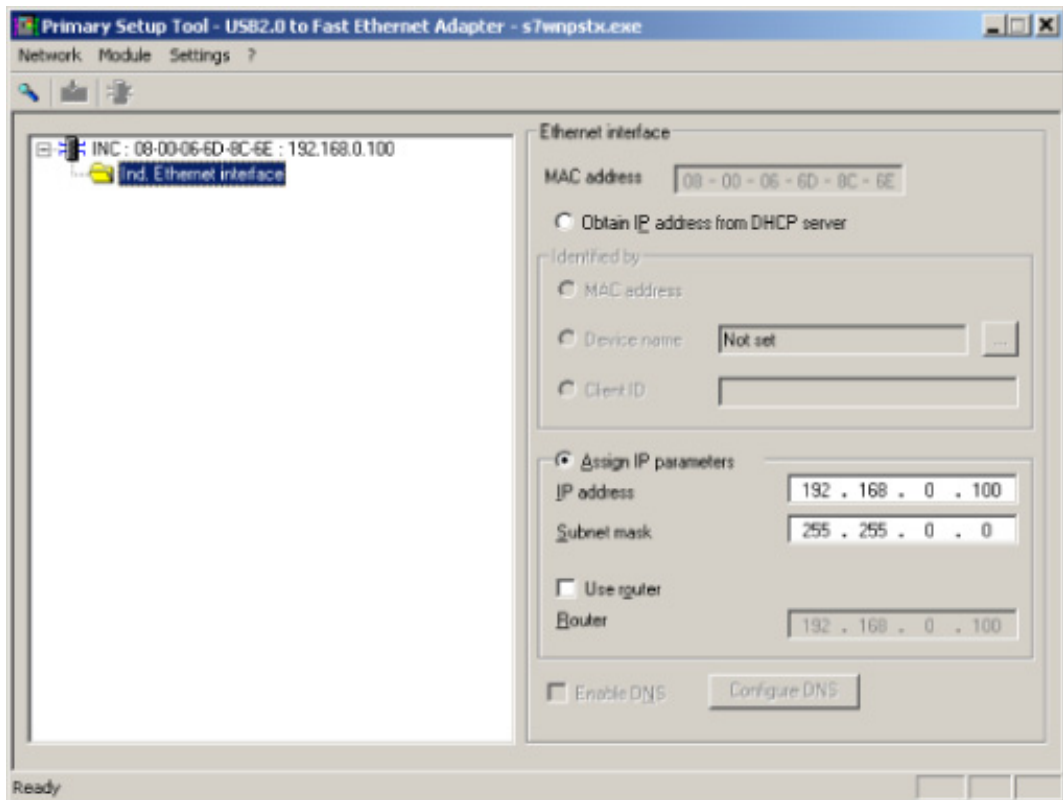

Figure 6-2 Dialog for configuring a module

Downloading configuration data to the module

Transfer the configuration data to the device by following the steps outlined below:

1. Select the module you want to configure in the left half of the program window. If an interface is selected and the input screen for the configuration data is displayed, it is not possible to download the configuration data.
2. Start the download with one of the steps outlined below:
 - Select the Module > Download menu command.
 - Click on the second button from the left in the toolbar (S7 modules with yellow arrow).

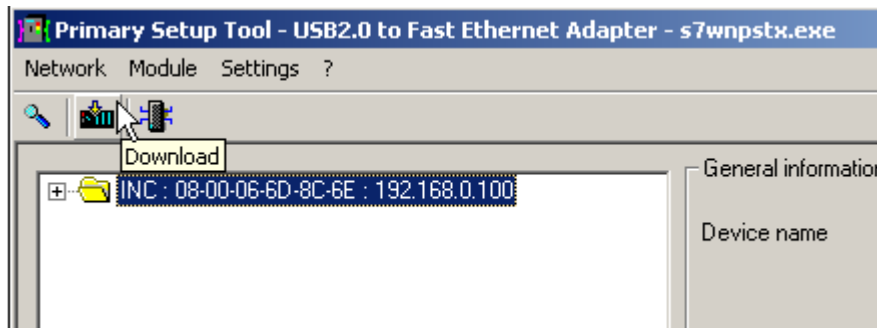

Figure 6-3 Dialog for downloading a module

Starting Web Based Management

INC devices (Industrial Network Component) such as the X-200 IE switches have a Web Based Management. Select the device you want to configure with Web Based Management and perform one of the following steps to start Web Based Management:

- Select the Module > INC Browser menu command.
- Click on the third button from the left in the toolbar (module with four blue cords).

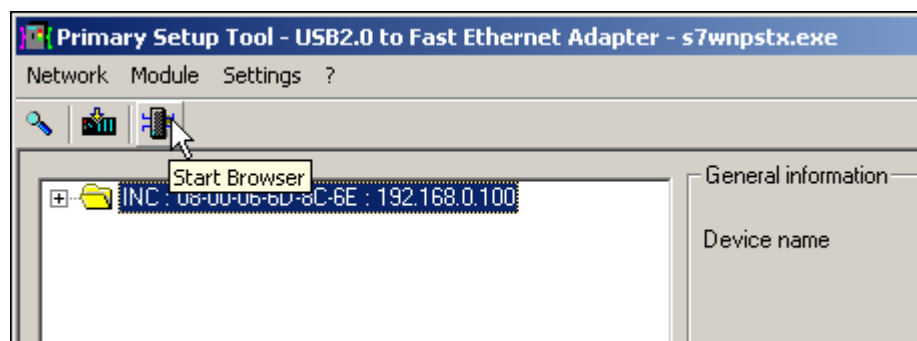

Figure 6-4 Dialog for starting Web Based Management

If the Module > Start INC Browser and the module icon are deactivated, there is no Web Based Management for the selected module.

Removing a module

You can remove a module from the list in the left part of the program window by selecting the Module > Remove Module menu command. Using this menu has no effect on the existence of a module in the network, after browsing the network again, all modules would be displayed again.

Assigning a PN IO device name

You can assign a PN IO device name to PROFINET IO-compliant devices. After selecting the Module > Assign Name menu, a dialog box opens in which you can enter the required name. The name can be a maximum of 255 characters long and over and above letters and numbers can contain only the special characters slash, hyphen, and underscore. The first character must be a letter.

Finding the location of a device

With the Module "Flash" command, you can make the LEDs of the relevant device flash. After selecting this menu, a dialog appears with which you can start and finish signaling.

The activity of the LEDs indicates which device is assigned to a particular list entry in the program window.

6.1.3 Configuration with DHCP

The Dynamic Host Configuration Protocol (DHCP) is a protocol that allows the dynamic configuration of IP addresses and provides additional information.

During initial startup, the network node registers with a server that provides the DHCP service. The server assigns a free IP address so that at the next startup, a connection is not absolutely necessary.

Properties of DHCP

- The use of DHCP is not restricted to the startup phase. DHCP can also be used during operation.
- The IP address remains valid for a period set by the DHCP server known as the "lease time". When this expires, the DHCP server must be requested to assign an IP address again.
- Generally, there is no fixed address assignment; in other words, when a client requests an IP address again, it is normally assigned a different address. It is, however, possible to configure the DHCP server so that it makes a fixed address assignment.

RFC - Request for Comments

The following RFC can be downloaded from the Internet:

RFC 2131 - Dynamic Host Configuration Protocol

6.2 Updating the firmware with the boot loader

If an error occurs when updating the firmware or if an IE Switch X-200 was updated with incompatible firmware, it is possible that the firmware of the device will not start correctly.

In this case, the boot loader is active after the device has started up. This status is signaled by a flashing fault LED.

The boot loader can also be activated by turning on the device and holding down the button until the fault LED starts to flash.

Note

The product must be connected with the FTP client at port 1.

With the boot loader activated, follow the steps below to load new firmware on the IE Switch X-200:

- Assign an IP address to the device. You can do this with the PST tool.
- Once you have assigned the IP address, you can communicate with the FTP server integrated in the boot loader.
- Send a firmware file to the IE Switch X-200 using FTP. You can use any FTP client to do this.
- Use the following connection settings for FTP access:
 - User name: siemens
 - Password: siemens
 - Transmission mode: Binary
- Once it receives the file, the device updates the firmware and restarts automatically.

6.3 Configuration using Web Based Management (WBM) and Command Line Interface (CLI)

Introduction

To make the best possible use of the technical possibilities of the IE switches, you can adapt the configuration of the device to the concrete situation in which it is used. There are two ways of configuring an IE switch:

- With the Command Line Interface, you can configure IE switches via Telnet or SSH (an Ethernet connection is necessary). You can enable or disable Telnet or SSH using Web Based Management.
- Web Based Management accesses the configuration of an IE switch over a Web browser. An Ethernet connection to the IE switch is necessary.

NOTICE

Depending on the selected configuration method, the following mechanisms are integrated to prevent unauthorized access to an IE switch:

- CLI via TELNET or SSH
A CLI session is interrupted automatically if no input is made for more than five minutes. This value can be assigned using the CLI (up to 600 s). The automatic interruption of a CLI session can also be disabled with CLI.
- Web Based Management
There is an automatic logout after 5 minutes; you can, however, also log out manually using a "Logout" button on the user interface located in the header of Web Based Management. Exiting the browser does not close the session. If the browser is started again within these 5 minutes, the session continues to be used.

Note

All the configuration changes are adopted in the flash memory after approximately 1 minute or after a warm restart. You should therefore run the "Restart" command in the command line interface or in Web Based Management before turning off the device. You can then be certain that all the configuration changes have been saved.

Note

To use SNMP Management, RMON, and traps, you require a network management station. This does not ship with IE switches.

6.3.1 Principle of Web Based Management

Principle of Web Based Management

IE switches have an integrated HTTP server for Web Based Management. If an IE switch is addressed over a Web browser, it returns HTML pages to the client computer depending on the user input.

The user enters the configuration data in the HTML pages sent by the IE switch. The IE switch evaluates this information and generates reply pages dynamically. The great advantage of this method is that apart from a Web browser, no special software is required on the client.

Requirements for Web Based Management

- An IE switch must have an IP address before you can use Web Based Management.
- To use Web Based Management, there must be an Ethernet connection between the IE switch and the client computer.
- Use of a Microsoft Internet Explorer, version 5.5 or higher is recommended.
- All the pages of Web Based Management require JavaScript. You should therefore make sure that Java Script is enabled in your browser settings.

Note

The browser must not be set so that it reloads the page from the server each time the page is accessed. The updating of the dynamic content of the page is ensured by other mechanisms. In the Internet Explorer, you can make the appropriate setting in the *Options > Internet Options > General* menu in the section *Temporary Internet Files* with the Settings button.

Below the text *Check for newer versions of stored pages*, the *Automatically* check box must be selected.

- Web Based Management is HTTP- or HTTPS-based, so you must also enable access to port 80 or 443 if you have a firewall installed.

Starting Web Based Management and logging on

1. Enter the IP address or the URL of the IE switch in the address box of the Web browser. If there is a problem-free connection to the IE switch, the Logon dialog of Web Based Management is displayed:

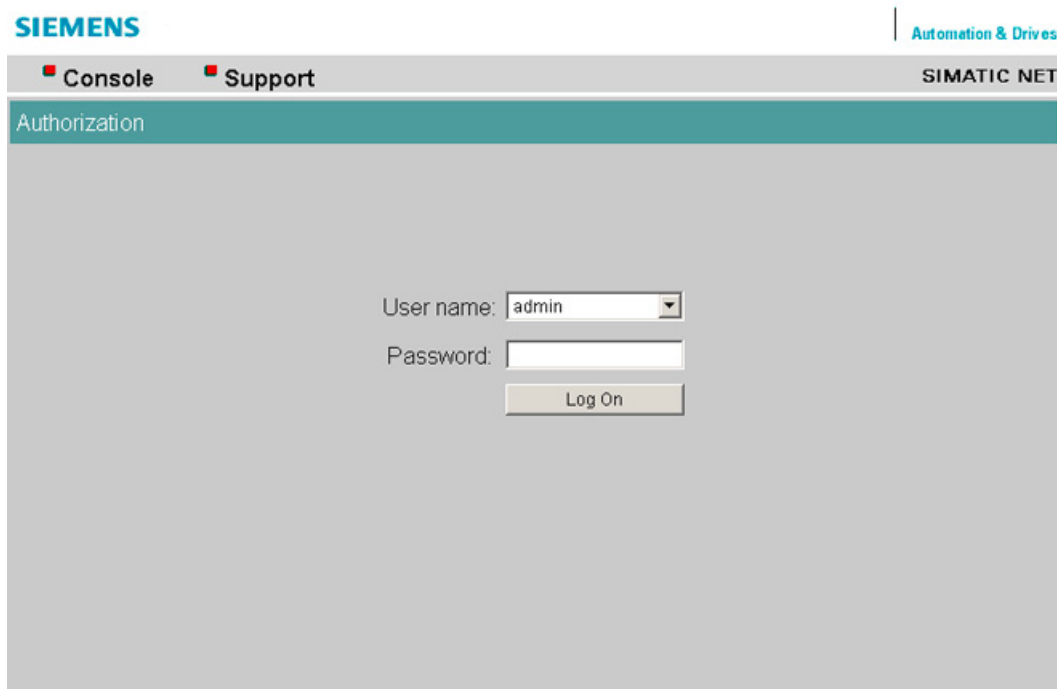

Figure 6-5 LOGON screen

2. In the "User Name" list box, select the "Admin" entry if you want to change settings of the IE switch (read and write access). If you select the "User" entry, you only have read access to the configuration data of the IE switch.
3. Enter your password. If you have not yet set a password, the default passwords as shipped apply: Enter admin if you selected "admin" as the user name or user if you selected "user".

Note

For security reasons, make sure that you change the original factory-set passwords. Resetting the device also resets the passwords to the factory settings.

4. Click the "Log On" button to start the logon.

6.3.2 LED simulation

Display of the operating state

IE Switches X-200 have several LEDs that provide information on the operating state of the devices. Depending on its location, direct access to the IE Switch X-200 is not always possible. WBM therefore provides a simulated display of the LEDs.

In the dialog (see below), you can see a schematic representation of an IE Switch X-200 with the existing modules and the corresponding LEDs. The send display is not displayed realistically; in other words, the LEDs do not flash.

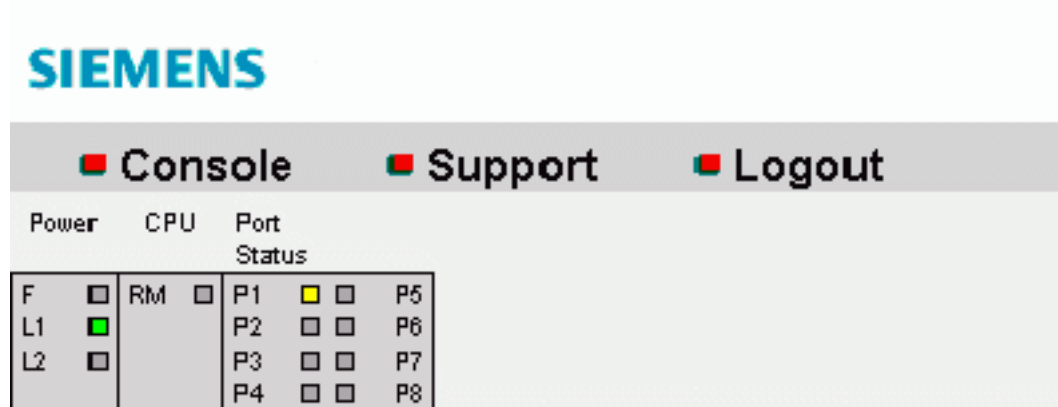

Figure 6-6 "LED Simulation" display

6.3.3 Working with WBM

Navigation bar

The upper menu bar of WBM provides 3 links:

- Console
This link opens a console window. In this window, you can enter CLI commands. You are then connected to the switch over a TELNET connection.
- Support
This link initiates an Internet connection that takes you directly to the support pages of SIEMENS AG. This is only possible when the PC supports an Internet connection.
- Log out
Closes the browser window.

Buttons

- Refresh
If you click on this button, current data of the switch is requested and displayed.
- Set Values
If you click on this button, configuration data you have set is stored on the device.

NOTICE
It is only possible to change the configuration if you log on as "admin".

Note

A blue text is a link that can be clicked.

6.3.4 Command Line Interface (CLI)

Starting the CLI in a Windows console

Follow the steps outlined below to start the Command Line Interface in a Windows console:

1. Open a Windows console and type in the command telnet followed by the IP address of the IE switch. `C:\>telnet <IP address>`
2. Enter your login and password.

```

Telnet 192.168.0.19
SIMATIC NET - SCALANCE X200
MAC Address       : 00-0E-8C-A2-F4-85
Device type      : SCALANCE X216
PNIO Device name : 192.168.0.19
Firmware         : V 4.0.32

Login: admin
Password: *****

/                (Go to top of menu tree)
..              (Go up in menu tree)
?              (Show menus/commands)
exit           (Exit from CLI/TELNET session)
restart        (Restart)

info           (Show identification data)
SYSTEM        (Open SYSTEM menu)
X200          (Open X200 menu)
AGENT         (Open AGENT menu)
SWITCH        (Open SWITCH menu)
STAT          (Open STAT menu)

CLI>

```

Starting the CLI in Web Based Management

Click on the "Console" entry in the upper menu bar of Web Based Management. A Telnet connection opens automatically in which you can log on with your user name and password.

Shortcuts for commands

As an alternative, instead of entering full CLI commands, you can simply enter the first letter or the first few letters and then press the Tab key. The Command Line Interface then displays a command starting with the letter or letters you typed in. If the command displayed is not the command you require, press the Tab key again to display the next command.

Directory structure

Before you can enter a command in the Command Line Interface, you must first open the required menu or submenu. This section lists the commands of each menu in a separate table. The table lists only the commands themselves.

Addressing scheme for the ports of an IE Switch X-200

The following addressing scheme applies to the port labeling of an IE Switch X-200:

- The number relates directly to the port.

The label 2 stands for the second port on the IE Switch X-200.

Symbols for representing CLI commands

CLI commands generally have one or more parameters that are represented in the syntax description as follows:

- Mandatory parameters are shown in pointed brackets.
Example: *<IP address>*

Instead of the parameter shown in italics, you enter the actual value, for the parameter shown above, for example, you would enter an actual IP address such as 141.120.246.210 .

If you omit a mandatory parameter, most commands output the current value.

- Optional parameters are shown in square brackets.
Example: devname [Device Name]
You can assign a new name with the devname command by setting the parameter [Device Name]. If the parameter [Device Name] is not set, the current name is displayed.
- Alternative input values are separated by the pipe character (|). In this case, you specify one of the listed values as the parameter.
Example: <E|D>
You enter either E or D.
- If a numeric value is required as a mandatory parameter, you can also specify a range of values:
Example: <0 ... 255>
Enter a value between 0 and 255.

Cross-menu commands

You can use the commands in the following table in any menu or submenu.

Table 6- 1 Command Line Interface - CLI\ ... >

Command	Description	Comment
/	Changes to the highest menu level.	Administrator and User
..	Moves you one menu level higher.	Administrator and User
?	Displays the commands available in the menu.	Administrator and User
exit	Closes the CLI session.	Administrator and User
restart	Restarts the IE switch	Administrator only
About	Displays information on the current menu item.	Administrator and User

6.3.5 WBM menus

6.3.5.1 Management menus - the Start menu

The Start dialog

The following start screen appears after you enter the login and password in WBM. Select the required function from the menu on the left-hand side.

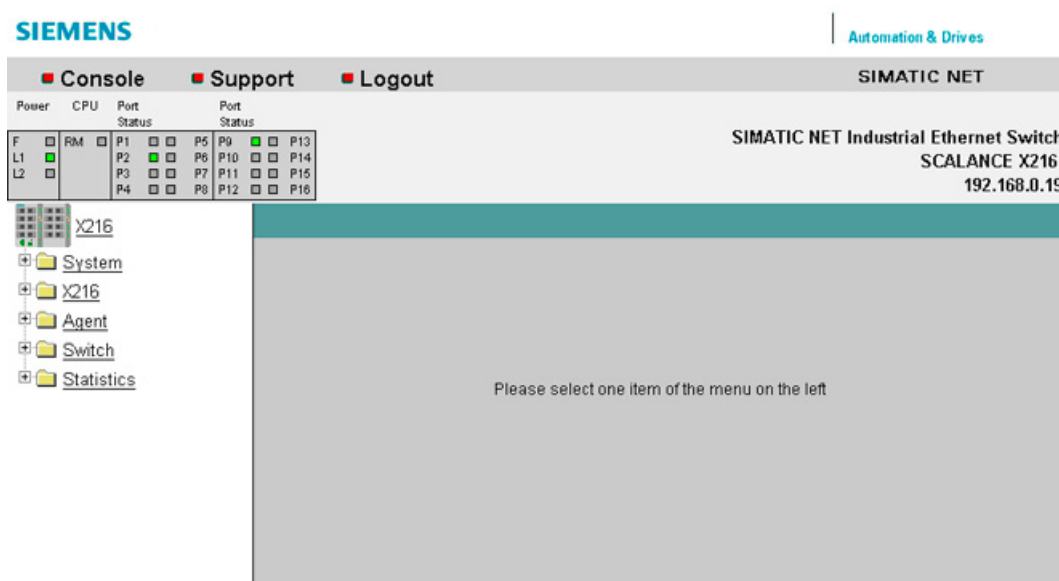

Figure 6-7 "Start Menu" dialog

6.3.5.2 The "System" WBM menu

System Configuration

The following screen appears when you click on the system folder icon:
The first three text boxes are read-only and display general information on the device. In the lower four boxes, you can specify the parameters.
You can change PNIO Device Name, System Contact, System Location and System Name.

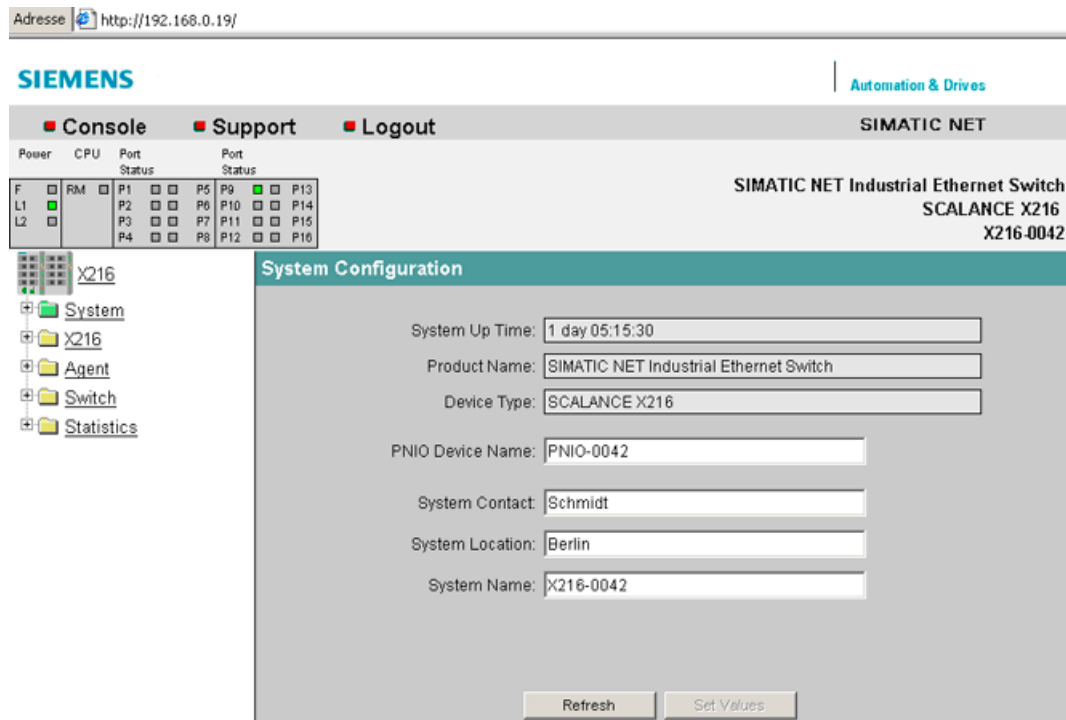

Figure 6-8 "System Configuration" dialog

System up time

The system up time displays the operating time of the device since the last restart.

Product Name

Displays the product name.

Device Type

Displays the device type.

PNIO Device Name

In this box, you enter the name under which the device will be accessible in PROFINET IO mode.

System Contact

Enter the name of a contact person responsible for managing the device in this box.

System Location

In this box, you enter a location for the device, for example a room number.

System Name

Enter a description of the device in this box.

You apply your settings with Set Values.

Syntax of the Command Line Interface

Table 6- 2 System Configuration - CLI\SYSTEM>

Command	Description	Comment
info	Shows the current system information.	
devname [Device Name]	Sets the "PNIO Device Name" variable.	Administrator only
name [sysName]	Sets the "sysName" variable.	Administrator only
contact [sysContact]	Sets the "sysContact" variable.	Administrator only
location [sysLocation]	Sets the "sysLocation" variable.	Administrator only

6.3.5.3 "System C-PLUG" WBM menu

C-PLUG Information

This dialog tells you whether a C-PLUG is inserted and whether it is valid for the IE Switch X-200.

If a C-PLUG is inserted, the dialog displays the configuration data it contains.

You cannot modify the contents of the boxes.

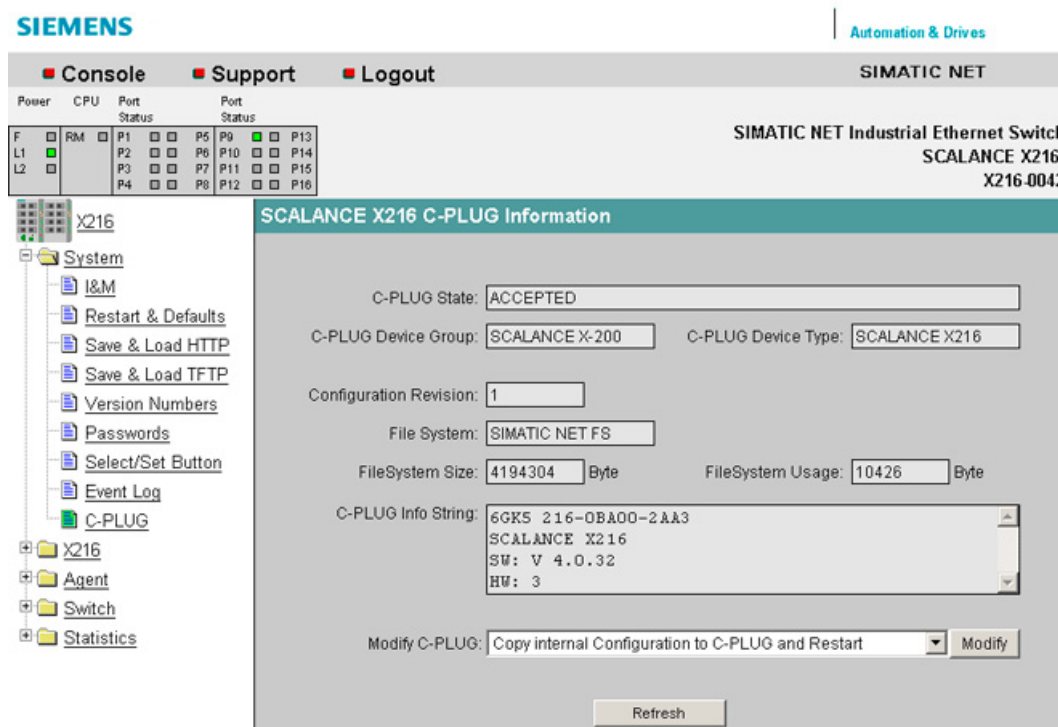

Figure 6-9 "C-PLUG Information" dialog

C-PLUG State

The status of the C-PLUG is displayed here.

- **ACCEPTED**
There is a C-PLUG with a valid and matching content inserted in the device.
- **NOT ACCEPTED**
No C-PLUG or C-PLUG inserted but invalid or incompatible content. This status is also displayed if the C-PLUG was formatted during operation.
- **NOT ACCEPTED, HEADER CRC ERROR**
A C-PLUG with bad content is inserted.

- **NOT PRESENT**
There is no C-PLUG inserted in the IE Switch X-200.
- **EMPTY**
The inserted C-PLUG is empty.

C-PLUG Device Group

Indicates the SIMATIC NET product line that previously operated with the C-PLUG.

C-PLUG Device Type

Indicates the device type within the product line that previously operated with the C-PLUG.

Configuration Revision

Indicates the version of the configuration structure. This information relates to the configuration options supported by the IE Switch X-200. This does not relate to the actual hardware configuration. This information does not change if you add or remove modules or extenders. The information can, however, change if you update the firmware.

File System

Shows the type of C-PLUG file system.

File System Size

Shows the maximum storage capacity of the C-PLUG file system.

File System Usage

Shows the storage space being utilized in the C-PLUG file system.

C-PLUG Info String

Displays information on the device that used the C-PLUG previously, for example order number, type designation, version of hardware and software.

NOTICE
<p>If an empty C-PLUG is inserted in an IE Switch X-200, the next time the device starts up, the configuration stored internally on the basic device is transferred to the C-PLUG.</p> <p>If you operated an IE Switch X-200 with a C-PLUG inserted, the configuration stored internally on the basic device is no longer modified.</p> <p>During ongoing operation, changes to the configuration data are stored only on the C-PLUG.</p> <p>If you remove the C-PLUG later, the configuration stored internally on the basic device becomes valid again. This restores the configuration status prior to inserting the C-PLUG.</p>

Modify C-PLUG, Modify button

If you are logged on as administrator, you can make settings here.

- **Copy internal Configuration to C-PLUG and Restart**
 The configuration in the internal flash memory of the switch is copied to the C-PLUG and this is followed by a restart.
 Use case:
 The IE Switch X-200 starts up with a C-PLUG inserted. This contains a configuration that differs from the IE Switch X-200 or a configuration containing errors. With this function, you can overwrite the content of the C-PLUG with the original device configuration.
- **Copy default Configuration to C-PLUG and Restart**
 This stores the configuration with all factory default values on the C-PLUG. This is followed by a restart during which the IE Switch X-200 restarts with these default values.
- **Clean C-PLUG (Low Level Format, Configuration lost)**
 Deletes all data from the C-PLUG and triggers low-level formatting. This is not followed by an automatic restart and the device displays an error. You can clear this error status by restarting or removing the C-PLUG after turning off the basic device. To retain the configuration of the basic device even after deleting the C-PLUG, the configuration data stored on the C-PLUG is transferred to the internal memory of the basic device.
- **Continue without C-PLUG**
 If the C-PLUG is removed from a device, an error message is displayed after the device restarts. In this case, you can select the "Continue without C-PLUG" option to change the device to the mode without a C-PLUG.

Your selection is then adopted when you click "Modify".

Syntax of the Command Line Interface

Table 6-3 C-PLUG Information - CLI\SYSTEM\C-PLUG>

Command	Description	Comment
info	Displays the current status (information) of the C-PLUG.	
initdef	Initializes the C-PLUG with the default parameters and restarts the device.	Administrator only.
initmem	Initializes the C-PLUG with the MEMORY parameters and restarts the device.	Administrator only.
usecplug [D]	If the C-PLUG was removed, the next time you restart the device, an error command is displayed in the Command Line Interface. By entering the usecplug D command, you can change the device to operate in the mode without C-PLUG.	Administrator only.
clear	Erases the data on the C-PLUG.	Administrator only.

6.3.5.4 The "System I&M" WBM menu

System Identification & Maintenance

The following dialog shows information on the parameters for Identification & Maintenance.

The following screen contains information on device-specific vendor and maintenance data such as the order number, serial number, version numbers etc.

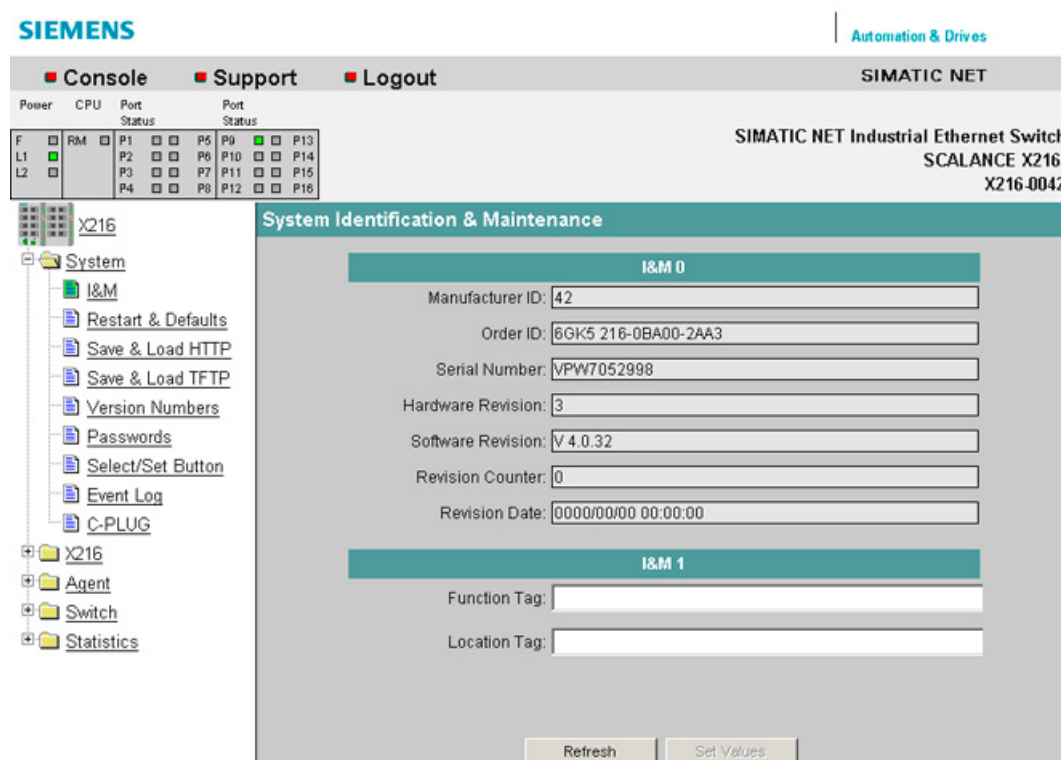

Figure 6-10 System Identification & Maintenance

I&M 0

Here, you can see the individual parameters for Identification & Maintenance.

I&M 1

Function tag

Here, you can enter the function tag (plant designation).

Location tag

Here, you can enter the location tag (location identifier).

Syntax of the Command Line Interface

Table 6-4 System Identification & Maintenance - CLI\SYSTEMMIM>

Command	Description	Comment
info	Displays information on the "Identification & Maintenance" menu item.	
function [function]	Specifies the function (max. 32 characters).	Administrator only.
location [location]	Specifies the location (max. 32 characters).	Administrator only.

6.3.5.5 The "System Restart & Defaults" WBM menu

System Restart & Defaults

In this screen, there is a button with which you can restart the device and various options for resetting to the device defaults.

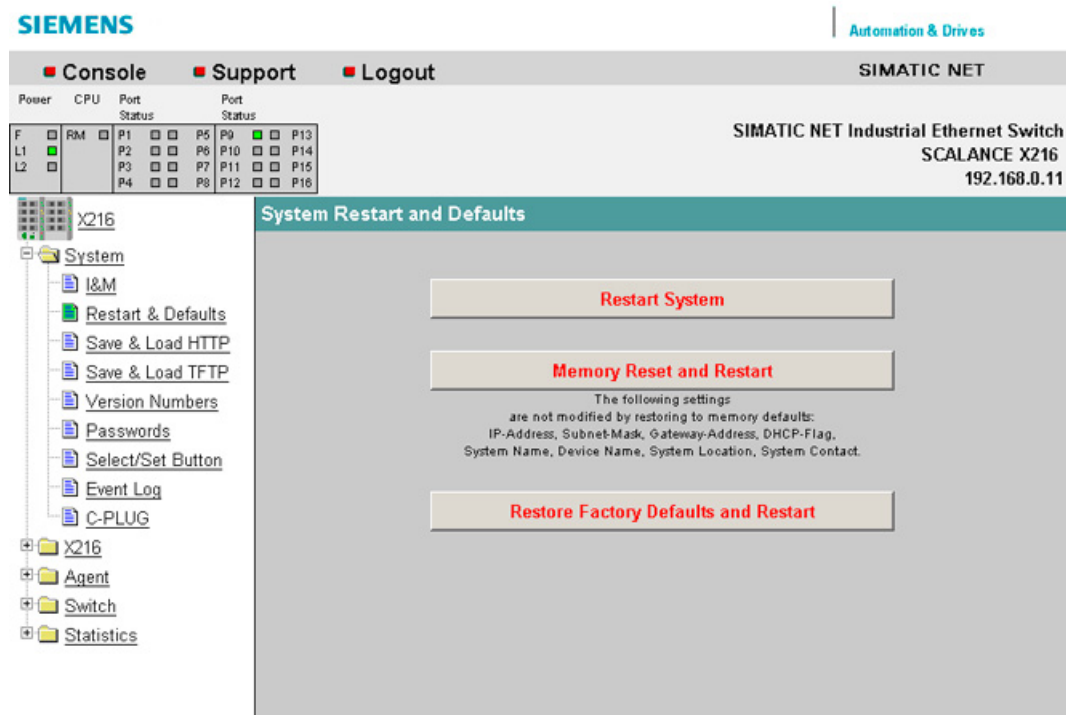

Figure 6-11 "Restart and Defaults" dialog

Restart System

Click this button to restart the IE Switch X-200. You must confirm the restart in a dialog box. During a restart, the IE Switch X-200 is reinitialized, the internal firmware is reloaded. The learned entries in the address table are deleted. You can leave the browser window open while the IE Switch X-200 restarts.

Memory Reset and Restart

Click on this button to restore the factory configuration settings with the exception of the following parameters:

- IP address
- Subnet mask
- IP address of the default router
- DHCP flag
- System name
- System location
- System contact
- PNIO Device Name
- System Event Log Table
- Settings for ring redundancy and standby

An automatic restart is triggered. In the user mode, this button is invisible.

Restore Factory Defaults and Restart

Click this button to restore the factory defaults for the configuration. The protected defaults are also reset. In the user mode, this button is invisible.

Note

The IE Switch X-200 must be given a new IP address before it can be accessed again.

Syntax of the Command Line Interface

Table 6- 5 System Restart & Defaults - CLI\SYSTEM\RESTARTS>

Command	Description	Comment
memreset	Restores the factory defaults. The protected settings are retained.	Administrator only.
defaults	Restores the factory defaults. The protected settings are also reset.	Administrator only.

6.3.5.6 The "System Save & Load HTTP" WBM menu

System Save & Load HTTP

The WBM allows you to store configuration information in an external file on your client PC or to load such data from an external file from the PC to the IE Switch X-200.

You can also load new firmware from a file located on your client PC. You can make the entries required for this on the page of the System Save & Load HTTP menu.

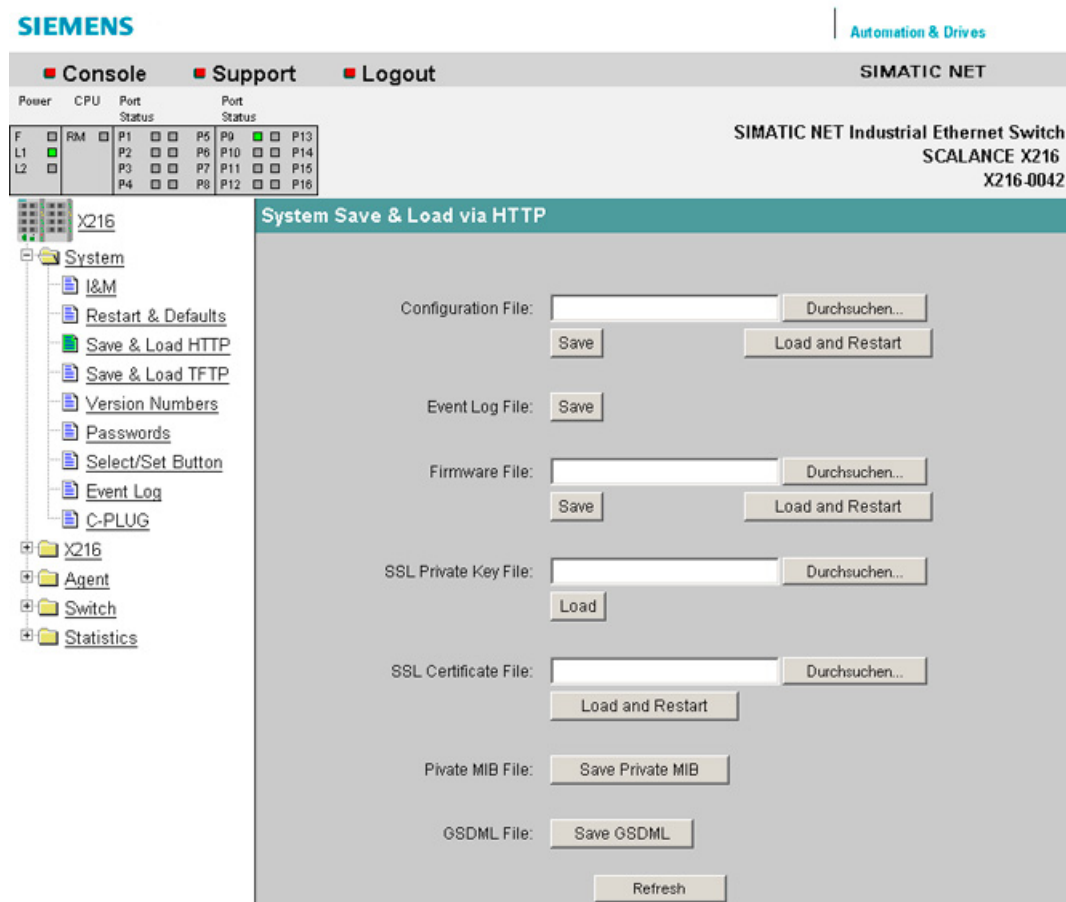

Figure 6-12 "System Save and Load via HTTP" dialog

Configuration File

Name and possibly also folder path of the configuration file that you want to load on the IE Switch X-200 or where you want to store the current configuration information.

Note

When a configuration file is downloaded, the device type is not checked.

Event Log File

By clicking "Save", you can save the event table (event log file) on the local computer.

Firmware File

Name and, if applicable, directory path of the file from which you want to load the new firmware.

NOTICE

If firmware is loaded that is older than the firmware on the device, you will have to reset the device to the factory defaults after loading the firmware.

If the firmware of an IE Switch X-200 is updated, make sure that the firmware in use is compatible with the relevant device.

If incompatible firmware is loaded on the device, it will no longer be possible to operate the device. In this case, compatible firmware will have to be loaded again with the boot loader.

You should therefore remember the following restrictions:

- SCALANCE X200-4P IRT, X201-3P IRT and X202-2P IRT are compatible with firmware X200IRT V2.1 or later.
- SCALANCE X202-2P IRT PRO and X204P IRT PRO are compatible with firmware X200IRT V3.1 or later.
- SCALANCE XF204IRT is compatible with firmware X200IRT V4.1 or later.
- SCALANCE X201-3P IRT PRO is compatible with firmware X200IRT V4.5 or later.
- SCALANCE XF204, XF204-2, XF206-1, XF208 are compatible with firmware X200 V4.1 or later.
- SCALANCE X204-2TS is compatible with firmware X200 V4.3 or later.

SSL Private Key File

Name of the file that contains the private key for SSL.

SSL Certificate File

Name of the file that contains the certificate for SSL.

Private MIB File

Here, you can save the private MIB of the IE Switch X-200 in a file.

GSDML file

Here, you can save the GSDML file of the IE Switch X-200 in a file.

Note

The private key and the certificate for SSL are required to allow the user to communicate via a secure connection with the Web server on the IE Switch X-200.

The files must be available in PEM format.

6.3.5.7 The "System Save & Load TFTP" WBM menu

System Save & Load TFTP

The WBM allows you to store configuration information in an external file on a TFTP server or to load such data from an external file from the TFTP server to the IE Switch X-200.

You can also load new firmware from a file located on the TFTP server. You can make the entries required for this on the page of the System Save & Load TFTP menu.

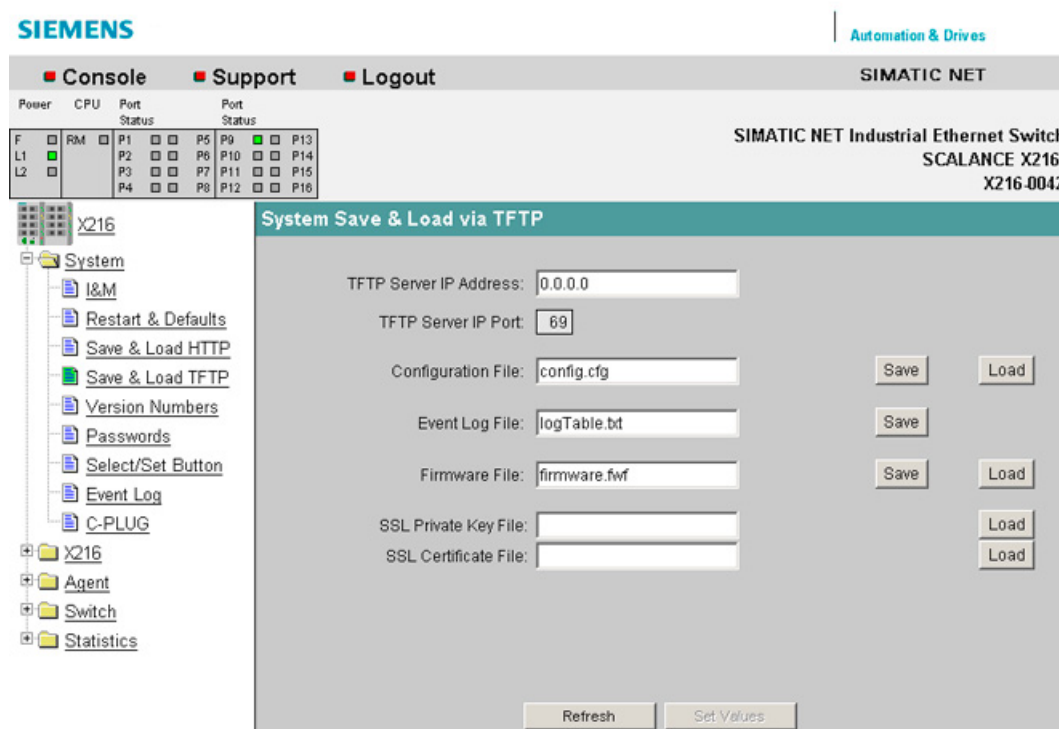

Figure 6-13 "System Save and Load via TFTP" dialog

TFTP Server IP Address

The IP address of the TFTP server with which you want to exchange data.

TFTP Server IP Port

The port of the TFTP server over which data exchange will be handled. If necessary, you can change the default value 69 to your own requirements using the CLI.

Configuration File

Name and possibly also folder path of the configuration file (maximum 32 characters) that you want to load on the IE Switch X-200 or where you want to store the current configuration information.

Note

When a configuration file is downloaded, the device type is not checked.

Event Log File

By clicking "Save", you can save the event table (event log file) on the local computer.

Firmware File

Name and possibly also folder path of the file (maximum 32 characters) from which you want to load the new firmware.

<p>NOTICE</p> <p>If firmware is loaded that is older than the firmware on the device, you will have to reset the device to the factory defaults after loading the firmware.</p> <p>If the firmware of an IE Switch X-200 is updated, make sure that the firmware in use is compatible with the relevant device.</p> <p>If incompatible firmware is loaded on the device, it will no longer be possible to operate the device. In this case, compatible firmware will have to be loaded again with the boot loader.</p> <p>You should therefore remember the following restrictions:</p> <ul style="list-style-type: none">• SCALANCE X200-4P IRT, X201-3P IRT and X202-2P IRT are compatible with firmware X200IRT V2.1 or later.• SCALANCE X202-2P IRT PRO and X204P IRT PRO are compatible with firmware X200IRT V3.1 or later.• SCALANCE XF204IRT is compatible with firmware X200IRT V4.1 or later.• SCALANCE X201-3P IRT PRO is compatible with firmware X200IRT V4.5 or later.• SCALANCE XF204, XF204-2, XF206-1, XF208 are compatible with firmware X200 V4.1 or later.• SCALANCE X204-2TS is compatible with firmware X200 V4.3 or later.

SSL Private Key File

Name of the file that contains the private key for SSL.

SSL Certificate File

Name of the file that contains the certificate for SSL

Note

The private key and the certificate for SSL are required to allow the user to communicate via a secure connection with the Web server on the IE Switch X-200.

The files must be available in PEM format.

System Command Line Interface

Table 6- 6 System Save & Load TFTP - CLI\SYSTEMLOADSAVE>

Command	Description	Comment
info	Displays information on the system.	
server [IP address] [:port]	Specifies the IP address or the port of the TFTP server with which data will be exchanged.	Administrator only.
fwname	Specifies the name of the firmware file.	Administrator only.
fwload	Loads the firmware from a file.	Administrator only.
fwsave	Saves the firmware in a file.	Administrator only.
cfgname [file name]	Specifies the name of a file (maximum 255 characters) from which the configuration data will be loaded or in which this data will be saved.	Administrator only.
cfgsave	Saves the configuration data in a file.	Administrator only.
cfgload	Loads the configuration data from a file.	Administrator only.
logname [file name]	Specifies the name of a file (maximum 255 characters) in which the log table is stored.	Administrator only.
logsave	Saves the log table in a file.	
pkname	Specifies the name of the file (maximum 255 characters) that contains the private SSL key.	Administrator only.
pkload	Loads the private SSL key from a file.	Administrator only.
ctname	Specifies the name of the file (maximum 255 characters) that contains the SSL certificate.	Administrator only.
ctload	Loads the SSL certificate from a file.	Administrator only.

6.3.5.8 The "System Version Numbers" WBM menu

System Version Numbers

This dialog informs you about the current versions of the boot software, firmware, and hardware.

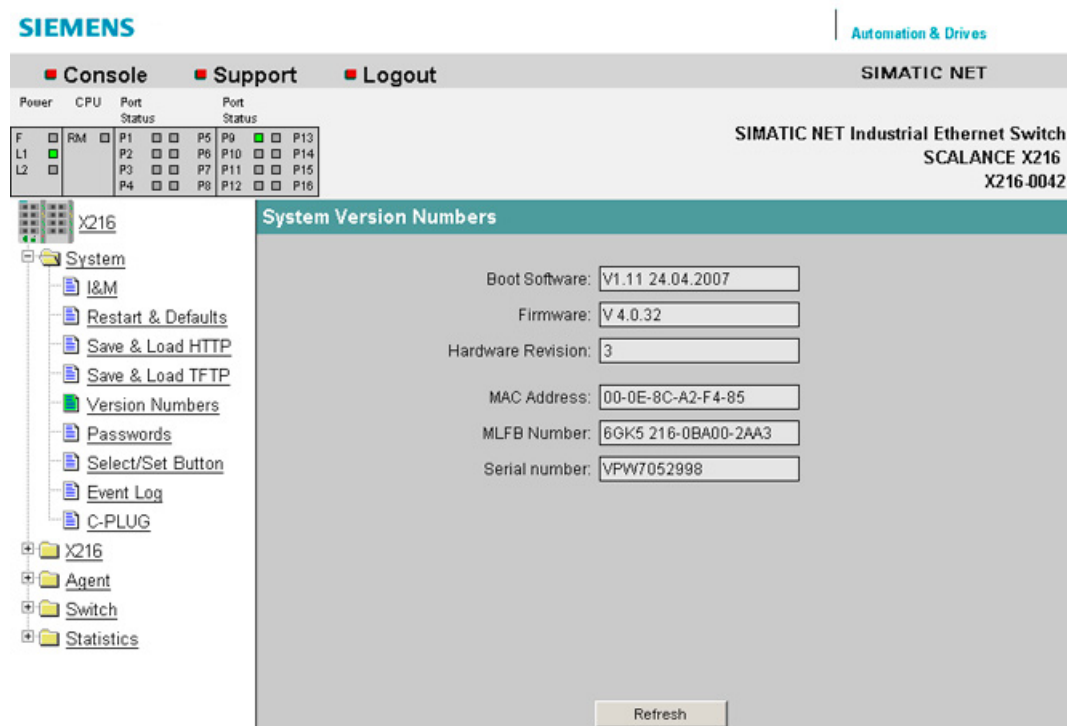

Figure 6-14 "System Version Numbers" dialog

Boot Software

The version of the boot software is displayed here. The boot software is stored permanently on the IE Switch X-200 and is used to load new firmware.

Firmware

The version of the firmware running on the IE Switch X-200.

Hardware Revision

Displays the version of the device.

MAC Address

Displays the MAC address of the device.

MLFB Number

Displays the order number of the device.

Serial number

Displays the serial number of the device.

Syntax of the Command Line Interface

Table 6- 7 System Information - CLI\>

Command	Description	Comment
info	Displays the MAC address, MLFB and serial number	

Table 6- 8 System Configuration - CLI\SYSTEM>

Command	Description	Comment
versions	Shows versions of firmware, hardware and boot software.	

6.3.5.9 The "System Passwords" WBM menu

System Passwords

In this dialog, if you are the administrator, you can change the passwords for Admin and User. The password can be up to a maximum of 16 characters (7-bit ASCII) long.

You apply your settings with "Set Value".

Note

Default password when supplied

- For Admin: admin
- For the user: user.

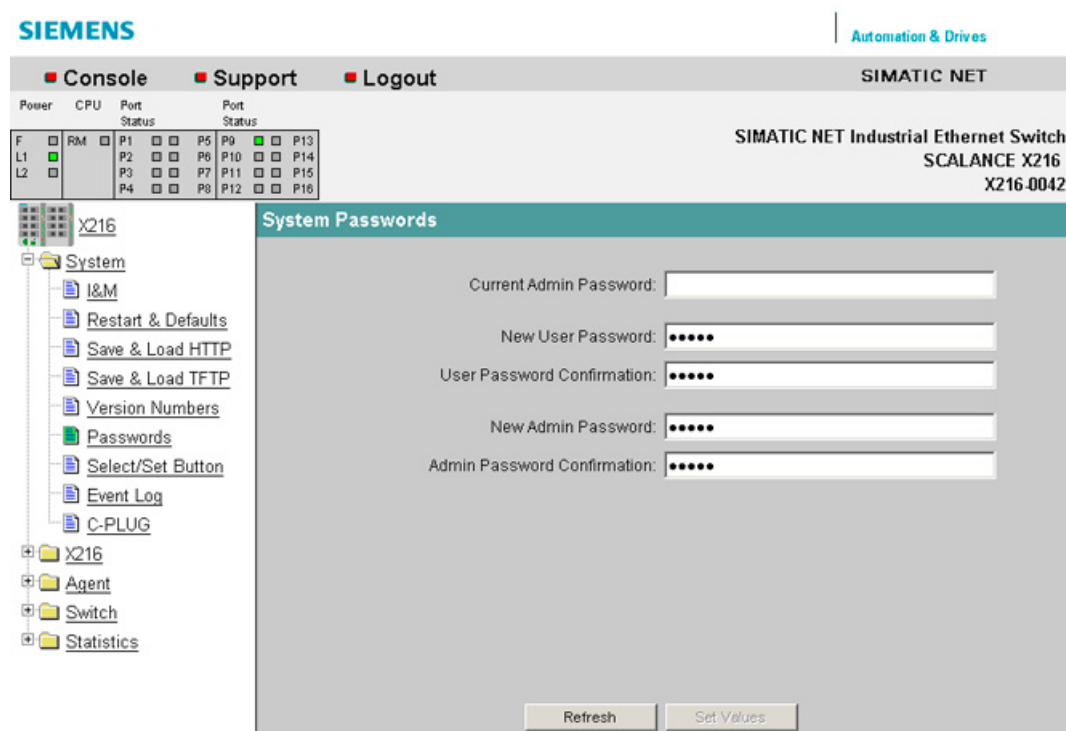

Figure 6-15 "System Passwords" dialog

Table 6- 9 System Passwords - CLI\SYSTEM>

Command	Description	Comment
password <admin user> <password>	Sets a new password for the user or administrator.	Administrator only.

6.3.5.10 The "System Select/Set Button" WBM menu

System Select/Set Button

In this dialog, you can set the function that can be configured by pressing the Select/Set button.

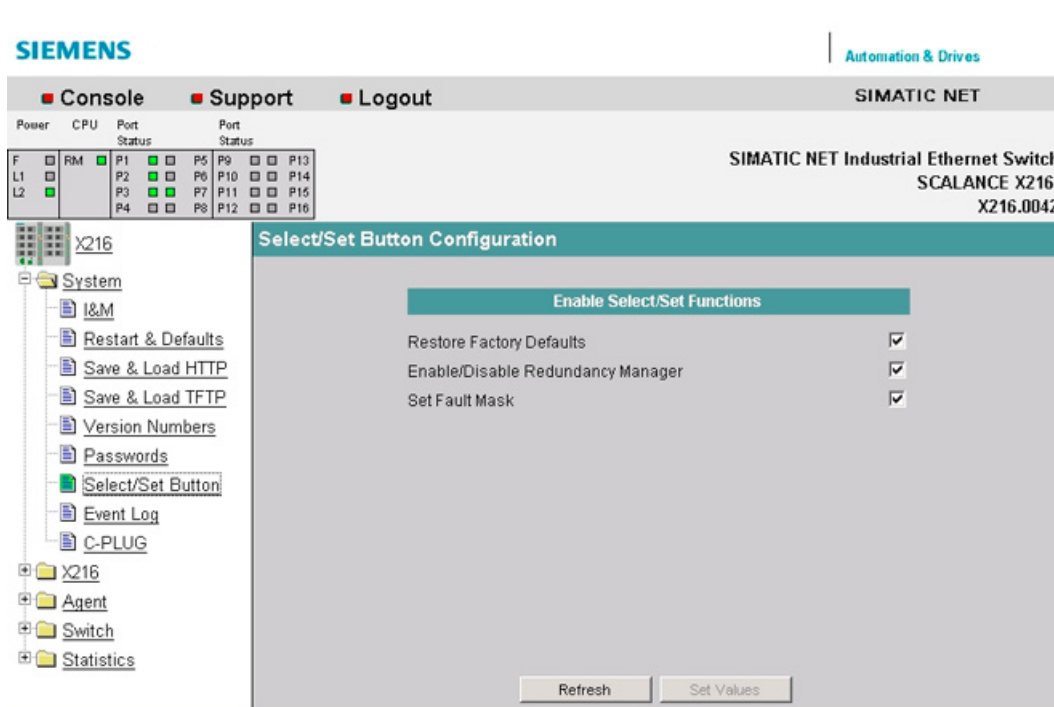

Figure 6-16 "Select/Set Button Configuration" dialog

Restore Factory Defaults

Here, you can restore the factory defaults using the Select/Set button.

Enable/Disable Redundancy Manager

Here, you can decide whether or not the redundancy manager can be enabled and disabled with a button.

Set Fault Mask

Here, you can specify whether or not it is possible to set the fault mask with a button.

6.3.5.11 The "System Event Log" WBM menu

System Event Log Table

This dialog shows which events occurred and when. You specify the events that are to be logged in the "Agent/Event Config" dialog.

You can save the event table using HTTP or TFTP in the System menu.

Note

Note that events occurring in quick succession are not always displayed in the causal sequence.

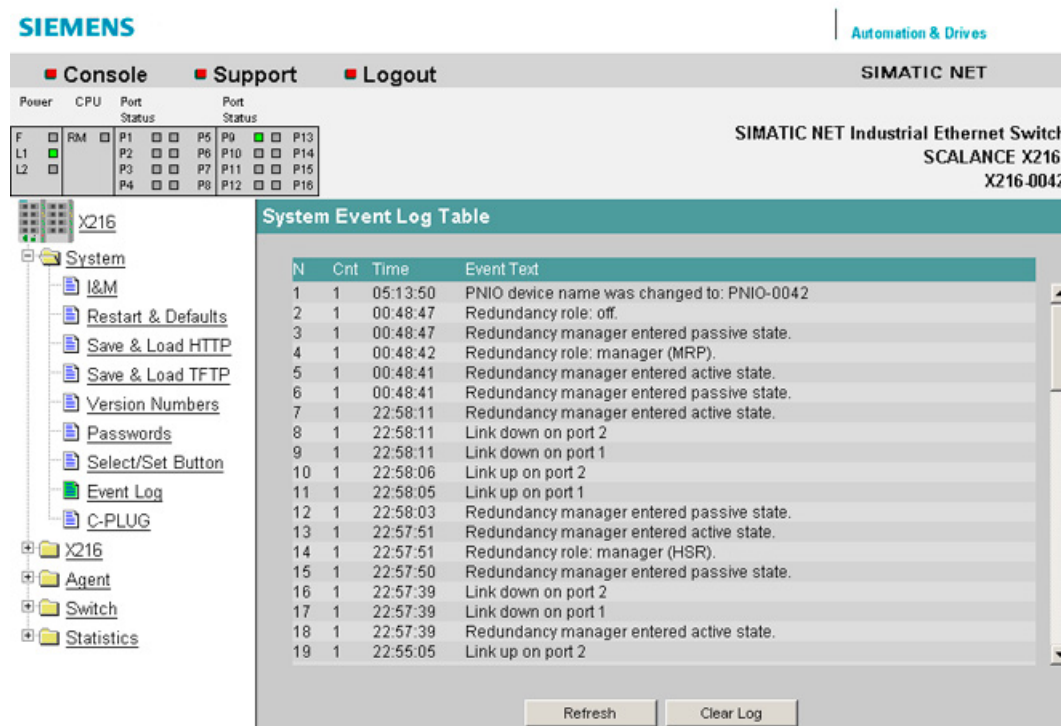

Figure 6-17 "System Event Log Table" dialog

Syntax of the Command Line Interface

Table 6- 10 System Event Log Table- CLI\SYSTEMLOG>

Command	Description	Comment
info	Displays information on the log table configuration.	
events <show clear>	Indicates or erases expired events in memory.	Administrator only.
eventmax [Max count]	Specifies the maximum number of events in the log table. A maximum of 10 to 400 entries can be set.	Administrator only.

6.3.5.12 The "X200" WBM menu

Status

This page provides information on operating states such as power supply and fault status.

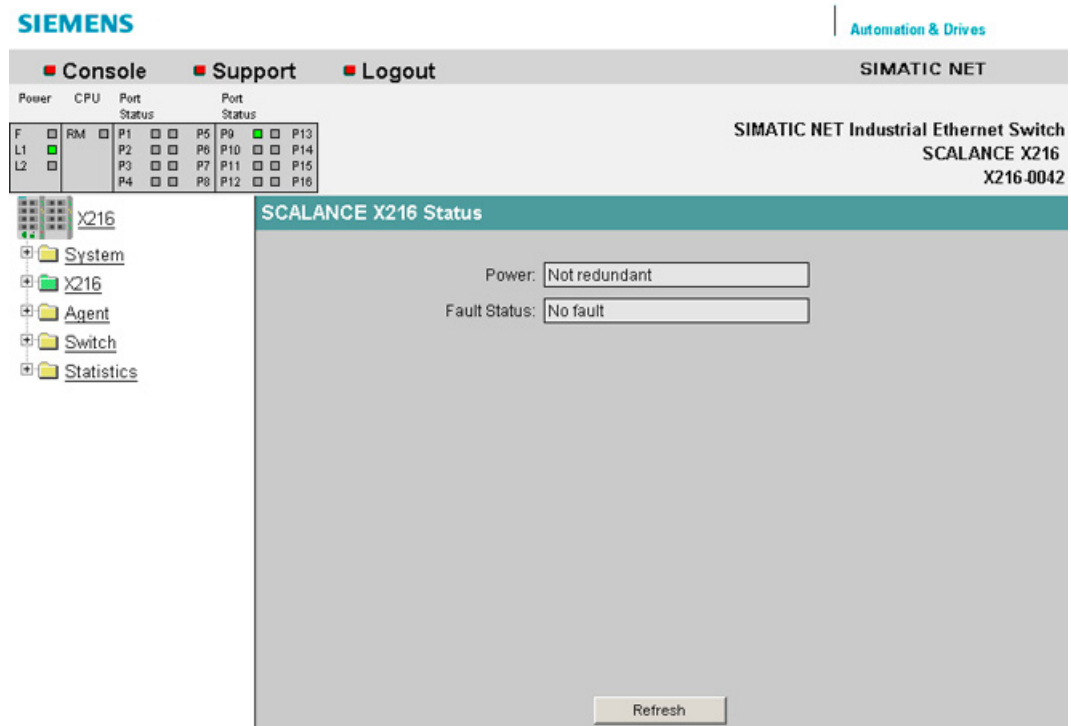

Figure 6-18 "Status" dialog

Power

This displays how the power is supplied.

Fault Status

Indicates whether faults are pending and if so which.

6.3.5.13 The "X200 Fault Mask" WBM menu

Fault Mask

The settings in this dialog allow you to monitor the link status and the redundant power supply.

The values of the settings that can be made with the button configuration are also displayed.

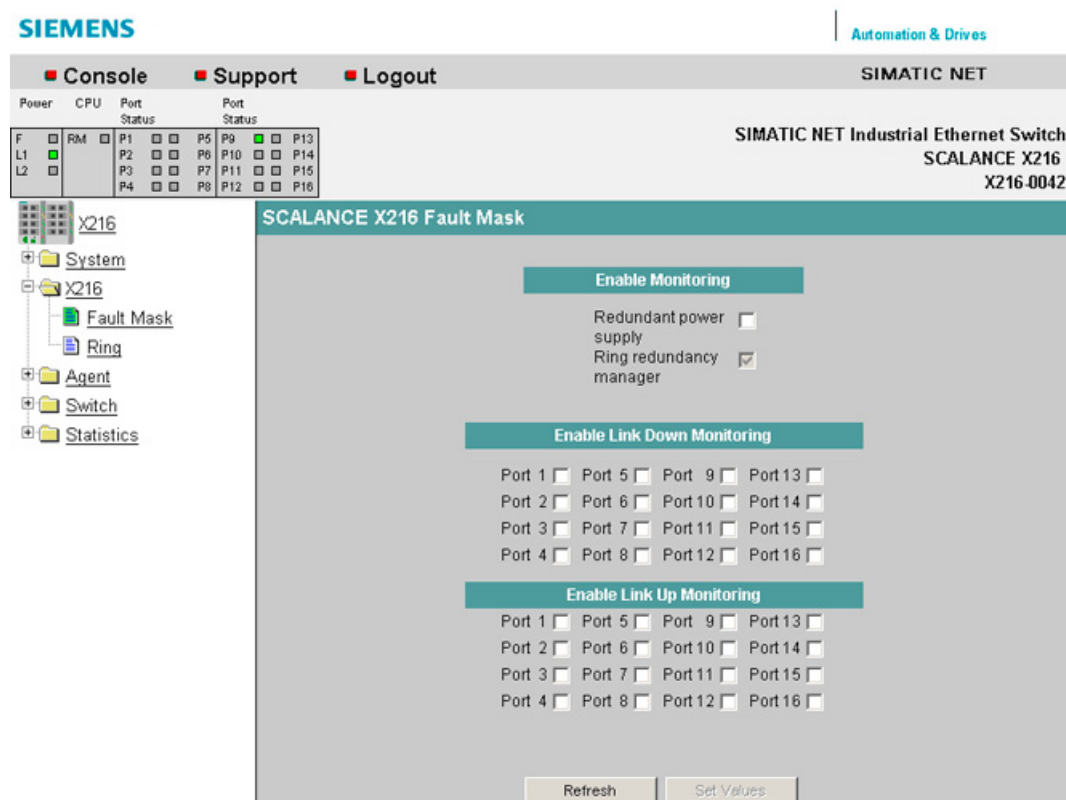

Figure 6-19 "Fault Mask" dialog

Enable Monitoring

Redundant power supply

Here, you can enable/disable monitoring of the redundant power supply.

Note

The following devices do not have a redundant power supply:

- SCALANCE X204 IRT PRO
- SCALANCE X202-2P IRT PRO
- SCALANCE X201-3P IRT PRO

Ring Redundancy Manager

Here you can choose whether the "active" status of the redundancy manager triggers an error.

Standby Manager (only SCALANCE X200IRT)

Here, you can choose whether the "master" status and "passive" or "slave" and "active" or partner not found triggers an error.

Enable Link Down Monitoring

Error message when the status of the port is "Link down". Here, you can enable/disable monitoring of the link status for the individual ports.

Enable Link Up Monitoring

Error message when the status of the port is "Link up". Here, you can enable/disable monitoring of the link status for the individual ports.

Note

With the default setting as supplied, no port is monitored; in other words, the fault mask is empty.

As default, the power supply is also not monitored.

Syntax of the Command Line Interface

Table 6- 11 Fault Mask - CLI\X200>

Command	Description	Comment
info	Displays information on the "X-200" menu item.	
fault	Displays the fault status.	
downmask <1-n> <E D>	Specifies a port mask for the ports for which the monitoring of a link down event is enabled.	Administrator only.
upmask <1-n> <E D>	Specifies a port mask for the ports for which the monitoring of a link up event is enabled.	Administrator only.
others <P> <E D>	Specifies the fault mask for: P - power mask	Administrator only.

6.3.5.14 The "X200 Ring" WBM menu

"Ring redundancy"

In this dialog, you can configure the ports for fast ring redundancy. You can also select the required redundancy method in this mask.

Note

X-200 IE switches as of firmware V4.0 support the media redundancy methods MRP and HSR.

X-200 IE switches with firmware V3.1 and older, X-300 and X-400 IE switches with firmware V2.3 and older and OSMs/ESMs support only the HSR method.

Note

If you want to configure an MRP ring, the devices can be interconnected to form a ring without any extra configuration. In this case, the default ring ports must be used, see section "Overview of the product characteristics", table "Overview of the connection options". The default mode "Automatic Redundancy Detection" automatically configures the ring.

If an HSR ring is configured, exactly one device in the ring must be set to "HSR Manager" mode. All other devices in the ring must be set to either "Automatic Redundancy Detection" or "HSR Client".

If an HSR ring is configured in which a linear bus is set up in which a device is set to "HSR manager" and the other devices have the setting "Automatic Redundancy Detection", the error message "other RM in ring" is signaled. This disappears after connecting the linear bus to form a ring.

Note

As default, a mode for automatic ring configuration is enabled. This causes cyclic frame communication at a low data rate. If it is not required, disable this redundancy function to avoid unnecessary network load.

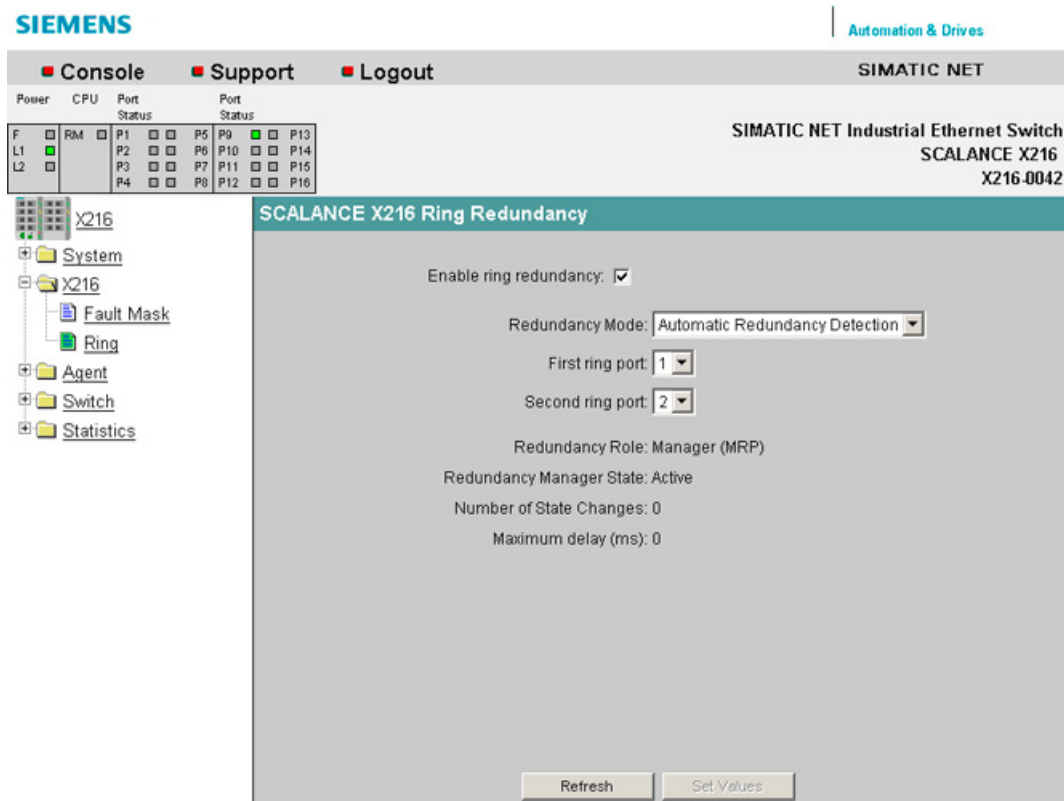

Figure 6-20 Ring Redundancy WBM menu (if the device is operating as a ring client)

Enable ring redundancy

Here, you can choose whether or not the module is part of a ring.

Redundancy Mode

Here, you can choose the role of the module within a ring.

- **Automatic Redundancy Detection**
 Select this setting to configure the redundant mode automatically.
 In "Automatic Redundancy Detection" mode, the IE Switch X-200 automatically detects whether or not there is a device with the role of "HSR Manager" in the ring. If this is the case, the device adopts the role of "HSR Client".
 If no HSR manager is found, all devices with the "Automatic Redundancy Detection" setting negotiate among themselves to establish which device adopts the role of "MRP Manager". The other device automatically set themselves to "MRP Client" mode.
- **MRP Client**
 Here, you can select the "MRP Client" role.
 In an MRP ring, at least one device must be set either to the mode "Automatic Redundancy Detection" or to the mode "MRP Manager (Auto)/Client". You also have the option of setting the "MRP Client" role for all other devices. If all except one device in the ring is configured as "MRP Client", this device automatically adopts the role of "MRP Manager".
 Select "MRP Client" mode if you want to operate the device along with components that do not originate from Siemens in the ring.

6.3 Configuration using Web Based Management (WBM) and Command Line Interface (CLI)

- **MRP Manager(Auto)/Client**
If this mode is set, the device attempts to adopt the role of "MRP Manager".
If there are several devices in the ring set to the "MRP Manager(Auto)/Client" mode, the role of "MRP Manager" is adopted automatically by one of the devices.
The the other devices adopt the role of "MRP Client".
- **HSR Client**
Here, you can select the role "HSR Client".
Select the role "HSR Client" if you want to use the standby functionality of the IE Switch X-200.
- **HSR Manager**
Here, you can select the role "HSR Manager". When you configure an HSR ring, exactly one module must be set as HSR manager.

Note

In the basic settings, the "Automatic Redundancy Detection" mode is preselected.

First ring port (relevant only when the Automatic Redundancy Detection role, MRP client or HSR client is selected and the redundancy role "HSR Manager" was adopted)

Here, you select which is the first ring port.

Second ring port (relevant only when the Automatic Redundancy Detection role, MRP client or HSR client is selected and the redundancy role "HSR Manager" was adopted)

Here, you select which is the second ring port.

Static ring port (relevant only when the HSR Manager role is selected and the redundancy role "HSR Manager" was adopted)

The port that is active in the ring is specified here.

Isolated ring port (relevant only when the HSR Manager role is selected and the redundancy role "HSR Manager" was adopted)

The port that closes the ring but via which no communication takes place is specified here.

Redundancy Role

Here, you can see which role the module has actually adopted in the ring.

Redundancy manager state (relevant only when the redundancy role "HSR Manager" or "MRP Manager" was adopted)

This indicates whether or not the redundancy manager is enabled or disabled.

Number of state changes (relevant only when the redundancy role "HSR Manager" or "MRP Manager" was adopted)

This shows how often the redundancy manager switched to a different path due to an interruption in the ring since the device was turned on.

Maximum delay (ms) (relevant only when the redundancy role "HSR Manager" or "MRP Manager" was adopted)

This shows how much a test frame was delayed. (Test frames are placed on the ring to detect interruptions in the ring.) For reliable functioning of the network, values < 20 ms are necessary.

Note

The standby function always requires an activated HSR client. If the standby manager is "enabled", the following message appears if you attempt to disable ring redundancy or to switch to redundancy manager:

Cannot disable "Redundancy" if "Standby Manager" is enabled.

Note

When shipped, ring ports are set as default, refer to the section "Overview of the product characteristics", table "Overview of the connection options".

Note

Note the following when configuring an HSR ring:

- If no redundancy "HSR Manager" has been specified yet, the ring must be interrupted at one point. This avoids circulating frames.
- If an MRP ring is configured, at least one device in the ring must be set to "Automatic Redundancy Detection" mode. The role of the redundancy manager is adopted automatically by a device with this setting.
- If you reconfigure an MRP ring to create an HSR ring, open the ring while you reconfigure the devices.

This avoids circulating frames.

NOTICE

Note the following when configuring an MRP ring:
--

- | |
|---|
| <ul style="list-style-type: none">• With devices having more than 8 ports, the selection of the ring ports when using MRP is restricted:<ul style="list-style-type: none">– With SCALANCE X216 and X224, ports 1 to 8 can be selected as MRP ring ports.– With SCALANCE X212-2 and X212-2LD, ports 9 to 14 can be selected as MRP ring ports.• The default ring ports are adapted automatically if you select MRP. Make sure that the ring ports are set correctly. |
|---|

Syntax of the Command Line Interface

Table 6- 12 Ring Redundancy - CLI\X200\REDUND>

Command	Description	Comment
info	Displays information on the redundancy modules.	
mode [A AM C E D]	Sets the redundancy mode: A - Automatic Redundancy Detection AM - MRP Manager(Auto)/Client C - MRP Client E - HSR Manager D - HSR Client	Administrator only.
static [n-m]	Specifies the static (fixed) ring port. Note: Only for the "HSR Manager" and "HSR-Client" modes: Specifies the static (fixed) ring port in the range n-m.	Administrator only.
isolated [n-m]	Specifies the isolated ring port. Note: Only for the "HSR Manager" and "HSR-Client" modes: Specifies the static (fixed) ring port in the range n-m.	Administrator only.
rports [n-m n-m]	Specifies the two ring ports in the range n-m.	Administrator only.
clear	Resets all redundancy counters to the original setting.	Administrator only.
redund [E D]	Enables / disables ring redundancy.	Administrator only.

6.3.5.15 The "X200 Standby" WBM menu

Standby manager

Note

Standby functionality is supported only by X-200IRT IE switches.

The standby manager mechanism allows the redundant coupling of two or more HSR rings. To do this, two neighboring devices within a ring must be configured as standby partners.

Enable the standby manager mechanism for both standby partners and select the port via which the module is connected to the ring you want to link to.

For the "Standby connection name", a name unique within the ring must be assigned for both partners, This identifies the two modules as standby partners that belong together.

Modules already being used as HSR managers cannot be configured as standby partners at the same time.

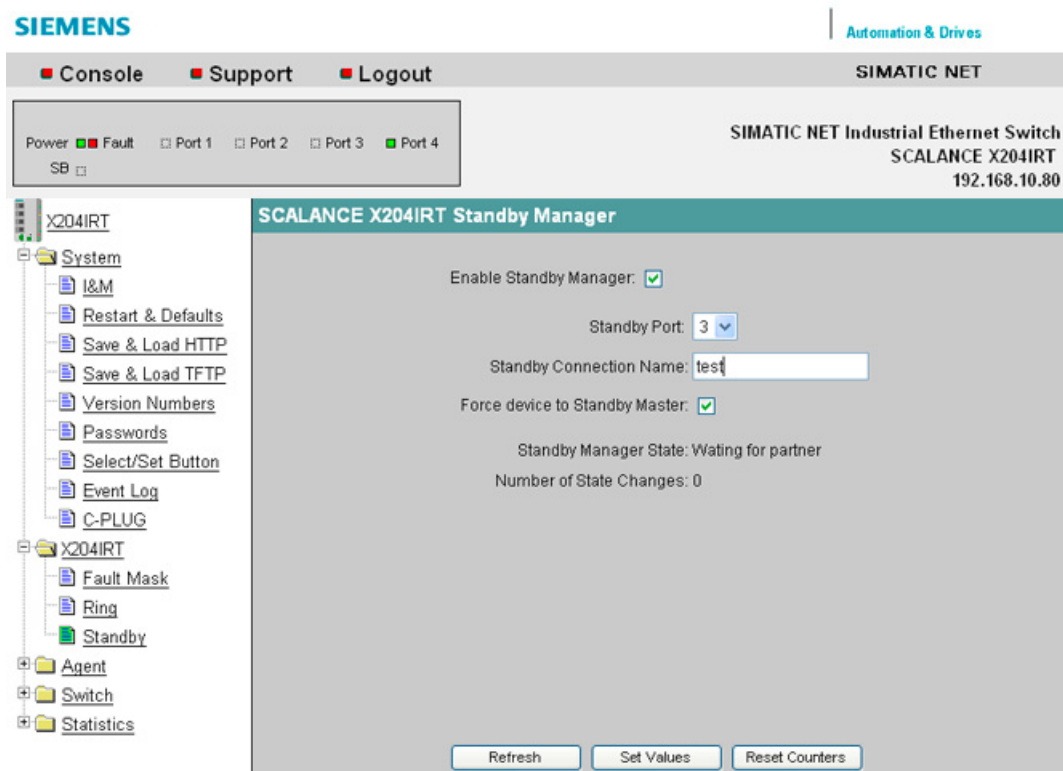

Figure 6-21 X202-2IRT Standby Manager dialog

Enable Standby manager

This function is enabled and disabled here.

Standby port

The coupling to the second ring is carried out over the selected port.

Standby connection name

The name of the standby connection is entered here; this must be identical to the name entered for the standby partner.

Force device to Standby Master

If you select this check box, the device is configured as a standby master regardless of its MAC address. If this check box is not selected for either of the devices for which the standby master is enabled, then assuming that no error has occurred, the device with the higher MAC address adopts the role of standby master. If the option is selected for both devices or if the "Force device to Standby Master" property is supported by only one device, the standby master is also selected based on the MAC address. This type of assignment is important in particular when a device is replaced. Depending on the MAC addresses, the previous device with the slave function can take over the role of the standby master.

Note

The standby manager always requires an activated HSR client. If this is not activated, the following error message is displayed:

"Cannot enable Standby manager if redundancy is disabled and not in "HSR Client" mode."

Note

If two devices are linked by the standby function, the "Standby" function must be enabled on both devices.

Note

The IE Switch X-200IRT uses a locally valid Ethernet address for communication in standby mode.

This is formed by setting the "universally/locally administered address bit" for the MAC address of the IE Switch X200IRT.

This is the second least significant bit of the first byte of the Ethernet address.

Syntax of the Command Line Interface

Table 6- 13 Standby (only for IE Switch X-200IRT) - CLI\X200\STANDBY>

Command	Description	Comment
info	Displays information on the standby module.	
port [1-4]	Specifies the standby port.	Administrator only.
partner [Name]	Specifies the name of the standby connection.	Administrator only
clear	Resets all counters to the original setting.	Administrator only
standby [E D]	Enables/disables the standby manager.	Administrator only
force [E D]	Enables/disables the device as standby master.	Administrator only

6.3.5.16 The "Agent" WBM menu

Agent Configuration

This menu item provides you with options for the IP address. You can specify whether or not the IE Switch X-200 obtains its IP address dynamically or has a fixed address. You can also enable options for accessing the IE Switch X-200 such as TELNET.

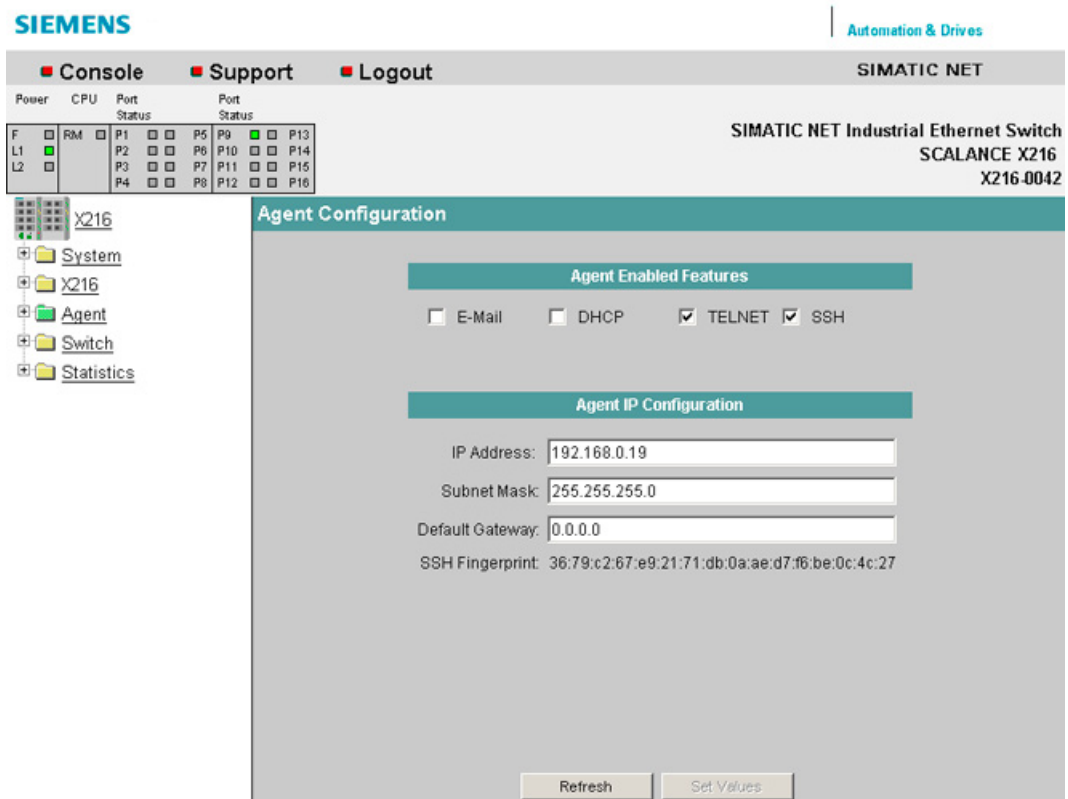

Figure 6-22 "Agent Configuration" dialog

Note

When supplied, SSH and TELNET are activated.

When supplied, DHCP (identification via MAC address) is enabled.

Settings for IE Switches X-200

Agent Enabled Features

E-Mail

Enables/disables E-mail functionality.

DHCP

Enables/disables the IE Switch X-200 searching for a DHCP server in the network when it starts up and configuring its IP parameters according to the data supplied by this server.

TELNET

Enables/disables the availability of the IE Switch X-200 over TELNET.

SSH

Enables / disables the SSH protocol.

Agent IP Configuration

IP Address

The IP address of the IE Switch X-200. If you make a change here, the WBM loses the connection to the IE Switch X-200. Enter the new address in the Internet browser to reestablish the connection.

Subnet Mask

Here, you enter the subnet mask of the IE Switch X-200.

Default gateway

If the PC with the Internet browser is not in the same subnet as the IE Switch X-200, you must enter the IP address of the default gateway here.

Syntax of the Command Line Interface

Table 6- 14 Agent Configuration - CLI\AGENT>

Command	Description	Comment
info	Displays information on the agent settings.	
timeout [E D Timeout]	Enable, disable or specify the TELNET timeout. When specifying the value, a range of 60 to 600 seconds is possible.	Administrator only.
mail [E D]	Enables/disables the mailing function.	Administrator only.
ping [-c number] [-s length] <IP address>	Sends a number of packets to the specified IP address. If the parameters for number and length are omitted, an IE switch sends ten packets each with a length of 128 bytes. Example: ping -c 5 -s 256 192.168.1.1 Five packets with a length of 256 bytes are sent to IP address 192.168.1.1.	-
wbmtime [minutes]	Displays or specifies the time limit after which a WBM connection is reset. A maximum value of 999 minutes can be set. The value 0 disables the time limit.	Administrator only.

Table 6- 15 Agent Configuration - CLI\AGENT\IP>

Command	Description	Comment
info	Displays information on the IP settings.	
ip [IP address]	Specifies the IP address. DHCP is disabled.	Administrator only.
subnet [subnet mask]	Specifies the subnet mask.	Administrator only.
gateway [IP address]	Specifies the IP address of the default IP gateway.	Administrator only.
dhcp [E D]	Enables / disables DHCP.	Administrator only.
dhcptype [M N C D]	Specifies the DHCP parameters: - M MAC address - N system name - C client ID - D PNIO device name	Administrator only.
clientid [client ID]	Specifies the DHCP client ID.	Administrator only.

6.3.5.17 The "Ping" WBM menu

Reachability of an address in an IP network

The ping function in Web Based Management has exactly the same function as the terminal function of the same name. It checks whether an address exists in an IP network.

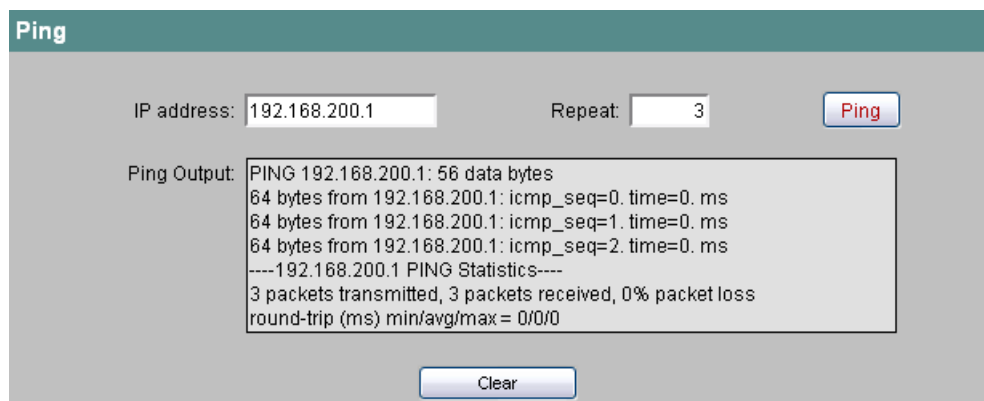

IP address

Enter the IP address of the network device you want to ping to test whether it can be reached.

Repeat

Here, enter the number of data packets to be sent.

Ping

Click this button to start sending the data packets.

Ping Output

This box shows the output of the ping function.

6.3.5.18 The "Agent SNMP Config" WBM menu

Note

On X-200IRT IE switches with firmware versions V4.0 and lower only the SNMPv1/v2 mode is possible.

Agent SNMP Configuration - Configuration of SNMP for an IE Switch X-200

On the SNMP Configuration page, you make basic settings for SNMP. For detailed settings (traps, groups, users), there are separate menu items in WBM.

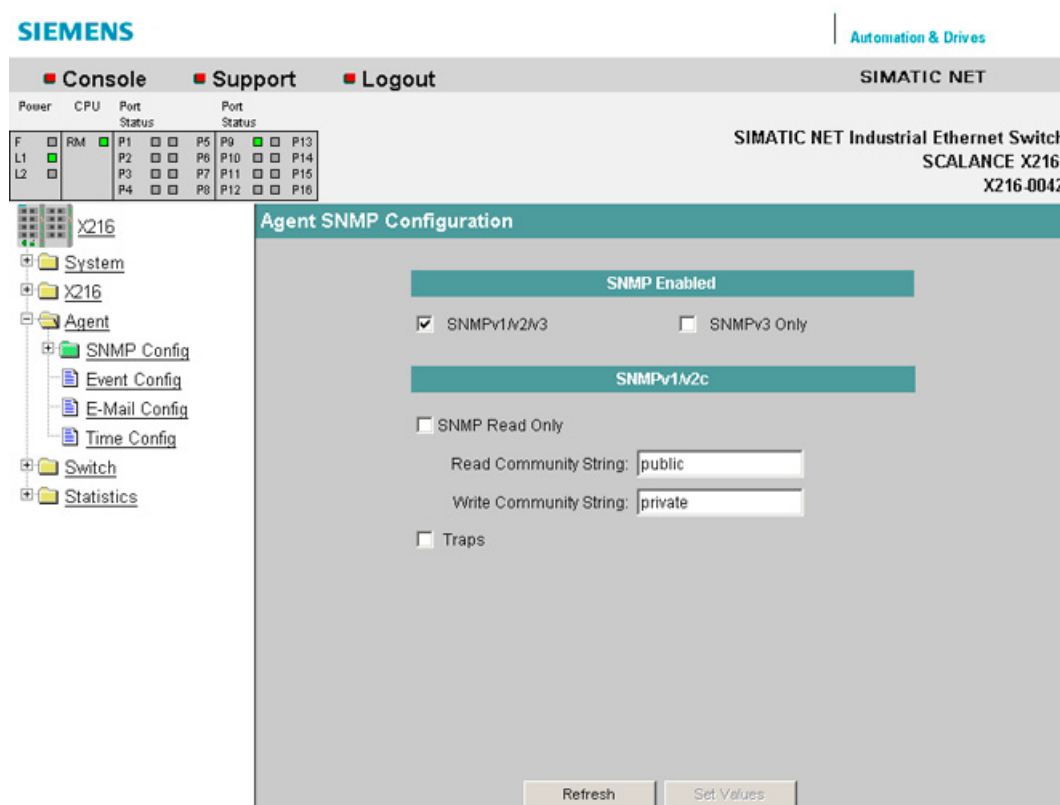

Figure 6-23 "Agent SNMP Configuration" dialog

SNMP enabled

Here, you can decide whether only SNMPv3 or also SNMPv1/v2 can be used.

SNMP Read Only

Enables/disables write protection for SNMP variables.

SNMP Community Strings

Read Community String

Displays the user name for read access to SNMP variables.

Write Community String

Displays the user name for write access to SNMP variables. Here, changes can only be made, when write protection (SNMP read only) has been disabled.

Traps

Here, you can enable or disable the sending of SNMP traps.

Syntax of the Command Line Interface

Table 6- 16 Agent SNMP Configuration - CLIAGENT\SNMP>

Command	Description	Comment
info	Displays information on SNMP.	
snmp [A 3 D]	Enables either [A] all SNMP versions or [3] only SNMPv3 or [D] disables SNMP.	Administrator only.
readonly	Enables / disables SNMPv1 read only mode.	Administrator only.
getcomm [string]	Specifies the Read Community string.	Administrator only.
setcomm [string]	Specifies the Write Community string.	Administrator only.
traps [E D]	Enables / disables SNMPv1 traps.	Administrator only.

6.3.5.19 The "Agent SNMP Trap Config" WBM menu

Agent Trap Configuration - SNMP Traps for Alarm Events

If an alarm event occurs, the IE Switch X-200 can send traps (alarm frames) to up to two different (network management) stations at the same time. Traps are sent only for events specified in the Agent Event Configuration menu.

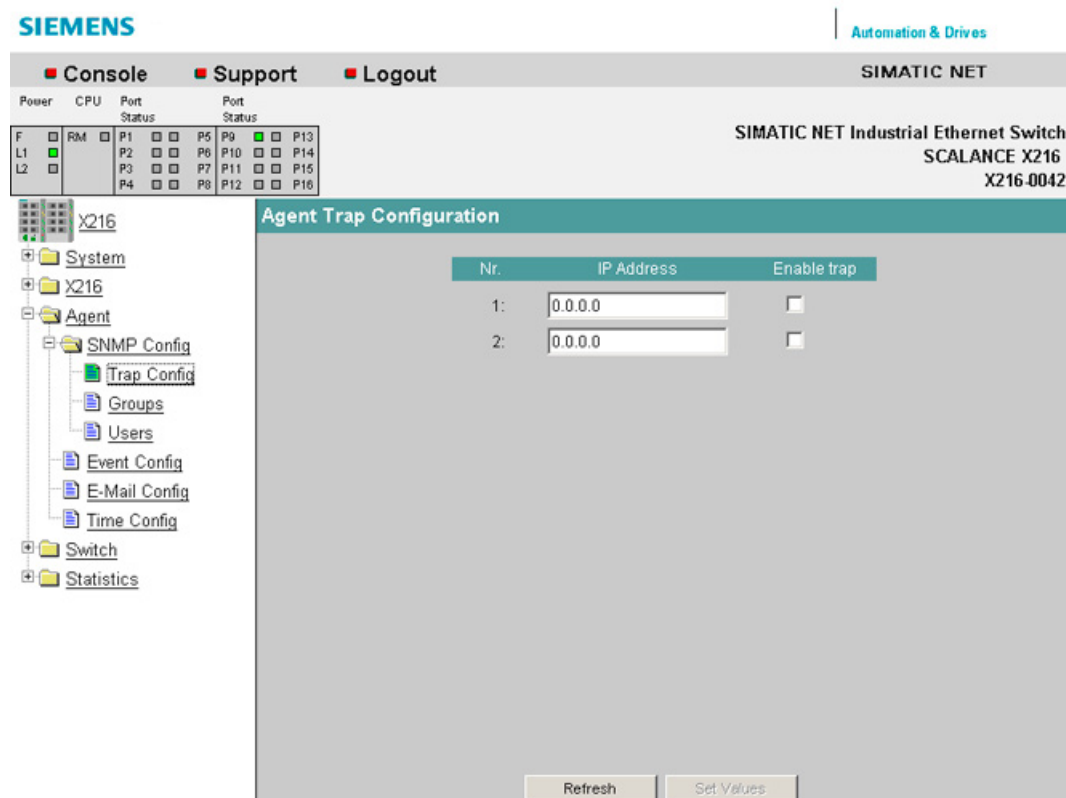

Figure 6-24 "Agent Trap Configuration" dialog

IP Address

Here, you enter the addresses of the stations to which the IE Switch X-200 will send traps.

Enable Trap

Click on the check box next to the IP addresses to enable the sending of traps to the corresponding stations.

Syntax of the Command Line Interface

Table 6- 17 Agent Trap Configuration - CLIAGENT\TRAP>

Command	Description	Comment
info	Shows the trap configuration table.	
traps [E D]	Enables / disables traps.	Administrator only.
settrap <entry> <IP> <E D>	Enables / disables the trap IP address to be specified.	Administrator only.

6.3.5.20 The "Agent SNMP Config Groups" WBM menu

Agent SNMP Configuration Groups

In this screen, you create or delete user groups for device access using SNMPv3. You can decide whether or not members of a group need to authenticate themselves, whether they communicate with encryption and whether they have read and write permissions.

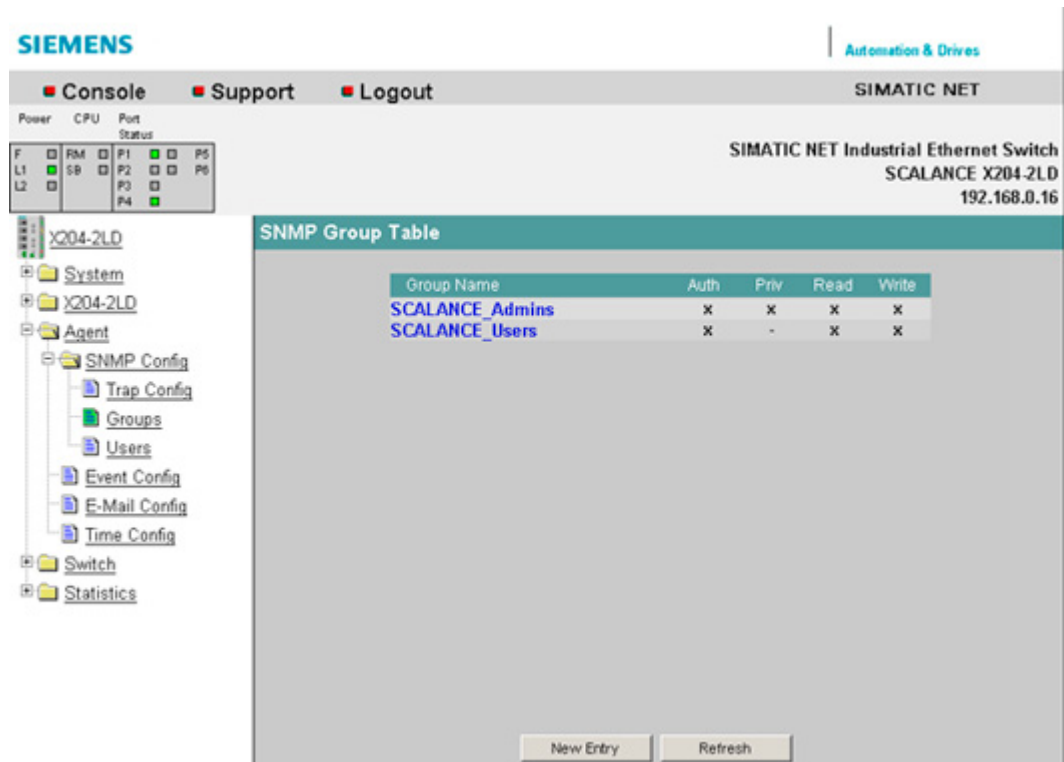

Figure 6-25 Agent SNMP Configuration Groups screen

Syntax of the Command Line Interface

Table 6- 18 Agent SNMP Configuration Groups - CLIAGENT\SNMP\GROUP>

Command	Description	Comment
info	Displays a list of all created SNMPv3 user groups.	
add <Name> [NOAUTH AUTH PRIV] [R W]	Adds an SNMPv3 user group.	Administrator only.
edit <index> [NOAUTH AUTH PRIV] [RE RD WE WD]	Changes the properties of an SNMPv3 group. The index of the group to be modified must be obtained with the "Info" command.	Administrator only.
delete <index>	Deletes an SNMPv3 group. The index of the group to be deleted must be obtained with the "Info" command.	Administrator only.
clearall	Deletes all the SNMPv3 groups that have been created.	Administrator only.

6.3.5.21 The "Agent SNMP Config Group Table" WBM menu

Agent SNMP Configuration Group Table

If you want to create a new SNMPv3 user group, this dialog appears:

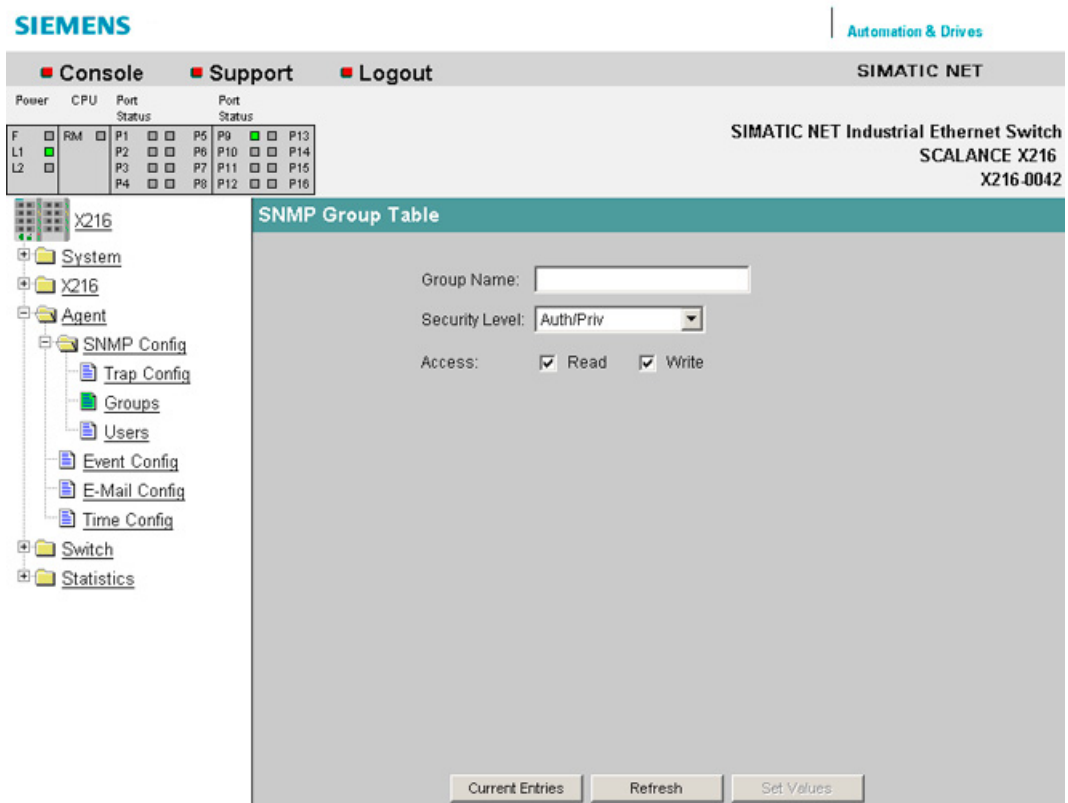

Figure 6-26 Agent SNMP Configuration Group Table dialog

Group Name

Enter the name of the SNMPv3 group you want to create here.

Security Level

Here, you set the required security level for the group you are creating.

No Auth/No Priv	The members of the group do not need to authenticate themselves when accessing the IE Switch X-200 and communicate without encryption.
Auth/No Priv	The members of the group need to authenticate themselves for SNMP access to the IE Switch X-200 but nevertheless communicate without encryption.
Auth/Priv	The members of the group need to authenticate themselves and communicate via an encrypted SNMP connection.

Access

Here, you decide whether the members of the group have read and write permissions.

6.3.5.22 The "Agent SNMP Config Users" WBM menu

Agent SNMP Configuration Users

Here, you can create or remove users for access via SNMPv3.

When you create a user, you assign it to a previously created group. You also need to set the required passwords and the authentication algorithm.

The relevant user names are the defaults for the passwords.

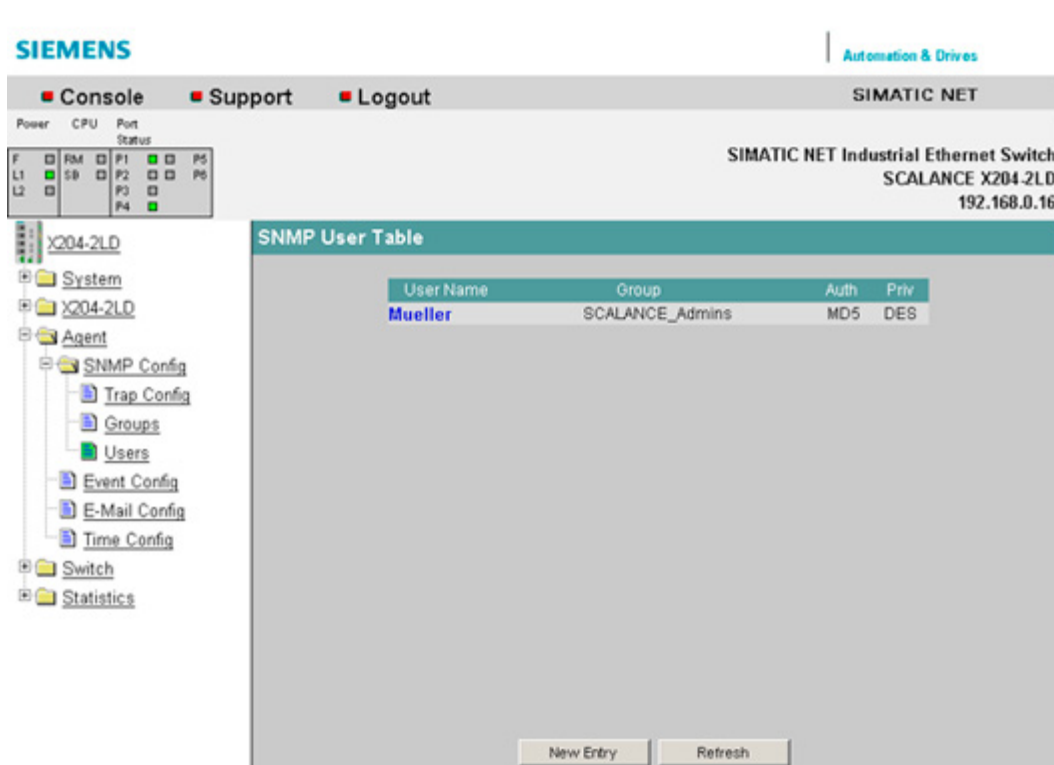

Figure 6-27 Agent SNMP Config Users screen

Syntax of the Command Line Interface

Table 6- 19 Agent SNMP Configuration Users - CLIAGENT\SNMP\USER>

Command	Description	Comment
info	Displays a list of all created SNMPv3 users.	
add <user> <group> [NONE MD5 SHA] [Authpass] [Privpass]	Adds a new SNMPv3 user to a user group.	Administrator only.

Command	Description	Comment
edit <index> <group> [NONE MD5 SHA] [Authpass] [Privpass]	Changes the properties of an SNMPv3 user. The index of the user to be modified must be obtained with the "Info" command.	Administrator only.
delete <index>	Deletes an SNMPv3 user. The index of the user to be deleted must be obtained with the "Info" command.	Administrator only.
clearall	Deletes all SNMPv3 users that have been created.	Administrator only.

6.3.5.23 The "Agent SNMP Config User Table" WBM menu

Agent SNMP Configuration User Table

If you want to create a new SNMPv3 user, this dialog appears:

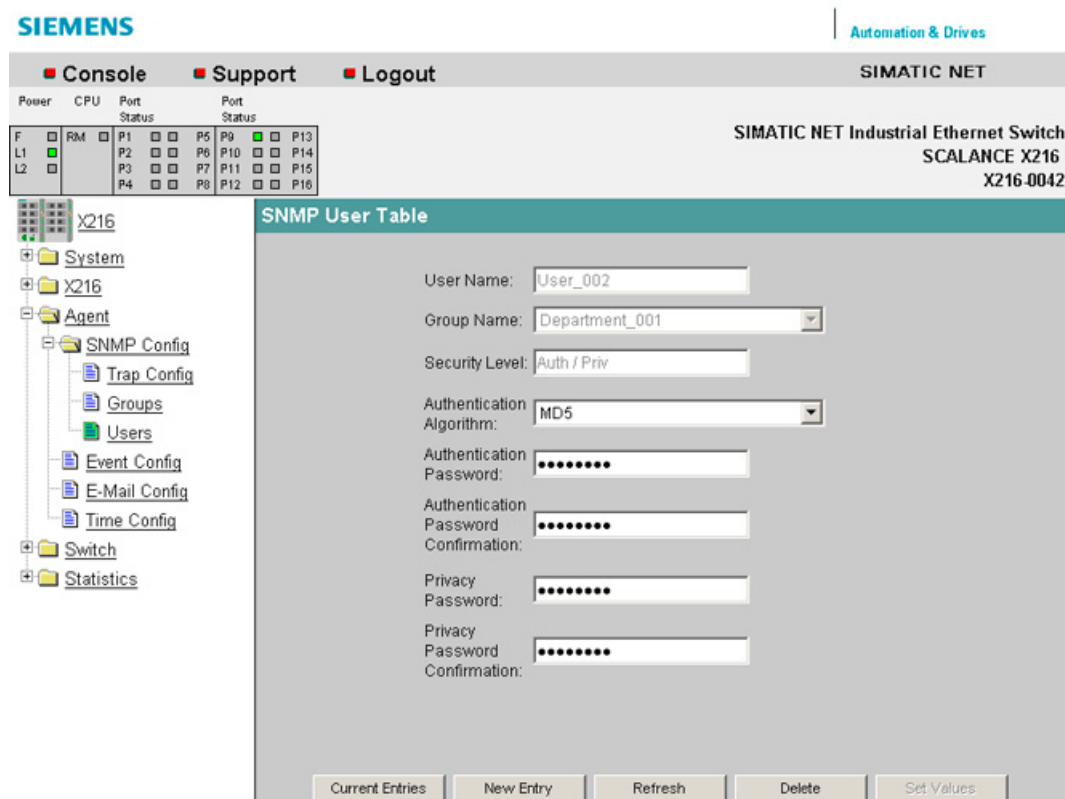

Figure 6-28 Agent SNMP Configuration User Table dialog

User Name

Enter the name of the user you want to create here.

Group Name

Here, you select the SNMPv3 user group to which the user you are creating will be assigned.

Authentication Algorithm

Here, you select the authentication method that the user will use.

Authentication Password/Password Confirmation

Here, you enter the password with which the user you are creating will log on with the IE switch for SNMPv3 communication.

Privacy Password/Password Confirmation

Here, you specify the password that the user will use for encryption of SNMPv3 communication.

6.3.5.24 The "Agent Event Config" WBM menu

Agent Event Configuration

On this page, you specify how the IE Switch X-200 reacts to system events. By selecting the corresponding check boxes, you specify how the IE Switch X-200 reacts to the various events. The following options are available:

- The IE Switch X-200 sends an e-mail.
- The IE Switch X-200 triggers an SNMP trap.
- The IE Switch X-200IRT saves the relevant event in the event table.

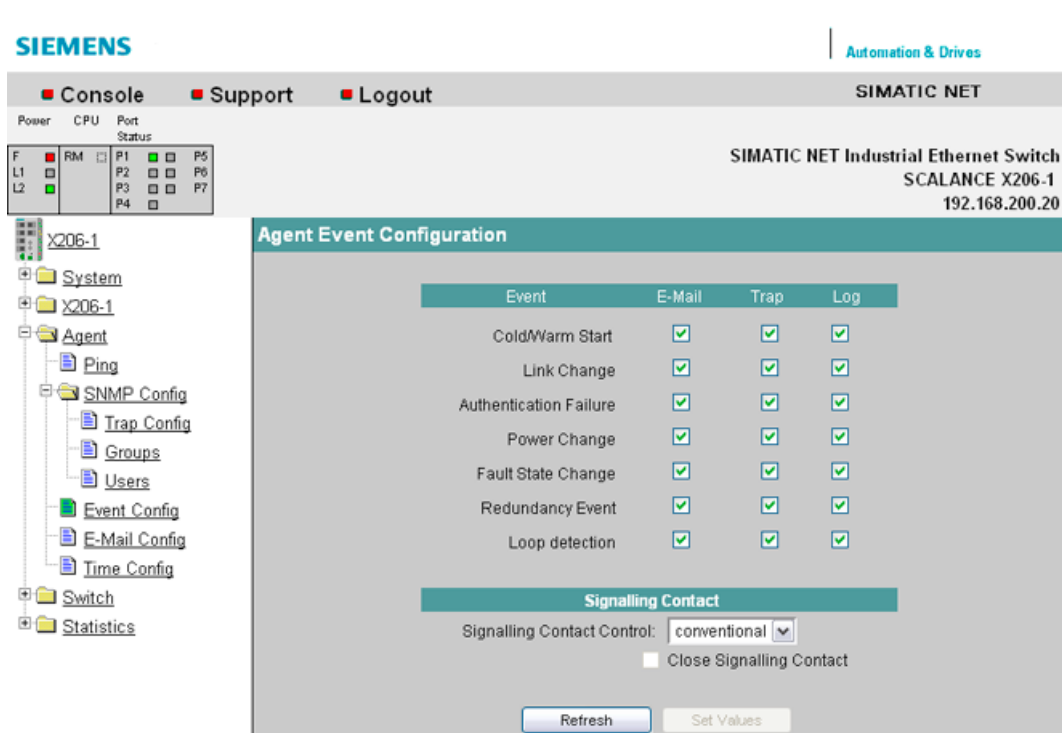

Figure 6-29 "Agent Event Configuration" dialog

You can configure the reaction of the IE Switch X-200 to the following events:

Cold/Warm Start

The IE Switch X-200 was turned on or reset by the user.

Link Change

A port has failed or data traffic is being handled again over a port that had previously failed.

Authentication Failure

There was an SNMP or Web Based Management access with a bad password or inadequate access rights (refer also to the section "Agent SNMP Configuration").

Power Change

This event occurs only when the power supply line 1 and line 2 is monitored. It indicates that there was a change to line 1 or line 2.

Fault State Change

The fault status has changed. The fault status can relate to the activated port monitoring, the response of the signaling contact or the power supply monitoring.

Redundancy Event

A redundancy event is triggered:

- When the redundant connection is opened or closed
- When a second ring manager is identified.

Loop detection

A loop was detected in the network.

Standby Event (relevant for IRT switches only)

A standby event is triggered:

- When the standby connection is opened or closed
- When the standby partner is lost or returns.

Signaling Contact Control

With this drop-down list, you can specify how the signaling contact works:

- **conventional**
Default setting for the signaling contact. An error/fault is displayed by the fault LED and the signaling contact opens. When the error/fault state no longer exists, the fault LED goes off and the signaling contact closes.
- **aligned**
The way the signaling contact works depends on the error/fault that has occurred. The signaling contact can be opened or closed as required by user actions.

Close Signaling Contact

Select this check box if you want to close the signaling contact.

Note

The setting of the "Close Signaling Contact" check box is only effective if the "aligned" setting was selected in the "Signaling Contact Control" drop-down list.

Syntax of the Command Line Interface

Table 6- 20 Agent Event Configuration - CLIAGENT\EVENT>

Command	Description	Comment																
info	Shows the current event configuration.																	
scontrol [C A].	<p>Selects how the signaling contact works:</p> <ul style="list-style-type: none"> Conventional An error/fault is displayed by the LED and the signaling contact opens. Aligned The signaling contact can be opened or closed as required regardless of a fault/error. 	Administrator only.																
sclose [yes no]	<p>Switches the signaling contact, if this in "aligned" mode:</p> <ul style="list-style-type: none"> Yes The contact is closed. No: The contact is opened 	Administrator only.																
setec <Event> <Index> <E D> <E D> <E D>	<p>Specifies how an IE switch reacts to system events. You can enter the following values for the <Event> parameter:</p> <table border="1"> <tr> <td>CW</td> <td>Cold/Warm Start</td> </tr> <tr> <td>LC</td> <td>Link Change</td> </tr> <tr> <td>AF</td> <td>Authentication Failure</td> </tr> <tr> <td>PM</td> <td>Power M12 Change</td> </tr> <tr> <td>FC</td> <td>Fault State Change</td> </tr> <tr> <td>RD</td> <td>Redundancy Event</td> </tr> <tr> <td>SB</td> <td>Standby Event</td> </tr> <tr> <td>LD</td> <td>Loop Detection</td> </tr> </table>	CW	Cold/Warm Start	LC	Link Change	AF	Authentication Failure	PM	Power M12 Change	FC	Fault State Change	RD	Redundancy Event	SB	Standby Event	LD	Loop Detection	Administrator only.
CW	Cold/Warm Start																	
LC	Link Change																	
AF	Authentication Failure																	
PM	Power M12 Change																	
FC	Fault State Change																	
RD	Redundancy Event																	
SB	Standby Event																	
LD	Loop Detection																	
	<p>If an event is specified, the configured actions are formed for each event. The three parameters <E> or <D> configure the reactions of the IE switch in the order:</p> <ul style="list-style-type: none"> E-mail Trap Entry in the log table <p>Example: If you only want to send an E-mail when there is a Link Change, enter the following command: setec LC E D D</p>																	

6.3.5.25 The "Agent E-Mail Config" WBM menu

Agent E-Mail Configuration - Network monitoring with E-mails

An IE Switch X-200 provides you with the option of automatically sending an E-mail (for example to a network administrator) if an alarm event occurs. The E-mail contains the identification of the sending device, a description of the cause of the alarm in plain language, and a time stamp with the time since the device started up. This allows centralized network monitoring to be set up for networks with few nodes based on an E-mail system. When an E-mail event message is received, the WBM can be started by the browser using the identification of the sender to read out further diagnostic information.

E-mails can only be sent when

- the E-mail function is activated on the IE Switch X-200 and the E-mail address of the recipient is configured.
- the E-mail function is enabled for the relevant event.
- there is an SMTP server in your network that can be reached by the IE Switch X-200.
- the IP address of the SMTP server is entered on the IE Switch X-200.

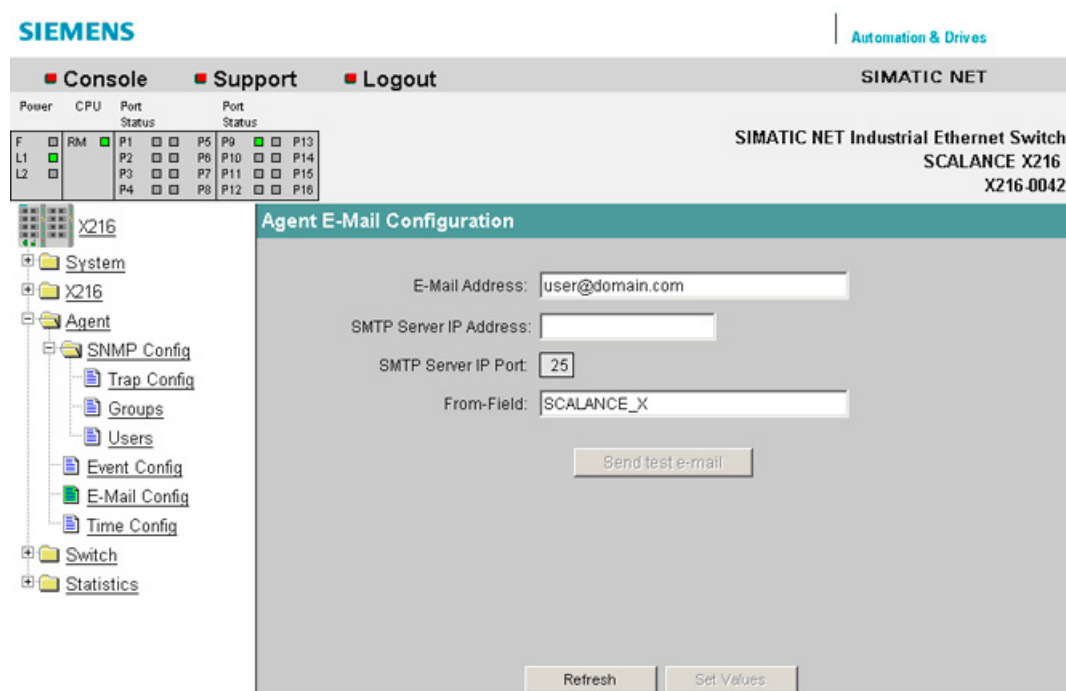

Figure 6-30 "E-Mail Configuration" dialog

E-Mail Address

Here, you enter the E-mail address to which the IE Switch X-200 sends an E-mail if a fault occurs.

SMTP Server IP Address

Here, you enter the IP address of the SMTP server over which the E-mail is sent.

SMTP Server IP Port

The IP port over which the mail is sent. If necessary, you can change the default value 25 to your own requirements in the CLI.

"From" Field

You can enter a text that appears in the "From" field of the E-mail.

Send Test E-Mail

Sends an E-mail with the selected parameters.

Syntax of the Command Line Interface

Table 6- 21 Agent E-Mail Configuration - CLIAGENT\EMAIL>

Command	Description	Comment
info	Shows the E-mail configuration.	
mail [E D]	Enables/disables the mailing function.	Administrator only.
smtp [IP address] [:port]	Specifies the IP address and the port number of the SMTP server.	Administrator only.
from [address]	Specifies a text that will be entered in the "From" field of the E-mail.	Administrator only.
email [E-mail address]	Specifies the address to which an IE switch sends an E-mail. This address can be up to a maximum of 50 characters long.	Administrator only.
testmail <test E-mail comment>	Sends an E-mail for testing.	Administrator only.

6.3.5.26 The "Agent Time Config" WBM menu

Agent Time Client Configuration

This dialog is used to configure the time protocols.

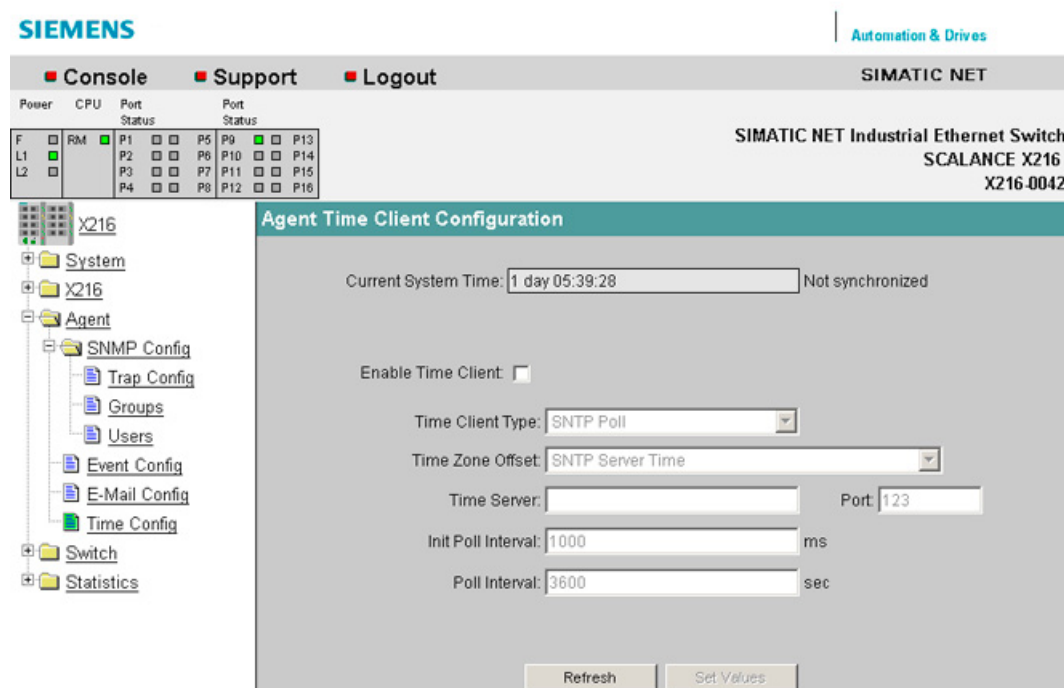

Figure 6-31 Agent Time Client Configuration dialog

Current system time

Either the time since the last restart or the current time is displayed here.

If the time is received from a "non-time server", the text "not synchronized" is displayed.

Enable time client

The time function can be enabled and disabled here.

Time client type

You can choose from four different protocol types here:

- SNTP Poll
 - If you choose this protocol type, you have to define further settings: Time zone offset, Time server, Init poll interval, Poll interval.
- SNTP Listen
 - In this mode, you can also select an offset to the time received from the server. Other settings are not possible.

6.3 Configuration using Web Based Management (WBM) and Command Line Interface (CLI)

- **SIMATIC time**
If you use the SIMATIC time transmitter, you do not need to make any further settings.
- **Manual**
Here, an input field opens for you to enter the current time. The time is quartz controlled and thus always exact. When you switch off or reset the device, this information is lost and must be entered again.

Time zone offset

You can enter a time zone correction for the SNTP protocols here.

Time server

Here, you can enter the Internet address of the server with which the system time will be synchronized. The number of the UDP port being used can also be entered. As default, the SNTP protocol uses UDP port 123.

Init poll interval

Here, you can enter the interval at which the IE Switch X200 repeats the initial poll for the system time if this was not successful the first time.

Poll interval

Once the system time has been adopted the first time from the time server, it is updated cyclically with renewed polls to the time server. Here, you specify how often the updates take place.

Syntax of the Command Line Interface

Table 6- 22 Agent Time Client Configuration - CLIAGENT\TIME>

Command	Description	Comment
info	Displays information on the time settings of the IE switch.	
timec [E D]	Enables / disables the time settings of the IE switch.	Administrator only.
server [IP address] [:port]	Sets the IP address and the port of the server.	Administrator only.
tzzone [-12..+12]	Sets the time difference in hours between the server and system time.	Administrator only.
tinitpoll [1000-100000ms]	Specifies the polling interval ...?	Administrator only.
tpoll [10-100000s]	Specifies the polling interval in the range from 10 - 100000 s.	Administrator only.
ttype [P L S M]	Specifies how the time is set: - P SNTP poll - L SNTP listen - S Siemens - M manual.	Administrator only.
settime [time]	Sets the time manually (DD MMM HH:MM:SS YYYY).	Administrator only.

6.3.5.27 The "Switch" WBM menu

Port Mirroring

Note**for all SCALANCE X-200 IRT**

Disable the function "Port Mirroring" if you want to operate the device in IRT mode. IRT mode is not possible when the mirroring function is enabled.

With this dialog, you can enable or disable port mirroring; in other words, mirroring the data traffic from the mirror port to the monitor port.

Apart from the device be monitored, no other communication node should be connected to the monitor port.

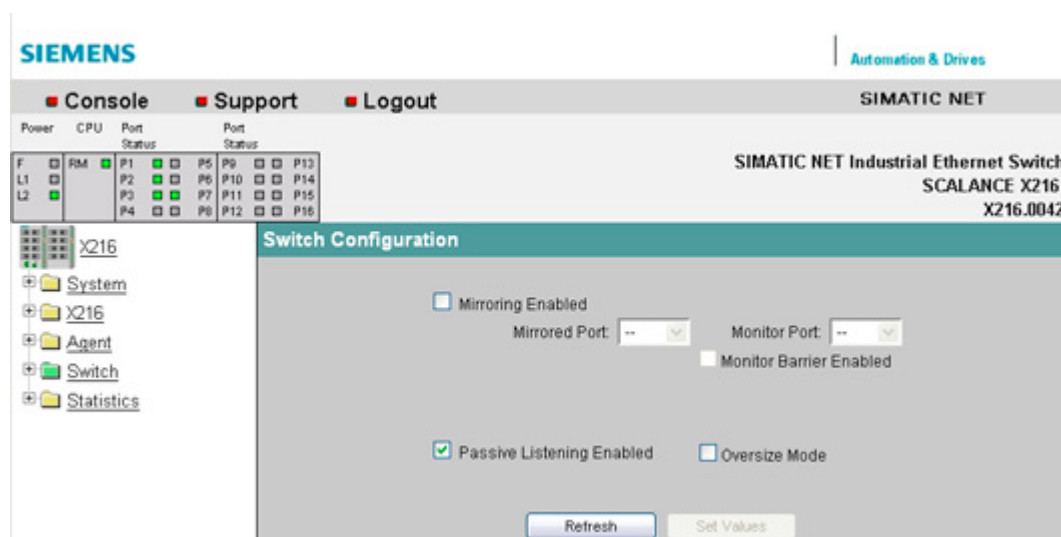

Figure 6-32 "Switch Configuration (Port Mirroring)" dialog

Mirroring Enabled

Clicking this check box enables or disables the mirroring function.

Mirrored Port

Under mirrored port, enter the port to be monitored.

Monitor Port

Under monitor port, enter the port to be monitored.

Monitor Barrier Enabled (not relevant for X-200IRT IE switches)

With this check box, you can restrict communication via the mirror port. If the check box is selected, the mirror port is taken out of normal frame switching. Otherwise communication via the mirror port is unrestricted.

6.3 Configuration using Web Based Management (WBM) and Command Line Interface (CLI)

Passive Listening Enabled (not relevant for X-200IRT IE switches)

With this check box, you enable/disable the "Passive Listening" function. If the "Passive Listening" function is enabled, the X-200IRT switch forwards received RSTP-BPDUs. If "Passive Listening" is disabled, all received RSTP frames are discarded.

Note

Passive listening can only be enabled when RSTP is enabled.

Oversize Mode

If you select this check box, frames with a size up to 1,632 bytes instead of 1,528 bytes are permitted.

Aging (relevant only for X-200IRT IE switches)

Here, you can disable the aging function by clicking on the check box. The aging time can be set in seconds.

Note

If the aging function is disabled, communication problems will occur when connected nodes are plugged into different ports. In normal mode, the aging function should therefore remain enabled.

NOTICE
<p>Note the following for all X-200IRT IE switches:</p> <p>With the "Port Mirroring" function and cyclic PROFINET data traffic, the mirror port (monitor port) only shows the frames received at the monitored port (mirrored port). Non-cyclic frames mean that PROFINET communication is not involved and, in this case therefore, both sent and received packets are shown at the mirror port (monitor port).</p>

Syntax of the Command Line Interface

Table 6- 23 Switch Configuration (Ports Mirroring) - CLISWITCH>

Command	Description	Comment
info	Displays information on the IE switch configuration.	
mirrored [port]	Specifies the port for mirroring.	Administrator only.
monitor [Port]	Specifies the port for the protocol monitor.	Administrator only.
mirroring [E D]	Enables / disables mirroring.	Administrator only.
plisten [E D]	Enables/disables passive listening	Administrator only.
oversize [E D]	Enables/disables the oversize mode function	Administrator only.

6.3.5.28 The "Switch Ports" WBM menu

Switch Ports

This dialog informs you about the current status of the ports. You can also make various port settings.

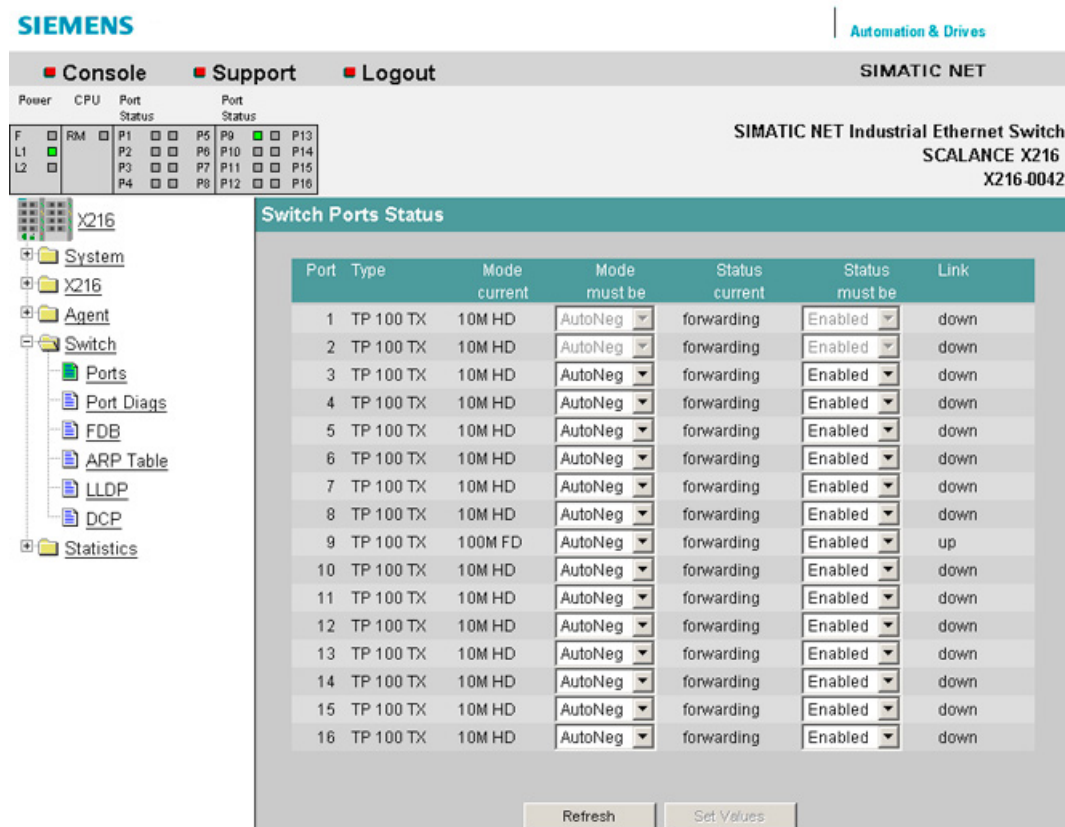

Figure 6-33 "Switch Ports" screen

Port

Shows the port number.

Type

Displays the type of port.

The following port types are available with the IE Switch X-200 modules:

TP 10 TX

TP 100 TX

FO 100 FX

Mode

Shows transmission rate (10 or 100 Mbps) and the transmission mode (full duplex (FD) or half duplex (HD)).

Negotiation

Indicates whether autonegotiation is enabled or disabled.

Status

Indicates that the port is enabled.

Link

Status of the link to the network. The following alternatives are possible:

- up
The port has a valid link to the network, a link integrity signal is being received.
- down
The link is down, for example because the connected device is turned off.

NOTICE

With IE Switches X-200, that are not IRT-compliant, it is not possible to disable ports in PROFINET mode!

If a port of such a device is disabled by Web Based Management, the disabled setting is overwritten when a PROFINET configuration is downloaded. In PROFINET mode, all ports of a non IRT-compliant IE Switch X-200 are automatically enabled.

Note

If an IE switch port operating in autonegotiation mode is connected to a partner device that is not operating in autonegotiation mode, the partner device must be set permanently to half duplex mode.

If an IE switch port is set permanently to full duplex, the connected partner device must also be set to full duplex.

If the autonegotiation function is disabled, the MDI/MDI-X autocrossover function is also inactive. This means it may be necessary to use a crossover cable.

Syntax of the Command Line Interface

Table 6- 24 Switch Port Status - CLI\SWITCH>

Command	Description	Comment
ports	Displays the port status.	Administrator only.

Table 6- 25 Switch Ports Status - CLI\SWITCH\SETPORT>

Command	Description	Comment
info	Displays the current port settings.	
enable <port> [D E]	Enables / disables the specified port.	Administrator only.

6.3 Configuration using Web Based Management (WBM) and Command Line Interface (CLI)

Command	Description	Comment
speed <port> [10 100 A]	<p>Specifies the port speed:</p> <ul style="list-style-type: none"> • 10 - 10 Mbps • 100 - 100 Mbps • A - Autonegotiation. <p>If autonegotiation is set, the setting applies for speed and duplicity.</p>	Administrator only.
duplex <port> [H F A]	<p>Specifies the port duplexity:</p> <ul style="list-style-type: none"> • H - half • F - full • A - autonegotiation <p>If autonegotiation is set, the setting applies for speed and duplicity.</p>	Administrator only.

6.3.5.29 The "Switch Port Diags" WBM menu

Switch Port Diagnostics

With this dialog, each individual Ethernet port can run independent fault diagnostics on the cable. This allows short-circuits and cable breaks to be localized.

NOTICE

Please note that this test is permitted only when no data connection is established on the port to be tested.

This test is not possible for IRT devices.

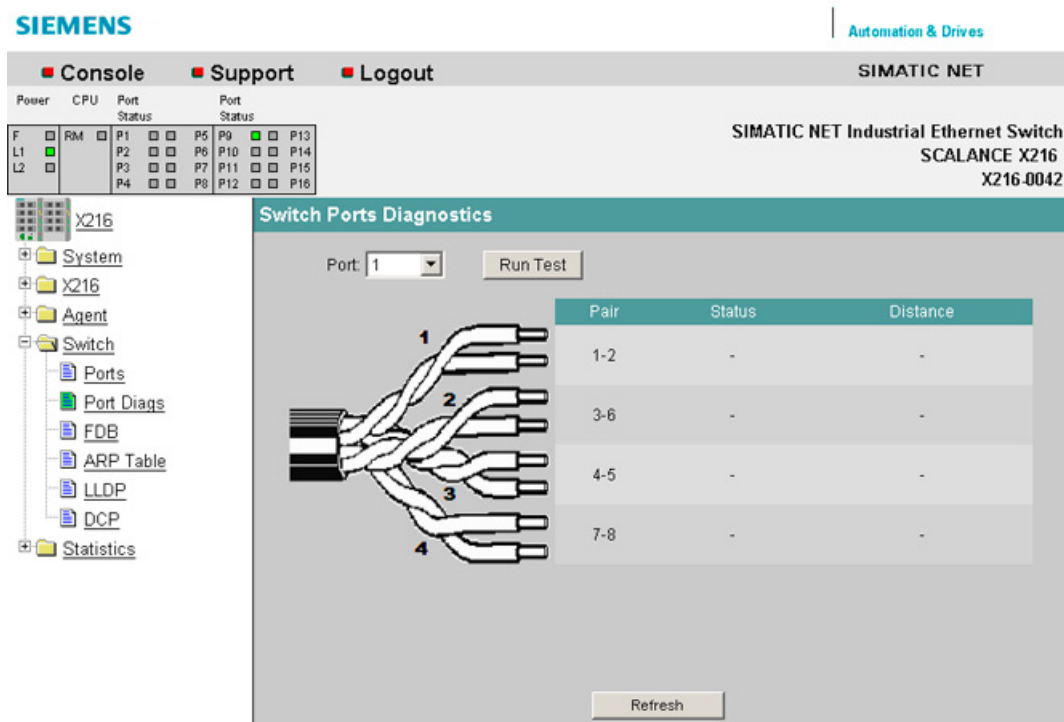

Figure 6-34 "Switch Ports Diagnostics" dialog

Port

The port to be tested is specified here.

Run Test

This button activates the test.

Pair

Displays the pair of wires in the cable.

Pairs 4-5 and 7-8 are not used.

Status

Displays the status of the cable.

Distance

Displays the distance to the cable end, cable break, or short-circuit.

Syntax of the Command Line Interface

Table 6- 26 Switch Port Diagnostics - CLISWITCH>

Command	Description	Comment
test <n>	Starts the "Switch Port Diagnostics" function for an individual port.	

6.3.5.30 The "Switch FDB" WBM menu

Switch Forwarding Database

The forwarding database displays which MAC addresses are currently reachable in the network via which port.

The FDB is refreshed each time the aging time elapses.

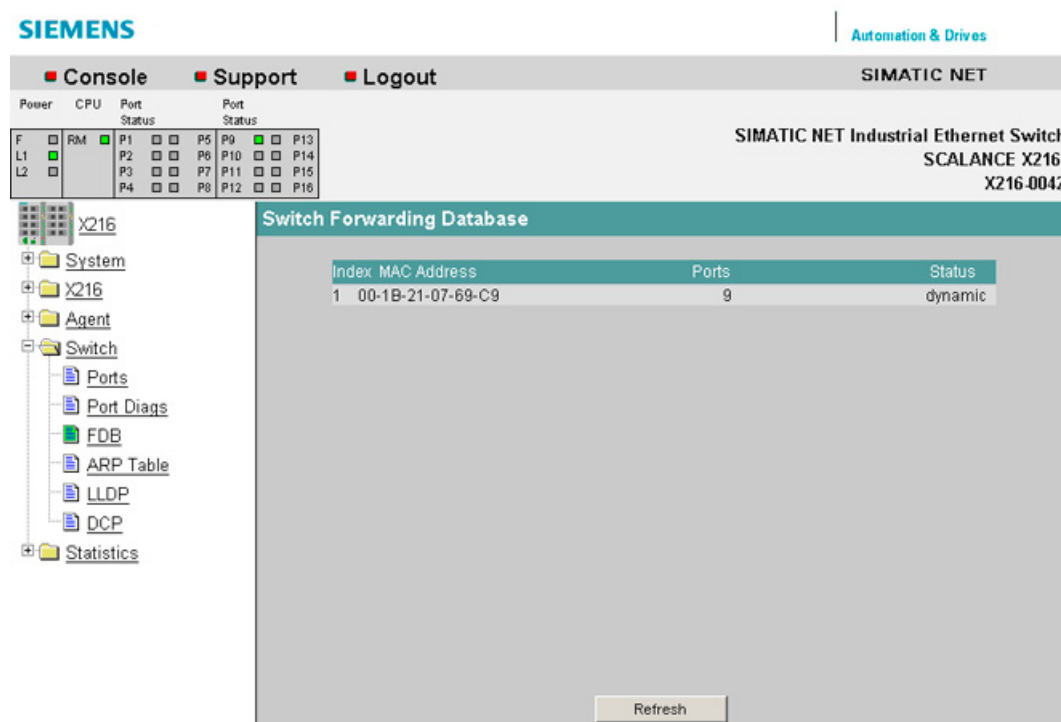

Figure 6-35 Switch Forwarding Database dialog

Syntax of the Command Line Interface

Table 6- 27 Switch Forwarding Database - CLI\SWITCH\SETPORT>

Command	Description	Comment
fdb [clear MAC addr][ports]	<p>Displays the FDB, deletes dynamic entries from the FDB or inserts an additional static entry in the FDB.</p> <p>If a static multicast address is entered, you can specify several ports separated by commas.</p> <p>If you want to remove a static entry from the FDB, the "fdb" command must be called without specifying ports.</p> <p>Port index 0 stands for the internal interface of the IE Switch X-200. This is indicated in the fdb by "C".</p> <p>Example: The command "fdb 01-08-00-99-99-99 1,2,3" enters the MAC address 01-08-00-99-99-99 for ports 1-3 in the FDB.</p>	Administrator only.

Note

With SCALANCE X-200, the MAC address table is deleted within 1s.

Note

Only dynamically learned Ethernet addresses are shown in Web Based Management. With the CLI, statically entered Ethernet addresses can also be shown.

Note

SCALANCE X-200IRT IE switches can learn up to 4000 Ethernet addresses, the other SCALANCE X-200 IE switches up to 8000 Ethernet addresses. The entry of a learned Ethernet address in the address table is made by the storage system which may reduce the actual number of addresses that can be learned.

6.3.5.31 The "Switch ARP Table" WBM menu

Switch ARP (Address Resolution Protocol)Table

This dialog shows which MAC address is assigned to which IP address.

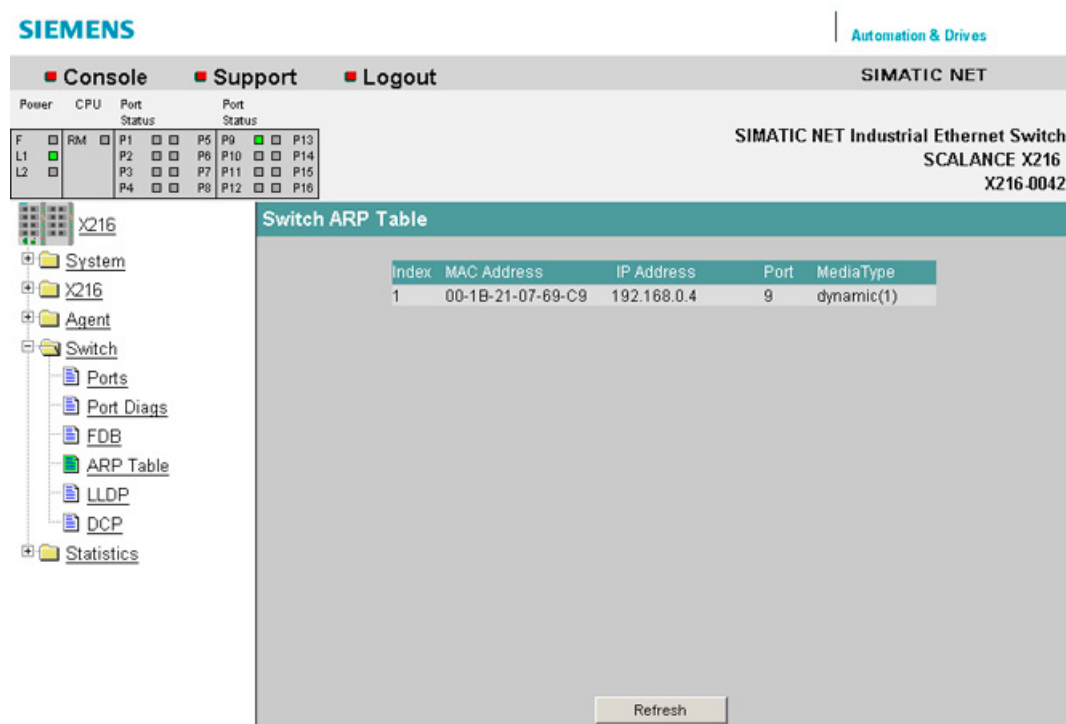

Figure 6-36 Switch ARP Table

Syntax of the Command Line Interface

Table 6- 28 Switch ARP Table - CLI\SWITCH>

Command	Description	Comment
arp	Displays the ARP table.	

6.3.5.32 The "Switch LLDP" WBM menu

Configuring frames of the Link Layer Discovery Protocol

This dialog allows you to configure the handling of frames of the Link Layer Discovery Protocol (LLDP) per port.

6.3 Configuration using Web Based Management (WBM) and Command Line Interface (CLI)

The LLDP protocol is used to exchange information between neighboring devices. An IE Switch X-200 sends LLDP frames to all ports at regular intervals. The LLDP frames received from neighboring devices are not forwarded; only the information they contain about neighboring devices is stored. This information can be read from a central location and used to identify the network topology.

To structure a network logically, the sending and receipt of LLDP frames can be configured per port.

Note

The LLDP protocol can be disabled in STEP 7 using the "End of topology discovery" function.

Note

With the SCALANCE X202-2IRT and X204IRT with a product version lower than or equal to 003, the following port-specific sender addresses are used for LLDP frames:

- Port 1: 08:00:06:9D:38:40
- Port 2: 08:00:06:9D:38:41
- Port 3: 08:00:06:9D:38:42
- Port 4: 08:00:06:9D:38:43



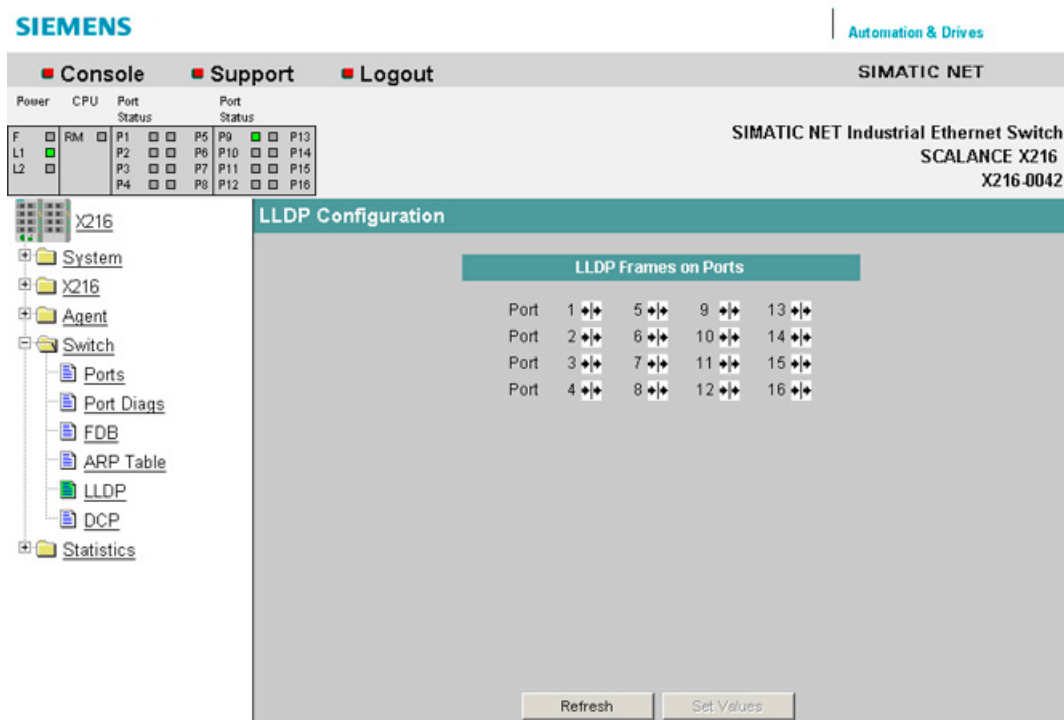

With all other X-200 IE switches, MAC addresses are used as the sender address for LLDP frames that are both device and port-specific.

The MAC address for a specific port is formed by adding the index of this port to the MAC address of the IE Switch X-200.

6.3 Configuration using Web Based Management (WBM) and Command Line Interface (CLI)



The following settings can be made for the displayed ports:

Symbol	Meaning
	Port sends and receives LLDP frames.
	LLDP frames are neither sent nor received. (not with X-200IRT IE switches)
	LLDP frames are sent but not received.
	LLDP frames are received but not sent. (not with X-200IRT IE switches)

Syntax of the Command Line Interface

Table 6- 29 Switch LLDP - CLI\SWITCH\LLDP>

Command	Description	Comment
info	Displays the current LLDP settings.	
lldpport [ports] <mode>	Changes the LLDP settings for one or more ports. The <mode> parameter can have the following values: <ul style="list-style-type: none">• RX - receive only• TX - send only• TX RX - send and receive• D - disables sending and receiving. Example: The command "lldpport 1,2,3 rx" specifies that LLDP frames are only received on ports 1-3.	Administrator only.

Note

With X-200IRT IE switches, only the following settings are possible:

- Port sends and receives LLDP frames.
 - LLDP frames are sent but not received.
-

6.3.5.33 The "Switch DCP" WBM menu

Configuring Discovery and basic Configuration Protocol frames

This dialog allows you to configure the handling of frames of the Discovery and basic Configuration Protocol (DCP) per port.

The DCP protocol is used to detect nodes in a network and to assign basic parameters such as the IP address, system name etc. to them.

To allow the logical structuring of networks, the sending of DCP frames can be enabled or disabled port-oriented on an IE Switch X-200.

Note



The sending of DCP frames can be disabled in STEP 7 using the "End of detection of accessible nodes" function.

Note

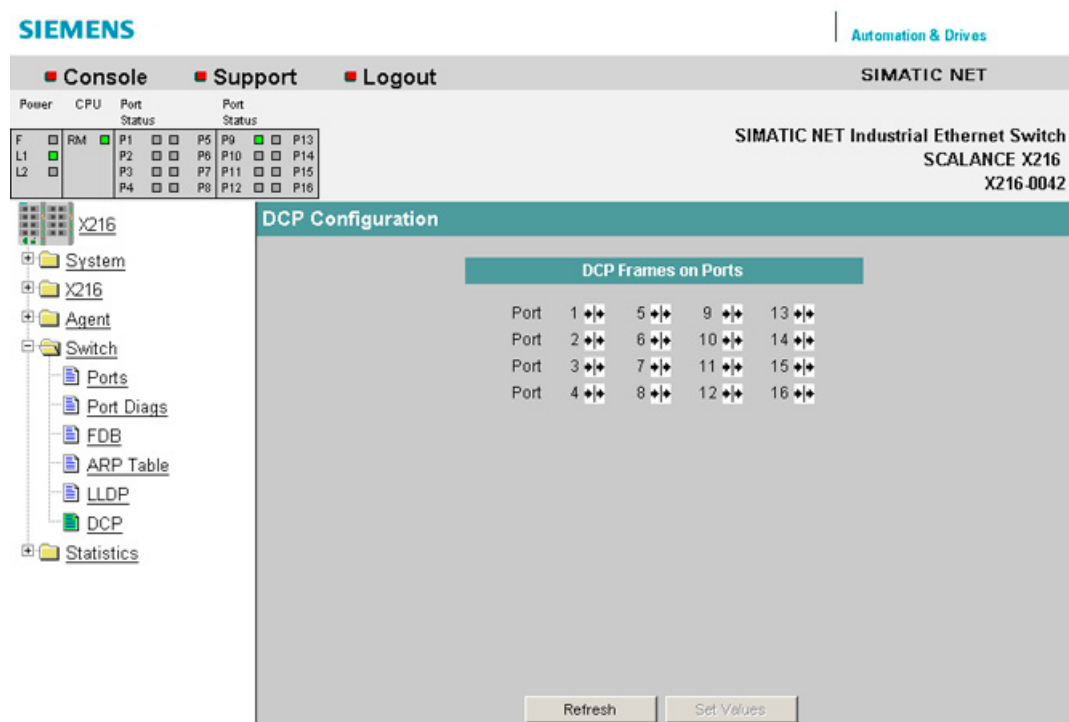
If DCP is turned off, it may not be possible to configure all switches with the PST tool.



The following settings can be made for the displayed ports:

Symbol	Meaning
	Port sends and receives DCP frames
	DCP frames are received but not sent

Syntax of the Command Line Interface

Table 6- 30 Switch DCP - CLI\SWITCH\DCP>

Command	Description	Comment
info	Displays the current DCP settings.	
dcpport [ports] <enabled disabled>	Enables or disables the sending of DCP frames on one or more ports. Example: The command "dcpport 1,2,3 rx" specifies that DCP frames are only received on ports 1-3.	Administrator only.

6.3.5.34 The "Switch POF" WBM menu

Plastic Optical Fiber Management

This screen displays the diagnostic data for interfaces with plastic FO cables.

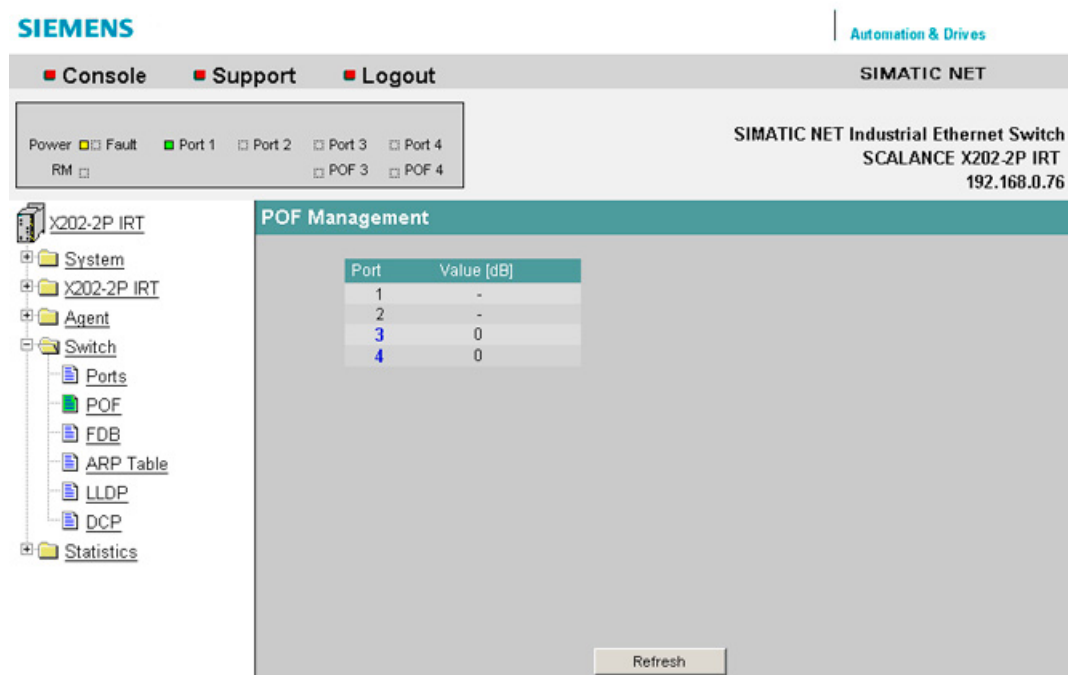

Figure 6-37 POF Management

Here, you can see the currently available link power margin as a numerical value for each POF port.

6.3 Configuration using Web Based Management (WBM) and Command Line Interface (CLI)

The link power margin indicates the attenuation on the connection between sender and receiver that can be overcome. The higher the link power margin, the higher the attenuation can be while maintaining a functioning link. If the link power margin sinks, the attenuation has increased, for example due to aging or a defect. The longer the cable being used, the lower the link power margin available.

The fiber-optic diagnostics screen appears if you click on one of the displayed ports. It displays information on the available link power margin over time.

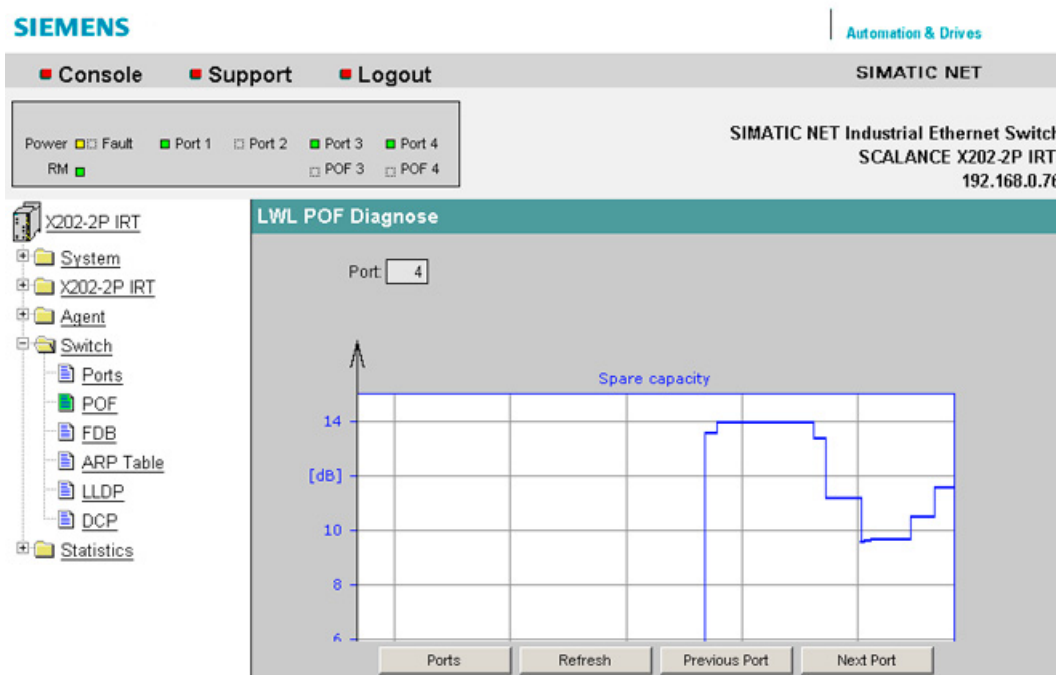

Figure 6-38 POF fiber-optic diagnostics

The vertical axis shows the available link power margin in dB.

The horizontal axis shows the time since the IE Switch X-200 started up.

The time from the startup of the IE Switch X-200 is displayed relative to the current time and current date. Date and time information are adopted from the PC on which the Web browser in use is running.

The diagram itself is divided into two areas:

White:

There is an adequate link power margin for problem-free operation. When the IE Switch X-200 is installed, the link power margin should be in this range.

Yellow:

If the link power margin enters this range, maintenance is necessary. The boundary of the yellow area is at a link power margin of 2 dB. To ensure long-term functionality of the system, the maintenance should be performed. If the link power margin is in the yellow range, this is signaled by the FO LED lighting up.

NOTICE
The page for diagnostics of fiber-optic cable only shows correct link power margins when plastic optical fiber (POF) is used. If polymer cladded fiber (PCF) is used, diagnostics is not possible.

6.3.5.35 The "Loop Detection Config" WBM menu

Loop Detection Configuration

On this page, you specify for the ports for which loop detection will be activated. These ports send test frames. If these frames are sent back to the device, there is a Loop.

Note

Note that the functions of the "Loop Detection Configuration" WBM menu are not available for X200IRT.

If the frames are received again at another port of the same device, there is a "Local Loop" involving this device.

If the sent frames are received again at the same port, there is a "Remote Loop" involving other network components.

Note

Note that loop detection is only possible at ports that were not configured as ring ports.

6.3 Configuration using Web Based Management (WBM) and Command Line Interface (CLI)

Loop Detection Configuration

Loop Detection Control

Loop Detection Enabled:

Rx Threshold (All Ports):

Remote Loop Reaction (All Ports):

Local Loop Reaction (All Ports):

Loop Detection Port Control

Port	Setting	Rx Threshold	Remote Loop Reaction	Local Loop Reaction	State	Source Port	Action
1	Forwarder	2	Disable	Disable	deactivated	-	Reset
2	Forwarder	2	Disable	Disable	deactivated	-	Reset
3	Sender	2	Disable	Disable	active	-	Reset
4	Sender	2	Disable	Disable	local loop	5	Reset
5	Sender	2	No Action	Disable	remote loop	5	Reset
6	Forwarder	2	Disable	Disable	deactivated	-	Reset
7	Forwarder	2	Disable	Disable	deactivated	-	Reset
8	Forwarder	2	Disable	Disable	deactivated	-	Reset
9	Forwarder	2	Disable	Disable	deactivated	-	Reset
10	Forwarder	2	Disable	Disable	deactivated	-	Reset
11	Forwarder	2	Disable	Disable	deactivated	-	Reset
12	Forwarder	2	Disable	Disable	deactivated	-	Reset
13	Forwarder	2	Disable	Disable	deactivated	-	Reset
14	Blocked	2	Disable	Disable	deactivated	-	Reset

Loop Detection Control

The following settings are available:

- "Loop Detection enabled" check box
Here you can enable loop detection for this switch. If loop detection is disabled, loop detection frames of other devices are forwarded.
- "Rx-Threshold (All Ports)" input box
Here, you can enter the number of received frames after which a loop is assumed. If a port-specific setting was made "Variant" is displayed.
- "Remote Loop Reaction (All Ports)" drop-down list
Here you can specify for all ports whether a port is activated or deactivated if a remote loop is detected. If a port-specific setting was made "Variant" is displayed.
- "Local Loop Reaction (All Ports)" drop-down list
Here you can specify for all ports whether a port is activated or deactivated if a local loop is detected. If a port-specific setting was made "Variant" is displayed.

Loop Detection Port Control

Meaning of the column entries:

- "Port" display box
The relevant port is listed here.
- "Setting" drop-down list
In this area, you define the behavior of the port. You can choose from the following options:
 - "Sender"
If this option is set, loop detection frames are sent and forwarded.
 - "Forwarder"
If this option is set, loop detection frames of other devices are forwarded.
 - "Blocked"
If you select this option, the forwarding of loop detection frames is blocked.
- "Rx-Threshold" input box
Here, you can specify the number of received frames after which a loop is assumed.
- "Remote Loop Reaction" drop-down list
Here, you can activate or deactivate a port if a remote loop is detected.
- "Local Loop Reaction" drop-down list
Here, you can activate or deactivate a port if a local loop is detected.
- "State" display box
Shows the status of the loop detection for the corresponding port.

6.3 Configuration using Web Based Management (WBM) and Command Line Interface (CLI)

- "Source Port" display box
Shows the port that received the frame that triggered the last reaction.
- "Action" button
After the loop in the network has been eliminated, you can use this button to reset the port again.

NOTICE
A loop is an error in the network structure that needs to be eliminated. The loop detection can help to find the errors more quickly but does not eliminate them. The loop detection is not suitable for increasing network availability by deliberately including loops.

NOTICE
Loops can only be detected between devices that forward loop detection frames. Loops via network components whose ports are set to "blocked" are not detected.

Note

Test frames create additional network load. We recommend that you only configure individual switches, for example at branch points of the ring, as "senders" and the others as "forwarders".

Syntax of the Command Line Interface

Table 6- 31 Loop Detection Configuration - CLI\SWITCH\LOOPD >

Command	Description	Comment
info	Displays information about the "Loop Detection Configuration".	
loopd [E D]	Enables / disables loop detection.	Administrator only.
loopdp <port> [B F S]	Defines the behavior of a port for loop detection: <ul style="list-style-type: none"> • "Blocked" • "Forwarder" • "Sender" 	Administrator only.
rxthres <port> <count>	Specifies the Rx.Threshold.	Administrator only.
local <port> [N D]	Specifies the reaction to a local loop.	Administrator only.
remote <port> [N D]	Specifies the reaction to a remote loop.	Administrator only.
reset <port>	Reactivates the port if it was deactivated due to a detected loop.	Administrator only.

6.3.5.36 The "Statistics" WBM menu

Statistics - counting and evaluation of received and sent frames

An IE Switch X-200 has internal statistics counters (RMON (Remote Monitoring) counters) with which it counts the number of received frames according to the following criteria:

- Frame length
- Frame type
- Bad frames

This information provides you with an overview of the data traffic and any problems on the network.

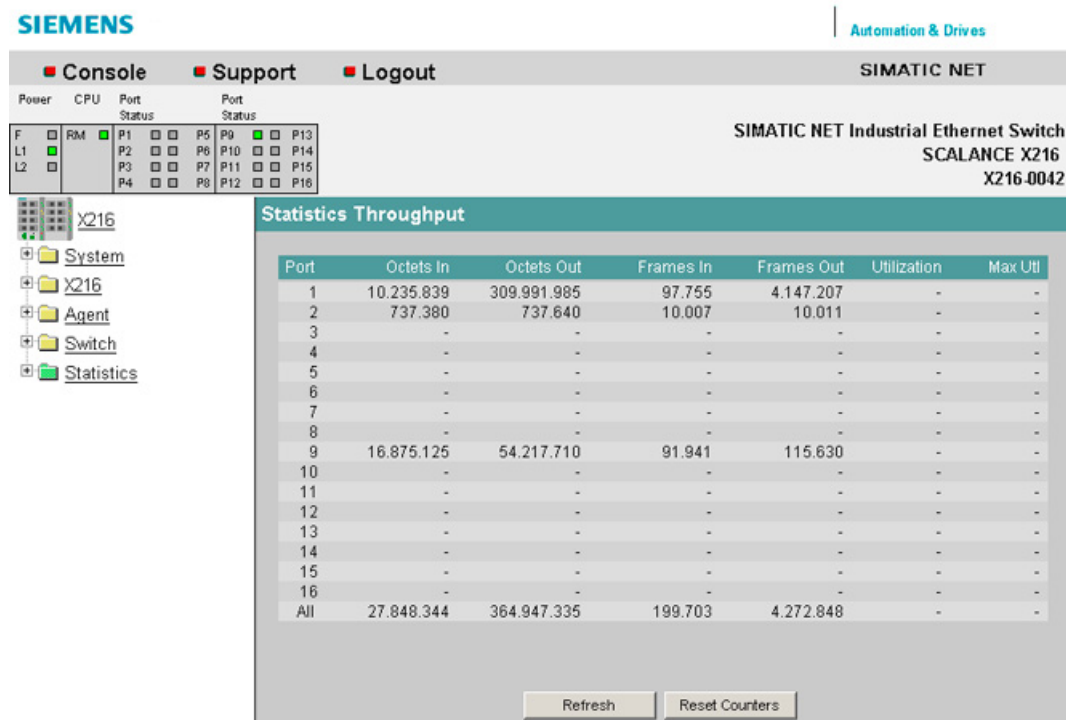

Figure 6-39 "Statistics Throughput" dialog

Octets In

Displays the number of received bytes.

Octets Out

Displays the number of sent bytes.

Frames In

Displays the number of received frames.

Frames Out

Displays the number of sent frames.

Utilization

Displays the port utilization as a percentage (%). If the bus utilization is less than 1%, nothing is displayed. Depending on the frame length (system dependent), the display can deviate by up to 20% since the proportion of pauses between frames increases the shorter the frame.

Max. Utilization

Displays the peak value of port utilization as a percentage (%).

Note

The Utilization value is calculated from the incoming frames. Here, both correct and bad frames are relevant. Outgoing frames are not taken into account in the calculation of this value.

Syntax of the Command Line Interface

Table 6- 32 Statistic - CLI\STAT>

Command	Description	Comment
info	Shows statistical information on sent and received frames.	
types	Displays information on the type of the sent and received frames.	
sizes	Displays information on the length of the sent and received frames.	
errors	Displays information on bad sent and received frames.	

6.3.5.37 The "Statistics Packet Size" WBM menu

Packet Size Statistics - received packets sorted according to length

The Packet Size Statistics page displays how many packets of which size were received at each port.

If you click the Reset Counters button, you reset the counters for all ports.

If you click on an entry in the Port column, the Packet Size Statistics graphic is displayed for the selected port. You then see a graphical representation of the counter value.

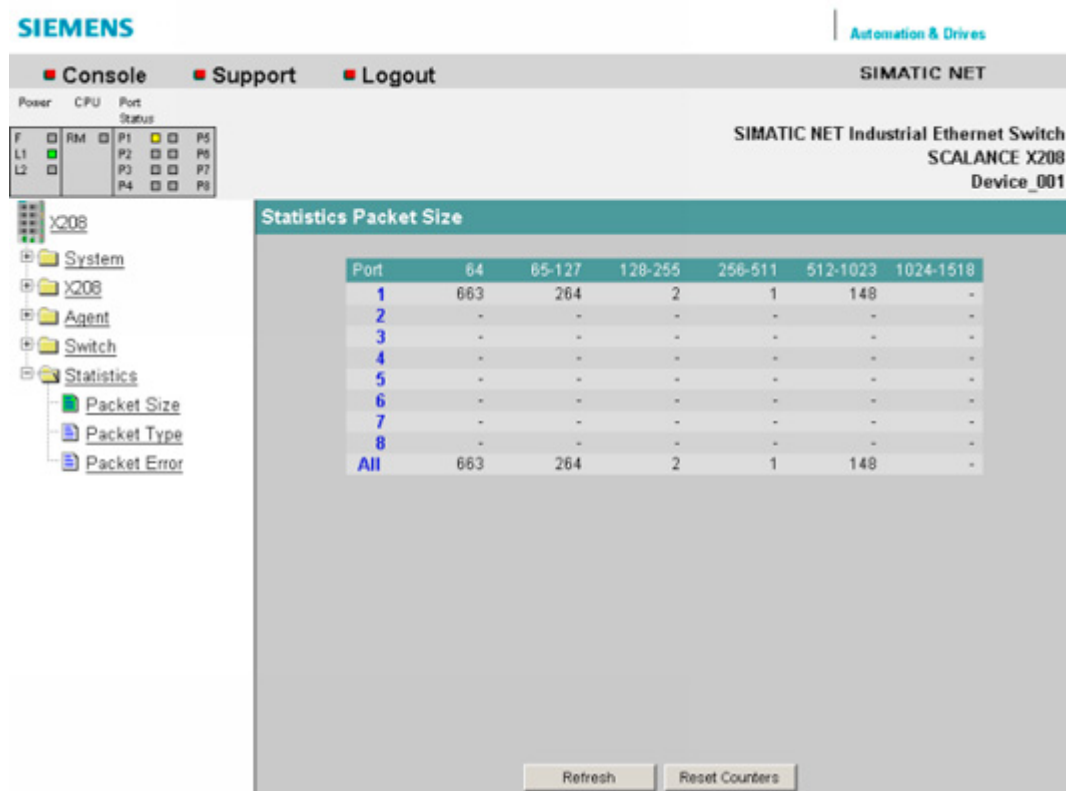

Figure 6-40 "Statistics Packet Size" dialog

64

Displays the number of packets with a length of 64 bytes.

65-127

Displays the number of packets with a length of 65-127 bytes.

128-255

Displays the number of packets with a length of 128-255 bytes.

256-511

Displays the number of packets with a length of 256-511 bytes.

512-1023

Displays the number of packets with a length of 512-1023 bytes.

1024-1518

Displays the number of packets with a length of 1024-1518 bytes.

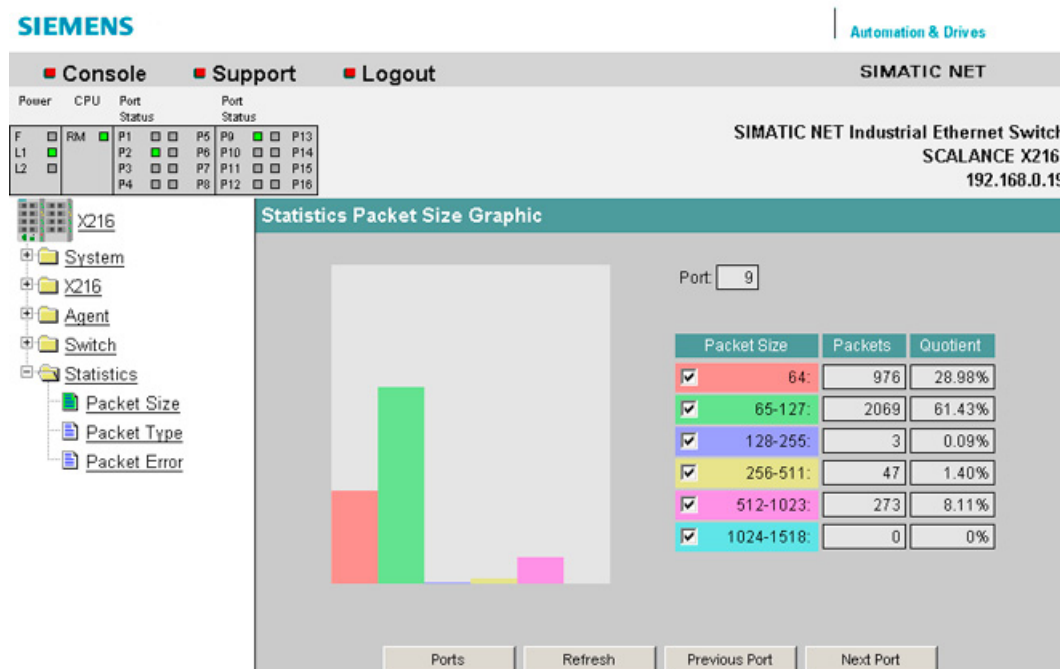

Figure 6-41 "Statistics Packet Size Graphic" dialog (graphic view)

Syntax of the Command Line Interface

Table 6- 33 Statistic Packet Size - CLI\INFORM>

Command	Description	Comment
sizes	Shows statistical information broken down according to frame length.	

6.3.5.38 The "Statistics Packet Type" WBM menu

Packet Type Statistics - received packets sorted according to type

The Statistics Packet Type page displays how many frames of the type unicast, multicast, and broadcast were received at each port.

If you click the Reset Counters button, you reset the counters for all ports.

If you click on an entry in the Port column, the Statistics Packet Type Graphic is displayed for the selected port. You then see a graphical representation of the counter value.

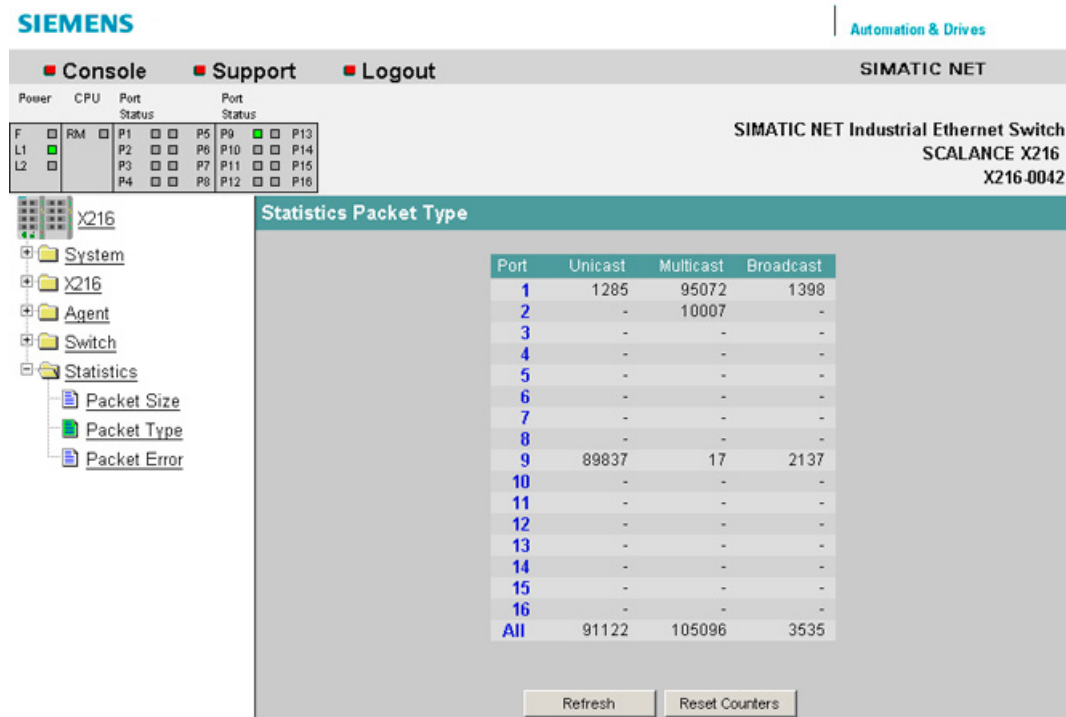

Figure 6-42 "Statistics Packet Type" dialog

Unicast

Displays the number of packets to the unicast recipient address.

Multicast

Displays the number of packets to the multicast recipient address.

Broadcast

Displays the number of packets to the broadcast recipient address.

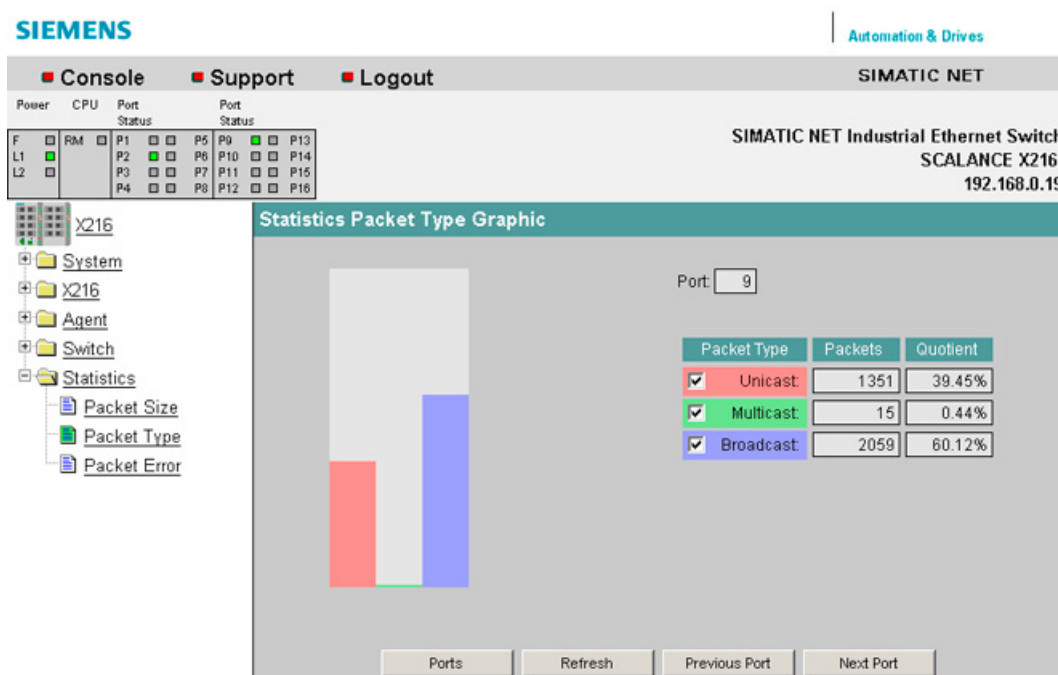

Figure 6-43 "Statistics Packet Type Graphic" dialog (graphic view)

Syntax of the Command Line Interface

Table 6- 34 Statistic Packet Type - CLIFORM>

Command	Description	Comment
types	Shows statistical information broken down according to frame type.	

6.3.5.39 The "Statistics Packet Error" WBM menu

Statistics Packet Error - Counting and evaluation of transmission errors

This dialog displays information on any errors that may have occurred and allows diagnostics for the port on which the error occurred. You can reset the error counters with the "Reset Counters" button.

If you click on an entry in the Port column, the Statistics Packet Error Graphic is displayed for the selected port. You then see a graphical representation of the counter value.

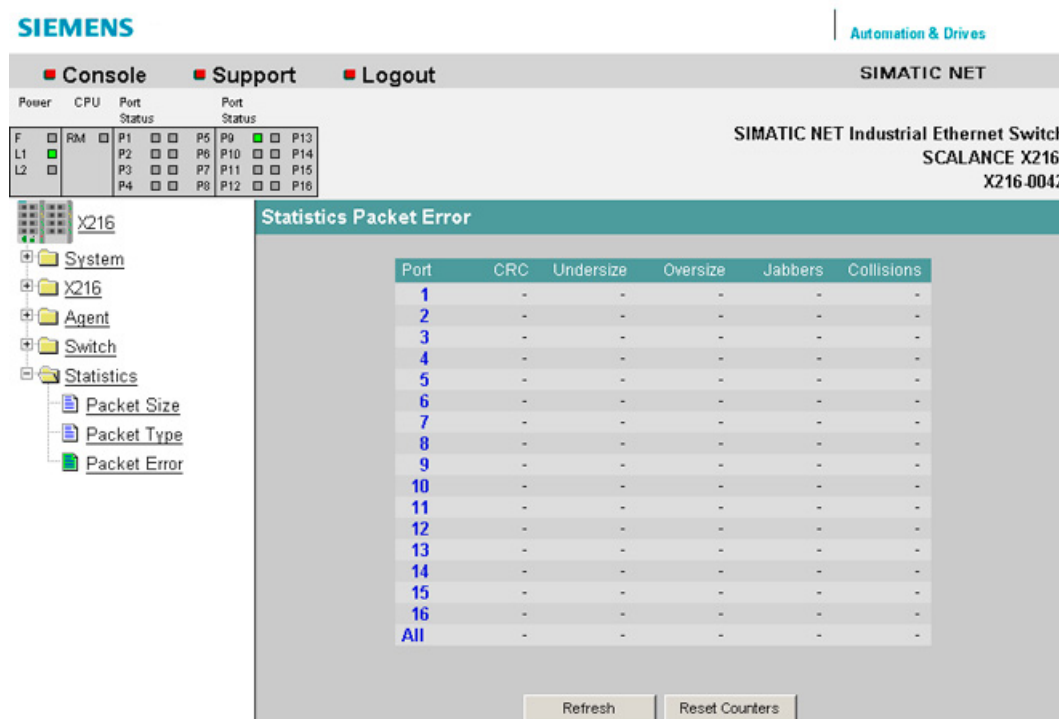

Figure 6-44 "Statistics Packet Error" dialog

The following errors can be detected:

CRC

Packets with a valid length but bad checksum.

Undersize

Packets too short with valid checksum.

Oversize

Packets too long with valid checksum.

Jabbers

Packets too long without valid checksum.

Collisions

Indicates the number of collisions that have occurred.

Note

X-200IRT IE switches work in the cut-through mode.

If a frame is received with a bad checksum, the forwarding of the frame is aborted prematurely and the frame is therefore shortened. The counter for CRC errors is incremented.

If the frame involved is a frame with a length of 64 bytes, the counter for undersize errors is also incremented due to the shortening of the frame

Syntax of the Command Line Interface

Table 6- 35 Statistic Packet Error - CLINFORM>

Command	Description	Comment
errors	Displays statistical information on received errors.	

6.3.6 SNMP

6.3.6.1 Configuration and diagnostics over SNMP

Configuration of an IE Switch X-200 over SNMP

A network management station can configure and monitor a SCALANCE X-200 using SNMP (Simple Network Management Protocol). To allow this, a management agent is installed in the IE Switch X-200 with which the management station exchanges data using Get and Set requests. X-200 IE switches support SNMP V1, V2, and V3.

The configurable data is in a database on the IE Switch X-200 known as the MIB (Management Information Base). The management station or Web Based Management can access this MIB.

SIMATIC NET SNMP OPC Server

The use of the SNMP OPC Server Windows application allows access to device information over the OPC interface. This allows network visualization, system diagnostics, and plant status monitoring to be implemented on any OPC client systems. OPC client systems include, for example, OPC Scout, SIMATIC HMI/SCADA, Office applications. This allows, for example, not only simple device diagnostics but also detailed information such as redundant network structures or network load distribution to be visualized. This increases operational safety and improves plant availability. The SNMP OPC Server has the following properties:

- Full integration in the SIMATIC NET OPC server environment.
- Parallel use of SNMP with other communication protocols such as PROFINET or S7 communication.
- Integrated MIB compiler for creating device profiles. The SNMP OPC MIB compiler can only compile SNMP V1 objects.
- Configuration and project engineering in STEP 7/NCM as of version V5.2

Supported MIBs

A distinction is made between standardized MIBs defined in RFCs and private MIBs. Private MIBs contain product-specific expansions that are not included in standard MIBs.

An IE Switch X-200 supports the following MIBs

- RFC1213: MIB II (all groups except for egp, transmission, at)
- Bridge MIB
- Private MIB

Access to the private MIB of an IE Switch X-200

You can save the private MIB of the IE Switch X-200 in WBM menu "System Save & Load HTTP" with the "Save Private MIB" button.

6.3 Configuration using Web Based Management (WBM) and Command Line Interface (CLI)

As an alternative, you can also display the private MIB directly in the Web browser. Follow the steps below to display the private MIB:

Start an Internet browser (for example Internet Explorer) and enter the following URL. When entering the URL, keep to the upper/lower case notation in the file name.

http://<IP address of the SCALANCE X200>/snScalanceX200.mib

If you have not yet logged on, a login window appears.

Once you are logged on, you have access to the private MIB file of the device.

In the Internet Explorer, select the *View -> Source* menu. With other browsers, select a comparable menu to display the source code.

If you use the Internet Explorer with the default settings, the private MIB file is opened in a Notepad editor and can be saved as a text file. The private MIB file also contains a description of the individual objects.

6.3.6.2 MIB variables

MIB variables of an IE Switch X-200

Key variables in the MIB-II standard

The following section lists certain SNMP variables from MIB II for monitoring the device status. MIB II describes all the SNMP variables that are usually supported by all SNMP-compliant devices.

Table 6- 36 Variables in the System directory

Variable	Access rights	Description
sysDescr	Read only	A string with up to 255 characters is used. This value contains the manufacturer's device ID.
sysObjectID	Read only	The address (object identifier) used to access device-specific SNMP variables is output here: 1.3.6.1.4.1.4196.1.1.5.2.nnn.mmm
sysUpTime	Read only	Time since the last reset (for example, after power up). The value is shown in hundredths of a second.
sysContact	Read and write	A contact person can be entered here. (Default: empty string). Possible value: string with a maximum of 255 characters.
sysName	Read and write	A name for the device can be entered here. (Default: empty string). Possible value: string with a maximum of 255 characters
sysLocation	Read and write	The device location can be entered here (default: empty string). Possible value: string with a maximum of 255 characters.
sysService	Read only	Shows the functions (services) provided by the component according to the ISO/OSI model. Layer functionality: 1. Physical (e.g. repeaters) 2. datalink/subnetwork (e.g. bridges , switches) 3. Internet (e.g. IP gateways, routers) 4. End to end (e.g. IP hosts) 7. Applications (e.g. E-Mail servers) Data type: 32-bit integer

6.3 Configuration using Web Based Management (WBM) and Command Line Interface (CLI)

Table 6- 37 Variables in the Interface directory

Variable	Access rights	Description
ifNumber	Read only	The number of different interfaces available in the component. Possible values: 4 - 8
ifDescr	Read only	A description and possibly additional information for a port. Possible value: string with a maximum of 255 characters
ifType	Read only	The value ethernet-csmacd(6) or optical(65) is entered for SCALANCE X-200.
ifSpeed	Read only	Data transfer rate of the Ethernet port in bits per second. With SCALANCE X-200 devices, this is either 10 Mbps or 100 Mbps
ifOperStatus	Read only	The current operating status of the Ethernet port. The following values are possible: • up(1) • down(2)
ifLastChange	Read only	Length of time for which the selected port has been operating in the current status. The value is shown in hundredths of a second.
ifInErrors	Read only	Number of received packages that were not forwarded to higher protocol layers because of an error.
ifOutErrors	Read only	Number of packages that were not sent because of an error.

Port Indexes

The interface index must be used for port designations. The following table shows how the interface indexes are assigned to the ports.

Interface Index	Port
1	Port 1
2	Port 2
3	Port 3
4	Port 4
5	Port 5
6	Port 6
7	Port 7
8	Port 8
.	.
.	.
.	.
24	Port 24

Important private MIB variables of an IE Switch X-200

OID The private MIB variables of the IE Switch X-200 have the following object identifier:
 iso(1).org(3).dod(6).internet(1).private(4).enterprises(1).
 ad(4196).adProductMibs(1).simaticNet(1).iScalanceX(5).iScalanceX200(2)

6.3 Configuration using Web Based Management (WBM) and Command Line Interface (CLI)

Variable	Access rights	Description
snX200FaultState	Read and write	Displays the error status of the device. Possible values: <ul style="list-style-type: none"> • 1 No error • 2 Error
snX200FaultValue	Read only	Errors are assigned an ascending index according to the order in which they occur. This 4-byte variable specifies the index.
snX200RmState	Read only	Indicates whether the redundancy manager is active or passive. Possible values: <ul style="list-style-type: none"> • 1 The redundancy manager is passive. The IE Switch X-200 is operating as redundancy manager and has opened the ring. In other words, the bus with the IE Switches X-200 connected to it is operating correctly. The "Passive" status is also shown when the redundancy manager mode is disabled. • 2 The redundancy manager is active. The IE Switch X-200 is operating as redundancy manager and has closed the ring. In other words, the bus with the IE Switches X-200 connected to it is interrupted (fault). The redundancy manager switches through the connection between the ring ports and thus restores a functioning bus configuration.
snX200RmStateChanges	Read only	Indicates how often the redundancy manager was switched to "active".
snBootStrapVersion	Read only	The firmware version of the bootloader in the format major.minor.
snHwVersion	Read only	The hardware version of the system in the format major.minor.
snInfoSerialNr	Read only	The serial number of the product.
snMacAddressBase	Read only	The MAC address of the IE Switch X-200.
snSwVersion	Read only	The software version of the system.
snInfoMLFB	Read only	The MLFB number of the device.
snX200PowerSupplyState	Read only	State of the redundant power supply: <p>1 Redundant supply</p> <p>2 No redundant supply</p> <p>Note:</p> <p>The following devices do not have a redundant power supply:</p> <ul style="list-style-type: none"> - SCALANCE X204 IRT PRO - SCALANCE X202-2P IRT - SCALANCE X201-3P IRT - SCALANCE X201-3P IRT PRO
SnX200RmMode	Read only	The redundancy manager mode <p>1 The IE Switch X-200 is redundancy manager.</p> <p>2 The IE Switch X-200 is not redundancy manager.</p>

IRT technology with SCALANCE X-200

With STEP 7 as of V5.4, you can configure PROFINET devices that support data exchange over isochronous real-time Ethernet (IRT). IRT frames are transferred deterministically over planned communication paths in a fixed order to achieve the best possible synchronicity and performance.

Supported devices

Topology-based IRT requires special network components that support planned data transmission. X202-2IRT, X204IRT, XF204IRT, X204IRT PRO, X202-2P IRT, X202-2P IRT PRO, X201-3P IRT and X200-4P IRT support topology-based IRT.

Note

In IRT mode, all X-200 IE switches in a plant must either have firmware version V3.1 or older, or they must have firmware version V4.0 or newer.

Operating an IRT plant containing both devices with firmware V3.1 or older and devices with V4.0 or newer is not possible.

Where necessary, install firmware V3.1 on the devices. This can be found on the accompanying CD in the \FW\SCALANCE X-200 IRT Isochronous Real-Time\ folder.

You should remember the following restrictions:

- The SCALANCE XF204 IRT is compatible with firmware X200IRT V4.1 or later.
- The SCALANCE X201-3P IRT PRO is compatible with firmware X200IRT V4.5 or later.

Firmware V3.1 must not be used for these two modules.

Note

No port mirroring in IRT mode

Disable the function "Port Mirroring" in SCALANCE X-200 IRT devices if you want to operate the device in IRT mode. IRT mode is not possible when the mirroring function is enabled.

Note

The use of the SCALANCE X-200 IRT as a redundant sync master is only permitted for IRT with the "High Performance" option.

Constant bus cycle and isochronous real time now also available with PROFINET

The possibilities available for constant bus cycles and isochronous real time with PROFIBUS DP are now available for PROFINET IO.

When using the constant bus cycle functionality in PROFIBUS DP, all nodes are synchronized by a global control signal generated by the DP master.

In PROFINET IO with IRT, a sync master generates a signal with which the sync slaves synchronize themselves. The sync master and sync slaves belong to a sync domain that is assigned a name during project engineering. In principle, both an IO controller and an IO device can adopt the role of sync master. A sync domain has exactly one sync master.

Relationship: Sync domain and IO systems

The important point is that sync domains do not need to be restricted to a PROFINET IO system: The devices of several IO systems can be synchronized by a single sync master as long as they are connected to the same Ethernet subnet.

On the other hand: A IO system may only belong to one sync domain.

Signal delays must be taken into account

If you use extremely precise synchronization intervals, the cable lengths (the associated delays) must be taken into account. With the aid of a Topology Editor, you can enter the properties of the cables between the ports of the switches. Based on this information and the other configuration data, STEP 7 calculates the optimized sequence of the IRT communication and the resulting update time.

Keeping network load within limits

To allow you to limit the network load resulting from extremely short update times, update groups are configured for the IRT data. If only a few devices require the shortest update times, these are assigned to the first update group. Each other update group has an update group with n times the update time compared with the previous group (n can be configured); in other words, the group is updated less often and network load is reduced.

In STEP 7 V5.4, only one update group is planned.

IRT runs alongside real-time and TCP/IP communication

Apart from IRT communication for which a fixed bandwidth is reserved within the update time, RT communication and TCP/IP communication are also permitted within the update time.

In RT communication (real-time communication), the cyclic data is transferred between the IO controller and IO device, however, without the "best possible synchronicity".

Unsynchronized IO device automatically exchange data using RT communication.

Since TCP/IP communication is also possible, other non real-time data or configuration/diagnostic data can be transported.

PROFINET IO functionality

8.1 Configuring with PROFINET IO

Using PROFINET IO

One option for diagnostics, parameter assignment, and generation of alarm messages of the connected IE Switch X-200 is to use PROFINET IO.

Note**Information on the Internet**

An overview of the PROFINET communication system can be found in the PROFINET system manual on the Internet at the following address:
<http://support.automation.siemens.com/WW/view/en/19292127>

Here, we will show you how you can use the options of PROFINET IO for a connected IE Switch X-200.

In the example, it is assumed that an S7 station is already configured with a PN IO chain (see also PN IO System Manual).

An example of a hardware configuration with a PN IO chain is shown in the following figure.

NOTICE

If you want to operate X200 IE switches that were previously configured over PROFINET without PROFINET functionality, the devices must be reset to the factory defaults.

You can do this with the "Reset to Factory Defaults" function in Web-Based Management or by pressing the button when you turn on the power supply.

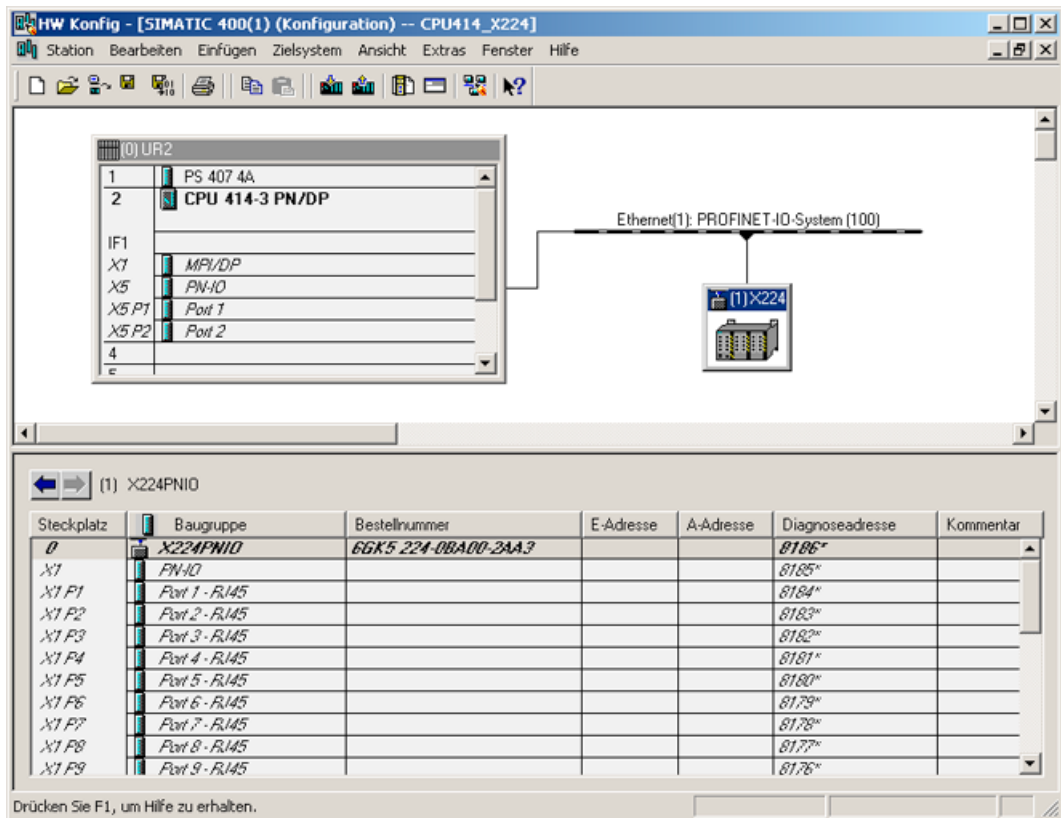

Figure 8-1 PN IO setup of the station

Including the IE Switch X-200

To include the individual X-200 IE switches as PN IO devices, the IE Switch X-200 must exist in the module catalog under PROFINET IO. If this is not the case, the X-200 IE switches must be included by linking the supplied GSDML file in the module catalog.

A device name can then be assigned.

Linking in a GSDML file

If the devices are not yet included in STEP 7, follow the steps below:

1. In the dialog box, select HW Config -> Options "Install GSD Files".
The following dialog box appears:

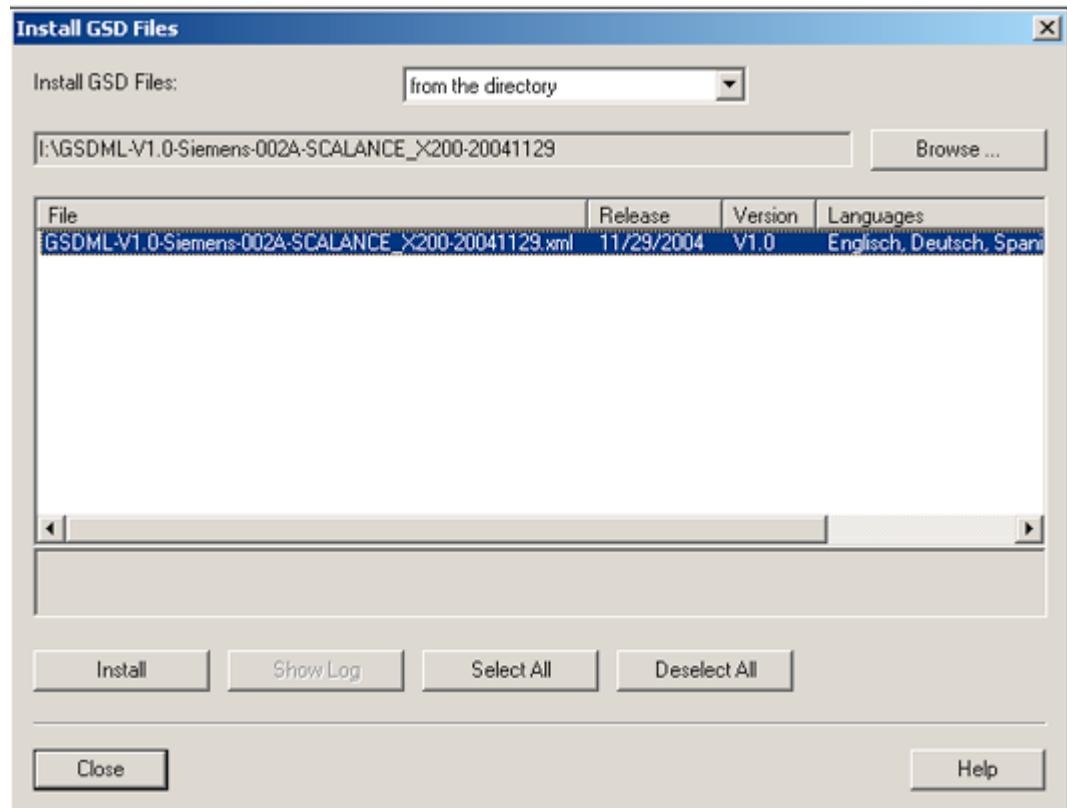

Figure 8-2 Installing the PN IO GSD file

2. Use "Browse" to navigate to the supplied xml file.
3. Then adopt the file using the "Install" function.
The X-200 IE switches are now included in the module catalog (refer to the module catalog in the following figure).
4. Drag the required X-200 IE switches from the hardware catalog to the PROFINET IO system. The inserted IE Switch X-200 appears as an icon in HW Config.
5. Click on the "(1)SCALANCE" icon so that the slots of the SCALANCE are displayed in the lower part of the screen. By double-clicking on slot=0, you can set the global parameters of the SCALANCE (substitute module).
6. By double-clicking on slot 1, you can make the PNIO settings. This includes, for example, the device name, the diagnostics address as well as settings relating to the IO cycle and media redundancy.
7. After double-clicking on the slots of the ports, you can set their specific parameters.
8. Right-click on the icon of the IE Switch X-200 to open the context menu. Select "Object Properties". Enter the device name and set the required IP configuration.

9. Save and compile the hardware configuration.
10. Select the Station > Save and Compile menu command.
11. Interconnect the devices over the network and turn on the power supply on the controller and the IE Switch X-200.

Assigning a device name

To transfer the name to the IE Switch X-200, you require an online connection from the PG to the IO device.

- You transfer the device name to the SCALANCE X-208 with PLC > Ethernet > Assign Device Name.

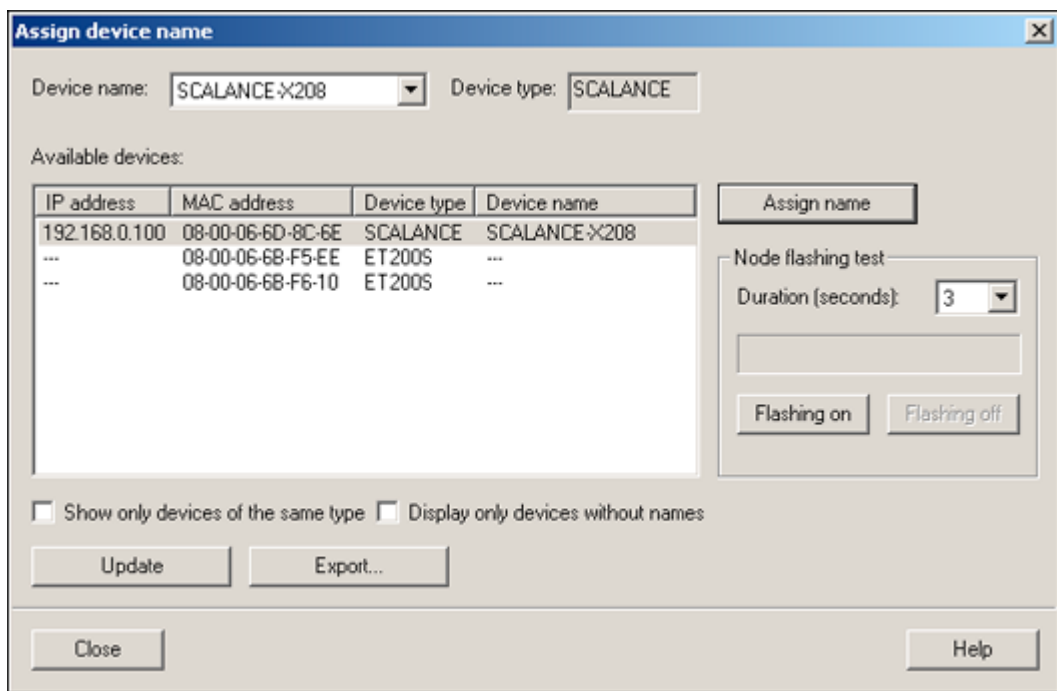

Figure 8-3 Assign Device Name PN IO dialog

If you use more than one PN IO device, the "Assign Device Name" dialog also displays more than one PN IO device. In this case, you should compare the MAC address of the device with the indicated MAC address and select the proper IO device. You can also check the assignment visually with the "Flashing On/Off" button (all the LEDs of the selected SCALANCE flash).

- Click on the Assign Name button in the Device Names dialog box. The device name is stored permanently on the SCALANCE.

After assigning the name, the device name you assigned appears in the dialog box.

- Select PLC > Download to Module to download the hardware configuration to the CPU module.

8.2 Settings in HW Config

8.2.1 Configuring alarms

Procedure

1. Open the dialog with the general settings. In this dialog, you will find settings that apply to the entire device.
2. To open the dialog, select the device whose settings you want to change. In the lower half of the station window, there is a detailed view of the selected device.
3. Double-click on slot 0 to open the properties dialog of the PROFINET interface. As an alternative, the properties dialog can also be opened by right-clicking on slot 0 and selecting the "Object Properties" entry from the context menu.
4. Then select the "Parameters" tab. Here, you can make the following settings:

Redundant power supply

Not monitored

The failure of one of the two power supplies does not cause an alarm to be generated.

Monitored

The failure of one of the two power supplies causes an alarm.

C-PLUG

Not monitored

No alarm results from a C-PLUG error.

Monitored

A C-PLUG error causes an alarm.

8.2.2 Configuring MRP

Procedure

1. In STEP 7, open the properties dialog of the PROFINET interface of the switch (double-click on the slot "PN-IO").
2. Open the "Media Redundancy" tab.

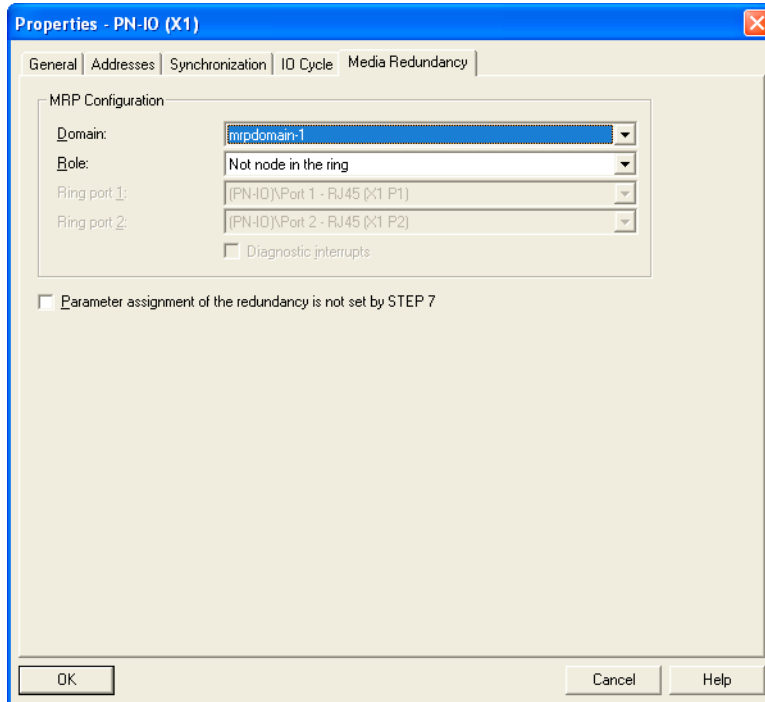

Figure 8-4 Properties dialog of the PROFINET interface, "Media Redundancy" tab

You can set the following parameters in the "MRP configuration" box to configure MRP for the device:

- Domain
- Role
- Ring port
- Diagnostics interrupts
- Redundancy parameters are not set by STEP 7

These settings are described below.

Note

Prioritized startup

If you configure MRP in a ring, you cannot use the "prioritized startup" function in PROFINET applications on the devices involved.

If you want to use the "prioritized startup" function, then disable MRP in the configuration.

In the STEP 7 configuration, properties dialog of the PROFINET interface > "Media redundancy" tab > "MRP configuration" box, set the role to "Not node in the ring".

Domain

All devices configured in a ring with MRP must belong to the same redundancy domain. A device cannot belong to more than one redundancy domain.

If you leave the setting for "Domain" as the factory set "default-mrpdomain", the factory settings for "Role" and "Ring ports" also remain active.

The MRP settings remain in effect following a restart of the device or following a power down and hot restart.

Role

NOTICE
If you reset to the factory settings, the MRP role of the device is also reset. If you are operating a non-Siemens device as the redundancy manager in the ring, this may cause loss of the data traffic.

The choice of role depends on the following use cases.

- You want to use MRP in a ring topology only with Siemens devices and without monitoring diagnostic interrupts:
Assign all devices to the "default-mrpdomain".
The device that actually takes over the role of redundancy manager, is negotiated by Siemens devices automatically.
- You want to use MRP in a ring topology that also includes non-Siemens devices or you want to receive diagnostic interrupts relating to the MRP status from a device (see "Diagnostic interrupts"):
 - Select the "Manager" role for one device (and one only) that will be redundancy manager in the ring.
 - For all other devices in the ring topology, select the role of "Client".

NOTICE

Using a non-Siemens device

To ensure problem-free operation when using a non-Siemens device as the redundancy manager in the ring, make sure that you assign the fixed role of "Client" to all other devices in the ring, before you close the ring. Otherwise, there may be circulating data frames that will cause a failure in the network.

- You want to disable MRP:
Select the option "Not node in the ring" if you do not want to operate the device within a ring topology with MRP.

Ring port 1 / ring port 2

Here, select the port you want to configure as ring port 1 and ring port 2.

The drop-down list shows the selection of possible ports for each device type. If the ports are specified in the factory, the boxes are grayed out.

Note

With X200 switches with more than 8 ports, not all ports can be selected as ring port.

NOTICE

Effects of resetting to factory settings

If you reset to the factory settings, the ring port settings are also reset. With the appropriate attachment, a previously correctly configured ring node can cause circulating frames and therefore the failure of the data traffic.

Diagnostics interrupts

Select the "Diagnostics interrupts" option, if you want diagnostics interrupts relating to the MRP status on the local CPU to be output.

The following diagnostic interrupts can be generated:

- Wiring or port error

Diagnostic interrupts are generated if the following errors occur at the ring ports:

- Connection abort on a ring port
- A neighbor of the ring port does not support MRP.
- A ring port is connected to a non-ring port.
- A ring port is connected to the ring port of another MRP domain.

- Interruption / return (redundancy manager only)

If the ring is interrupted and when the original configuration returns, diagnostic interrupts are generated.

The occurrence of both interrupts within 0.2 seconds indicates an interruption in the ring.

Parameter assignment of the redundancy is not set by STEP 7

This option only affects switches.

If you enable this option, existing redundancy settings from Web Based Management, CLI or SNMP, are retained and are not overwritten.

Select this option if you want to set the properties for media redundancy using alternative mechanism or tools such as Web based Management or SNMP. The parameters in the "MRP configuration" box are then reset and grayed out. The entries then have no meaning.

Note

No change of the media redundancy configuration during operation of PROFINET IO

With X200-IRT devices, media redundancy cannot be set during PROFINET IO operation.

Set the devices to the "Reset to Factory Defaults" status to configure media redundancy on a alternative path. You can then make the redundancy settings with WBM, CLI, or SNMP. After these settings have been made, you can create the configuration in STEP 7.

8.2.3 Configuring the topology

Procedure

1. Call the dialog box with port-specific settings. To open the dialog, select the device whose settings you want to change. In the lower half of the station window, there is a detailed view of the selected device.
2. Double-click on the required port to open its properties dialog. As an alternative, the properties dialog can also be opened by right-clicking on the relevant port and selecting the "Object Properties" entry from the context menu.
3. Then select the "Topology" tab.

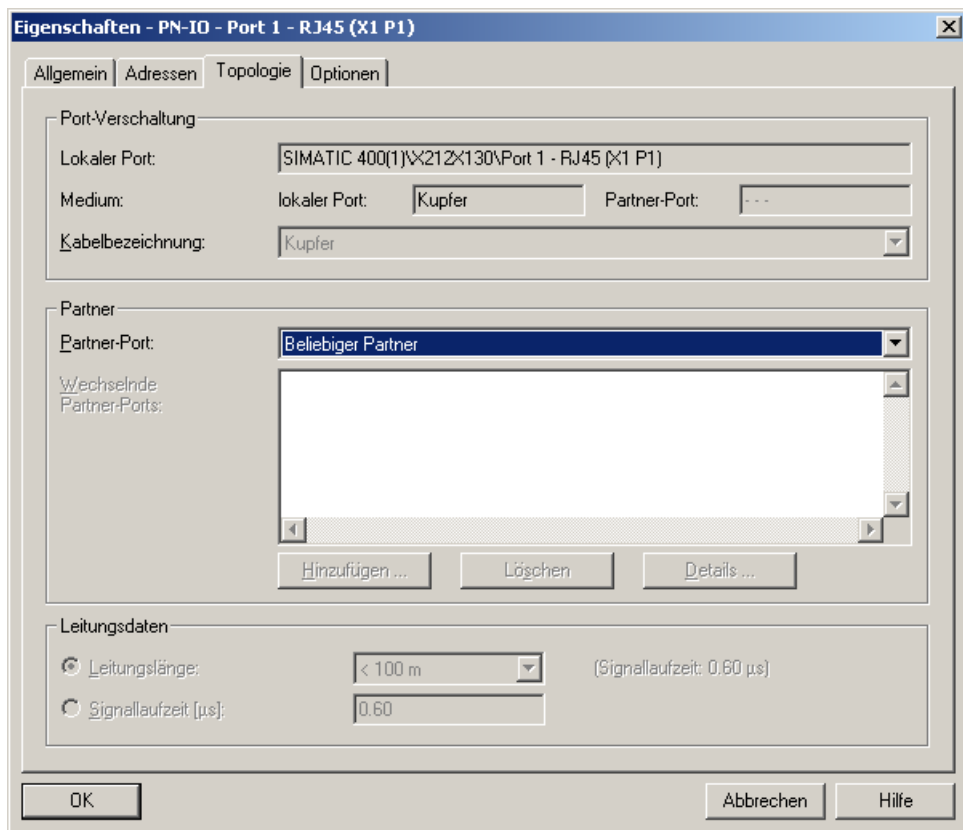

Figure 8-5 STEP 7 HW Config dialog box, "Topology" tab

Partners

- Partner port

Here you can configure the topology that will be monitored. To do this, select the port of another device that is connected to the currently selected port in the "Partner Port" drop-down list:

- "Alternating partner port"

Select this option if you want alternating ports to be monitored.

- "Any partner"

Select this setting, if you do not want the topology be monitored.

This is the default setting.

- Changing partner ports

Here, select all ports to be monitored when ports alternate.

8.3 HSR configuration in PROFINET IO

With PROFINET IO, the use of MRP rather than HSR is recommended.

HSR cannot be configured with STEP 7.

Note

If you nevertheless want to use HSR with PROFINET IO, please note the following points:

- Select the firmware version V3.0 for all modules in HSR mode in STEP 7 HW Config.
If a firmware version V4.0 or higher is selected in HW Config, the parameters for the redundancy function are always set by STEP 7. STEP 7, however, supports only MRP mode. This behavior only occurs up to STEP 7 V5.4.
With STEP 7 V5.5, the setting "Parameter assignment of the redundancy is not set by STEP 7" was introduced.
- If the default settings for the ring ports are used, only one device in the ring needs to be configured as HSR manager. No further parameter assignment is necessary for the other nodes.

Create the configuration of the module with Web Based Management, CLI or SNMP before it establishes a connection to the controller. As soon as there is a connection to the controller, the redundancy settings can no longer be changed!

NOTICE
<p>If a firmware is downloaded that is older than the firmware already on the device, you will need to reset to factory settings after downloading the firmware.</p> <p>If the firmware of an IE Switch X-200 is updated, make sure that the firmware in use is compatible with the relevant device.</p> <p>If incompatible firmware is downloaded to the device, it will no longer be possible to operate the device. In this case, compatible firmware will have to be loaded again with the boot loader.</p> <p>You should therefore remember the following restrictions:</p> <ul style="list-style-type: none">• SCALANCE X200-4P IRT, X201-3P IRT and X202-2P IRT are compatible with firmware X200IRT V2.1 or later.• SCALANCE X202-2P IRT PRO and X204P IRT PRO are compatible with firmware X200IRT V3.1 or later.• SCALANCE XF204IRT is compatible with firmware X200IRT V4.1 or later.• SCALANCE X201-3P IRT PRO is compatible with firmware X200IRT V4.5 or later.• SCALANCE XF204, XF204-2, XF206-1, XF208 are compatible with firmware X200 V4.1 or later.• SCALANCE X204-2TS is compatible with firmware X200 V4.3 or later.

8.4 Structure of the data records

Data records 4, 5 and 0x802A

The structure of the data records 4, 5 and 0x802A is described below.

Data record 4:

Access: Read-write,
Structure:
typedef struct {
Word BlockType;
Word BlockLength;
Byte BlockVersionHigh;
Byte BlockVersionLow;
DWord Alarm_enable; };

BlockType:

1: Constant

BlockLength:

6: Constant in device data, designates the length without Type+ Length

BlockVersionHigh:

1: Constant in device data, designates the major version

BlockVersionLow:

1: Constant in device data, designates the minor version

Enable_alarms:

This bit list specifies what is to be monitored. If a bit is set, this alarm source is enabled.

Reserved	C-PLUG	Red_power
Bit 2 - 31	Bit 1	Bit 0
0	0: No C-PLUG monitoring	0: No monitoring of the redundant power supply
	1: Missing or incorrect C-PLUG generates alarm	1: Monitoring of the redundant power supply

Data record 5:

Supplies the current alarm setting for this port

Access: Read-only

```
typedef struct {
    Word BlockType;
    Word BlockLength;
    Byte BlockVersionHigh;
    Byte BlockVersionLow;
    DWord status; };
```

BlockType:

1: Constant

BlockLength:

6: Constant in device data, designates the length without Type+ Length

BlockVersionHigh:

1: Constant in device data, designates the major version

BlockVersionLow:

1: Constant in device data, designates the minor version

Status:

Reserved Bits 8-31	C-PLUG_status Bits 4-7	Reserved Bits 2-3	Fault_line_status Bit 1	Power line redundancy Bit 0
0	Information regarding the configuration plug of the network component 0: C-PLUG inserted and ok 1:C-PLUG not inserted 2: C-PLUG inserted but not ok (incorrect type) 3: C-PLUG inserted but not ok (checksum error)		Information about the current error status 0: Fault line passive 1: Fault line active	This bit provides information about the redundant power supply 0: not redundant 1: redundant

Data record 0x802A

Structure

```
typedef struct{
  Word BlockType;
  Word BlockLength;
  Byte BlockVersionHigh;
  Byte BlockVersionLow;
  Word Padding;
  Word SlotNumber;
  Word SubslotNumber;
  Byte LengthOwnPortID;
  8 Byte OwnPortID;
  Byte NumberOfPeers;
  Word Padding;
  Byte LengthPeerPortID;
  8 Byte PeerPortID;
  Byte LengthPeerChassisID;
  8 Byte PeerChassisID;
  Word Padding;
  DWord LineDelay;
  6 Byte PeerMACAddress;
  Word Padding;
  Word MAUType;
  Word Padding;
  DWord DomainBoundary;
  DWord MulticastBoundary;
  Word LinkState;
  Word Padding;
  DWord MediaType;};
```

BlockType

Constant = 0x020F

BlockLength

Constant, describes the length of the data record without the "BlockType" and "BlockLength" fields.

BlockVersionHigh

Constant = 1, designates the major version.

BlockVersionLow

Constant = 0, designates the minor version.

SlotNumber

Slot designation.

SubslotNumber

Subslot designation

LengthOwnPortID

Length of the OwnPortID field in bytes.

OwnPortID

ID of the port used.

NumberOfPeers

Number of neighboring ports.

LengthPeerPortID

Length of the "PeerPortID" field in bytes.

PeerPortID

Designation of the neighboring port.

LengthPeerChassisID

Length of the "PeerChassisID" field in bytes.

PeerChassisID

ID of the neighboring device.

LineDelay

LineDelay.FormatIndicator = 0

Value (hexadecimal)	Meaning
0x00000000	Line delay and cable delay unknown.
0x00000001 – 0x7FFFFFFF	Line delay in nanoseconds.

LineDelay.FormatIndicator = 1

Value (hexadecimal)	Meaning
0x00000000	Reserved
0x00000001 – 0x7FFFFFFF	Cable delay in nanoseconds.

PeerMACAddress

MAC address of the neighboring device.

MAUType

Value (hexadecimal)	Meaning
0x0000 – 0x0004	Reserved
0x0005	10BASET
0x0006-0x0009	Reserved
0x000A	10BASETXHD
0x000B	10BASETXFD
0x000C	10BASEFLHD
0x000D	10BASEFLFD
0x000F	100BASETXHD
0x0010	100BASETXFD (default)
0x0011	100BASEFXHD
0x0012	100BASEFXFD
0x0013 – 0x0014	Reserved
0x0015	1000BASEXHD
0x0016	1000BASEXFD
0x0017	1000BASELXHD
0x0018	1000BASELXFD
0x0019	1000BASESXHD
0x001A	1000BASESXFD
0x001B – 0x001C	Reserved
0x001D	1000BASETHD
0x001E	1000BASETFD
0x001F	10GigBASEFX
0x0020 – 0x002D	Reserved
0x002E	100BASELX10
0x002F – 0x0035	Reserved
0x0036	100BASEPXFD
0x0037 – 0xFFFF	Reserved

DomainBoundary

Specifies which multicast addresses are blocked.

MulticastBoundary

The individual bits of the DWord variables specify which of the 32 first RT_CLASS_2 multicast addresses (from 01-0E-CF-00-02-00 to 01-0E-CF-00-02-1F) is blocked.

Bit	Value	Meaning
0	1	The multicast MAC address 01-0E-CF-00-02-00 will be blocked.
	0	The multicast MAC address 01-0E-CF-00-02-00 will not be blocked.
...	1	The multicast MAC address 01-0E-CF-00-02-xx will be blocked.
	0	The multicast MAC address 01-0E-CF-00-02-xx will not be blocked.
31	1	The multicast MAC address 01-0E-CF-00-02-1F will be blocked.
	0	The multicast MAC address 01-0E-CF-00-02-1F will not be blocked.

LinkState

Value (hexadecimal)	Meaning
0x00	Unknown
0x01	Disabled / discard
0x02	Blocked
0x03	Port listening enabled
0x04	Learn
0x05	Forward
0x06	Interrupted
0x07 – 0xFF	Reserved

MediaType

Value (hexadecimal)	Meaning
0x00	Unknown
0x01	Copper cable
0x02	Fiber-optic cable
0x03	Wireless communication
0x04 – 0xFFFFFFFF	Reserved

Note

You will find further information on the IEC data record in IEC 61158.

Approvals and markings

Note

The specified approvals apply only when the corresponding mark is printed on the product. You can check which of the following approvals have been granted for your product by the markings on the type plate.

Product name

Type designation	Order number
SCALANCE XF204	6GK5 204-0BA00-2AF2
SCALANCE X208	6GK5 208-0BA10-2AA3
SCALANCE XF208	6GK5 208-0BA00-2AF2
SCALANCE X216	6GK5 216-0BA00-2AA3
SCALANCE X224	6GK5 224-0BA00-2AA3
SCALANCE X204-2	6GK5 204-2BB10-2AA3
SCALANCE X204-2TS	6GK5 204-2BB10-2CA2
SCALANCE XF204-2	6GK5 204-2BC00-2AF2
SCALANCE X206-1	6GK5 206-1BB10-2AA3
SCALANCE XF206-1	6GK5 206-1BC00-2AF2
SCALANCE X212-2	6GK5 212-2BB00-2AA3
SCALANCE X204-2LD	6GK5 204-2BC10-2AA3
SCALANCE X206-1LD	6GK5 206-1BC10-2AA3
SCALANCE X212-2LD	6GK5 212-2BC00-2AA3
SCALANCE X202-2IRT	6GK5 202-2BB00-2BA3
SCALANCE X204IRT	6GK5 204-0BA00-2BA3
SCALANCE XF204IRT	6GK5 204-0BA00-2BF2
SCALANCE X204IRT PRO	6GK5 204-0JA00-2BA6
SCALANCE X202-2P IRT PRO	6GK5 202-2JR00-2BA6
SCALANCE X201-3P IRT PRO	6GK5 201-3JR00-2BA6
SCALANCE X202-2P IRT	6GK5 202-2BH00-2BA3
SCALANCE X201-3P IRT	6GK5 201-3BH00-2BA3
SCALANCE X200-4P IRT	6GK5 200-4AH00-2BA3

EC directives

SIMATIC NET products meet the requirements and aims of the following EC directives.

EU declaration of conformity

You will find the EC Declaration of Conformity for this product on the Internet at the following address:

<http://support.automation.siemens.com/WW/view/de/16689636>

- > Entry list
- > Entry type "Certificates"
- > Certificate type "Declaration of Conformity"

Example German: "EG-Konformitätserklärung SCALANCE X202-2P IRT PRO",
 Example English: "Declaration of Conformity SCALANCE X202-2P IRT PRO".

EMC directive (electromagnetic compatibility)

The SIMATIC NET product meets the requirements of the EC Directive:
 2004/108/EEC "Electromagnetic Compatibility"

The product is designed for use in the following areas:

Area of application	Requirements	
	Emission	Immunity to interference
Industrial area	EN 61000-6-4 Class A: 2001	EN 61000-6-2: 2001

 WARNING
<p>Personal injury and damage to property may occur.</p>
<p>The installation of expansions that are not approved for SIMATIC NET products or their target systems may violate the requirements and regulations for safety and electromagnetic compatibility.</p>
<p>Only use expansions that are approved for the system.</p>

- **Keep to the installation guidelines**
The product meets the requirements if you adhere to the installation and safety instructions contained in this documentation and in the following documentation when installing and operating the product.
- **You can always find the latest documentation on the Internet!**
The current descriptions of the currently available products can always be found on the Internet under the specified entry IDs/Internet pages:
 - SIMATIC NET Industrial Ethernet Network manual
<http://support.automation.siemens.com/WW/view/XX/27069465>
(XX = German: de, English: en, French: fr, Italian: it Spanish: es)
 - EMC Installation Guideline, Planning Guide
<http://support.automation.siemens.com/WW/view/XX/28518276>
(XX = German: de, English: en, French: fr, Italian: it Spanish: es)
- **Working on the product**
To protect the product from electrostatic discharge, personnel must first discharge any electrostatic charge from their body before touching the product.

Note

The product was tested with a device that also complies with the standards listed above. If the product is operated with a device that does not meet these standards, there is no guarantee that the corresponding values will be adhered to.

Explosion protection directive (ATEX)

The SIMATIC NET product meets the requirements of the EC directive:
94/9/EC "Equipment and Protective Devices for Use in Potentially Explosive Atmospheres"

Note

When using (installing) SIMATIC NET products in hazardous area zone 2, make absolutely sure that the associated conditions are adhered to.

You will find these conditions on the SIMATIC NET Manual Collection.

- "Approval of SIMATIC/ SIMATIC NET Products for Direct Installation in Ex-Zone 2"

ATEX code:

II 3 G Ex nA II T4 KEMA 07 ATEX 0145X

The product meets the requirements of the standards

- EN 60079-15 : 2005 (electrical apparatus for potentially explosive atmospheres; Type of protection "n")
- and EN 60079-0:2006

The products

- SCALANCE X204-2
- SCALANCE X204-2TS

- SCALANCE X202-2IRT
- SCALANCE X212-2
- SCALANCE X206-1
- SCALANCE XF204-2
- SCALANCE XF206-1

have the approval:

II 3(2)G Ex nA [op is] IIC T4 DEKRA 11 ATEX 0060 X

These products meet the requirements of the standards

- EN 60079-15 : 2005
- EN 60079-0:2006
- EN 60079-28 : 2007

FM approval

The product meets the requirements of the standards

- Factory Mutual Approval Standard Class Number 3611
- FM Hazardous (Classified) Location Electrical Equipment:
Non Incendive / Class I / Division 2 / Groups A,B,C,D / T4 and
Non Incendive / Class I / Zone 2 / Group IIC / T4

FDA and IEC approvals

The following products meet the FDA and IEC requirements listed below.

- SCALANCE X204-2LD
- SCALANCE X206-1LD
- SCALANCE X212-2LD



Figure 9-1 FDA and IEC approvals

Note for Australia

The product meets the requirements of the AS/NZS 2064 standard (Class A).

UL Approval for Information Technology Equipment

Underwriters Laboratories (UL) complying with Standard UL 60950-1

Report Number E115352

UL Approval for Industrial Control Equipment

Underwriters Laboratories (UL) complying with Standard UL 508
Report Number E85972

CSA Approval for Information Technology Equipment

CSA Certification Mark
Canadian Standard Association CSA C22.2 No. 60950-1-03

CSA Approval for Industrial Control Equipment

CSA Certification Mark
Canadian Standard Association CSA C22.2 No. 142-M1987

cULus Approval for Information Technology Equipment

cULus Listed 60E9 I. T. E.
Underwriters Laboratories Inc. complying with

- UL 60950-1 (Information Technology Equipment)
- CSA C22.2 No. 60950-1-03

cULus Approval for Industrial Control Equipment

cULus Listed 69B1
Underwriters Laboratories Inc. complying with

- UL 508
- CSA C22.2 No. 213-M1987

cULus Approval Hazardous Location

cULus Listed 21BP I. T. E. FOR HAZ. LOC.
Underwriters Laboratories Inc. complying with

- UL 60950-1 (Information Technology Equipment)
- CSA C22.2 No. 60950-1-03 (Information Technology Equipment)
- UL 1604 and UL 2279 Pt.15 (Hazardous Locations)
- or ANSI/ISA 12.12.01 (Hazardous Locations)

Approved for use in
Cl. 1, Div. 2, GP. A, B, C, D, T4 A
Cl. 1, Zone 2, GP. IIC T4
Cl. 1, Zone 2, Aex nC IIC T4

EN 50155 (only SCALANCE X204-2TS)

The SCALANCE X204-2TS meets the requirements of EN 50155 (railway applications - electronic equipment used on rolling stock).

Approvals

Device type SCALANCE	cULus	cULus for Hazardous Locations ¹	FM ¹	C-TICK	CE	ATEX95 Zone 2 ¹	E1
XF204	UL 60950 -1 CSA C22.2 No. 60950 -1	UL 1604 and UL 2279 Pt.15 ANSI / ISA 12.12.01 CSA C22.2 No. 213- M1987 CL. 1, Div. 2 GP.A.B.C.D T.. CL. 1, Zone 2, GP. IIC, T..	FM 3611 CL.1, Div.2 GP. A.B.C.D T.. CL.1, Zone 2, GP. IIC, T.. Ta:..	AS/NZS 2064 (Class A).	EN 61000-6-4 Class A, EN 61000-6-2	EN 60079-15:2005 , EN 60079-0:2006 II 3 G Ex nA II T.. KEMA 07 ATEX 0145X	-
X208	UL 60950-1 CSA C22.2 No. 60950-1	ANSI / ISA 12.12.01 CSA C22.2 No. 213- M1987 CL. 1, Div. 2 GP.A.B.C.D T.. CL. 1, Zone 2, GP. IIC, T..	FM 3611 CL.1, Div.2 GP. A.B.C.D T.. CL.1, Zone 2, GP. IIC, T.. Ta:..	AS/NZS 2064 (Class A).	EN 61000-6-4 Class A, EN 61000-6-2	EN 60079-15:2005 , EN 60079-0:2006 II 3 G Ex nA II T.. KEMA 07 ATEX 0145X	-
XF208	UL 60950 1 CSA C22.2 No. 60950 1	ANSI / ISA 12.12.01 CSA C22.2 No. 213- M1987 CL. 1, Div. 2 GP.A.B.C.D T.. CL. 1, Zone 2, GP. IIC, T..	FM 3611 CL.1, Div.2 GP. A.B.C.D T.. CL.1, Zone 2, GP. IIC, T.. Ta:..	AS/NZS 2064 (Class A).	EN 61000-6-4 Class A, EN 61000-6-2	EN 60079-15:2005 , EN 60079-0:2006 II 3 G Ex nA II T.. KEMA 07 ATEX 0145X	-
X216	UL 60950-1 CSA C22.2 No. 60950-1	ANSI / ISA 12.12.01 CSA C22.2 No. 213- M1987 CL. 1, Div. 2 GP.A.B.C.D T.. CL. 1, Zone 2, GP. IIC, T..	FM 3611 CL.1, Div.2 GP. A.B.C.D T.. CL.1, Zone 2, GP. IIC, T.. Ta:..	AS/NZS 2064 (Class A).	EN 61000-6-4 Class A, EN 61000-6-2	EN 60079-15:2005 , EN 60079-0:2006 II 3 G Ex nA II T.. KEMA 07 ATEX 0145X	-
X224	UL 60950-1 CSA C22.2 No. 60950-1	ANSI / ISA 12.12.01 CSA C22.2 No. 213- M1987 CL. 1, Div. 2 GP.A.B.C.D T.. CL. 1, Zone 2, GP. IIC, T..	FM 3611 CL.1, Div.2 GP. A.B.C.D T.. CL.1, Zone 2, GP. IIC, T.. Ta:..	AS/NZS 2064 (Class A).	EN 61000-6-4 Class A, EN 61000-6-2	EN 60079-15:2005 , EN 60079-0:2006 II 3 G Ex nA II T.. KEMA 07 ATEX 0145X	-
X204-2	UL 60950-1 CSA C22.2 No. 60950-1	ANSI / ISA 12.12.01 CSA C22.2 No. 213- M1987 CL. 1, Div. 2 GP.A.B.C.D T.. CL. 1, Zone 2, GP. IIC, T..	FM 3611 CL.1, Div.2 GP. A.B.C.D T.. CL.1, Zone 2, GP. IIC, T.. Ta:..	AS/NZS 2064 (Class A).	EN 61000-6-4 Class A, EN 61000-6-2	EN 60079-15:2005 , EN 60079-0:2006 EN 60079-28: 2007 II 3 G Ex nA II T.. KEMA 07 ATEX 0145X II 3(2)G Ex nA [op is] IIC T4 DEKRA 11 ATEX 0060 X	-

Device type SCALANCE	cULus	cULus for Hazardous Locations ¹	FM ¹	C-TICK	CE	ATEX95 Zone 2 ¹	E1
X204-2TS	UL 60950-1 CSA C22.2 No. 60950-1	ANSI / ISA 12.12.01 CSA C22.2 No. 213- M1987 CL. 1, Div. 2 GP.A.B.C.D T.. CL. 1, Zone 2, GP. IIC, T..	FM 3611 CL.1, Div.2 GP. A.B.C.D T.. CL.1, Zone 2, GP. IIC, T.. Ta:..	AS/NZS 2064 (Class A).	EN 61000-6-4 Class A, EN 61000-6-2	EN 60079-15:2005 , EN 60079-0:2006 II 3 G Ex nA II T.. KEMA 07 ATEX 0145X II 3(2)G Ex nA [op is] IIC T4 DEKRA 11 ATEX 0060 X	-
XF204-2	UL 60950 1 CSA C22.2 No. 60950 1	ANSI / ISA 12.12.01 CSA C22.2 No. 213- M1987 CL. 1, Div. 2 GP.A.B.C.D T.. CL. 1, Zone 2, GP. IIC, T..	FM 3611 CL.1, Div.2 GP. A.B.C.D T.. CL.1, Zone 2, GP. IIC, T.. Ta:..	AS/NZS 2064 (Class A).	EN 61000-6-4 Class A, EN 61000-6-2	EN 60079-15:2005 , EN 60079-0:2006 EN 60079-28: 2007 II 3 G Ex nA II T.. KEMA 07 ATEX 0145X II 3(2)G Ex nA [op is] IIC T4 DEKRA 11 ATEX 0060 X	-
X206-1	UL 60950-1 CSA C22.2 No. 60950-1	ANSI / ISA 12.12.01 CSA C22.2 No. 213- M1987 CL. 1, Div. 2 GP.A.B.C.D T.. CL. 1, Zone 2, GP. IIC, T..	FM 3611 CL.1, Div.2 GP. A.B.C.D T.. CL.1, Zone 2, GP. IIC, T.. Ta:..	AS/NZS 2064 (Class A).	EN 61000-6-4 Class A, EN 61000-6-2	EN 60079-15:2005 , EN 60079-0:2006 EN 60079-28: 2007 II 3 G Ex nA II T.. KEMA 07 ATEX 0145X II 3(2)G Ex nA [op is] IIC T4 DEKRA 11 ATEX 0060 X	-
XF206-1	UL 60950 1 CSA C22.2 No. 60950 1	ANSI / ISA 12.12.01 CSA C22.2 No. 213- M1987 CL. 1, Div. 2 GP.A.B.C.D T.. CL. 1, Zone 2, GP. IIC, T..	FM 3611 CL.1, Div.2 GP. A.B.C.D T.. CL.1, Zone 2, GP. IIC, T.. Ta:..	AS/NZS 2064 (Class A).	EN 61000-6-4 Class A, EN 61000-6-2	EN 60079-15:2005 , EN 60079-0:2006 EN 60079-28: 2007 II 3 G Ex nA II T.. KEMA 07 ATEX 0145X II 3(2)G Ex nA [op is] IIC T4 DEKRA 11 ATEX 0060 X	-
X212-2	UL 60950-1 CSA C22.2 No. 60950-1	ANSI / ISA 12.12.01 CSA C22.2 No. 213- M1987 CL. 1, Div. 2 GP.A.B.C.D T.. CL. 1, Zone 2, GP. IIC, T..	FM 3611 CL.1, Div.2 GP. A.B.C.D T.. CL.1, Zone 2, GP. IIC, T.. Ta:..	AS/NZS 2064 (Class A).	EN 61000-6-4 Class A, EN 61000-6-2	EN 60079-15:2005 , EN 60079-0:2006 EN 60079-28: 2007 II 3 G Ex nA II T.. KEMA 07 ATEX 0145X II 3(2)G Ex nA [op is] IIC T4 DEKRA 11 ATEX 0060 X	-
X204-2 LD	UL 60950-1 CSA C22.2 No. 60950-1	ANSI / ISA 12.12.01 CSA C22.2 No. 213- M1987 CL. 1, Div. 2 GP.A.B.C.D T.. CL. 1, Zone 2, GP. IIC, T..	FM 3611 CL.1, Div.2 GP. A.B.C.D T.. CL.1, Zone 2, GP. IIC, T.. Ta:..	AS/NZS 2064 (Class A).	EN 61000-6-4 Class A, EN 61000-6-2	EN 60079-15:2005 , EN 60079-0:2006 II 3 G Ex nA II T.. KEMA 07 ATEX 0145X	-

Device type SCALANCE	cULus	cULus for Hazardous Locations ¹	FM ¹	C-TICK	CE	ATEX95 Zone 2 ¹	E1
X206-1 LD	UL 60950-1 CSA C22.2 No. 60950-1	ANSI / ISA 12.12.01 CSA C22.2 No. 213- M1987 CL. 1, Div. 2 GP.A.B.C.D T.. CL. 1, Zone 2, GP. IIC, T..	FM 3611 CL.1, Div.2 GP. A.B.C.D T.. CL.1, Zone 2, GP. IIC, T.. Ta:..	AS/NZS 2064 (Class A).	EN 61000-6-4 Class A, EN 61000-6-2	EN 60079-15:2005 , EN 60079-0:2006 II 3 G Ex nA II T.. KEMA 07 ATEX 0145X	-
X212-2LD	UL 60950-1 CSA C22.2 No. 60950-1	ANSI / ISA 12.12.01 CSA C22.2 No. 213- M1987 CL. 1, Div. 2 GP.A.B.C.D T.. CL. 1, Zone 2, GP. IIC, T..	FM 3611 CL.1, Div.2 GP. A.B.C.D T.. CL.1, Zone 2, GP. IIC, T.. Ta:..	AS/NZS 2064 (Class A).	EN 61000-6-4 Class A, EN 61000-6-2	EN 60079-15:2005 , EN 60079-0:2006 II 3 G Ex nA II T.. KEMA 07 ATEX 0145X	-
X202-2IRT	UL 60950-1 CSA C22.2 No. 60950-1	ANSI / ISA 12.12.01 CSA C22.2 No. 213- M1987 CL. 1, Div. 2 GP.A.B.C.D T.. CL. 1, Zone 2, GP. IIC, T..	FM 3611 CL.1, Div.2 GP. A.B.C.D T.. CL.1, Zone 2, GP. IIC, T.. Ta:..	AS/NZS 2064 (Class A).	EN 61000-6-4 Class A, EN 61000-6-2	EN 60079-15:2005 , EN 60079-0:2006 EN 60079-28: 2007 II 3 G Ex nA II T.. KEMA 07 ATEX 0145X II 3(2)G Ex nA [op is] IIC T4 DEKRA 11 ATEX 0060 X	-
X204IRT	UL 60950-1 CSA C22.2 No. 60950-1	ANSI / ISA 12.12.01 CSA C22.2 No. 213- M1987 CL. 1, Div. 2 GP.A.B.C.D T.. CL. 1, Zone 2, GP. IIC, T..	FM 3611 CL.1, Div.2 GP. A.B.C.D T.. CL.1, Zone 2, GP. IIC, T.. Ta:..	AS/NZS 2064 (Class A).	EN 61000-6-4 Class A, EN 61000-6-2	EN 60079-15:2005 , EN 60079-0:2006 II 3 G Ex nA II T.. KEMA 07 ATEX 0145X	-
XF204IRT	UL 60950-1 CSA C22.2 No. 60950-1	ANSI / ISA 12.12.01 CSA C22.2 No. 213- M1987 CL. 1, Div. 2 GP.A.B.C.D T.. CL. 1, Zone 2, GP. IIC, T..	FM 3611 CL.1, Div.2 GP. A.B.C.D T.. CL.1, Zone 2, GP. IIC, T.. Ta:..	AS/NZS 2064 (Class A).	EN 61000-6-4 Class A, EN 61000-6-2	EN 60079-15:2005 , EN 60079-0:2006 II 3 G Ex nA II T.. KEMA 07 ATEX 0145X	-
X204IRT PRO	UL 60950-1 CSA C22.2 No. 60950-1	ANSI / ISA 12.12.01 CSA C22.2 No. 213- M1987 CL. 1, Div. 2 GP.A.B.C.D T.. CL. 1, Zone 2, GP. IIC, T..	FM 3611 CL.1, Div.2 GP. A.B.C.D T.. CL.1, Zone 2, GP. IIC, T.. Ta:..	AS/NZS 2064 (Class A).	EN 61000-6-4 Class A, EN 61000-6-2	EN 60079-15:2005 , EN 60079-0:2006 II 3 G Ex nA II T.. KEMA 07 ATEX 0145X	-
X202-2P IRT PRO	UL 60950-1 CSA C22.2 No. 60950-1	ANSI / ISA 12.12.01 CSA C22.2 No. 213- M1987 CL. 1, Div. 2 GP.A.B.C.D T.. CL. 1, Zone 2, GP. IIC, T..	FM 3611 CL.1, Div.2 GP. A.B.C.D T.. CL.1, Zone 2, GP. IIC, T.. Ta:..	AS/NZS 2064 (Class A).	EN 61000-6-4 Class A, EN 61000-6-2	EN 60079-15:2005 , EN 60079-0:2006 II 3 G Ex nA II T.. KEMA 07 ATEX 0145X	-

Device type SCALANCE	cULus	cULus for Hazardous Locations ¹	FM ¹	C-TICK	CE	ATEX95 Zone 2 ¹	E1
X201-3P IRT PRO	UL 60950-1 CSA C22.2 No. 60950-1	ANSI / ISA 12.12.01 CSA C22.2 No. 213- M1987 CL. 1, Div. 2 GP.A.B.C.D T.. CL. 1, Zone 2, GP. IIC, T..	FM 3611 CL.1, Div.2 GP. A.B.C.D T.. CL.1, Zone 2, GP. IIC, T.. Ta:..	AS/NZS 2064 (Class A).	EN 61000-6-4 Class A, EN 61000-6-2	EN 60079-15:2005 , EN 60079-0:2006 II 3 G Ex nA II T.. KEMA 07 ATEX 0145X	-
X202-2P IRT	UL 60950-1 CSA C22.2 No. 60950-1	ANSI / ISA 12.12.01 CSA C22.2 No. 213- M1987 CL. 1, Div. 2 GP.A.B.C.D T.. CL. 1, Zone 2, GP. IIC, T..	FM 3611 CL.1, Div.2 GP. A.B.C.D T.. CL.1, Zone 2, GP. IIC, T.. Ta:..	AS/NZS 2064 (Class A).	EN 61000-6-4 Class A, EN 61000-6-2	EN 60079-15:2005 , EN 60079-0:2006 II 3 G Ex nA II T.. KEMA 07 ATEX 0145X	-
X201-3P IRT	-	-	-	AS/NZS 2064 (Class A).	EN 61000-6-4 Class A, EN 61000-6-2	-	-
X200-4P IRT	UL 60950-1 CSA C22.2 No. 60950-1	ANSI / ISA 12.12.01 CSA C22.2 No. 213- M1987 CL. 1, Div. 2 GP.A.B.C.D T.. CL. 1, Zone 2, GP. IIC, T..	FM 3611 CL.1, Div.2 GP. A.B.C.D T.. CL.1, Zone 2, GP. IIC, T.. Ta:..	AS/NZS 2064 (Class A).	EN 61000-6-4 Class A, EN 61000-6-2	EN 60079-15:2005 , EN 60079-0:2006 II 3 G Ex nA II T.. KEMA 07 ATEX 0145X	-

¹For temperature information "T.." or the maximum ambient temperature "Ta:..", refer to the type plate.

Mechanical stability

Device type SCALANCE	IEC 60068-2-6 vibration		IEC 60068-2-27 shock	
XF204	5 – 9 Hz: 3.5 mm 9 – 500 Hz: 1 g 1 octave/min, 20 sweeps		15 g, 6 ms duration 6 shocks per axis	
X208	5 – 9 Hz: 3.5 mm 9 – 500 Hz: 1 g 1 octave/min, 20 sweeps		15 g, 6 ms duration 6 shocks per axis	
XF208	5 – 9 Hz: 3.5 mm 9 – 500 Hz: 1 g 1 octave/min, 20 sweeps		15 g, 6 ms duration 6 shocks per axis	
X216	5 – 9 Hz: 3.5 mm 9 – 500 Hz: 1 g 1 octave/min, 20 sweeps		15 g, 11 ms duration 6 shocks per axis	
X224	5 – 9 Hz: 3.5 mm 9 – 500 Hz: 1 g 1 octave/min, 20 sweeps		15 g, 11 ms duration 6 shocks per axis	
X204-2	5 – 9 Hz: 3.5 mm 9 – 500 Hz: 1 g 1 octave/min, 20 sweeps		15 g, 6 ms duration 6 shocks per axis	
X204-2TS	5 – 9 Hz: 3.5 mm 9 – 500 Hz: 1 g 1 octave/min, 20 sweeps	5 – 150 Hz: Max. 7.9 g random	15 g, 6 ms duration 6 shocks per axis	50 g, 30 ms duration 6 shocks per axis
XF204-2	5 – 9 Hz: 3.5 mm 9 – 500 Hz: 1 g 1 octave/min, 20 sweeps		15 g, 6 ms duration 6 shocks per axis	
X206-1	5 – 9 Hz: 3.5 mm 9 – 500 Hz: 1 g 1 octave/min, 20 sweeps		15 g, 6 ms duration 6 shocks per axis	
XF206-1	5 – 9 Hz: 3.5 mm 9 – 500 Hz: 1 g 1 octave/min, 20 sweeps		15 g, 6 ms duration 6 shocks per axis	
X212-2	5 – 9 Hz: 3.5 mm 9 – 500 Hz: 1 g 1 octave/min, 20 sweeps		15 g, 11 ms duration 6 shocks per axis	
X204-2 LD	5 – 9 Hz: 3.5 mm 9 – 500 Hz: 1 g 1 octave/min, 20 sweeps		15 g, 11 ms duration 6 shocks per axis	
X206-1 LD	5 – 9 Hz: 3.5 mm 9 – 500 Hz: 1 g 1 octave/min, 20 sweeps		15 g, 6 ms duration 6 shocks per axis	
X212-2LD	5 – 9 Hz: 3.5 mm 9 – 500 Hz: 1 g 1 octave/min, 20 sweeps		15 g, 6 ms duration 6 shocks per axis	
X202-2IRT	10 - 58 Hz: 0.075 mm 58 - 500 Hz: 1 g 10 cycles per axis		10 g, 16 ms duration 6 shocks per axis	
X204IRT	10 - 58 Hz: 0.075 mm 58 - 500 Hz: 1 g 10 cycles per axis		10 g, 16 ms duration 6 shocks per axis	
XF204IRT	10 - 58 Hz: 0.075 mm 58 - 500 Hz: 1 g 10 cycles per axis		10 g, 16 ms duration 6 shocks per axis	

Device type SCALANCE	IEC 60068-2-6 vibration	IEC 60068-2-27 shock
X204 IRT PRO	5 – 9 Hz: 3.5 mm 9 – 150 Hz: 1 g 10 cycles per axis	15 g, 11 ms duration 6 shocks per axis
X202-2P IRT PRO	5 – 9 Hz: 3.5 mm 9 – 150 Hz: 1 g 10 cycles per axis	15 g, 11 ms duration 6 shocks per axis
X201-3P IRT PRO	5 – 9 Hz: 3.5 mm 9 – 150 Hz: 1 g 10 cycles per axis	15 g, 11 ms duration 6 shocks per axis
X202-2P IRT	5 – 9 Hz: 3.5 mm 9 – 500 Hz: 1 g 1 octave/min, 20 sweeps	15 g, 11 ms duration 6 shocks per axis
X201-3P IRT	5 – 9 Hz: 3.5 mm 9 – 500 Hz: 1 g 1 octave/min, 20 sweeps	15 g, 11 ms duration 6 shocks per axis
X200-4P IRT	5 – 9 Hz: 3.5 mm 9 – 500 Hz: 1 g 1 octave/min, 20 sweeps	15 g, 11 ms duration 6 shocks per axis

Note

The interfaces of the X-200 IE switches can be divided into groups each with 4 ports:

- P1 to P4
- P5 to P8
- P9 to P12
- etc.

If only ports of different port groups are used, the device meets the requirements for Environment B in compliance with IEEE 802.3, Section 33.4.1.1. If ports of the same port group are used, the requirements for Environment A are met.

Technical specifications

Table 10- 1 Construction

Type	Dimensions (W x H x D) in mm	Weight in g	Installation options - DIN rail - S7-300 standard rail - Wall mounting
XF204	75 x 125 x 73	250	+ No wall mounting possible No S7-300 standard rail mounting possible
X208	60 x 125 x 124	780	+
XF208	75 x 125 x 73	250	+ No wall mounting possible No S7-300 standard rail mounting possible
X216	120 x 125 x 124	1200	+
X224	180 x 125 x 124	1600	+
X204-2	60 x 125 x 124	780	+
X204-2TS	60 x 125 x 124	780	+
XF204-2	75 x 125 x 73	250	+ No wall mounting possible No S7-300 standard rail mounting possible
X206-1	60 x 125 x 124	780	+
XF206-1	75 x 125 x 73	250	+ No wall mounting possible No S7-300 standard rail mounting possible
X212-2	120 x 125 x 124	1200	+
X204-2LD	60 x 125 x 124	780	+
X206-1LD	60 x 125 x 124	780	+
X212-2LD	120 x 125 x 124	1200	+
X202-2IRT	60 x 125 x 124	780	+
X204IRT	60 x 125 x 124	780	+
XF204IRT	75 x 125 x 73	250	+ No wall mounting possible No S7-300 standard rail mounting possible
X204 IRT PRO	90 x 125 x 124	1000	+
X202-2P IRT PRO	90 x 125 x 124	1000	+
X201-3P IRT PRO	90 x 125 x 124	1000	+
X202-2P IRT	60 x 125 x 124	780	+
X201-3P IRT	60 x 125 x 124	780	+
X200-4P IRT	60 x 125 x 124	780	+

Table 10- 2 Ports

Type	Connectors end devices or network components via twisted pair RJ-45 jacks with MDI X pinning 10/100 Mbps (half / full duplex)	Connections for end devices or network components via FO cable BFOC sockets (100 Mbps, full duplex to 100BaseFX)	Connectors for power supply 4-pin plug-in terminal block	Connectors for signaling contact 2-pin plug-in terminal block
XF204	4	-	1	1
X208	8	-	1	1
XF208	8	-	1	1
X216	16	-	1	1
X224	24	-	1	1
X204-2	4	2	1	1
X204-2TS	4	2	1	1
XF204-2	4	2	1	1
X206-1	6	1	1	1
XF206-1	6	1	1	1
X212-2	12	2	1	1
X204-2LD	4	2	1	1
X206-1LD	6	1	1	1
X212-2LD	12	2	1	1
X202-2IRT	2	2	1	1
X204IRT	4	-	1	1
XF204IRT	4	-	1	1

Type	Connectors end devices or network components via twisted pair RJ-45 jacks with MDI X pinning 10/100 Mbps (half / full duplex)	Connections for end devices or network components via FO cable SC RJ jacks (push-pull) (100 Mbps, full duplex to 100BaseFX)	Connector for power supply 4-pin plug-in terminal block	Connector for signaling contact 2-pin plug-in terminal block
X202-2P IRT	2	2	1	1
X201-3P IRT	1	3	1	1
X200-4P IRT	-	4	1	1

Type	Connectors end devices or network components via twisted pair RJ-45 jacks with MDI X pinning 10/100 Mbps (half / full duplex)	Connections for end devices or network components via FO cable SC RJ jacks (push-pull) (100 Mbps, full duplex to 100BaseFX)	Connector for power supply 5-pin Power PLUG Pro connector (male)	Connector for signaling contact 5-pin b-coded M12 connector (male)
X204 IRT PRO	4	-	2	1
X202-2P IRT PRO	2	2	2	1
X201-3P IRT PRO	1	3	2	1

Table 10-3 Electrical data

Device type SCALANCE	Power supply 2 x 12 ... 24 VDC (10 ... 30 VDC) SELV (Safety Extra Low Voltage)	Power loss at 12 VDC	Current consumption at rated voltage	Overcurrent protection at input Non-replaceable fuse (F)
X204-2TS	+	6.60 W	0.6 A	3.0 A / 32 V

Device type SCALANCE	Power supply 2 x 24 VDC (18 ... 32 VDC) SELV (Safety Extra Low Voltage)	Power loss at 24 VDC	Current consumption at rated voltage	Overcurrent protection at input PTC resettable fuse
XF204	+	2.64 W	110 mA	1.1 A / 33 V
X208	+	3.84 W	160 mA	0.6 A / 60 V
XF208	+	3.12 W	130 mA	1.1 A / 33 V
X216	+	5.76 W	240 mA	1.1 A / 33 V
X224	+	8.40 W	350 mA	1.1 A / 33 V
X204-2	+	6.36 W	265 mA	0.6 A / 60 V
XF204-2	+	5.28 W	220 mA	1.1 A / 33 V
X206-1	+	5.28 W	220 mA	0.6 A / 60 V
XF206-1	+	4.08 W	170 mA	1.1 A / 33 V
X212-2	+	7.92 W	330 mA	1.1 A / 33 V
X204-2LD	+	6.36 W	265 mA	0.6 A / 60 V
X206-1LD	+	5.28 W	220 mA	0.6 A / 60 V
X212-2LD	+	7.92 W	330 mA	1.1 A / 33 V
X202-2IRT	+	6.0 W	300 mA	0.6 A / 60 V
X204IRT	+	4.8 W	200 mA	0.6 A / 60 V
XF204IRT	+	4.8 W	200 mA	0.6 A / 60 V
X204 IRT PRO	+	4.8 W	200 mA	0.6 A / 60 V
X202-2P IRT PRO	+	7.2 W	300 mA	1.1 A / 33 V
X201-3P IRT PRO	+	7.2 W	300 mA	1.1 A / 33 V
X202-2P IRT	+	7.2 W	300 mA	1.1 A / 33 V
X201-3P IRT	+	8.4 W	350 mA	1.1 A / 33 V
X200-4P IRT	+	9.6 W	400 mA	1.1 A / 33 V

Table 10- 4 Optical data

Device type SCALANCE	Optical transmit power	Receiver sensitivity
X204-2 X204-2TS XF204-2 X206-1 XF206-1 X212-2 X202-2IRT	-19 / -17 / -14 dBm (min. / typ. / max.)	-34 / -32 dBm (typ. / max.)
X204-2LD X206-1LD X212-2LD	-15 / -7 dBm (min. / max.)	-34 dBm (max.)
X202-2P IRT PRO X201-3P IRT PRO X202-2P IRT X201-3P IRT X200-4P IRT	-8 / -4.5 / -2 dBm (min. / typ. / max.)	-23 / -25 dBm (min. / typ.)

Table 10- 5 Signaling contact

Voltage for the signaling contact	24 VDC
Current through the signaling contact	max. 100 mA*

*For X204-2TS max. 50 mA.

Table 10- 6 Permitted cable lengths (copper)

Device type SCALANCE	0 - 55 m IE TP torsion cable with IE FC RJ-45 PLUG 180 or 0 - 45 m IE TP torsion cable with IE outlet RJ-45 + 10 m TP cord	0 - 85 m IE FC TP marine / trailing / flexible / FRNC / festoon / food cable with IE FC RJ-45 PLUG 180 or 0 - 75 m IE FC TP marine / trailing / flexible / FRNC / festoon / food cable + 10 m TP cord over IE FC outlet RJ-45	0 - 100 m IE FC TP standard cable with IE FC RJ-45 PLUG 180 or over IE FC outlet RJ-45 with 0 90 m IE FC TP standard cable + 10 m TP cord
XF204	+	+	+
X208	+	+	+
XF208	+	+	+
X216	+	+	+
X224	+	+	+
X204-2	+	+	+
X204-2TS	+	+	+
XF204-2	+	+	+
X206-1	+	+	+
XF206-1	+	+	+
X212-2	+	+	+
X204-2LD	+	+	+
X206-1LD	+	+	+
X212-2LD	+	+	+
X202-2IRT	+	+	+
X204IRT	+	+	+
XF204IRT	+	+	+
X204 IRT PRO	0 - 55 m IE TP torsion cable with IE RJ-45 PLUG Pro	0 - 85 m IE FC TP marine / trailing / flexible / FRNC / festoon / food cable with IE RJ-45 PLUG Pro	0 - 100 m IE FC TP standard cable with IE RJ-45 PLUG Pro
X202-2P IRT PRO			
X201-3P IRT PRO			
X202-2P IRT	+	+	+
X201-3P IRT	+	+	+
X200-4P IRT	-	-	-

Table 10- 7 Permitted cable lengths (fiber-optic)

Device type SCALANCE	1 - 50 m 980/1000 plastic optical fiber (POF)	1 - 100 m 200/230 polymer cladde d fiber (PCF) 6 dB max. permitted FO cable attenuation with 3 dB link power margin	0 - 4000 m Glass FO cable 62.5/125 µm glass fiber; 0 - 5000 m Glass FO cable 50/125 µm glass fiber; ≤ 1 dB/km at 1300 nm; 600 MHz x km; 6 dB max. permitted FO cable attenuation with 3 dB link power margin	0 - 26000 m glass FOC 9/125 µm single mode fiber; 0.5 dB/km at 1300 nm; 13 dB max. permitted FO cable attenuation with 2 dB link power margin
XF204	-	-	-	-
X208	-	-	-	-
XF208	-	-	-	-
X216	-	-	-	-
X224	-	-	-	-
X204-2	-	-	+	-
X204-2TS	-	-	+	-
XF204-2	-	-	+	-
X206-1	-	-	+	-
XF206-1	-	-	+	-
X212-2	-	-	+	-
X204-2LD	-	-	-	+
X206-1LD	-	-	-	+
X212-2LD	-	-	-	+
X202-2IRT	-	-	+	-
X204IRT	-	-	-	-
XF204IRT	-	-	-	-
X204 IRT PRO	-	-	-	-
X202-2P IRT PRO	+	+	-	-
X201-3P IRT PRO	+	+	-	-
X202-2P IRT	+	+	-	-
X201-3P IRT	+	+	-	-
X200-4P IRT	+	+	-	-

Table 10- 8 MTBF

Device type SCALANCE	Degree of protection	MTBF
XF204	IP20	48 years
X208	IP30	83 years
XF208	IP20	54 years
X216	IP30	52 years
X224	IP30	45 years
X204-2	IP30	64 years
X204-2TS	IP20	63 years
XF204-2	IP20	60 years
X206-1	IP30	72 years
XF206-1	IP20	69 years
X212-2	IP30	46 years
X204-2LD	IP30	60 years
X206-1LD	IP30	69 years
X212-2LD	IP30	43 years
X202-2IRT	IP30	62 years
X204IRT	IP30	81 years
XF204IRT	IP20	81 years
X204 IRT PRO	IP67	99 years
X202-2P IRT PRO	IP67	85 years
X201-3P IRT PRO	IP67	85 years
X202-2P IRT	IP30	84 years
X201-3P IRT	IP30	78 years
X200-4P IRT	IP30	73 years

Table 10- 9 Switching properties

Device type SCALANCE	Max. number of learnable addresses	Aging time	Switching technique	Latency
X-200	8000	30 s	Store and forward	5 μ s
XF-200	8000	30 s	Store and forward	5 μ s
X-200IRT	4096	30 s (configurable)	Store and forward / cut through	< 5 μ s
XF204IRT	4096	30 s (configurable)	Store and forward / cut through	< 5 μ s

Table 10- 10 Permitted ambient conditions

Device type SCALANCE	Operating temperature	Storage/transport temperature	Relative humidity in operation	Operating altitude at max. xx°C ambient temperature
XF204 *)	-40 °C to +60 °C	-40 °C to +70 °C	< 95 % (no condensation)	2000 m at max. 56 °C 3000 m at max. 50 °C
X208	-40 °C to +60 °C	-40 °C to +70 °C	< 95 % (no condensation)	2000 m at max. 56 °C 3000 m at max. 50 °C
XF208 *)	-40 °C to +60 °C	-40 °C to +70 °C	< 95 % (no condensation)	2000 m at max. 56 °C 3000 m at max. 50 °C
X216	-40 °C to +60 °C	-40 °C to +70 °C	< 95 % (no condensation)	2000 m at max. 56 °C 3000 m at max. 50 °C
X224	-40 °C to +60 °C	-40 °C to +70 °C	< 95 % (no condensation)	2000 m at max. 56 °C 3000 m at max. 50 °C
X204-2	-40 °C to +60 °C	-40 °C to +70 °C	< 95 % (no condensation)	2000 m at max. 56 °C 3000 m at max. 50 °C
X204-2TS	-40 °C to +70 °C	-40 °C to +70 °C	< 95 % (no condensation)	2000 m at max. 56 °C 3000 m at max. 50 °C
XF204-2 *)	-40 °C to +60 °C	-40 °C to +70 °C	< 95 % (no condensation)	2000 m at max. 56 °C 3000 m at max. 50 °C
X206-1	-40 °C to +60 °C	-40 °C to +70 °C	< 95 % (no condensation)	2000 m at max. 56 °C 3000 m at max. 50 °C
XF206-1 *)	-40 °C to +60 °C	-40 °C to +70 °C	< 95 % (no condensation)	2000 m at max. 56 °C 3000 m at max. 50 °C
X212-2	-40 °C to +60 °C	-40 °C to +70 °C	< 95 % (no condensation)	2000 m at max. 56 °C 3000 m at max. 50 °C
X204-2LD	-40 °C to +60 °C	-40 °C to +70 °C	< 95 % (no condensation)	2000 m at max. 56 °C 3000 m at max. 50 °C
X206-1LD	-40 °C to +60 °C	-40 °C to +70 °C	< 95 % (no condensation)	2000 m at max. 56 °C 3000 m at max. 50 °C
X212-2LD	-40 °C to +60 °C	-40 °C to +70 °C	< 95 % (no condensation)	2000 m at max. 56 °C 3000 m at max. 50 °C
X202-2IRT	-40 °C to +60 °C	-40 °C to +70 °C	< 95 % (no condensation)	2000 m at max. 56 °C 3000 m at max. 50 °C
X204IRT	-40 °C to +70 °C	-40 °C to +70 °C	< 95 % (no condensation)	2000 m at max. 56 °C 3000 m at max. 50 °C
XF204IRT *)	-40 °C to +60 °C	-40 °C to +60 °C	< 95 % (no condensation)	2000 m at max. 56 °C 3000 m at max. 50 °C
X204 IRT PRO	-25 °C to +70 °C	-40 °C to +70 °C	< 95 % (no condensation)	2000 m at max. 56 °C 3000 m at max. 50 °C
X202-2P IRT PRO	-25 °C to +60 °C	-40 °C to +70 °C	< 95 % (no condensation)	2000 m at max. 56 °C 3000 m at max. 50 °C
X201-3P IRT PRO	-25 °C to +60 °C	-40 °C to +70 °C	< 95 % (no condensation)	2000 m at max. 56 °C 3000 m at max. 50 °C
X202-2P IRT	-25 °C to +60 °C	-40 °C to +70 °C	< 95 % (no condensation)	2000 m at max. 56 °C 3000 m at max. 50 °C
X201-3P IRT	-25 °C to +50 °C	-40 °C to +70 °C	< 95 % (no condensation)	2000 m at max. 45 °C 3000 m at max. 40 °C
X200-4P IRT	-25 °C to +40 °C	-40 °C to +70 °C	< 95 % (no condensation)	2000 m at max. 35 °C 3000 m at max. 30 °C

Note

Note the mounting position of the SCALANCE XF-200 and X204-2TS

If a SCALANCE XF-200 or X204-2TS are mounted on a vertical rail, an ambient temperature of maximum +40 °C is permitted.

Note

The following applies to IE Switches X-200 that do not have IRT functionality:

The number of IE Switches X-200 connected in a line influences the frame delay.

When a frame passes through X-200 IE switches, it is delayed by the Store&Forward function of the X-200 IE switch

- with a 64 byte frame length by approx. 10 microseconds (at 100 Mbps)
- with a 1500 byte frame length by approx. 130 microseconds (at 100 Mbps)

This means that the more IE Switch X-200 devices the frame passes through, the longer the frame delay.

Note

The following applies to X-200 IE switches that have IRT functionality:

The number of IE Switches X-200 connected in a line influences the frame delay. The more X-200IRT IE switches a frame runs through, the higher the frame delay.

By using the "cut through" switching mechanism, the X-200IRT IE switches are ideal to meet the real-time requirements of PROFINET.

Cut through is not possible

- between a port set to 10 Mbps and a port set to 100 Mbps
- when two packets are to be sent at the same time on one port.

In this case, an IE Switch X-200 changes to Store&Forward and the delay increases.

Accessories

Table 11- 1 Order numbers

	Order number	Available for SCALANCE	
"Industrial Ethernet TP and Fiber Optic Networks" manual	6GK1970-1BA10-0AA0	All	
IE FC Stripping Tool	6GK1901-1GA00	All except X200-4P IRT	
IE FC blade cassettes	6GK1901-1GB00	All except X200-4P IRT	
IE FC TP standard cable GP	6XV1840-2AH10	All except X200-4P IRT	
IE FC TP trailing cable	6XV1840-3AH10	All except X200-4P IRT	
IE FC TP marine cable	6XV1840-4AH10	All except X200-4P IRT	
IE FC TP trailing cable GP	6XV1870-2D	All except X200-4P IRT	
IE FC TP flexible cable GP	6XV1870-2B	All except X200-4P IRT	
IE FC FRNC cable GP	6XV1871-2F	All except X200-4P IRT	
IE FC TP festoon cable GP	6XV1871-2S	All except X200-4P IRT	
IE FC TP food cable	6XV1871-2L	All except X200-4P IRT	
IE TP torsion cable	6XV1870-2F	All except X200-4P IRT	
IE POF standard cable GP	6XV1874-2A	X202-2P IRT, X201-3P IRT, X200-4P IRT, X202-2P IRT PRO, X201-3P IRT PRO	
IE POF trailing cable	6XV1874-2B	X202-2P IRT, X201-3P IRT, X200-4P IRT, X202-2P IRT PRO, X201-3P IRT PRO	
IE PCF standard cable	6XV1861-2A	X202-2P IRT, X201-3P IRT, X200-4P IRT, X202-2P IRT PRO, X201-3P IRT PRO	
IE PCF trailing cable	6XV1861-2C	X202-2P IRT, X201-3P IRT, X200-4P IRT, X202-2P IRT PRO, X201-3P IRT PRO	
FO standard cable GP	6XV1 873-2A	X204-2, X204-2TS, XF204-2 X206-1, XF206-1 X212-2 X202-2IRT	
FO FRNC cable	6XV1 873-2B		
FO ground cable	6XV1 873-2G		
FO trailing cable	6XV1 873-2C		
FO trailing cable GP	6XV1 873-2D		
INDOOR FO cable	6XV1 820-7AH10		
FO standard cable	6XV1 820-5AH10		
FO trailing cable	6XV1 820-6AH10		
Robust cable (50/125) (900 µm)	6XV1873-2R		
FC FO standard cable GP (62.5/200/230)	6XV1847-2A		
FC FO Trailing Cable (62.5/200/230)	6XV1847-2C		
Crimp and Cleave cable assembly case for FC FO system	6GK1900-1GL00-0AA0		
FC BFOC connector set with cleaning cloths and dust protection cap, pack of 20	6GK1900-1GB00-0AC0		
FC SC connector set with cleaning cloths and dust protection cap, pack of 20 = 10 duplex connectors	6GK1900-1LB00-0AC0		
SM FO robust cable GP (4x10/125)	6XV1843-2R		X204-2LD X206-1LD X212-2LD

	Order number	Available for SCALANCE
IE FC RJ-45 Plug 180 pack of 1	6GK1901-1BB10-2AA0	All except X200-4P IRT
IE FC RJ-45 Plug 180 pack of 10	6GK1901-1BB10-2AB0	
IE FC RJ-45 Plug 180 pack of 50	6GK1901-1BB10-2AE0	
C-PLUG	6GK1900-0AB00	X-200
IE SC RJ PCF Plug	6GK1900-0NB00-0AC0	X202-2P IRT, X201-3P IRT, X200-4P IRT
IE SC RJ POF Plug	6GK1900-0MB00-0AC0	X202-2P IRT, X201-3P IRT, X200-4P IRT
IE termination kit SC RJ PCF Plug	6GK1900-0NL00-0AA0	X202-2P IRT, X201-3P IRT, X200-4P IRT
IE termination kit SC RJ POF Plug	6GK1900-0ML00-0AA0	X202-2P IRT, X201-3P IRT, X200-4P IRT
IE SC RJ POF refill set	6GK1900-0MN00-0AA0	X202-2P IRT, X201-3P IRT, X200-4P IRT
IE RJ-45 Plug PRO	6GK1901-1BB10-6AA0	X202-2P IRT PRO, X201-3P IRT PRO, X204IRT PRO
IE SC RJ POF Plug PRO	6GK1900-0MB00-6AA0	X202-2P IRT PRO, X201-3P IRT PRO
IE SC RJ PCF Plug PRO	6GK1900-0NB00-6AA0	X202-2P IRT PRO, X201-3P IRT PRO
IE FC RJ-45 Plug PRO	6GK1901-1BB20-6AA0	X202-2P IRT PRO, X201-3P IRT PRO
Power Plug PRO	6GK1907-0AB10-6AA0	X202-2P IRT PRO, X201-3P IRT PRO, X204IRT PRO

References

Sources of information and other documentation

1. SIMATIC NET Industrial Twisted Pair and Fiber-Optic Networks,
Order numbers:
6GK1970-1BA10-0AA0 German
6GK1970-1BA10-0AA1 English
6GK1970-1BA10-0AA2 French
6GK1970-1BA10-0AA4 Italian
2. PROFINET Cabling and Interconnection Technology
Can be ordered from the PROFIBUS User Organization (PNO)

Dimension drawings

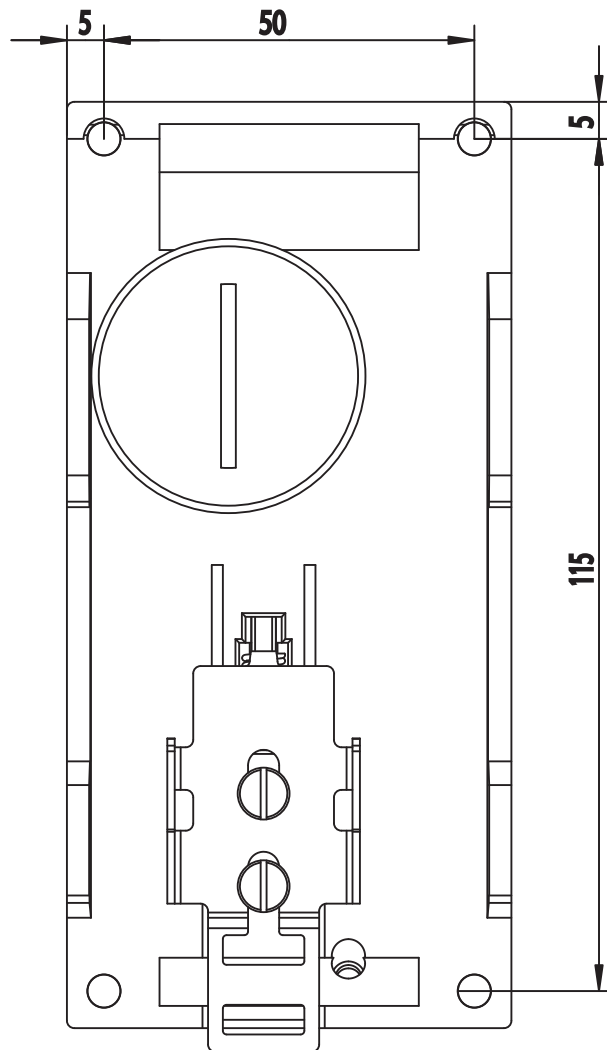

Figure 13-1 Dimension drawing SCALANCE X208, X206-1, X204-2, X204-2TS, X202-2IRT, X204IRT, X204-2LD, X206-1LD, X202-2P IRT, X202-4P IRT, X201-3P IRT, X200-4P IRT

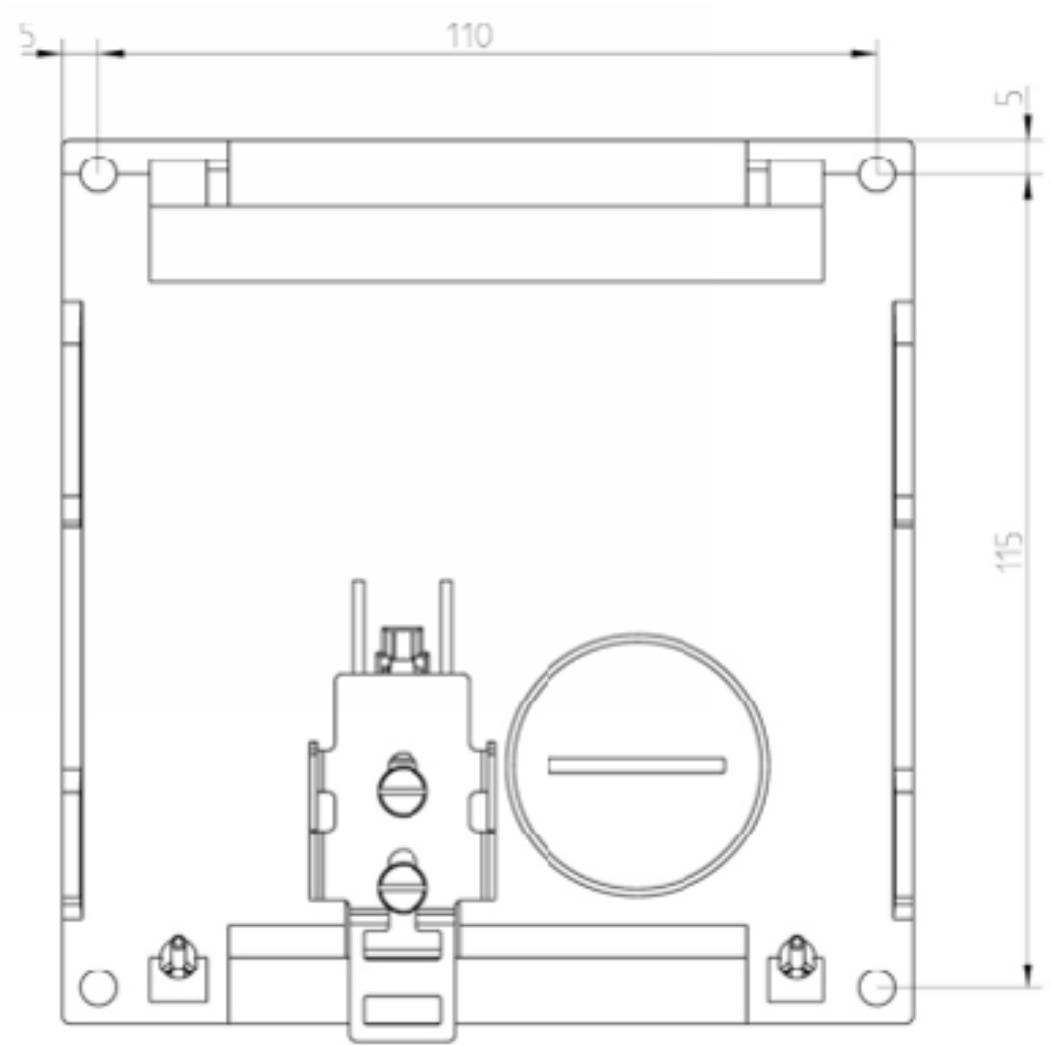

Figure 13-2 Dimension drawing SCALANCE X216, X212-2 and X212-2LD

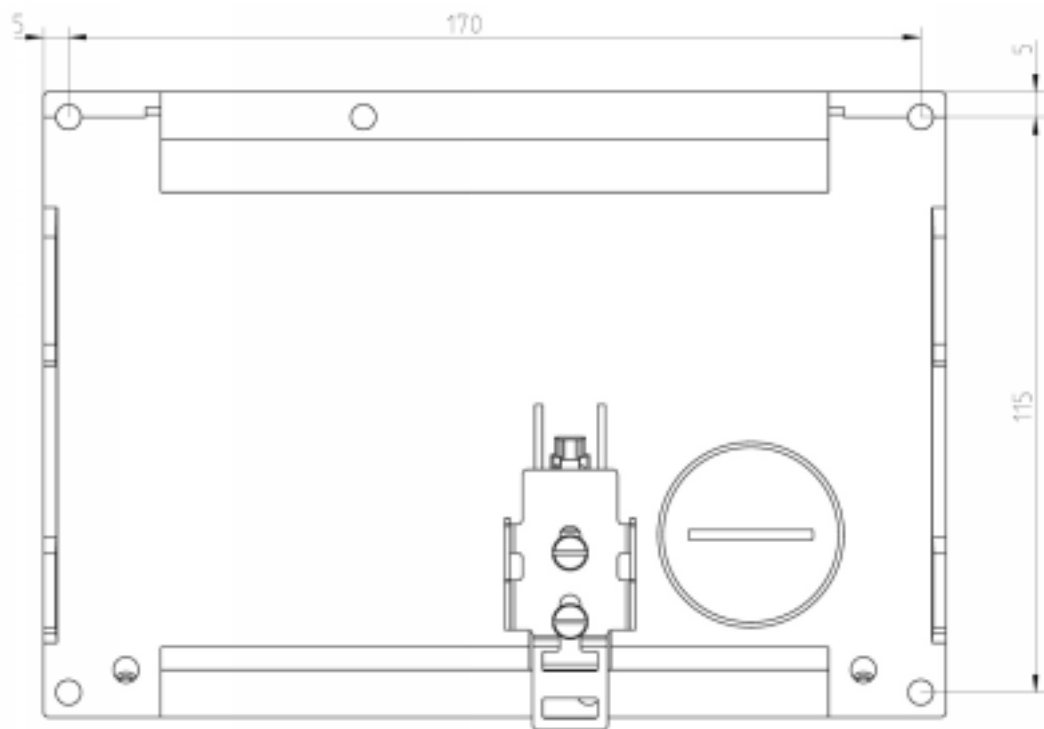

Figure 13-3 Dimension drawing SCALANCE X224

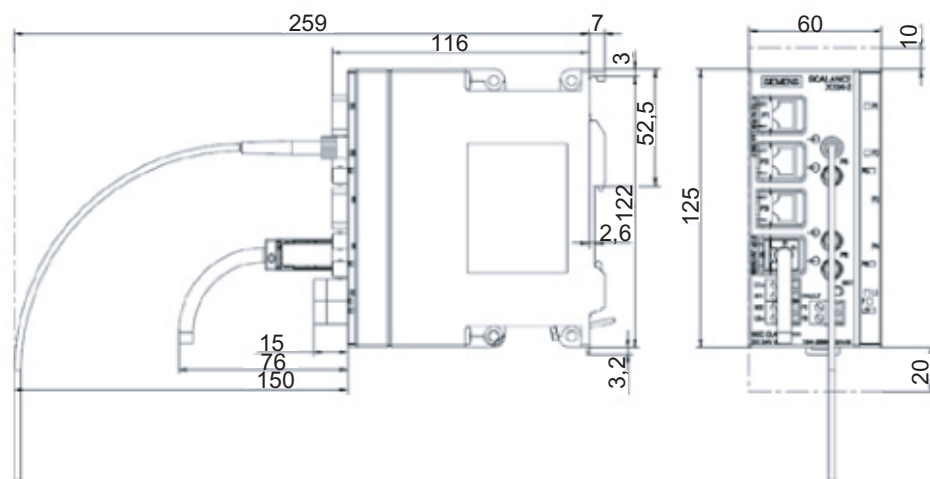

Figure 13-4 SCALANCE X200 side view

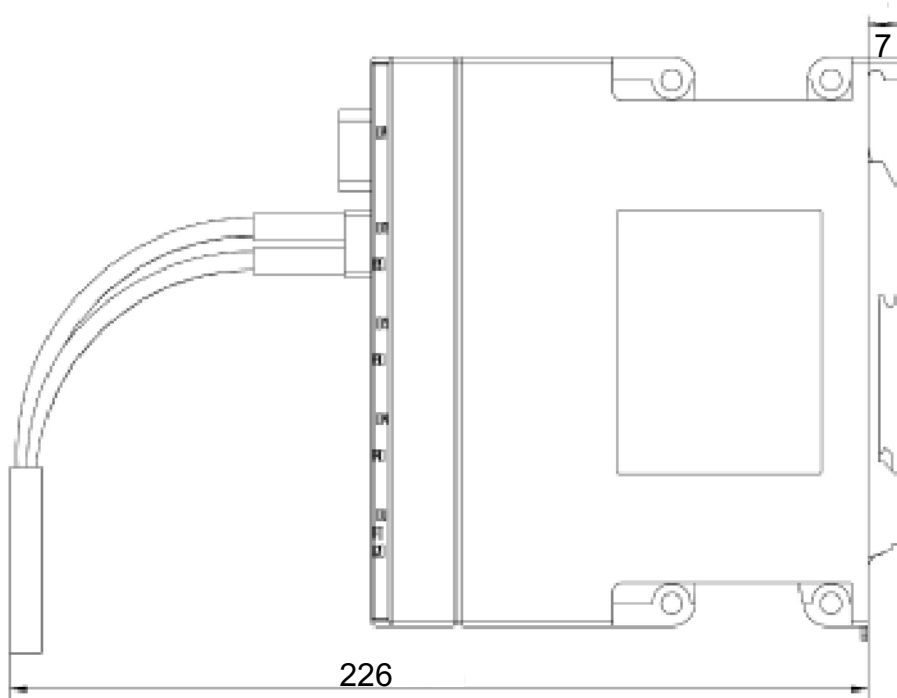

Figure 13-5 SCALANCE X-200 POF

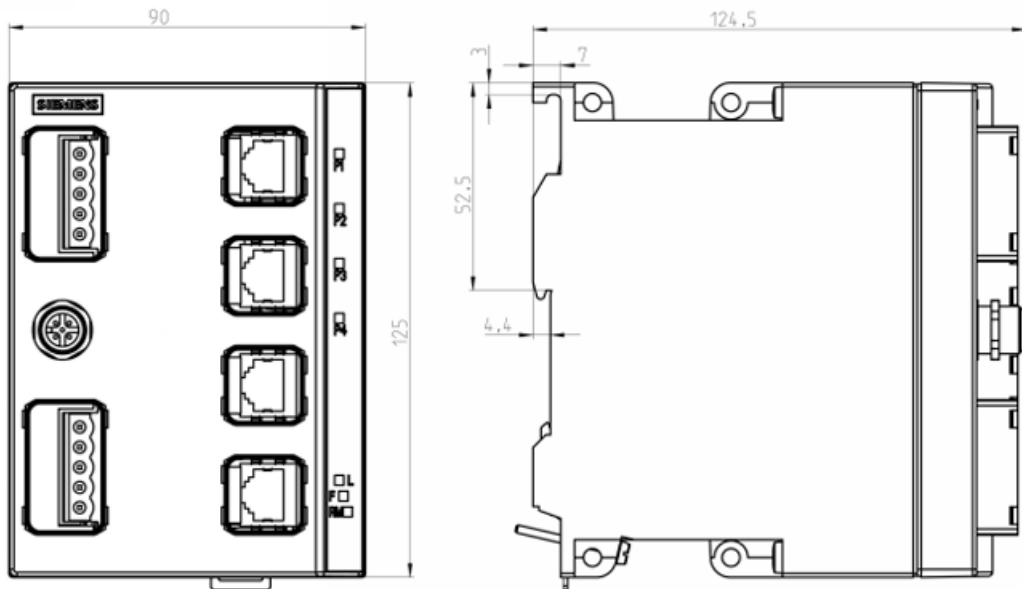

Figure 13-6 Dimension drawings of the SCALANCE X204 IRT PRO, SCALANCE X202-2P IRT PRO, SCALANCE X201-3P IRT PRO

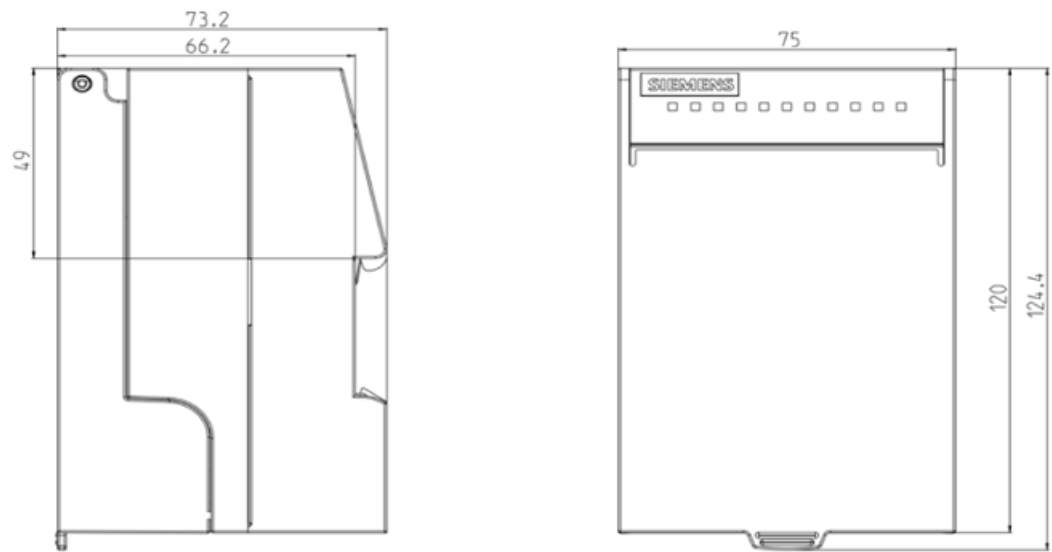

Figure 13-7 SCALANCE XF-200 dimension drawings

Index

A

ATEX, 14
ATEX95, 5
Autonegotiation, 37, 40, 43, 46, 49, 52, 56, 60, 64, 68,
72, 77, 82, 87, 91, 94, 97, 100, 104, 108, 112

B

BFOC socket
 ST socket, 58, 62, 75
Button, 119

C

CLI command
 Shortcuts for commands, 161
 Symbolic representation, 162
Connector pinout
 SCALANCE X201-3P IRT, 111
 SCALANCE X201-3P IRT PRO, 103
 SCALANCE X202-2IRT, 86
 SCALANCE X202-2P IRT, 107
 SCALANCE X202-2P IRT PRO, 99
 SCALANCE X204 IRT PRO, 96
 SCALANCE X204-2 / SCALANCE X204-2TS, 51
 SCALANCE X204-2LD, 71
 SCALANCE X204IRT, 90
 SCALANCE X206-1, 59
 SCALANCE X208, 39
 SCALANCE X212-2, 67
 SCALANCE X212-2LD, 81
 SCALANCE X216, 45
 SCALANCE X224, 48
 SCALANCE XF204, 36
 SCALANCE XF204-2, 55
 SCALANCE XF204IRT, 93
 SCALANCE XF206-1, 63
 SCALANCE XF208, 42
Console, 159
C-PLUG, 116

D

DHCP, 147, 154
Displays
 FO diagnostics display, 127
 LED display during startup, 127
 Power display, 122
 Power status display, 123
 Redundancy manager display, 124
 Standby functions, 125
DLC protocol, 149
Dynamic Host Configuration Protocol, 154

E

EMC directive, 264

G

Glossary, 6

H

Hazardous area, 13
HSR, 24, 28

I

IP address, 147
IP addresses, 150
Isochronous Real-time Ethernet, 243

L

Lease time, 154
LED simulation, 159
LEDs, 159

M

Management Information Base, 238
MDI / MDIX autocrossover function, 52, 56, 64
MDI / MDIX autocrossover function, 52, 56, 64

MDI /MDIX autocrossover function, 60, 72, 77, 87, 100, 108
MDI /MDIX autocrossover function, 60, 72, 77, 87, 100, 108
MDI /MDIX autocrossover function, 60, 72, 77, 87, 100, 108
MDI /MDIX autocrossover function, 60, 72, 77, 87, 100, 108
MDI /MDIX autocrossover function, 60, 72, 77, 87, 100, 108
MDI /MDIX autocrossover function, 60, 72, 77, 87, 100, 108
MDI /MDIX autocrossover function, 60, 72, 77, 87, 100, 108
MDI /MDIX autocrossover function, 60, 72, 77, 87, 100, 108
MDI /MDIX autocrossover function, 60, 72, 77, 87, 100, 108
MDI /MDIX autocrossover function, 60, 72, 77, 87, 100, 108
MDI /MDIX autocrossover function, 60, 72, 77, 87, 100, 108
MDI/MDIX autocrossover function, 104
Media redundancy, 23, 26
Media redundancy methods, 24, 28
MIB, 238
MRP, 24, 25
MRPD, 24

N

Network topology, 17
 Bus topology, 17
 Ring topology, 19
 Star topology, 18

P

Plastic Optical Fiber (POF), 113
Possible attachments
 SCALANCE X200-4P IRT, 114
 SCALANCE X201-3P IRT, 110
 SCALANCE X201-3P IRT PRO, 102
 SCALANCE X202-2IRT, 85
 SCALANCE X202-2IRT PRO, 98
 SCALANCE X204 IRT PRO, 95
 SCALANCE X204-2 / SCALANCE X204-2TS, 50
 SCALANCE X204-2LD, 70
 SCALANCE X204IRT, 89
 SCALANCE X206-1, 58
 SCALANCE X206-1LD, 75
 SCALANCE X208, 38
 SCALANCE X212-2, 66
 SCALANCE X212-2LD, 80
 SCALANCE X216, 44
 SCALANCE X224, 47
 SCALANCE XF204, 35

SCALANCE XF204-2, 54
SCALANCE XF204IRT, 92
SCALANCE XF206-1, 62
SCALANCE XF208, 41
Primary Setup Tool, 147, 150, 151
PROFINET IO, 245
PROFINET IO (PN IO), 153

R

Redundancy manager, 23
Refresh, 160

S

Safety notices, 13
Set Values, 160
SIMATIC NET glossary, 6
Simple Network Management Protocol, 238
SNMP, 238
ST socket
 BFOC socket, 50, 54, 70, 85
STEP 7 V 5.3 plus SP 1, 147
Support, 159

W

Web Based Management, 157