



Compass™ Series HSPA USB Modem

Installation Guide

2130961
Rev 1.1C

Important Notice

Due to the nature of wireless communications, transmission and reception of data can never be guaranteed. Data may be delayed, corrupted (i.e., have errors) or be totally lost. Although significant delays or losses of data are rare when wireless devices such as the Sierra Wireless modem are used in a normal manner with a well-constructed network, the Sierra Wireless modem should not be used in situations where failure to transmit or receive data could result in damage of any kind to the user or any other party, including but not limited to personal injury, death, or loss of property. Sierra Wireless accepts no responsibility for damages of any kind resulting from delays or errors in data transmitted or received using the Sierra Wireless modem, or for failure of the Sierra Wireless modem to transmit or receive such data.

Safety and Hazards

Do not operate the Sierra Wireless modem in areas where blasting is in progress, where explosive atmospheres may be present, near medical equipment, near life support equipment, or any equipment which may be susceptible to any form of radio interference. In such areas, the Sierra Wireless modem **MUST BE POWERED OFF**. The Sierra Wireless modem can transmit signals that could interfere with this equipment.

Do not operate the Sierra Wireless modem in any aircraft, whether the aircraft is on the ground or in flight. In aircraft, the Sierra Wireless modem **MUST BE POWERED OFF**. When operating, the Sierra Wireless modem can transmit signals that could interfere with various onboard systems.

Note: Some airlines may permit the use of cellular phones while the aircraft is on the ground and the door is open. Sierra Wireless modems may be used at this time.

The driver or operator of any vehicle should not operate the Sierra Wireless modem while in control of a vehicle. Doing so will detract from the driver or operator's control and operation of that vehicle. In some states and provinces, operating such communications devices while in control of a vehicle is an offence.

Limitation of Liability

The information in this manual is subject to change without notice and does not represent a commitment on the part of Sierra Wireless. SIERRA WIRELESS AND ITS AFFILIATES SPECIFICALLY DISCLAIM LIABILITY FOR ANY AND ALL DIRECT, INDIRECT, SPECIAL, GENERAL, INCIDENTAL, CONSEQUENTIAL, PUNITIVE OR EXEMPLARY DAMAGES INCLUDING, BUT NOT LIMITED TO, LOSS OF PROFITS OR

Patents

REVENUE OR ANTICIPATED PROFITS OR REVENUE ARISING OUT OF THE USE OR INABILITY TO USE ANY SIERRA WIRELESS PRODUCT, EVEN IF SIERRA WIRELESS AND/OR ITS AFFILIATES HAS BEEN ADVISED OF THE POSSIBILITY OF SUCH DAMAGES OR THEY ARE FORESEEABLE OR FOR CLAIMS BY ANY THIRD PARTY.

Notwithstanding the foregoing, in no event shall Sierra Wireless and/or its affiliates aggregate liability arising under or in connection with the Sierra Wireless product, regardless of the number of events, occurrences, or claims giving rise to liability, be in excess of the price paid by the purchaser for the Sierra Wireless product.

Portions of this product may be covered by some or all of the following US patents:

5,515,013	5,629,960	5,845,216	5,847,553	5,878,234
5,890,057	5,929,815	6,169,884	6,191,741	6,199,168
6,339,405	6,359,591	6,400,336	6,516,204	6,561,851
6,643,501	6,653,979	6,697,030	6,785,830	6,845,249
6,847,830	6,876,697	6,879,585	6,886,049	6,968,171
6,985,757	7,023,878	7,053,843	7,106,569	7,145,267
7,200,512	7,295,171	7,287,162	D442,170	D459,303
D599,256	D560,911			

and other patents pending.

This product includes

technology licensed from:

QUALCOMM® 3G

Licensed by QUALCOMM Incorporated under one or more of the following United States patents and/or their counterparts in other nations:

4,901,307	5,056,109	5,101,501	5,109,390	5,228,054
5,267,261	5,267,262	5,337,338	5,414,796	5,416,797
5,490,165	5,504,773	5,506,865	5,511,073	5,535,239
5,544,196	5,568,483	5,600,754	5,657,420	5,659,569
5,710,784	5,778,338			

Manufactured or sold by Sierra Wireless or its licensees under one or more patents licensed from InterDigital Group.

Copyright

© 2008 Sierra Wireless. All rights reserved.

Trademarks

“Heart of the Wireless Machine®” is a registered trademark of Sierra Wireless. Watcher® is a trademark of Sierra Wireless, registered in the European Community.

Sierra Wireless, the Sierra Wireless logo, the red wave design, the red-tipped antenna, and TRU-Install are trademarks of Sierra Wireless.

Windows® is a registered trademark of Microsoft Corporation.

QUALCOMM® is a registered trademark of QUALCOMM Incorporated. Used under license.

Macintosh® is a trademark of Apple Inc., registered in the U.S. and other countries.

Other trademarks are the property of the respective owners.

Contact Information

Sales Desk:	Phone:	1-604-232-1488
	Hours:	8:00 AM to 5:00 PM Pacific Time
	E-mail:	sales@sierrawireless.com
Post:	Sierra Wireless 13811 Wireless Way Richmond, BC Canada V6V 3A4	
Fax:	1-604-231-1109	
Web:	www.sierrawireless.com	

Consult our website for up-to-date product descriptions, documentation, application notes, firmware upgrades, troubleshooting tips, and press releases:

www.sierrawireless.com

Revision History

Revision number	Release date	Changes
1.0	April 2008	New document
1.1	May 2008	Revised instructions for inserting the SIM card.
1.1B	Sept. 2008	Updated FCC information
1.1C	Sept. 2008	Updated FCC information

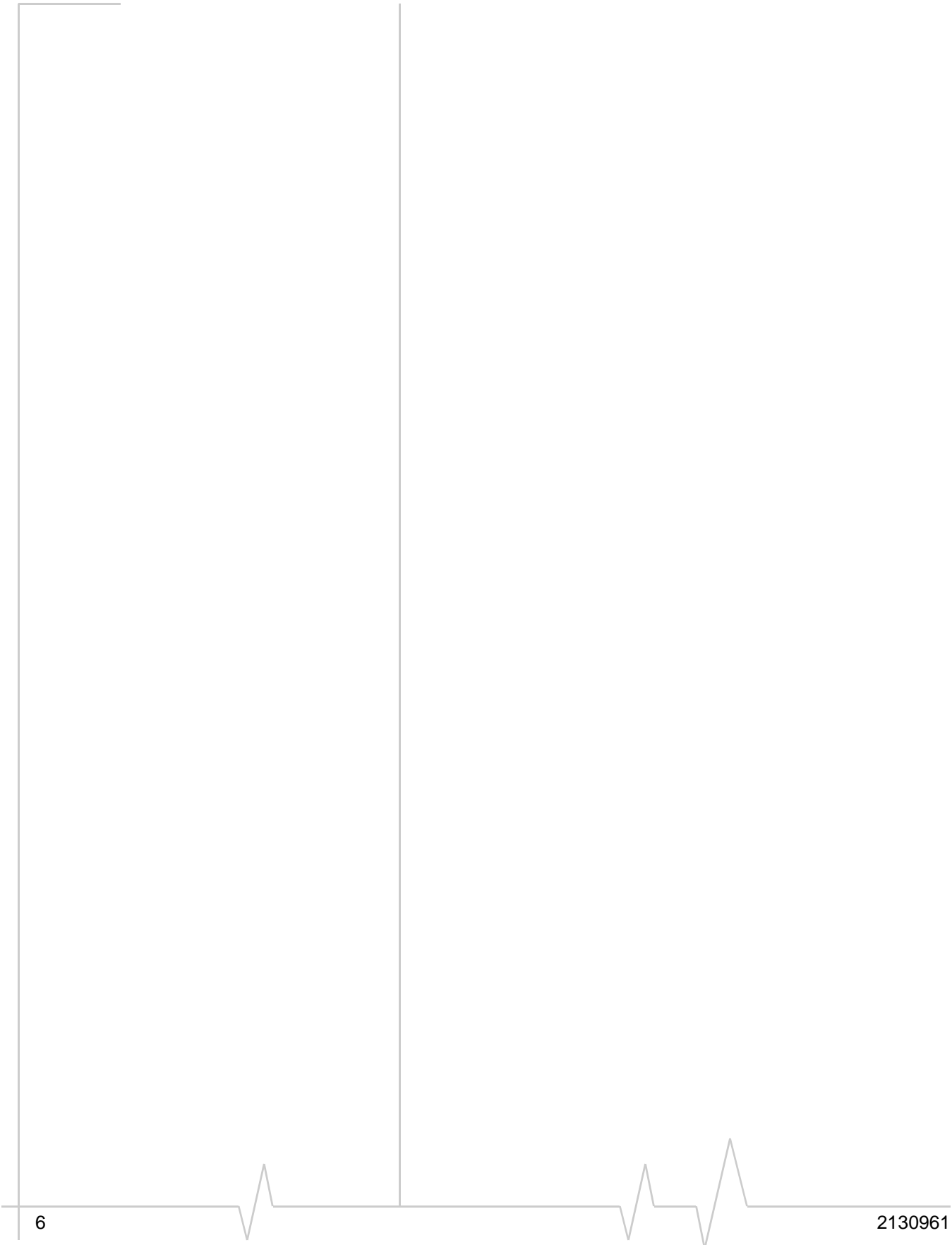

»» Contents

Introducing the Compass USB Modem	9
Services supported	9
Your account and coverage area.....	10
Compass USB modem software.....	11
Frequency band support	11
Getting Started	13
Overview of installation steps.....	13
System requirements	13
Insert the SIM card	14
Insert the Compass USB modem into the USB slot	14
Connect to the network	15
Attach the Compass USB modem to the lanyard	17
Using your Compass USB Modem	19
LEDs	20
Removing a SIM card	21
Using the microSD card.....	22
Removing the microSD card	23
Using the extension cable and notebook computer clip.....	23
Connection management software	25
Launching 3G Watcher	25
The 3G Watcher window	26
Indicators in 3G Watcher	27
Status icons	27
Turning the radio on and off	28
Frequency band and network selection	28
Reinstalling the software.....	29

Care and Maintenance of Your Compass USB Modem31

Technical Specifications33

 Radio frequency and electrical specifications 33

 Environmental specifications 34

Regulatory and Safety Information35

 Notice 35

 Safety and hazards 35

 Regulatory information for North America 36

 Regulatory information for EU countries 38

Index 39

1: Introducing the Compass USB Modem

- Services supported
- Your account and coverage area
- Compass USB modem software
- Frequency band support

The Compass™ USB third generation (3G) wireless modem enables you to connect to the Internet, send and receive email, connect to a corporate network or virtual private network (VPN), or view streaming video, without the need for a cable.

The modem fits into Type A USB ports.

The Compass USB modem is TRU-Install™ enabled. All the required software is on the modem. When you set up your modem, the software is installed on your computer. You do not need an installation CD.

The modem has a built-in antenna. A slot on the end of the modem accommodates a microSD external memory card. Depending on your service provider, a microSD card may be included in your package, or you may need to purchase it separately.

Services supported

Your Compass USB modem supports speeds of up to 7.2 Mbps. However, actual speed depends on the services offered by your service provider. Contact your service provider and visit www.sierrawireless.com for details.

Maximum theoretical data speeds are:

- High Speed Download Packet Access (HSDPA) — up to 7.2 Megabits per second (Mbps)
- High Speed Upload Packet Access (HSUPA) — up to 2.0 Mbps
- Concurrent HSDPA/HSUPA (HSPA) — up to 3.6 Mbps download and up to 1.5 Mbps upload
- Universal Mobile Telecommunications System (UMTS) — 384 kilobits per second (kbps)
- Enhanced Data rates for GSM Evolution (EDGE) — 236 kbps
- General Packet Radio Service (GPRS) — 56 kbps

Note: If you purchased the Compass USB modem from a GSM service provider, you may already have an account and a SIM card. Otherwise, your retailer should be able to give you the names of companies that provide these items.

Note: The fee for service is usually higher when you are roaming (connected to a network other than the one belonging to your service provider).

GPRS and EDGE are second generation (2G) data services. UMTS and HSDPA/HSUPA are 3G data services.

When establishing a connection, your Compass USB modem uses the fastest available service. If, for example, you are using a Compass USB modem in an area that has EDGE service but not UMTS or HSDPA/HSUPA service, the Compass USB modem connects using EDGE service.

Once the connection is established, you have access to all Internet services.

Your account and coverage area

You must have an account with a GSM service provider to use the Compass USB modem. To use the modem's 3G capability, your account must be with a service provider that offers HSDPA/HSUPA or UMTS service. (The Compass USB modem is backwards compatible with 2G service.)

When you obtain your account, you are given a Subscriber Identity Module (SIM) card containing account information. Before you use the Compass USB modem, you must insert the SIM card into it.

Your ability to obtain service depends on these factors:

- **Network coverage** — You must be within the network coverage area.
- **Service provider** — If you are within the coverage area of a network that is not operated by your own service provider, you can obtain service only if there is a roaming agreement between your service provider and the network operator.
- **Account provisions** — Your account may restrict your usage to certain networks or limit the amount of time you can use the network.
- **Frequency band** — You cannot connect to networks operating in bands not supported by your Compass USB modem, regardless of roaming agreements or account provisions.

Most service providers have coverage maps on their web sites.

Compass USB modem software

The Compass USB modem comes with connection management software. Depending on your carrier, it may come with carrier-specific software or the following software made by Sierra Wireless:

- 3G Watcher for Windows®. Use this software to manage the Compass USB modem and monitor your connections.
- Driver software that forms the interface between the Compass USB modem and your Windows operating system

For information on Watcher features and using Watcher, see [“Connection management software”](#) on page 25.

Frequency band support

Frequency bands supported by the Compass USB modem:

Technology	Bands	Location
2G	850 MHz (cellular band)	North America
	900 MHz (EGSM band)	Europe
	1800 MHz (DCS band)	Europe and Asia
	1900 MHz (PCS band)	North America
3G	WCDMA 800 (band VI)	Japan
	WCDMA 850 (band V)	North America and Australia
	WCDMA 1900 (band II)	North America
	WCDMA 2100 (band I)	Europe, Asia, and Australia



2: Getting Started

Note: Keep a written record in a secure place of the account information that your service provider gives you.

Follow the instructions in this chapter to set up and start using your Compass USB modem.

To use your Compass USB modem, you'll need:

- An account with a service provider
- A SIM card (supplied by the service provider)
- A profile, which may be:
 - Already stored on your modem when you purchase it
 - Set up automatically
 - Selected from a drop-down list
 - Created manually

Overview of installation steps

1. Check the system requirements.
2. Insert the SIM card.
3. Insert the Compass USB modem into your computer's USB port. (The necessary software is installed and either the profile is set up automatically or Watcher prompts you to create a profile.)

System requirements

The Compass USB modem is supported on:

- Windows Vista™
- Windows XP (Home and Professional versions)
- Windows 2000
- Macintosh® OS X 10.4.11 or later

To install the Compass USB modem, you require the following:

USB port	1 USB Type A slot (USB 1.1 or 2.0)
I/O resources	1 IRQ, 40 bytes I/O space
Memory	32 MB

Note: If you are running Windows 2000, Windows Installer Redistributable 2.0 must be installed. This is available on the Microsoft web site, www.microsoft.com.

*Note: If you are running Mac OS X, please refer to the **Watcher Quick Start Guide for Mac OS X** found at www.sierrawireless.com/mac.*

Note: To prevent the SIM card from becoming jammed in its slot, ensure the edge of the card is smooth before inserting it. Do not attach labels to your SIM card as this may also cause it to jam.

Insert the SIM card

1. If your SIM card is attached to a larger card, detach the SIM card and remove any fragments stuck to it.
2. Remove the cap from the end of the Compass USB modem.
3. If there is a non-functional SIM card in the upper slot:
 - a. Press it in and then release it.
 - b. Gently remove the non-functional SIM card.
4. Insert the SIM card into the top slot:
 - a. Push the SIM card in slightly beyond the edge of the plastic housing — far enough to ensure that the SIM card stays in place and the spring does not push the SIM card out.

When it is properly inserted, the outer edge of the SIM card is in line with the edge of the housing.

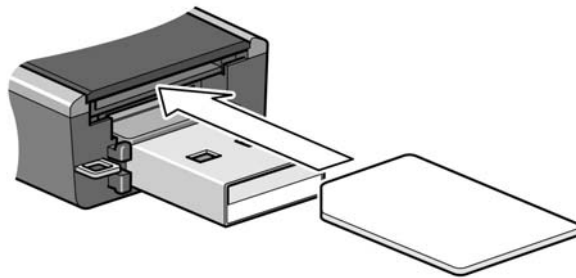

Insert the Compass USB modem into the USB slot

1. Gently insert the modem into the USB slot.

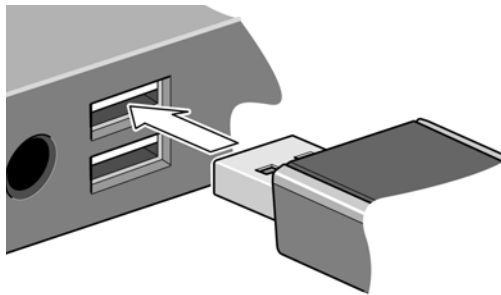

Note: If your computer's USB slot is vertical, use the supplied USB extension cable and notebook computer clip. See ["Using the extension cable and notebook computer clip"](#) on page 23.

Note: Do not forcefully insert the Compass USB modem as you may damage connector pins.

If the orientation of your computer's USB slot or the thickness of your computer are such that pressure is applied to the end or side of the modem, you may damage the modem or your computer. In such cases, do not insert the modem directly into your computer's USB slot; use the supplied USB extension cable and notebook computer clip instead.

Note: Do not insert the Compass USB modem or the USB extension cable into a USB hub or, if your keyboard is separate from your notebook computer, a USB slot on your keyboard.

The Compass USB modem comes with TRU-Install™, a Sierra Wireless feature that installs the necessary software the first time you insert the Compass USB modem into your computer. (You do not need an installation CD.)

2. The installation process starts automatically when you insert the modem.

If it does not, select **Start > Run** and type **d:\setup.exe** (where **d** is your TRU-Install CD-ROM drive letter¹).

3. Follow the on-screen instructions.
-

Note: Do not remove the modem until the software installation is complete. If you have inadvertently removed the modem too soon, see ["Reinstalling the software"](#) on page 29.

Connect to the network

To use your account (and connect to your service provider's network), you need to have at least one profile set up on your modem. Depending on how your modem is configured, the profile may already be set up or you may need to create one.

Scenario	Required action
Watcher automatically detects or creates a default profile.	Click Connect ^a .
Watcher prompts you to create a data profile.	1. Click Yes , then....

1. The drive appears as a CD-ROM drive, even though there is no physical CD required for installation.

Scenario	Required action
<ul style="list-style-type: none"> If Watcher opens the Options window Profile pane and pre-selects an appropriate profile (normally the name of your service provider) from the drop-down list... 	<ul style="list-style-type: none"> a. Click OK to accept that profile (or choose another from the drop-down list). b. Click Connect^a.
<ul style="list-style-type: none"> If Watcher opens the Options window Profile pane, the Profile name field is blank, and your service provider is not included in the drop-down list... 	<p>You need to create a profile manually. Refer to the Watcher online help for details.</p>

- a. The first time you insert the modem in the computer, it takes a few seconds for the modem to locate the network. While it is scanning for a network, the Connect button is unavailable.

Once the software is successfully installed and the profile is set up, the Compass USB modem is ready to use.

Anytime you use the Compass USB modem with the same computer, TRU-Install verifies that the correct software is already installed. This process takes a few seconds.

If you need to re-install the software, see [page 29](#).

For information on using Watcher, see [“Connection management software”](#) on page 25 or consult the Online Help that comes with Watcher (from the main window, select **Help > Help Topics**).

Attach the Compass USB modem to the lanyard

To keep everything together, thread the lanyard through the cap and the modem, as shown in the illustrations.

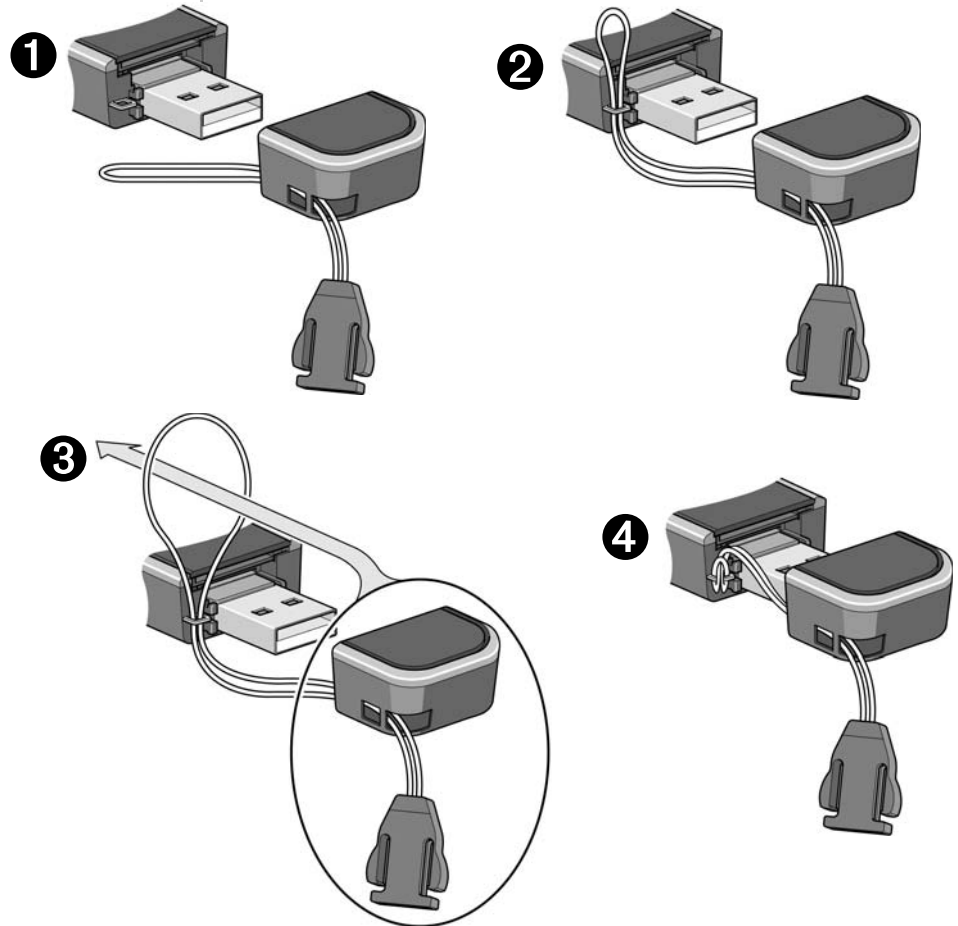

You can also attach the lanyard to the cap.

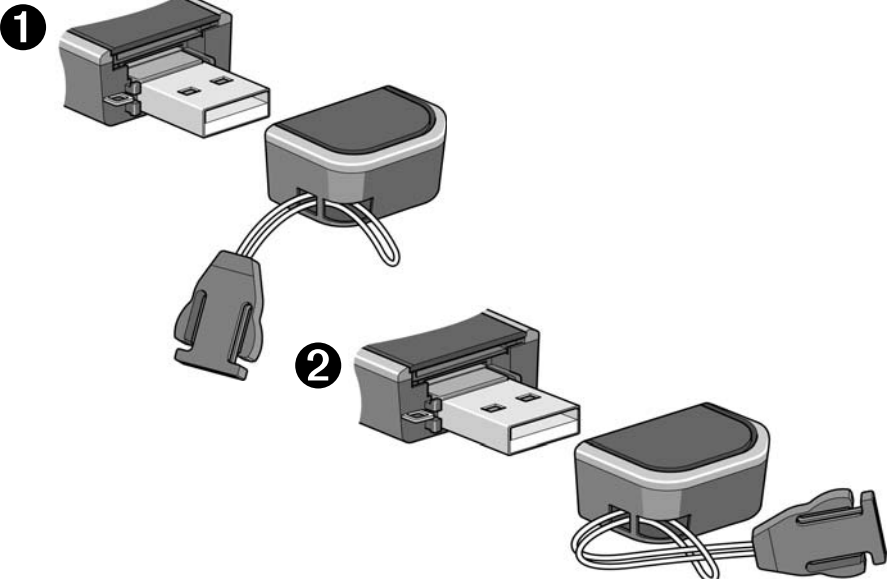

3: Using your Compass USB Modem

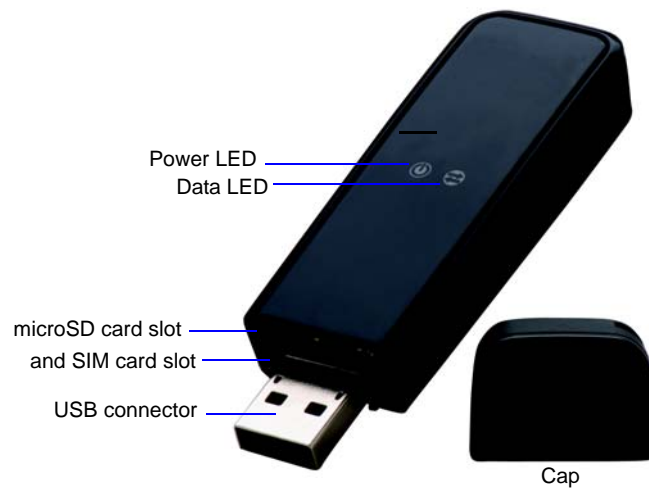

- Removing a SIM card
- Using the microSD card
- Connection management software

Your HSPA Compass USB modem has USB connector and slots for a SIM card and a microSD external storage card. LEDs on the front of the modem provide status information.



LEDs

The Compass USB modem has two LEDs that show the current status of the modem.

LED	State	Indicates
Power 	Off	Indicates one of the following states: <ul style="list-style-type: none"> • The modem is not inserted in the computer. • The computer is off or in “suspend and resume” mode. • The modem radio has been turned off using Watcher (Tools > Turn Radio Off) or another connection client.
	Solid Blue	The power is on, the modem is working normally.
	Blinking Blue	The firmware is being updated. Do not remove the modem from the computer.
	Blinking Amber	The modem is searching for service (initializing).
	Solid Amber	Modem error—either the modem is having a problem initializing (searching for service) or is offline because of a failure. Contact your service provider.
Data 	Off	The modem is unable to detect 2G or 3G service.
	Blinking Amber	The modem has detected a 2G network (EDGE, GPRS, GSM) and is ready to connect.
	Solid Amber	The modem is connected to a 2G network and is able to send and receive data.
	Blinking Blue	The modem has detected a 3G network (UMTS, HSPA) and is ready to connect.
	Solid Blue	The modem is connected to a 3G network and can send and receive data.

Removing a SIM card

Chapter 2 provides instructions for inserting the SIM. To remove the SIM card from the Compass USB modem:

1. Remove the cap.
2. Push the SIM card in and then release it.

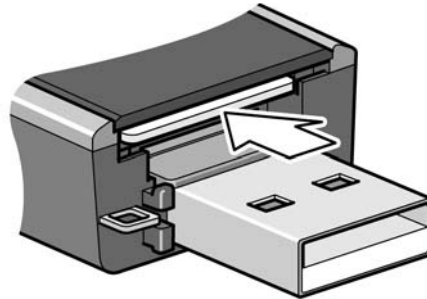

3. Remove the SIM card.

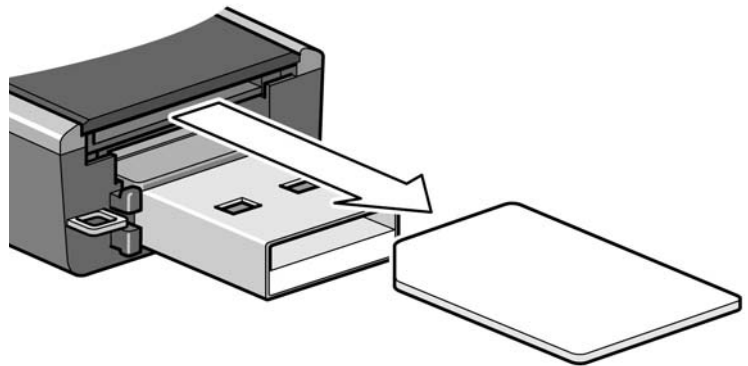

Using the microSD card

The Compass USB modem is built to accommodate a microSD external storage card.

To use a microSD card:

1. If there is a non-functional microSD card in the lower slot:
 - a. Press it in and then release it.
 - b. Gently remove the non-functional microSD card.
2. Insert the microSD card into the lower slot at the end of the modem, as shown in the illustration.

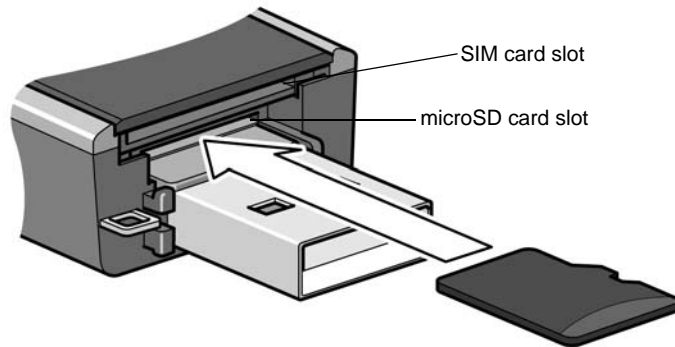

3. Insert the Compass USB modem into the computer's USB slot.

If the computer does not have Watcher installed, you may be given the option to install it. If you do not want to install Watcher, cancel the installation. You can use the microSD without having Watcher installed.

The microSD card appears as a USB memory drive. You can copy, paste, and drag files to and from it the same way as you can with any other external drive.

Removing the microSD card

Tip: To help conserve battery life, remove the microSD card when you are not using it.

To remove the microSD card:

1. Remove the cap.
2. Push the microSD card in and then release it.

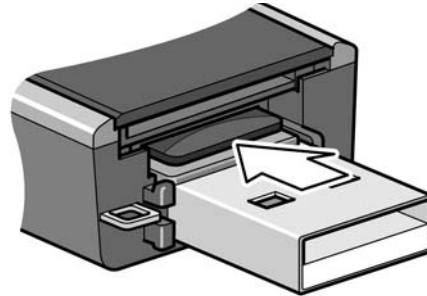

3. Gently pull the microSD card out.

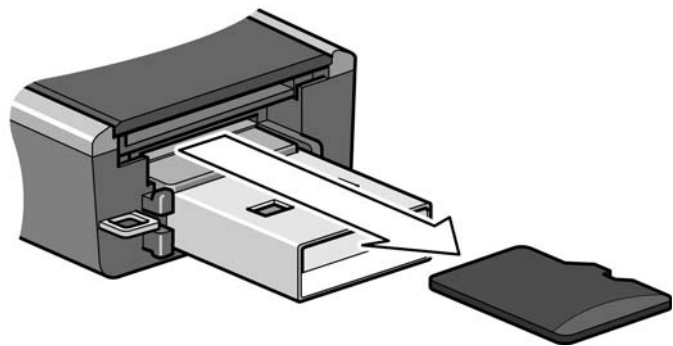

Using the extension cable and notebook computer clip

Your Compass USB modem comes with an extension cable and clip. The clip fits on the top of your notebook computer and holds your Compass USB modem.

Note: To meet FCC (regulatory) requirements, use only the supplied extension cable and notebook computer clip; other cables and notebook computer clips should not be used.

Note: Do not insert the Compass USB modem or the USB extension cable into a USB hub or, if your keyboard is separate from your notebook computer, a USB slot on your keyboard.

To use the extension cable and clip:

- 1.** Place the clip on top of the notebook computer.
- 2.** Connect the extension cable to the modem.
- 3.** Place the modem in the clip holder.
- 4.** Connect the other end of the extension cable to the USB slot on your computer.

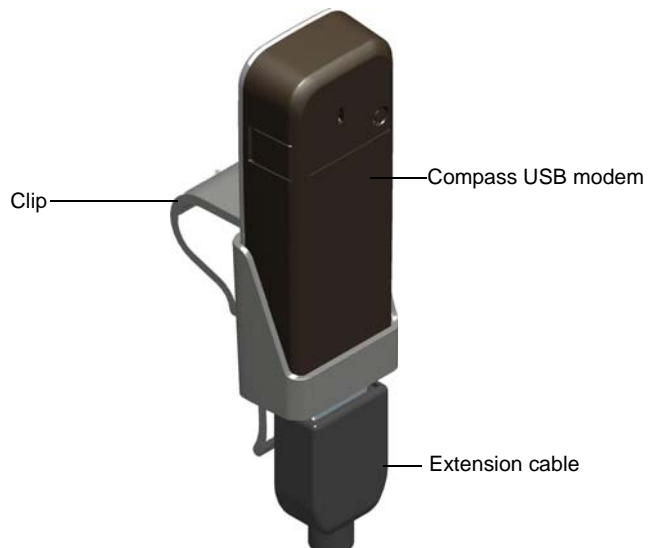

Note: Your clip may look slightly different from the one shown in the illustration.

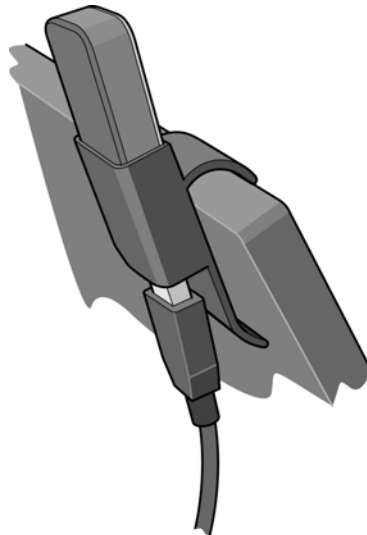

Connection management software

Your Compass USB modem comes with Sierra Wireless 3G Watcher or other connection management software, depending on your carrier.

Note: 3G Watcher is also compatible with earlier Sierra Wireless modems such as the AirCard 88xU USB modem, AirCard 88xE ExpressCard modem, and the AirCard 88x PC card modem.

3G Watcher enables you to:

- Initiate data connections
- Determine signal strength, roaming status, GPRS, EDGE, UMTS, or HSDPA/HSUPA availability, and other network connection parameters
- Monitor the status of the Compass USB modem and GSM service
- Send and receive SMS messages
- Enable or disable SIM security that prevents others from using your SIM card if it is lost or stolen
- Set options related to notifications and the 3G Watcher window
- Create or modify an account profile

You do not need to run 3G Watcher when you use the Compass USB modem, but 3G Watcher does provide useful status information.

Launching 3G Watcher

Unless this feature has been disabled, 3G Watcher launches automatically anytime you insert the Compass USB modem. You can also launch 3G Watcher by:







- Double-clicking the desktop shortcut , or
- Selecting **Start > Programs > Sierra Wireless > 3G Watcher > 3G Watcher**

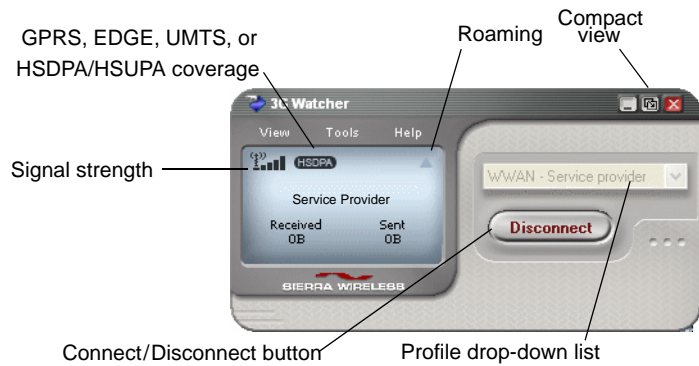



Depending on how your profile is configured, your browser, VPN, or other program may launch automatically anytime you launch 3G Watcher.

*Note: To view the online Help in 3G Watcher, select **Help > Help Topics**. You can also display help by pressing <F1>.*

The 3G Watcher window



	<p>Device status. If an icon of the Compass USB modem with an “X” is displayed, 3G Watcher is unable to detect the modem. This indicates that the modem is not fully inserted into the computer or the device is powered down.</p> <p>You may be able to resolve this problem by restarting 3G Watcher, stopping, removing, and reinserting the Compass USB modem, or restarting your computer.</p>
 	<p>Signal strength and service status. The number of bars beside the antenna increases as signal strength increases, to a maximum of five bars. The ToolTip that displays when you position the mouse pointer over this indicator shows the numeric value of the RSSI (Received Signal Strength Indication) in dBm.</p> <p>An antenna with a line through it indicates no service is available (Not in Service). You are outside of the coverage area or have insufficient signal strength to maintain a GSM data connection.</p>
<p>Coverage. The icon indicates the fastest service that is:</p> <ul style="list-style-type: none"> - Available in your current coverage area. - Supported by your Compass USB modem. 	
	<p>HSPA icon—concurrent HSDPA and HSUPA</p>
	<p>HSUPA icon—High-Speed Uplink Packet Access (HSUPA)</p>
	<p>HSDPA icon—High-Speed Downlink Packet Access (HSDPA)</p>





	<p>3G icon—Universal Mobile Telecommunications System (UMTS)</p>
	<p>EDGE icon—Enhanced Data rates for GSM Evolution (EDGE)</p>
	<p>GPRS icon—General Packet Radio Service (GPRS)</p>
<p>When only the letters are displayed, (for example EDGE), you are within the coverage area, but have not yet acquired the service.</p> <p>When the indicator has an outline (EDGE), you have acquired service and are able to establish a data connection.</p> <p>When the indicator is filled (EDGE), you have a data connection on the wireless service.</p>	
	<p>Roaming. You are connected to a network other than your local service provider's. There may be a surcharge for roaming service. (Support for roaming depends on your service provider.)</p>
	<p>New SMS message. Click the icon to open the SMS Express window and read your messages. When your SIM becomes full, this icon flashes and turns red.</p>

Indicators in 3G Watcher

Data transmission. When the modem is connected to the network, the main 3G Watcher window shows the amount of data received and sent.

Status icons

These icons appear in the system tray (usually in the lower right corner of your screen).

	<p>Watcher cannot detect the Compass USB modem. Ensure that the Compass USB modem is inserted properly and powered on.</p>
	<p>You do not have an active high-speed connection.</p>
	<p>You have an active high-speed connection.</p>
	<p>You have new (unread) SMS messages.</p>

Turning the radio on and off

This option allows you to conserve your computer's battery by turning off the Compass USB modem's radio transmitter/receiver when you are not using it.

To turn off the radio:

1. Select **Tools > Turn Radio Off**.

When the radio is turned off, the menu option switches to **Turn Radio On** and the message "Radio is off" is displayed in the 3G Watcher window.

To turn on the radio:

1. Select **Tools > Turn Radio On**.

Frequency band and network selection

3G Watcher has two options that affect your ability to obtain GPRS, EDGE, UMTS, or HSDPA/HSUPA service:

- The frequency band you want to use
- The network you want to use, if you are within the coverage area of more than one network

Frequency band selection

Every GSM network operates on one set of frequency bands. The Compass USB modem is designed to change frequency bands automatically to obtain network service. You can also change frequency bands manually from the **Network** tab of the User Options window (**Tools > Options > Network**).

*Note: Unless your service provider specifies otherwise, it is recommended that you use the **Automatic** setting.*

Network selection

This option is set in the **Network** pane of the User Options window (**Tools > Options > Network > Network Selection Mode**).

Depending on your location, you may be within the coverage area of several networks. Your ability to obtain service on each network depends on your account.

Your options for network selection are:

- **Automatic** — The Compass USB modem automatically selects a network based on your account and network availability.
- **Manual** — The Compass USB modem scans the area and displays a list of detected GSM networks.

If you select a network on which you cannot obtain service, the message, "Failed to register with network" appears. Choose a different network.

More information is available in the Watcher Online Help. From the main Watcher window, select **Help > Help Topics**.

Reinstalling the software

If you need to reinstall or repair the 3G Watcher software:

1. Open the **Control Panel**.
2. Double-click **TRU-Install**.
3. Follow the on-screen instructions.

Or, in Watcher:

1. Select **Tools > Software Installation Mode**.
2. Follow the on-screen instructions.

If you have canceled the software installation process or removed the modem from the computer before the software installation process was complete, you may receive error messages when you try to reinstall the software. If that happens:

1. Go to **Start > Control Panel > Add or Remove Programs** and remove **TRU-Install**.
2. Insert the modem into the computer.

Note: Do not remove the modem until the software installation process is complete.

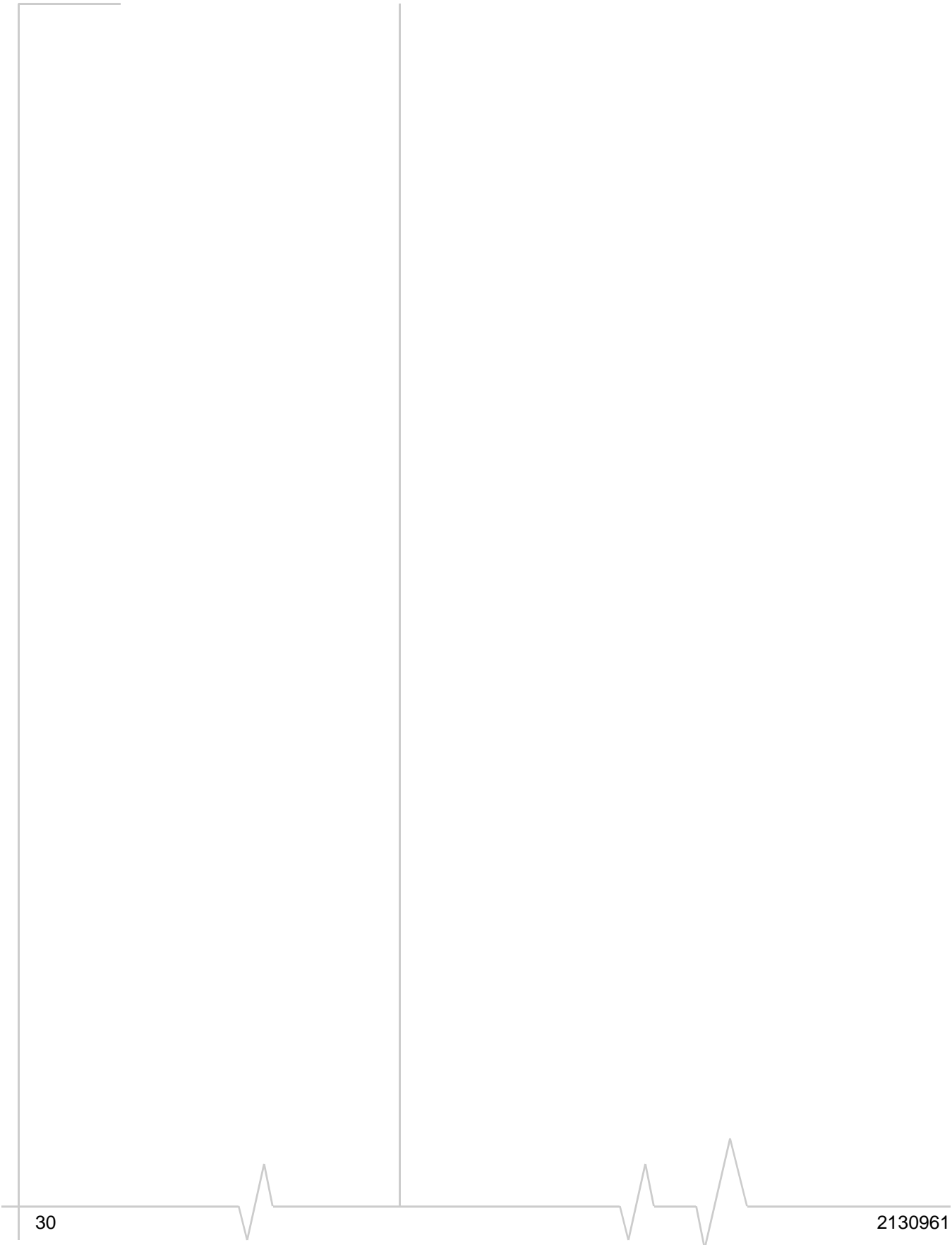

4: Care and Maintenance of Your Compass USB Modem

As with any electronic device, the Compass USB modem must be handled with care to ensure reliable operation. Follow these guidelines when you use and store your Compass USB modem:

- Do not apply adhesive labels to the SIM card. This may cause it to jam inside the slot, or prevent it from being inserted properly.
- When not installed in your computer, store the Compass USB modem and SIM card in a safe place.
- The Compass USB modem should fit easily into your computer's USB port. Forcing the Compass USB modem into the port may damage the connector pins.
- Protect the Compass USB modem from liquids, dust, and excessive heat. (See the "[Environmental specifications](#)" on page 34 for maximum tolerances.)

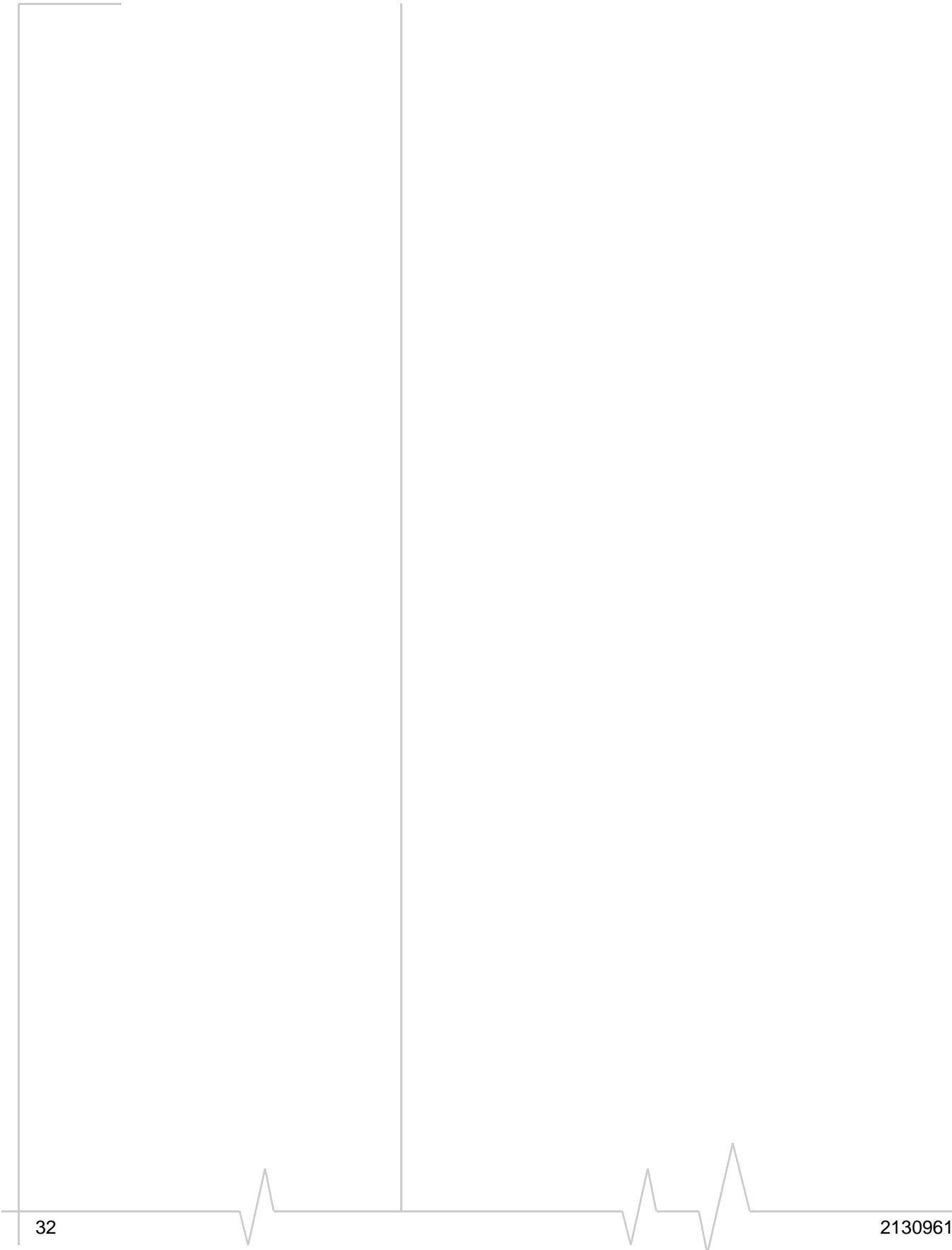

5: Technical Specifications

Radio frequency and electrical specifications

Table 5-1: Radio frequency and electrical specifications

Compliance	GSM Release 6
Transmit	GSM 1900 (PCS): 1850 to 1910 MHz GSM 1800 (DCS): 1710 to 1785 MHz EGSM 900: 880 to 915 MHz GSM 850: 824 to 849 MHz WCDMA 2100 (Band I): 1920 to 1980 MHz WCDMA 1900 (Band II): 1850 to 1910 MHz WCDMA 850 (Band V): 824 to 849 MHz WCDMA 800 (Band VI): 830 to 840 MHz
Receive	GSM 1900 (PCS): 1930 to 1990 MHz GSM 1800 (DCS): 1805 to 1880 MHz EGSM 900: 925 to 960 MHz GSM 850: 869 to 894 MHz WCDMA 2100 (Band I): 2110 to 2170 MHz WCDMA 1900 (Band II): 1930 to 1990 MHz WCDMA 850 (Band V): 869 to 894 MHz WCDMA 800 (Band VI): 875 to 885 MHz
Channel spacing	200 kHz (GSM) 5 MHz (WCDMA)
Channel raster	200 kHz
Frequency stability	0.1 ppm

Environmental specifications

Operating temperature	0°C to +50°C (+32°F to +122°F)
Storage temperature	-20°C to +85°C (-4°F to +185°F)
Humidity	85%, non-condensing
Vibration	Random vibration, 10 to 1000 Hz, nominal 6G RMS in each of 3 mutually perpendicular axes. Test duration of 60 minutes for each axis, for a total test time of 3 hours (non-operating).
Drop	1 m on concrete on each of 6 faces, 2 times

6: Regulatory and Safety Information

Notice

Because of the nature of wireless communications, transmission and reception of data can never be guaranteed. Data may be delayed, corrupted (that is, have errors), or be totally lost. Although significant delays or losses of data are rare when wireless devices such as the Sierra Wireless modem are used in a normal manner with a well-constructed network, the Sierra Wireless modem should not be used in situations where failure to transmit or receive data could result in damage of any kind to the user or any other party, including but not limited to personal injury, death, or loss of property. Sierra Wireless and its affiliates accept no responsibility for damages of any kind resulting from delays or errors in data transmitted or received using the Sierra Wireless modem, or for failure of the Sierra Wireless modem to transmit or receive such data.

Safety and hazards

The Compass USB modem **MUST BE POWERED OFF** in all areas that may be susceptible to radio interference, in particular:

- Prohibited areas
Obey all signs and notices and follow all rules and regulations. Power off the Compass 888 USB modem when instructed to do so or when you suspect that it may cause interference or danger.
- In areas where blasting is in progress
- Where explosive atmospheres may be present
Areas with a potentially explosive atmosphere are not always clearly marked. Such areas include gas stations, fuel depots, chemical transfer or storage facilities, areas where blasting is in progress, areas where the air contains chemicals or particles such as grain, dust, or metal powders, and any other area where you would normally be advised to turn off your cellular phone or vehicle engine.
- Near medical or life-support equipment
Medical equipment may be susceptible to any form of radio interference. In such areas the Compass 888 USB modem can transmit signals that could interfere with this equipment.

- On board aircraft

In addition to Federal Aviation Authority (FAA) requirements, many airline regulations state that you must suspend wireless operations before boarding an aircraft. The Compass 888 USB modem is capable of transmitting signals that could interfere with various onboard systems and controls.

Failure to observe this instruction may lead to suspension or denial of cellular telephone services to the offender, legal action, or both.

Some airlines may permit the use of cellular phones while the aircraft is on the ground and the door is open. The Compass 888 USB modem may be used normally at this time.

- While operating a vehicle

The driver or operator of any vehicle should not use a wireless data device while in control of a vehicle. Doing so detracts from the driver or operator's ability to control and operate the vehicle. In some countries, using such communications devices while in control of a vehicle is an offence.

Regulatory information for North America

CAUTION: Unauthorized modifications or changes not expressly approved by Sierra Wireless, Inc. could void compliance with regulatory rules, and thereby your authority to use this equipment.

The design of the Compass 888 USB modem complies with U.S. Federal Communications Commission (FCC) and Industry Canada (IC) guidelines respecting safety levels of radio frequency (RF) exposure for portable devices, which in turn are consistent with the following safety standards previously set by Canadian, U.S. and international standards bodies:

- ANSI/IEEE C95.1-1999, *IEEE Standard for Safety Levels with Respect to Human Exposure to Radio Frequency Electromagnetic Fields, 3kHz to 300 GHz*
- National Council on Radiation Protection and Measurements (NCRP) Report 86, -1986, *Biological Effects and Exposure Criteria for Radio Frequency Electromagnetic Fields*
- Health Canada, Safety Code 6, 1999, *Limits of Human Exposure to Radio frequency Electromagnetic Fields in the Frequency Range from 3 kHz to 300 GHz*

- International Commission on Non-Ionising Radiation Protection (ICNIRP) 1998, *Guidelines for limiting exposure to time-varying electric, magnetic, and electromagnetic fields (up to 300 GHz)*

Caution: *The Compass 888 USB modem must be 1.0 cm or more from users during operation, to satisfy FCC /IC RF exposure requirements. The Compass 888 USB modem has been tested for compliance with FCC / IC RF exposure limits in the notebook computer(s) configurations with horizontal and vertical USB slots and can be used in notebook computers with substantially similar physical dimensions, construction, and electrical and RF characteristics. This USB modem must not be used with any other antenna or transmitter that has not been approved to operate in conjunction with this modem. Note: This USB modem must not be used in any unapproved configurations. For details, contact Sierra Wireless.*

Note: The Compass 888 USB modem is approved for normal-size notebook computers only (typically with 12 inches or larger display screens). For notebook computers with a display screen smaller than 12 inches or if the orientation of the USB slot does not allow for at least 1.0 cm between the modem and the user or bystanders, use the provided extension cable and clip to ensure a safe distance between the modem antenna and users or bystanders.

To meet FCC requirements, use only the supplied USB extension cable and laptop clip; other cables and laptop clips should not be used.

These devices comply with Part 15 of the FCC Rules. Operation is subject to the condition that these devices do not cause harmful interference.

Where appropriate, the use of the equipment is subject to the following conditions:

Warning: (EMI) – *United States FCC Information – This equipment has been tested and found to comply with the limits pursuant to Part 15 of the FCC Rules. These limits are designed to provide reasonable protection against harmful interference in an appropriate installation. This equipment generates, uses, and can radiate radio frequency energy and, if not installed and used in accordance with the instructions, may cause harmful inter-*

ference to radio communication. However, there is no guarantee that interference will not occur in a particular installation.

If this equipment does cause harmful interference to radio or television reception, which can be determined by turning the equipment off and on, the user is encouraged to try to correct the interference by one or more of the following measures:

- Increase the separation between the equipment and receiver
- Connect the equipment into an outlet on a circuit different from that to which the receiver is connected
- Consult the dealer or an experienced radio/TV technician for help

If you have purchased this product under a United States Government contract, it shall be subject to restrictions as set forth in subparagraph (c)(1)(ii) of Defense Federal Acquisitions Regulations (DFARs) Section 252.227-7013 for Department of Defense contracts, and as set forth in Federal Acquisitions Regulations (FARs) Section 52.227-19 for civilian agency contracts or any successor regulations. If further government regulations apply, it is your responsibility to ensure compliance with such regulations.

Regulatory information for EU countries

Sierra Wireless hereby declares that the Compass 888 USB wireless modem conforms to all the essential requirements of Directive 1999/5/EC:

CE 0682

The Declaration of Conformity made under Directive 1999/5/EC is available for viewing at the following location in the EU community:

Sierra Wireless (UK), Limited
Lakeside House
1 Furzeground Way, Stockley Park East
Uxbridge, Middlesex
UB11 1BD
England

»» | Index

Numerics

3G Watcher
introduction, 25
launching, 25

A

account, 10
antenna
icon, 26

C

channel raster, 33
channel spacing, 33
clip, 23
Compass USB modem, inserting, 14
connect to the network, 15
coverage, 27
coverage area, 10

D

data transmission, 27
device not available, 26
device not responding, 26
driver, 11

E

EDGE
connection status, 27
indicator, 27
electrical specifications, 33
envelope icon
main window, 27
system tray, 27
environmental specifications, 34
error messages, 29
extension cable, 23
external memory storage, 9, 22
external SD, 9, 22
external storage card, 22

F

flash drive, 22
frequencies
receive, 33
transmit, 33

frequency stability, 33

G

GPRS
connection status, 27
indicator, 27

H

HSDPA
connection status, 26
indicator, 26
HSDPA / HSUPA connection status, 26
HSDPA / HSUPA indicator, 26
HSPA connection, 26
HSUPA connection status, 26
HSUPA indicator, 26
humidity, 34

I

I/O space (input/output space), 13
icon
antenna, 26
device status, 26
roaming, 27
signal strength, 26
SMS message, 27
indicator
device status, 26
EDGE coverage, 27
GPRS coverage, 27
HSDPA / HSUPA coverage, 26
HSDPA coverage, 26
HSUPA coverage, 26
roaming, 27
signal strength, 26
SMS message, 27
status, 27
UMTS coverage, 27
installing, error messages, 29
IRQ (interrupt request), 13

L

lanyard, 17
launching 3G Watcher, 25
LEDs, 20

M

Macintosh OSX support, 13
memory card, 9
memory required, 13
micro external memory card, 22
microSD, 9, 22
modem, inserting, 14

N

network
 overview, 10
 selection, 28
notebook computer clip, 23

O

online help, 26
operating systems supported, 13

P

power options, power up/down, 28
profile, 13, 15

R

radio frequency specifications, 33
receive frequencies, 33
regulatory information, 35
requirements, software, 13
RF specifications, 33
roaming, 10
roaming indicator, 27
RSSI, 26

S

safety notice, 35
service, 26
 HSDPA, 26
 UMTS, 27
signal strength indicator, 26
SIM card
 inserting, 14
 removing, 21
SMS messages
 indicator, 27
 status, 27
software installation, 15
software requirements, 13
specifications, 33–34
 electrical, 33
 environmental, 34
 radio frequency, 33

status

concurrent HSDPA / HSUPA service, 26
connection, 27
data transmission, 27
device, 26
EDGE connection, 27
EDGE service, 27
GPRS connection, 27
GPRS service, 27
HSDPA / HSUPA, 26
HSDPA connection, 26
HSDPA service, 26
HSUPA connection, 26
HSUPA service, 26
roaming, 27
signal strength, 26
SMS messages, 27, 27
system tray icons, 27
UMTS connection, 27
UMTS service, 27

storage

temperature, 34
when not using card, 31
system requirements, 13
system tray icons, 27

T

technical specifications, 33–34
temperature, 34
transmit frequencies, 33
triangle icon, 27
TRU-Install, 9, 15, 15

U

UMTS connection status, 27
UMTS indicator, 27
USB port requirements, 13

V

vibration, 34

W

Watcher
 icons and indicators, 27
 main window, 26
Watcher, description, 11
Windows 2000 support, 13
Windows Vista support, 13
Windows XP support, 13

