



# Sierra Wireless USB Modem

## User Guide

2131232  
Rev 1.0



## Important Notice

Due to the nature of wireless communications, transmission and reception of data can never be guaranteed. Data may be delayed, corrupted (that is, have errors) or be totally lost. Although significant delays or losses of data are rare when wireless devices such as the Sierra Wireless modem are used in a normal manner with a well-constructed network, the Sierra Wireless modem should not be used in situations where failure to transmit or receive data could result in damage of any kind to the user or any other party, including but not limited to personal injury, death, or loss of property. Sierra Wireless accepts no responsibility for damages of any kind resulting from delays or errors in data transmitted or received using the Sierra Wireless modem, or for failure of the Sierra Wireless modem to transmit or receive such data.

## Safety and Hazards

Do not operate the Sierra Wireless modem in areas where blasting is in progress, where explosive atmospheres may be present, near medical equipment, near life support equipment, or any equipment which may be susceptible to any form of radio interference. In such areas, the Sierra Wireless modem **MUST BE POWERED OFF**. The Sierra Wireless modem can transmit signals that could interfere with this equipment.

Do not operate the Sierra Wireless modem in any aircraft, whether the aircraft is on the ground or in flight. In aircraft, the Sierra Wireless modem **MUST BE POWERED OFF**. When operating, the Sierra Wireless modem can transmit signals that could interfere with various onboard systems.

---

*Note: Some airlines may permit the use of cellular phones while the aircraft is on the ground and the door is open. Sierra Wireless modems may be used at this time.*

---

The driver or operator of any vehicle should not operate the Sierra Wireless modem while in control of a vehicle. Doing so will detract from the driver or operator's control and operation of that vehicle. In some states and provinces, operating such communications devices while in control of a vehicle is an offence.

## Limitation of Liability

The information in this manual is subject to change without notice and does not represent a commitment on the part of Sierra Wireless. SIERRA WIRELESS AND ITS AFFILIATES SPECIFICALLY DISCLAIM LIABILITY FOR ANY AND ALL DIRECT, INDIRECT, SPECIAL, GENERAL, INCIDENTAL, CONSEQUENTIAL, PUNITIVE OR EXEMPLARY DAMAGES INCLUDING, BUT NOT LIMITED TO, LOSS OF PROFITS OR

REVENUE OR ANTICIPATED PROFITS OR REVENUE ARISING OUT OF THE USE OR INABILITY TO USE ANY SIERRA WIRELESS PRODUCT, EVEN IF SIERRA WIRELESS AND/OR ITS AFFILIATES HAS BEEN ADVISED OF THE POSSIBILITY OF SUCH DAMAGES OR THEY ARE FORESEEABLE OR FOR CLAIMS BY ANY THIRD PARTY.

Notwithstanding the foregoing, in no event shall Sierra Wireless and/or its affiliates aggregate liability arising under or in connection with the Sierra Wireless product, regardless of the number of events, occurrences, or claims giving rise to liability, be in excess of the price paid by the purchaser for the Sierra Wireless product.

## Patents

Portions of this product may be covered by some or all of the following US patents:

5,515,013	5,629,960	5,845,216	5,847,553	5,878,234
5,890,057	5,929,815	6,169,884	6,191,741	6,199,168
6,339,405	6,359,591	6,400,336	6,516,204	6,561,851
6,643,501	6,653,979	6,697,030	6,785,830	6,845,249
6,847,830	6,876,697	6,879,585	6,886,049	6,968,171
6,985,757	7,023,878	7,053,843	7,106,569	7,145,267
7,200,512	7,295,171	7,287,162	D442,170	D459,303
D599,256	D560,911			

and other patents pending.

This product includes

technology licensed from:

QUALCOMM® 3G

Manufactured or sold by Sierra Wireless or its licensees under one or more patents licensed from InterDigital Group.

## Copyright

© 2009 Sierra Wireless. All rights reserved.

## Trademarks

“Heart of the Wireless Machine®” is a registered trademark of Sierra Wireless. Watcher® is a trademark of Sierra Wireless, registered in the European Community.

Sierra Wireless, the Sierra Wireless logo, the red wave design, the red-tipped antenna, and TRU-Install are trademarks of Sierra Wireless.

Windows® is a registered trademark of Microsoft Corporation.

Windows Vista® is a registered trademark of Microsoft Corporation.

QUALCOMM® is a registered trademark of QUALCOMM Incorporated. Used under license.

Macintosh® is a trademark of Apple Inc., registered in the U.S. and other countries.

## Contact Information

Other trademarks are the property of the respective owners.

Sales Desk:	Phone:	1-604-232-1488
	Hours:	8:00 AM to 5:00 PM Pacific Time
	E-mail:	<a href="mailto:sales@sierrawireless.com">sales@sierrawireless.com</a>
Post:	Sierra Wireless 13811 Wireless Way Richmond, BC Canada V6V 3A4	
Fax:	1-604-231-1109	
Web:	<a href="http://www.sierrawireless.com">www.sierrawireless.com</a>	

Consult our Web site for up-to-date product descriptions, documentation, application notes, firmware upgrades, troubleshooting tips, and press releases:

[www.sierrawireless.com](http://www.sierrawireless.com)

## Revision History

Revision number	Release date	Changes
1.0	June 2008	New document

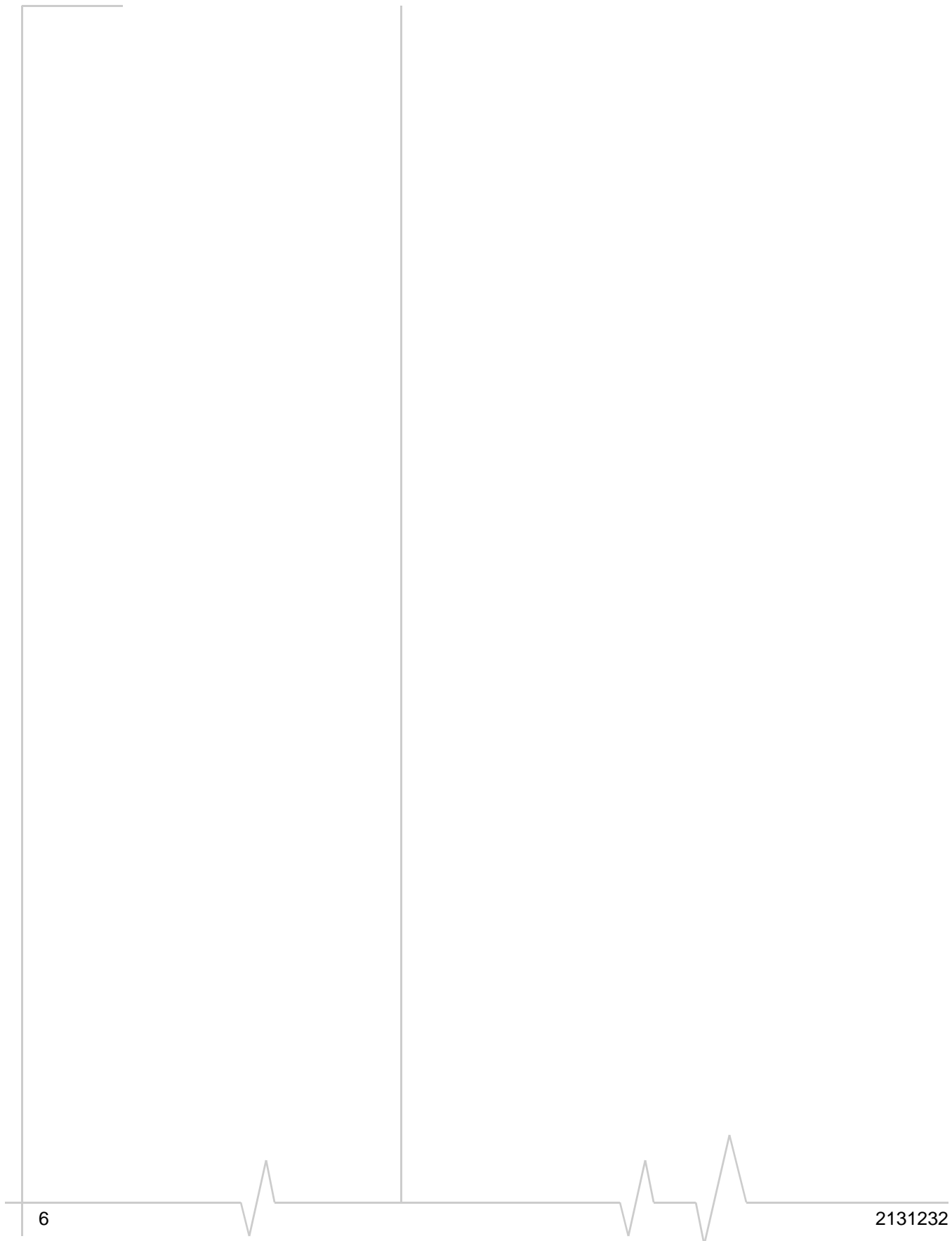

# >> Contents

<b>Introducing the Sierra Wireless USB Modem</b> .....	<b>9</b>
About the USB modems .....	9
Services supported .....	9
Your account and coverage area .....	10
Modem software .....	11
Frequency band support .....	11
<b>Getting Started</b> .....	<b>13</b>
Overview of installation steps .....	13
System requirements .....	13
Inserting the SIM card .....	14
Insert the modem into the computer .....	15
Installing the software .....	16
Windows Operating System .....	16
Mac OS X .....	17
Attach the modem to the lanyard .....	18
<b>Using your USB Modem</b> .....	<b>19</b>
USB modem features .....	19
LED operation .....	20
Using the microSD card (some models only) .....	21
Removing the microSD card .....	22
Removing the SIM card .....	23
Using the extension cable and clip .....	23
Connection management software .....	24
Launching Watcher .....	25
Turning the radio on and off .....	25
Frequency band and network selection .....	25

Reinstalling the software (Windows)..... 27

**Care and Maintenance of Your USB Modem .....29**

**Technical Specifications .....31**

    Radio frequency and electrical specifications ..... 31

    Environmental specifications ..... 32

**Regulatory and Safety Information .....33**

    Notice ..... 33

        Safety and hazards ..... 33

    Regulatory information for North America ..... 34

    Regulatory information for EU countries..... 36

**Index..... 37**



# 1: Introducing the Sierra Wireless USB Modem

- Services supported
- Your account and coverage area
- Modem software
- Frequency band support

## About the USB modems

Sierra Wireless USB wireless modems enable you to connect to the Internet, send and receive email, connect to a corporate network or virtual private network (VPN), or view streaming video, without the need for a cable.

The USB modems connect to a Type A USB port on your computer.

The modems are TRU-Install™ enabled. All the required software is on the modem. When you set up your modem, the software is installed on your computer. You do not need an installation CD.

The modems have a built-in antenna and may have a slot that accommodates a microSD external memory card. Depending on your service provider, a microSD™ card may be included in your package, or you may need to purchase it separately.

## Services supported

Depending on the model, your modem supports speeds of up to 21 Mbps (Megabits per second). However, actual speed depends on the services offered by your service provider. Contact your service provider and visit [www.sierrawireless.com](http://www.sierrawireless.com) for details.

Maximum theoretical data speeds are:

- Evolved High Speed Packet Access (Evolved HSPA or HSPA+)— up to 21 Mbps
- High Speed Download Packet Access (HSDPA) — up to 7.2 Mbps
- High Speed Upload Packet Access (HSUPA) — up to 5.76 Mbps
- Concurrent HSDPA/HSUPA (HSPA) — up to 3.6 Mbps download and up to 1.5 Mbps upload

- Universal Mobile Telecommunications System (UMTS) – 384 kbps (kilobits per second)
- Enhanced Data rates for GSM Evolution (EDGE) – 236 kbps
- General Packet Radio Service (GPRS) – 56 kbps

GPRS and EDGE are second generation (2G) data services. UMTS, HSDPA/HSUPA, and HSPA+ are 3G data services.

When establishing a connection, your modem uses the fastest available service. If, for example, you are using the modem in an area that has EDGE service but not UMTS or HSDPA/HSUPA service, the modem connects using EDGE service.

Once the connection is established, you have access to all Internet services.

## Your account and coverage area

---

*Note: If you purchased the modem from a GSM service provider, you may already have an account and a SIM card. Otherwise, your retailer should be able to give you the names of companies that provide these items.*

---

You must have an account with a GSM service provider to use the modem. To use the modem's 3G capability, your account must be with a service provider that offers HSPA, HSPA+ or UMTS service. (The modem is backwards compatible with 2G service.)

When you obtain your account, you are given a Subscriber Identity Module (SIM) card containing account information. Before you use the modem, you must insert the SIM card into it.

Your ability to obtain service depends on these factors:

- **Network coverage** – You must be within the network coverage area.
- **Service provider** – If you are within the coverage area of a network that is not operated by your own service provider, you can obtain service only if there is a roaming agreement between your service provider and the network operator.
- **Account provisions** – Your account may restrict your usage to certain networks or limit the amount of time you can use the network.
- **Frequency band** – You cannot connect to networks operating in bands not supported by your modem, regardless of roaming agreements or account provisions.

Most service providers have coverage maps on their Web sites.

## Modem software

The modem comes with connection management software. Depending on your carrier, it may come with carrier-specific software or the following software made by Sierra Wireless:

- Sierra Wireless Watcher<sup>®</sup> for Windows or 3G Watcher for Mac<sup>®</sup>. Use this software to manage the modem and monitor your connections.
- Driver software that forms the interface between the modem and your Windows operating system

For information on Watcher features and using Watcher, see [“Connection management software”](#) on page 24.

## Frequency band support

Frequency bands supported by the modem:

Technology	Bands	Location
<b>2G</b>	850 MHz (cellular band)	North America
	900 MHz (EGSM band)	Europe
	1800 MHz (DCS band)	Europe and Asia
	1900 MHz (PCS band)	North America
<b>3G</b>	WCDMA 850 (band V)	North America and Australia
	WCDMA 1900 (band II)	North America
	WCDMA 2100 (band I)	Europe, Asia, and Australia

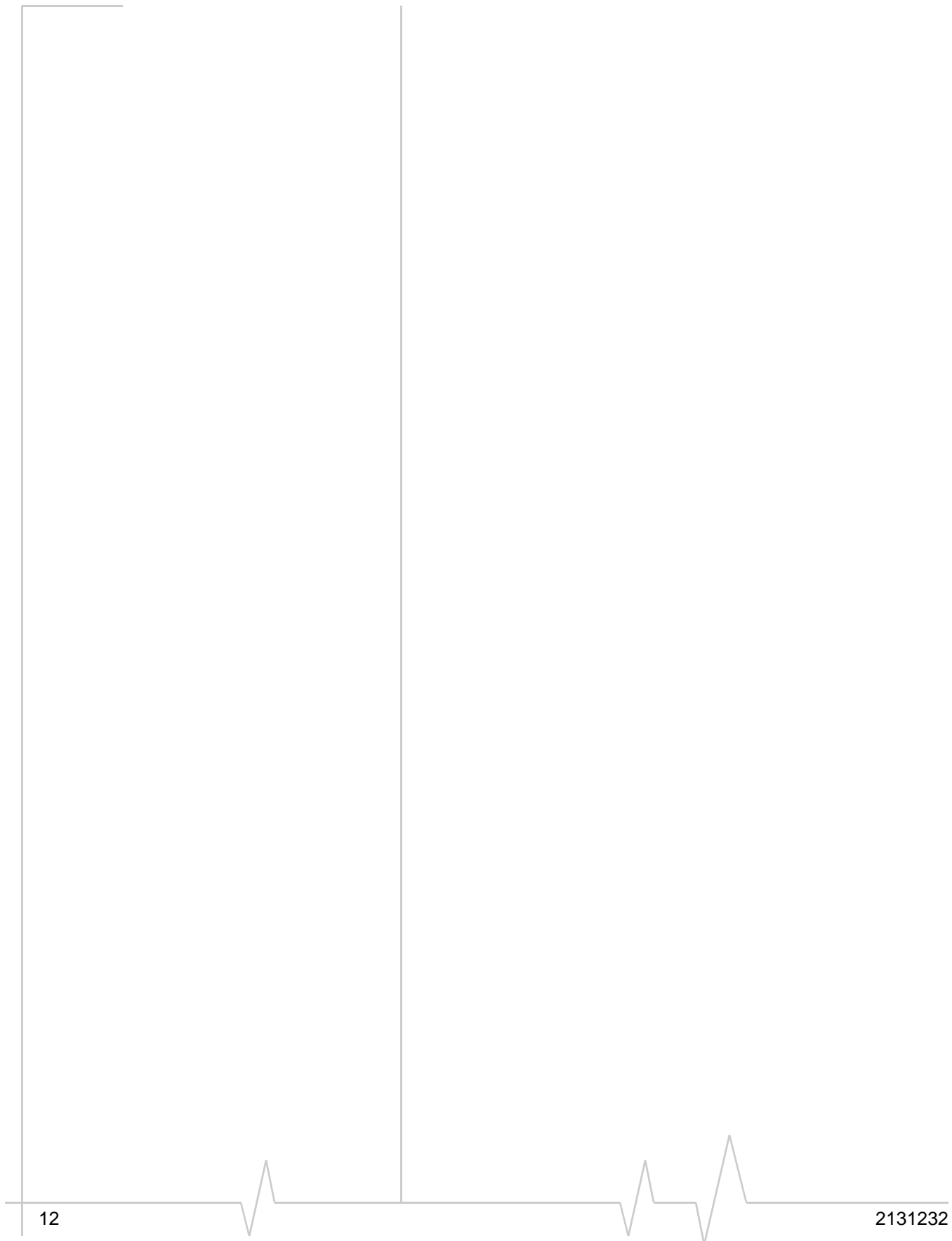

## >> 2: Getting Started

---

*Note: Keep a written record in a secure place of the account information that your service provider gives you.*

---

Follow the instructions in this chapter to set up and start using your modem.

To use your modem, you'll need:

- An account with a service provider
- A SIM card (supplied by the service provider)
- A profile, which may be:
  - Already stored on your modem when you purchase it
  - Set up automatically
  - Selected from a drop-down list
  - Created manually

### Overview of installation steps

1. Check the system requirements.
2. Insert the SIM card into the modem.
3. Insert the modem into your computer. (The necessary software is installed and either the profile is set up automatically or Watcher prompts you to create a profile.)

### System requirements

The modem is supported on:

- Windows Vista®
- Windows XP (Home and Professional versions)
- Mac® OS X 10.4.11 or later

To install a USB-connected modem, your computer requires the following:

USB port	1 USB Type A slot (USB 1.1 or 2.0)
Memory	32 MB

---

*Note: If you are running Mac OS X, please refer to the **Watcher Quick Start Guide for Mac OS X** found at [www.sierrawireless.com/mac](http://www.sierrawireless.com/mac).*

---

---

*Note: To prevent the SIM card from becoming jammed in its slot, ensure the edge of the card is smooth before inserting it. Do not attach labels to your SIM card as this may also cause it to jam.*

---

## Inserting the SIM card

1. If your SIM card is attached to a larger card, detach the SIM card and remove any fragments stuck to it.
2. Remove the end cap. The SIM card slot is the uppermost slot above the USB connector<sup>1</sup>. See [Figure 2-1](#).
3. Insert the SIM card. Depending on the model, your modem may or may not have a SIM tray.

If there is no SIM tray:

- a. Gently push the SIM card into the slot until the card will not go in any further.

When it is properly inserted, the outer edge of the SIM card is in line with the edge of the housing.

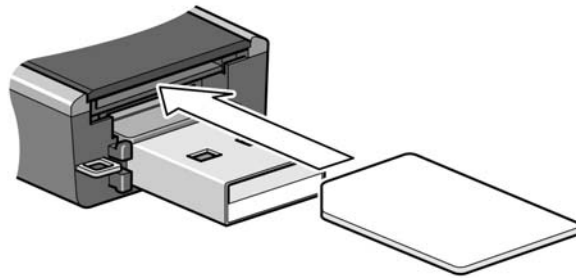
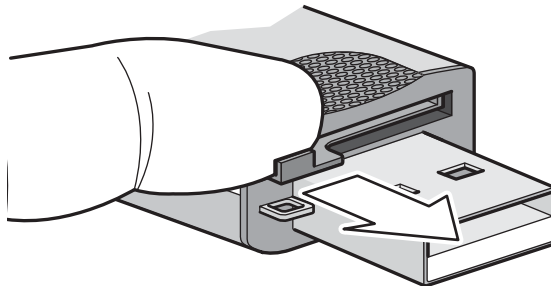

Figure 2-1: Inserting the SIM card into a USB modem

If there is a SIM tray:

- a. Gently slide open the SIM card tray, but do not remove it entirely.<sup>2</sup>



---

1. Depending on your model, some modems may have only one slot or the SIM slot may be on the side of the modem.  
2. If you inadvertently remove the tray entirely, reinsert it into the modem.

- b.** Place the SIM card on the tray, as shown in the following illustration.

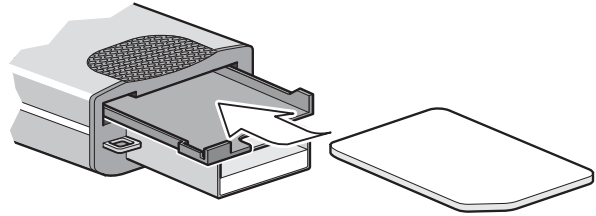

- c.** Close the SIM tray.

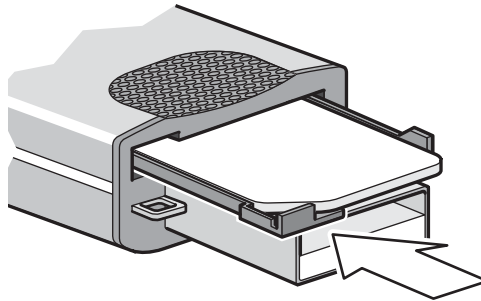

---

*Note: For instructions on removing the SIM card, see [page 23](#).*

---

## Insert the modem into the computer

- 1.** Gently insert the modem into the USB slot.

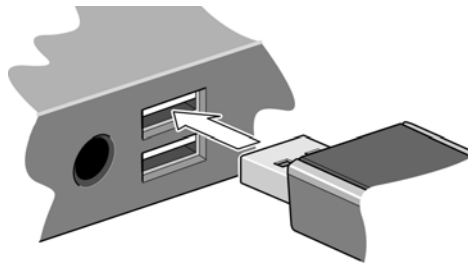

---

*Note: If the orientation of your computer's USB slot or the thickness of your computer are such that pressure is applied to the end or side of the modem, you may damage the modem or your computer. In such cases, do not insert the modem directly into your computer's USB slot; use the USB extension cable and notebook computer clip instead. See "[Using the extension cable and clip](#)" on page 23.*

---

*Note: Do not forcefully insert the modem as you may damage connector pins.*

*Note: Do not insert the modem or the USB extension cable into a USB hub or, if your keyboard is separate from your notebook computer, a USB slot on your keyboard.*

## Installing the software

The modem comes with TRU-Install™, a Sierra Wireless feature that installs the necessary software the first time you insert the modem into your computer. (You do not need an installation CD.)

The installation process starts automatically when you insert the modem. Follow the on-screen instructions for installing the software.

## Windows Operating System<sup>1</sup>

If the installation process does not start automatically:

1. Double-click **My Computer** (Windows XP) or **Computer** (Windows Vista) on your desktop.
2. Click the **TRU-Install** drive.
3. Under the TRU-Install drive, go to the **Win** folder and double-click the **Setup.exe** file.
4. Follow the on-screen instructions for installing the software.

*Note: Do not remove the modem until the software installation is complete. If you have inadvertently removed the modem too soon, see “Reinstalling the software (Windows)” on page 27.*

## Connect to the network

To use your account (and connect to your service provider’s network), you need to have at least one profile set up on your modem. Depending on how your modem is configured, the profile may already be set up or you may need to create one.

Scenario	Required action
Watcher automatically detects or creates a default profile.	Click <b>Connect</b> <sup>a</sup> .
Watcher prompts you to create a data profile.	1. Click <b>Yes</b> , then....

1. If you are using a Mac computer, see page 17.



Scenario	Required action
<ul style="list-style-type: none"> <li>If Watcher opens the Options window Profile pane and pre-selects an appropriate profile (normally the name of your service provider) from the drop-down list...</li> </ul>	<ol style="list-style-type: none"> <li>Click <b>OK</b> to accept that profile (or choose another from the drop-down list).</li> <li>Click <b>Connect</b><sup>a</sup>.</li> </ol>
<ul style="list-style-type: none"> <li>If Watcher opens the Options window Profile pane, the Profile name field is blank, and your service provider is not included in the drop-down list...</li> </ul>	<p>You need to create a profile manually. Refer to the Watcher online help for details.</p>

- The first time you insert the modem in the computer, it takes a few seconds for the modem to locate the network. While it is scanning for a network, the Connect button is unavailable.

Once the software is successfully installed and the profile is set up, the modem is ready to use.

Anytime you use the modem with the same computer, TRU-Install verifies that the correct software is already installed. This process takes a few seconds.

If you need to re-install the software, see [page 27](#).

For information on using Watcher, see “[Connection management software](#)” on page 24 or view the Online Help that comes with Watcher.

## Mac OS X

- After inserting the modem, double-click the installer package.

If you do not see the installer package:

- Open Finder.
  - Under **Devices**, click **TRU-Install**.
  - Double click the installer package.
- Follow the on-screen instructions.
  - Restart our computer when prompted.

### Connect to the network

Once the software is successfully installed, the modem is ready to use.

- Click the **Connect** button to connect to the network.

## Attach the modem to the lanyard

To keep everything together, thread the lanyard through the cap and the modem, as shown in the illustrations.

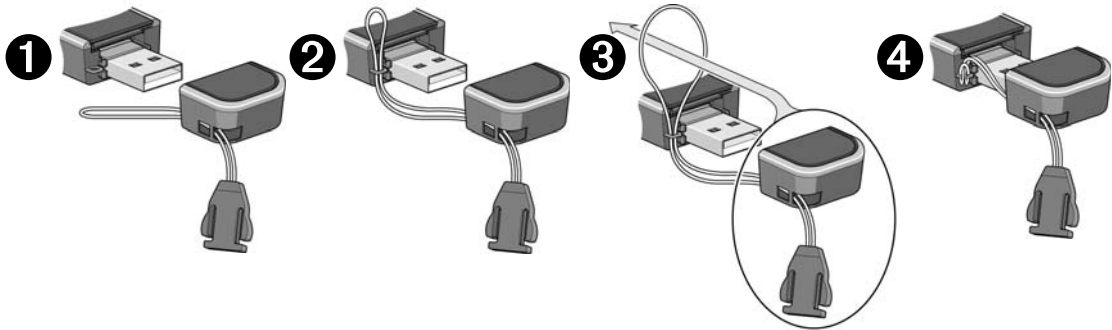

You can also attach the lanyard to the cap.

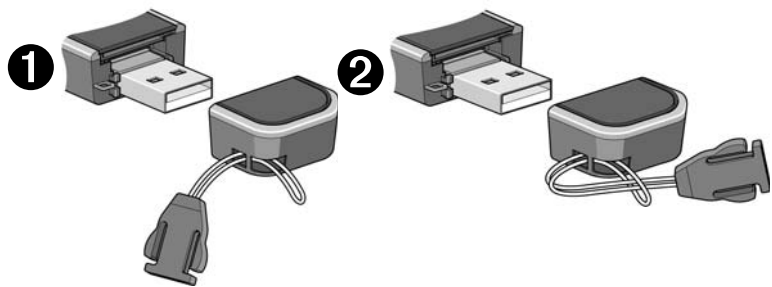

## 3: Using your USB Modem

- USB modem LED operation
- Using the microSD card (some models only)
- Using the extension cable and clip
- Connection management software

### USB modem features

USB modems have a USB connector and slots for a SIM card and a microSD external storage card. LEDs on the front of the modem provide status information.

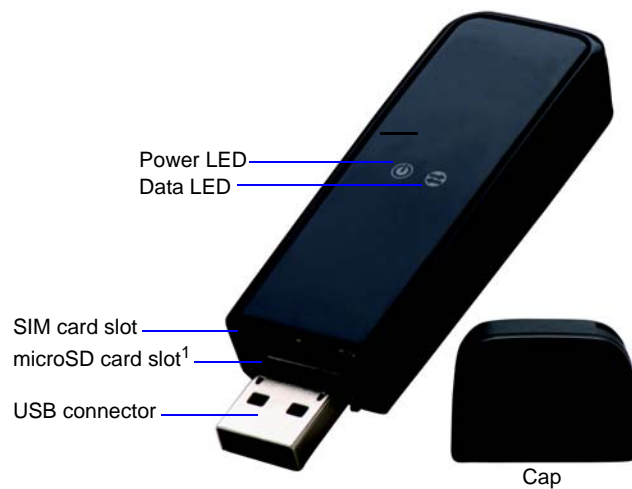



---

*Note: 1. Depending on the modem, the microSD card slot may be on the side of the modem.*

---

## LED operation

The USB modem has two LEDs that show the current status of the modem.

LED	State	Indicates
<b>Power</b> 	Off	Indicates one of the following states: <ul style="list-style-type: none"> <li>The modem is not inserted in the computer.</li> <li>The computer is off or in “suspend and resume” mode.</li> <li>The modem radio has been turned off using Watcher (see <a href="#">“Turning the radio on and off”</a> on page 25) or another connection client.</li> </ul>
	Solid Blue	The power is on, the modem is working normally.
	Blinking Blue	The firmware is being updated. Do not remove the modem from the computer.
	Blinking Amber	The modem is searching for service (initializing).
	Solid Amber	Modem error—either the modem is having a problem initializing (searching for service) or is offline because of a failure. Contact your service provider.
<b>Data</b> 	Off	The modem is unable to detect 2G or 3G service.
	Blinking Amber	The modem has detected a 2G network (EDGE, GPRS, GSM) and is ready to connect.
	Solid Amber	The modem is connected to a 2G network and is able to send and receive data.
	Blinking Blue	The modem has detected a 3G network (UMTS, HSPA, HSPA+) and is ready to connect.
	Solid Blue	The modem is connected to a 3G network and can send and receive data.

## Using the microSD card (some models only)

Some Sierra Wireless modems can accommodate a microSD external storage card.

To use a microSD card:

1. If there is a non-functional microSD card in the lower slot:
  - a. Press it in and then release it.
  - b. Gently remove the non-functional microSD card.
2. Insert the microSD card into the lower slot at the end of the modem, as shown in the illustration.

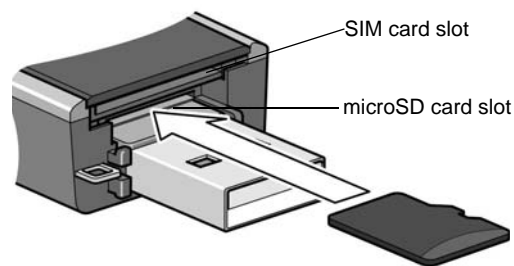

Or if the microSD slot is on the side of the modem:

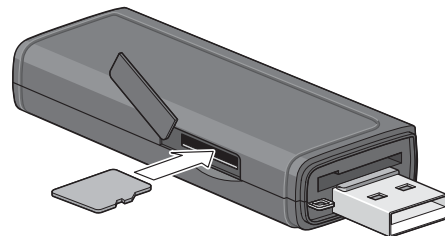

3. Insert the modem into the computer.
 

If the computer does not have Watcher installed, you may be given the option to install it. If you do not want to install Watcher, cancel the installation. You can use the microSD card without having Watcher installed.

The microSD card appears as a USB memory drive. You can copy, paste, and drag files to and from it the same way as you can with any other external drive.

## Removing the microSD card

To remove the microSD card:

### If the microSD slot is in the end of the modem:

1. Remove the cap.
2. Push the microSD card in and then release it.

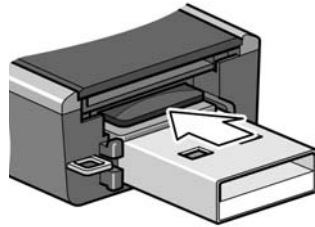

3. Gently pull the microSD card out.

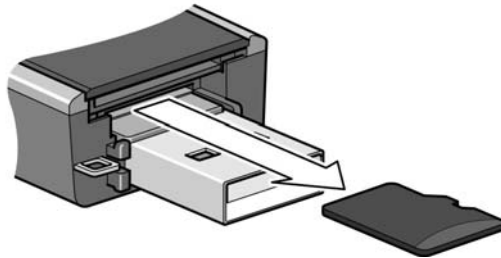

### If the microSD slot is on the side of the modem:

1. Open the flap on the side of the modem.
2. Push the microSD card in and then release it.

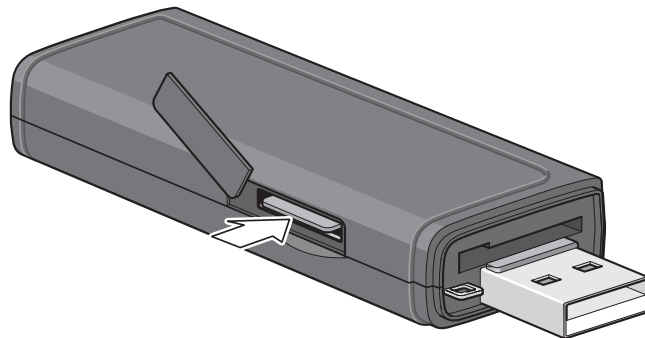

Gently pull the microSD card out.

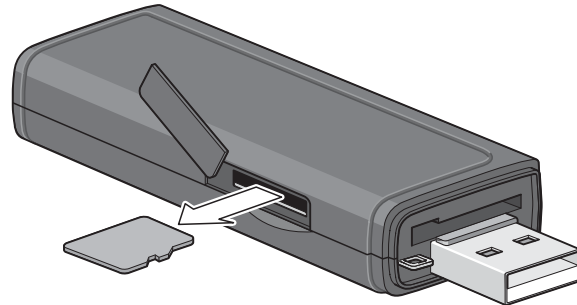

## Removing the SIM card

To remove the SIM card from the modem, push the SIM card in and then release it. See [Figure 3-1](#).

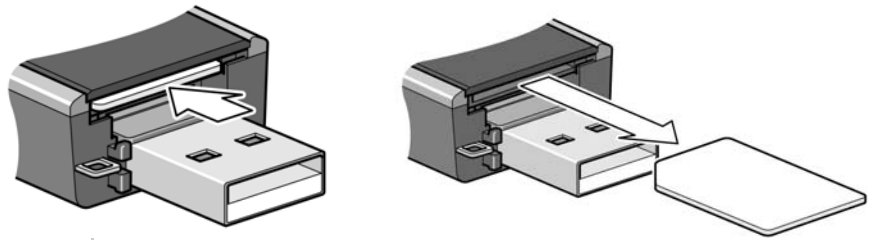

Figure 3-1: Removing the SIM card from a USB modem

## Using the extension cable and clip

Some USB modems may come with an extension cable and clip. The clip fits on the top of your notebook computer and holds your modem.

---

*Note: To meet FCC (regulatory) requirements, use only the supplied extension cable and notebook computer clip; other cables and notebook computer clips should not be used.*

---



---

*Note: Do not insert the modem or the USB extension cable into a USB hub or, if your keyboard is separate from your notebook computer, a USB slot on your keyboard.*

---

To use the extension cable and clip:

1. Place the clip on top of the notebook computer.

2. Connect the extension cable to the modem.
3. Place the modem in the clip holder.
4. Connect the other end of the extension cable to the USB slot on your computer.

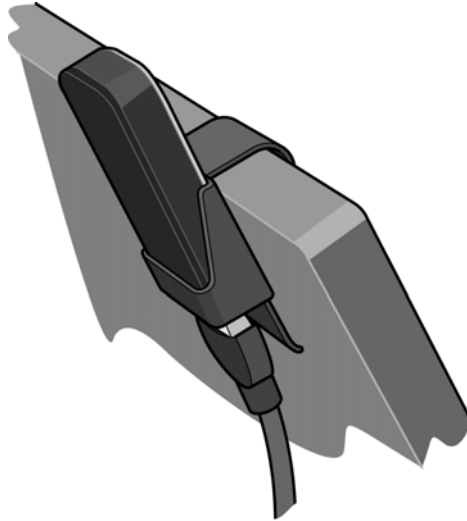

## Connection management software

Your modem comes with Sierra Wireless Watcher, Watcher for Mac, or other connection management software, depending on your carrier.

---

*Note: Sierra Wireless Watcher and Watcher for Mac are compatible with earlier Sierra Wireless modems.*

---

Watcher enables you to:

- Initiate data connections
- Determine signal strength, roaming status, GPRS, EDGE, UMTS, or HSDPA/HSUPA availability, and other network connection parameters
- Monitor the status of the modem and GSM service
- Send and receive SMS messages
- Enable or disable SIM security that prevents others from using your SIM card if it is lost or stolen
- Set options related to notifications and the 3G Watcher window





- Create or modify an account profile

You do not need to run Watcher when you use the modem, but Watcher does provide useful status information.

## Launching Watcher

Unless this feature has been disabled, Watcher launches automatically anytime you insert the modem. You can also launch Watcher by:

Windows	Mac
<ul style="list-style-type: none"> <li>• Double-clicking the desktop shortcut , or</li> <li>• Selecting <b>Start &gt; Programs &gt; Sierra Wireless &gt; 3G Watcher &gt; 3G Watcher</b></li> </ul>	<ul style="list-style-type: none"> <li>• Clicking the Watcher icon  in the dock, or</li> <li>• Navigating to the <b>Applications &gt; 3G Watcher</b> folder and double-clicking 3G Watcher.</li> </ul>

Depending on how your profile is configured, your browser, VPN, or other program may launch automatically anytime you launch Watcher.

## Turning the radio on and off

This option allows you to conserve your computer's battery by turning off the modem's radio transmitter/receiver when you are not using it.

To turn off the radio:

1. Select **Tools > Turn Radio Off**.

When the radio is turned off, the menu option switches to **Turn Radio On** and the message "Radio is off" is displayed in the 3G Watcher window.

To turn on the radio:

1. Select **Tools > Turn Radio On**.

## Frequency band and network selection

3G Watcher has two options that affect your ability to obtain GPRS, EDGE, UMTS, HSDPA/HSUPA or HSPA+ service:

- The frequency band you want to use
- The network you want to use, if you are within the coverage area of more than one network

---

*Note: Your service provide may not permit manual network selection. If network selection is restricted, (Mac) the Network button in the Preferences pane will be disabled.*

---

### Frequency band selection

Every GSM network operates on one set of frequency bands. The modem is designed to change frequency bands automatically to obtain network service. You can also change frequency bands manually.

To change frequency bands manually:

Windows	Mac
<ol style="list-style-type: none"> <li>1. From the main window, select <b>Tools &gt; Options &gt; Network</b>.</li> <li>2. In the Frequency Band field, select an option from the drop-down list.</li> </ol>	<ol style="list-style-type: none"> <li>1. Select <b>3G Watcher &gt; Preferences &gt; Network</b>.</li> <li>2. In the Frequency Band field, select the desired frequency band from the drop-down list.</li> </ol>

---

*Note: Unless your service provider specifies otherwise, it is recommended that you use the **Automatic** setting.*

---

More information is available in the Watcher Online Help. From the main Watcher window, select **Help > Help Topics** (Windows) or **Help > SierraWatcher Help** (Mac).

### Network selection

To change your network selection mode:

Windows	Mac
<ol style="list-style-type: none"> <li>1. From the main window, select <b>Tools &gt; Options &gt; Network &gt; Network Selection Mode</b>.</li> <li>2. Select an option from the Network Selection Mode drop-down list.</li> </ol>	<ol style="list-style-type: none"> <li>1. Select <b>3G Watcher &gt; Preferences &gt; Network</b>.</li> <li>2. Select an option in the Network Selection Mode field.</li> </ol>

Depending on your location, you may be within the coverage area of several networks. Your ability to obtain service on each network depends on your account.

Your options for network selection are:

- **Automatic** — The modem automatically selects a network based on your account and network availability.
- **Manual** — The modem scans the area and displays a list of detected GSM networks.

If you select a network on which you cannot obtain service, the message, “Failed to register with network” appears. Choose a different network.

More information is available in the Watcher Online Help. From the main Watcher window, select **Help > Help Topics** (Windows) or **Help > SierraWatcher Help** (Mac).

## Reinstalling the software (Windows)

If you need to reinstall or repair the Watcher software:

1. Open the **Control Panel**.
2. Double-click **TRU-Install**.
3. Follow the on-screen instructions.

Or, in Watcher:

1. Select **Tools > Software Installation Mode**.
2. Follow the on-screen instructions.

If you have canceled the software installation process or removed the modem from the computer before the software installation process was complete, you may receive error messages when you try to reinstall the software. If that happens:

1. Go to **Start > Control Panel > Add or Remove Programs** and remove **TRU-Install**.
2. Insert the modem into the computer.

---

*Note: Do not remove the modem until the software installation process is complete.*

---

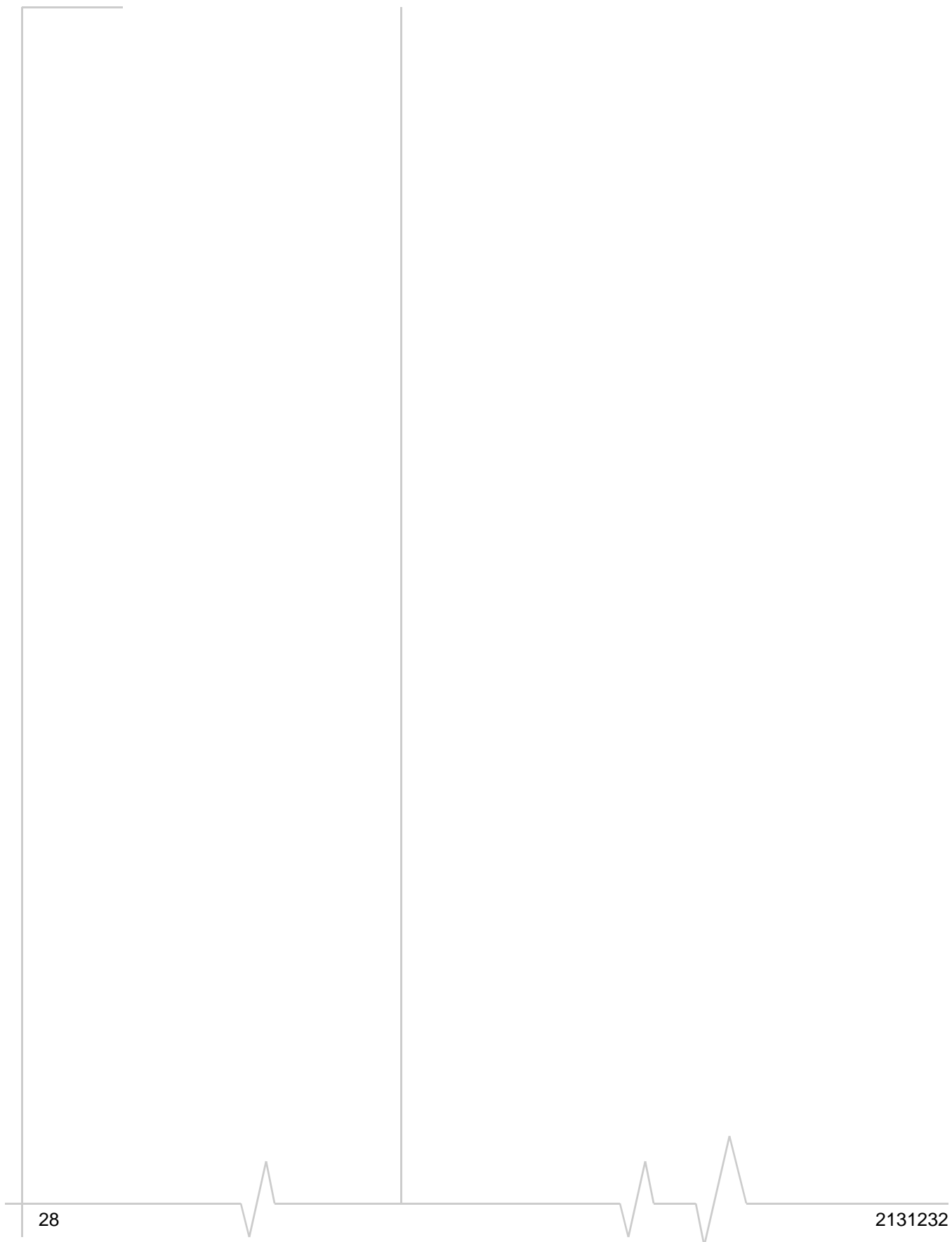

28

2131232

## 4: Care and Maintenance of Your USB Modem

As with any electronic device, the modem must be handled with care to ensure reliable operation. Follow these guidelines when you use and store your modem:

- Do not apply adhesive labels to the SIM card. This may cause it to jam inside the slot, or prevent it from being inserted properly.
- When not installed in your computer, store the modem and SIM card in a safe place.
- USB-connected modems should fit easily into your computer's USB port. Forcing the modem into the port may damage the connector pins.
- Protect the modem from liquids, dust, and excessive heat. (See the "[Environmental specifications](#)" on page 32 for maximum tolerances.)

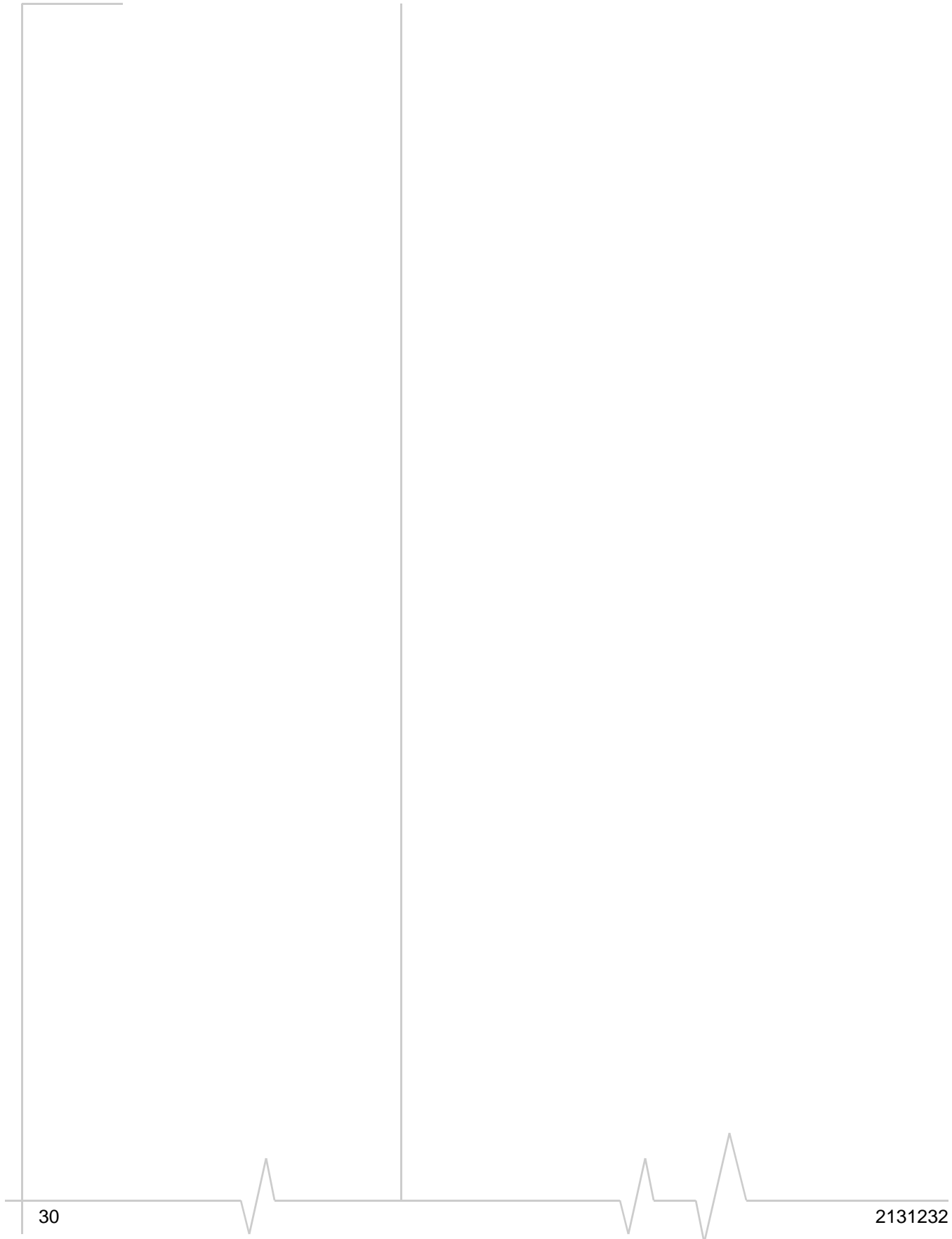

## Radio frequency and electrical specifications

Table 5-1: Radio frequency and electrical specifications

<b>Compliance</b>	GSM Release 6
<b>Transmit</b>	GSM 1900 (PCS): 1850 – 1910 MHz GSM 1800 (DCS): 1710 – 1785 MHz EGSM 900: 880 – 915 MHz GSM 850: 824 – 849 MHz WCDMA 2100 (Band I): 1920 – 1980 MHz WCDMA 1900 (Band II): 1850 – 1910 MHz WCDMA 850 (Band V): 824 – 849 MHz WCDMA 800 (Band VI): 830 – 840 MHz
<b>Receive</b>	GSM 1900 (PCS): 1930 to 1990 MHz GSM 1800 (DCS): 1805 to 1880 MHz EGSM 900: 925 to 960 MHz GSM 850: 869 to 894 MHz WCDMA 2100 (Band I): 2110 to 2170 MHz WCDMA 1900 (Band II): 1930 to 1990 MHz WCDMA 850 (Band V): 869 to 894 MHz WCDMA 800 (Band VI): 875 to 885 MHz
<b>Channel spacing</b>	200 kHz (GSM) 5 MHz (WCDMA)
<b>Channel raster</b>	200 kHz
<b>Frequency stability</b>	0.1 ppm

## Environmental specifications

<b>Operating temperature</b>	0°C to 50°C (32°F to 122°F)
<b>Storage temperature</b>	-20°C to +85°C (-4°F to +185°F)
<b>Humidity</b>	85%, non-condensing
<b>Vibration</b>	Random vibration, 10 to 1000 Hz, nominal 6G RMS in each of 3 mutually perpendicular axes. Test duration of 60 minutes for each axis, for a total test time of 3 hours (non-operating).
<b>Drop</b>	1 m on concrete on each of 6 faces, 2 times

DRAFT



## 6: Regulatory and Safety Information

### Notice

Because of the nature of wireless communications, transmission and reception of data can never be guaranteed. Data may be delayed, corrupted (that is, have errors), or be totally lost. Although significant delays or losses of data are rare when wireless devices such as the Sierra Wireless modem are used in a normal manner with a well-constructed network, the Sierra Wireless modem should not be used in situations where failure to transmit or receive data could result in damage of any kind to the user or any other party, including but not limited to personal injury, death, or loss of property. Sierra Wireless and its affiliates accept no responsibility for damages of any kind resulting from delays or errors in data transmitted or received using the Sierra Wireless modem, or for failure of the Sierra Wireless modem to transmit or receive such data.

### Safety and hazards

The modem **MUST BE POWERED OFF** in all areas that may be susceptible to radio interference, in particular:

- Prohibited areas  
Obey all signs and notices and follow all rules and regulations. Power off the modem when instructed to do so or when you suspect that it may cause interference or danger.
- In areas where blasting is in progress
- Where explosive atmospheres may be present  
Areas with a potentially explosive atmosphere are not always clearly marked. Such areas include gas stations, fuel depots, chemical transfer or storage facilities, areas where blasting is in progress, areas where the air contains chemicals or particles such as grain, dust, or metal powders, and any other area where you would normally be advised to turn off your cellular phone or vehicle engine.
- Near medical or life-support equipment  
Medical equipment may be susceptible to any form of radio interference. In such areas the modem can transmit signals that could interfere with this equipment.
- On board aircraft

In addition to Federal Aviation Authority (FAA) requirements, many airline regulations state that you must suspend wireless operations before boarding an aircraft. The modem is capable of transmitting signals that could interfere with various onboard systems and controls.

Failure to observe this instruction may lead to suspension or denial of cellular telephone services to the offender, legal action, or both.

Some airlines may permit the use of cellular phones while the aircraft is on the ground and the door is open. The modem may be used normally at this time.

- While operating a vehicle

The driver or operator of any vehicle should not use a wireless data device while in control of a vehicle. Doing so detracts from the driver or operator's ability to control and operate the vehicle. In some countries, using such communications devices while in control of a vehicle is an offence.

## Regulatory information for North America

**CAUTION:** Unauthorized modifications or changes not expressly approved by Sierra Wireless, Inc. could void compliance with regulatory rules, and thereby your authority to use this equipment.

The design of the Sierra Wireless modems complies with U.S. Federal Communications Commission (FCC) and Industry Canada (IC) guidelines respecting safety levels of radio frequency (RF) exposure for portable devices, which in turn are consistent with the following safety standards previously set by Canadian, U.S. and international standards bodies:

- ANSI/IEEE C95.1-1999, *IEEE Standard for Safety Levels with Respect to Human Exposure to Radio Frequency Electromagnetic Fields, 3 kHz to 300 GHz*
- National Council on Radiation Protection and Measurements (NCRP) Report 86, -1986, *Biological Effects and Exposure Criteria for Radio Frequency Electromagnetic Fields*
- Health Canada, Safety Code 6, 1999, *Limits of Human Exposure to Radio frequency Electromagnetic Fields in the Frequency Range from 3 kHz to 300 GHz*
- International Commission on Non-Ionising Radiation Protection (ICNIRP) 1998, *Guidelines for limiting exposure to time-varying electric, magnetic, and electromagnetic fields (up to 300 GHz)*

---

**Caution:** *The Sierra Wireless USB modem must be 1.0 cm or more from users during operation, to satisfy FCC / IC RF exposure requirements. The Sierra Wireless USB modem has been tested for compliance with FCC / IC RF exposure limits in the notebook computer(s) configurations with horizontal and vertical USB slots and can be used in notebook computers with substantially similar physical dimensions, construction, and electrical and RF characteristics. This USB modem must not be used with any other antenna or transmitter that has not been approved to operate in conjunction with this modem. Note: This USB modem must not be used in any unapproved configurations. For details, contact Sierra Wireless.*

---

*Note: The Sierra Wireless USB modem is approved for normal-size notebook computers only (typically with 12 inches or larger display screens). For notebook computers with a display screen smaller than 12 inches or if the orientation of the USB slot does not allow for at least 1.0 cm between the modem and the user or bystanders, use the provided extension cable and clip to ensure a safe distance between the modem antenna and users or bystanders.*

*To meet FCC requirements, use only the supplied USB extension cable and laptop clip; other cables and laptop clips should not be used.*

---

These devices comply with Part 15 of the FCC Rules. Operation is subject to the condition that these devices do not cause harmful interference.

Where appropriate, the use of the equipment is subject to the following conditions:

---

**Warning:** (EMI) – *United States FCC Information – This equipment has been tested and found to comply with the limits pursuant to Part 15 of the FCC Rules. These limits are designed to provide reasonable protection against harmful interference in an appropriate installation. This equipment generates, uses, and can radiate radio frequency energy and, if not installed and used in accordance with the instructions, may cause harmful interference to radio communication. However, there is no guarantee that interference will not occur in a particular installation.*

---

If this equipment does cause harmful interference to radio or television reception, which can be determined by turning the equipment off and on, the user is encouraged to try to correct the interference by one or more of the following measures:

- Increase the separation between the equipment and receiver
- Connect the equipment into an outlet on a circuit different from that to which the receiver is connected
- Consult the dealer or an experienced radio/TV technician for help

If you have purchased this product under a United States Government contract, it shall be subject to restrictions as set forth in subparagraph (c)(1)(ii) of Defense Federal Acquisitions Regulations (DFARs) Section 252.227-7013 for Department of Defense contracts, and as set forth in Federal Acquisitions Regulations (FARs) Section 52.227-19 for civilian agency contracts or any successor regulations. If further government regulations apply, it is your responsibility to ensure compliance with such regulations.

## Regulatory information for EU countries

Sierra Wireless hereby declares that the Sierra Wireless USB wireless modem conform to all the essential requirements of Directive 1999/5/EC:

**CE 0682**

The Declaration of Conformity made under Directive 1999/5/EC is available for viewing at the following location in the EU community:

Sierra Wireless (UK), Limited  
Lakeside House  
1 Furzeground Way, Stockley Park East  
Uxbridge, Middlesex  
UB11 1BD  
England

# »» | Index

## Numerics

3G Watcher  
introduction, [24](#)  
launching, [25](#)

## A

account, [10](#)

## C

channel raster, [31](#)  
channel spacing, [31](#)  
clip, [23](#)  
connect to the network, [16](#)  
coverage area, [10](#)

## D

driver, [11](#)

## E

electrical specifications, [31](#)  
environmental specifications, [32](#)  
error messages, [27](#)  
extension cable, [23](#)  
external memory storage, [9](#), [21](#)  
external SD, [9](#), [21](#)  
external storage card, [21](#)

## F

flash drive, [21](#)  
frequencies  
receive, [31](#)  
transmit, [31](#)  
frequency stability, [31](#)

## H

humidity, [32](#)

## I

installing, error messages, [27](#)

## L

lanyard, [18](#)  
launching 3G Watcher, [25](#)  
LEDs, [20](#)

## M

Macintosh OSX support, [13](#)  
memory card, [9](#)  
memory required, [13](#)  
micro external memory card, [21](#)  
microSD, [9](#), [21](#)  
modem, inserting, [15](#)

## N

network  
overview, [10](#)  
selection, [27](#)  
notebook computer clip, [23](#)

## O

operating systems supported, [13](#)

## P

power options, power up/down, [25](#)  
profile, [13](#), [16](#)

## R

radio frequency specifications, [31](#)  
receive frequencies, [31](#)  
regulatory information, [33](#)  
requirements, software, [14](#)  
RF specifications, [31](#)  
roaming, [10](#)

## S

safety notice, [33](#)  
SIM card  
inserting, [14](#)  
removing, [23](#)  
software installation, [16](#)  
software requirements, [14](#)

specifications, [31–32](#)  
    electrical, [31](#)  
    environmental, [32](#)  
    radio frequency, [31](#)  
storage  
    temperature, [32](#)  
    when not using card, [29](#)  
system requirements, [13](#)

## T

technical specifications, [31–32](#)  
temperature, [32](#)  
transmit frequencies, [31](#)  
TRU-Install, [9](#), [16](#), [16](#)

## U

USB modem, inserting, [15](#)  
USB port requirements, [13](#)

## V

vibration, [32](#)

## W

Watcher, description, [11](#)  
Windows Vista support, [13](#)  
Windows XP support, [13](#)



