



USER'S MANUAL

This manual explains how to use **SIGMA SD14** digital SLR camera.
Please refer to the **SIGMA Photo Pro** User Guide, which is available in the PDF format of the supplied CD-ROM, to get information about installation of **SIGMA Photo Pro** software to your computer, connection between camera and computer and for detailed explanation of **SIGMA Photo Pro** software.

Thank you for purchasing the Sigma Digital Autofocus Camera

The Sigma SD14 Digital SLR camera is a technical breakthrough! It is powered by the Foveon® X3™ image sensor, the world's first image sensor to capture red, green and blue light at each and every pixel. A high-resolution digital single-lens reflex camera, the SD14 delivers superior-quality digital images by combining Sigma's extensive interchangeable lens line-up with the revolutionary Foveon X3 image sensor. You will get the greatest performance and enjoyment from your new SD14 camera's features by reading this instruction manual carefully before operating it. Enjoy your new Sigma camera!

SPECIAL FEATURES OF THE SD14

- Powered by Foveon X3 technology.
- In addition to RAW format data recording system, this camera also incorporates easy to use and high quality JPEG recording format. Super high quality JPEG format recording mode makes the best use of the characteristic of **FOVEON® X3™** image sensor.
- Dust protector keeps dust from entering the camera and adhering to the image sensor.
- Mirror-up mechanism and depth-of-field preview button support advanced photography techniques.

- Please keep this instruction booklet handy for future reference. Doing so will allow you to understand and take advantage of the camera's unique features at any time.
 - The warranty of this product is one year from the date of purchase. Warranty terms and warranty card are on a separate sheet, attached. Please refer to these materials for details.



Disposal of Electric and Electronic Equipment in Private Households

Disposal of used Electrical & Electronic Equipment (Applicable in the European Union and other European countries with separate collection systems)

This symbol indicates that this product shall not be treated as household waste. Instead it shall be collected separately for the recycling of electrical and electronic equipment.

If the new products are purchased, this product might be handed over to the distributor or the collection system of waste electrical and electronic equipment eventually.

By ensuring this product is disposed of correctly, you will help prevent potential negative consequences for the environment and human health, which could otherwise be caused by inappropriate waste handling of this product or components of this product.

If this product is disposed illegally, it might cause a possibility of penalties.

For more detailed information about recycling of this product, please contact your local city office, your household waste disposal service or the shop where you have purchased the product.

NOTES ON COPYRIGHT

This camera is intended only for personal use and should never be used in a way that infringes upon or contravenes international or domestic copyright laws and regulations. In addition, although it is intended purely for personal use, some restrictions may be applied to the photographing of demonstrations, performances, shows, exhibitions, or commercial properties, etc. Copyright or other legal rights should not be contravened.

- FOVEON is a registered trademark of Foveon, Inc. X3, and the X3 Logo are trademarks of Foveon, Inc.
- CompactFlash is a trademark of SanDisk Corporation.
- IBM PC/AT series computer is a trademark or registered trademark of International Business Machines Corporation (IBM) in the U.S.A.
- Microsoft and Windows are either registered trademarks or trademarks of Microsoft Corporation in the United States and/or other countries.
- Macintosh and MAC OS are registered trademarks or trademarks of Apple Inc. in the U.S.A. and /or other countries.
- Adobe and Photoshop are trademarks of Adobe Systems Incorporated.
- Microdrive is a registered trademark of Hitachi Global Storage Technologies in the United States and / or other countries.
- All other company or product names used in documents are trademarks or registered trademarks of their respective holders.

PACKAGE CONTENTS / ACCESSORIES

Please make sure that following standard accessories are included with your camera. If any of them is missing, contact the retailer from which you purchased your camera immediately.

1. Camera Body (SD14)
2. Body Cap (on the camera)
3. Eyepiece Cup (on the camera)
4. Strap
5. Finder Cap
6. Li-ion Battery BP-21 (Battery Cover is included)
7. Battery Charger BC-21
8. Battery Charger Cable
9. USB Cable
10. Video Cable
11. SIGMA Photo Pro Disc
12. Instruction Manual
13. Warranty Card
14. SIGMA Limited Warranty & Service Network

- | |
|--|
| <ul style="list-style-type: none">● No CF card is included with this camera. Please purchase the brand and capacity CF card that you desired separately. |
|--|

TABLE OF CONTENTS

PACKAGE CONTENTS / ACCESSORIES	2
SAFETY PRECAUTIONS	6
HANDLING PRECAUTIONS	8
DESCRIPTION OF THE PARTS	11
TOP LCD PANEL	13
VIEWFINDER	13
CONTROL DIALS	14
BASIC OPERATION AND QUICK REFERENCE	15
PREPARATION	18
ATTACHING THE CARRY STRAP	18
HOW TO USE THE FINDER CAP	18
LOADING THE BATTERY	19
CHECKING THE BATTERY STATUS	22
USING A HOME POWER SUPPLY (SOLD SEPARATELY)	23
MOUNTING AND REMOVING THE LENS	24
SETTING THE LANGUAGE	26
SETTING THE TIME AND DATE	27
INSERTING AND REMOVING THE CF CARD	28
FORMATTING THE CF CARD	30
FILE NUMBERING SYSTEM	31
FOLDER MANAGER	32
FRAME NUMBER COUNTER	33
DIOPTER ADJUSTMENT	34
TOP LCD ILLUMINATION	35
HOLDING THE CAMERA	35
SHUTTER BUTTON	36
SETTING THE ELECTRONIC SOUND	36
BASIC OPERATION	37
SELECTING THE EXPOSURE MODE	37
P PROGRAM AE	37
A APERTURE PRIORITY AE	39
S SHUTTER SPEED PRIORITY AE	40
M MANUAL EXPOSURE	41
BULB SETTING	42
USING THE BUILT-IN FLASH	43
USING THE BUILT-IN FLASH	43
EXPOSURE MODE AND BUILT-IN FLASH	44

FUNCTION SETTING OF FLASH	45
FOCUSING	46
HOW TO USE AUTOFOCUS	46
SELECTING THE AUTOFOCUS MODE	47
AF POINT SELECTION	48
AF AUXILIARY LIGHT	49
FOCUS LOCK	50
MANUAL FOCUS	50
OPERATION OF THE DRIVE MODE	51
DRIVE-AREA	51
SINGLE FRAME SHOOTING	51
CONTINUOUS SHOOTING	52
SELF TIMER	52
MIRROR LOCK-UP	53
ADVANCED OPERATION	54
SETTING THE WHITE BALANCE (WB)	54
SETTING THE SENSITIVITY (ISO EQUIVALENCY)	57
IMAGE FILE SETTING	58
IMAGE PARAMETER AND COLOR SPACE	59
SELECTING THE METERING MODE	61
AE LOCK	62
EXPOSURE COMPENSATION	63
FLASH EXPOSURE COMPENSATION	64
AUTO BRACKETING	65
REMOTE CONTROLLER RS-31	67
DEPTH-OF-FIELD PREVIEW BUTTON	69
FLASH PHOTOGRAPHY	70
EXTENDED MODE SETTING	71
REVIEWING, DELETING AND MODIFYING IMAGES	72
QUICK PREVIEW	72
CHANGING THE QUICK PREVIEW DURATION	72
CHANGING THE QUICK PREVIEW STYLE	74
QUICK DELETE	75
REVIEWING IMAGES	76
VIEWING ONE IMAGE AT A TIME	77
MAGNIFYING IMAGES (ZOOMED-IN VIEW)	78

VIEWING NINE IMAGES AT A TIME (CONTACT SHEET VIEW)	79
VIEWING IMAGES A PAGE AT A TIME (JUMP MODE).....	80
VIEWING IMAGE INFORMATION.....	81
IMAGE INFO SCREEN FOR MAGNIFIED IMAGES.....	82
HISTOGRAM.....	83
OVER-EXPOSURE WARNING	84
VIEWING IMAGES ON A TV	85
DELETING IMAGES.....	86
DELETING A SINGLE IMAGE	87
DELETING MULTIPLE IMAGES.....	88
MODIFYING IMAGES	89
LOCKING IMAGES	90
MARKING IMAGES	93
ROTATING IMAGES	96
USING THE OK BUTTON SHORTCUT	98
SHOWING A SLIDESHOW	100
CHANGING SLIDESHOW SETTINGS.....	103
CAMERA SET-UP MENU.....	104
USING THE CAMERA SET-UP MENU.....	104
LIST OF MENU FUNCTIONS.....	105
CAMERA INFO PAGE.....	107
REFERENCE.....	108
OPTIONAL ACCESSORIES	108
MAINTENANCE	109
CLEANING THE IMAGE SENSOR.....	109
EXPLANATION OF TERMS.....	112
AUTO POWER OFF	115
WARNING DISPLAYS.....	117
TROUBLESHOOTING	119
SPECIFICATIONS	121
CONNECTING YOUR CAMERA TO A COMPUTER	122

SAFETY PRECAUTIONS

To avoid causing damage or injury, please read this instruction manual carefully, before using the camera.

Please take special note of the following two cautionary symbols.

 **Warning !!** Using the product and disregarding this warning sign may cause serious injury or other dangerous results.

 **Caution !!** Using the product disregarding this caution sign may cause injury or damage.

 This symbol denotes warning or point, where caution is required.

 Symbol contains information regarding the actions that must be avoided.

WARNING (BATTERY, BATTERY CHARGER AND AC ADAPTER)

 Keep batteries in a safe place out of children's reach. If a battery is swallowed, call for emergency medical aid immediately.

 Do not use any battery other than the designated battery types. Doing so may cause battery explosion, battery leakage, camera damage, injury or fire.

 Do not use any battery other than that specified in this booklet. Otherwise, it might cause battery explosion, battery leakage, camera damage, injury or fire.

 Avoid any shock, shake and drop. Ignoring this warning may cause battery explosion, or battery leakage, resulting in injury or fire.

 Never disassemble, short circuit, heat, batteries or put batteries into fire. Ignoring this warning may cause battery explosion, battery leakage, injury or fire.

 Please only use charger with dedicated battery. Charging other battery types causes battery explosion, battery leakage, camera damage, injury or fire.







 If for some reason, the camera or batteries emit smoke, or if overheating or the smell of burning is detected, remove the batteries, taking care to avoid being burned. Take the camera to the retailer where you bought it, or to an authorized Sigma service station.

 Please follow all guidelines, rules and regulations of your community regarding the disposal of batteries.









 If you do not use the camera for a long period of time, remove the battery.

 Do not use any AC adapter other than the one provided with your camera. Using other brands may cause electrical shock and fire



SAFETY PRECAUTIONS

-  The AC Adapter is designed for use with this product only. Do not use it with any other appliance. Doing so may cause overheating, fire, electric shock or injury.
-  If the adapter is emitting smoke, generating a strange odor or making an abnormal noise, while in use, disconnect the power plug from the outlet immediately. Otherwise, fire or electric shock may result.
-  If water or a foreign object gets into the adapter, unplug from the AC outlet immediately. It could cause fire or electric shock.
-  Do not attempt to modify or disassemble this product. Doing so can cause fire or electric shock.
-  Do not place any heavy objects on the power cord, or pull it, bend it unduly, or heat it. It could damage the cord, and could cause fire or electric shock.
-  Do not use this product with AC voltage other than the specified power supply voltage (AC100V - 240V). Doing so could cause fire or electric shock.
-  Use a safety approved AC power cord as is specified by each country.



WARNING (CAMERA)

-  Never use your camera in an environment where flammable or burnable, gas, liquids or chemicals, such as Propane, Gasoline, etc., are present.
-  Keep the camera in a safe place that children cannot reach. Playing with the camera strap around one's neck can cause strangulation.
-  Do not disassemble the camera; Doing so can cause electric shocks and burns.
-  Do not touch internal parts of the camera that become exposed as a result of damage, it could cause fire or electric shock. Remove the batteries and contact an authorized Sigma service station.
-  After attaching a lens, do not look directly at the sun, through the viewfinder. Doing so can cause damage to the eye or loss of eyesight.
-  Do not look at the sun with the lens of your camera; otherwise you can lose your eyesight.
-  Keep the camera away from moisture or water. If you drop your camera/lens in water, please contact the retailer where you purchased the camera, or a service station immediately. If you use the camera with this condition it can cause electric shock or fire.
-  Prevent water, or metallic and other conductive objects from coming into contact with the terminals of Camera Body. This can result in electric shock, overheating and fire.





SAFETY PRECAUTIONS

-  Do not fire the flash close to eyes. Otherwise, the bright light would damage the eye. Keep at least 1m/3feet distance between face and the camera, when taking a picture with flash.
-  Do not cover the flash with your finger or hand, it can cause skin burn.

CAUTION (BATTERY CHARGER AND AC ADAPTER)

-  Do not pull the Battery Charger or the AC power cord, when disconnecting the AC adapter from the AC outlet. It could cause fire or electric shock due to damaged cord. Always take hold of the moulded AC plug, when unplugging it from the outlet.
-  Do not cover the Battery Charger or the AC adapter with cloth, cushions, etc. It could cause excessive heat, deform the case, and cause fire.
-  When Battery Charger is not used unplug it from the outlet.

CAUTION (CAMERA)

-  Do not aim your lens or camera & lens combinations toward the sun; light entering through the lens could cause damage to eyes or fire.
-  Please do not carry your camera while a tripod is attached, as this could result in injury or a fall.
-  Please do not grasp the camera with wet hand, as it might cause electric shock
-  Do not leave the camera in a hot place or in a car parked in the sun. If the camera becomes hot, it might cause burns to the skin.
-  If the liquid crystal display (LCD) monitor becomes damaged, be careful of the fragments of glass, which can cause injury. If the liquid inside the LCD monitor leaks out, and you are faced with the following situations, please do as follows.
 - If the liquid adheres to clothes or the skin, wash it away with soap immediately.
 - If the liquid enters the eye, flush the affected eye with clean water immediately for 15minutes, and seek medical assistance.
 - If the liquid is swallowed, drink large quantity of water, induce vomiting and seek medical assistance.

HANDLING PRECAUTIONS

Please read this section before using the camera.

Study and familiarize yourself with the functions of your camera before using it. No compensation or guarantee is provided for unsatisfactory pictures or loss of profit, etc.

Carry spare batteries when you use the camera in a cold environment, on a field trip, or when taking many pictures at one time.

Do not use this camera with any external flash unit other than Sigma Flash EF-500 DG SUPER SA-STTL or EF-500 DG ST SA-STTL, which have special contact pins on the hot shoe. The flash units are offered as optional accessories. Other brands of external flash units may damage the camera's circuit boards or may not function properly.

ENVIRONMENT

- Your camera is a precision instrument. Do not drop it or subject it to physical shock.
- This camera is not waterproof, and cannot be used underwater. Wipe off any water droplets with a dry cloth as soon as possible. If the camera gets really wet, promptly consult your nearest Sigma Service Center.
- Do not leave the camera in a dusty, hot, or highly humid environment for a long period of time.
- If the camera is moved from a cold place to a warm room, water droplets may appear on the camera. Please keep the camera in a bag until it is acclimatized to the ambient room temperature.
- The camera will work within a temperature range between 0°C/32°F and +40°C/104°F and humidity less than 80% (no condensation). However, in cold temperatures below 0°C, the power performance of the battery reduced. Please carry a spare battery in these circumstances, and keep the batteries warm.
- Static electricity or magnetic fields, may effect the operation of the camera. If such exposure occurs, please remove the battery from the camera and re-insert it, to reset the camera's microprocessors.

HOW TO STORE THE CAMERA

- If you intend to store the camera for a long time, remove the battery.
- To avoid growth of fungus, store the camera and lens in a dry, cool and ventilated place, with a drying agent such as silica gel. Keep your equipment away from chemicals.

NOTE ON THE TFT COLOR LCD MONITOR

- A few pixels may always be lit or may never light on the LCD monitor. This is not a failure or malfunction. Images recorded with the camera will not be affected.
- Excessive rubbing of, pushing on or impact to the LCD monitor may cause failure.
- Because of the normal physical characteristics of the liquid crystal, the reaction of the display may become slow at low temperatures. At high temperatures, the display may become dark, but it will return to normal at room temperature.

NOTES ON CF CARD AND MICRODRIVE

Unlike a Microdrive™ a CF card is resistant to vibration and it is the optimal recording medium for a digital camera. Nevertheless the effects of strong shock, static electricity or magnetism, may cause the data memorized by the CF card to be lost. A Microdrive™ is a hard disk. Shock, vibration, static electricity, and magnetism, may cause data loss and may damage the Microdrive. Therefore, careful handling is required and caution is especially necessary while writing, or reading data.

- Do not leave the CF card or Microdrive in direct sunlight or near a heating device.
- Avoid storing CF cards and Microdrives in environments of high temperature and humidity or where static electricity or electromagnetic fields may be generated
- For proper usage of the CF card and Microdrive, please refer to their instruction manuals.
- The "Delete" feature of the Camera and PC may not delete the data in the memory card completely some data might still remain. If you wish to remove all data from card securely, please use third party software.

DESCRIPTION OF THE PARTS

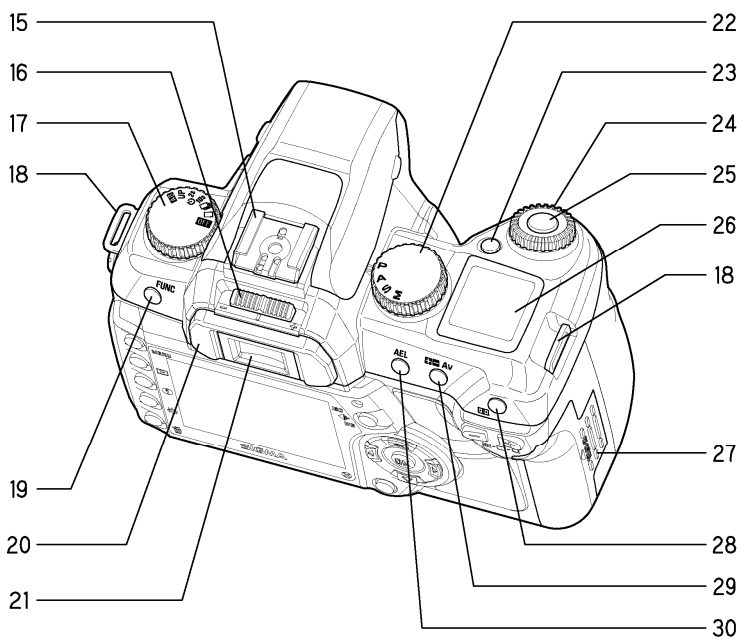
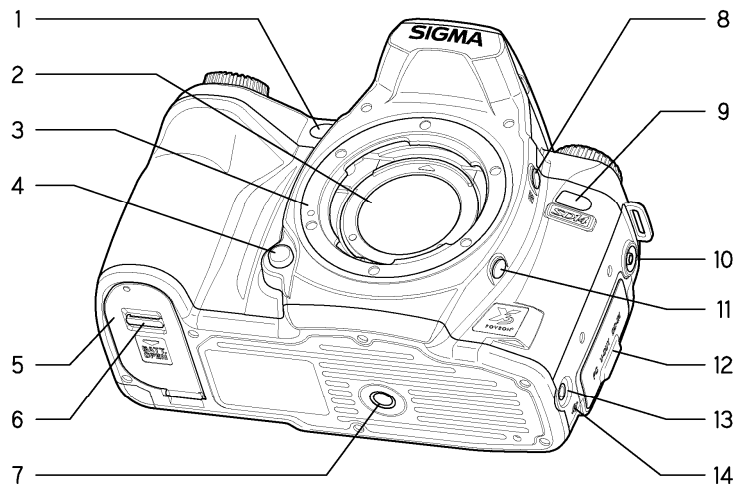

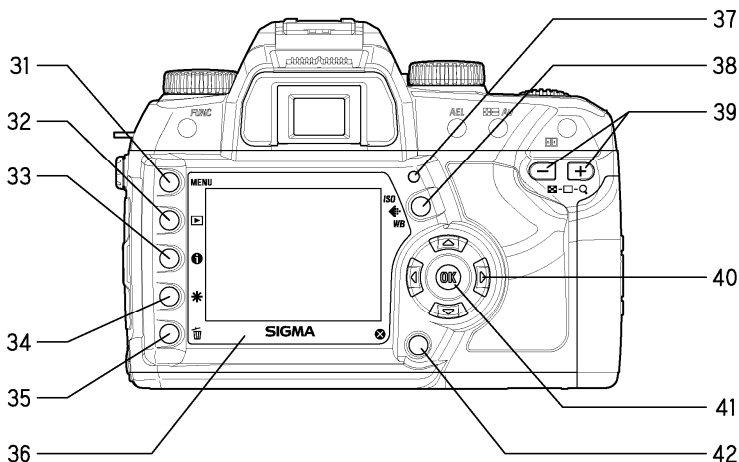

- | | |
|---------------------------------------|---|
| 1. AF AUXILIARY LIGHT | 24. C-DIAL (COMMAND DIAL) |
| 2. DUST PROTECTOR | 25. SHUTTER BUTTON |
| 3. LENS MOUNT | 26. TOP LCD PANEL |
| 4. LENS LOCK BUTTON | 27. CF CARD COVER |
| 5. BATTERY COMPARTMENT COVER | 28. AF POINT SELECTOR BUTTON |
| 6. BATTERY COMPARTMENT COVER LATCH | 29. Av EXPOSURE / APERTURE COMPENSATION BUTTON |
| 7. TRIPOD SOCKET | 30. AE LOCK BUTTON |
| 8. FLASH EXPOSURE COMPERTMENT BUTTON | 31. MENU (MAIN MENU) BUTTON |
| 9. REMOTE CONTROL SENSOR | 32. (VIEW) BUTTON |
| 10. PC SYNCHRO TERMINAL | 33. (INFORMATION) BUTTON |
| 11. DEPTH-OF-FIELD PREVIEW BUTTON | 34. (MODIFY MENU) BUTTON |
| 12. CONNECTOR COVER | 35. (DELETE) BUTTON |
| 13. RELEASE SOCKET | 36. COLOR LCD MONITOR |
| 14. FOCAL PLANE MARK | 37. CF CARD BUSY LIGHT |
| 15. HOT SHOE | 38. ISO WB QUICK SET BUTTON |
| 16. DIOPTER ADJUSTER | 39. CONTROLLER |
| 17. D-DIAL (DRIVE DIAL) | 40. 4-WAY CONTROLLER |
| 18. CAMERA STRAP EYELET | 41. (OK) BUTTON |
| 19. FUNC (FUNCTION) BUTTON | 42. (CANCEL) BUTTON |
| 20. EYEPiece CUP | |
| 21. VIEWFINDER EYEPiece | |
| 22. MODE DIAL | |
| 23. TOP LCD ILLUMINATION BUTTON | |

TOP LCD PANEL

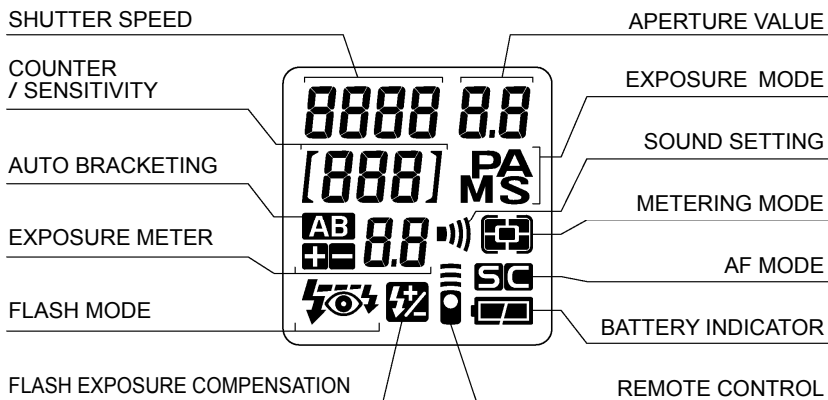

VIEWFINDER

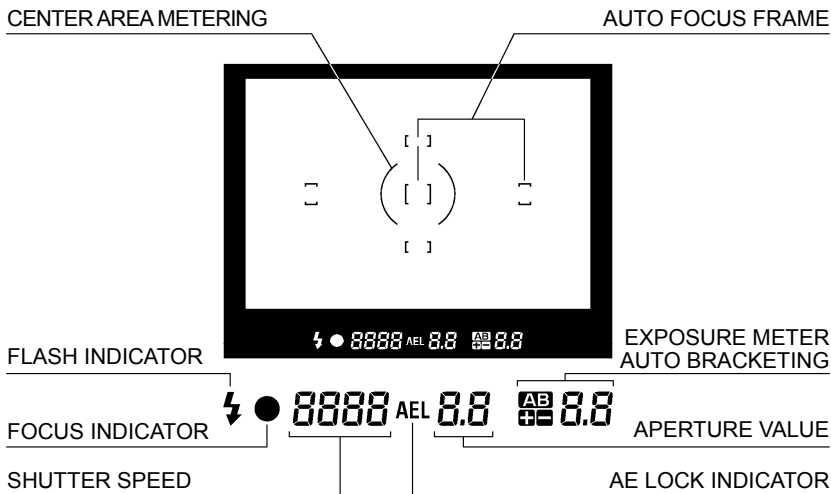

CONTROL DIALS

D-DIAL

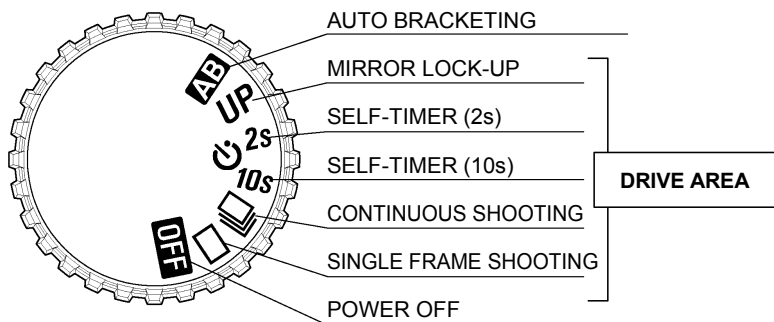

MODE DIAL

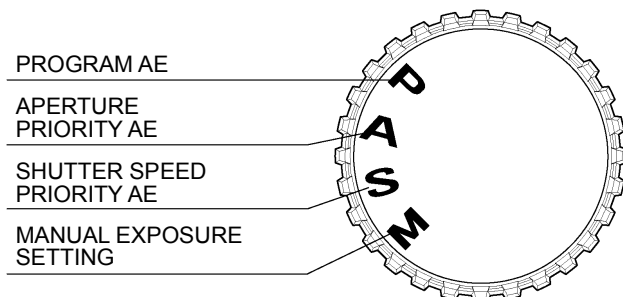

BASIC OPERATION AND QUICK REFERENCE

The SD14 camera has many advanced features. This section, describes basic camera operation. You can find more details in later sections.

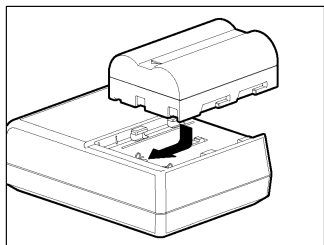

Charging the battery (P.19)

Charge the supplied lithium ion battery with the provided battery charger.

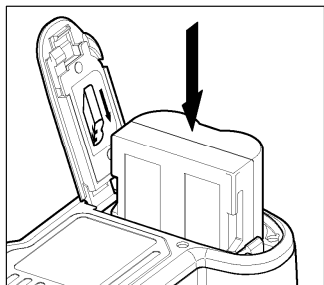

To insert the battery (P.20)

Insert the battery into the chamber in accordance with the diagram.

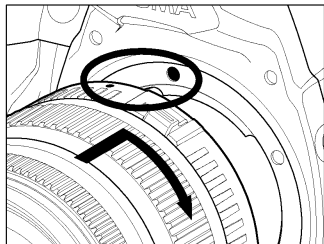

Mount the lens (P.24)

Align the red mark on the camera's lens mount with the red dot on the lens. Insert the lens into the mount of the camera, and rotate the lens clockwise until it clicks into the locked position.



Set the language (P.26)

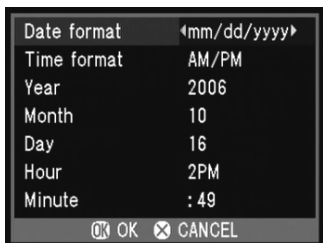

Set the date and time (P.27)

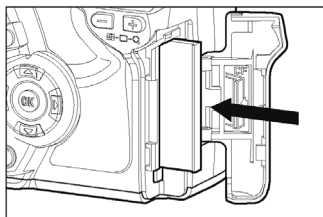

Loading the Compact-Flash Card (P.28)

Position the CF card label facing toward the CF card cover as shown in the illustration, and push the CF card gently, all the way into the slot.

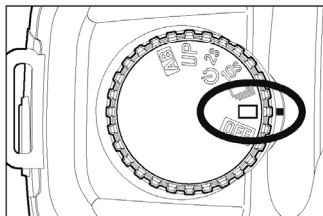

Turn the “D”-dial to the □ (single frame shooting) position. (P.51)

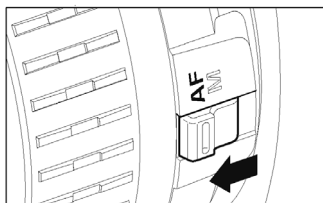

Set the AF/MF switch on the lens to the AF position. (P.46)

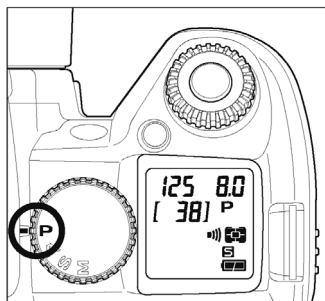

Select the exposure mode (P.37)

Set the "Mode"-Selector to **P** "Program AE" position



Focus (P.46)

Determine the composition through the finder, and then press the shutter button "Half-way" to activate exposure metering and autofocus.

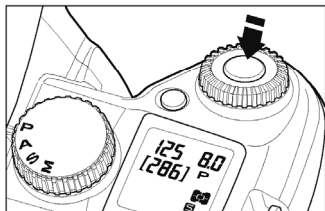
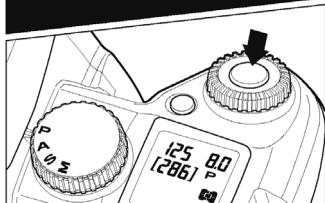

Take a picture

Press the shutter button "All-the way-down" to take a picture



Review the image. (P.72)

The image is displayed for 2 seconds on the LCD monitor.

PREPARATION

This section describes necessary preparations before using the camera.

ATTACHING THE CARRY STRAP

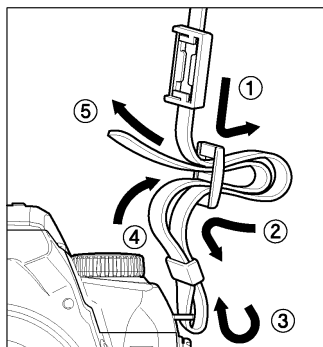

1
Undo the strap end.

2
Thread the Finder Cap onto the strap.

3
Attach the carry strap as shown.

HOW TO USE THE FINDER CAP

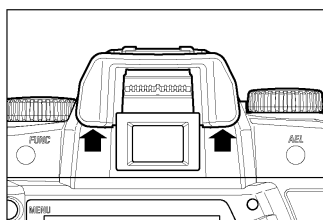

When using the self-timer or remote control, cover the viewfinder eyepiece with the Finder Cap, to prevent stray light from entering the camera.

1
Remove the eyecup from the viewfinder.

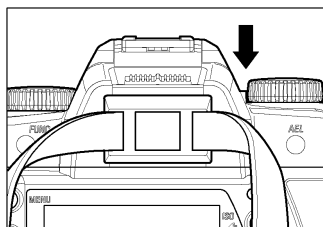

2
Attach the Finder Cap onto the viewfinder.

LOADING THE BATTERY

A lithium ion battery BP-21 is provided with the SD14 camera. Charge the battery, before using the camera first time. Please charge the battery by the supplied battery charger BC-21, when no charge remains.

To Charge the battery

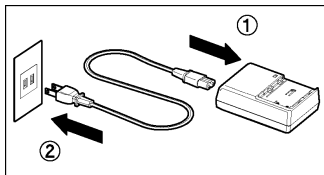

1

Connect the power cable to the charger and insert the plug into the wall outlet.

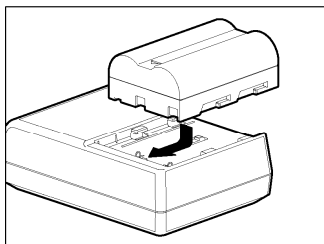

2

Attach the battery, by sliding it in the direction of the arrow, as shown in the diagram.

- Charge lamp will be on during charging.
- It takes about 150 minutes to recharge the battery.
- Required time for recharging the battery depends on the ambient temperature and status of recharge level.

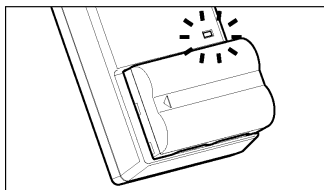

3

When the charge lamp goes out, charging is completed. Remove the battery from the charger and remove the power cable plug from the wall outlet.

- We recommend charging the battery before using the camera again. If it is not used for several days, battery performance decreases.
- In the case that the number of possible shots will decrease extremely after charging, it may indicate the end of battery life. Please purchase a new battery.

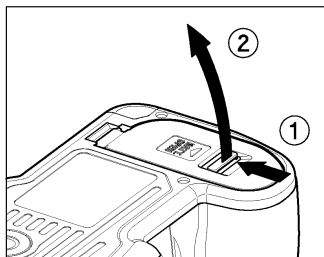

LOADING THE BATTERY

1

Confirm that the D dial is in the **OFF** position, and open the cover by sliding the battery compartment cover latch in the direction of the arrow, as shown in the instruction.

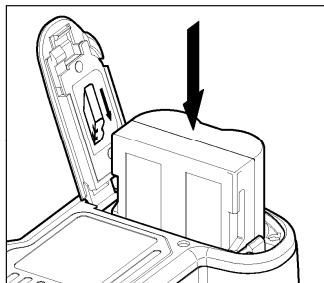

2

Insert the battery in accordance with diagram inside the cover.

- Insert the battery until it locks into place.

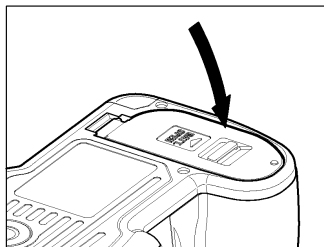

3

Close the cover securely.

- Push the cover until it clicks into the locked position.

WARNING!!

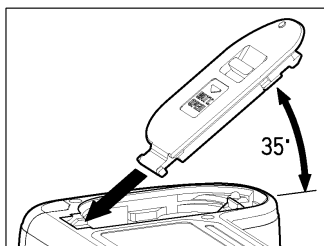

It is possible to remove battery cover, if it is tilted around 35° . If this part comes off during opening or closing the cover, please insert cover as shown in the illustration.

TO REMOVE THE BATTERY

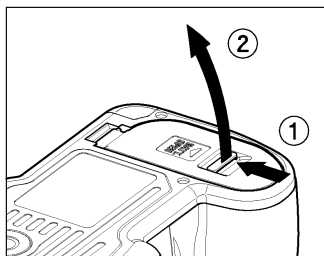

1

Turn the “D”- dial to the **OFF** position, and open the battery compartment cover by sliding battery compartment cover latch in the direction as shown by the arrow.

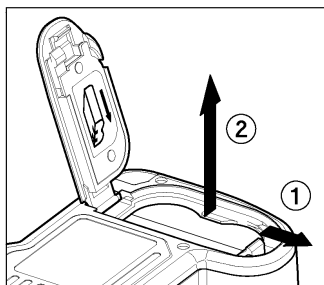

2



Eject the battery by sliding the battery compartment cover latch in the direction of the arrow, as shown in the illustration.

WARNING!!

- While the CF Card busy light is on, please do not remove the battery. Doing so can result data loss. Moreover, Camera, CF card and Microdrive may be damaged.

CHECKING THE BATTERY STATUS

When “D”-dial is set to drive area (p.14), the battery icon, which shows the capacity of the battery, is shown on the top LCD panel. Explanations of the symbols are given as follows.

	Battery Status
	The battery strength is sufficient.
	The battery level is low and the battery will need to be changed soon.
	The power of the battery is insufficient, replace the battery immediately.

POWER SAVING

To conserve the battery, the camera has several power-saving features. After six seconds of non-operation certain camera systems automatically shut down: the shutter speed and aperture value disappear from the top LCD panel, the display in the viewfinder turns off, and some buttons no longer work (however, it is still be possible to review images or change menu settings on the color LCD monitor). Press the shutter button halfway to reactivate the camera. To prevent the shutter from being accidentally released, turn the D-dial to the **OFF** position whenever the camera is not in use.

Additionally, if the color LCD monitor is not used for a set amount of time, the camera goes into a low-power mode. The VIEW and MENU buttons are not active when the camera is in low-power mode. This feature prevents the color LCD from being accidentally turned on and draining the battery while the camera is not being used. To reactivate the VIEW and MENU buttons, press the shutter button halfway. For more information see p.115.

USING A HOME POWER SUPPLY (Sold Separately)

You can power the camera from a wall outlet using the provided AC Adapter - (SAC-2). When using your camera for an extended period of time, reviewing the pictures or connecting the camera to a computer or cleaning the image sensor, we recommend that you operate the camera from a household power outlet.

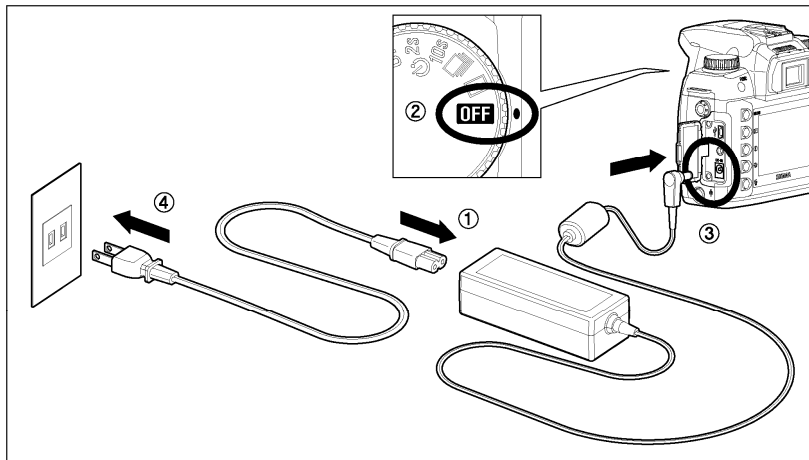

1

Connect the AC cable to the AC adapter. ①

2

Connect the plug of the AC adapter to the camera. ②, ③

3

Insert the plug of the AC cable into a wall outlet. ④

When you have finished using the camera, please disconnect the plug from the wall socket.

When using the SD14 with an AC power supply, the battery icon shows the full symbol, regardless of the power level of the battery. If you start to operate the camera on battery power, the display will change and show the remaining power level of the battery.

WARNING!!

- While the CF card busy light is on, do not change the power supply by any means. Doing so can result in data loss or damage to the camera, CF card or Microdrive.

MOUNTING AND REMOVING THE LENS

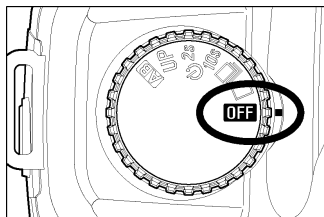

1

Make sure to turn the “D”-Dial to **OFF** position (Power Off position)

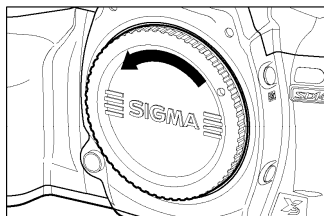

2

Remove the camera body cap and the rear cap of the lens'.

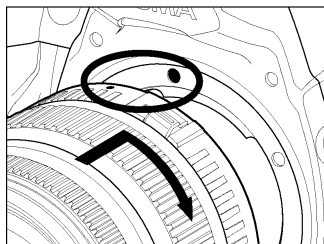

3

Align the red mark on the camera's mount with the red dot on the lens. Insert the lens into the mount of the camera, and rotate the lens clockwise until it clicks into the locked position.

CAUTION !!

- To ensure a proper connection, do not hold down the lens lock button while mounting the lens.
- The SD14 camera contains a dust protector, located inside the lens mount. The dust protector is a very delicate device. Take care not to cause scratch its surface. Touching or pushing it with your fingers can easily damage it. If there is dirt or dust on it, please refer to the Maintenance section of your manual (P.109).

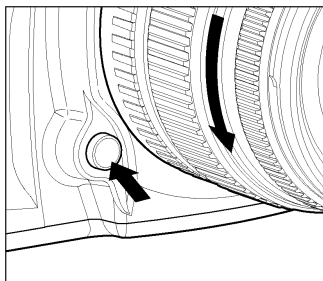

4

To remove the lens, press the lens lock button and turn the lens counter-clockwise until it stops. Gently remove the lens from the camera body.

CAUTION !!

- On the mount surface of the lens, there are a number of electrical contacts. Keep them clean to ensure proper connection. To avoid damaging them, be sure to place the lens on its front end when it is off the camera.

SETTING THE LANGUAGE

Camera menus and messages that appear on the color LCD monitor can be displayed in either English, Japanese, German or French and other languages. You should receive the SD14 camera pre-set to English, however, if necessary, you can change the camera language yourself.

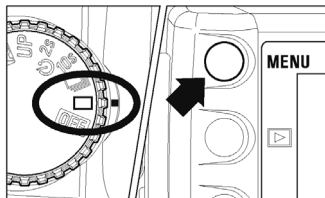

1

Make sure the camera is turned on.



2

Press the **MENU** button on the back of the camera to display the Camera Set-up Menu. (See P.104)

3

Use the  arrows on the 4-way controller to select "**Language**".

4

Press the  arrow or  to open the sub-menu.





5

Use the  arrows on the 4-way controller to select the desired language.



English	English
日本語	Japanese
Deutsch	Germany
中文	Chinese
Français	French
Español	Spanish
Italiano	Italy
한국어	Korean

6

Press the  arrow or  to apply the setting or the  arrow or  to close the sub-menu without making any changes.

SETTING THE TIME AND DATE

The SD14 camera records the date and time when each image is captured and stores this information with the image. To ensure that the correct information is recorded with each image, set the camera's internal clock to the correct date and time before using the camera for the first time or after extended periods of disuse.

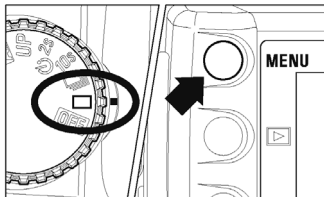

1
Make sure the camera is turned on.

2
Press the **MENU** button on the back of the camera to display the Camera Set-up Menu. (See P.104)

3
Use the \blacktriangle arrows on the 4-way controller to select "Date/Time...".

4
Press the \blacktriangleright arrow or the OK to open the date/time set-up page.

5
Use the \blacktriangle arrows on the 4-way controller to select a setting and use the \blacktriangleleft arrows to cycle through the setting options.

6
Once all changes have been made, press OK to save the settings and return to the main menu.

• Press \times at any time to close the date/time set-up page without saving any of the changes.

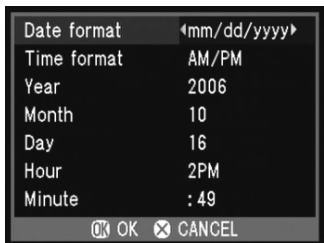

TIP

- The date can be displayed in one of three formats: mm/dd/yyyy (month/day/year), dd/mm/yyyy (day/month/year), or yyyy/mm/dd (year/month/day).
- The camera's internal clock is powered by a capacitor that receives its charge from camera's battery. If the camera is without battery for an extended period of time, such as after prolonged storage, the internal clock will need to be reset.
- You can synchronize the date and time on the SD14 camera to your computer by using the "Set Date and Time..." option in the Camera menu of the SIGMA Photo Pro software (See SIGMA Photo Pro Manual provided on the CD-ROM).

INSERTING AND REMOVING THE CF CARD

The SD14 camera uses CompactFlash™ (CF) cards to store images. The camera supports both Type I and Type II CF cards, including Microdrives.

TO INSERT THE CF CARD

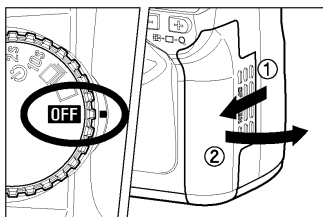

1
Set the “D”-Dial to the **OFF** position.

2
Open the CF card cover, as shown in the illustration.

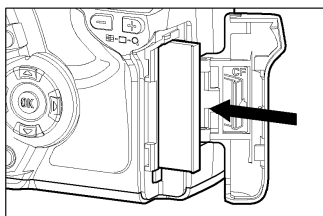

3
Position the CF card with the label facing toward the CF card cover and insert the CF card smoothly, in the direction of the arrow, as far as it can go into the slot.

- The eject button will pop out slightly.

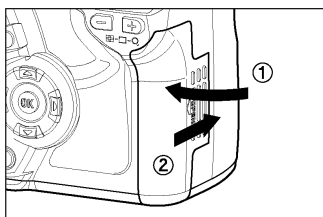

4
Close the CF Card Cover and slide it in the direction shown by the arrow, until it clicks shut

TIP

- It may be necessary to format the CF card before use. (See P.30)

TO REMOVE THE CF CARD

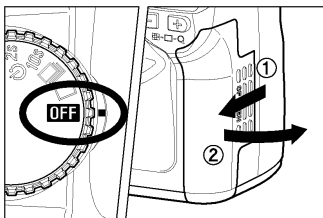

1

Set the "D"-Dial to the **OFF** position.

- Make sure that the CF card busy light is off, before continuing.

2

Slide the CF Card Cover until it pops open.

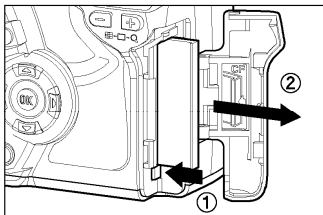

3

Press the Eject button to eject the CF card.

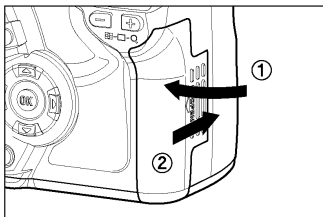

4

Close CF Card Cover and slide it in the direction shown by the arrow until it clicks shut

CAUTION !!

- Never do any of the following while the CF Card busy light is on. (The CF card busy light indicates when the camera is writing, reading, or erasing images from the CF card. Doing any of the following may cause image data to be lost or corrupted.)
 1. Do not open the CF card cover or remove the CF card.
 2. Do not open the battery cover or remove the battery.
 3. Do not apply shocks or vibrations to the camera.

TIP

- If the "D"-Dial is set to the **OFF** position while the CF Card busy light is on, the camera will remain on until it is done processing images or accessing the CF card.

FORMATTING THE CF CARD

New CF cards must be formatted before use. In addition, cards with corrupt or incompatible file systems may need to be formatted before use.

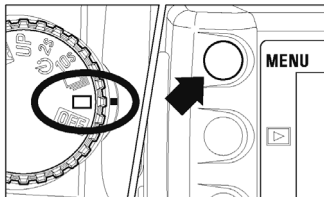

TO FORMAT THE CF CARD

1

Make sure the camera is turned on.

2

Press the **MENU** button on the back of the camera to display the Camera Set-up Menu. (See P.104)

3

Use \blacktriangle arrows on the 4-way controller to select "Format CF Card...".

4

Press \blacktriangleright arrow or **OK** to open the confirmation dialog.

5

Press **OK** to format the CF card or **X** to close the confirmation dialog without formatting the card.

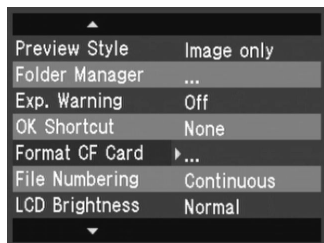

CAUTION !!

- Formatting erases all card contents, including locked SD14 images and all non-SD14 files. Review card contents carefully before formatting.

TIP

- Cards formatted in other cameras or devices may not operate correctly in the SD14 camera or may have reduced capacity. To store the maximum number of SD14 images, format the CF card in the SD14 camera before use.

FILE NUMBERING SYSTEM

The images you take are automatically assigned file numbers from 0001 to 9999. When images are being reviewed, the file number of each image is displayed in the left corner of the Info Strip (see P.77). The file number is also incorporated into the filename of the image. The filename consists of "SDIM" followed by the 4-digit file number and extension. For example: image number 0023 will be stored in the file SDIM0023.X3F. All SD14 image files will be stored in the /###SIGMA folder on the CF card.

File numbering can be continuous, or can be reset every time an empty card is detected. Use the Camera Set-up Menu to set the file numbering system.

FILE NUMBERING OPTIONS

OPTION	DESCRIPTION
Continuous (Default)	Numbering is continuous. The first file number assigned on an empty card will be one higher than the last assigned number. (If the inserted card contains SD14 images with file numbers greater than the last assigned number, file numbering will continue with one higher than the highest file number on the card.)
Auto Reset	Each time an empty CF card is inserted, or all images on the current card are deleted, the file number will reset to its default value of 0001. (If the inserted card already contains SD14 images, the file number will not be reset).

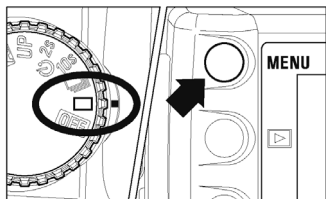

TO SET FILE NUMBERING SYSTEM

1

Make sure the camera is turned on.

2

Press the **MENU** button on the back of the camera to display the Camera Set-up Menu. (See P.104)

3

Use  arrows on the 4-way controller to select "File Numbering".

4

Press  arrow or  to open the sub-menu.

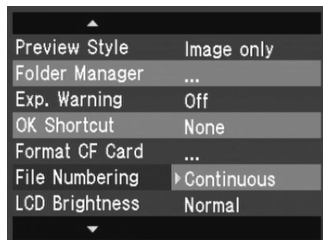

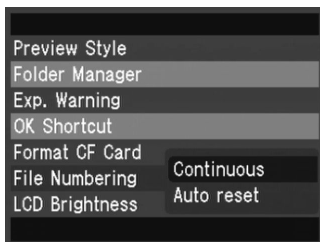

5 Use \blacktriangle arrows on the 4-way controller to select numbering system.

6 Press \blacktriangleright arrow or OK to apply the setting or \blacktriangleleft arrow or \times to close the sub-menu without making any changes.

FOLDER MANAGER

You can create and choose folders in which photographs will be stored.

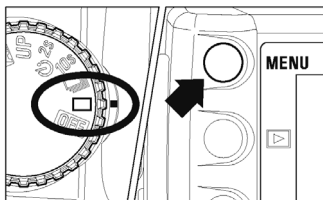

1 Turn the "D"-dial to the drive area to turn on the camera.

2 Press the **MENU** button on the back of the camera to display the Camera Set-up Menu. (P.104)

3 Use the \blacktriangle arrows on the 4-way controller to select "Folder Manager".

4 Press the \blacktriangleright arrow or the OK button to open the sub menu.

5 Use the \blacktriangle arrows on the 4-way controller to select "Create Folder".

6 Use the \blacktriangleleft arrows on the 4-way controller to select the desired folder number. (Default number is the lowest number). It is possible to select a folder number up to 999.

7 Press OK to create the file or \times to cancel.

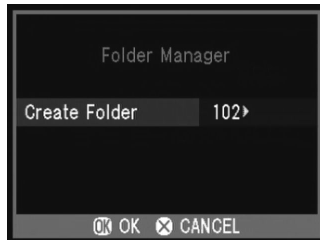
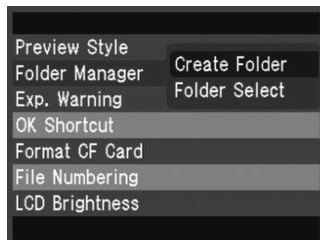

NOTE

- The images will be recorded in the latest created folder.
- In the case of File number being set to Continuous, the number of recording image will be consecutive number. In the case of File number being set to Auto reset, the number will start from 0001.
- You can select a folder number from the consecutive number of the latest folder number to 999. It is not possible to create folder numbers lower than the latest folder number.
- If you change the recording folder, please select "Folder Select" in Folder Manager. Use the ◀▶ arrows on the 4-way controller to select the desired folder number and press **OK** to confirm.

FRAME NUMBER COUNTER

This display shows the number of images that can be recorded on the CF-card.

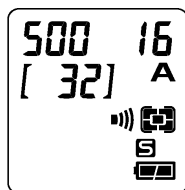

- The number of images that can be recorded on the CF card depends on the settings you choose.

For example, in the illustration on the left, 32 pictures can be stored on the CF card. (The number shown in the counter is only an estimate. The actual number of images, which can be recorded, will depend on the subject, shooting conditions and shooting mode.)

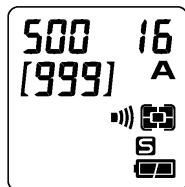

- Even if it is possible to record more than 999 images on the CF -card, the maximum number of frames that can be displayed by the counter is 999.

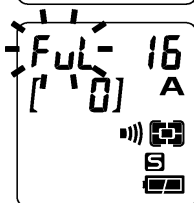

- If no more space is available to store images on the CF-card, the frame number will be "0" and the Shutter Speed display will show "FuL" and blink.

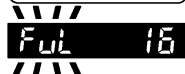

- You can also see "FuL" shown in the viewfinder.

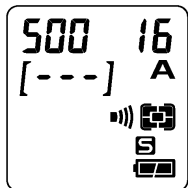

- If a CF-card is not inserted into the camera, “0” appears on the LCD panel.

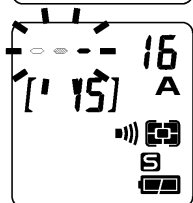

- When the camera is turned on and occupied with the image processing, the frame number value blinks on the top LCD panel. A cursor will be in motion on the frame number value to show the progress.

- The shutter will not release when the camera is busy with processing. It is necessary to await the end of the processing before taking a picture.

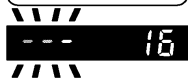

DIOPTER ADJUSTMENT

Adjust the viewfinder diopter so that you can see clearly through the viewfinder.

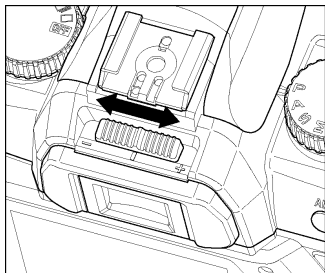

While looking through the viewfinder, slide the diopter adjuster to the left or to the right, until the image appears sharp on the focus screen.

TIP

- The camera's adjustable diopter range is -3 to $+1.5$ dpt.
- If you still cannot see the viewfinder clearly, we suggest that you purchase a viewfinder diopter adjustment eyepiece and use it together with the built-in diopter adjuster.

TOP LCD ILLUMINATION

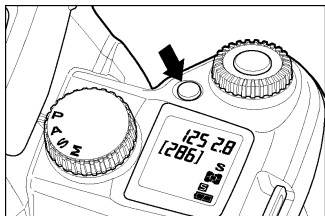

Pressing the “Top LCD Illumination Button” activates the orange color LCD illuminator, allowing the Top LCD display to be read in the dark.

NOTE

- The top LCD illumination will not function if the camera is in Power Saving Mode (P.22). Press the shutter button “halfway down” to activate the exposure meter of the camera (aperture and shutter speed values will be shown on the LCD monitor).
- If the shutter button is pressed, the top LCD illumination will be turned off.
- Illumination will continue during operation of the buttons or dials. Illumination will disappear 6 seconds after stopping operating the camera.
- Top LCD illumination does not function when build in flash is charged.

HOLDING THE CAMERA

To avoid camera shake, which can cause blurring of your photograph, hold the camera steady.

- Firmly grasp the camera’s grip with your right hand.
- Hold the camera steady with your left hand and support the bottom of the camera and the lens.
- Place your eye as close to the viewfinder as possible.
- Keep your elbow close to your body and take a half step forward for a more stable stance.

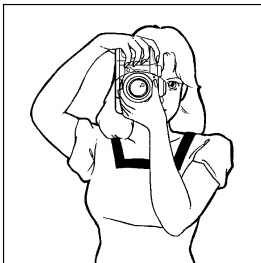
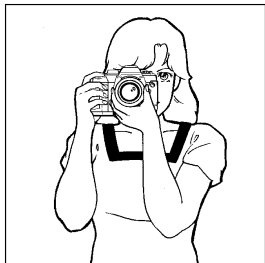

SHUTTER BUTTON

The shutter button of the SD14 camera has two positions. When you press the shutter button “halfway down”, the camera’s autofocus and Exposure Systems activate. When you press the button “all-the-way down”, and the shutter will release to take a picture.

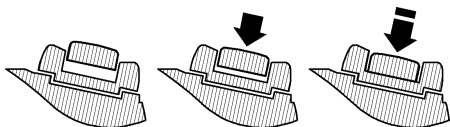

TIP

- Before you start to take pictures, we recommend that you operate the camera, to become familiar with the “halfway down” position and other features of the camera.

SETTING THE ELECTRONIC SOUND

The camera will inform you with an electronic “beep”, when it has confirmed focus. It is possible to disable this electronic beep, if you desire.

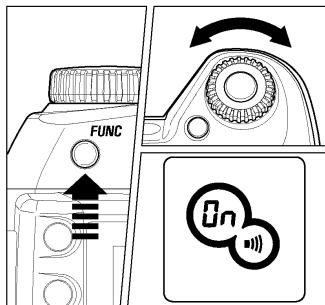

1

Press the *FUNC* button 5 times and hold. The LCD panel will show the  symbol. Do not release the *FUNC* button.

2

Press and hold the *FUNC* button and turn the “C”-dial. Select  to enable the “beep” sound or “- -” to cancel it.

TIP

- When  is shown on the LCD panel, the electronic beep is on. If no symbol shown the beep is off.
- The electronic beep cannot be turned off when you use the self-timer mode or a remote control.

BASIC OPERATION

SELECTING THE EXPOSURE MODE

The features and the operation methods of the four different exposure modes of the camera are explained below.

P PROGRAM AE

To make picture taking easier, the camera will automatically select an appropriate combination of shutter speed and aperture value, according to the brightness of the subject.

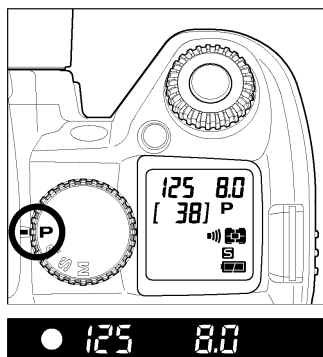

1

Set the "D"-Dial to the "Drive Area" (P.14).

2

Set the "Mode"-Dial to the **P** position.

3

Press the shutter button "half-way" to verify the focus and exposure display in the viewfinder.

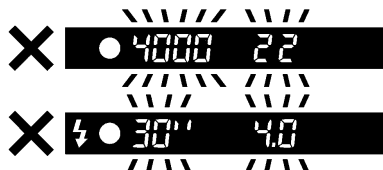

If the subject is too bright or dark, both shutter speed and aperture value indicators will blink and will show the limit values. If you take a picture with these settings, the picture will be overexposed or underexposed.



⚡ When this symbol blinks, shutter speed may be too slow and picture may be blurred. In this case, please use a flash (P.43) or use a tripod to prevent blurring.

PROGRAM SHIFT

You can change the combination of shutter speed and aperture value, which were automatically selected by the camera. While turning the “C”-Dial, the combination of shutter speed and aperture value will change within the range of combinations that give the equivalent exposure.

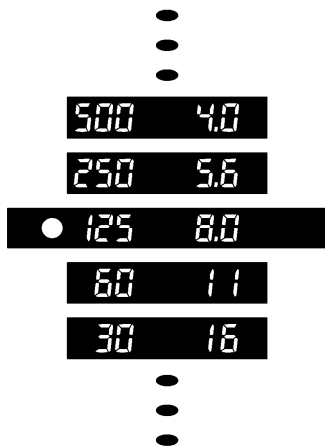
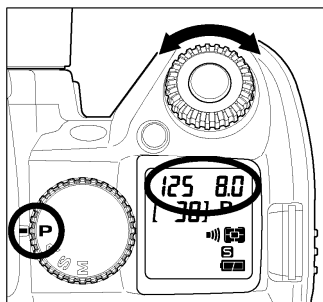

- It will be canceled automatically, after taking the picture.
- A program shift cannot be performed while using the flash.

A APERTURE PRIORITY AE

After you set the aperture, the camera will determine the appropriate shutter speed. If you select smaller apertures, depth of field will be greater. Larger apertures tend to blur the background, as depth of field will be shallower.

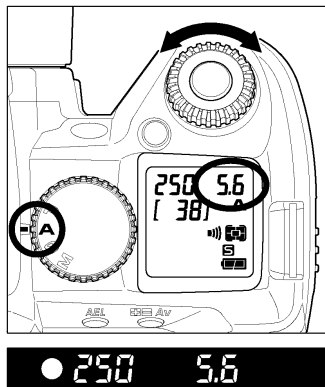

1

Set the "D"-Dial to "Drive-Area" (P.14).

2

Set the "Mode"-Dial to the **A** position

3

Press the shutter button "Half-Way" to verify the focus, and select the desired aperture value by turning the "C" -Dial.

4

Verify the setting in the viewfinder.



If the appropriate shutter speed is outside the range of suitable combinations due to the subject being too bright or too dark, the shutter speed indicator will blink. If the subject is too bright, set the aperture value to a smaller one (larger F-number). If the subject is too dark, set the aperture value to a larger one (smaller F-number) until the indicator stops blinking.

S SHUTTER SPEED PRIORITY AE

When you set the desired shutter speed, the camera will select the appropriate aperture value for correct exposure. You can achieve stop action effects by selecting a fast shutter speed, or give the feeling of motion to a moving subject by selecting a slow shutter speed.

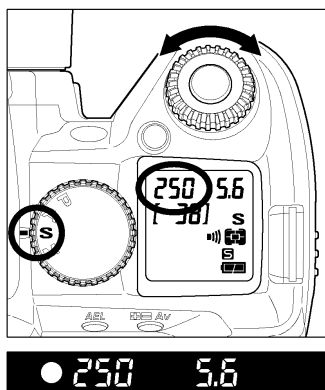

1

Set the “D”-Dial to the “Drive –Area” (P.14).

2

Set the “mode”-Dial to the “S” position.

3

Press the shutter button “halfway” to verify the focus, and select the desired shutter speed value by turning the “C” –Dial.

4

Verify the setting in the viewfinder.



If the appropriate aperture value is beyond the range of the lens in use, due to the subject being too bright or too dark, the aperture value indicator will blink. If the subject is too bright, set the shutter speed to a faster one, or if the subject is too dark, set the shutter speed to a slower one, until the indicator stops blinking.

M MANUAL EXPOSURE

Set both the shutter speed and aperture value according to the indication of the exposure meter. You can change the exposure, as you desire.

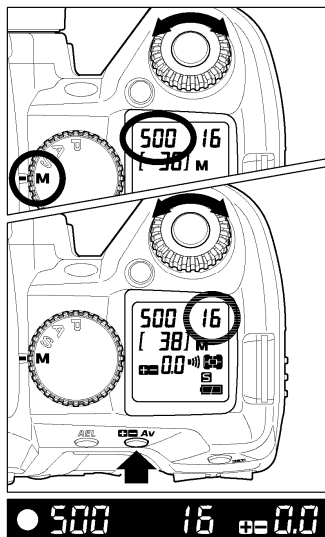

1
Set the “D”-Dial to the “Drive-Area” (P.14).

2
Set the “Mode”-Dial to the “M” position.



3
Press the shutter button “Half-Way” to verify the focus, and rotate C dial to select the desired shutter speed.

4
While pressing  Av button, rotate C dial to select the desired aperture.

5
Verify the settings in the viewfinder.

To determine the exposure value using the camera's exposure meter

Rotate the “mode”-Dial to the **M** position. When you press the shutter button “Half-way”, the shutter speed and aperture value are displayed in the viewfinder, and the display indicates the difference between the manually selected exposure and the metered exposure. Such as

-  **1.7** 1 2/3 Step Below (under exposure)
-  **0.0** Correct Exposure
-  **3.0** 3.0 Over (over exposure)

The exposure meter can display an exposure error of up to ± 3 stops from the correct exposure in $1/3$ steps. If the exposure error is more than three stops, the exposure meter will blink.

BULB SETTING

When long time exposures are required (for shooting night scenes or very dark subjects) the use of the “Bulb” setting is recommended. Please use a tripod, when taking pictures with this setting. Bulb photography can be performed only when ISO sensitivity is set to ISO100 and 200. (Please refer to P.57 about setting ISO sensitivity.)

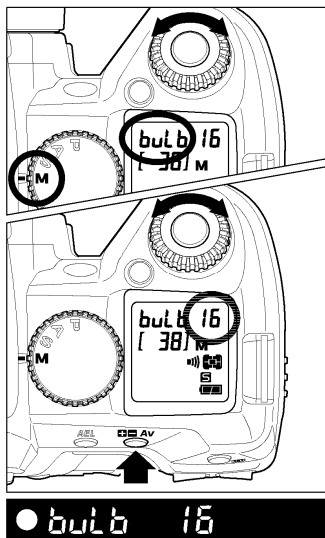

1

Set the “D”-Dial on the “Drive Area” (P.14).

2

Set the “Mode”-Dial to the “M” position.

3

Rotate the “C” -dial until *bulb* is displayed on the top LCD panel’s shutter speed location.

4

While pressing **Av** button, rotate the “C” -dial to select the desired aperture.

5

Depress the shutter button fully to take the picture.

CAUTION !!

- It is not possible to use Bulb photography for more than 30 seconds. The shutter will automatically close about 30 seconds after the shutter button was pressed.

USING THE BUILT-IN FLASH

The cameras have built-in flash for taking pictures at night or in low light, which is very convenient.

USING THE BUILT-IN FLASH

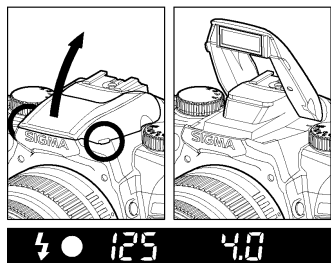

P mode, use this mode for automatic photography. The flash sync speed and aperture are set automatically. If the subject is too dark, the flash indicator "⚡" in viewfinder will blink, then you can take a flash exposure by following.

1

Grasp the built-in flash (see picture) and lift it up gently.

2

Wait for the ⚡ mark to appear in the viewfinder.

- When you lift up the built-in flash, it will start charging. While the built-in flash is charging, the ⚡ mark is not visible, but when the flash is sufficiently charged, the indicator in viewfinder and on the LCD panel, will show ⚡ mark.
- During the charging, the shutter cannot be released.
- After you finish using the built-in flash, close the flash head by pressing the top part of the flash down.
- When you use the built-in flash continuously, the grip of the camera will become warm. This is normal and not a defect.

CAUTION !!

- The lens hood may intrude into the light path of the built-in flash unit, resulting in a shadow at the bottom of the picture. (The same phenomenon is possible with a lens, which has a large front lens and long length) Either remove the lens hood, or use an external Sigma dedicated flash.
- To prevent overheating and protect the built-in flash unit after using continuous shooting with flash, please do not use your flash for a while.

EXPOSURE MODE AND BUILT-IN FLASH

P mode

Depending on the brightness of the subject, the most appropriate shutter speed (between 1/60~1/180 sec) and aperture will be selected.

In bright situations, the flash will be “daylight synchronization flash”, and the camera will calculate the appropriate flash amount for the correct exposure, of both the subject and background. If the ambient light is too great, resulting in overexposure, the shutter speed and aperture value displays will blink. If the subject is too dark, the camera will proceed to take a flash exposure with the aperture fully open.

A mode

Use this mode if you want to set the desired aperture value. The camera will select the appropriate shutter speed for the background. The shutter speed will operate at 1/180 or slower. In bright situation, the camera will work the same as P mode for daylight synchronization flash and it can obtain a balanced exposure between the subject and background. If the maximum synchronized shutter speed is displayed and is blinking, please set the aperture value to a smaller aperture value (large F-number). If the subject is too dark, the flash will use slow synchronization.

S mode

Use this mode if you want to set a specific shutter speed. The camera will select the appropriate aperture value for the background. The shutter speed will operate between 1/180 or slower. The camera will automatically correct the shutter speed to the highest synchronization speed even if you select a higher shutter speed. If the subject is too bright, the flash will be set to daylight synchronized. Then you can obtain a balanced exposure between subject and background. When the lens smallest aperture (largest F-number) value is blinking, the picture will be over-exposed. If the subject is too dark, the camera will display the largest aperture value (small F-number) blinking, but the flash will operate with correct exposure.

M mode

This mode enables you to set both flash synchronized speed and aperture value. If you set a synchronized speed faster than 1/180, the shutter speed will be set automatically to 1/180. If the exposure meter indicates appropriate number, you will obtain the correct exposure for the subject and background. If the exposure meter indicates minus (under), you will obtain the correct exposure for subject, but the background will be dark. If the exposure meter indicates plus (over), both the subject and the background may be over-exposed.

CAUTION !!

- When **P** and **A** modes are showing the shutter speed as 1/200sec., the actual shutter speed value is 1/180sec. In the case of **S** and **M** modes, please select 1/200sec., if you wish to set the shutter speed to 1/180sec.
- If the flash is set on the wireless mode, the shutter synchronized speed will be set automatically to 1/60 second. Please refer to the wireless mode page **45**.

FUNCTION SETTING OF FLASH

In addition to regular flash photography, the built-in flash also incorporates redeye reduction function. Further it is also possible to use it during the wireless TTL flash mode if you purchase an optional external flash unit (DG SUPER SA-STTL only).

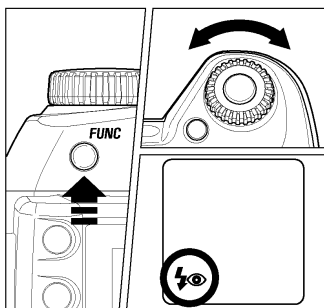

1

Press the **FUNC** button 3 times and hold. The LCD panel will display the flash mark (⚡). Do not release the **FUNC** button.

2

Continue holding the **FUNC** button and turn the "C"-dial to select the flash mode desired.



NORMAL FLASH

When you lift up the built-in flash, you can use your camera with Normal Flash. Please use this mode for ordinary photography.



RED-EYE REDUCTION FLASH

When you take a picture with flash, sometimes the person's eyes reflect the flashlight and the "redeye" phenomenon will appear in the picture.

In order to avoid this effect, the red-eye reduction lamp lights approx.1sec before the main flash fires, this reduces the effect of the "redeye" phenomenon in the picture.

■ Depending on the lighting and subject conditions, the Redeye Reduction flash may not completely eliminate the redeye in all cases.



C1~C3 WIRELESS TTL FLASH MODE

It is possible to take pictures with Wireless TTL Flash Mode, if you use the optional external flash SIGMA EF SUPER series (only this Flash Type is compatible with wireless flash photography). Please refer to the Instruction Manual of the DG SUPER SA-STTL for more details.

FOCUSING

Adjustment of autofocus and manual focus operation are explained below.

HOW TO USE AUTOFOCUS

It is possible to use Autofocus function only with AF Lenses. Your camera is equipped with highly precise AF System and incorporates two different autofocus modes. (In the case of Mirror lenses and some specialized lenses, the camera can be use only in Manual Focus mode).

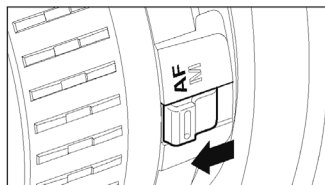

SETTING THE AUTOFOCUS MODE

1

Set the focus mode switch of the lens, to **AF**.



2

Decide the composition through the viewfinder and press the shutter button halfway (if the autofocusing is selected, the camera confirms focusing with an electronic sound and a red "in-focus" indicator appears in the viewfinder) .

Although your camera is equipped with highly precise AF system, in some cases autofocus cannot set correctly.

- Low-contrast subjects, such as blue sky or blank wall, etc. or when the color of the subject is same as background.
- The subject is located in a very low light environment
- Overlapping near and far objects, such as an animal behind a fence
- A subject, which moves with a high speed
- Subjects, which have repeated patterns such as building windows.

In such cases, please use one of the following focusing methods.

1. Use the Focus Lock function to focus on another subject, which has a similar focusing distance as your subject.
2. Set the lens to MF mode and focus manually.

SELECTING THE AUTOFOCUS MODE

Press the **FUNC** button twice (holding the button down the second time) and turn the “C”-dial to select either **S** (Single AF Mode) or **C** (Continuous Mode) icon on the LCD panel.

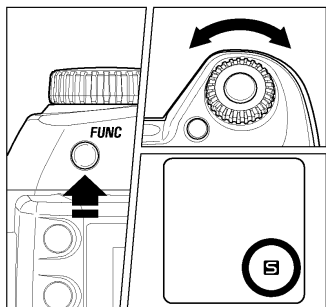

S SINGLE AF MODE

Depress and hold the shutter button “Half-way” to activate the autofocus function. In order to avoid out of focus exposures, the shutter cannot be released until the subject is in focus. This is called “focus priority”. The Focus Indicator lights up in the viewfinder, when the AF Point Selection is focused on the subject and the focus is locked. Press the shutter button the rest of the way to take the picture. If the camera cannot focus on the subject properly, remove your finger from the shutter button and press again.

- Focus indicator will blink, if the subject is out of focus.
- Use your camera in this mode for regular photography.

C CONTINUOUS AF MODE

Press the shutter button “Half-way” to activate the autofocus function. If the subject is in motion, the camera will focus continuously with motion prediction function. You can release the shutter any time, even if the subject is not precisely in focus. However, depending on the subject situation, (i.e. speed and direction of moving subject, the lens and shutter speed etc.) there is a possibility that the picture may be out of focus.

- Focus indicator will not appear.
- Autofocus lock does not work.
- Depending on some unusual conditions of the subject, sometimes autofocusing is not possible.
- When the Automatic Selection mode of the AF Point Selection is selected, the camera automatically selects the initial focus point for tracking the subject.

AF POINT SELECTION

The SD14 is equipped with 5 focusing points. Selecting the AF point can be done automatically or manually by the photographer.

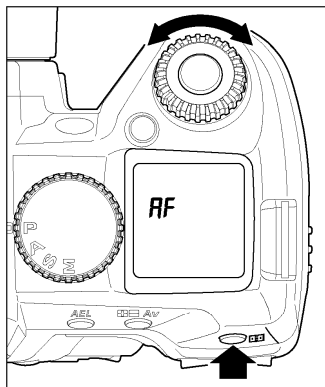

Press **[AF]** button and select the desired AF point by rotating the “C”-dial displayed in the viewfinder.

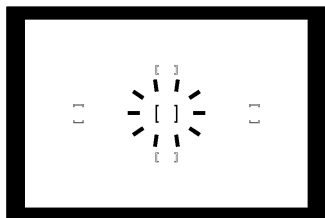

- The Selected AF point will be illuminated in red in the viewfinder.
- Automatic AF point selection can be achieved when the five focusing points in the viewfinder are illuminated in red.

- When you rotate the “C”-dial clockwise, the selection will occur in the looping sequence that follows.



AF AUXILIARY LIGHT

The built-in AF Auxiliary Light of the SD14 enables focusing in low light conditions.

- The AF Auxiliary Light can be used with **S** (Single AF mode) and automatic or center focus AF point selection only.
- The AF Auxiliary Light is effective with the center focus of the automatic AF selection only.
- The effective distance of the AF Auxiliary Light is 3m.

CAUTION!!

- The lens hood must be removed when the AF Auxiliary Light is used. The AF Auxiliary Light may not work correctly if long and large diameter lenses are attached to the camera as they may interfere with the beam.
- If the AF Auxiliary Light is continuously used, it may turn off temporarily in order to protect the lamp. The AF Auxiliary Light can be used again after a short pause.
- Do not use the AF Auxiliary Light for other purposes (lighting etc.) as continuous use of the AF Auxiliary Light will cause damage .

The AF Auxiliary Light can be turned off as follows.

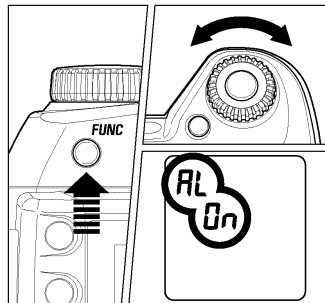

1

Press **FUNC** button six times (press and hold the button at the sixth depression) , **AL** mark will be displayed on the top LCD. Do not release the **FUNC** button.

2

Continue to press and hold the **FUNC** button and rotate the "C"-dial, - - mark deactivates the AF auxiliary light.

It is possible to use the AF Auxiliary Light by selecting the **ON** icon.

FOCUS LOCK

This photography method is useful if a photographic subject is not positioned within the central AF frame.

1

Choose the AF point according to the "AF POINT SELECTION" instructions on page 48.

2

Position the photographic subject into the selected AF frame, and focus by pressing the shutter button half-way.

3

Keep the shutter button depressed half-way while you compose the picture as desired. Then press the shutter button the rest of the way to take picture.

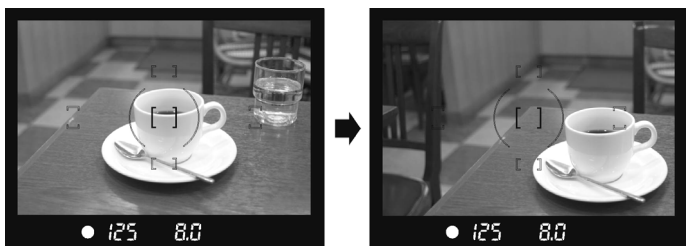

- Focus Lock can be used with **S** (single AF mode) only. The AF cannot be locked in **C** (continuous AF mode).

MANUAL FOCUS

In situations, where autofocus or focus lock is not effective, you can focus manually.

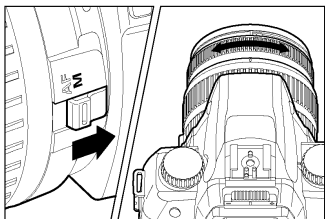

1

Set the focus mode switch, on the lens to the **M** position (AF mode mark will disappear from the LCD panel).

2

While looking through the viewfinder, turn the focusing ring on the lens until you get a clear sharp image.

- When you use a lens, which has maximum aperture of F5.6 or faster, the focus indicator in the viewfinder will appear, when correct focus is attained.

OPERATION OF THE DRIVE MODE

Operation of the self-timer, and other functions of the camera are explained by the following:

DRIVE-AREA

Some of the important operations and settings of the camera can be activated by the drive area of the "D"-dial. Such as single frame shooting, continuous shooting, self-timer, and mirror lock-up.

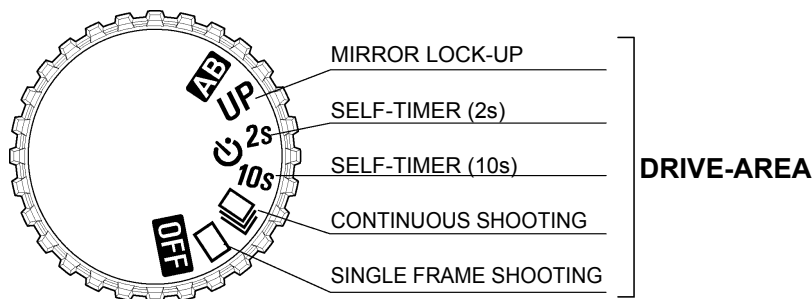





□ SINGLE FRAME SHOOTING

When you press the shutter button in the single frame-shooting mode, only one frame will be exposed. Then the camera will be ready for the next shot by advancing one frame. Single frame shooting mode is recommended for ordinary photography.

CONTINUOUS SHOOTING

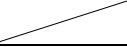

In this mode, when you keep the shutter button fully depressed, the camera will take pictures continuously. At the time of continuous shooting the number of frames per sec. is given below.

The maximum number of frames and speed of continuous shooting are as follows:

		RES (Recording mode)			
		 Super Hi	 HI	 MED	 LOW
QUAL (Recording quality)	RAW		6	12	24
			3.0	3.0	3.0
	FINE	6	6	12	24
		3.0	3.0	3.0	3.0
	NORM	6	6	12	24
		3.0	3.0	3.0	3.0
	BASIC	6	6	12	24
		3.0	3.0	3.0	3.0

The upper rows show the maximum number of frames, the lower rows show the maximum shooting speed in continuous mode (frames per second).

CAUTION !!

- When AF mode is set to AF  (Single AF mode) mode and the focus indicator in the viewfinder is on, focus distance and exposure value are fixed at the setting for the first picture. It is possible that focus and exposure could be incorrect, if subject moves or the brightness changes. When AF mode is set to AF  mode (Continuous AF mode), then camera will focus on the subject continuously. However, depending on the subject situation, since the shutter release has the first priority there is a possibility that the picture may be out of focus.
- When you use the continuous shooting mode with external flash, the camera may be slow, because the camera will not take pictures, while the flash is re-charging.
- Images taken in rapid succession, such as during Continuous shooting, are initially stored in the camera's internal memory buffer. This allows you to continue shooting without having to wait for images to be recorded to the CF card. Once the memory buffer is full, the shutter will be disabled until some images have been transferred to the CF card.

SELF TIMER

When you want to include yourself in the picture or avoid camera shake, please use the self-timer.

When you set the self-timer to **10s**, then the shutter will be released 10seconds after you fully press the shutter button.

When you set the self-timer to **2s**, then the shutter will be released 2seconds after you fully press the shutter button.

After you decide the composition of your picture, press the shutter button "Half-way" and adjust the focusing. Then, when you press the shutter button the rest of the way, the display in the viewfinder will disappear and the self-timer will be activated. During the self-timer operation you will hear an electronic beeping sound. The beeping sound will be much faster during the last two seconds, before the shutter is released. The LCD panel will also countdown the remaining time.

- You will hear the electronic sound during "Self-timer" operation, even if you set the electronic sound option to OFF.
- If you want to cancel the "Self-timer" operation, turn the "D"-dial to another position.
- When you start the "Self-timer" and do not look through the viewfinder, attach the finder cap to the viewfinder eyepiece to prevent light entering.

UP MIRROR LOCK-UP

If you want to reduce the camera's vibration such as during Macro Photography or when using long telephoto lenses, use the Mirror Lock-up function.

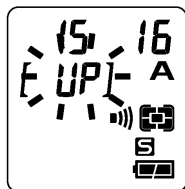

Set the "D"-Dial to the "UP" position. When you press the shutter button "Half-way" the camera will set the focus and exposure. As you press the shutter button further, the mirror will move up and the exposure value will be memorized.

Remove your finger from the shutter button and lightly press again to release the shutter.

Mirror lock-up function can be cancelled manually by turning the "D"-dial away from the "up" position.

CAUTION !!

- Mirror lock up will cancel automatically, and mirror will return to its original position, after 30 seconds. You can reactivate the mirror lock-up function by pressing the shutter button "Half-way" again.

WARNING !!

- If you are using this function in a strong light source, there is a possibility that light entering through the lens, might degrade the image. Please refrain from using the mirror lock-up function in such an environment.

TIP

- It is possible to use Mirror Lock-up with remote control (Sold Separately). Please refer to page 67,68.









ADVANCED OPERATION

This section explains the application of the more advanced functions of your camera, when composing the expressions of your picture.

SETTING THE WHITE BALANCE (WB)

The color of light reflected by an object can vary depending on the color of the light source illuminating it. For example, a neutral colored object will reflect reddish light under incandescent lighting, and greenish light under fluorescent lighting. The human brain is able to compensate for differences in the color of a light source, allowing us to see white objects as white independent of the lighting condition. Film cameras rely on special color-correcting filters and film types to adjust for these differences in lighting. Digital cameras, however, are able to use software to mimic the adjustments made by the brain, so that colors that appear white to the human eye also appear white in your photographs.

WHITE BALANCE OPTIONS

	OPTION	COLOR TEMP.	DESCRIPTION
	Auto (Default)	—	Select this setting to allow the camera to automatically determine the appropriate white balance adjustments.
	Sunlight	Approx. 5400 K	Select this setting when taking pictures in full sunlight.
	Shade	Approx. 8000 K	Select this setting when taking pictures in the shade under sunny skies.
	Overcast	Approx. 6500 K	Select this setting when taking pictures under cloudy, overcast skies.
	Incandescent	Approx. 3000 K	Select this setting when taking pictures indoors under incandescent (tungsten) lighting.
	Fluorescent	Approx. 4100 K	Select this setting when taking pictures indoors under fluorescent lighting.
	Flash	Approx. 7000 K	Select this setting when taking pictures with the Sigma EF-500 DG flash.
	Custom	—	Select this setting when using a custom white balance. Use the "Set Custom WB" menu option to create a custom white balance setting. The "Custom" option will not be available if no custom white balance has been set.

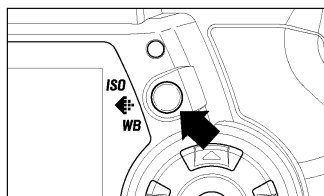

1
Make sure the camera is turned on.

2
Press the Image Setting Button (ISO/WB) to open the quick set menu.

3
The desired mode can be chosen by pressing the (▼) button of the 4-way controller.





4
A photograph can be taken when the shutter button is pressed half-way and this will determine the white balance mode. (alternatively, the mode can be chosen by pushing the (OK) button).

■ If Custom White Balance (CWB) is selected, "Set custom-WB" of set-up menu will be used for shooting.

SETTING A CUSTOM WHITE BALANCE

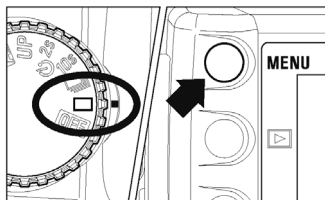
For more precise control of the white balance setting or when photographing under unusual lighting conditions, the "Set Custom WB" option can be used to capture a sample of neutral object in a scene to be used for color correction.





1 Make sure that "D"-dial is set to Single Frame Shooting .

2 Press the **MENU** button on the back of the camera to display the Camera Set-up Menu. (See P.104)



3 Use  arrows on the 4-way controller to select "Set Custom WB".

4 Press  arrow or  to open the custom white balance dialog screen.

5 Under the lighting conditions that will be used for the final photograph, frame a white or neutral color object, such as a sheet of white paper or a white wall, so that it fills the Center Area Metering circle inside the viewfinder.



6 Press the shutter button to release the shutter and capture a custom white balance setting.

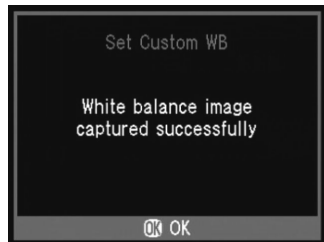

7 If a valid white balance setting was captured, a message will appear indicating that the white balance image was captured successfully. If the capture was not successful, "Failed!" will be displayed on the color LCD monitor. Repeat steps **5** and **6** to capture a valid white balance setting or press  to dismiss the dialog.

TIP

- When a custom white balance setting is successfully captured, "**Custom**" will automatically become the selected item in the White Balance menu.
- It is recommended that an automatic exposure mode such as **P**, **A**, or **S** be used when capturing a custom white balance setting to ensure proper exposure.
- It may be necessary to set the lens to manual focus (**P.50**) when capturing a custom white balance setting since auto focus may not work properly when photographing low contrast subjects.

SETTING THE SENSITIVITY (ISO EQUIVALENCY)

The photosensitivity of digital cameras is described in terms of "ISO equivalent" like silver-halide film cameras. (ISO sensitivity **P.113**)

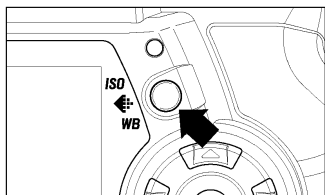

1

Press the **ISO**↔**WB** button on the back of the camera to open the Image Setting Menu.

2

Use the **▲** on the 4-way controller to select the desired ISO sensitivity value.
(The ISO value can be changed 100 → 200 → 400 → 800 by pressing **-** button. The ISO value turns yellow, while selecting ISO sensitivity.)

3

Press the shutter button halfway or **OK** button to apply the setting. Then you can take the picture.







NOTE

- If extended mode is selected you can use ISO up to 1600 (See **P.71**)

IMAGE FILE SETTING

The file size changes depending on resolution mode and recording quality selected.

		RES (Resolution mode)			
		 Super Hi 4608×3072	 HI 2640×1760	 MED 1776×1184	 LOW 1296×864
QUAL (Recording quality)	RAW (RAW)		13.3MB	6.6MB	3.3MB
	FINE (JPEG)	7.5MB	3.3MB	1.6MB	0.8MB
	NORM (JPEG)	4.6MB	1.9MB	0.9MB	0.5MB
	BASIC (JPEG)	3.2MB	1.3MB	0.6MB	0.3MB

* The file sizes change depending on subjects.

RECORDING IMAGES

It is possible to record images in the widely used JPEG or RAW formats. The RAW images are recorded without digital processing in the camera body and require post-processing with the supplied software, which can convert RAW images to JPEG or TIFF format.

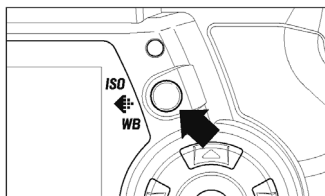

RESOLUTION MODE SETTING



1

Press the **ISO**  **WB** button on the back of the camera to open the Image Setting Menu.

2

Use the  button on the 4-way controller to select the desired recording mode. (The following recording modes **Super Hi** → **HI** → **MED** → **LOW** can be changed by pressing the  button. The icon turns yellow during selecting.)

3



Press the shutter button halfway or  button to apply the setting. Then you can take the picture.

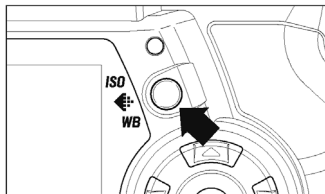

RECORDING QUALITY SETTING



1 Press the **ISO**  **WB** button on the back of the camera to open the Image Setting Menu.

2 Use the  button on the 4-way controller to select the desired recording quality. (The quality can be changed; **RAW** → **FINE** → **NORM** → **BASIC** by pressing the  button. The recording quality turns yellow, during recording.)



3 Press the shutter button halfway or  button to apply the setting. Then you can take the picture.

IMAGE PARAMETER AND COLOR SPACE

It is possible to adjust the recording image parameter (contrast, sharpness and saturation) and select the color space.

Contrast

Contrast can be increased by moving the cursor to + side or decreased, preserving image detail, by moving the cursor - side.

Sharpness

It is possible to make the pictures appear sharper, by moving the cursor to + side, or softer by moving the cursor to - side,.

Saturation

It is possible to increase saturation thus making pictures appear vivid, if the cursor is moved to + side. Moving the cursor to - side, decreases saturation and makes images less vivid.

Color space

It is possible to select sRGB, which is a common color space or Adobe RGB, which is mainly used for commercial printing, and other industrial purposes.



1
Press the **MENU** button on the back of the camera to access the setup menu. (P.104)

2
Press the **◀▶** button on the 4-way controller to select "Adjust Setting".

3
Press the **▶** button on the 4-way controller or the **OK** button to open the sub menu.

4
Use the **◀▶** button to select the desired parameter from the scroll menu.

5
Press the **▶** button on the 4-way controller or the **OK** button to open the Adjust Setting Menu.

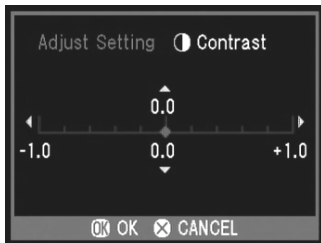

6
Use the **◀▶** button on the 4-way controller to select the desired value. (In the case of the color space, use the **◀▶** button on the 4-way controller to select sRGB or Adobe RGB) .

7
Press the **OK** button to confirm the setting.

- JPEG is compressed after parameter adjustment. In the case of RAW format, parameter information is recorded without adjustment. It is possible to re-adjust RAW images using the supplied Sigma Photo Pro software.
- Please set color space to sRGB for regular usage. If you select Adobe RGB, please be sure to use the supplied Sigma Photo Pro software or another image processing software supporting DCF 2.0.

SELECTING THE METERING MODE

The camera has three advanced metering modes.

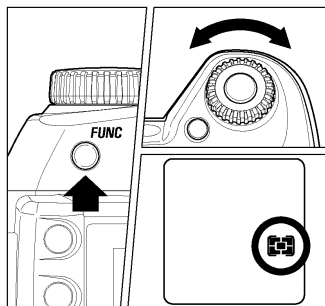

While pressing the **FUNC** button, rotate the “C”-dial to select the desired metering mode and display it on the LCD panel. Releasing the metering button sets the selected metering mode.

8 SEGMENT METERING

The camera measures the brightness of the scene by independently measuring each segment of the focusing screen and analyzing the correct exposure for the main subject under any lighting situation.

Even under strong back lighting or complex lighting situations, the camera will give you the correct exposure.

[] AVERAGE METERING

The camera will measure the average brightness of the entire scene with additional emphasis on the center area. It will determine the most suitable exposure with respect to lighting conditions.

[■] CENTER AREA METERING

The camera will measure the brightness only inside of the circle as shown in the viewfinder. This mode is suitable when you wish to set exposure for a portion of the scene and ignore the influence of rest of the scene.

AE LOCK

The camera will fix and memorize the exposure value, while you press the “AE” Lock button. When you wish to lock the exposure of a subject off-center, AE lock is very useful. Use of this function with Center Area Metering Mode is recommended.



1

Center the subject inside the viewfinder, then press the shutter button “Half-way”.

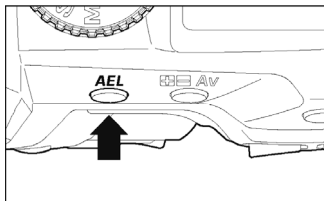

2

Keep shutter button “Half-way” depressed, and then push the “AE” lock button. (While operating the AE lock, the displays of the shutter speed and aperture value in the viewfinder are locked and “AEL” is visible). You can release the shutter button.

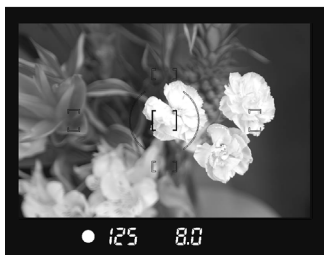

3

Hold the AE lock button while you compose the picture. Then press the shutter button to take the picture.

- When the subject is out of focus during AE lock operation, remove your finger from shutter button and press the shutter button “Half-way” again, or remove your finger from the AE lock button and restart from the beginning.

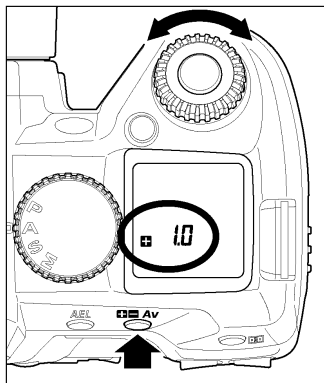

EXPOSURE COMPENSATION

If you want to intentionally overexpose or underexpose the picture, use this function.



While pressing  Av button, turn the “C”-dial to set the desired compensation value. Then, release the Exposure Compensation button.



- The LCD panel will show “ 0.0” when you initially press the exposure compensation button. The “” indicates overexposure, and “” indicates underexposure.
- Exposure compensation can be set in 1/3EV increments from +3.0 to –3.0 stops.
- For example, if you set +1.0 then the shutter speed will be one stop slower in Aperture Priority mode. In Shutter Speed Priority mode, the aperture will be one-stop larger (smaller F-number). In the case of Program mode, the shutter speed will be 0.5 stop slower and the aperture will increase 0.5 stop.

CAUTION !!

- Once you set the Exposure Compensation, the camera will continuously hold this mode, until the compensation amount is set to  0.0 value.
- Exposure compensation function cannot be used with Manual Operation mode.

NOTE

- During flash photography, if exposure compensation is performed, background exposure and flash output both will be compensated. If it is used together with flash exposure compensation, it is possible to adjust the balance of background exposure and the flash output amount (please refer to next page).

FLASH EXPOSURE COMPENSATION

It is possible to compensate the flash output level without changing the background's exposure.

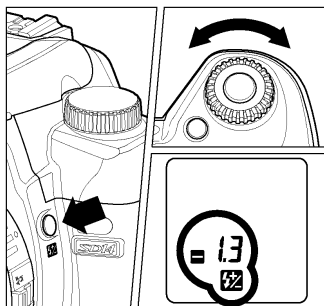

While pressing the **Fn** button, turn the "C"-dial to set the compensation amount.

- The LCD panel will show **+ -** 0.0 when you initially press the **Fn** button.
+ indicates over exposure **-** indicates underexposure.
- Exposure compensation can then be set in 1/3 increments from +3.0 to -3.0 stops.
- **Fn** mark will be displayed in the top LCD panel after setting the compensation amount. Compensation amount will not be displayed. Exposure amount can be confirmed by pressing the flash exposure amount.
- It is possible to use the camera for flash exposure compensation of the external flashgun. If the setting is done by both camera and flashgun, then the camera's setting will have priority over the flash's setting.

WARNING!!

- Once you set the flash Exposure Compensation, the camera will continuously hold this mode, until the compensation amount is reset to **+ -** 0.0 value.

Combination of Exposure Compensation and Flash Exposure Compensation

It is possible to make adjustments by using the exposure compensation together with the flash exposure compensation, such as making the background brighter and preventing unwanted flash reflections from the subject.

For instance, set the exposure compensation to +2 and the flash exposure compensation to -2, and the background exposure will be 2 stops over exposed and the flash exposure be 0 (appropriate).

- If exposure compensation and flash exposure compensation are set, **Fn** will be displayed on the display on the LCD panel, only the exposure compensation amount will be displayed.

AUTO BRACKETING

This function of the camera lets you take a sequence of pictures of the same subject at three different exposure levels; Appropriate Exposure, Under Exposure and Over Exposure. If it is difficult to determine the proper exposure, please use this function.

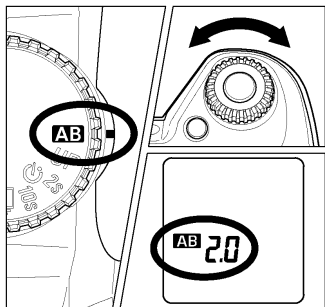

1
Set the "D"-dial to **AB** position.

2
Turn the "C"-dial to set the bracketing amount. (It can be set in 1/3 EV step increments up to ± 3 EV).

3
Set the "D"-dial to drive area (**P.14**).

- The camera will take three pictures in the following sequence; Appropriate exposure, under exposure and over exposure.
- For example: If you set the bracketing amount to 2.0, the indicator in the viewfinder will show as follow.

	P,A,S mode	M mode
First Frame	+ 0.0	* Measured Value
Second Frame	- 2.0	-2.0 EV deviation from Measured Value
Third Frame	+ 2.0	+2.0 EV deviation from Measured Value

(* Measured value is the difference between the correct exposure value of the camera and your setting value).

- The exposure bracketing can be used with 4 different modes.

P Mode ; Both shutter speed and aperture value will be changed.

A Mode ; Only shutter speed will be changed.

S Mode ; Only aperture value will be changed.

M Mode ; Only shutter speed will be changed.

WARNING !!

- Once you set the auto bracketing mode, the camera will continuously hold that auto bracketing mode until you set the bracketing amount to "0.0".

- For the first frame, “**AB**” mark will be displayed continuously on the LCD panel. For the second frame, “**AB**” mark on the LCD panel, will blink slowly, then it will blink quickly for the third frame.
- When you set the self-timer mode, the camera will automatically take three consecutive pictures.
- It is possible to change the drive mode during the Auto Bracketing operation. But if you set the self-timer mode, the camera will take three continuous pictures.
- It is not possible to use Auto Bracketing mode for flash photography. Auto Bracketing will not affect the output level of the flash.

Auto Bracketing mode can be used in combination with Exposure Compensation.

You can take pictures with Auto Bracketing mode based on a compensated exposure, which you set.

To do so, please set both the Auto Bracketing mode and Exposure Compensation mode as desired.

The combined value (Exposure Compensation and Auto Bracketing) will be indicated on the viewfinder display.

Example

Exposure Compensation +1.7 with Auto Bracketing amount 1.0

First Frame	+ 1.7 (Exposure compensation +1.7 & no shift value)
Second Frame	+ 0.7 (Exposure compensation +1.7 & shift value -1.0)
Third Frame	+ 2.7 (Exposure compensation +1.7 & shift value +1.0)

REMOTE CONTROLLER RS-31

This accessory permits releasing the camera's shutter from up to 16 feet (5m) away from in front of the camera, or up to 9.8 feet (3m) away if you are 30 degrees to either side. (Depending on the lens, there may be some restrictions when using it from the left side of the camera.) All without wires or cables.

Description of Parts

- ① Transmit Button
- ② Time Delay Selector
- ③ Transmitting diode
- ④ Channel Selector

OPERATION

SETTING OF THE REMOTE CONTROLLER

- 1** Select the delay time.

- Shutter will be released immediately after the transmit button is pressed.
- Shutter will be released 3 second after the transmit button is pressed.

- 2** Select the channel.

SETTING OF THE CAMERA

- 3** Press and hold the **FUNC** button four times, the LCD panel will indicate the  icon. Do not release the **FUNC** button.

- 4** Keep pressing the **FUNC** button depressed, and turn the "C"-dial to select the channel (same channel as Remote Controller). Release the **FUNC** button. After setting the channel, the  mark will appear on the LCD panel.

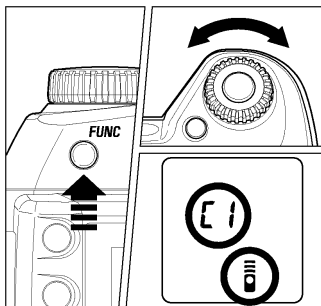

- 5** Check that the subject is framed correctly. After you set the focus, we recommend setting the lens switch to MF position.

- 6** Point the transmitting diode at the camera and press the transmit button.

- 7** After taking the picture, please cancel the remote control mode following the above procedure from number **3** to **4**, and then choose " - " mark to cancel remote control function.

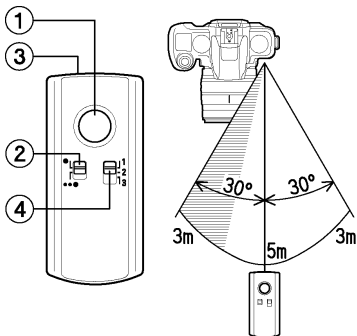

- The remote control mode cannot be used together with continuous shooting mode. If the “D”-dial is set to the continuous shooting mode, the camera will expose only one frame for each activation by the remote controller.
- The remote controller may not work properly if strong sunlight is shining directly on the camera’s remote control sensor.
- The camera will switch itself off after about 5 minutes of inactivity, while in the remote control mode. To reactivate the camera, press the shutter button “half-way down”; the remote control mode will work again.
- The light entering the viewfinder can affect the exposure system of the camera. To prevent this, use the finder cap while using the remote controller.

USING THE MIRROR LOCK-UP WITH REMOTE CONTROL

When using mirror-up mode with the remote controller, we recommend that after adjusting the focus, fully depress the shutter button of the camera once, to lock-up the mirror, and then release the shutter by remote control. This procedure saves your time.

- 1** Set the “D”-dial to “*UP*” position, and set the remote control mode.
- 2** Press the shutter button “half-way” to focus on the subject, and set the desired exposure. Then press the shutter button “all-way down” to raise the mirror-up and retain the focus and exposure.
- 3** To take the picture, point the remote controller’s transmitting diode at the camera and press the transmit button.

REPLACING THE REMOTE CONTROLLER BATTERY (RS-31)

The remote controller is powered by 1pc CR 2032 3V Lithium -- battery.

- 1** Use a coin or a similar subject to open the battery cover in the direction of the arrow.
- 2** Open the bottom cover and replace the battery.
- 3** Use a coin or similar object to close the battery cover by rotating clockwise.

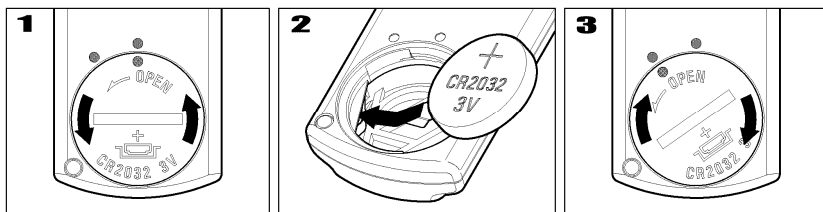

Check controller operation after replacing the battery.

WARNING !!

- If you have set the SD14's channel to remote control mode, camera's battery consumption will increase. In addition, camera's exposure display will disappear and AE Lock will not function. If you are not using Remote Control please cancel the "☺" remote control mode by choosing "- -".

DEPTH-OF-FIELD PREVIEW BUTTON

Normally, the lens' aperture is always fully opened, except at the time the picture is actually taken, for looking through the viewfinder under maximum brightness conditions.

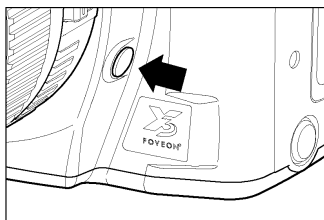

However, by pressing the depth-of-field preview button, the aperture can be closed down to the selected shooting aperture before the picture is taken, enabling you to check depth of field through the viewfinder before shooting.

DEPTH OF FIELD

When you set the focus for a particular subject, there is an area in front of and behind your subject, which will also be in focus. This is called the Depth-of-Field.

Depth of Field will increase when

Using a smaller aperture value (Larger F-number)

i.e. When you photograph the subject under the same conditions but change the aperture value from F8 to F22, F22 will show more area in focus (more depth of field).

Using shorter focal length (wide-angle) lens.

i.e. When you photograph the subject under the same conditions, changing only focal length from 50mm to 28mm, the 28mm lens will show more area in focus (more depth of field).

Photographing the subject at greater distance

When you photograph the subject with same focal length lens and aperture value but change the camera-to-subject distance, the subject at the greater distance shows more area in focus (more depth of field) compared to subject at the shorter distance.

FLASH PHOTOGRAPHY

ELECTRONIC FLASH EF-500 DG SUPER SA-STTL (Sold Separately)

ELECTRONIC FLASH EF-500 DG ST SA-STTL (Sold Separately)

Optional Sigma Electronic Flashes EF-500 **DG** SUPER SA-STTL and EF-500 **DG** ST SA-STTL with the STTL system allow you to use features such as Auto Flash with the SD14. The EF-500 **DG** SUPER SA-STTL lets you do even more, such as use Multi Flash and other advanced features.

EF-500 DG SUPER SA-N, EF-500 DG ST SA-STTL

- **High light output.** Maximum guide number of 50 (165 ft) (ISO100, 105mm zoom head position) .
- **Easy to use.** The flash automatically sets the zoom position according to the focal length of the lens in use (from 28 to 105mm). A built-in wide panel can provide the ultra-wide-angle coverage of a 17mm lens.
- **Flexible.** For bounce flash, the flash head can be tilted up or down, or swiveled to the left or right. Additionally, the flash head can be tilted 7° downward for close-ups.
- **High-speed.** For stop action photography, shutter speeds up to 1/4000 of a second can be used with the high-speed sync FP flash (EF-500 DG Super SA-STTL only).
- **Versatile.** Both flash models can be used with Sigma SD9, SA300n, SA-5, SA-7 and SA-9 cameras.

WARNING !!

- SD14 is compatible only with the **DG** series clip-on type flashguns. Non-**DG** type Sigma flashguns or flashguns for the other camera brands made by Sigma, or flashguns made by other manufacturers, cannot be used with Sigma SD14 camera..

To get maximum performance from SD14 in flash photography, please use EF-500 **DG** SUPER **SA-STTL** or EF-500 **DG** ST **SA-STTL** flashguns. EF-500 **DG** SUPER SA and EF-500 **DG** ST SA also can be used with SD14 camera; however, there are some restrictions with the following functions.

- AF auxiliary light may not be powerful enough, and focusing may not work properly depending on the distance or photographic subjects. In such a case, please use manual focus.
- In the case of EF-500 **DG** SUPER SA, sometimes, the exposure display of the camera and the exposure display of the flash may not be same. For further information, please refer to the EF-500 **DG** SUPER SA instruction manual.
- Wireless flash function of EF-500 **DG** SUPER SA cannot be used (Slave Flash can be used).

The SD14 is equipped with a PC Synchro Terminal, which accepts a cable connection fro external/studio flash units.

CAUTION!!

- S-TTL auto flash does not work, if PC Synchro Terminal is used.
- Set the camera's exposure mode to M and set to flash synchronized speed Sync (1/180) or a shutter speed of 1/160 or lower. See the instruction manual of the particular flash used for additional information.
- The SD14's PC Synchro Terminal is compatible with plugs that have a positive (+) polarity on the central pin and a negative (-) polarity on the shield. If the plug has reverse polarity, use a commercially-available polarity conversion cord.

WARNING!!

- The PC terminal cannot accept flashes that use a voltage of more than 250V. Higher voltage will damage the camera. Please ask the manufacturer of the flash about the voltage and compatibility with the PC terminal.

EXTENDED MODE SETTING

If Extended Mode is selected, it is possible to use ISO 1600 sensitivity.

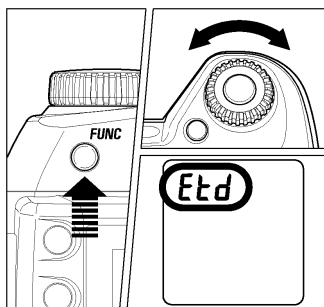

1

Press the "FUNC" button 7 times and hold, the LCD panel will indicate "dEF". Do not release the FUNC button.

2

Keep the "FUNC" button depressed and turn the "C"-dial to select the "Etd".

REVIEWING, DELETING AND MODIFYING IMAGES

This section explains how to review, delete, and modify images after they have been captured.

TIP

- The SD14 may not be able to display images captured by other cameras, or "SD14" images that have been renamed or moved from the **DCIM** folder on the CF card. For more information on SD14 file names, see File Numbering System (See **P.31**).

QUICK PREVIEW

The SD14 camera can be set to automatically display a preview of each image immediately after it is taken. This is useful for instantly checking exposure and framing.

CHANGING THE QUICK PREVIEW DURATION

The Quick Preview image can be completely disabled, displayed for 2, 5, or 10 seconds, or set to remain on until further action. Use the Camera Set-up Menu to change Quick Preview duration.

QUICK PREVIEW OPTIONS

OPTION	DESCRIPTION
Off	No preview image is displayed.
2 sec. (Default)	Preview image is displayed for 2 seconds. (Color LCD monitor shuts off automatically after 2 seconds.)
5 sec.	Preview image is displayed for 5 seconds.
10 sec.	Preview image is displayed for 10 seconds.
Hold	The image is displayed on the LCD monitor until 1) the shutter button is pressed half-way, 2) the X or MENU buttons are pressed or 3) the LCD Sleep or Auto Power Off time is reached.

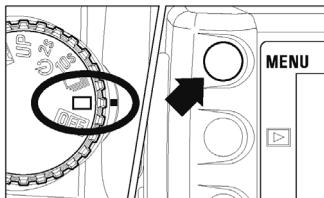

TO CHANGE PREVIEW DURATION

1

Make sure the camera is turned on.

2

Press the **MENU** button on the back of the camera to display the Camera Set-up Menu. (See P.104)

3

Use the  arrows on the 4-way controller to select "Quick Preview".



4





Press the  arrow or  to open sub-menu.

5



Use the  arrows on the 4-way controller to select duration.



6

Press the  arrow or  to apply the setting or the  arrow or  to close sub-menu without making any changes.

TIP

- To manually turn off the Quick Preview image, press the  button or the shutter button half-way.
- While the Quick Preview image is being displayed, the  button can be used as a shortcut key to temporarily toggle the over-exposure warning overlay on or off, or to mark, lock or rotate the image. (See P.98 to set OK key shortcut.)
- It will not be possible to zoom in to the preview image, use the Modify Menu, or change to another image while the Quick Preview is up.
- Pressing the  button while the Quick Preview image is up enables all image review features and overrides the Quick Preview time-out.

CHANGING THE QUICK PREVIEW STYLE

The preview image can be a full-screen image or an Image Info Screen. Use the Camera Set-up Menu to change Quick Preview style.

PREVIEW STYLE OPTIONS

OPTION	DESCRIPTION
Image only (Default)	Full-screen image
Info screen	Image Info Screen

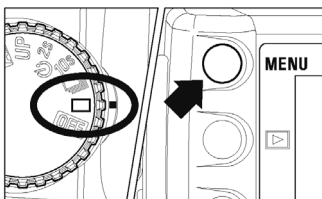

TO CHANGE PREVIEW STYLE

1

Make sure the camera is turned on.

2

Press the **MENU** button on the back of the camera to display the Camera Set-up Menu. (See P.104)

3

Use the \blacktriangle arrows on the 4-way controller to select "Preview Style".

4

Press the \blacktriangleright arrow or **OK** to open sub-menu.

5

Use the \blacktriangle arrows on the 4-way controller to select a style.

6

Press the \blacktriangleright arrow or **OK** to apply the setting or the \blacktriangleleft arrow or **X** to close sub-menu without making any changes.



TIP

- The **i** button can be used to toggle between the full-screen view and Image Info Screen for the currently displayed preview image, regardless of style setting.

QUICK DELETE

Undesirable images can be deleted as soon as their preview is displayed.

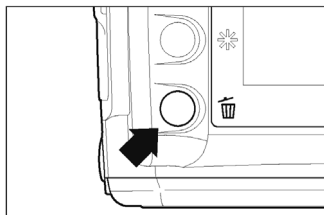

TO DELETE A PREVIEW IMAGE



1

Press  while the Quick Preview image is displayed.

- The Quick Delete confirmation dialog will open.



2

Press  to delete the image or  to close the confirmation dialog without deleting the image.

- If the image is deleted, the confirmation window will close and the color LCD monitor will turn off.

REVIEWING IMAGES

The pictures captured by the SD14 can be reviewed in various ways.

To review images captured by the SD14 camera press the  button on the back of the camera. The last image recorded on the CF card will be displayed on the color LCD monitor in Single-Image View.

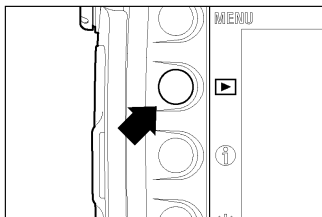

TO REVIEW IMAGES

Press  button on the back of the camera to turn on LCD monitor and display image.

- Pressing  again will turn off the LCD monitor.

TIP

- If no new images have been captured in the meantime, the last reviewed image will be displayed instead.
- If there are no images on the CF card an error message will be displayed (see P.118 for more information).
- Since the SD14 camera does not have a separate "playback mode" for looking at captured images, it is always ready to take pictures, even while displaying captured images.

The  Controller is used to change between different review options as shown.

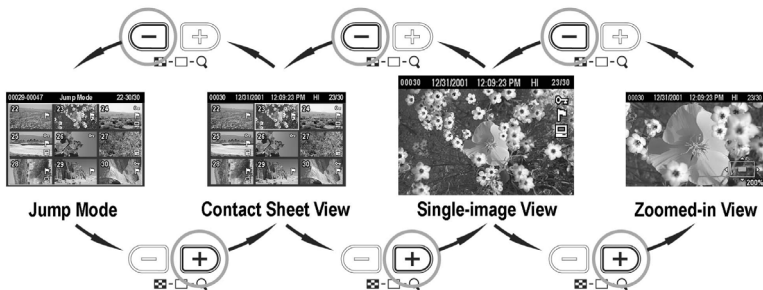

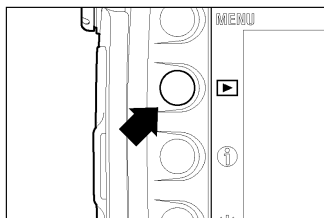

VIEWING ONE IMAGE AT A TIME



Press  button on the back of the camera to see recorded images in Single-Image View.

While in Single-Image View:

- Press  arrow on the 4-way controller to see next image.
- Press  arrow on the 4-way controller to see previous image.
- Press  arrow on the 4-way controller to change the indicated information. It is possible to select the information bar from the following three patterns.



0035 F4 1/200s ISO100

File numbering, Aperture, Shutter speed, ISO sensitivity



0035 2006/09/10 05:26:24 PM



File numbering, year/month/date, hour/minute/second



0035 100SIGMA RAW 35/37

File numbering, Folder name, Recording quality, Resolution mode, file number/total files recorded

TIP

- It is not necessary to wait for the current image to finish loading before proceeding to another image.
- To scroll through images more quickly, press and hold a button on the 4-way controller. Images will advance automatically until the button is released.
- The first and last recorded images on the CF card are linked. Pressing the  arrow on the 4-way controller while the first image is displayed brings up the last recorded image on the card. Pressing the  arrow on the 4-way controller while the last image is displayed brings up the first recorded image on the card.

MAGNIFYING IMAGES (ZOOMED-IN VIEW)

To view image detail or check focus, recorded images can be magnified up to 5 levels, depending on the resolution of the image.

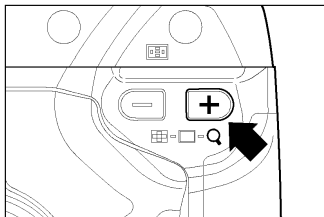

TO MAGNIFY IMAGE

Press **+** on the **-/+** Controller from Single-Image View.



While in Zoomed-in View:

- Press **+** on the **-/+** Controller to increase magnification.
- Press **-** on the **-/+** Controller to decrease magnification.
- Press the **←/→** arrows on the 4-way controller to pan around the image.
- Press **X** to return to Single-Image View.

TIP

- While in Zoomed-In View, the 4-way controller cannot be used to change images. Press **X** to get out of Zoomed-In View, or return to Single-Image View by pressing **-** on the **-/+** Controller, then use the 4-way controller to change the image selection.

VIEWING NINE IMAGES AT A TIME (CONTACT SHEET VIEW)

Images can be viewed in a "contact sheet" of nine thumbnail images.

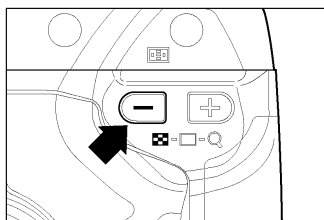

TO GO TO CONTACT SHEET VIEW

Press **-** on the **-/+** Controller from Single-Image View.

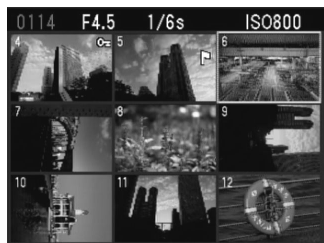

While in Contact Sheet View:

- Use the **◀▶** arrows on the 4-way controller to change the image selection.
- Press **+** on the **-/+** Controller to return to Single-Image View.
- Press **-** on the **-/+** Controller to go to Jump Mode.

TIP



- When the last row of images is reached, pressing **▼** on the 4-way controller will jump to the first 9 images on the card.

VIEWING IMAGES A PAGE AT A TIME (JUMP MODE)

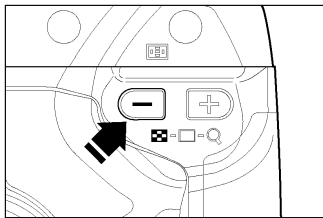
Use Jump Mode to browse large sets of images more quickly, or to skip right to the first or last page of images on the CF card.









TO GO TO JUMP MODE



Press  on the  Controller twice from Single-Image View (or once from Contact Sheet View).



While in Jump Mode:

- Press the  arrow on the 4-way controller to jump to the next page of images.
- Press the  arrow on the 4-way controller to jump to the previous page of images.
- Press the  arrow on the 4-way controller to jump to the last page of images.
- Press the  arrow on the 4-way controller to jump to the first page of images.
- Press  on  Controller to return to Contact Sheet.

TIP

- The first and last pages of images are linked. Pressing the  arrow on the 4-way controller while the first page of 9 images is displayed brings up the last page of images. Pressing the  arrow on the 4-way controller while the last page of images is displayed brings up the first page of images.

VIEWING IMAGE INFORMATION

The Image Info Screen contains additional information about each image.

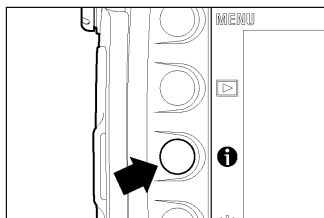

TO DISPLAY IMAGE INFO SCREEN

Press the **i** button from Single-Image, Contact Sheet, or Zoomed-In View.

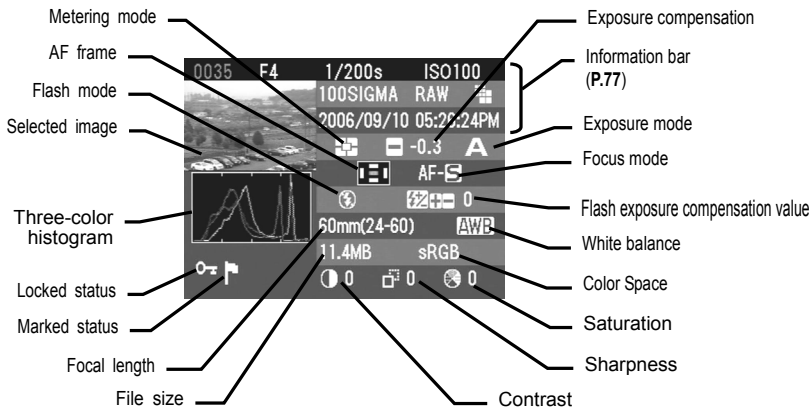

While in Image Info Screen:

Press **i** again or **X** to close the Image Info Screen and return to the previous view.

Use **◀▶** arrows on the 4-way controller to change the image selection the same way as in Single-Image View. (See next section for the exception.)

IMAGE INFO SCREEN FOR MAGNIFIED IMAGES

It is possible to obtain detailed histogram information for a particular section of an image by opening the Image Info Screen from Zoomed-In View.

- For more information on the histogram see next section.

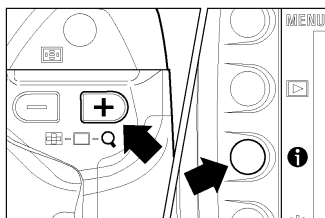

TO DISPLAY MAGNIFIED IMAGE INFO SCREEN

1

Magnify the image to the desired level and pan to the area of interest. (See P.78)

2

Press < **i** INFO >.

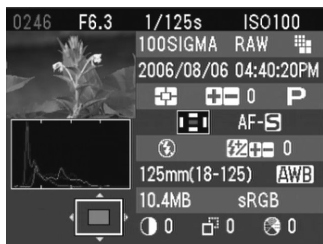

The magnified segment of the image will be shown in the thumbnail and the values displayed in the histogram will correspond to that segment only.

While in Image Info Screen for a Magnified Image:

- Press the **◀▶** arrows on the 4-way controller to pan to another part of the image. (Histogram will update automatically to reflect the new values.)
- Press **[-][+]** on the **[-][+]** Controller to increase/decrease magnification.
- Press **⊗** to cancel magnification and view the Image Info Screen for full image. (Press **⊗** again to close the Image Info Screen.)
- Press **i** to close the Image Info Screen and return to Zoomed-In View.

TIP

- While viewing an Image Info Screen for a magnified image, the 4-way controller cannot be used to change images. Press **⊗** to cancel magnification or return to full image view by pressing **[-]** on the **[-][+]** Controller, then use the 4-way controller to change the image selection.

HISTOGRAM

The histogram is a graph depicting the distribution of brightness values in the image for each of the three color channels (Red, Green, and Blue). The horizontal axis shows the brightness level, with darker pixels towards the left side and brighter pixels toward the right. The vertical axis shows the proportion of pixels at each level of brightness.

By examining the histogram of the full image, you can gauge the over-all exposure of that image. You can also use the histogram to determine if zoomed-in sections of an image are over or under exposed.



This histogram shows that the higher pixel values are never used in the image, indicating that the image is underexposed, and therefore will appear dark. In general, when the histogram is higher on the left side, the image is mostly composed of dark pixels, causing it to appear dark—either because the image is underexposed or because it is a dark scene such as night shot or sunset.



This histogram shows a fairly even distribution of pixel values, indicating that the image is well exposed, with good contrast. However, the histogram distribution of a well exposed image will vary greatly depending on the subject.



This histogram shows that many of the pixel values are at their brightness limit, indicating that some areas of the image may be blown out. In general, when the histogram runs off the right side, the image will have many white pixels—either because the image is overexposed or because it is a bright scene such as the beach or snow.

OVER-EXPOSURE WARNING

It is possible to indicate the over-exposed areas by highlighting them in red.

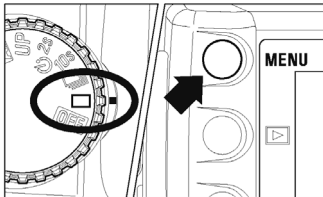

TO TURN ON OVER-EXPOSURE WARNING

1

Make sure the camera is turned on.

2

Press the **MENU** button on the back of the camera to display the Camera Set-up Menu. (See **P.104**)

3

Use  arrows on the 4-way controller to select "Exposure Warning".





4

Press  arrow or  to open sub-menu.

5

Use  arrows on the 4-way controller to select "On".

6

Press  arrow or  to apply the setting or  arrow or  to close the sub-menu without making any changes.



TIP

- The  button can be used as a shortcut key to temporarily toggle the over-exposure warning overlay on or off. Using the shortcut key will not change the Exposure Warning setting in the Set-up Menu. (See **P.98** to set OK key shortcut.)

VIEWING IMAGES ON A TV

The SD14 camera can be connected to a television or a videocassette recorder using the provided video cable, allowing the recorded images to be viewed on the television monitor or recorded on videotape.

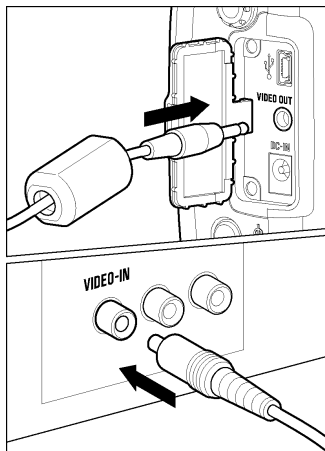

TO CONNECT THE CAMERA TO A VIDEO DEVICE

1

Open the cover protecting the camera's VIDEO OUT, DC-IN, and USB connectors.

2

Connect the video cable to the <VIDEO OUT> terminal on the camera and to the video input terminal on the television or video cassette recorder.

3

Turn on the camera and the video device.

WARNING !!

- Please do not use any video cable other than provided with your Sigma SD14 camera, when connecting a video input terminal. Using other brands may cause damage.

TIP

- It is recommended that the camera be powered with the provided AC adapter during television playback to avoid draining the battery.
- The default mode for the video signal is NTSC. When connecting the camera to a PAL device, the Video Mode setting in the Camera Set-up Menu must be changed. (See **P.104**)

DELETING IMAGES

This section describes how to delete the image(s) recorded on a CF card.

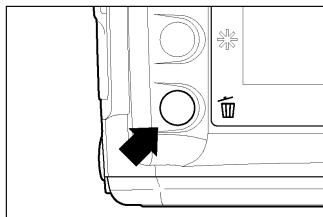

Images recorded on the CF card can be deleted one at a time or several at once using the Delete Menu.

- The Delete Menu can be opened from all views (Single-Image, Contact Sheet, and Zoomed-In), as well as from Jump Mode and the Image Info Screen.



TO DISPLAY THE DELETE MENU

Press the  button on the back of the camera.

- Press  again or  to close the Delete Menu without deleting any images.

DELETE MENU

MENU ITEM	DESCRIPTION
Current image	Delete the currently selected image only. (Not available if the Delete Menu is opened from the Jump Mode.)
All marked	Delete all marked images on the CF card. (See P.93 for information on marking images.)
All	Delete all images on the CF card. (Locked images are not deleted) (See P.90 for information on locking images.)

DELETING A SINGLE IMAGE

TO DELETE A SINGLE IMAGE

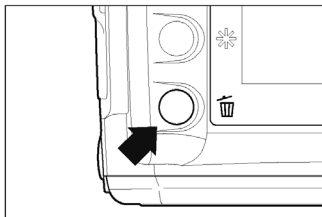

1

Use the  arrows on the 4-way controller to select the image to be deleted in Contact Sheet or Single-Image View.



2



Press  to display the Delete Menu.

- “Current image” will be the default selection.



3

Press  to delete the image.

- If the image is unlocked, it will be deleted without any further confirmation.
- If the image is locked, a confirmation dialog will come up asking if you are sure you want to delete the locked image. Press  to unlock and delete the image or  to return to reviewing images without deleting.

TIP

- If the Delete Menu was opened from the Jump Mode, you cannot select “Delete”. If the CF card contains a marked image, then “All Marked” is selected. If the CF card does not contain marked image, then “All” is selected.

DELETING MULTIPLE IMAGES

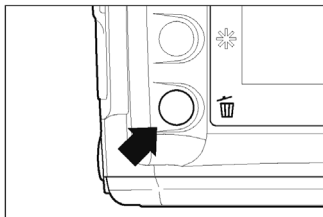

TO DELETE MULTIPLE IMAGES

1

Press  to display the Delete Menu.

2

Use the  arrows on the 4-way controller to select “All marked” or “All”.



- Locked images are not deleted. Locked images must be unlocked first before they can be deleted (**P90**).
- If there are no marked images, or all the marked images are locked, the “All marked” menu item will not be available from the Delete Menu.



3

Press  to display the confirmation dialog.

4

Press  to delete all the images or press  to return to reviewing images without deleting.



TIP

- Marked images that are also locked will not be deleted with the “All marked” menu item. The locked images must be unlocked first. Marked images are not protected from deletion unless they are also locked.
- To erase all files from the CF card, including locked images as well as all non-SD14 files, use the “Format CF Card” menu item in the camera Set-up Menu (see **P.30**).

MODIFYING IMAGES

Image modifications, such as locking, marking, and rotating, as well as automatic image playback, can be performed from the Modification Menu.

The Modification Menu contains the Lock Menu, Mark Menu, Rotate Menu, and Slideshow Menu.

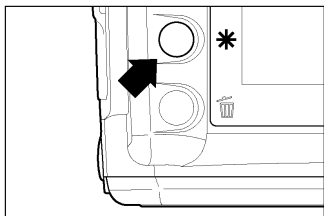

TO DISPLAY THE MODIFICATION MENU

Press the * button on the back of the camera.

- Press * again or ⊗ to close the Modification Menu without applying any changes.

TIP

- The Modification Menu can be opened from all views (Single-Image, Contact Sheet, and Zoomed-In), as well as from Jump Mode and Image Info Screen.
- To make it easier to apply the same modification to a number of images, the last action performed will be the default selection when the Modification Menu is opened again.

LOCKING IMAGES

Locking protects images from being accidentally deleted. Locked images must be unlocked before they can be deleted by the Delete Menu functions.

LOCK MENU

MENU ITEM	DESCRIPTION
Lock/Unlock	Lock the currently selected image only. If the image is already locked, the menu item changes to "Unlock". (Not available if the Lock Menu is opened from Jump Mode.)
Lock all marked	Lock all marked images on the CF card. (See P.93 for information on marking images.)
Lock all	Lock all images on the CF card.
Unlock all	Unlock all locked images on the CF card.

CAUTION !!

- Locking does not prevent images from being erased when the CF card is formatted. Review card contents carefully before formatting.

TIP

- Locked images have a "read-only" status when viewed on a computer.

TO LOCK A SINGLE IMAGE

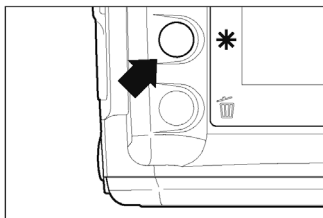

1 Use the arrows on the 4-way controller to select the image to be locked in Contact Sheet or Single-Image View.

2 Press * to display the Modification Menu.



3 Use the arrows on the 4-way controller to select the Lock Menu.

4 Use the arrows on the 4-way controller to select "Lock".

• If the selected image is already locked, the "Lock" menu item will change to "Unlock".

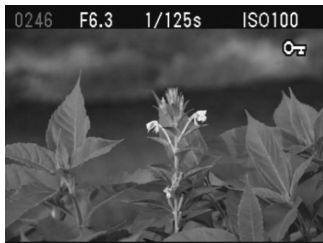

5 Press to lock the image. A key icon will appear in the upper-right corner of the image indicating that the image is locked.

TIP

- To unlock a locked image, select the locked image and follow the same steps as above.
- If the Lock Menu was opened from Jump Mode, the "Lock" menu item will not be available.

TO LOCK MULTIPLE IMAGES

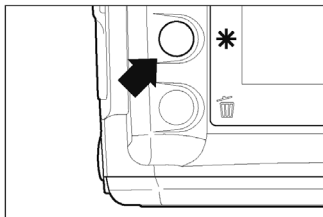

1
Press * to display the Modification Menu.



2
Use the ◀▶ arrows on the 4-way controller to select the Lock Menu.

3
Use the ▲▼ arrows on the 4-way controller to select "Lock all marked" or "Lock all".
• If all images are already locked, the "Lock all" menu item will not be available.



4
Press OK to display the confirmation dialog.

5
Press OK to lock the images or press X to return to reviewing images without locking. A key icon will appear in the upper-right corner of all locked images.

TIP

- Select "Unlock all" from the Lock Menu to unlock all locked images on the CF card.
- The OK button can be used as a shortcut key for locking images. (See P.98)

MARKING IMAGES

Images can be marked for various reasons, such as to identify favorites, to select images for a slideshow, or to select images to be deleted with the “All marked” menu item in the Delete Menu (**P.88**).

MARK MENU

MENU ITEM	DESCRIPTION
Mark/Unmark	Mark the currently selected image only. If the image is already marked, the menu item changes to “Unmark”. (Not available if the Mark Menu is opened from Jump Mode.)
Mark all	Mark all images on the CF card. (If all images on the card are already marked, this menu item will not be available.)
Unmark all	Unmark all marked images on the CF card.

TIP

- Images marked on the camera will retain their marked status when viewed in **SIGMA Photo Pro**.

TO MARK A SINGLE IMAGE

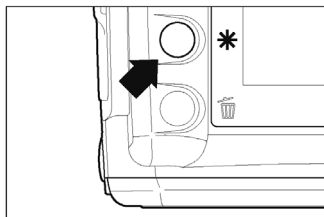

1
Use the ◀▶ arrows on the 4-way controller to select the image to be marked in Contact Sheet or Single-Image View.

2
Press * to display the Modification Menu.



3
Use the ◀▶ arrows on the 4-way controller to select the Mark Menu.

4
Use the ◀▶ arrows on the 4-way controller to select "Mark".

• If the selected image is already marked, the "Mark" menu item will change to "Unmark".



5
Press **OK** to mark the image. A flag icon  will appear in the upper-right corner of the image indicating that the image is marked.

TIP

- To unmark a marked image, select the marked image and follow the same steps as above.
- If the Mark Menu was opened from Jump Mode, the "Mark" menu item will not be available.
- The **OK** button can be used as a shortcut key for marking images. (See **P.98**)

MARKING ALL IMAGES

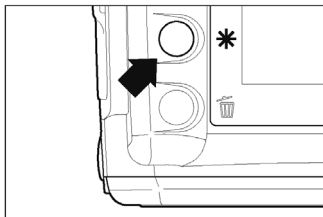

1

Press * to display the Modification Menu.



2

Use the  arrows on the 4-way controller to select the Mark Menu.

3

Use the  arrows on the 4-way controller to select "Mark all".



- If all images are already marked, the "Mark all" menu item will not be available.



4

Press  to display the confirmation dialog.

5

Press  to mark the images or press  to return to reviewing images without marking.

A flag icon  will appear in the upper-right corner of all marked images.

TIP

- Select "Unmark all" from the Mark Menu to unmark all marked images on the CF card.

ROTATING IMAGES

Images taken with a vertical (portrait) orientation can be rotated for more convenient viewing on the color LCD monitor or on an attached television. The images' new orientation will be used in all views as well as in the slideshow.

TIP

- Rotating an image will make it appear smaller on the display, but will have no effect on the quality of the image data.
- Images rotated on the camera will be displayed in their rotated orientation in **SIGMA Photo Pro**.

ROTATE MENU

MENU ITEM	DESCRIPTION
Rotate ↻	Rotate the currently selected image 90 degrees to the right (clockwise).
Rotate ↺	Rotate the currently selected image 90 degrees to the left (counterclockwise).

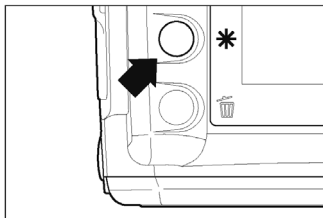

TO ROTATE AN IMAGE

1

Use the  arrows on the 4-way controller to select the image to be rotated in Contact Sheet or Single-Image View.



2

Press * to display the Modification Menu.

3

Use the  arrows on the 4-way controller to select the Rotate Menu.

4

Use the  arrows on the 4-way controller to select the rotation direction: clockwise  or counterclockwise .





5

Press **OK** to rotate the image and close the Modification Menu or **X** to return to reviewing images without rotating.

TIP

- To rotate an image 180 degrees, rotate it twice in the same direction.
- To get an image back into its original orientation, rotate it in the opposite direction.
- The **OK** button can be used as a shortcut key for rotating images. (See **P.97**)
- If the Rotate Menu was opened from Jump Mode, both **“Rotate”** menu items will be unavailable.

USING THE OK BUTTON SHORTCUT

The **OK** button can be used as a shortcut key for locking, marking, or rotating images. By setting the **OK** button to perform the most commonly used operation, images can be easily locked, marked, or rotated with a single button press. Alternatively, the **OK** button shortcut can be used to temporarily toggle the over-exposure overlay on or off.

TO SET THE OK SHORTCUT

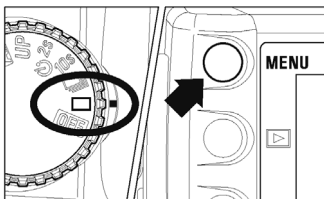

1

Press the **MENU** button on the back of the camera to display the Camera Set-up Menu. (See P.104)



2

Use the **◀▶** arrows on the 4-way controller to select "OK Shortcut".

3

Press the **▶** arrow or **OK** to open the sub-menu.

4

Use the **◀▶** arrows on the 4-way controller to select desired shortcut.

Shortcut options are: **None**, **Lock/Unlock**, **Mark/Unmark**, **Rotate** **↻**, **Rotate** **↺**, or **Exp. Warning**.

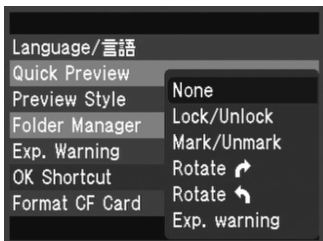

5

Press the **▶** arrow or **OK** to apply the setting or the **◀** arrow or **⊗** to close sub-menu without making any changes.

TO USE THE OK SHORTCUT

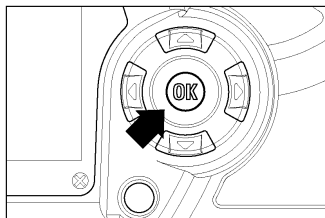

1

Press  to see recorded images.



2

Use the  arrows on the 4-way controller to select an image .

3

Press  to lock, mark, or rotate the image or toggle exposure warning (depending on the shortcut setting).

TIP

- If the shortcut is set to “**Lock**”, images that are already locked can be unlocked by pressing the  button. Similarly, if the shortcut is set to “**Mark**”, images that are already marked can be unmarked by pressing the  button.
- The  button can't be used as a shortcut key while a dialog box, menu, or error screen is open or if the camera is in Jump Mode.

SHOWING A SLIDESHOW

All images on the CF card, or only selected images, can be shown in an automatic playback mode using the SD14 camera's Slideshow feature.

SLIDESHOW MENU

MENU ITEM	DESCRIPTION
Resume show	Resume a stopped slideshow. (Not available if there is no slideshow to resume)
Show all	Start an automated slideshow of all images on the CF card.
Show marked	Start an automated slideshow of all marked images on the CF card.
Show locked	Start an automated slideshow of all locked images on the CF card.
Settings...	Change slideshow settings.

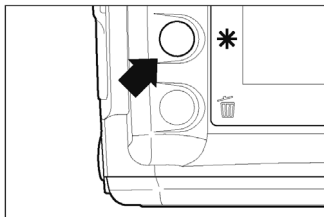

TO START A SLIDESHOW

1

Identify the images that you wish to include in the slideshow by marking or locking them. (See **P.90-95**)

2

Press * to display the Modification Menu.

3

Use the ◀▶ arrows on the 4-way controller to select the Slideshow Menu.

4





Use the ▲▼ arrows on the 4-way controller to select the slideshow contents: all images on the card, only the marked images, or only the locked images.

5

Press **OK** to close the Modification Menu and begin the slideshow.



TIP

- The , , , and  Controller will not work while a slideshow is in progress. To get additional information on an image, delete an image, or modify an image, press  to stop the slideshow.
- The Auto Power Off and LCD Sleep functions are disabled during slideshow playback.
- It is recommended that the camera be powered with the provided AC adapter during automatic slideshow playback to avoid draining the battery.
- For best results, rotate all slideshow images to the correct orientation and use an attached television monitor to display the slideshow.

TO MANUALLY ADVANCE OR REWIND A SLIDESHOW

Press the  arrow on the 4-way controller to advance to the next image

Press the  arrow on the 4-way controller to return to the previous image.

TIP

- Once manual navigation stops, the slideshow will continue to automatically advance to the next image after the duration set in the slideshow set-up page. (See Page 103).

TO STOP/PAUSE A SLIDESHOW

Press **X** to stop a slideshow and return to the previous view (Single-Image, Contact Sheet, etc.).

- The image that the slideshow stops on will become the currently selected image.

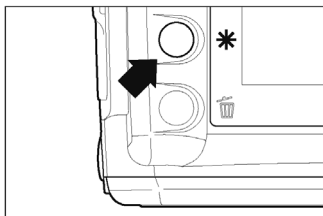

TO RESUME A STOPPED SLIDESHOW

1

Press * to display the Modification Menu.

2

Use the **◀▶** arrows on the 4-way controller to select the Slideshow Menu.

3

If not already selected, use the **◆** arrows on the 4-way controller to select "Resume show".

4

Press **OK** to close the Modification Menu and resume the slideshow.

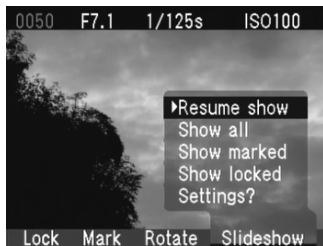

- The slideshow will resume with the next image in the sequence following the one the slideshow was stopped on.

TIP

- It will not be possible to resume a slideshow that has stopped automatically after the last image. (See **P.100** for setting slideshow repetition.)
- Pressing **MENU**, **▶** or the shutter release will also stop a slideshow, however, it will not be possible to resume a slideshow stopped in this manner.

CHANGING SLIDESHOW SETTINGS

You can customize slideshows by setting the length of time that images will be displayed and specifying whether or not the slideshow will repeat itself continuously.

SETTING	OPTIONS	DESCRIPTION
Duration	2 sec (default), 5 sec, 10 sec, Manual	Set the length of time that each image in a slideshow is displayed. (When set to "Manual", each image will remain on the screen until the slideshow is manually advanced.)
Repeat	Yes (default), No	Set whether the slideshow loops continuously or stops on the last image.

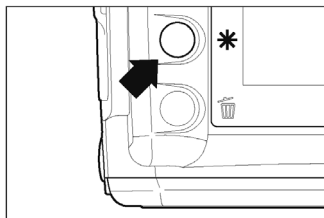

TO CHANGE SLIDESHOW SETTINGS

1

Press * to display the Modification Menu.

2

Use the ◀▶ arrows on the 4-way controller to select the Slideshow Menu.

3

Use the ⬆️ arrows on the 4-way controller to select "Settings...".

4

Press **OK** to open the slideshow set-up page.

5

Use the ⬆️ arrows on the 4-way controller to select a setting and use the ◀▶ arrows to cycle through the setting options.

6

Once all changes have been made, press **OK** to save the settings and return to the Slideshow Menu.



CAMERA SET-UP MENU

This section describes the various settings in the Camera Set-up Menu.

USING THE CAMERA SET-UP MENU

The Set-up Menu contains two types of menu items; items followed by an ellipsis (...) open dialog windows, all other items open sub-menus listing the setting options.

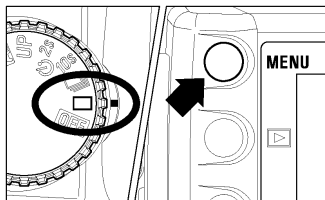



TO DISPLAY SET-UP MENU





Press the **MENU** button on the back of the camera.

- Press **MENU** again to close the Set-up Menu and turn off the color LCD monitor.



While in the Set-up Menu:

- Use the  arrows on the 4-way controller to select menu items.
- Press the  arrow or  to open sub-menus or dialogs.

While in set-up sub-menus:

- Use the  arrows on the 4-way controller to select setting options.
- Press the  arrow or  to apply new settings.
- Press the  arrow or  to close sub-menus without applying changes.

LIST OF MENU FUNCTIONS

Menu Item	Options	Description	Page
Set Custom WB...	[Dialog]	Captures the image to be used for the custom white balance setting.	56,57
Adjust Setting	Contrast Sharpness Saturation Color Space	Sets image parameter and color space.	59~60
Date/Time...	[Dialog]	Sets the date and time in the camera's internal clock and the format in which the date and time will be displayed.	27
Language/言語	English * 日本語 Deutsch 中文 Français Español Italiano 한국어	Sets the language in which menus and messages will be displayed.	26
Quick Preview	Off 2 sec.* 5 sec. 10 sec. Hold	Sets the duration of the Quick Preview image that is automatically displayed on the color LCD monitor after the image is captured.	72,73
Preview Style	Image only * Info screen	Sets the type of information displayed in the Quick Preview image.	74
Folder Manager	Create Folder Folder Select	Creates a new folder and enables the selection of folders for image recording.	32,33
Exp. Warning	Off * On	Sets whether or not the over - exposure warning is shown on images.	84
OK Shortcut	None * Lock/Unlock Mark/Unmark Rotate  , Rotate  Exp. warning	Sets the function that the <✓OK> button will perform during image review.	98,99

Format CF Card...	[Dialog]	Formats the CF card. (Formatting will erase all data on the card.)	30
File Numbering	Continuous * Auto reset	Sets the file numbering system used when a new CF card is inserted in the camera.	31
LCD Brightness	Dim Normal * Bright	Sets the color LCD monitor brightness.	—
LCD Contrast	High Medium * Low	Sets the color LCD monitor contrast.	—
LCD Sleep	30 sec.* 1 min. 2 min. 5 min. 10 min. 15 min. 30 min. Off	Sets the delay before the color LCD monitor turns off automatically if no operation has occurred.	115,116
Auto Power Off	10 sec. 30 sec.* 1 min. 5 min. Off	Sets the delay before the camera shuts down automatically if no operation has occurred.	115,116
Key Sound	Long Short * Off	Sets the duration of the tone that indicates a successful button press. (This setting will not affect the electronic sound setting, which indicates image focus. See P.36 for setting the electronic sound.)	—
Video Mode	NTSC * PAL	Sets the standard to be used for video output when the camera is connected to a television or VCR.	85
Firmware	Current version Firm update	Confirm current firmware version and update the latest firmware version from CF card.	
Camera Reset...	[Dialog]	Restores all menu options to their default settings. (Default settings are indicated by a *.)	—

* Designates the default option. Some defaults may vary depending on country of purchase.

CAMERA INFO PAGE

The Camera Info Page can be used to get at-a-glance information about image-capture settings (like ISO, resolution, and white balance) and CF card status.

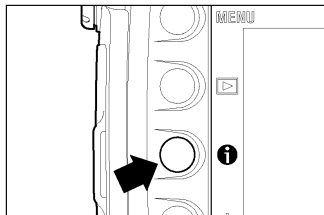

TO VIEW THE CAMERA INFO PAGE

1

Make sure the camera is turned on.

2

Press the **i** button to open the camera info page.

3

Once you are done reviewing your settings, press **OK** to close the Camera Info Page and return to the main menu.

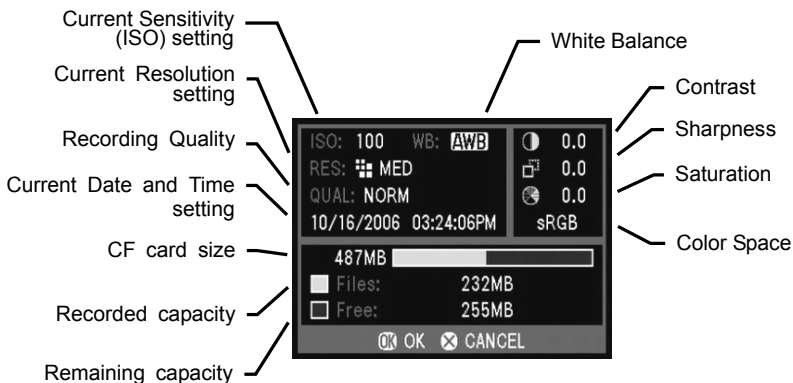

REFERENCE

OPTIONAL ACCESSORIES

REMOTE CONTROLLER RS-31

Wireless remote control, permits releasing the shutter from a place away from the camera. Time for a shutter release can be set up in two stages. Moreover, a setup of a channel is also possible, to avoid interference with other cameras and remote controls. (For detailed information please refer page 67)

POWER GRIP PG-21

This battery pack extends power capacity of the SD14 two times and can also be used as a vertical position grip. Two BP-21 Lithium-ion batteries can be used in Power Pack SD. In addition, it is equipped with a vertical shutter release to hold the camera steady in the vertical position.

ELECTRONIC FLASH EF-500 DG SUPER SA-STTL

Auto zoom flash with abundant light and STTL Automatic Exposure with the maximum guide number 50/m (165/ft) (ISO100).

EF-500 DG SUPER SA allows you to use many advanced flash techniques such as "STTL system Auto Flash" or Multi Flash etc. (Please refer to page 70 for details).

ELECTRONIC FLASH EF-500 DG ST SA-STTL

Auto zoom flash with abundant light and STTL Automatic Exposure with the maximum guide number 50/m (165/ft) (ISO100). It provides a proper flash exposure under any lighting conditions and it is equipped with bounce flash function, same as EF-500 DG Super. (Please refer to page 70 for details.)

CABLE RELEASE SWITCH CR-21

It can connect with release socket, on the camera body, and the shutter can be released, without touching the camera. This accessory minimizes the camera shake, which can result in blurriness of your photograph, especially when using Mirror up and a super-telephoto lens. (It is connected to release socket of the camera. Since it is not equipped with "Halfway" operation. Please press the shutter button "Half-way" and check the exposure. Please adjust the focus manually.)

AC ADAPTER SAC-2

This is used to provide a constant electricity supply when shooting in the studio, or taking indoor shots. It is also recommended for use when connecting the camera to your computer to transfer data.

EYEPIECE DIOPTRIC CORRECTION LENSES

The SD14 has a built-in type "Diopter Adjuster" and its range is $-3 \sim +1.5$ dpt, if you still cannot see the viewfinder clearly, then please purchase a viewfinder diopter adjustment eyepiece. These are series of seven optional accessory lenses, which adjust the camera's viewfinder to accommodate the vision requirements (near-sightedness or far-sightedness) of different photographers. They attach to the camera's eyepiece frame. The dioptic correction values of these lenses range from -4 to $+3$.

MAINTENANCE

- Do not use chemicals or other cleaning agents such as thinners or benzene for cleaning the camera and lens. Use a clean, soft cloth and blower to clean the camera and lens. Lens cleaners can be used for removing fingerprints.
- Do not lubricate the camera, lens or lens contacts.
- Use a blower to remove dust and dirt from the color LCD monitor. To remove fingerprints or other stains from the LCD monitor, wipe the surface gently with a soft, clean cloth. Do not apply excessive force, as this could damage the LCD monitor.
- The Sigma SD14 camera contains a dust protector located inside the lens mount. The dust protector is a very delicate device and care must be taken not to scratch its surface. Use a blower to remove dirt and dust from the dust protector. Do not use a blower brush, as the bristles could scratch the dust protector surface. To avoid damage, do not apply pressure to the dust protector.

CLEANING THE IMAGE SENSOR

Although SD14 is equipped with a dust protector to prevent dust or dirt from entering the camera, in rare circumstances, dust or dirt may adhere to the image sensor, causing black spots to appear on images. If this occurs, it may be necessary to clean the image sensor.

- The image sensor is extremely delicate and can easily be damaged. We recommend that you contact an authorized Sigma Service Station to have the sensor cleaned. We do not advise attempting the procedure yourself, especially if you have no previous experience cleaning delicate optical components.

WARNING!!

- The image sensor is a very important part of your camera. Please take all necessary precautions to avoid damaging the sensor.
- Do not use an aerosol compressed air cleaner. Liquid may leak from the cleaner and damage the image sensor or other electronics inside the camera.
- After cleaning the image sensor, please ensure the dust protector is correctly attached. If the dust protector is not properly attached, it may move and damage the image sensor of the camera or the lens.

If you feel qualified to clean the image sensor, prepare the following tools:

- Dedicated AC adapter “SAC-2” (Cleaning cannot be done when the camera is powered by the Lithium battery. Please use the AC adapter SAC-2 (sold separately) only as the power source when cleaning).
- Blower (Do not attach the brush, as it can scratch the image sensor surface.)

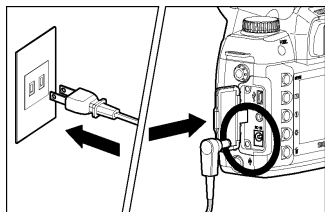

1

Connect the AC adapter to the camera and plug it into a wall socket. (P.23)

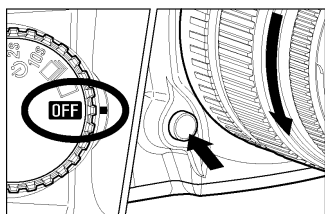

2

Turn the “D”-Dial to the **OFF** position and remove the lens.

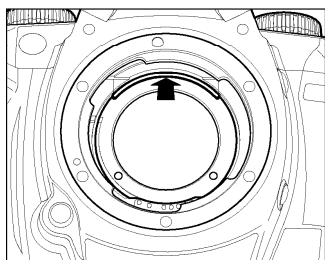

3

To detach the dust protector, slide it upwards from its projecting lip with your fingernail. Be careful not to touch the glass on the dust protector.

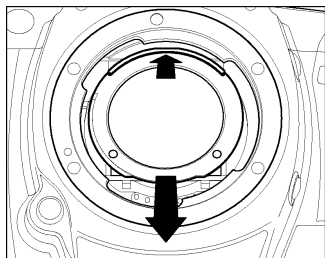

4

Once the dust protector slides upwards, the lower part of the dust protector is released. Grasp it and remove the dust protector. (Be careful not to touch the glass on the dust protector.)

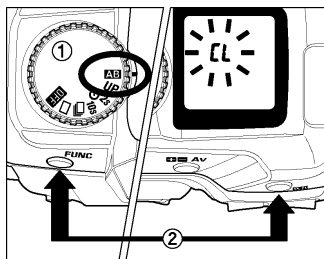

5

Turn the “D”-dial to the **AB** position and press the **FUNC** and **INFO** button together. (The CL icon will be displayed on the top LCD panel, the shutter will open and you will be able to see the image sensor).

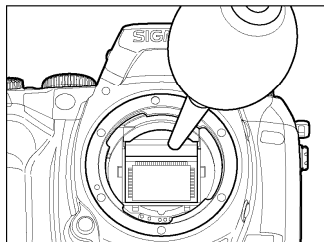

6

Carefully blow away any dust from the image sensor using the blower.

Make sure that the tip of blower does not protrude inside the lens mount. If the power supply should suddenly shut off, the shutter curtain and mirror will close. These delicate parts could hit the blower and damage the camera.

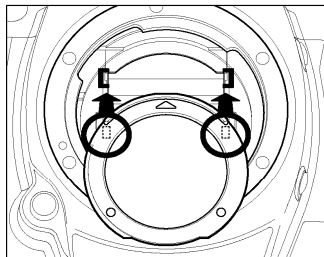

7

Once you are done cleaning the image sensor, turn the “D” –Dial to the **OFF** position. Check that there is no dust or dirt on the dust protector.

Insert the upper tabs on the back of the dust protector into the two holes as shown in the illustration.

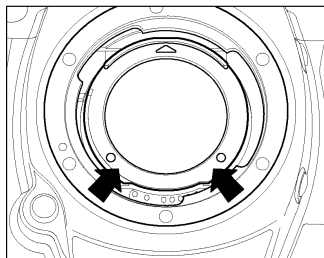

8

Push the lower section of the dust protector, as shown in the illustration, with your finger until it clicks into position. In order to avoid any damage, please ensure that the dust protector is correctly positioned.

If the dust or dirt cannot be removed with the above-mentioned procedure, consult with Sigma- authorized service personnel.

If you see fingerprints on the glass portion of the dust protector, first use a blower to remove any dust, then gently wipe it with a soft, clean cloth.

EXPLANATION OF TERMS

AE

Auto Exposure; by using a built-in exposure meter, camera determines the correct exposure value, which is combinations of shutter speed and/or aperture value.

AE Lock

The camera will fix and memorize the exposure value with AE lock. For example, if a photographic subject is placed in the center and exposure value of the composition is fixed, the brightness of the background will not influence the exposure, even if the composition changes and the subject is moved from the center of a screen. (AE lock button must be used).

AF

Auto Focus; by using a built-in sensor, camera adjusts the focusing automatically.

AF Lock

In AF shooting mode, you can lock the focus on the main subject. For instance, compose the desired subject in the center of the viewfinder. With the focus fixed at the same setting, you can re-compose the picture with the subject off-center and take shots. (Please press the shutter button "Half-way" to use this feature with Sigma SD14).

Aperture

The lens opening of the iris diaphragm inside the lens. The amount of light, which strikes the image sensor, is adjusted by the iris diaphragm. The f-number (Focal Length/Diameter of the Aperture Opening) describes the size of this opening, the size of the hole can be made larger or smaller. Large aperture (low f-number) gives bright results and, small aperture (high f-number) gives darker results.

Auto Power-Off

For saving the battery power, the SD14 camera can automatically turn itself off, if you do not operate it.

CMOS

Complementary Metal Oxide Semiconductor (CMOS) can perform signal amplification on a per-pixel basis. Significant current flows only during the switching operation. Therefore a CMOS image sensor can scan data rapidly, sustain high-speed operation and consume less energy. Recent technological and production improvements in digital imaging systems are making CMOS more and more competitive in terms of image quality and cost.

Color Temperature

The numerical expression of the tone of the light, produced by a light source. The standard unit for color temperature is degrees Kelvin (K). The sunny daylight used as a standard near 5600 K. Low color temperature implies warmer more yellow/red light while high color temperature implies a colder more blue light. The typical color temperature of Tungsten light is 3200 K grade, a personal computer is 9300 K.

Exposure.

The amount of light reaching the image sensor's surface. The exposure is controlled by the combination of aperture and shutter speed.

EV

Exposure Value (EV) is a numerical value that expresses the amount of light for a given exposure, and depends on brightness of the photographic subject and sensitivity of the film. If a photographic subject is bright, then this numerical value will be large, and if the subject is dark then this numerical value will be small. If two-times of light reaches the film surface then the difference in exposure value will be +1, and if the amount of light is reduced by half, the exposure value changes by -1.

Histogram

The histogram function is a graphic representation of how bright and dark pixels are distributed in an image. The histogram function enables a precise check on the exposure of the photo.

ISO Sensitivity

ISO (International Organization for Standardization) ; refers to the number assigned to each silver halide film, which indicates film speed or the film's relative sensitivity to light, the higher the number, the greater photosensitivity and vice versa. Digital cameras also use standard ISO sensitivity ratings like silver halide films.

JPEG

Joint Photographic Experts Group has established a standard method for compressing and decompressing the digitized images. If the rate of compression is high the file size will be small but picture quality will be decreased.

Microdrive

Developed by IBM, the Microdrives are extremely small-sized hard disks that can fit in a CompactCard memory slot. The Microdrive is built into a Type II CompactFlash form factor.

NTSC

National Television Standards Committee (NTSC) video format is primarily used in the United States, Japan, Canada etc. The NTSC is a standard for television and videos, which defines a composite video signal with a refresh rate of 60 half-frames (interlaced) per second. Each frame contains 525 lines and can contain 16 million different colors.

PAL

Phase Alternating Line (PAL), video format primarily used in Europe, excluding France, as well as Australia and parts of the Far East. PAL delivers 625 lines at 50 half-frames per second.

RAW

The RAW image format is the data as it comes directly from the image sensor of the camera. No in-camera processing is performed before transferring the image to computer.

Shutter Speed

The camera's shutter opens for a length of time to control the amount of light that reaches the imaging element. The length of time that shutter blinds are open allowing light to strike the image sensor is called as shutter speed.

White Balance

The human eye and brain adapt to changes in lighting conditions, not only to intensity, but also to the color characteristic of the light source, so that colors of the objects look normal or accurate. For example, a white object will appear white whether it is viewed under sunlight, tungsten or fluorescent illumination. However, color film or digital camera must be adjusted, so that colors will be represented accurately, under different types of illumination. This adjustment is called white balance. The function to adjust a white balance automatically is called automatic white balance.

AUTO POWER OFF

In order to conserve battery power, the SD14 camera goes into a low-power mode if not used for a predetermined amount of time. The Auto Power Off timeout can be set using the Camera Set-up Menu to 10 seconds, 30 seconds, 1 minute, 5 minutes, or Off. The default setting is 30 seconds.

TIP

- The VIEW and MENU buttons will not be active when the camera is in low-power mode. This prevents the color LCD monitor from being accidentally turned on and draining the battery while the camera is not being used. To reactivate the VIEW and MENU buttons, simply press the shutter halfway or turn the "D"-dial to another position and back; this will take the camera out of low-power mode and allow you to perform all regular camera functions.
- It will still be possible to take pictures while the camera is in low-power mode. To take a picture simply press the shutter button half-way to activate the exposure metering and autofocus mechanism, then press the shutter fully to take the picture.
- The Auto Power Off timeout counter will not start until the color LCD monitor is turned off, either manually or by the LCD Sleep timeout.

AUTO POWER OFF OPTIONS

OPTION	DESCRIPTION
10 seconds	Camera goes into low-power mode if not used for 10 seconds.
30 seconds	Camera goes into low-power mode if not used for 30 seconds.
1 minute (Default)	Camera goes into low-power mode if not used for 1 minute.
5 minutes	Camera goes into low-power mode if not used for 5 minutes.
Off	The Auto Power Off function is disabled.

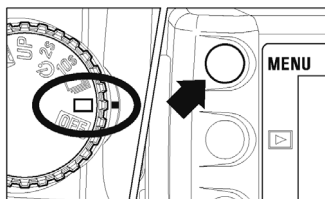

TO SET AUTO POWER OFF

1

Make sure the camera is turned on.

2

Press the **MENU** button on the back of the camera to display the Camera Set-up Menu. (See P.104)

3

Use  arrows on the 4-way controller to select "Auto Power Off".

4





Press  arrow or  to open sub-menu.



5

Use  arrows on the 4-way controller to select desired setting.

6

Press  arrow or  to apply the setting or  arrow or  to close sub-menu without making any changes.

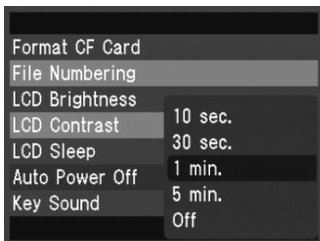

WARNING DISPLAYS

TOP LCD PANEL WARNING INDICATIONS

Some part of battery icon is off

Battery is low

- ▶ Have fresh battery ready.

Battery icon blinks

Battery is very low and just about exhausted.

- ▶ Replace battery with new one. (P.19~21)

It is malfunctioning because of an unknown reason.

- ▶ Take battery out and reload again, then turn on the camera. (P.19~21)

Exposure Blinks

Exposure Control exceeds the operating range.

- ▶ Choose an exposure value until blinking disappears. (P.37~40)

“---” is displayed on the frame counter.

CF card is not inserted.

- ▶ Please insert CF card. (P.28)

Frame counter does not show a number other than 999

Even if it is possible to record more than 999 images on the CF Card, the maximum number of frames that can be seen on the counter is 999.

- ▶ The frame counter changes, if frame counter is 998 or less. (P.33)

Shutter speed indicates “FuL” and frame number shows “0”, both indicators blink.

No more space available to store images on CF card.

- ▶ Insert a new “CF card” or delete unnecessary images. (P.86~88)

The cursor will be in motion on the frame number value

The camera is busy with image processing.

- ▶ Please wait until the process ends. (P.34)

Shutter speed shows “Err”

Camera is malfunctioning because of some reason.

- ▶ Please reset your camera by turn off the power switch and turn on again.
If problem persist then please contact store that you purchased the camera.

Frame counter shows “Err”

CF Card might be faulty.

- ▶ Please replace the CF card. (P.28~29)

COLOR LCD MONITOR MESSAGES

“No CF card in camera”

The camera can not detect a CF card.

- ▶ Please Insert the CF Card. (P.28)

“Incompatible file system. Format card.”

The CF card is corrupt or not formatted properly.

- ▶ Format CF card. If the error persists, replace with new card. (P.30)

“CF card is full!”

There is no more room on the CF card.

- ▶ Delete unwanted photos, choose a lower resolution setting, or use a different card. (P.86~88)

“No images on CF card”

The  button has been pressed when there are no SD14 images on the CF card.

- ▶ To review images, insert a card with valid SD14 images, capture new images onto the card, or press  button again to turn off display.

“Error writing to CF card!”

There was an error writing to the CF card.

- ▶ Turn the camera off and back on. Verify that the card has not been corrupted by pressing the  button. If the problem persists, call Technical Support.

An error has occurred! Error code # # #.

An error has occurred on the camera.

- ▶ Turn the camera off and back on. If the problem persists, call Technical Support and give them the error number.

“CF card cover is open!

Do not remove CF card while the camera is on or busy light is flashing!”

The CF card slot cover has been opened.

- ▶ Close CF card cover immediately. The CF card cover should not be opened while the camera is on.

TROUBLESHOOTING

If you have a problem with your camera or cannot take good pictures, consult the list below as you check the camera before requesting repairs.

No indication on the top LCD panel

Battery is exhausted.

- ▶ Replace the battery. (P.19–21)

Battery is improperly installed.

- ▶ Insert the battery in the proper direction. (P.19–21)

The shutter does not release

Battery is exhausted.

- ▶ Replace the battery. (P.19–21)

D-dial is set outside of the Drive Area.

- ▶ Set the D-dial to the Drive Area to take a picture. (P.51)

Camera is unable to get a focus lock when set to AF-S mode.

- ▶ Try focusing on a different subject or focus the camera manually. (P.46–50)

CF card is not inserted or is inserted improperly.

- ▶ Insert the CF card correctly. (P.28)

The camera is busy writing to the CF card.

- ▶ Please wait until the CF card busy light goes off. (P.34)

CF card is full.

- ▶ Insert a new CF card or delete unwanted images. (P.86–88)

Autofocus does not operate

The AF/M switch on the lens body is set to **M**.

- ▶ Set the AF/M switch on the lens to **AF**. (P.46)

Lens is not properly mounted to the camera body.

- ▶ Mount the lens to the camera body correctly. (P.24)

The buttons on the back of the camera don't work

Auto Power Off is activated.

- ▶ Press the shutter button halfway to reactivate the buttons.
- ▶ Disable Auto Power Off in the Set-up Menu. (P.104,106)

Difficulty seeing the images on the color LCD monitor.

Dust or dirt has adhered to the color LCD monitor.

- ▶ Clean the color LCD monitor with a blower or eyeglass cloth. (P.109)

The color LCD monitor is worn out.

- ▶ Please consult the retailer from which you purchased the camera or contact the nearest Sigma Service Center.

Pictures are coming out blurred

The AF/M switch on the lens body is set to **M**.

- ▶ Set the AF/M switch on the lens to **AF**. (P.46)

Hand movement or camera shake occurred when the shutter button was pressed.

- ▶ To prevent blurring, press the shutter button more gently or use remote controller, cable release switch or a tripod.

Cannot use the CF card

Image data on the CF card is corrupted.

- ▶ Format the CF card. (P.30)

Cannot delete images

Images may be locked.

- ▶ Unlock the images. (P.90–92)

Incorrect date and time is shown

Date and time setting may be incorrect.

- ▶ Enter the correct date and time in the Set-up Menu. (P.27)

No image appears on the TV monitor

Video cable is not correctly inserted.

- ▶ Insert the video cable correctly. (P.85)

SPECIFICATIONS

Camera Type	Interchangeable Lens SLR Type Digital Camera
Storage Media	CompactFlash™ (CF) (Type I / II), HITACHI MicroDrive™
Image Sensor Size	13.8 x 20.7mm
Lenses Used	Sigma SA Mount Lenses
Picture Angle	Equivalent to 1.7x the focal length of a lens when used on a 35mm SLR camera.
Lens Mount	SA mount
Imaging Element Type	FOVEON® X3™ (CMOS)
Color Photo Detectors	14.06 Million (2652 Columns x 1768 Rows x 3 Layers)
Aspect Ratio	3 : 2
Image Recording Format	Lossless compression RAW Data (12bit), JPEG
Resolution	Super Hi(JPEG) : 4608 x 3072, HI : 2640 x 1760 MED : 1776 x 1184, LOW : 1296 x 864
Interfaces	USB 2.0, Video Out (NTSC/PAL)
White Balance	8 Type (Auto, Sunlight, Shade, Overcast, Incandescent, Fluorescent, Flash, Custom white balance)
Viewfinder Type	Pentaprism SLR Viewfinder
Viewfinder Frame Coverage	98% horizontal, 98% vertical
Viewfinder Magnification	0.9x (50mm F1.4 at infinity)
Eyepoint	18mm
Diopter Adjustment Range	-3dpt to +1.5dpt
Auto Focus Type	TTL phase difference detection system
AF Operating Range	EV 0 to 18 (ISO100)
Focus Mode	Single AF, Continuous AF (AF Predict function), MF
Metering Systems	8-segment Evaluative Metering, Center Metering, Center-Weighted Average Metering
Metering Range	EV 1 to 20 (with 50mm F1.4 at ISO100)
Exposure Modes	(P) Program AE, (A) Aperture Priority AE, (S) Shutter Speed Priority AE, (M) Manual
ISO Sensivity	ISO 100, 200, 400, 800, (1600)
Exposure Compensation	±3EV (in 1/3steps)
AE Lock	Push button type
Auto Bracketing	±3EV (in 1/3steps, Appropriate Exposure – Under Exposure – Over Exposure)
Shutter Type	Vertical-travel metal focal plane shutter, electronically controlled through entire speed range
Shutter Speeds	1/4000sec to 30sec, Bulb up to 30sec Flash Synchronization at 1/180sec.

Burst Rate	HI Mode : 3.0fps for 6 frames, MED Mode: 3.0fps for 12 frames, LOW Mode: 3.0fps for 24frames
External Flash Synchronization	Hot shoe (contact X, with dedicated flash linking contact)
LCD Monitor Type	2.5", low-temperature polysilicon TFT color LCD monitor, approx. 150,000 pixels, Coverage area 100% with white LED backlight
Reviewing Images	Single-Image display, Zoom-in display, 9 segments thumbnail display, Slide Show
Language	Chinese / English / French / German / Italian / Japanese / Korean / Spanish
Power Source	lithium ion battery BP-21 AC Adapter SAC-2
Dimensions	144mm/5.7"(W) X 107.3mm/4.2"(H) X 80.5mm/3.2"(D)
Weight	700g / 24.7oz (without battery)

CONNECTING YOUR CAMERA TO A COMPUTER

The SD14 camera can be connected directly to a computer using the provided USB cable. Make sure that the camera is off before connecting it to the computer. Data transfer rates will vary depending on the computer and operating system used. For further information, please refer to the SIGMA Photo Pro User Guide, which is available in PDF format on the supplied CD-ROM.

CONNECTING THE CABLES

- The shutter button and color LCD monitor will be disabled while the camera is connected to the computer via a USB cable.

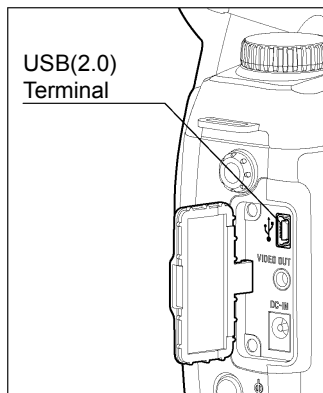

WARNING!!

- Please use only the USB cable supplied with your camera.

This device complies with Part 15 of the FCC Rules. Operation is subject to the following two conditions:
(1) This device may not cause harmful interference, and
(2) this device must accept any interference received, including interference that may cause undesired operation.

SIGMA FC Tested To Comply With FCC Standards FOR HOME OR OFFICE USE	SD14
--	-------------

SIGMA CORPORATION OF AMERICA
15 Fleetwood Court, Ronkonkoma,
NY 11779, U.S.A.
TEL: 631 585 1144

For customers in the U.S.A.

Federal Communications Commission (FCC) Radio Frequency Interference Statement

This equipment has been tested and found to comply with the limits for class B digital devices, pursuant to Part 15 of the FCC Rules. These limits are designed to provide reasonable protection against harmful interference in a residential installation. This equipment generates, uses and can radiate radio frequency energy and, if not installed and used in accordance with the instructions, may cause harmful interference to radio communications. However, there is no guarantee that interference will not occur in a particular installation. If this equipment does cause harmful interference to radio or television reception, which can be determined by turning the equipment off and on, the user is encouraged to try to correct the interference by one or more of the following measures:

- Reorient or relocate the receiving antenna.
- Increase the separation between the equipment and receiver.
- Connect the equipment into an outlet on a circuit different from that to which the receiver is connected.
- Consult the dealer or an experienced radio/TV technician for help.

Use of interface cable is required to comply with class B limits in Subpart B of Part 15 of FCC Rules.

Any changes or modifications to this equipment not specified in this manual may void your warranty.

For customers in the Canada

This Class B digital apparatus complies with Canadian ICES-003.

Cet appareil numérique de la classe B est conforme à la norme NMB-003 du Canada.



The CE Mark is a Directive conformity mark of the European Community (EC).

SIGMA (Deutschland) GmbH

Carl-Zeiss-Str. 10/2, D-63322 Roedermark, Germany

Verkauf: 01805-90 90 85-0 Service: 01805-90 90 85-85 Fax (Service): 01805-90 90 85-35

SIGMA CORPORATION

2-4-16 Kuriki, Asao-ku, Kawasaki-shi, Kanagawa 215-8530 Japan

Phone : 044 - 989 - 7430 Fax : 044 - 989 - 7451