

WiVIEW

WMT-1000I

WMT-1000O

USER'S MANUAL

Version 1.0

Notice
This device has been approved by FCC for a home appliance and is suitable for all residential areas.

- © 2006 Copyright SIGMACOM CO., LTD. All right reserved
- All trademarks are the properties of their respective owner.
- The information contained herein is subjected to change without notice.

WMT-10000 Specification

■ Power Supply

Adaptor

IN: 100-240V~50/60Hz 0.5A

OUT: 12V, DC 1.25A

■ Power Consumption : 2.5mW/MHz

■ Digital Modulation : OFDM

■ Channel

3Channel (5180MHz, 5200MHz, 5220MHz), BAND WIDTH : 20MHz

■ VIDEO

OUTPUT : Composite, S-Video, Component (480i)

■ AUDIO

OUTPUT : 2-Channel Stereo

■ FRONT

LED Lamps : Power (Red), Signal (Green)

■ Physical Specification

Size (W * H * D) : 42 * 230 * 195 (Without Stand)

85 * 240 * 195 (With Stand)

Operating Temperature : -10°C ~ +50°C

Storage Temperature : -10°C ~ +70°C

WMT-1000I Specification

■ Power Supply

Adaptor

IN: 100-240V~50/60Hz 0.5A

OUT: 12V, DC 1.25A

■ Power Consumption : 2.5mW/MHz

■ Digital Modulation : OFDM

■ Channel

3Channel (5180MHz, 5200MHz, 5220MHz), BAND WIDTH : 20MHz

■ VIDEO

INPUT : Composite, S-Video, Component (480i, 480p, 720p, 1080i)

■ AUDIO

INPUT : 2-Channel Stereo

■ PC Interface : USB

■ 2-Input IR Blaster

■ FRONT

LED Lamps : Power (Red), Signal (Green)

■ Physical Specification

Size (W * H * D) : 42 * 230 * 195 (Without Stand), 85 * 240 * 195 (With Stand)

Operating Temperature : -10°C ~ +50°C

Storage Temperature : -10°C ~ +70°C

Overview of WiVIEW

Safety notice and Warning

Restricted to indoor use.

FCC notice to users and product statements

THIS DEVICE COMPLIES WITH PART 15 OF THE FCC RULES.

Operation is subject to the following two conditions; (1) this device may not cause harmful interference, and (2) this device must accept any interference received, including interference that may cause undesired operation.

CAUTION: Changes or modifications not expressly approved by the party responsible for compliance could void the user's authority to operate the equipment.

This appliance and its antenna must not be co-located or operating in conjunction with any other antenna or transmitter. A minimum separation distance of 20 cm must be maintained between the antenna and the person for this appliance to satisfy the RF exposure requirements.

NOTE: This equipment has been tested and found to comply with the limits for a Class B digital device, pursuant to Part 15 of the FCC Rules. These limits are designed to provide reasonable protection against harmful interference in a residential installation. This equipment generates, uses and can radiate radio frequency energy and, if not installed and used in accordance with the instructions, may cause harmful interference to radio communications. However, there is no guarantee that interference will not occur in a particular installation.

If this equipment does cause harmful interference to radio or television reception, which can be determined by turning the equipment off and on, the user is encouraged to try to correct the interference by one or more of the following measures:

- Reorient or relocate the receiving antenna.
- Increase the separation between the equipment and receiver.
- Connect the equipment into an outlet on a circuit different from that to which the receiver is connected.
- Consult the dealer or an experienced radio/TV technician for help.

European CE notice to users and product statements

This product is CE marked according to the provisions of the R & TTE Directive (99/5/EC). Hereby, Sigmacom Co., Ltd declares that this product is in compliance with the essential requirements and other relevant provisions of Directive 1999/5/EC. For further information, please contact <http://www.sigmacom.co.kr/eng/main/>

Operating Matrix

1. Connect video-out of PC or VIDEO out-put device(DVD player, DVR) to video-in of the WMT-1000I(server) with cable.
2. Connect video-in of TV or other displays to image-out of the WMT-1000O(client) with cable.
3. WMT-1000I encode a video data into MPEG2 and transmit encoded data to WMT000O in the band of 5180khz,5200khz and 5220khz in 802.11a protocol.
4. After WMT-1000O receives the encoded data, WMT-1000O decode the data into analog signal and transmits to TV or other displays.
5. According PC connection, remotecontrol transmits PC control-signal to WMT-1000O and WMT-1000O transmit the signal to WMT-1000I by wireless and WMT-1000I transmits the signal to PC by USB port.

Contents

Overview of Wi-VIEW

Safety notices and warnings

Checking Wi-VIEW package

Each part description

Using remote control

- Controlling Wi-VIEW
- Controlling SMC(Sigma Multimedia Center)
- Installing batteries

Placing Wi-VIEW on the stand

Hardware Installation

Connecting Wi-VIEW

Connecting to WMT-1000I of Wi-VIEW

- Connecting satellite receiver or cable TV receiver
- Connecting VCR
- Connecting DVD Player or Game console
- Using the remote control of external video device

Connecting to WMT-1000O of Wi-VIEW

- Connecting analog TV set
- Connecting HDTV Ready set

Main functions

Using the remote control of menu screen

Starting Wi-VIEW

Setting Input

Setting Output

Adjusting image quality

Setting OSD language

Additional functions

- Checking Wi-VIEW's information
- Setting screen saver
- checking network status

Using SMC (Sigma Multimedia Center)

Basic screen content

Description of each button of the remote control

SMC function

1) TV

- Running TV program
- Setting antenna
- Setting TV channel (registered/preferred)
- EPG(Electronic Programming Guide)
- Reservation
- Multi-screen

2) Music

- 3) Picture
- 4) Video
- 5) DVD
- 6) Radio
- 7) Setup
 - Standard setting
 - TV setting
 - File setting
 - Multimedia setting

Accessories

Thank you for purchasing the Wi-VIEW.

When removing the package, make sure that the following contents are included.

If you find any missing part, please contact our near dealer or distributor.

WMT-1000I - 1 EA	Holder - 2EA
WMT-1000O - 1 EA	Remote control
Power Adaptor - 2EA	Sound(2RCA) cable
Composite (3 RCA) cable - 2EA	IR Blaster cable
Component (YPbPr) cable - 2EA	USB cable
S-Video cable - 2EA	

Part name

■ Front

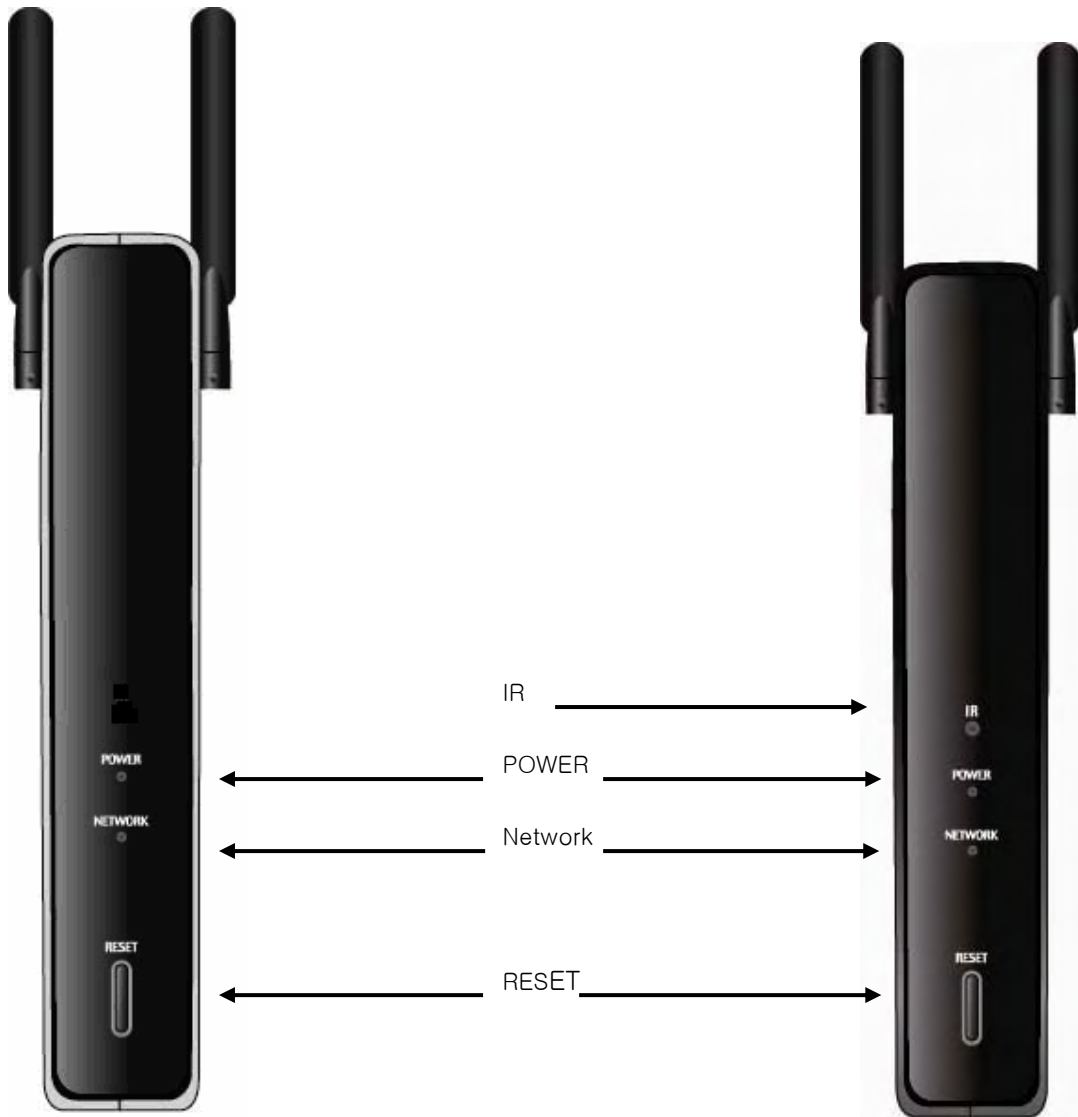

< Server **Input**>

WMT-1000I

< client **Output**>

WMT-1000O

- Power: The status of Power
- Network : The status of wireless connection
- Reset : Used for reboot

IR: The status of remote control receiver

Power: The status of Power

Network : The status of wireless connection

Reset : Used for reboot

* Back

. WMT-1000I

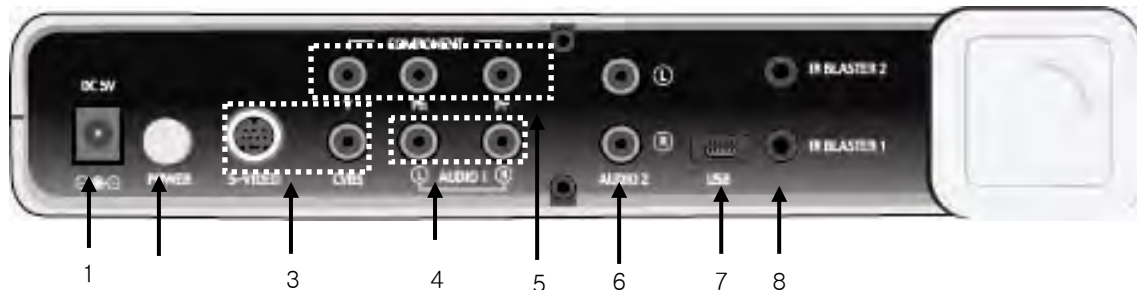

1. **DC-In:** Used for Power In
2. **Power button:** Used for power on
3. **Video In(S-VIDEO&CVBS):** Used for receiving video signal (S-VIDEO, COMPOSITE) from external devices.
4. **Sound In:** Used for receiving audio signal(S-VIDEO, COMPOSITE) from external devices.
5. **Video In (Component):** Used for receiving video signal (COMPONENT) from external devices.
6. **Sound In:** Used for receiving audio signal (COMPONENT) from external devices.
7. **USB Port:** Used for upgrading the firmware from PCs
8. **IR Blaster Port:** Used for a remote control of external devices.

. WMT-1000O

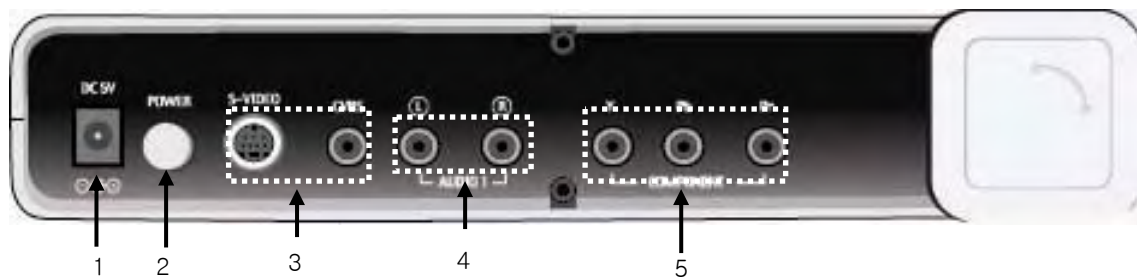

1. **DC-In:** Used for power In
2. **Power button:** Used for power on
3. **Video Out (S-VIDEO&CVBS):** Used for sending video signal (S-VIDEO, COPOSITE) to Wi-VIEW input.
4. **Sound Out:** Used for sending audio signal to Wi-VIEW input.
5. **Component (YPbPr) out:** Used for sending video signal Component) to Wi- VIEW input.

Using remote control

* Wi-VIEW control

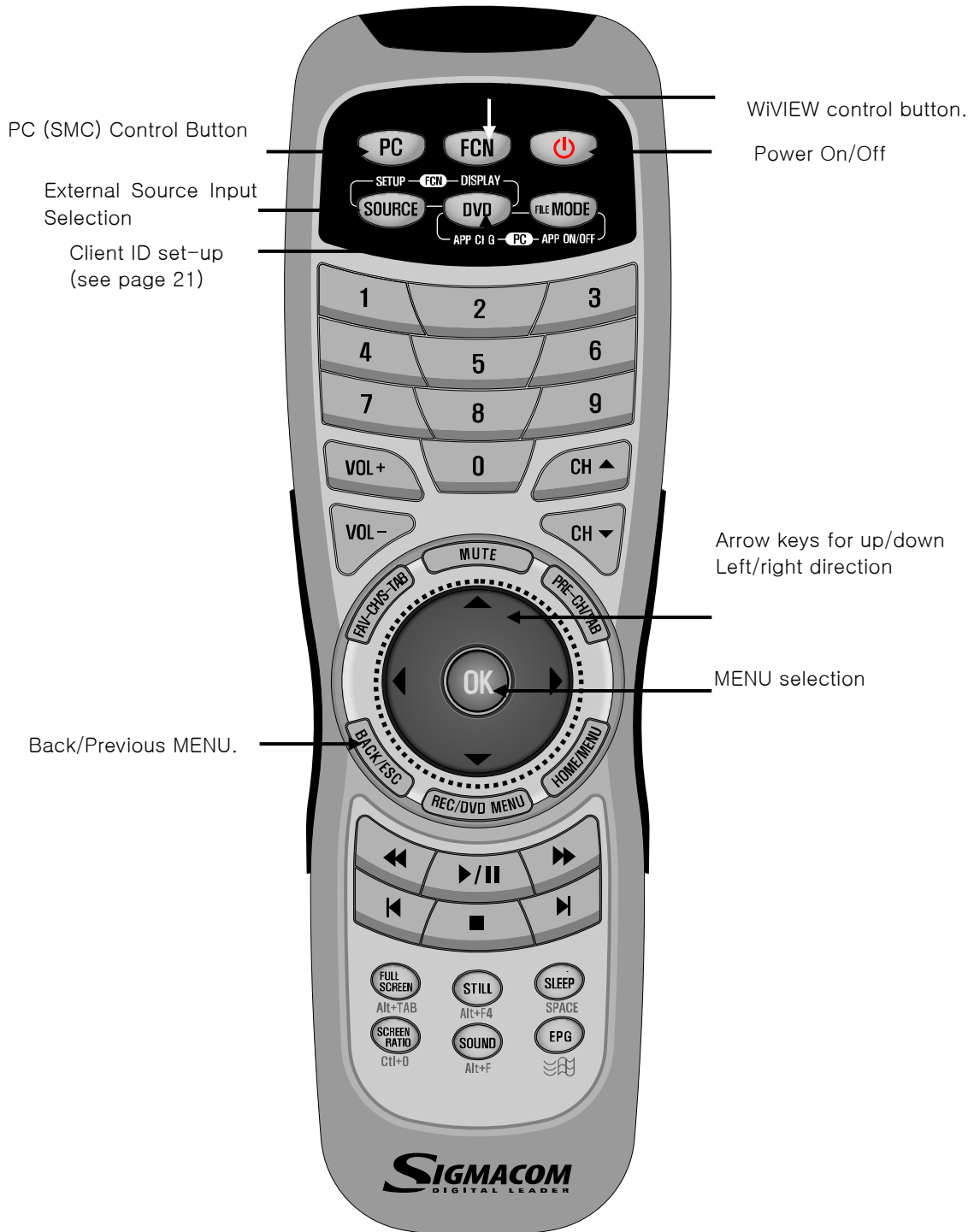

*** SMC (Sigma Multimedia Center) control**

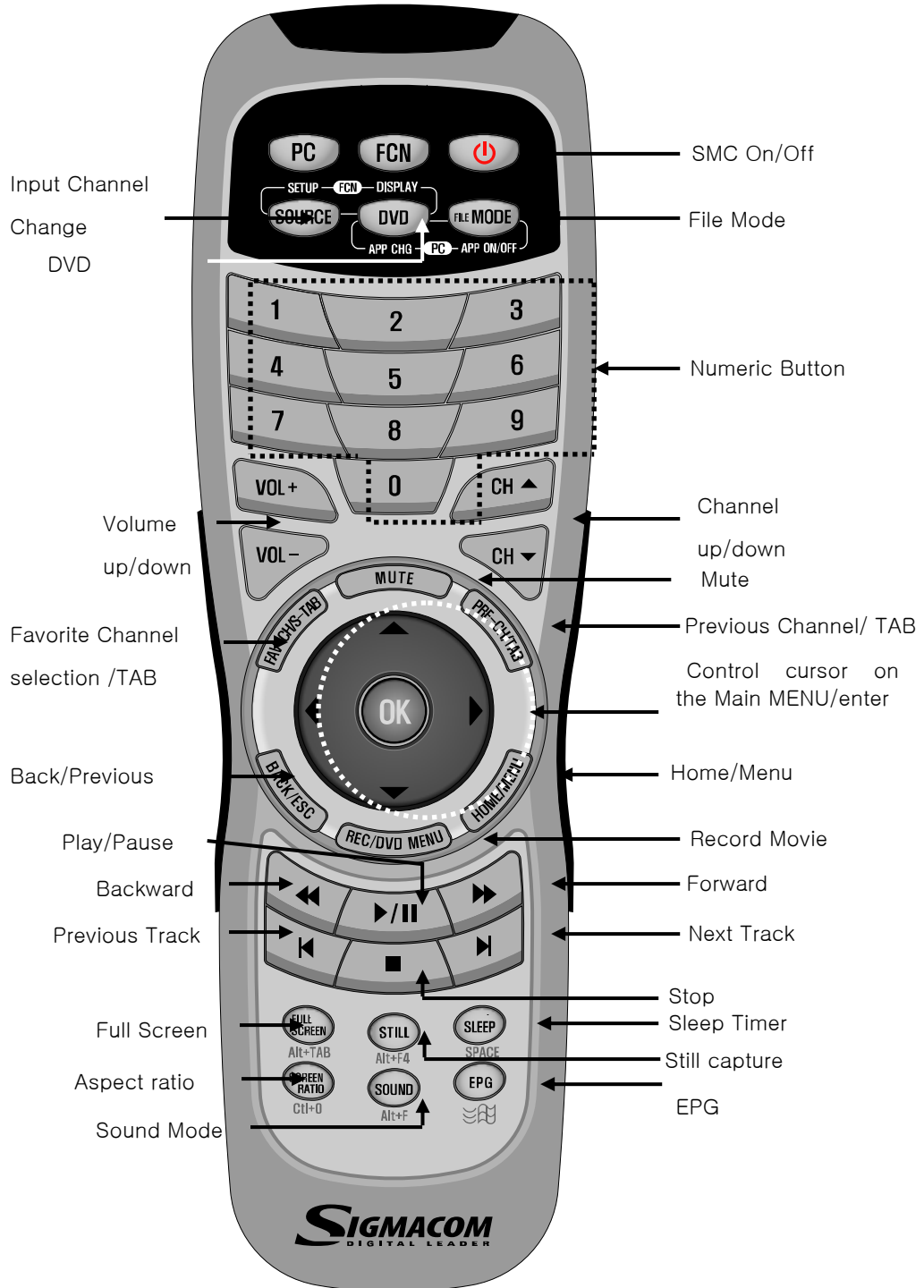

*** Inserting Batteries in the Remote control**



<Open the cover>



<Insert batteries >

1. Open the battery cover.(see the above figure)
2. Insert two AAA-size batteries (1.5V) into the battery compartment by matching + and –
3. Close the cover and push the latch back to lock the cover.

Placing Wi-VIEW on the stand

The figure below is to place the Wi-VIEW in standing position.



1. Put the Wi-VIEW into the holder.
2. Fix the position by matching two wholes on the bottom.

Installation

Connecting the Wi-VIEW

You can connect the Wi-VIEW to external devices such as VCR, DVD and game console.

* Connecting WMT-1000I diagram

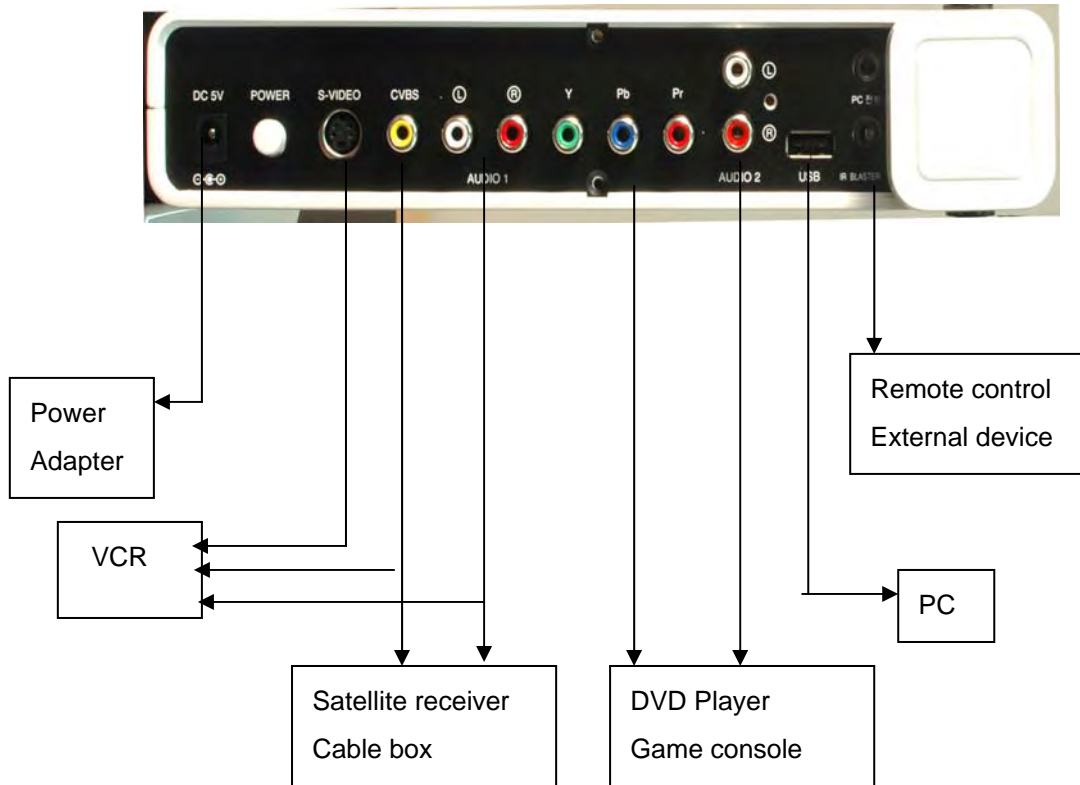

* Connecting WMT-1000O diagram

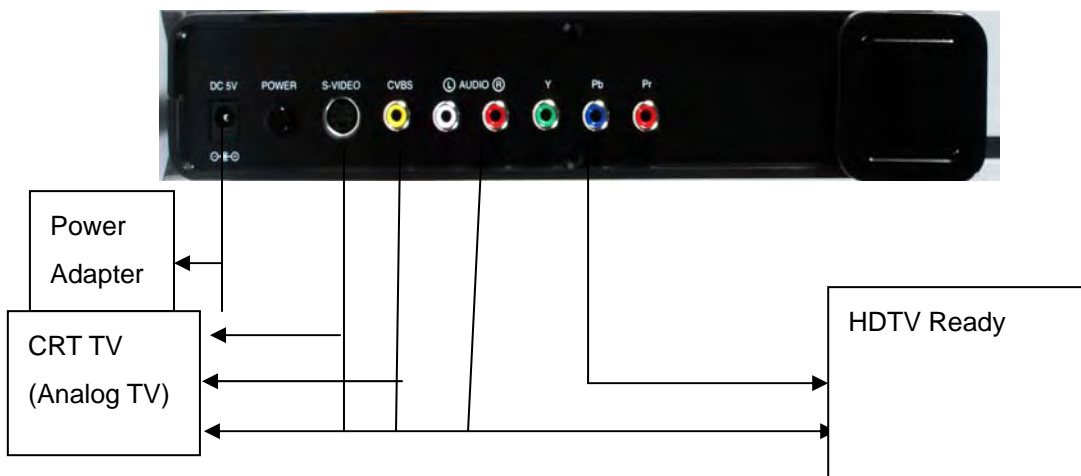

Connecting Server(Input)

◆ Connecting to Satellite receiver or cable TV receiver

. Video connection

You should connect Video out (composite/Yellow) of a satellite receiver or cable TV receiver to Video In (CVBS port) of the Wi-VIEW with the composite cable. (Yellow).

. Audio connection

You should connect Audio out (composite, White/Red) of a satellite receiver or cable TV receiver to Audio In(Audio 1,White/Red) of the Wi-VIEW with the composite cable(White/Red).

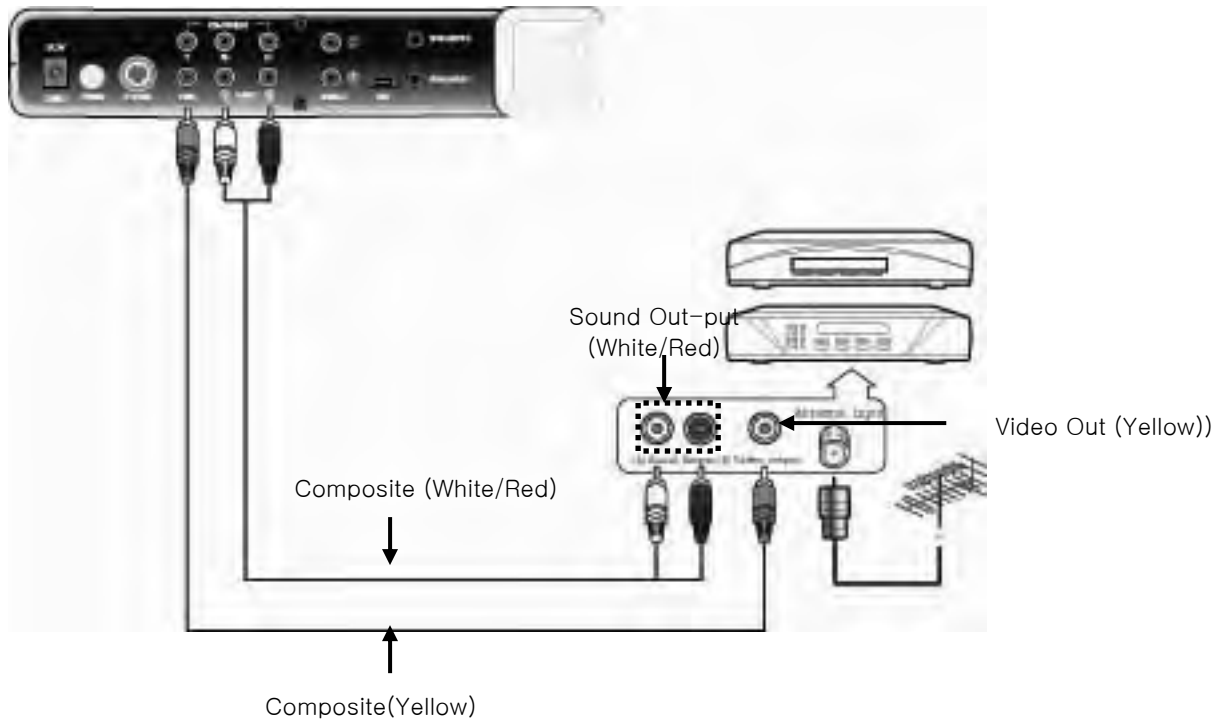

◆ Connecting VCR

. Video connection

1. You should connect Video out (Yellow) of a VCR to Video In (CVBS) of the Wi-VIEW with the composite cable (Yellow).
2. For S-VIDEO connection, you should connect S-VIEO out of a VCR to Video In (S-VIDEO) of the Wi-VIEW with the S-VIDEO cable.

. Audio connection

You should connect Audio out (White/Red) of a Satellite receiver or cable TV receiver to Audio In (Audio 1, White/Red) of the Wi-VIEW with the composite cable(White/Red).

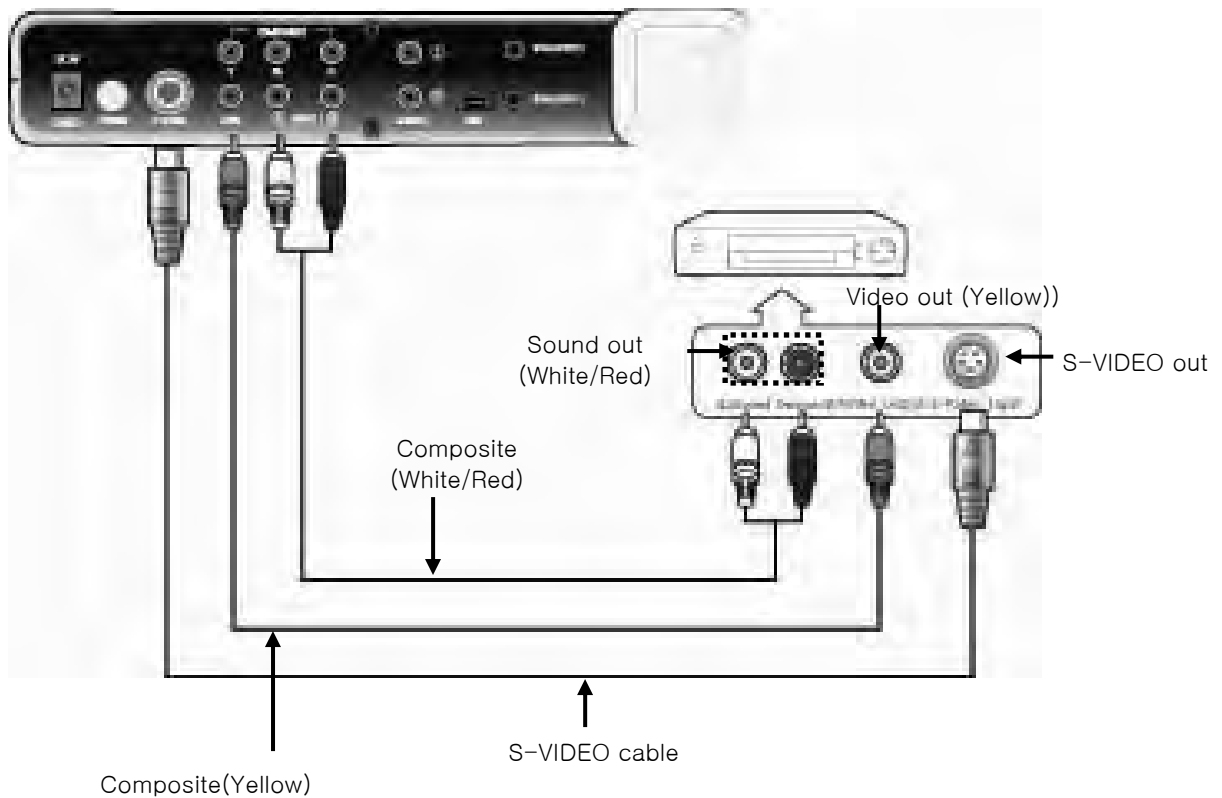

Note

. You should select a connection from S-VIDEO or Composite.

◆ **Connecting DVD Player & Game console**

1. Video connection

You should connect Component In (YPbPr) of the WI-VIEW to Component out of a DVD player or Game console with the component cable(R/G/B).

2. Audio connection

You should connect Composite In(White/Red) of the Wi-VIEW to Composite out of a DVD player or Game console with the composite cable.

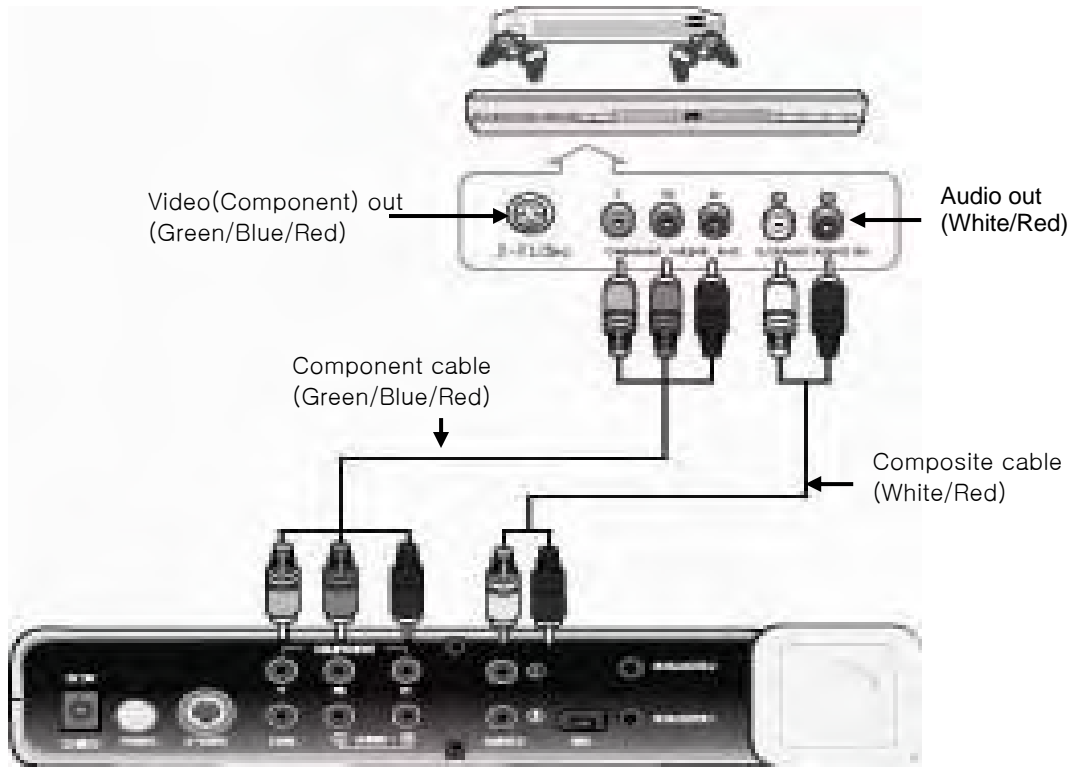

◆ **Using the remote control of an external video device**

. When using with PCs

You should connect the USB port of PC to the Wi-VIEW(server) with the USB cable.

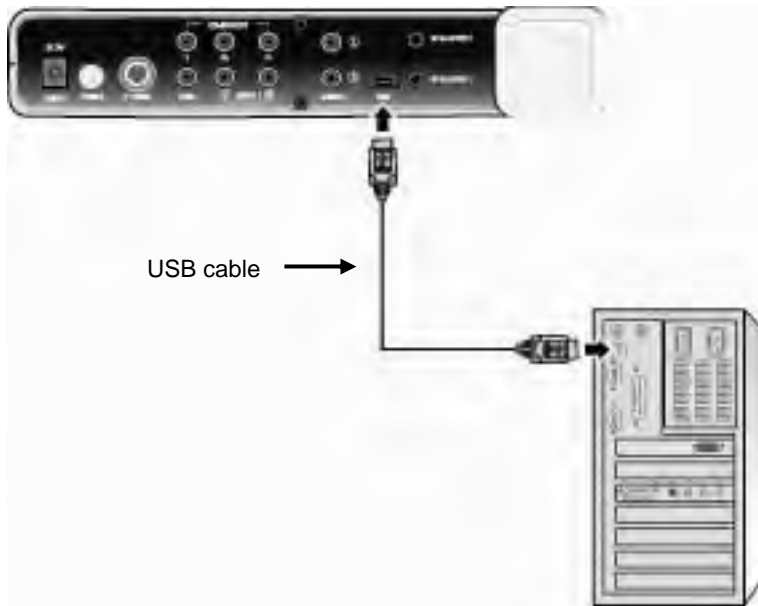

. When using with external video devices

1. Connect IR blaster as shown below.
2. Remove the sticker of IR blaster cable and attach it to the remote control receiver of external video device.

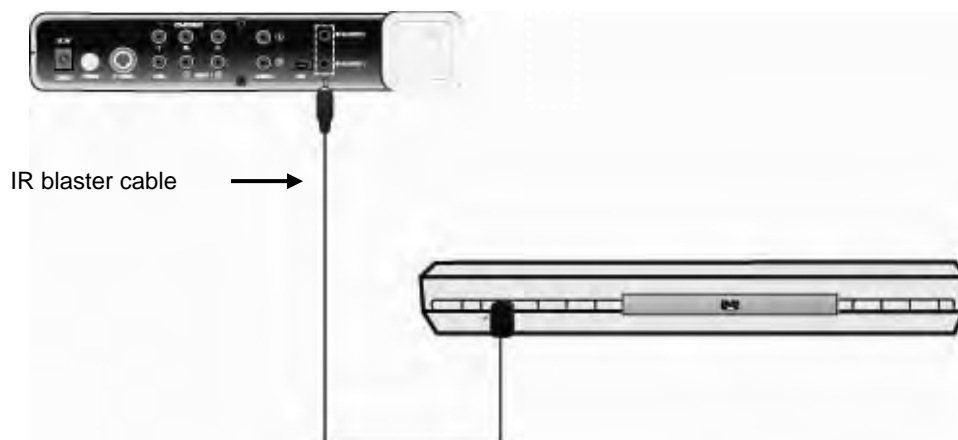

Connecting Client(output)

◆ Connecting analog TV

. Video connection

You should connect Composite (CVBS) or S-Video of the WIVIEW to an available input of a TV set with an appropriate cable.

. Audio connection

You should connect Audio out of the WIVIEW to Audio In(White/Red) with the composite cable.

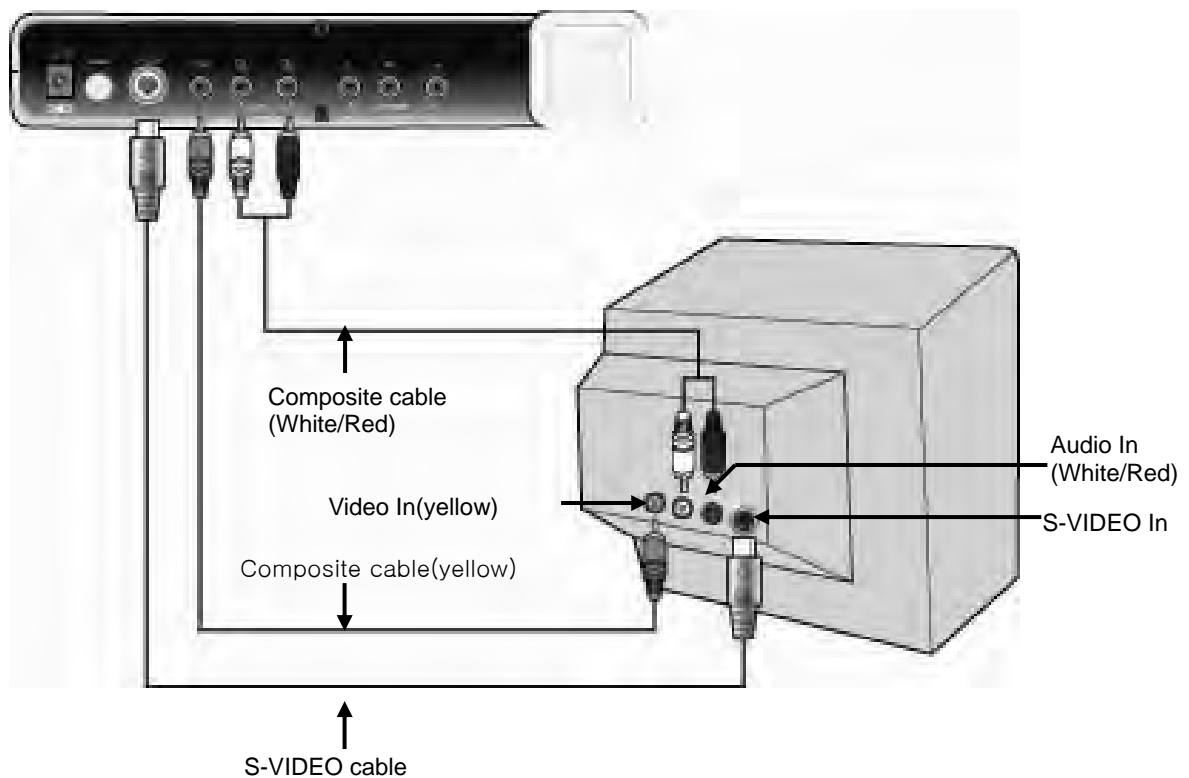

Note)

You should select one connection only from S-Video or composite.

◆ **Connecting HDTV Ready**

1. Use the composite connection with WIVIEW and HDTV ready TV set.
2. Use the composite cable(white/red) for audio connections.

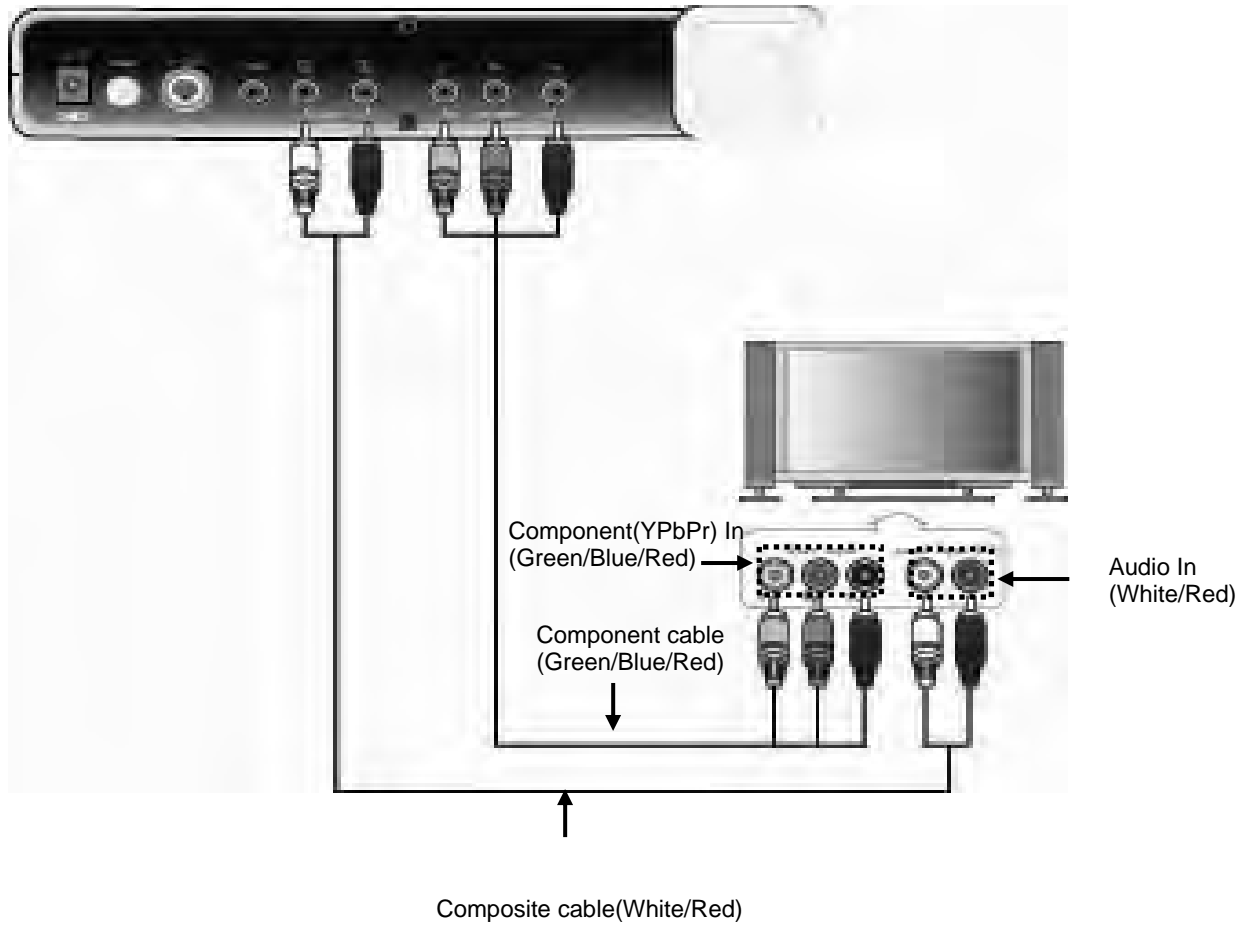

Basic functions

Using the remote control on the menu

◆ Button descriptions

- . **SOURCE [figure]**: Used for calling or quitting the menu screen.
- . **BACK/ESC [figure]**: Used for going back to the previous step.
- . **Up/down [figure]** : Used for going up and down from the menu screen.
- . **Left/right [figure]**: Used for going left or right from the menu screen.
- . **Enter[figure]** : Used for going to sub menu or changing setup values.

*** Using remote control for Menu setup

- . **Main menu**: This is the Root menu and can be moved by up/down buttons.
- . **Sub menu**: This is the Sub menu that branches from the main menu and can be moved by up/down buttons. You can also use left/right buttons when changing setup values.

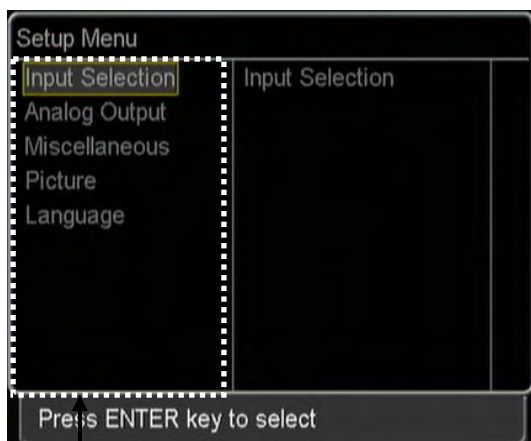

Select a category then press ENTER to go to the sub menu

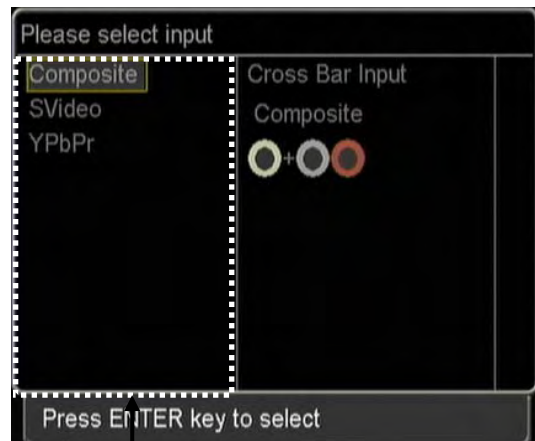

Select an item that you want to change then press ENTER to select.

Starting the WiVIEW

When pressing the power on the remote control, the following ID information is displayed



Note

- . To change 'Input' ID, refer to ~ page.
- . Keep 3M away from the server and client system.

Server (input) setup

This function is to set connections with the server and external video devices. (DVD player or PC)

1. Press SOURCE [] on the remote control, then Setup Menu appears.
2. Select "Input Selection"

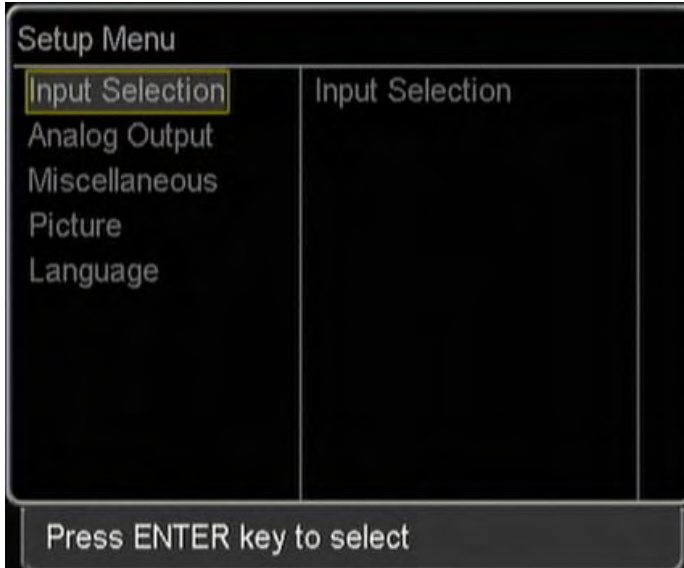

3. Select an available input, then press [].

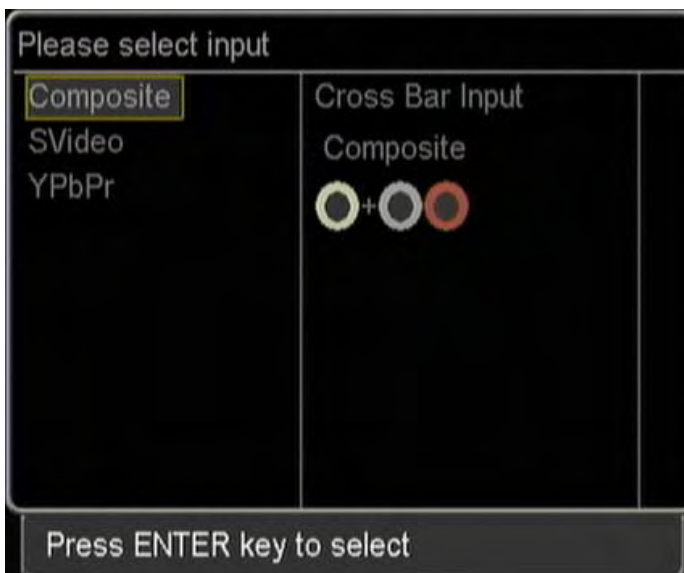

Client (Output) setup

This function is to set connections with the client and display devices (TV or monitor).

1. Press "SOURCE" [] on the remote control, then "Setup Menu" appears.
2. Select "Analog Output"

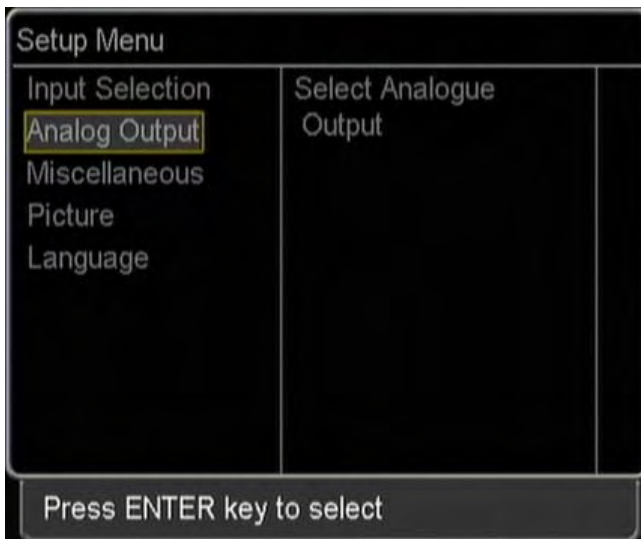

3. Select an available input, then press [].

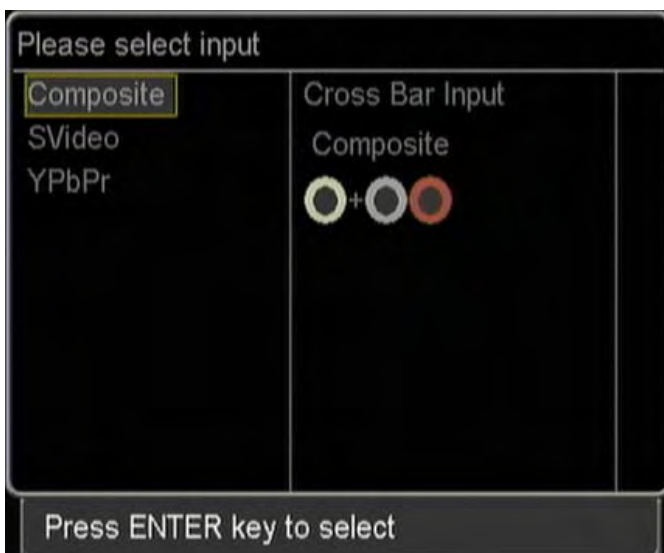

Quality control

This function is to adjust the image quality on the TV screen.

1. Press 'SOURCE' [SOURCE] then "Setup Menu" appears.
2. Select "Picture"

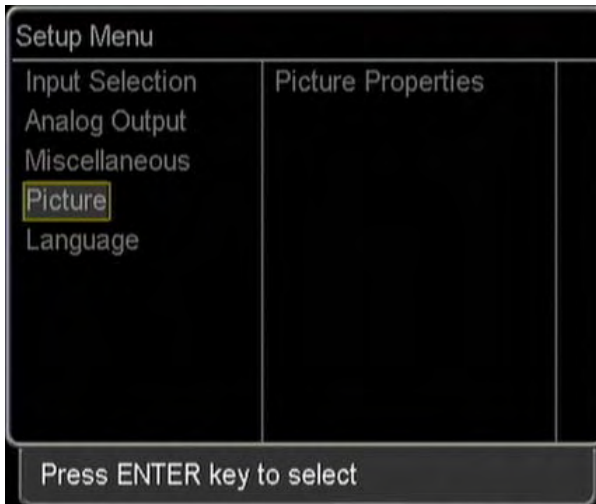

3. Select one of the Contrast, Luminance, Saturation, Sharpness and Hue.

4. Press [OK] then adjust the color value using [◀/▶].

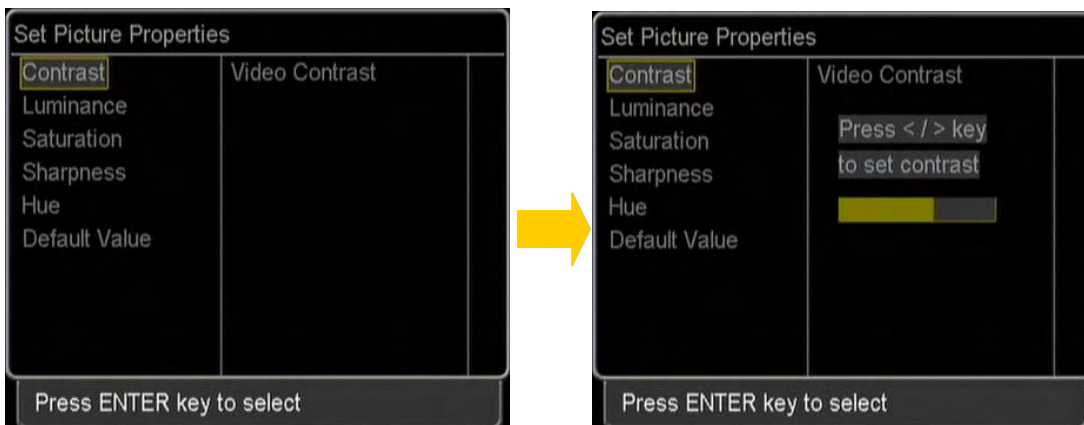

Note

Above pictures are the examples when selecting [Contrast].

OSD language

This function is to select OSD menu language.

1. Press 'SOURCE' [- 2. Select "Language"

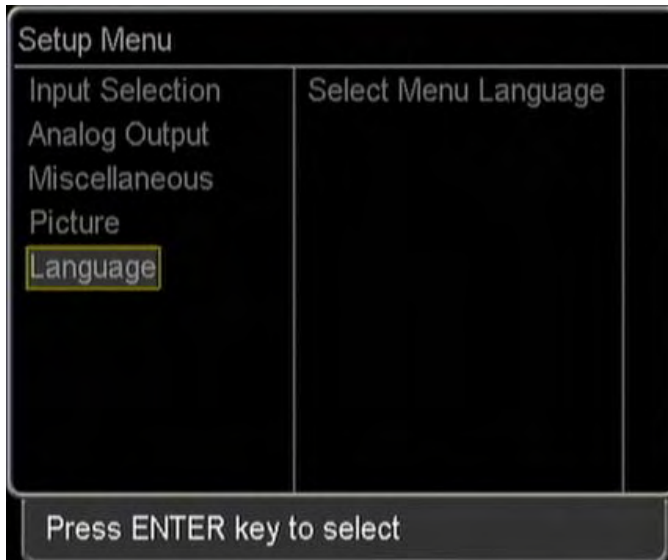

3. Select OSD menu language, then OK [



Miscellaneous

This function is to show basic information on firmware version, server ID, EEPROM, screen saver, and network status.

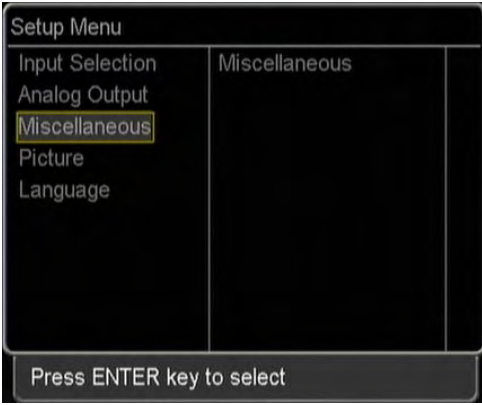

Setup Menu

Input Selection	Miscellaneous
Analog Output	
Miscellaneous	
Picture	
Language	

Press ENTER key to select

1. Press  on the remote control.
2. 'Setup Menu' appears then select **[Miscellaneous]**

. Checking Wi-VIEW information

Information on firmware versions of MPEG Decoder, Wireless Chip, Mpeg Encoder, and Wireless Chip can be checked as below.

1. Select "Firmware Version"

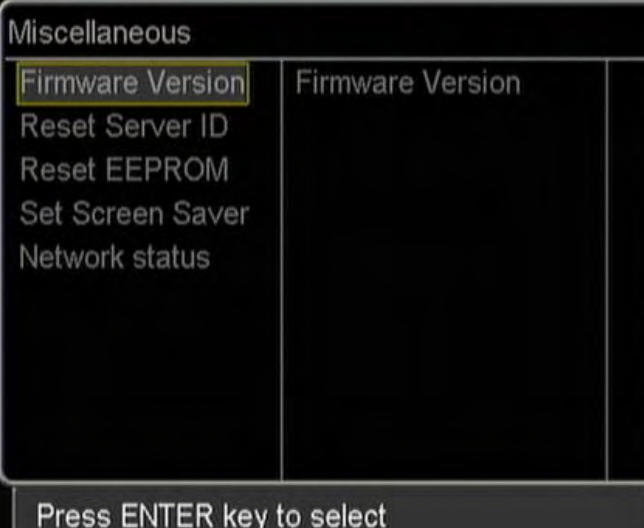

Miscellaneous

Firmware Version	Firmware Version
Reset Server ID	
Reset EEPROM	
Set Screen Saver	
Network status	

Press ENTER key to select

2. By pressing OK , firmware versions for server and client can be checked.



Notice

ESS	MPEG decoder version for server
Xcode	MPEG encoder version for client
M2Svr	Wireless Chip version for server
M2Cit	Wireless Chip version for client

. Setting Screen Saver

This function is to show a screen saver on the black screen when external video devices are not connected. This is useful when you do not know whether the server and client are activated or not.

1. Select "Set Screen Saver" then press [].

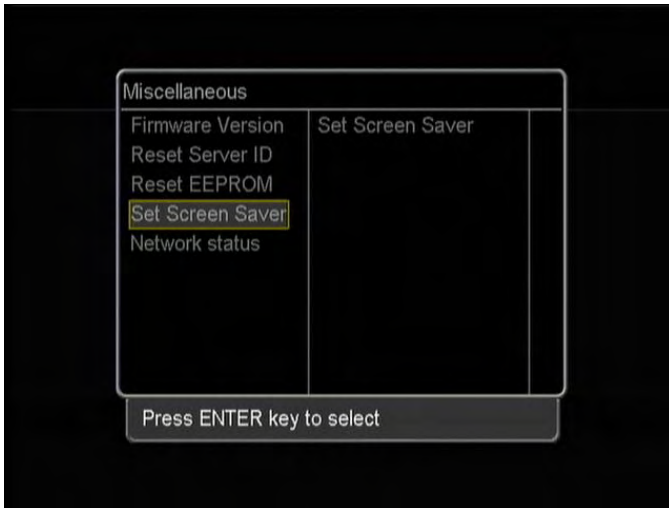

2. Select "Enable" then press [].

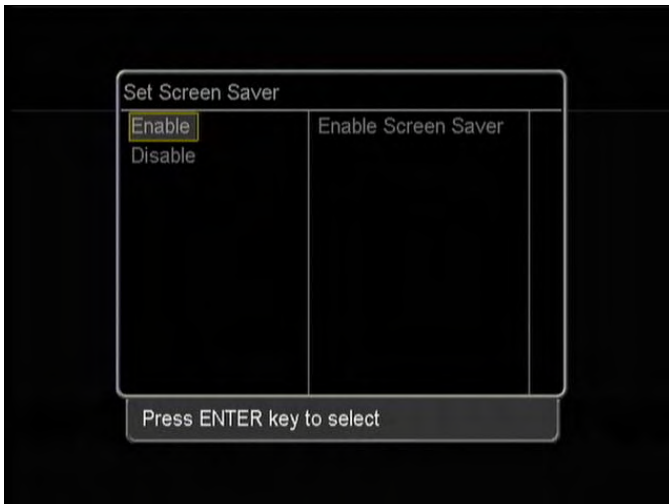

. Checking the network status

This shows Client RSSI, Server RSSI, RF channel, RF frequency and stream bit rate.

1. Select "Network Status."

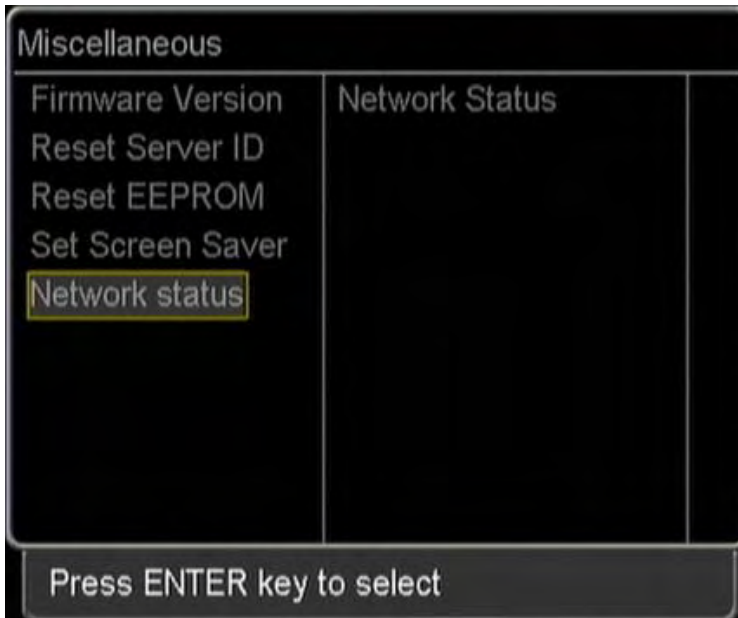

2. Press [] then appropriate information appears.

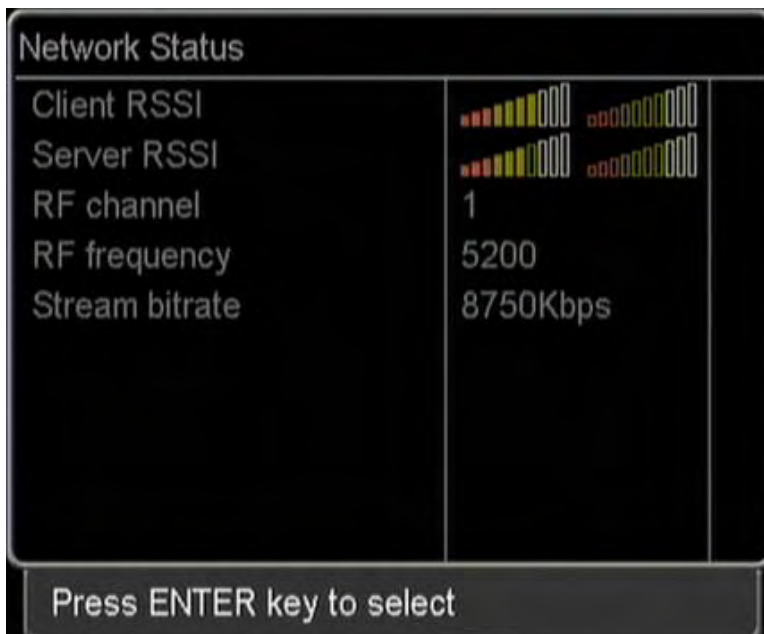

Chapter 4. Using SMC(Sigma Multimedia Center)

SMC is an entertainment tool to be used to watch DVD/TV, listen to music, and view the digital photos. This can be a unified easy control panel for all complicated interface buttons.

◆ Main menu screen



- **Each menu function**

- **Main menu**

. Analog TV[, Digital TV[] / Radio[]

These functions are used to watch TV and listen to Radio.

(SIGMA TV card should be installed in your system to enable TV functions.)

. Movie[] / Music[] / Picture[]

These functions are used to watch movies, listen to music and view digital photos.

.DVD []

This function is used to play DVD titles.

. Common[, TV Config[, File Config[, Multimedia Config[]

These functions are used to set configuration for TV, file play or multimedia control.

. Go to SIGMACOM home page[]

This function is to go to SIGMACOM web site.

- **Windows menu**

. Help[]: shows program information on SMC.

. Minimize[]: iconizes SMC program window.

. Restore Previous Size[]: turns to full screen.

. Close[]: quits SMC program.

■ Search menu

.Play/Pause[] : plays or pauses video(TV, video, DVD) or music files.

.Stop[] : stops video(TV, video, DVD) or music files.

.Record[] : records a watching scene as a file.

(This function is possible when TV menu has been selected.)

.Rewind/Fast Forward[]: go backward or forward a video on play.

.Previous file/Next file[] : go previous or next track or title.

.Previous channel/next channel[]: go previous or next channel on TV or radio.

.Volume up /down[] : volume up or down

.Sound off[] : makes MUTE

.Still Capture[] : captures a scene on the screen as a still image

(This function is enabled when TV menu has been selected.)

.Reservation[] : makes a reservation to turn TV on or off





.Quick TV[] : moves to TV mode quickly.

. Quick VIDEO[]: moves to VIDEO mode quickly.

. Quick DVD[]: moves to DVD mode quickly.

◆ **Watching PC contents(video, music, picture) thru WiVIEW**

This function is to view video files as album or file more conveniently. In using media (video, music, picture)menu, files should be registered in book mark.

1. Select a media (video  music  and picture  to be used in the main menu.
2. When pressing bookmark , the following window appears.

(Below is an example when registering music files.)

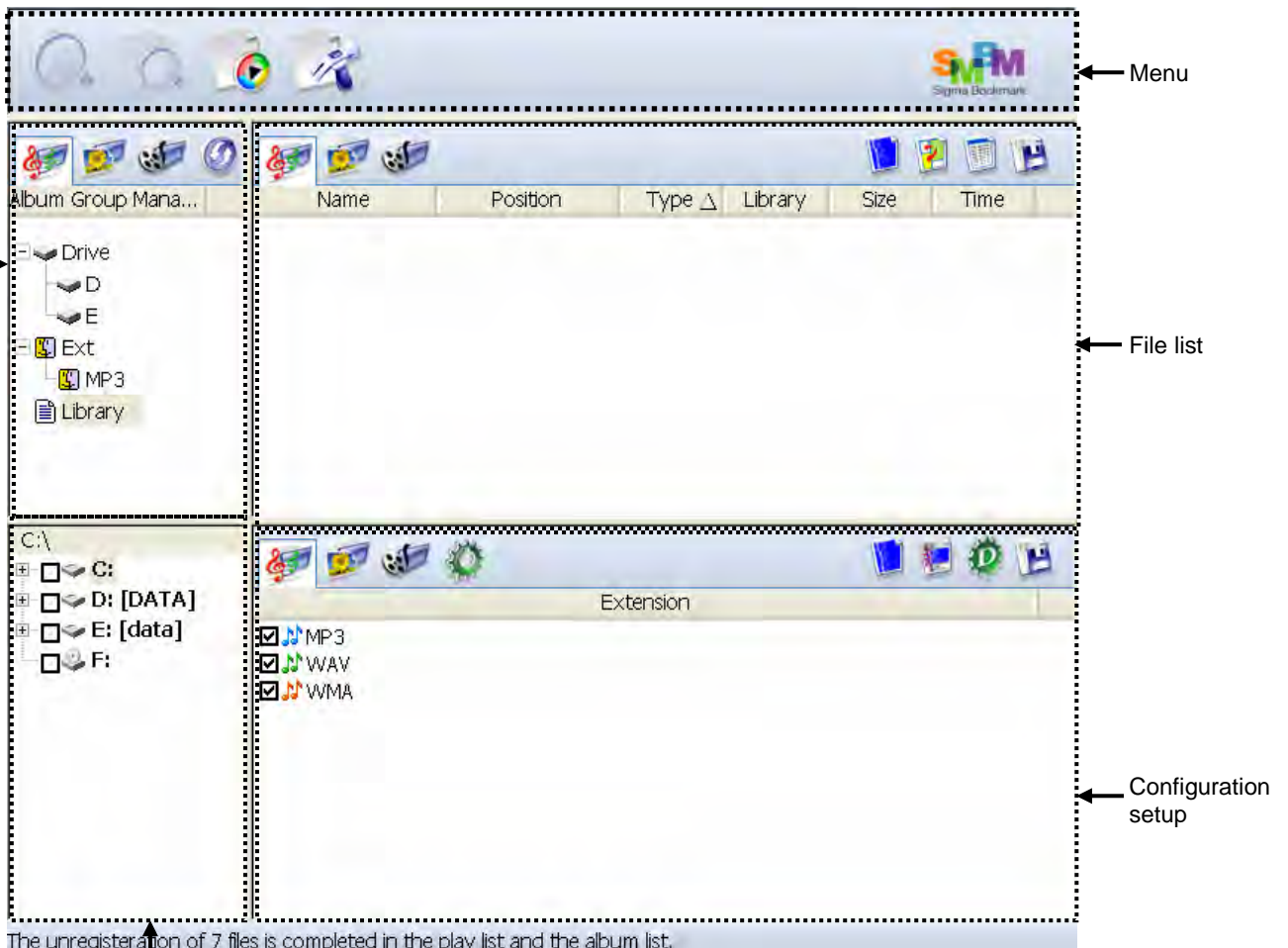



Album list

File search folder

Note
If a file has not been registered, bookmark(SMBM) window appears when selecting a media menu.

■ **Menu**

.Search files[] : scans media files(video, music, picture)

.Mode change[] : switches to Search mode or Edit mode

.Show the playlist[] : shows media file list(video, music, picture)

.Configuration[] : shows configuration to set SMBM

■ **Album list**

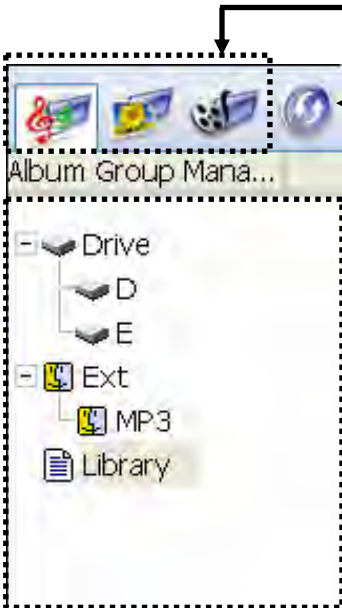

Used to select media files(video, music, picture)

Used to add, delete or change libraries

Shows scanned media contents(video, music, picture)

The screenshot shows a window titled "Album Group Mana...". At the top, there are four icons: a music note, a video camera, a film strip, and a globe. Below the icons is a tree view showing a folder structure: "Drive" (expanded) containing "D" and "E"; "Ext" (expanded) containing "MP3" and "Library".

■ **File search folder**

Used to set drive or folder for searching media files (video, music, picture)

■ **File list**

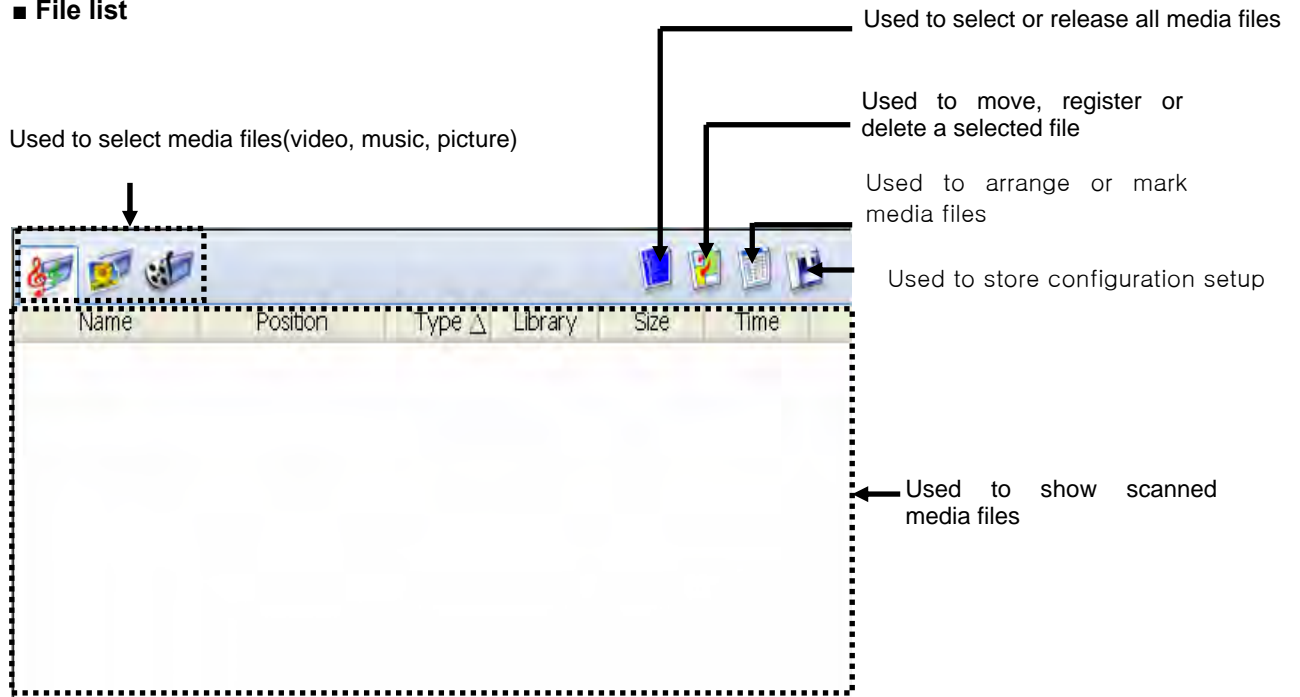

■ **Configuration setup**

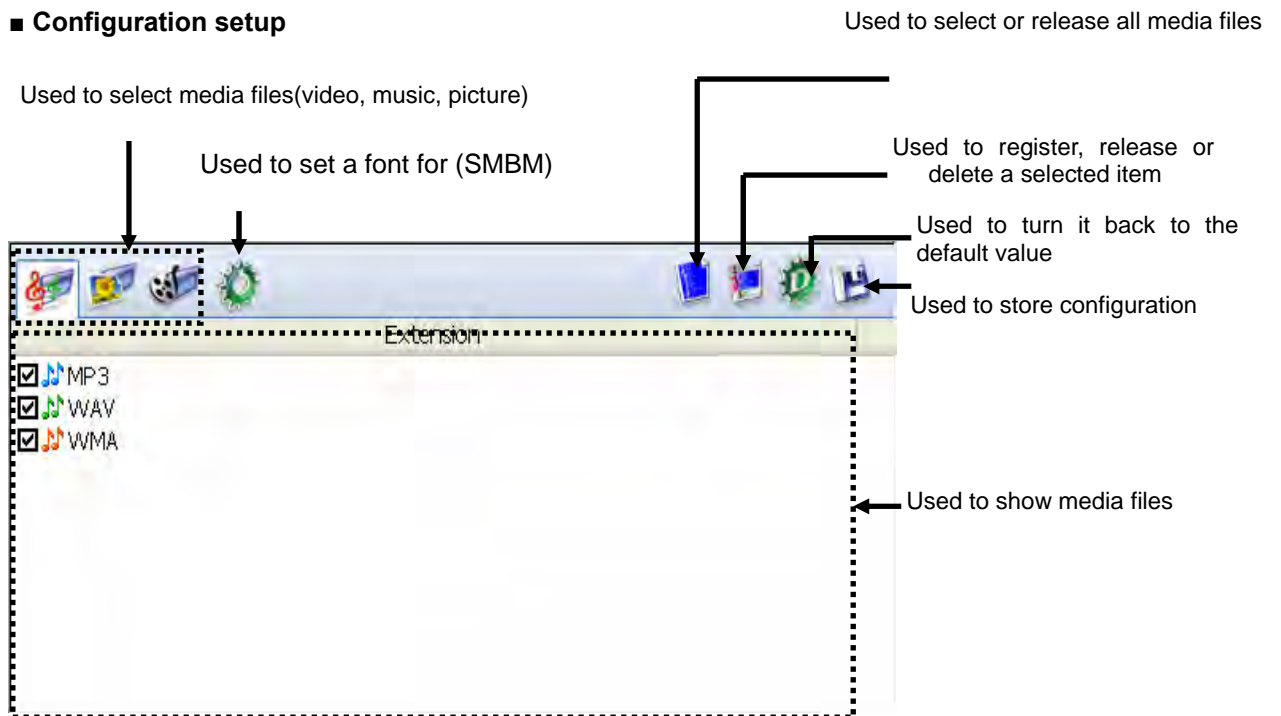

Note If there is a scanned file, it turns to play list when selecting []'

■ Scanning files

1. Select a folder to scan in the folder window.
2. When pressing 'File search' [🔍], scanned files appear in the file list.
3. After selecting a file to register,, press 'file save' [💾].

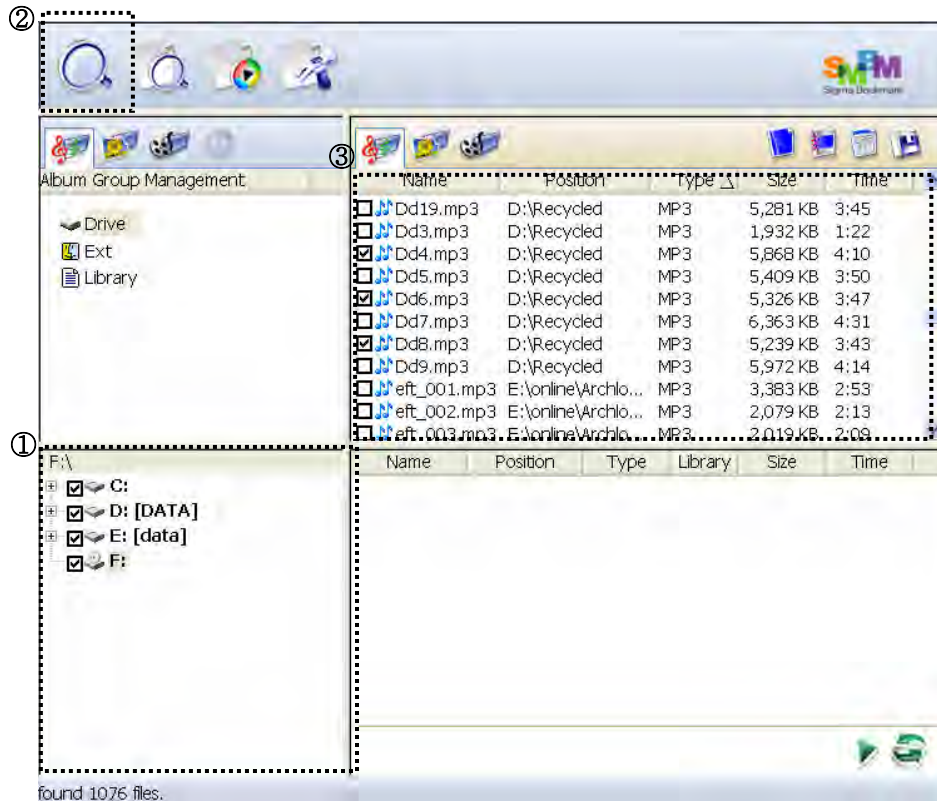

4. A message that album setting has been changed appears then press OK.

Note

In 'Search mode', the title color is changed to orange.

5. Select an item(drive, extension, library)in the album list then the following message appears.Click YES.

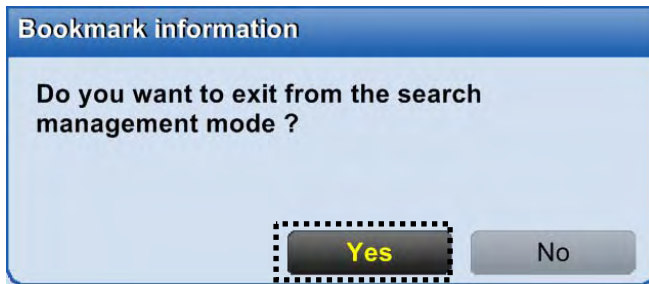

6. It will changed from Search mode to Edit mode and Drive, scanned file extensions, and libraries will be created at the same time.

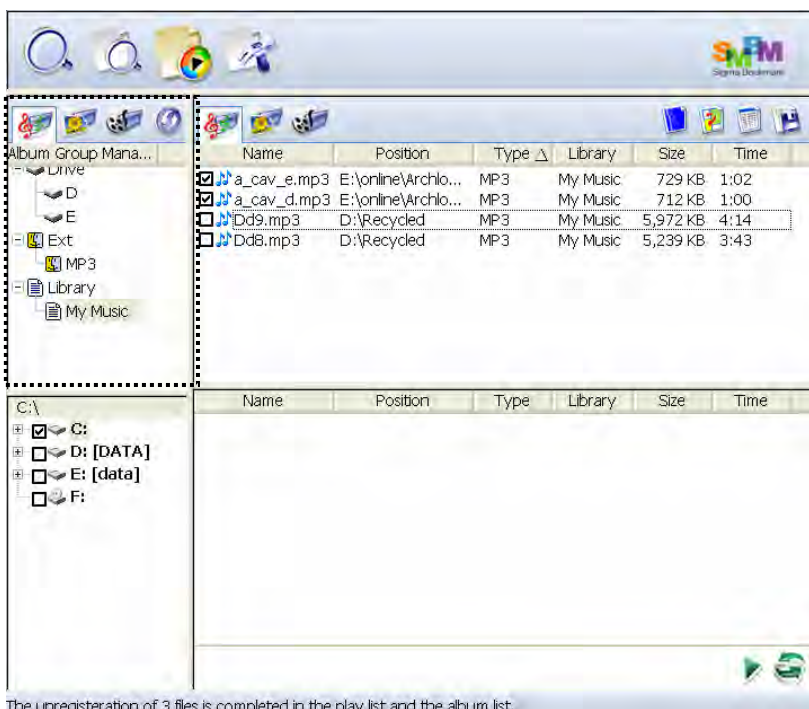

Check-point

A wanted file format can be searched only in the book mark. It will turn to a window that the file format can be selected by clicking "Configuration setup". Save by clicking "file save" after selecting a file format.

■ **Registering files in the list**

1. Select a file to register in the file list then it will be registered in “configuration setup and play list” automatically.
2. Click “file save” to save in the “file list”.

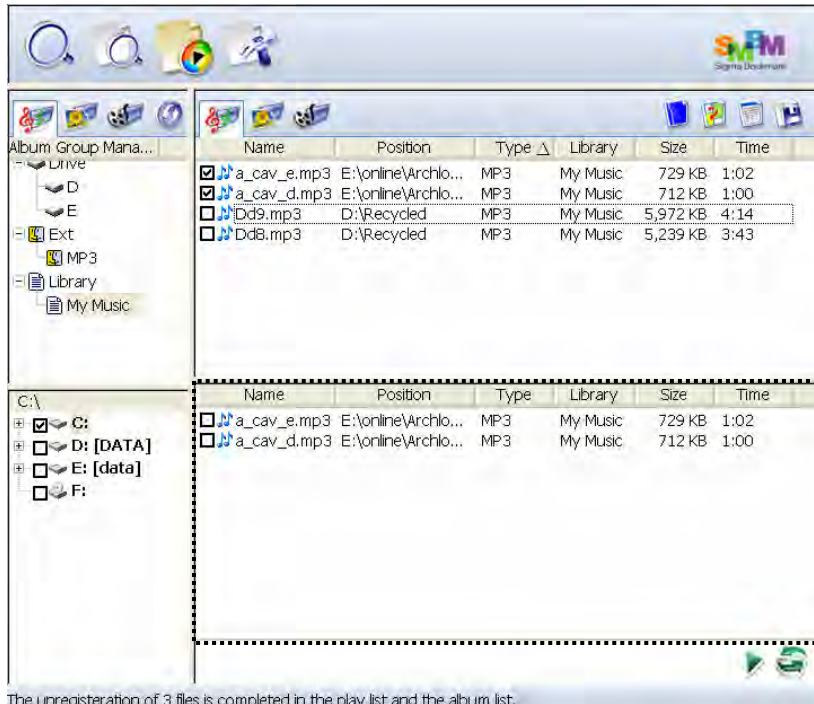

The unregistration of 3 files is completed in the play list and the album list.

3. Saved files can be checked by clicking 'Music[]':



◆ SMC function



1) TV function (analog TV/digital TV)

This function is used with a TV capture card. If a TV tuner card is not installed in your system, you can not use this function with SMC program.

● Running the TV program

1. Select 'TV[

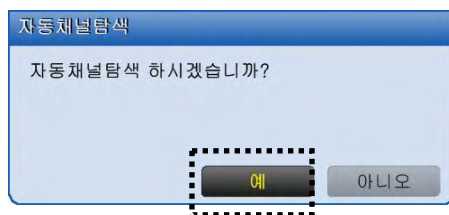
2. If this is the first time to run the SMC program, it will ask you for auto-scan as follows. Click YES to

proceed. (or by clicking 'Auto-scan[

3. If the channel scan is finished, the following screen appears.

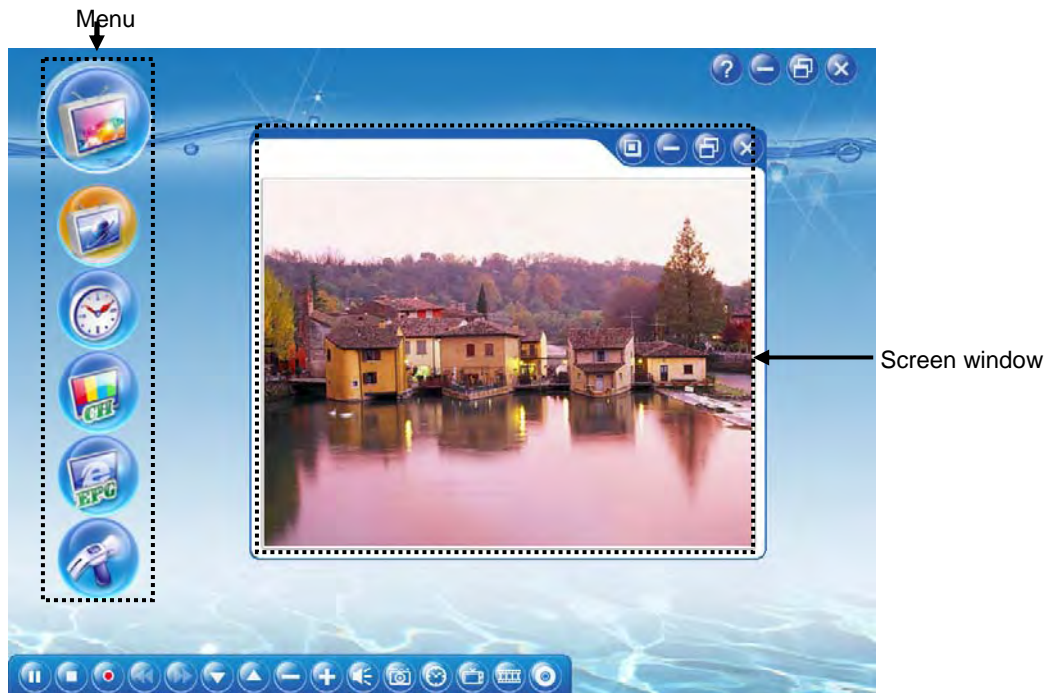

Note

If you can not see a TV show on the screen, make sure the antenna is connected correctly. Refer to page ~ for antenna connection.

. Menu



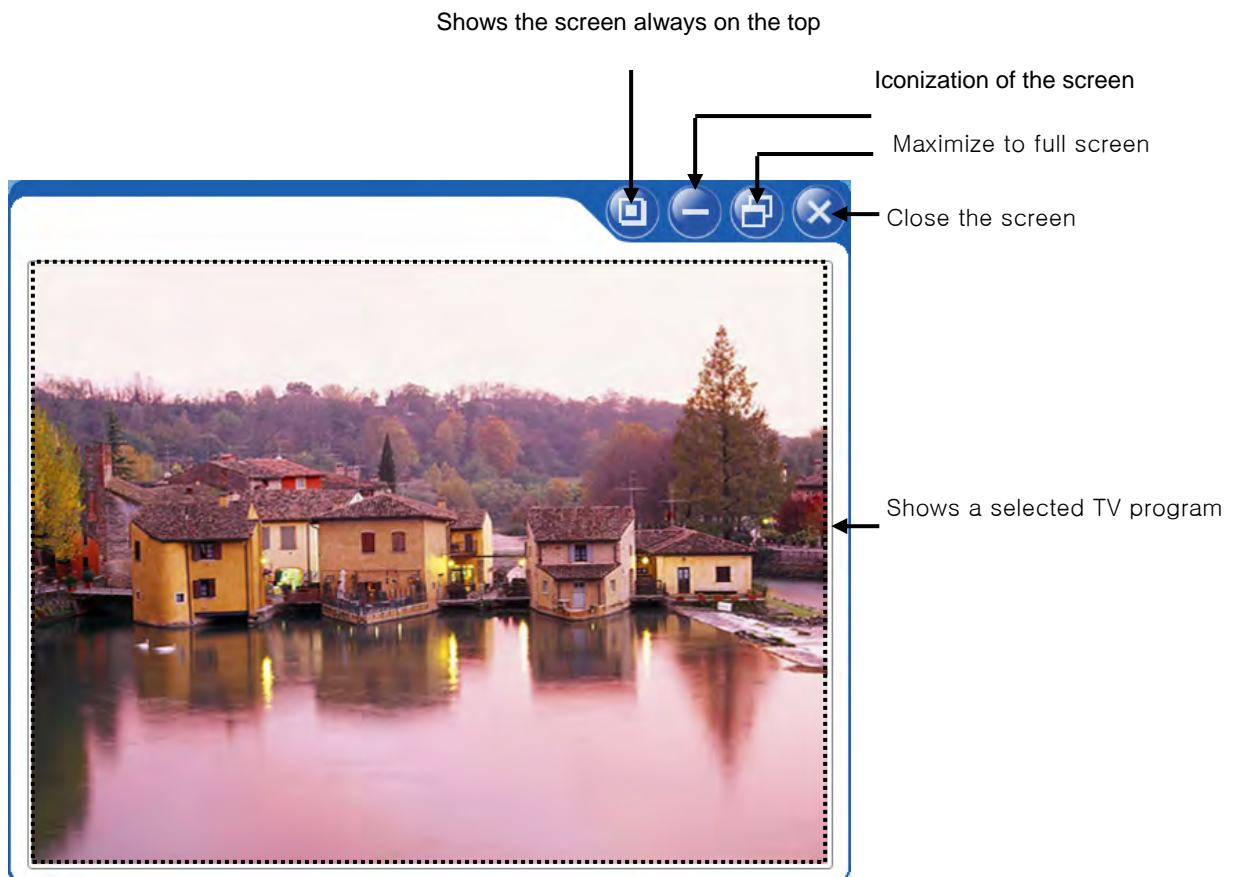

. Screen window



- **Setting antenna**

This is used to select a TV antenna connection.

1. Select Options  in 'TV Config' .
2. Select 'Src&Dev' and TV antenna.
3. Select an available antenna connection.

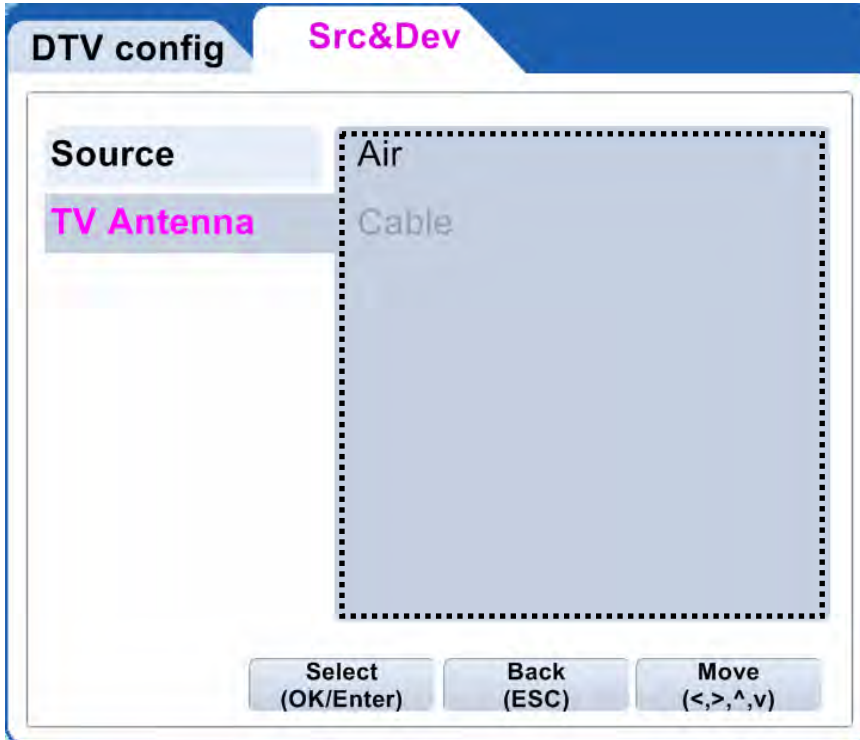

4. When moving back to the previous screen by pressing ESC or BACK/ESC, the configuration is saved automatically.

5. Press Back  and select Live TV  to check the TV screen.

- **Setting TV channel**

This is used to search available TV channels from the over-the-air or cable and to set channel save/delete or favorite channels

Select 'auto-scan[

- **Registered channel(channel memory/delete)**

This shows scanned channel list and it also can be used to add or delete channels.

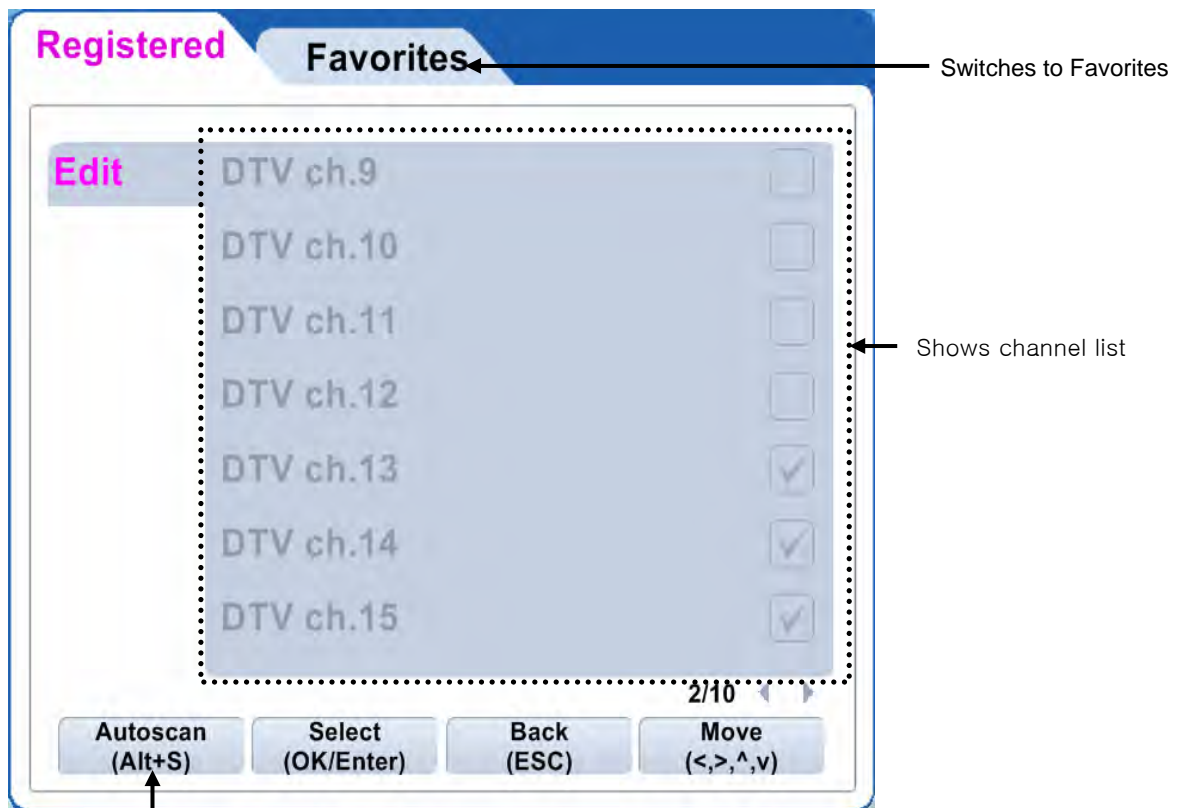

Scanned channels are marked in the check-box. []

■ Favorite channel

This is used to manage favorite TV channels only.

. Adding a favorite channel

- 1 Select Favorite channel' in 'Auto-scan[- 2. Select a favorite channel to be shown in the list then click "favorite channel add".

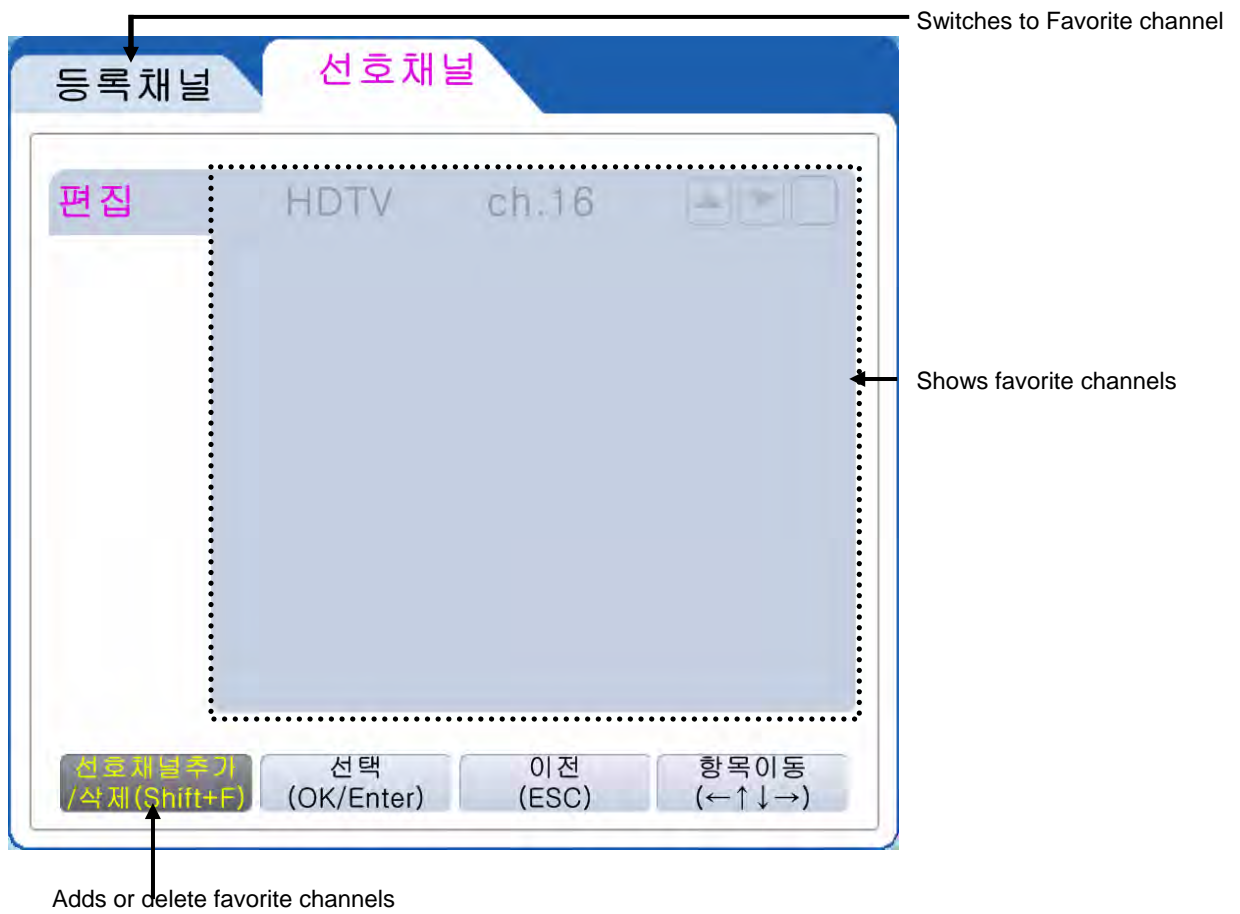

4. By pressing ESC on the keyboard or BACK/ESC on the remote control, the settings are saved.

- **EPG(Electronic Programming Guide)**

This function is a TV program guide provided by national TV broadcast service providers. It can be used to record a favorite TV show at a convenient time.

When selecting 'EPG[]', the following program guide window appears.

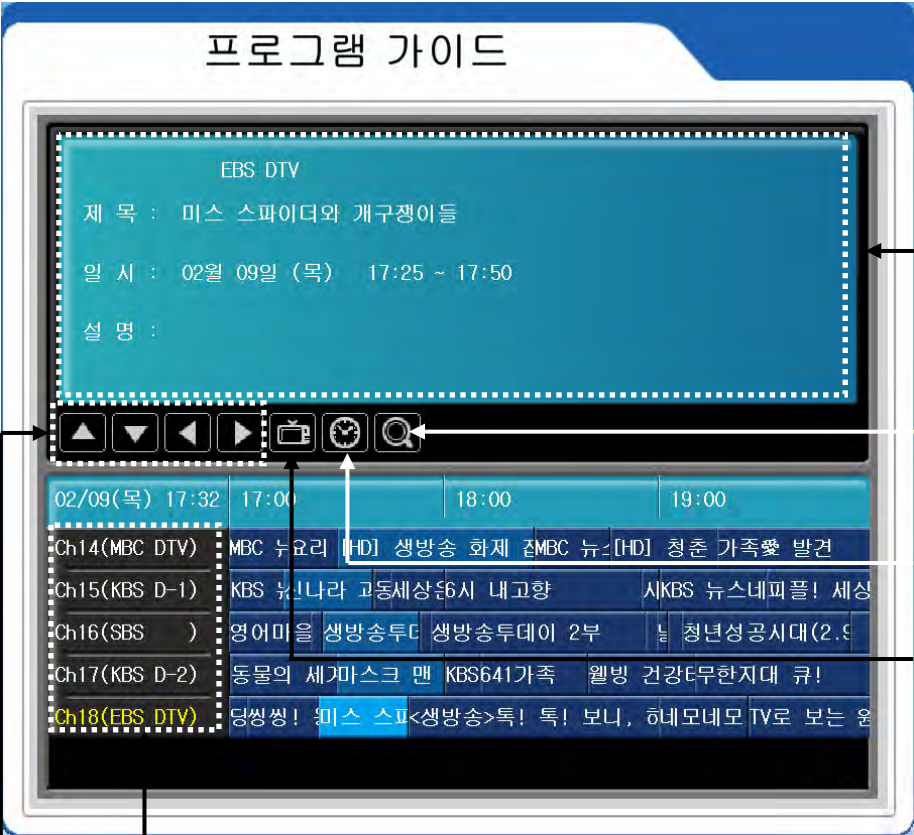

Shows program information

EPG search

Records the current program

Moves to the current selected program

Scanned channels

Moves the table up/down/left/right

. **Recording by pre-schedule**

1. Select a TV program to record in the EPG table.

Note

- . The current available channels are marked in sky-blue color.
- . One or more channels should be stored to run EPG.
- . This function is supported in DTV mode only and the screen should be activated.

- **Reservation**

This is used to record or quit a TV program by pre-schedule system.

Select 'Pre-schedule[

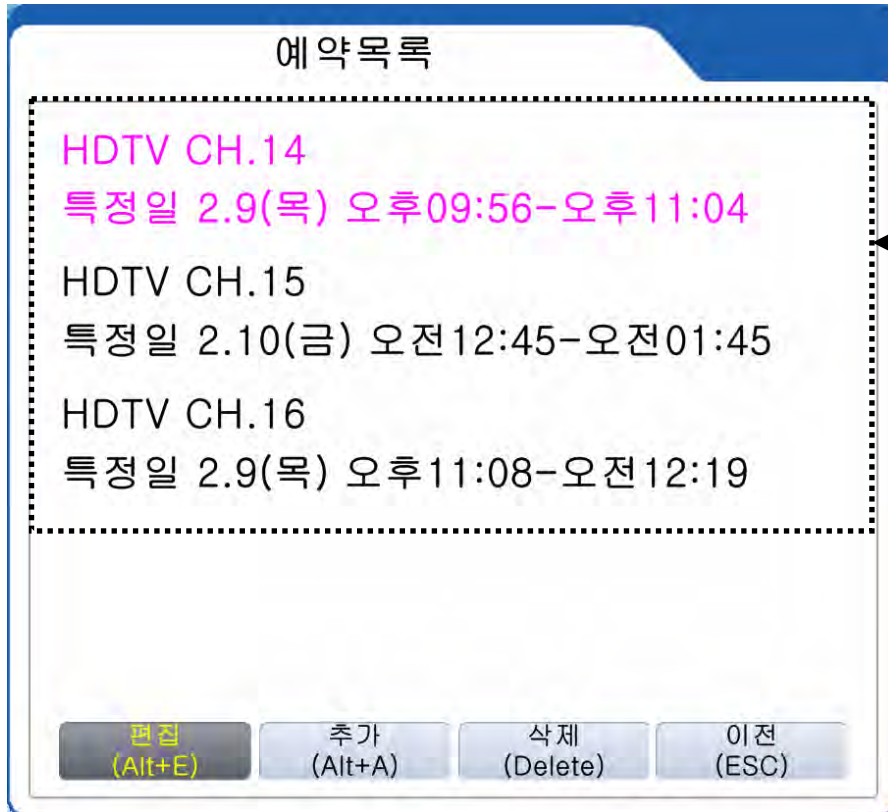

Shows program information to be pre-scheduled.

■ Adding Reservation list

This function is to reserve a TV program in advance daily, weekly or b-weekly.

Select 'Add reservation' [] then "Add Reservation" window appears.

(Following menu is an example for DTV mode. Note that analog TV mode may have a different menu.)

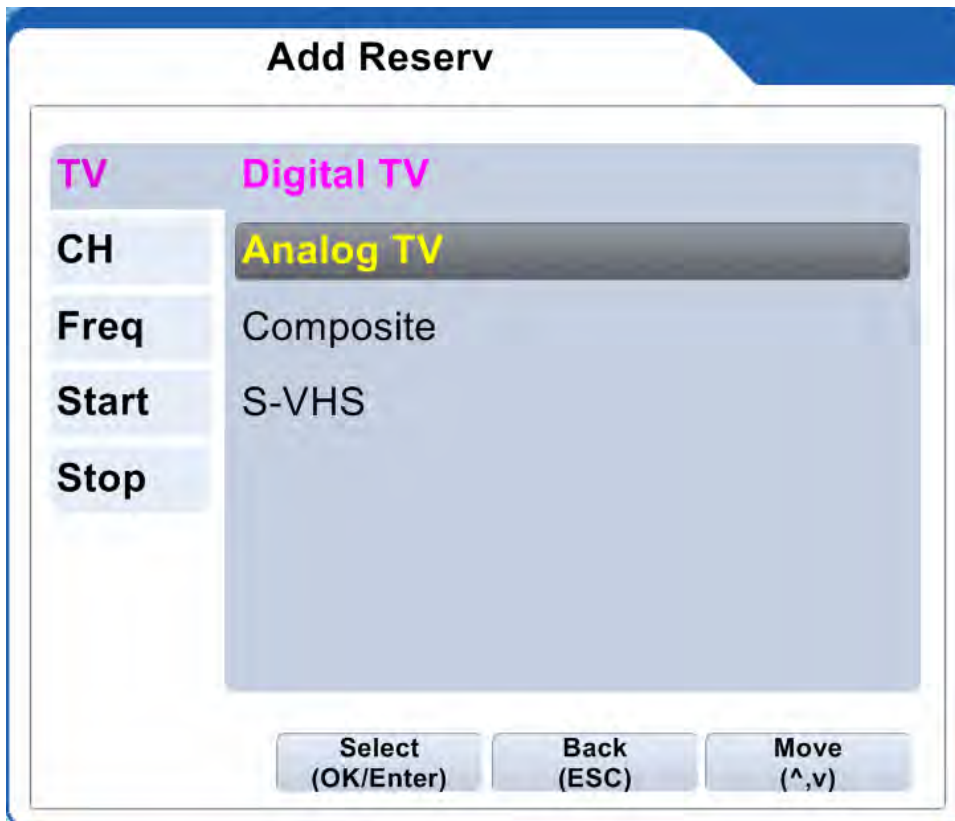

1. Set a channel to reserve (virtual channel), input mode, frequency, start and stop time.
2. Press 'Save' to store the configurations.

Note

Reservation can be easily set by EPG. Refer to page ~ for more information on EPG.

- **Multi-screen**

This function can be used in analog TV mode only. Available channels are shown in the multi-channel window in serial.

Select 'channel edit ' in the menu then the available channels are displayed as below.



. Watching one channel

Click a channel to view in full screen.

. Switching to window screen

Double-click a channel in the multi-screen window then it will turn to the windows screen.

Note
 Available channels should be registered to watch in the multi-screen. To register channels, refer page ~.

2) Music

This function is used to play music files (mp3/wav/wma) from HDD or CD-ROM Drive.

Note

Music files should be registered to use MUSIC function. Refer to page~.

1. Select 'Movie [

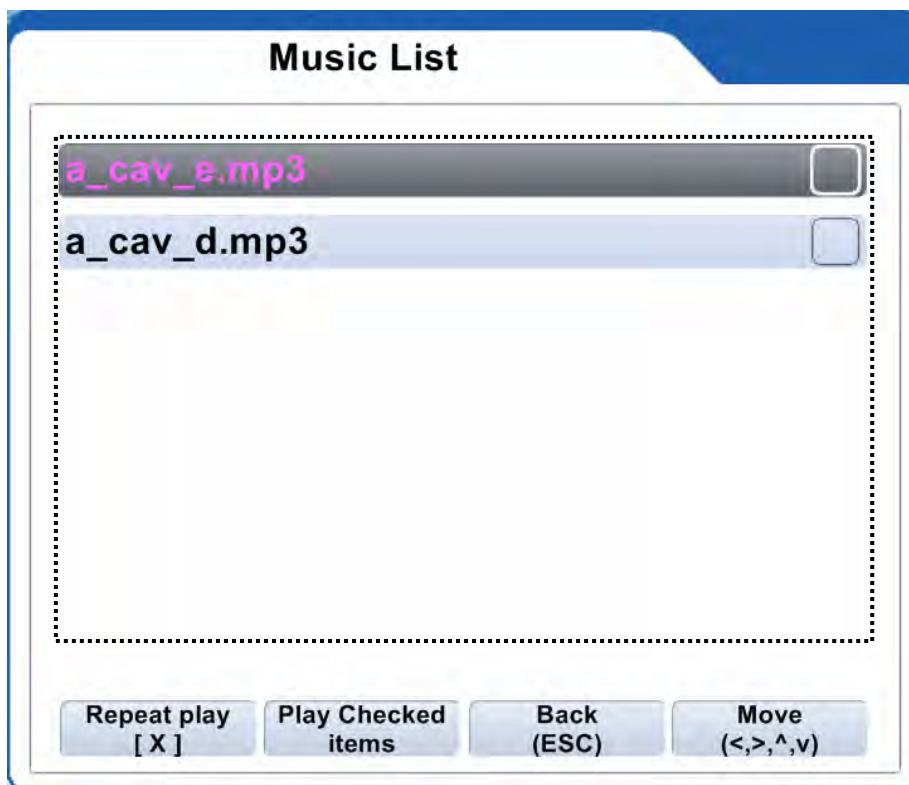

← Shows registered music files

2. Click “Play checked items” after selecting a music file.

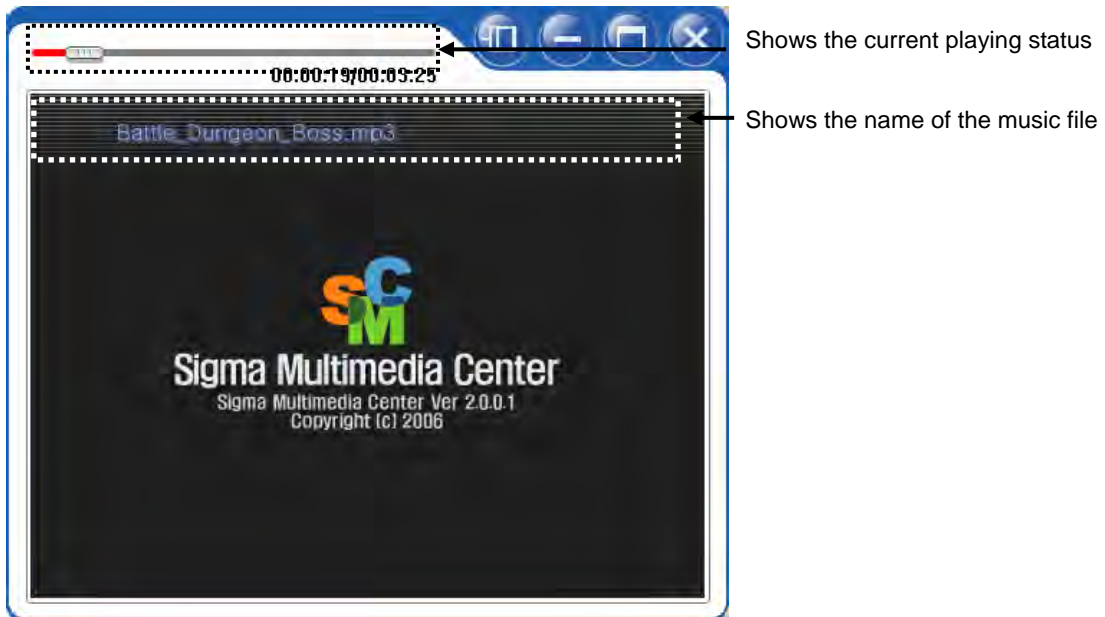

Note

Picture files can be shown while playing if picture files are registered while playing. Refer to page ~ to add files.

3) Picture

This function is used to see picture files(BMP/GIF/JPEG/JPG/PNG/TIFF) from HDD or CD-ROM Drive.

Note

Picture files should be registered in the Book Mark to use Picture function. Refer to page ~ for more information.

1. Select 'Picture []' in the menu.

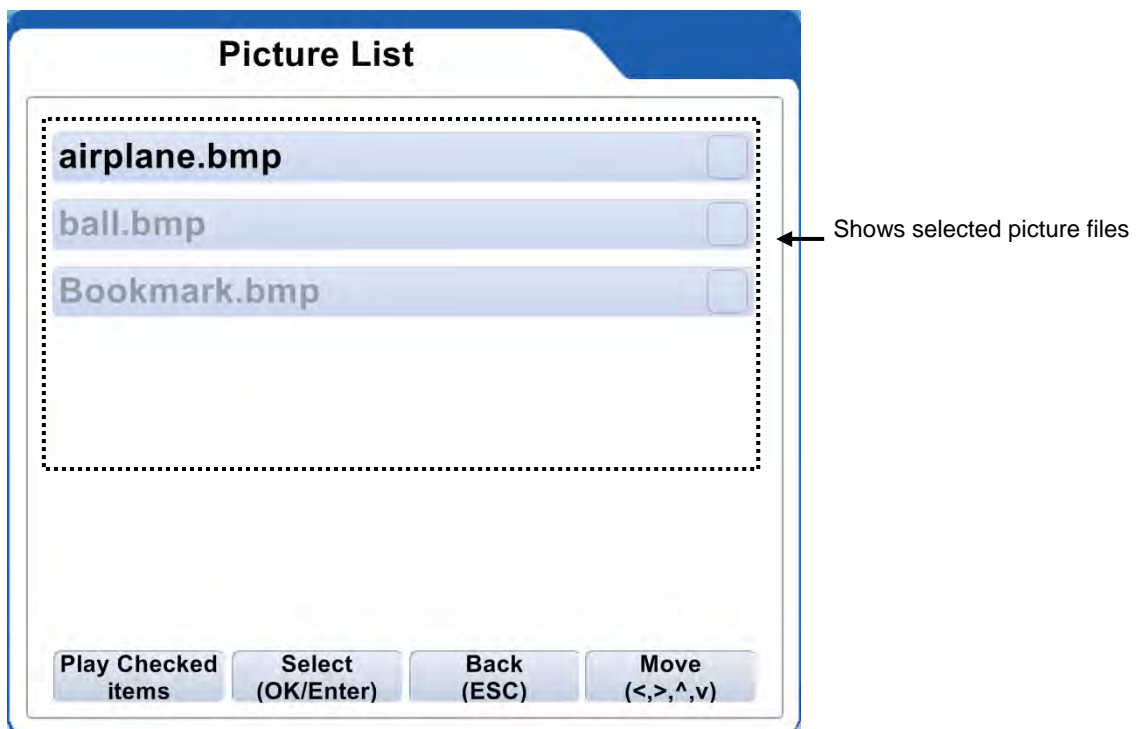

2. Selected picture files will be shown by clicking 'Play Checked item'.

4) Movie

This function is used to see video files(ASF/AVI/MPEG/MPG/TP/TRP/TP) from HDD or CD-ROM Drive.

Note

Video files should be registered in Book Mark to use Movie function. Refer to page~ for more information.

1. Select 'Movie[

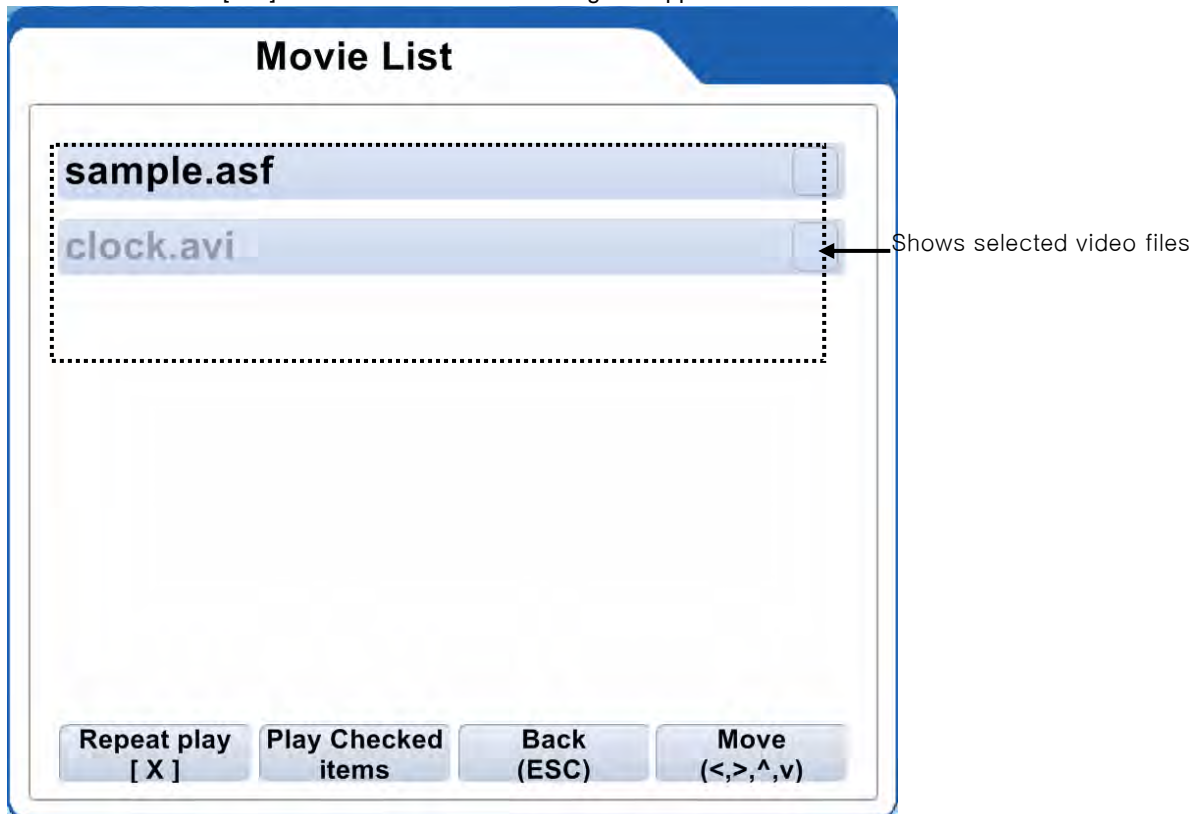

2. Click "Play Checked items" after selecting a video file.

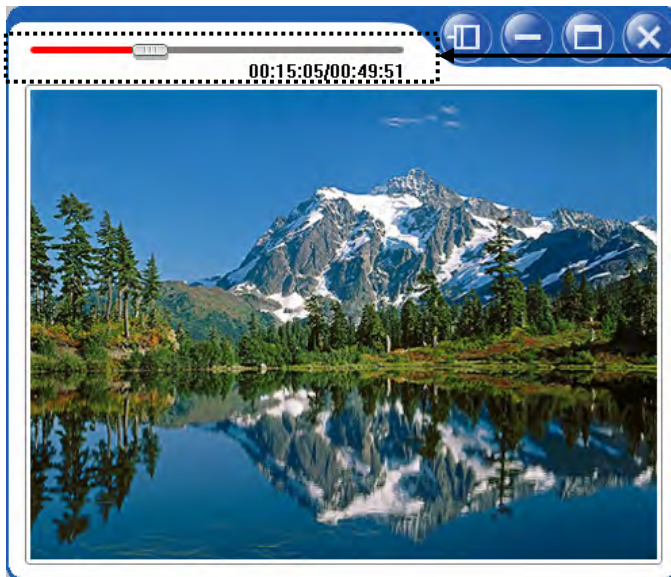

Shows the current playing status
(The playing position can be changed
with the mouse dragging.)

Screen window

5) DVD function

This function is used to play DVD titles on the DVD-ROM.

1. Insert a DVD title into the DVD-ROM.

2. Click 'DVD[

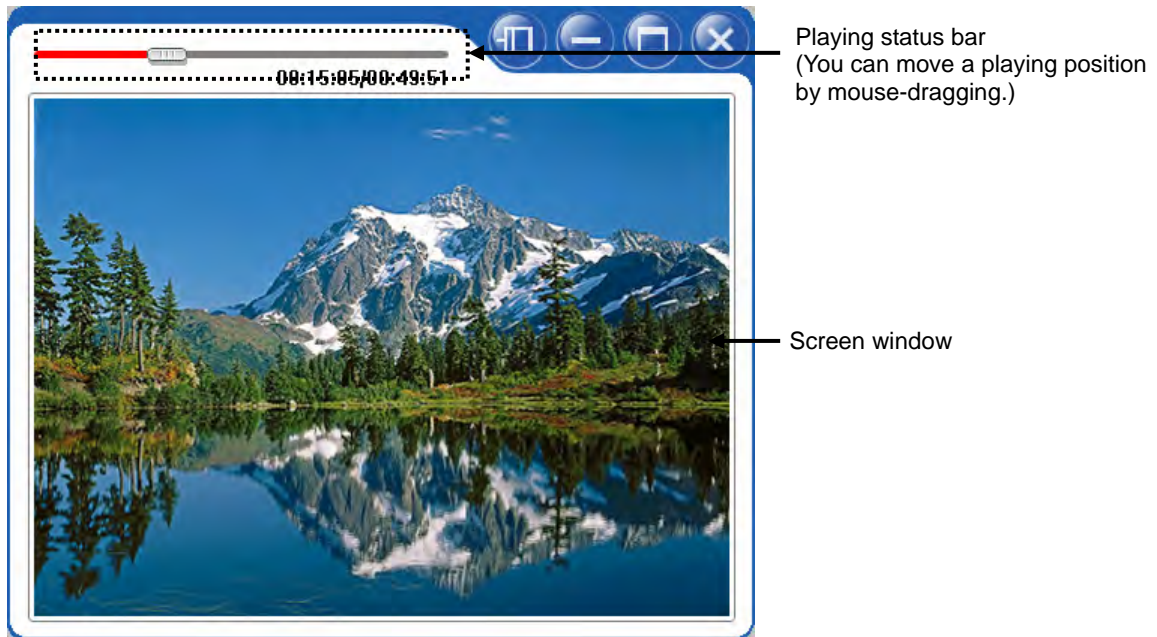

Note

Sub-title and angle options can be set in Setting Multimedia. Refer to the page “ ”.

6) Radio function

This is used to receive radio signals from local radio stations.

- Select 'FM[

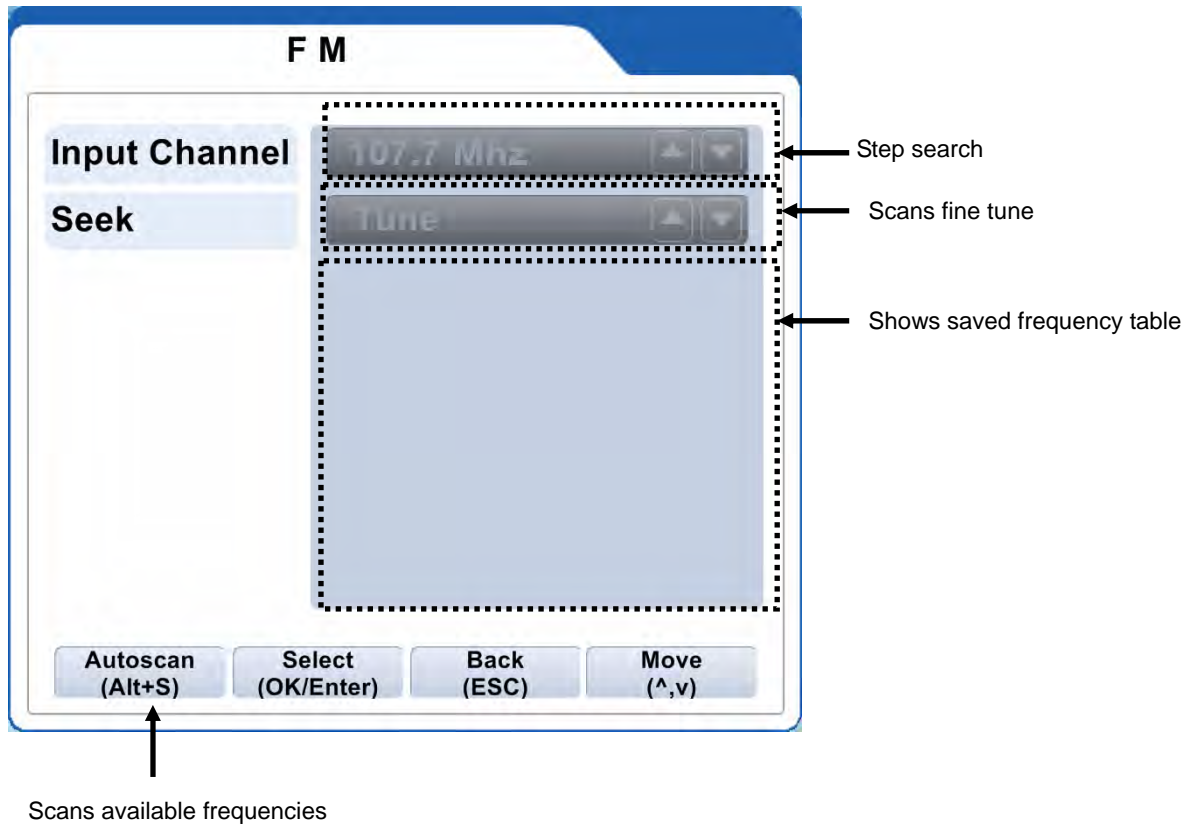

. Manual input for frequencies

1. Select "input channel" in FM window.
2. Input a channel you want in the input channel window and press Save.

Note
For FM radio reception, a FM radio card is required to install in your system.

Note
An antenna is required for fine frequency scan.

7) Setting

This is used to show configurations for each function(TV/music/file/video/picture).

The default set values can be changed.

When selecting a function to change, appropriate setup window appears.

■ General setting

This is used to set country, time zone and screen size. In addition priority, exit mode, sleep, auto update and startup size can be set.

Select 'Common[

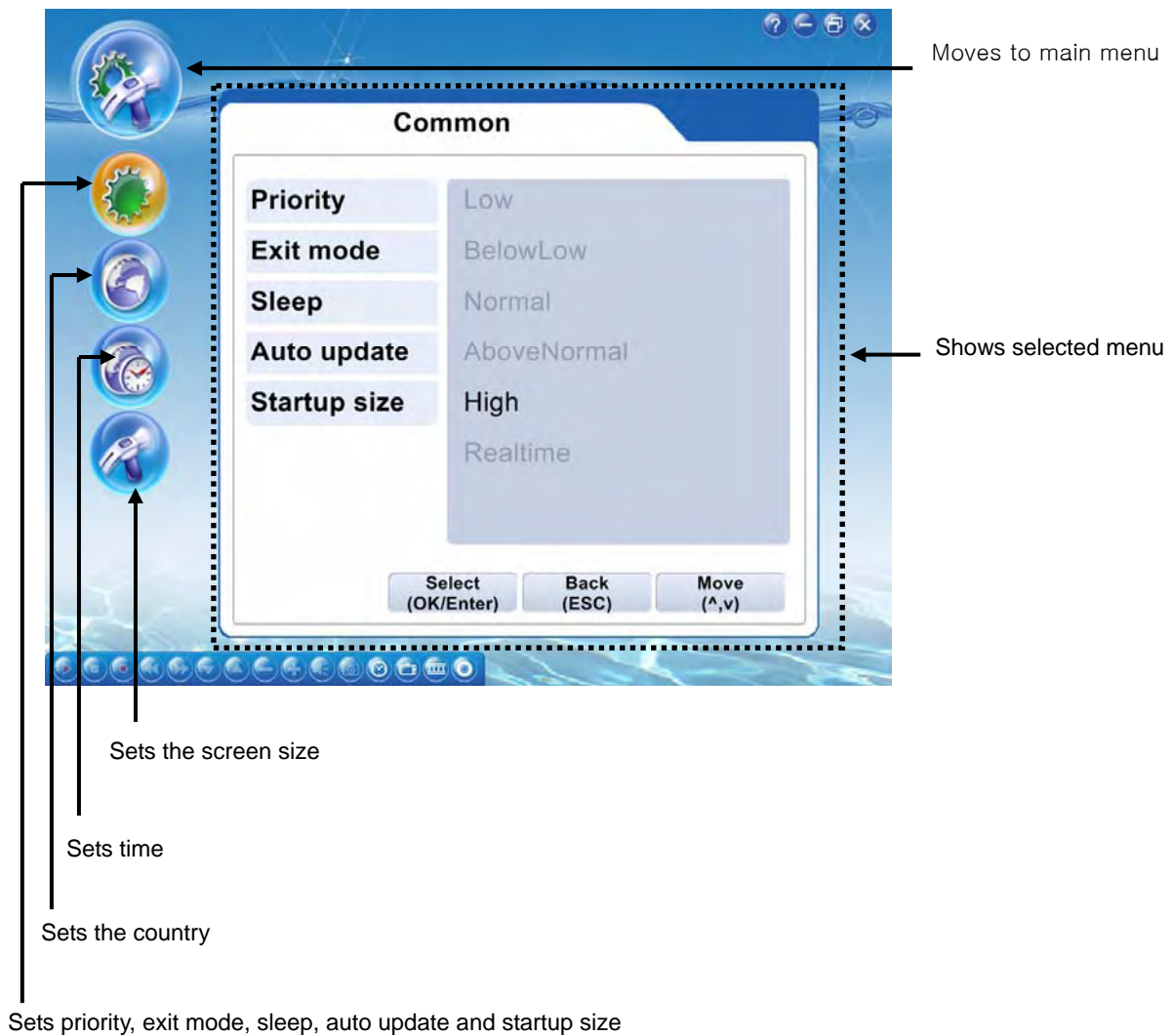

■ Setting TV

This menu is used to set configurations for TV input modes and pre-schedule.

Select 'TV Config[]' in the main menu.



Moves to previous menu

Shows selected menu

Sets to reserve a time for start and quit

Sets required values for still image and video capture

Sets overlay and screen size

Sets TV color values

Sets audio format from analog TV, sub-title, input modes, and antenna types

■ Setting File configuration

This menu is used to set play order, search time duration, aspect ratio and screen size for music and video files.

Select 'File Config[]' in the main menu.

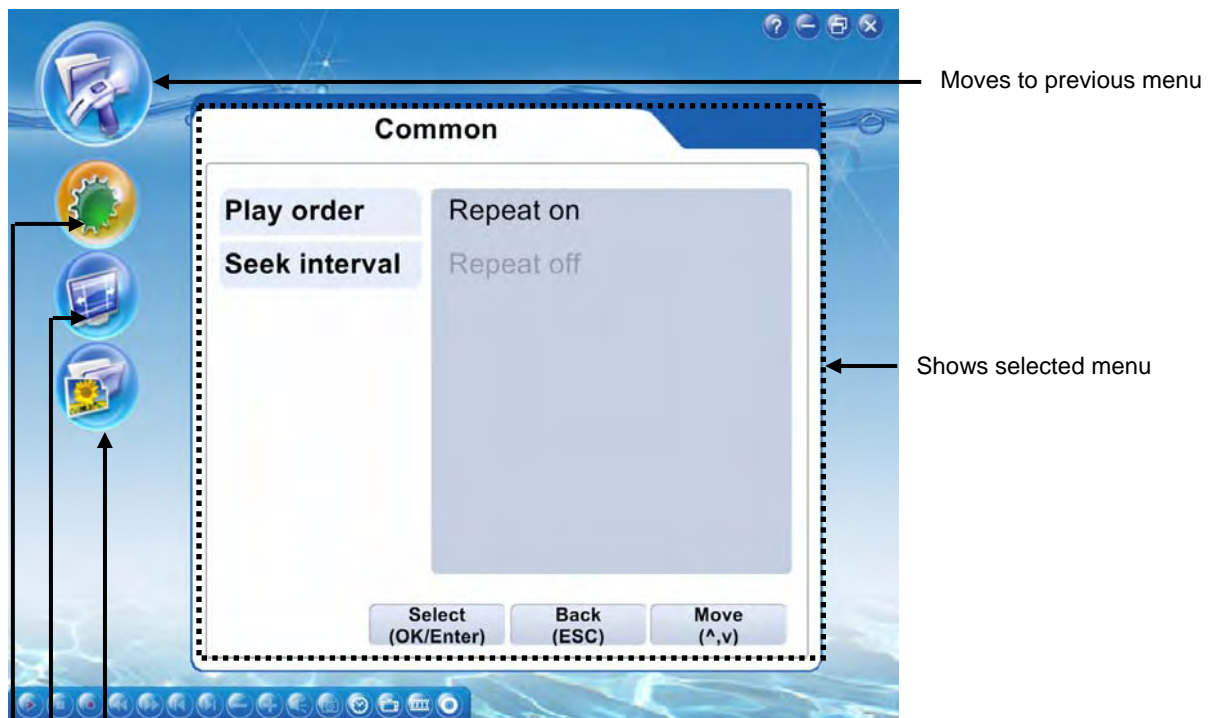

Shows info on picture files and sets slide show time

Sets aspect ratio and screen size

Sets play order and search time duration

■ **Setting Multimedia**

This menu is used to set configurations for DVD or Digital Camcorder.

Select 'Multimedia Config[]' in the menu.



Moves to previous menu

Shows selected menu

Sets aspect ratio or screen size

Sets recording folder, file format and recording time

Sets sub-title, audio, angle and closed caption

Setting	Value
Subttl	None
Audio	Title default
Angle	German
CC	English Spanish French Japanese

1/2 ◀ ▶

Select (OK/Enter) Back (ESC) Move (^,v)