



SDP660 PORTABLE RADIO

USER MANUAL

TNM-U-E-0114, Issue 1.1B
July 2013



Field House,
Uttoxeter Old Road
Derby
DE1 1NH

Tel: +44 (0) 1332 375500
FAX: +44 (0) 1332 375501
<http://www.simocogroup.com>



1270 Ferntree Gully Road,
Scoresby
Victoria, 3179
Australia

Tel: +61 (0)3 9730 3999
FAX: +61 (0)3 9730 3988
<http://www.simocogroup.com>

©Simoco 2013

PREFACE

DECLARATION

This User Manual covers the Digital Mobile Radio (DMR) Operating Instructions for the SDP660 Portable Radio Transceiver.

Any performance figures quoted are subject to normal manufacturing and service tolerances. The right is reserved to alter the equipment described in this manual in the light of future technical development.

Changes or modifications not expressly approved by the party responsible for compliance could void the user's authority to operate the equipment.

COPYRIGHT

All information contained in this document is the property of Simoco. All rights are reserved. This document may not, in whole or in part, be copied, photocopied, reproduced, translated, stored, or reduced to any electronic medium or machine-readable form, without prior written permission from Simoco.

COMPUTER SOFTWARE COPYRIGHTS

The AMBE+2™ voice coding Technology embodied in this product is protected by intellectual property rights including patent rights, copyrights and trade secrets of Digital Voice Systems, Inc. This voice coding Technology is licensed solely for use within this Communications Equipment. The user of this Technology is explicitly prohibited from attempting to extract, remove, decompile, reverse engineer, or disassemble the Object Code, or in any other way convert the Object Code into a human-readable form. U.S. Patent Nos. #6,912,495 B2, #6,199,037 B1, #5,870,405, #5,826,222, #5,754,974, #5,701,390, #5,715,365, #5,649,050, #5,630,011, #5,581,656, #5,517,511, #5,491,772, #5,247,579, #5,226,084 and #5,195,166.

DISCLAIMER

There are no warranties extended or granted by this document. Simoco accepts no responsibility for damage arising from use of the information contained in the document or of the equipment and software it describes. It is the responsibility of the user to ensure that use of such information, equipment and software complies with the laws, rules and regulations of the applicable jurisdictions.

EQUIPMENT AND MANUAL UPDATES

In the interests of improving the performance, reliability or servicing of the equipment, Simoco reserves the right to update the equipment or this document or both without prior notice.

ERRORS AND OMISSIONS

The usefulness of this publication depends upon the accuracy and completeness of the information contained within it. Whilst every endeavour has been made to eliminate any errors, some may still exist. It is requested that any errors or omissions noted should be reported to either of the following who are part of the Simoco group:



Field House
Uttoxeter Old Road, Derby.
DE1 1NH. UK

Tel: +44 (0) 871 741 1050

E-mail: customer.service@simocogroup.com



1270 Ferntree Gully Road, Scoresby
Victoria. 3179
Australia

Tel: +61 (0)3 9730 3999

E-mail: inquiry.aus@simocogroup.com

DOCUMENT HISTORY

Issue	Date	Comments
1.0	January 2013	Initial Issue.
1.1	July 2013	Additional General Precaution added, plus changes to Support page email addresses.

RELATED DOCUMENTS

1. **TNM-M-E-0033. SDP600 Series DMR Portable Radio Transceivers – Service Manual, Issue 1.0.**
2. **TNM-U-E-0116. SDP660 Portable Radio – Brief User Guide, Issue 1.1, dated July 2013.**
3. **TNM-U-E-0118. PAR-600CRG1 Single Rapid Charger – SDP650/660 Instruction Manual, Issue 1.0, dated January 2013.**

To order printed copies of this or any of the above publications, please contact Simoco. See the **Support** page for contact information.

A comprehensive list of documentation is available for download on the Simoco website <http://www.simocogroup.com> via the Partner Portal.

TABLE OF CONTENTS

	Page
Title Page	1
Preface	2
Table of Contents (This List)	4
List of Figures	6
List of Tables	7
Personal Safety	8
Warnings	8
Compliance with RF Energy Exposure Guidelines (United States and Canada)	10
General Notes	13
Support – Contact Information	14
Abbreviations	15
Glossary	16
1 INTRODUCTION	17
1.1 OVERVIEW	17
1.2 CONFIGURATION	17
1.3 FEATURES	17
2 GETTING STARTED	19
2.1 PREPARING THE RADIO FOR USE	19
2.1.1 Charging the Battery	19
2.1.1.1 Procedure	19
2.1.2 Fitting the Battery	20
2.1.3 Fitting the Antenna	20
2.1.4 Fitting the Belt Clip	21
2.1.5 Fitting Audio Accessory/Programming Cable	21
2.2 CONFIGURATION	21
3 FRONT PANEL CONTROLS	22
4 MAIN SCREEN	24
4.1 DEFAULT SCREEN LAYOUT	24
4.1.1 Soft Labels	24
4.1.2 Text Panel	24
4.1.3 Icons	24
5 BASIC OPERATIONS	28
5.1 TURNING THE RADIO ON/OFF	28
5.2 ENTERING A PASSWORD	28
5.3 WELCOME SCREEN	29
5.4 LOCKING AND UNLOCKING THE KEYPAD	29
5.5 ADJUSTING THE VOLUME	30
5.6 SELECTING A ZONE	30
5.7 SELECTING A CHANNEL	30

5.8	MAKING A CALL	30
5.9	RECEIVING A CALL	31
9	SCAN/ VOTING FUNCTIONS	32
5.9.1	Scan/ Voting Screen.....	32
5.10	EMERGENCY ALARM	33
5.10.1	Making an Emergency Call.....	33
6	MENU SYSTEM.....	34
6.1	MENU NAVIGATION.....	35
7	MENU SCREENS	36
7.1	CHANNELS MENU.....	36
7.2	ZONE MENU.....	37
7.3	SETTINGS MENU	37
7.4	OPTIONS MENU.....	38
7.5	CONTACTS MENU.....	38
7.6	INFORMATION MENU.....	39
7.7	MESSAGES MENU	40
7.7.1	Inbox	40
7.7.2	Outbox.....	41
7.7.3	Send Status.....	41
7.7.4	Send Template	42
7.7.5	New Message.....	42
7.7.6	Sending Status, Template and Text Messages.....	43
7.7.7	Viewing Received Messages.....	43
7.8	MUTE ADJUST MENU.....	44
7.9	BACKLIGHT MENU.....	45
7.10	BRIGHTNESS MENU.....	46
7.11	KEY BEEPS MENU.....	46
7.12	SPEAKER VOLUME MENU	47
7.13	ALERT VOLUME MENU.....	47
7.14	RADIO STATUS MENU.....	48
7.14.1	RSSI 48	
7.14.2	Battery Level	48
7.14.3	Accelerometer Orientation	49
7.14.4	GPS 49	
7.15	SCAN MENU.....	49
7.16	DISPLAY TEST	50
8	SPECIAL FUNCTIONS.....	52
8.1	CHANNEL UP AND DOWN	52
8.2	ZONE UP AND DOWN	52
8.3	SCAN ON/OFF.....	52
8.4	SKIP.....	52
8.5	TALK AROUND ON/OFF	52
8.6	LOW POWER.....	52
8.7	GO TO CHANNEL A, B, C OR D.....	52
8.7.1	Go To Contact A, B,C or D	52
8.8	MENU	52

8.9	ZONE, CHANNEL, CONTACT AND MUTE	52
8.10	RESET	53
8.11	SPEAKER MUTE	53
8.12	MAN DOWN.....	53
8.13	LONE WORKER	54
1.1	DMR ALL CALL DIAL STRING.....	54
9	DIAL STRINGS.....	55
10	ACCESSORIES.....	56

APPENDICES

A ALERT TONES AND MESSAGES.

LIST OF FIGURES

	Page
Figure 1. Fitting the Battery.	20
Figure 2. Fitting the Antenna.	20
Figure 3. Fitting the Belt Clip.	21
Figure 4. Fitting Audio Accessory/Programming Cable.....	21
Figure 5. SDP660 Controls.....	22
Figure 6. Default Screen Layout.....	24
Figure 7. Initial Screen.	28
Figure 8. Password Screen.	28
Figure 9. Welcome Screen (example).	29
Figure 10. Default Screen with Keys Locked.	29
Figure 11. Menu Navigation (example).....	35
Figure 12. Channels Menu.	36
Figure 13. Zone Menu.	37
Figure 14. Settings Menu (example).....	37
Figure 15. Options Menu.....	38
Figure 16. Contacts Menu.	38
Figure 17. Individual contact details.	39
Figure 18. Information Menu.	39
Figure 19. Radio Information Screens.....	39
Figure 20. Messages Menu.	40
Figure 21. Messages – Inbox.	40
Figure 22. Messages – Outbox.....	41
Figure 23. Messages – Send Status.....	41
Figure 24. Messages – Send Template.....	42
Figure 25. Messages – New Message.....	42
Figure 26. Send Message Screen.	43
Figure 27. Message View Screen.....	44
Figure 28. Message Options Screen.	44

Figure 29. Mute Adjust Menu.....	45
Figure 30. Backlight Menu.....	45
Figure 31. Brightness Menu.....	46
Figure 32. Key Beeps Menu.....	46
Figure 33. Speaker Volume Menu.....	47
Figure 34. Alert Volume Menu.....	47
Figure 35. Radio Status Menu – RSSI Screen.....	48
Figure 36. Radio Status Menu – Battery Level Screen.....	48
Figure 37. Radio Status Menu – Accelerometer Orientation Screen.....	49
Figure 38. Radio Status Menu – GPS Screen.....	49
Figure 40. Scan Menu.....	50
Figure 41. Test Mode Menu.....	50
Figure 42. Display Test Menu.....	50

LIST OF TABLES

	Page
Table 1. Charge Indications.....	20
Table 2. SDP660 – Controls.....	23
Table 3. LED Indications.....	23
Table 4. Icon Details.....	25
Table 5. SDP650 and SDP660 DMR Portable Radio Accessories.....	56
Table A1. Alert Tones.....	58

PERSONAL SAFETY

SAFETY PRECAUTIONS

These Safety Precautions, Warnings and Cautions advise personnel of specific hazards which may be encountered when using the equipment covered in this manual and that control measures are required to prevent injury to personnel, and damage to equipment and/or the environment.

Before using this equipment, personnel are to acquaint themselves with all risk assessments relevant to the work site and the task. They must then comply with the control measures detailed in those risk assessments.

References covering safety regulations, health hazards and hazardous substances are detailed under the **WARNINGS** section below. These are referred to in this user manual when they are encountered.

GENERAL PRECAUTIONS

Do NOT operate your portable radio, without a hands-free kit, whilst driving a vehicle.

Do NOT operate your radio in an explosive atmosphere – unless the radio's level of IECEx approval is approved for use in that atmosphere.

Obey the 'Turn Off Two-way Radios' signs where these are posted, e.g. on a petrol station forecourt.

Do NOT touch the antenna while the radio is transmitting.

Do NOT use or store the batteries above +60 °C.

Do NOT dispose of batteries in a fire.

Do NOT operate the radio if the antenna has become disconnected or damaged.

Only recharge batteries in an approved battery charger.

HAZARDOUS SUBSTANCES

Before using any hazardous substance or material, the user must be conversant with the safety precautions and first aid instructions:

- On the label of the container in which it was supplied.
- On the material Safety Data Sheet.
- In any local Safety Orders and Regulations.

WARNINGS

Lithium Batteries



WARNING
LITHIUM BATTERIES. THIS EQUIPMENT USES LITHIUM ION BATTERIES. REFER TO THE CONTROL OF SUBSTANCES HAZARDOUS TO HEALTH REGULATIONS (COSHH) 2002 AND/OR THE APPROPRIATE SAFETY DATA SHEET.

Radio Frequency Radiation



WARNING
RADIO FREQUENCY RADIATION. A RADIO FREQUENCY (RF) RADIATION HAZARD EXISTS IN THIS EQUIPMENT. TO AVOID RF INJURY, DO NOT TOUCH THE ANTENNA WHEN THE TRANSMITTER IS IN USE. DO NOT OPERATE TRANSMITTER WITH THE ANTENNA DISCONNECTED.

Dangerous Voltages

Dangerous voltages exist in this equipment, for the appropriate Safety precautions, refer to the relevant Electrical Safety Regulations appropriate to the country of operation.



WARNING
DANGEROUS VOLTAGES. DANGEROUS VOLTAGES EXIST IN ALL THE BATTERY CHARGERS USED WITH THIS RADIO. FOR THE APPROPRIATE SAFETY PRECAUTIONS REFER TO THE RELEVANT ELECTRICAL SAFETY REGULATIONS APPROPRIATE TO THE COUNTRY OF OPERATION.

HINTS FOR USING THE RADIO

When transmitting, hold the radio a few centimetres from your mouth and speak across it, rather than into it. The microphone is located near the bottom left hand corner of the portable radio.

Keep the length of your conversation to a minimum to conserve battery life.

When it is possible to move location, avoid making calls from known poor signal-strength areas such as the radio systems fringe areas (limit of range) or from screened or shadowed areas, e.g. an underground car park or underpass.

COMPLIANCE WITH RF ENERGY EXPOSURE GUIDELINES (UNITED STATES AND CANADA)

RF ENERGY EXPOSURE AWARENESS AND CONTROL INFORMATION AND OPERATIONAL INSTRUCTIONS FOR FCC OCCUPATIONAL USE REQUIREMENTS

Before using your Simoco portable two-way radio, read this important RF energy awareness and control information and operational instructions to ensure compliance with the Federal Communication Commission's (FCCs) RF exposure guidelines.

NOTICE.

This radio is intended for use in Occupational/Controlled conditions in a portable application where users have full knowledge of their exposure and can exercise control over their exposure to meet the occupational limits in FCC/ICNIRP and International Standards. This radio device is NOT authorised for general population consumer use.

This two-way radio uses electromagnetic energy in the Radio Frequency (RF) spectrum to provide communications between two or more users over a distance. It uses RF energy or radio waves to send and receive calls. RF energy is one form of electromagnetic energy. Other forms include, but are not limited to, electric power, sunlight and x-rays. RF energy, however, should not be confused with these other forms of electromagnetic energy, which, when used improperly, can cause biological damage. Very high levels of x-rays, for example, can damage tissues and genetic material.

Experts in science, engineering, medicine, health and industry work with organizations to develop standards for safe exposure to RF energy. These standards provide recommended levels of RF exposure for both workers and the general public. These recommended RF exposure levels include substantial margins of protection. All Simoco two-way radios are designed, manufactured and tested to ensure they meet government established RF exposure levels. In addition, manufacturers also recommend specific operating instructions to users of two-way radios. These instructions are important because they inform users about RF energy exposure and provide simple procedures on how to control it. Please refer to the following websites for more information on what RF energy exposure is and how to control your exposure to assure compliance with established RF exposure limits.

<http://transition.fcc.gov/oet/rfsafety/rf-faqs.html>

<http://www.osha.gov/SLTC/radiofrequencyradiation/>

Federal Communications Commission Regulations

The FCC rules require manufacturers to comply with the FCC RF energy exposure limits for portable two-way radios before they can be marketed in the United States (US). When two-way radios are used as a consequence of employment, the FCC requires users to be fully aware of and able to control their exposure to meet occupational requirements. Simoco two-way radios have an exposure awareness label attached to the equipment directing users to specific awareness information. Do not remove this exposure awareness label from the device. Additionally, your Simoco user manual or separate safety booklet includes information and operating instructions required to control your RF exposure and to satisfy compliance regulations.

Compliance with RF Exposure Standards

Simoco two-way radios are designed and tested to comply with a number of national and international standards and guidelines (listed below) for human exposure to RF electromagnetic energy. This radio complies with the IEEE (FCC) and International Commission on Non-Ionizing Radiation Protection (ICNIRP) exposure limits for Occupational/Controlled RF exposure environments at operating duty factors of up to 50% talk 50% listen and is authorised by the FCC

for occupational use. In terms of measuring RF energy for compliance with these exposure guidelines, your radio generates measurable RF energy only while it is transmitting (during talking), not when it is receiving (listening) or in standby mode.

Your Simoco two-way radio complies with the following RF energy exposure standards and guidelines:

- United States Federal Communications Commission, Code of Federal Regulations; 47CFR part 2 sub-part J.
- American National Standards Institute (ANSI)/Institute of Electrical and Electronic Engineers (IEEE) C95.1-1992.
- Australian Communications Authority Radio Communications Standard et seq.
- Institute of Electrical and Electronic Engineers (IEEE) C95.1-1999 Edition.
- Industry Canada RSS-102.

RF Exposure Compliance and Control Guidelines and Operating Instructions

To control exposure to yourself and others and ensure compliance with the Occupational/Controlled environment exposure limits always adhere to the following procedures.

Guidelines:

- User awareness instructions should accompany the device when transferred to other users.
- This radio meets the FCC RF exposure guidelines when used with the Simoco accessories supplied or designated for the product. The designated Simoco belt clip type is PAR-600CLIP and the extension speaker microphone types are PAR-9180LMS2-2, PAR-9180LMW1 and PAR-600LMS4. Use of other accessories may not ensure compliance with the FCC's RF exposure guidelines and may violate FCC regulations.
- Do not use this device if the operational requirements described herein are not met.

Instructions:

- Transmit no more than the rated duty factor of 50% of the time. To transmit (talk), push the Push-To-Talk (PTT) button. To receive calls (listen), release the PTT button. Transmitting 50% of the time, or less, is important because the radio generates measurable RF energy exposure only when transmitting (in terms of measuring for standards compliance).
- Do not operate the radio without an approved antenna attached, as this may cause the FCC RF exposure limits to be exceeded. With this product, only use an antenna supplied or approved by Simoco.
- Always keep the radio at least 5 cm (2.0 inches) from the face when transmitting and at least 10 mm (0.4 inches) from the body. This radio has been tested for RF exposure compliance at the distances listed in **Table 1**.

Table 1. RF Exposure Compliance Distances

Frequency Band	Bodyworn	Handheld in front of Face
AC: 136 MHz – 174 MHz	10 mm (0.4 inches)	25 mm (1.0 inches)
TU: 400 MHz – 480 MHz	10 mm (0.4 inches)	25 mm (1.0 inches)
UW: 440 MHz – 520 MHz	10 mm (0.4 inches)	25 mm (1.0 inches)

Approved Accessories

- This radio meets the FCC RF exposure guidelines when used with the Simoco accessories supplied or designated for the product. Use of other accessories may not ensure compliance with the FCCs RF exposure guidelines and may violate FCC regulations.
- To obtain a list of Simoco approved accessories please see the Simoco Group Departmental contact details on the Support page and either contact the relevant Technical Support Helpline or Customer Services, visit the following website, which lists approved accessories:

<http://www.simocogroup.com>

For additional information on exposure or other information, please see the Simoco Group Departmental contact details on the Support page and contact the relevant Technical Support Helpline or Customer Services.

GENERAL NOTES

MANUAL COMPILATION

This manual provides detailed information on the use of the SDP660 DMR Portable Radio Transceiver including Getting Started, Front Panel Controls, Main Screen, Basic Operations, Menu System, Menu Screens, Special Functions and Accessories.

Details of both the “default” and “optional” system configurations have been included in this User Manual, therefore, some material may not be relevant to every system. Configuration is dependent upon the specification by the customer when the equipment was ordered and installed.

PAGINATION

This manual is divided into a number of sections, each section deals with one aspect of the system.

Following initial issue, any page that has been amended or updated will also bear an updated reference.

SIMOCO SUPPORT

CONTACT INFORMATION

At Simoco we welcome your comments, feedback and suggestions. Departmental contacts have been provided for your quick reference below.



UK Customer Services

Email: customer.service@simocogroup.com
Tel: UK: 08717 411 050
International: +44 (0) 1332 375 671
Fax: UK: 08717 411 049
International: +44 (0) 1332 376 672

Sales

E-mail sales@simocogroup.com

Marketing

E-mail marketing@simocogroup.com

Technical Support

E-mail: techsupport@simocogroup.com

Technical Support Helpline

Tel: UK: 08717 411 040
International: +44 (0) 1332 375 671



Australian Customer Services

Email: inquiry.aus@simocogroup.com
Tel: Within Australia: 1300 363 607
International: +61 3 9730 3999



US Customer Services

Email: customerservice@simocoamericas.com
Tel: +1 (0) 877 848 3876

Technical Support

E-mail: techsupport@simocoamericas.com

ABBREVIATIONS

The following abbreviations are used through out this document. Whenever practicable, wherever the abbreviation is first used the full meaning is given with the abbreviation in parenthesis, after that only the abbreviation will be used.

LIST OF ABBREVIATIONS

Abbreviation	Meaning
AC	Alternating Current
ANSI	American National Standards Institute
BER	Bit Error Rate
CC	Colour Code
COSHH	Control Of Substances Hazardous to Health
CTCSS	Continuous Tone Controlled Squelch System
DCS	Digital Coded Squelch
DMR	Digital Mobile Radio
DSP	Digital Signals Processor
FCC	Federal Communications Commission
FDMA	Frequency Division Multiple Access
FM	Frequency Modulation
FPP	Field Personality Programmer
GPS	Global Positioning System
ICNIRP	International Commission on Non-Ionizing Radiation Protection
ID	Identification
IECEX	International Electrotechnical Commission system for the certification to standards for electrical equipment for Explosives atmospheres.
IEEE	Institute of Electrical and Electronics Engineers
LCD	Liquid Crystal Display
LED	Light Emitting Diode
OVCM	Open Voice Channel Mode
PABX	Private Automatic Branch eXchange
PIN	Personal Identification Number
PSTN	Public Switched Telephone Network
PTT	Push (Press) To Talk
RF	Radio Frequency
RSSI	Received Signal Strength Indicator
Rx	Receiver
SDM	Simoco Digital Mobile
SDP	Simoco Digital Portable
SUID	Subscriber Unit Identification
TGID	Talk Group Identification
Tx	Transmitter
UID	Unit Identification
US	United States

GLOSSARY OF TERMS

The table below contains a list of the common terms used through out this document and their meanings.

Term	Meaning
'.....'	Reference to a setting or feature (exactly as it is displayed) that may be selected or enabled either directly or through a software application, e.g. 'Menu', 'Control', 'Switch'.
Channel	A logical combination of RF Frequency, Default Talk Group Identity (TGID), other channel associated parameters (CTCSS, scan etc)
CTCSS	A sub-audio tone used for validating a received signal (also known as a PL tone).
FPP	Field Personality Programmer or Field Programmer. A Software Application used for configuring the radio options and parameters.
Monitor	Mode of Radio Receive. Any DMR signal regardless of Colour Code or TGID will be heard.
Normal Mute	Mode of Radio Receive. Only signals with matching Colour Code will be heard.
Push To Talk	The action or signal that causes the equipment to be placed into transmit mode or to be keyed.
Radio Unit ID	Unique identifier allocated to each radio (range: 0 – 16,000,000).
Scanning	A process of selecting the first-found, permitted signal from one of several possible radio channels carrying different signals, by sequentially scanning the channels.
Selective	Mode of Radio Receive. Only signals with matching Colour Code and TGID or Unit ID will be heard.
Vote/voting	A process to select a permitted radio signal of adequate signal quality from one of several possible radio channels carrying the same signal, by sequentially scanning the channels before and at the start of signal reception.
Zone	A collection of channels (usually organised by functional group of users).

1 INTRODUCTION

1.1 OVERVIEW

The SDP600 Series Radios are versatile Digital Signal Processor (DSP) controlled, two-way portable radios. The SDP600 Series Radio is available in a number of frequency bands for specific applications.

The radios are software programmable and can be customised to the operational requirements of a customer's particular fleet. Simoco representatives can help in programming the radio facilities to meet a customer's present and future requirements.

A comprehensive range of accessories is available to compliment the SDP600 Series Radios including: chargers, antennas, remote speaker microphones, covert/surveillance kits, holsters and carry cases. Refer to Simoco for comprehensive descriptions and pricing.

The SDP660 model offers full keypad functionality for telephony, complex groups, advanced data messaging and a total of 12 programmable function keys. The SDP650 model offers seven function keys but no keypad.

This User Manual describes the facilities that are currently available and can be programmed into the SDP660 Series Radios.

1.2 CONFIGURATION

Before the SDP660 radio can be used it must be configured using the Field Personality Programmer (FPP). The configuration process loads the customised channels, signalling and user options so that the radio will operate with the user's system.

1.3 FEATURES

The SDP660 portable radio has the following features:

- Integrated Man Down - motion and positional sensor for full employee safety.
- IP67 performance for best in class resistance to water and dust.
- Ear-piece speaker for full-duplex calling mode.
- Bluetooth, enhances the radio with wireless accessories and applications.
- Integral Global Positioning System (GPS) Antenna for dedicated satellite performance placed optimally within the radio.
- High output main speaker for loud & clear digital audio.
- 7-colour Light Emitting Diode (LED) with all-round viewing for clear indication of radio status.
- Easy access to emergency button for no-doubt notification.
- Ergonomic push-to-talk.
- Selector knob enhances usability, for control of volume and brings smart-phone speed-scrolling to the radio.
- IP67 rated side-connector.
- Battery life 40% greater than equivalent analogue and Frequency Division Multiple Access (FDMA) technologies.
- Multiple programmable buttons, from side function keys to main keypad for ultimate customisation.
- Intuitive keypad.

- Full colour display with intuitive interface.

2 GETTING STARTED

This User Manual covers the basic operation of the Simoco SDP660 Digital Portable radio.

The radio is software programmable and can be customised to the operational requirements of a customer's specific needs. Simoco representatives can help in programming the radio facilities to meet a customer's present and future requirements.

Users should check with their Simoco dealer or system administrator about the features programmed into the radio and specifically about:

- Whether any preset conventional channels are programmed into the radio?
- Which buttons have been programmed to access other features?
- The optional accessories that may be required?

2.1 PREPARING THE RADIO FOR USE

2.1.1 Charging the Battery



WARNING
LITHIUM BATTERIES. THIS EQUIPMENT USES LITHIUM ION BATTERIES. REFER TO THE PERSONAL SAFETY PAGES.

Your radio is powered by either a 2200 mAh or a 3000 mAh Lithium Ion battery. To avoid damage and comply with warranty terms, the battery should be charged with a Simoco Standard Battery charger.

For best performance, new batteries should be charged for 5 hours before initial use.

2.1.1.1 Procedure

This charging procedure assumes that the PAR-600CRG1 Single Rapid Charger is used. For full details on this charger, please refer to TNM-U-E-0118, PAR-600CRG1 Single Rapid Charger – SDP650/660 Instructional Manual [3].

- 1 Connect the AC power adapter to an AC mains supply and to the socket on the back of the charger.
- 2 Switch on the mains power. The Red LED on the charger will flash briefly. The charger is now in standby mode.
- 3 Switch the radio off.
- 4 Place the battery pack, or the radio with the battery attached, into the charging slot on the charger.
- 5 Check that the Red LED on the charger is illuminated.
- 6 The fast charging process will be initiated. When the battery pack is fully charged, the Green LED on the charger will be illuminated (see **Table 2**).

Table 2. Charge Indications.

Charge State	LED States	
	Red LED	Green LED
Battery absent	Off	Off
Fast Charge	On	Off
Charge Complete	Off	On
Charge suspended (High or Low Temp)	1 Hz Flashing	Off

2.1.2 Fitting the Battery

Insert the battery into the bottom of the radio. (See arrow 1 in **Figure 1** below).

Press down slightly on the battery release clip located at the top of the battery until a click is heard. (See arrow 2).



Figure 1. Fitting the Battery.

To remove the battery, turn the radio off. Slide the battery release clip downwards to release the battery.

2.1.3 Fitting the Antenna

With the radio turned off, locate the antenna in its threaded socket and turn clockwise to tighten.



Figure 2. Fitting the Antenna.

To remove the antenna, ensure the radio is turned off and turn the antenna counterclockwise.

2.1.4 Fitting the Belt Clip

Align the belt clip with the grooves of the belt clip housing on the back of the battery. Push the belt clip downwards until a click is heard.

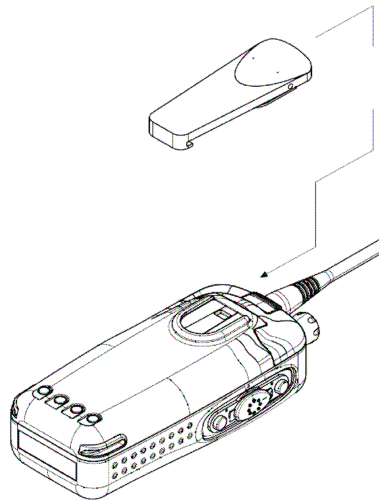

Figure 3. Fitting the Belt Clip.

2.1.5 Fitting Audio Accessory/Programming Cable

- 1 On the side of the radio, release the retaining screw and remove the accessory socket cover.
- 2 On the audio accessory/programming cable, locate the tab lug of the connector into either the top or bottom tab hole on the side of the radio as required (see **Figure 4** below).
- 3 Tighten the screw to secure the audio accessory/programming cable to the radio.



Figure 4. Fitting Audio Accessory/Programming Cable.

2.2 CONFIGURATION

Before the SDP660 radio can be used it must be configured using the Field Personality Programmer (FPP). The configuration process loads the customised channels, signalling and user options so that the radio will operate with the user's system.

3 FRONT PANEL CONTROLS

The SDP660 portable Radio has the following features:

- Multiple programmable dedicated function buttons and a numeric keypad.
- Function buttons and numeric buttons can also have a second programmable function provided by a longer button press.
- Multi-coloured LED for a clear indication of radio status.
- Full colour display with intuitive interface.



The Controls of the SDP660 Portable radio are shown below in **Figure 5**.



Figure 5. SDP660 Controls.

The functions of each of the controls are detailed below in **Table 3**.

Table 3. SDP660 – Controls.

No.	Control	Label	Function
1	Tx/Rx/Power LED		Multi coloured LED. See Table 4 below for full details of colour indications.
2	Volume		Multifunction knob. Provides volume control (rotate clockwise to increase the volume; counterclockwise to decrease the volume). Also provides channel and zone selection, in conjunction with side-buttons F6 and F13.
3	Earpiece		
4	Antenna		
5	Function Key F5		Prog. function key. Default – Emergency/Alarm .
6	Function Key F6		Prog. function key. Assignable key for Zone or Channel browsing.
7	PTT		Push To Talk. Hold the radio 10 cm from the mouth. Press and hold the PTT switch and speak. Release the PTT switch to listen.
8	Function Key F13		Prog. function key. Assignable key for Zone or Channel browsing.
9	LCD Display		
10	Function Key F1	Menu	Prog. function key. Default – Menu Select .
11	Function Key F11		Prog. function key. Default – Start Call, Send Message.
12	Function Key F12		Prog. function key. Default – End Call, Cancel, power On/Off.
13	Function Key F4	Mon	Prog. function key. Default – Mon (Monitor).
14	Nav-Up F7	▲	Prog. function key. Default – Up key for scrolling.
	Nav-Down F8	▼	Prog. function key. Default – Down key for scrolling.
	Nav-Left F9	◀	Prog. function key. Default – Left key for scrolling.
	Nav-Right F10	▶	Prog. function key. Default – Right key for scrolling.
	Nav-Select	Select	Default – Function Select .
15	Numeric Keypad		Used to enter Idents, send text messages and set status.
16	Microphone		

The details of the multi-coloured LED indications are contained below in **Table 4**.

Table 4. LED Indications.

LED Colour	Meaning
LED Off.	Radio is in idle state (no call activity).
Green	Receiving a valid incoming signal.
Green Flashing	Radio in talk-back hang time. (FPP defined parameter for digital channel).
Red	Radio is transmitting.
Red Flashing	Emergency Mode active. This is a FPP defined parameter
Orange Flashing	Low Battery.

4 MAIN SCREEN

4.1 DEFAULT SCREEN LAYOUT

The default screen layout is shown below in **Figure 6**.

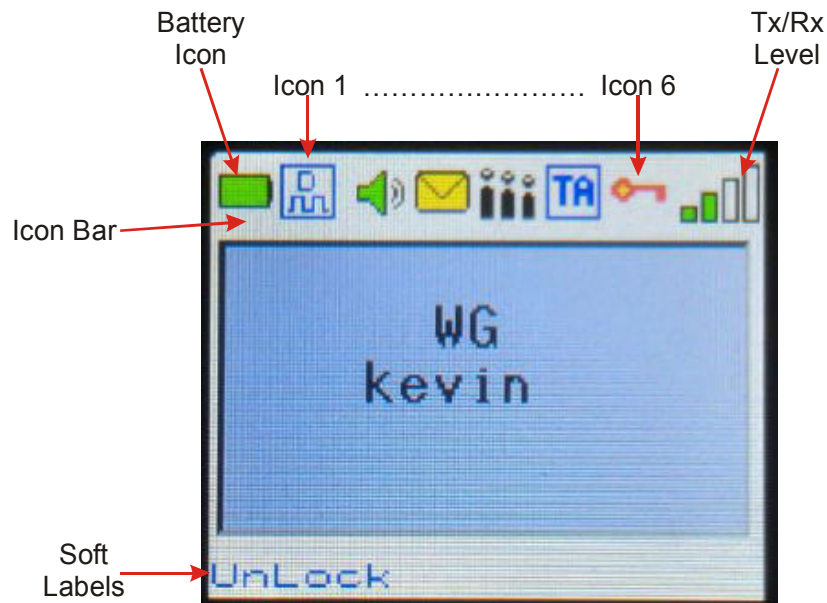

Figure 6. Default Screen Layout.

The screen has three main areas: the Icon Bar; the Text Panel; and the Soft Labels area.

4.1.1 Soft Labels

The bottom line of the display is used for the Soft Labels associated with the function buttons.

The soft label text is defined in the FPP and can be assigned to the F1, F4 and Nav-Select function buttons. Each soft label can be up to five characters.

4.1.2 Text Panel

The main area of the default screen is the Text Panel, which displays textual information in three lines. These three lines contain both Persistent and Non-persistent text information as follows:

- Text Line 1. Persistent Text, e.g. Zone name.
- Text Line 2. Persistent Text, e.g. Channel name.
- Text Line 3. Non-persistent Text messages, e.g. keypad dial string entries, received status/data messages, error messages, etc. (Messages are displayed for the 'Message Timeout' period, which is defined in the FPP).

4.1.3 Icons

The Icon bar is used to display the Standard and Special Icons.

















Standard **Icons** are displayed in six positions Icon 1 to Icon 6 as shown above. Therefore, up to six Icons can be displayed at once.

















The Special Icons include the:

- **Battery Icon.** This is always displayed on the default screen at the top left on the Icon bar. It indicates the condition of the battery.
- **Rx Signal Strength.** This is displayed on the default screen at the top right on the Icon bar. The stronger the Rx signal, the more bars will be displayed.
- **TX Level.** This is displayed on the default screen overwriting the RSSI icon at the top right on the icon bar. The icon indicates low, medium or high power.
- **Bar Icon.** This is displayed in the Text panel and is used as a temporary progress or level indicator.

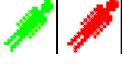
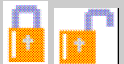
Details of the Icons that can be displayed on the Icon bar are contained below in **Table 5**.

Table 5. Icon Details.

Icon Position	ICON	INDICATION
Battery Icon		Indicates the condition of the battery. Always displayed on default screen.
Icon 1. (Channel Type)		DMR Icon. Displayed when DMR Channel selected.
		DMR Repeater Icon displayed when DMR Repeater channel selected
		Analogue Icon. Displayed when an Analogue Channel selected.
		Trunk Icon. Displayed when DMR Trunk Channel selected.
Icon 2 (Channel Activity)		Transmit indicator. Displayed when radio is transmitting.
		A filled speaker icon indicates that a signal is present and the radio is unmuted.
		The outline speaker icon indicates that a signal is present and the radio is muted. This could be another user group, for instance.
		Scan Indicator. When radio is on a scan channel and scanning, the arrow will rotate.
		Scanning Paused. Displayed if scanning 'Paused' function is enabled. Only displayed when channel is idle.
		Monitor. All digital radio signals on the channel will be heard.
		Normal Mode. Only radio signals from the users own network will be heard on the speaker.
		Selective Mode. Only radio signals specifically directed to the user or the channel's defined talk group will be heard on the speaker.
Icon 3		Envelope Icon. If icon is displayed, it indicates there are one or more unread received Status/Data messages.. Unread Status/Data messages can be viewed in the 'Messages' menu.
Icon 4 (Call Type)		Group Call. The call type displayed depends on the valid call type received or the call type associated with the selected Contacts entry.
		Individual Call.

Icon Position	ICON	INDICATION
Icon 4 (Call Type contd.)		Emergency Call.
		Individual Emergency.
		Priority Group Call.
		Priority Individual Call.
		All Call.
		Broadcast Call.
		OVCM Group Call.
		OVCM Individual Call.
		Data Call.
Icon 5 (Misc.)		Talk Around enabled. Talk Around is enabled for current channel only.
		Global Positioning System Icon. Icon will flash while waiting to acquire GPS location. Icon will be steady if location acquired.
		Lone Worker. When Lone Worker function enabled, it will display and start a countdown timer.
		Man Down. When 'Man Down' facility enabled, Icon will: Flash Green while calibrating and remembering the radio orientation. Steady Green once orientation has been remembered. Flash Red when the man-down sensor has detected a lack of motion, an impact to, or an abnormal orientation of the Radio.
Icon 6 (Misc.)		Encryption. If channel has digital encryption enabled or an encrypted digital signal is received, the padlock icon will be displayed. <i>For Future Development.</i>
		Keypad Locked. Displayed when the Keypad Locked function is enabled.
Tx/Rx Level		Received Signal Strength Indication (RSSI). The number of bars displayed corresponds to the received signal strength. 0 bars = -128 dBm. 4 bars = -103 dBm or stronger. Rx level is displayed while scanning.
		Displayed while Transmitting. Indicates the channel's power setting High/Medium/Low. If Low power override function enabled, the low power icon will be displayed. The actual power settings associated with H/M/L are defined in the FPP.
		
		
Bar Icon		Displayed in the Text panel as a temporary progress or level indicator, e.g. volume being changed. <i>Future: Display for Lone Worker time remaining.</i>

5 BASIC OPERATIONS

5.1 TURNING THE RADIO ON/OFF

To turn the radio On, press the Red handset button (F12), the initial opening screen will be displayed.

When the radio is switched on and power is applied, the radio displays 'Simoco Xd' while the DSP boots up the radio.



Figure 7. Initial Screen.

To turn the radio Off, press and hold the Red handset button for two seconds. When the button is released, the radio display will power down.

If the radio Inactivity Timer is enabled, the radio will automatically turn off after a predefined duration of inactivity as set by the FPP (i.e. no keys pressed). The radio will emit warning beeps for 10 seconds prior to switching off. Pressing any key will reset this timer.

5.2 ENTERING A PASSWORD

Within the FPP there is a 'Password' field. When this field is enabled and defined, the radio will wait for the user to enter the correct four digit Personal Identification Number (PIN) before entering an operational state.

When entering the password, only the numeric keys 0-9 can be used. An asterisk "*" will be displayed for each key press. After the 4th number is entered, the radio will automatically verify the number and, if correct, the radio will display the welcome screen.

If incorrect, the radio will sound an error beep and clear the entered PIN, to allow the user to try again.

If the wrong PIN is entered three times, the radio will switch off.

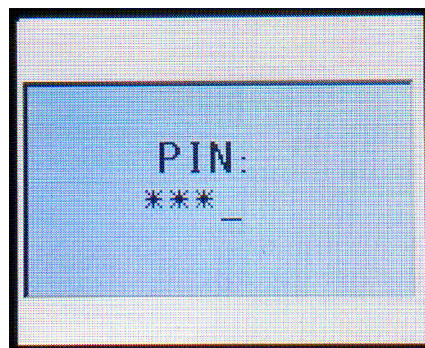

Figure 8. Password Screen.

5.3 WELCOME SCREEN

Within the FPP there is a 'Welcome Text' field, which enables a welcome message to be displayed on the screen when the radio is switched on. If the Welcome Text has been defined, the radio will display the welcome message and radio ID for two seconds while the radio initialises.

Note.

Use of a Welcome Text message will increase the power-on time by 2 seconds.

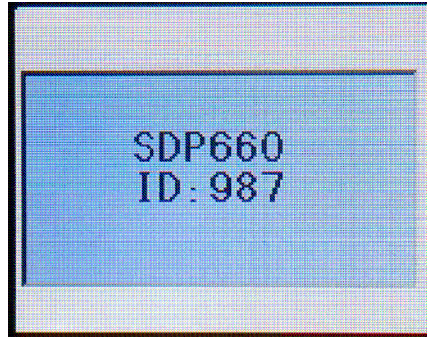

Figure 9. Welcome Screen (example).

5.4 LOCKING AND UNLOCKING THE KEYPAD

When the keypad is not in use it can be locked to prevent accidental keypad operation. This is known as the KeyLock facility.

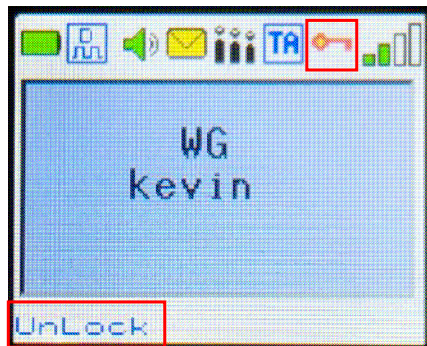

Figure 10. Default Screen with Keys Locked.

If the keypad is 'Locked', all the keys except PTT, Alarm, Reset and Unlock function are disabled.

When the keypad is locked, the radio will display the key icon on the icon bar and 'UnLock' above the F1 key.

To unlock the keypad, either of the following methods can be used:

- 1 By key combination.

Press the F1 key followed by the '*' key within 2 seconds. When the F1 key is pressed the radio will display 'Now Press *'. After the star key is pressed, the original F1 label will be redisplayed.

- 2 By using the function key.

The FPP has a 'Lock/Unlock' enable function that can be assigned to a function button. If this has been assigned, pressing the relevant function button will unlock the keypad.

The FPP also has an 'Auto-Lock Keys' option. When this is enabled, the keypad will lock automatically if there are no valid key press within the preset time period (normally 10 s).

The KeyLock feature does not affect display messages and icons.

5.5 ADJUSTING THE VOLUME

After turning the radio on, to adjust the volume, rotate the volume control knob clockwise to increase it or counter-clockwise to decrease it.

5.6 SELECTING A ZONE

The radio supports up to 40 zones.

Channels per zone should be dynamically allocated, ie. Flexible mix of zone sizes up to the total channel capacity. For example, of the 2000 channels, there may be 8 zones of 250 channels. Another configuration may have 40 zones of 50 channels. A zone can be selected by any of the following methods:

- 1 By menu selection.

Access the 'Zone' menu and use the ▲/▼ keys to select the desired zone.

- 2 By using the function keys.

In the FPP, the functions 'Zone Select Up' and 'Zone Select Down' can be assigned to function buttons. The desired zone can quickly be selected by pressing the relevant programmed button.

5.7 SELECTING A CHANNEL

A channel can be selected by any of the following methods:

- 1 By menu selection.

Access the 'Channel' menu and use the ▲/▼ keys to select the desired channel.

- 2 By using the function keys.

In the FPP, the functions 'Channel Up' and 'Channel Down' can be assigned to function buttons. The desired Channel can quickly be selected by pressing the relevant programmed button.

5.8 MAKING A CALL

Select the Zone/Channel required on which to make the call.

To avoid interfering with other users of the channel, listen first to ensure no other transmissions are occurring, or check that the speaker icon is not present.

If the speaker icon is shown, there are transmissions present on the channel and the user should not transmit. If required, the radio may be programmed to prevent transmission on a busy channel.

To transmit, to the selected channel's default radio talk group, hold the radio or microphone about 10 cm in front of the mouth and press the PTT switch. Wait until the radio indicates that the Tx is transmitting and then speak clearly in a normal conversational manner.

In most systems, it is good practice to wait a short time (0.5 secs) between pressing the PTT switch and commencing to speak. This allows the transmission path to be properly established (or not) and avoids lost or distorted speech.

On some channels, the radio may provide alert tones to indicate the success or failure of the establishment of the transmission path. Only speak after the tone indicating the transmission's successful establishment. The radio's LED will also turn **Red** to show that the transmitter is active and the display will also show the relevant transmission icon.

Use the correct operating procedure and keep transmissions as short as possible.

Release the PTT switch as soon as you have completed your message in order to hear any replies. The radio cannot listen and talk to groups simultaneously.

If you wish to talk to other groups or individuals these can be selected on the contact menu or dialled before pressing the PTT.

Note.

A Transmit Limit Timer may be setup that limits a continuous transmission on a channel. The last 10 seconds before the timer expires may be accompanied by warning beeps.

When transmitting a private call, the  icon will be displayed.

When transmitting a group call, the  icon will be displayed.



A call can be made as follows:

- 1 Through the Contact menu:
 - 1.1 Go to the 'Contact' menu.
 - 1.2 Use the ▲ and ▼ keys to select the contact you wish to call.
 - 1.3 Press the PTT key to transmit the call.
- 2 Through manually dialling the number.
 - 2.1 Use the keypad to enter the subscriber UID, TGID or dial stringnumber required and then press #.
 - 2.2 Press the PTT key to transmit the call.

5.9 RECEIVING A CALL

The Speaker Icon  will be displayed when a valid signal is being received and audio will be heard at the Loudspeaker.

The speaker icon will be shown as an outline when a signal is being received that is not addressing this radio and hence, is not audible. For instance, another user group may be having a conversation on another talk group when receiving in Selective Mute.

When receiving a private call, the  icon will be displayed. When receiving a group call, the  icon will be displayed.

When receiving a call, press the PTT key within the preset time period to call back.

9SCAN/ VOTING FUNCTIONS

The Scan Function allows the sequential searching of up to 16 channels, if the selected zone channel is programmed as a Scan channel, for a valid signal (Carrier + CTCSS/DCS tone for Analogue FM or Colour Code for DMR). When found, the radio will stop on that channel until the signal disappears again.

To activate Scanning, select a channel that has been programmed as a Scan channel. Once selected, the scanning will either start automatically, if programmed, or the programmed scan function button will need to be pressed. (FPP configurable).

While listening on the channel, the user is able to PTT on that channel. After the signal disappears, the radio will remain listening on the channel for a short time (FPP configurable, typically 4 seconds for scanning and 2 seconds for voting) before resuming scanning.

A Priority Channel may only be assigned to a Scan group.

If a Priority Channel is assigned to Scan mode, the radio will interleave a check of this channel between each normal Scan channel. The radio may also check the Priority Channel every few seconds while stopped on a channel. If a signal is found on the Priority Channel then the radio will switch to that channel immediately.

5.9.1 Scan/ Voting Screen

A Scan can be started by:

1. Pressing the function key that has been assigned the scan function by the FPP; or
2. Selecting a zone channel that has been assigned to automatically scan by the FPP; or
3. Selecting the SCAN ON option under the 'User Options' menu.

The top line of the display still shows the name of the current selected channel. The second line of the display shows the name of the current selected zone while scanning/voting.

The Channel can be changed by using the ▼ and ▲ keys. Other channels may be either Scan or Normal channels, depending on the radio's configuration.

Scanning is indicated by a rotating arrow symbol.

When scanning stops on a channel, on the screen, the second line from the top shows the name of the channel from the scan group that the radio has stopped on. If stopped on a channel, that channel can be "skipped" by pressing the programmed skip function key. Once a channel is "skipped" it will not be scanned for the duration that Zone/Channel selection.

When transmitting on a channel, the second line of the display shows the name of the current channel that the radio is transmitting on.

5.10 EMERGENCY ALARM

5.10.1 Making an Emergency Call

When the emergency key is pressed and held for a time determined by the FPP, the radio will change to emergency mode. Under emergency mode, the radio can operate in three FPP configurable modes:

- **Frozen.** The screen will freeze in the state it was in before the emergency mode became active. The Emergency mode icon will be displayed. 
- **Blank.** The screen will blank giving no indication to others that the radio is in emergency mode.

When emergency mode is triggered, the radio can be configured by the FPP to transmit and receive on a cyclic basis with FPP programmed time periods.

During Tx, the radio will generate an emergency broadcast call on either the currently selected channel or an FPP nominated channel.

Others may listen to the automatic transmissions to hear conversations near the radio.

The power button is not operable in emergency alarm mode.

The radio can be programmed to exit emergency alarm mode when the number of programmed cycles is completed or to remain in emergency alarm mode. To terminate the emergency alarm mode, the battery must be disconnected and re-connected.

6 MENU SYSTEM

This section details the operation of the menu system for the SDP660 Portable Radios.

The SDP660 radio software uses a programmed menu structure to enable the operator to access the radio options. The structure of the menu can be configured using the FPP to meet a customer's specific needs. In simple configurations, no menu can be programmed. An example menu structure for a radio is illustrated overleaf in **Figure 11**.

Pressing the 'F1' key from the top-level channel screen enters the menu system. By default this key has a soft menu label alongside it titled 'MENU'. The soft key 'F4' is generally the 'Back' key.

The possible menus are:

- Channel.
- Zone (this is usually the first menu as it is often accessed).
- Contact.
- Radio Info.
- Mute Adjust
- User Options.
- Settings.
- Backlight.
- Brightness.
- Contrast.
- Key Beeps.
- Speaker Volume.
- Alert Volume
- Text Message.
- GPS
- RSSI
- Scan
- Talk Groups

The presence and order of the above menu selections is determined by the FPP configuration.

The **Settings** menu is a special case entry. **Settings** is a subgroup that can have any of the list of menu selections assigned to it. This means that, if required, the lesser used selections can be partly hidden away under the Settings subgroup but still remain accessible.

The order and presence of the Settings subgroup selections is determined by the FPP. For instance **Info**, **Radio Status** and **Contrast** could be placed under Settings.

The **Options** menu group is also a menu subgroup. This subgroup contains the five configuration options of: Backlight; Brightness; Speaker Volume; Alert Volume; and Key Beeps.

6.1 MENU NAVIGATION

Pressing the ‘Menu’ (F1) key selects Menu mode from the main Channel Screen. Once in menu mode, the ▼ and ▲ keys scroll through the menus.

To exit Menu mode, press the ‘Back’ (F4) key or the Menu timeout will exit automatically. Generally, pressing ‘Back’ key while in a menu backs up to the next highest level of menu and the ‘Select’ (Nav Select) button selects the menu option.

The ▼ and ▲ keys are used to navigate through a list of options such as channels, or to increase/decrease a value.

Note: Example menus only shown.
Other Menus may be configured with the FPP.

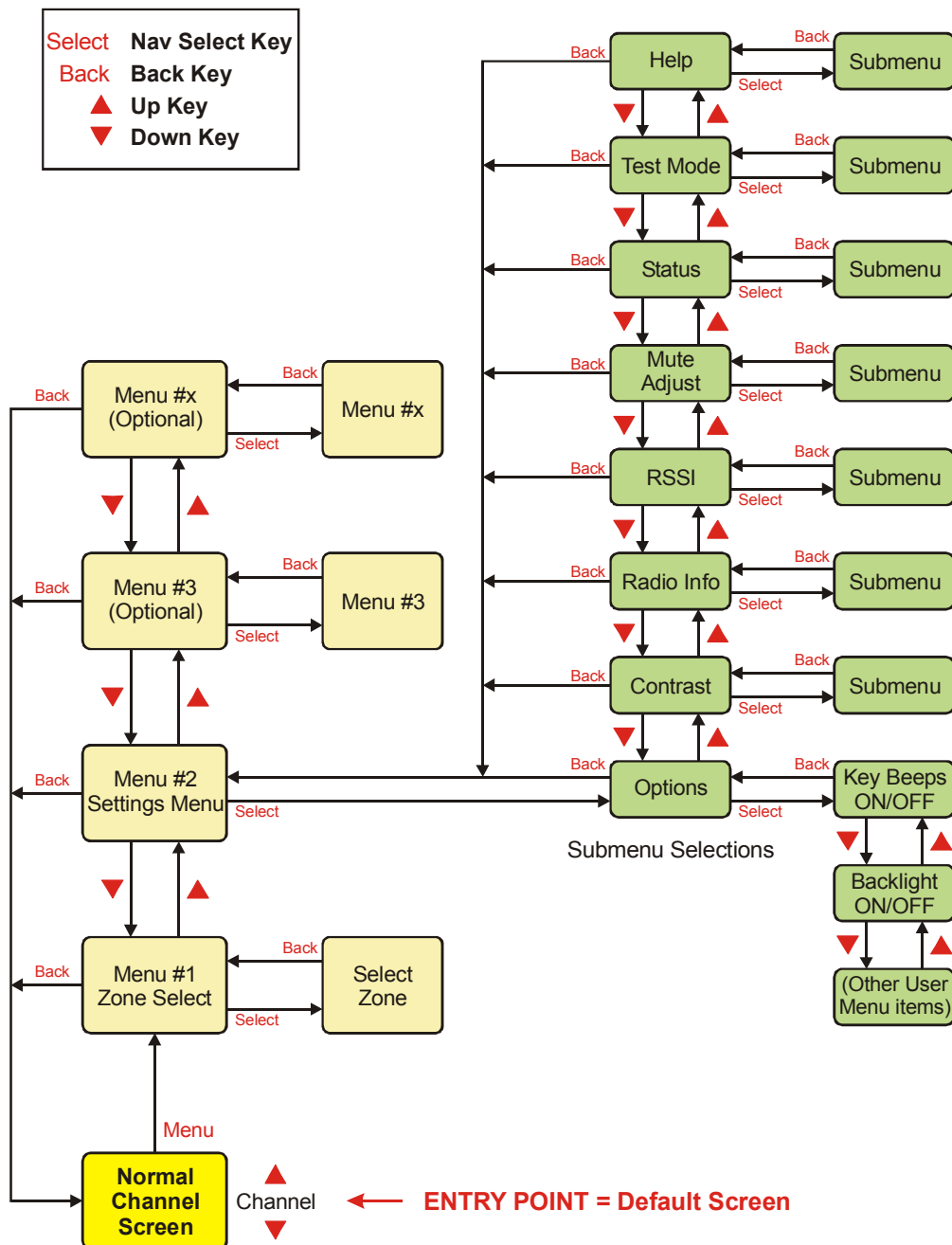

Figure 11. Menu Navigation (example).

7 MENU SCREENS

The menu structure on the SDP660 Portable Radio is configurable using the FPP. A system administrator usually tailors the order and presence of the menu options to specific customer requirements.

This section describes all the menus that are currently available.

Normally, the menus are divided into three menu lists. These are the Main Menu list, the Settings Menu list and the Options Menu list.

In the default configuration, the Main menu contains the Channel, Zone and Settings menus. This allows access to the second 'Settings' menu level.

The Main Menu can be accessed from the main default screen by selecting the 'Menu' (F1) button.

To access any of the menu options from the Main, Settings or Options Menus, use the ▲ and ▼ keys to scroll through the lists until the required menu option is selected with the leading pointer (>) and then press the 'Select' (Nav Select) button.

Pressing the 'Back' (F4) button at any point will go back to the previous screen.

7.1 CHANNELS MENU

The Channels menu allows the user to select the communication channel to be used within a Zone. An example of the Channels menu screen is shown below in **Figure 12**.

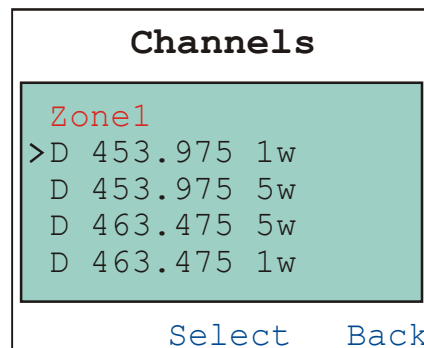

Figure 12. Channels Menu.

The Channel Screen shows the currently selected channel. To change to another channel, use the ▲ and ▼ keys or the Rotary Encoder to move the leading pointer to the required channel and press the 'Select' button.

The channel can also be changed from the main default screen simply by using the ▲ and ▼ keys

Radio channels may be configured with the FPP as specific frequencies or as auto-scan types. When an auto-scan channel is selected, it will immediately go into scan mode. Selecting another non-auto-scan channel will stop the scan.

7.2 ZONE MENU

The Zone menu is used for changing Zones. A Zone is normally defined as a group of radio channels with a common operational role.

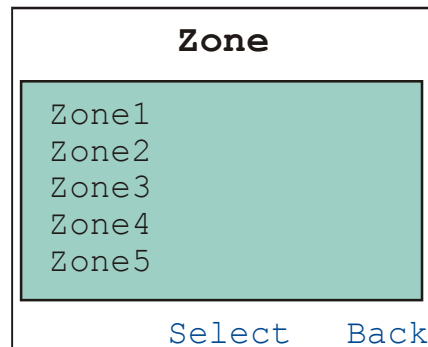

Figure 13. Zone Menu.

Once the 'Zone' menu appears, press the ▼ and ▲ keys to choose the required Zone. Press the 'Select' key to select the required Zone. The radio will return to the channel screen and select the first channel in the new Zone.

Direct access to the 'Zone' menu from other screens can also be programmed to one of the function buttons with the FPP.

7.3 SETTINGS MENU

The Settings Menu allows the user to access a programmable selection of the menu options from which they can edit/modify the operation of some of the general functions of the radio.

The Settings menu options can be programmed into the Settings menu with the FPP. The FPP User can choose to add any, all or none of the menu options to the Settings menu as required. If the Settings menu option is not included in the Main Menu list, the Settings Menu will not be accessible to the radio user.

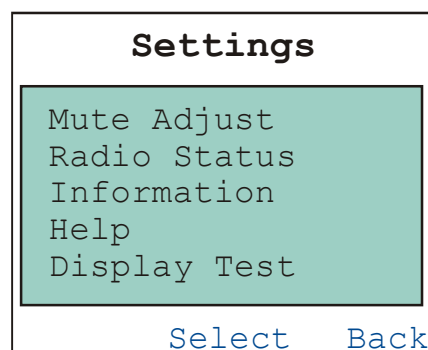

Figure 14. Settings Menu (example).

Using the ▼ and ▲ keys, cycle through the available Settings menus options. Press the 'Select' key to access the menu option required.

Using the ▼ and ▲ keys, scroll through the available Settings Sub-menus.

The Setup menu structure may include, for example:

- Information (Radio software and hardware information);
- Mute Adjust;

- Radio Status; or
- User Options.

7.4 OPTIONS MENU

The Options menu allows the user access to a preset selection of menu options for user radio interface configuration items. These include the backlight timeout period, the backlight brightness, speaker and alert tone volume control limitations, and the key beeps function.

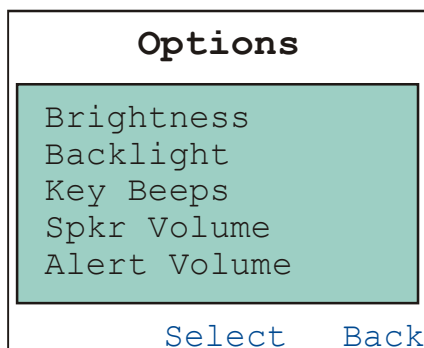

Figure 15. Options Menu.

Using the ▼ and ▲ keys, scroll through the available Options menu items. Press the 'Select' key to access the menu option required.

If required, these user option functions can also be assigned directly to the radio's function buttons.

Information on each of the Options menu items is contained later in this section.

7.5 CONTACTS MENU

The Contacts Menu allows user to select the communication entity they wish to call, e.g. individual radio unit (UID or SUID), talk group of radio units (TGID), dialled external network access gateway (phone, internet, other radio networks, dispatchers), and PABX/PSTN.

Up to 20 Contact Lists can be created and programmed into the Radio with the FPP. Each Contact List can have up to 600 entries. Each Contact List is assigned on a per "Channel" basis in the Zone set up section of the FPP.

Therefore, the Contact list displayed via the Contact menu is the Contact List assigned to the radio's currently selected Channel. This ensures that a user can't select a Contact who uses a different mode than the one selected.

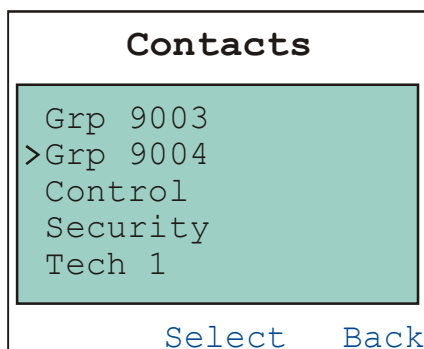

Figure 16. Contacts Menu.

Use the ▼ and ▲ keys to scroll through the available contacts. Pressing the 'Select' key will display the details for the selected contact (see **Figure 17** overleaf).

Pressing the PTT key will place a call to the selected contact.

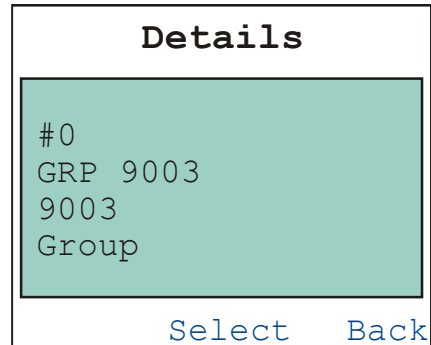

Figure 17. Individual contact details.

The details displayed for the contact are:

- #0 – The serial number of the contact list entry.
- GRP 9003 – Contact name.
- 9003 – The Contact number to dial (e.g. UID, TGID, dialstring, PSTN).
- Group – The type of contact (e.g. Individual, Group, PSTN)

7.6 INFORMATION MENU

The Information menu provides the User with information about the specific radio such as the Radio ID, Serial Number, Authorisations, Software Version, etc.

The Information menu is typically located under to Settings menu.

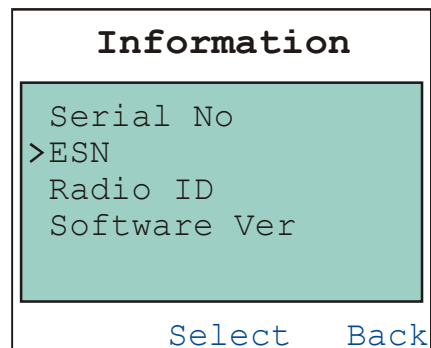

Figure 18. Information Menu.

Using the ▼ and ▲ keys, select a radio information item from the list. Press the 'Select' key to display the specific information screen. Examples are shown below in **Figure 19**.

The 'Radio Info' screens are read-only screens.

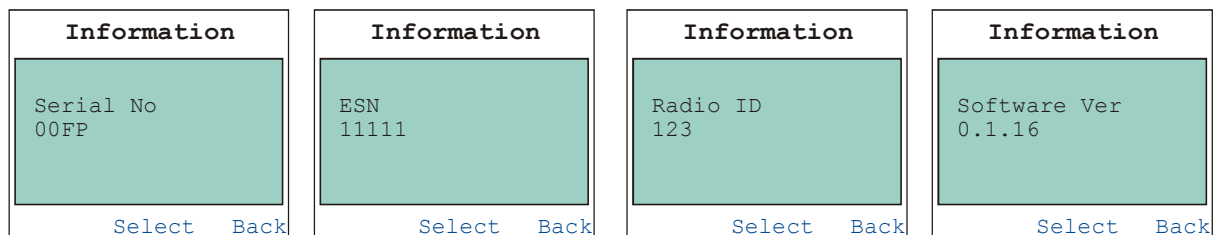



Figure 19. Radio Information Screens.

7.7 MESSAGES MENU

A radio unit can receive and transmit predefined short messages and text messages with another radio unit on a DMR channel.

The Messages menu allows the user to view a preset menu screen which allows the radio user to check the state of the various digital message systems in the radio. The message system sub-menus are: Inbox, Outbox, Send Status, Send Template, and New Message.

Received messages are stored in the 'Inbox'. Transmitted messages are stored in the 'Outbox'. Both can be viewed and deleted as required.

If there are unread messages stored in the radio, the  icon will be displayed on the default screen.

Use the ▼ and ▲ keys to scroll through the Messages menu options. Press the 'S' key to access the required option.

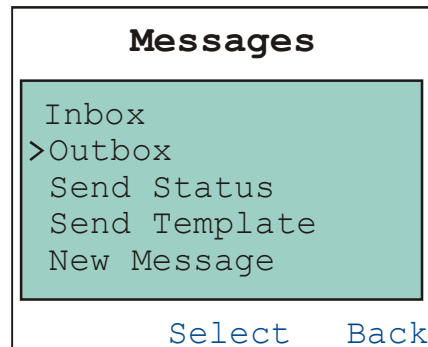

Figure 20. Messages Menu.

7.7.1 Inbox

The Inbox is used to store the received messages. Up to 20 messages can be stored in the Inbox. These messages are volatile, which means that, at radio start-up, the inbox will be empty.

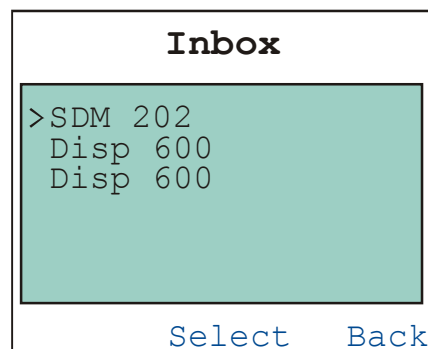

Figure 21. Messages – Inbox.

For each received message the Inbox displays either details of the sender from the Contacts list or, if the ID is not known to the Contact list, the sender UID. If no messages are stored, 'No Messages' is displayed.

To scroll through the stored messages, use the ▼ and ▲ keys.

Pressing the 'Select' key will display the selected Message. Pressing the 'Select' key again will give 'Reply' and 'Delete' options.

To return to the Messages Menu, press the 'Back' key.

7.7.2 Outbox

The Outbox is used to store the transmitted (sent) messages. Up to 20 messages can be stored in the outbox. These messages are volatile, which means that, at radio start-up, the outbox will be empty.

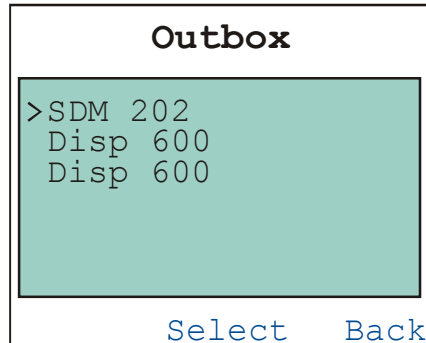

Figure 22. Messages – Outbox.

For each sent message, the Outbox displays either details of the recipient from the Contacts list or, if the ID is not known to the Contact list, the recipient's UID. If no messages are stored, 'No Messages' is displayed.

To scroll through the stored messages, use the ▼ and ▲ keys.

Pressing the 'Select' key will display the selected Message. Pressing the 'Select' key again will give 'Reply' and 'Delete' options.

To return to the Messages Menu, press the 'Back' key.

7.7.3 Send Status

The Send Status menu option can be used to send a short Status message to another party. Up to 10 Status lists, each containing up to 250 status message entries can be created and pre-programmed into the radio using the FPP. Each status message entry consists of a unique Number and Text. Each Number may range from 0 to 1023. One status list may be attached to each zone-channel.

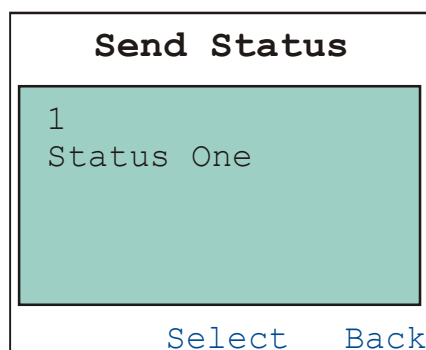

Figure 23. Messages – Send Status.

The information displayed on the Send Status message screen shows the unique number and the text of the status message.

To select a different Status message, use the ▼ and ▲ keys to scroll through the programmed status messages. Each Status message will be displayed in turn.

Press the 'Back' key to return to the previous screen.

Press the 'Select' key to display the Send screen, which allows you to select a Contact from the Contacts menu. See **Para 6.7.6 – Sending Status, Template and Text Messages** for further information.

7.7.4 Send Template

The Send Template menu option can be used to send a pre-formed message. Up to 100 template messages may be configured by the FPP. Each template is a pre-formed message text.

The Send Template menu is only displayed if the FPP has configured one or more templates.

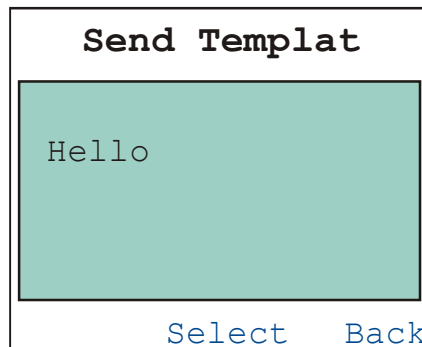

Figure 24. Messages – Send Template.

To select a different Template message, use the ▼ and ▲ keys to scroll through the programmed messages.

Press the 'Select' key to display the Send screen, which allows you to select a Contact from the Contacts menu. See **Para 6.7.6 – Sending Status, Template and Text Messages** for further information.

7.7.5 New Message

The New Message menu option can be used to create, edit and send short text messages.

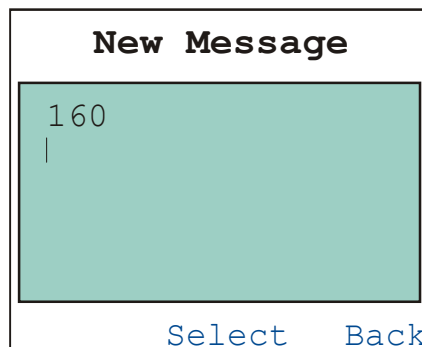

Figure 25. Messages – New Message.

Each message can be up to 160 characters in length. The number of remaining characters that can be entered is displayed above the message.

Text characters are entered using the keypad. Each keypad button is labelled with up to 4 text characters (e.g. 7 = PQRS). The text characters are entered by pressing the keypad once for the first character, twice for the second, and three times for the third, and so on.

After a short delay, the cursor will advance to the next character entry. Entered characters are inserted immediately to the right of the cursor.

Punctuation characters (full stop, comma, question mark, etc) are entered using the # key. A space is entered with the * key.

Each line displays up to 12 characters. Up to five lines can be displayed at once. If more than five lines of text are entered, the lines will be scrolled up.

The text used in the message is lowercase, left justified.

The ◀ and ▶ keys are used to scroll the cursor left or right.

A double press of the '#' key will erase the character to the left of the cursor. A double press of the '*' key will erase the complete message.

Press the 'Back' key to return to the previous screen.

Press the 'Select' key to display the Send screen, which allows you to select a Contact from the Contacts menu. See **Para 6.7.6 – Sending Status, Template and Text Messages** below for further information.

7.7.6 Sending Status, Template and Text Messages

To send Status, Template and Text Messages carry out the following:

- 1 When the message has been selected/created and is ready to be sent, press the 'Select' key to display the Send screen (see **Figure 26** below).
- 2 On the Send screen, use the ▲ and ▼ keys to select the 'Contact' option. Press the 'Select' key. An individual Contact Details screen from the Contact List will be displayed (see **Figure 17**).
- 3 To select a different contact than the one displayed, use the ▲ and ▼ keys.
- 4 With the correct Contact displayed, press the 'Select' key to send the message.
- 5 Short messages confirming that the message is being sent and that delivery has been successful or that delivery has failed will be displayed.

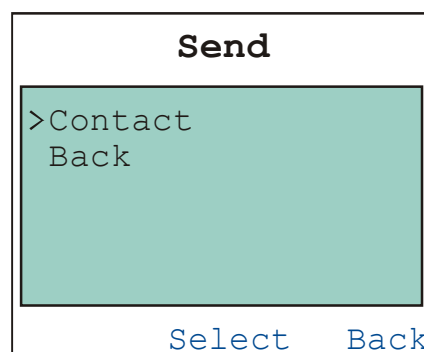

Figure 26. Send Message Screen.

7.7.7 Viewing Received Messages

When selected, the details of received messages (status, template and text messages) stored in the Inbox will be displayed on the Message View screen.

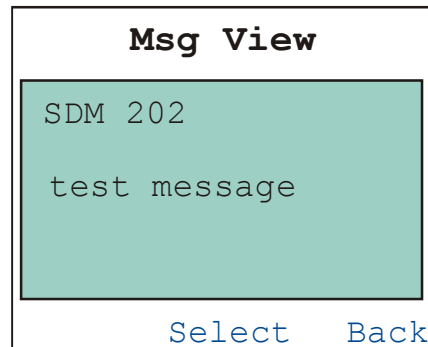

Figure 27. Message View Screen.

The information displayed for each message includes: either the name of the sender from the Contacts list or, if the ID is not known to the Contact list, the sender ID; and the first two lines of the messages in text string.

Pressing the 'Select' key will display further message options (see **Figure 28**). Pressing the 'Back' key will return to the Message Inbox.

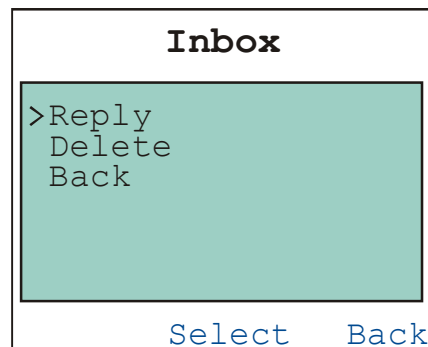

Figure 28. Message Options Screen.

The message options are:

- **Reply:** This will open a text Message screen in order to reply to the selected message.
- **Delete:** This will delete the received message.
- **Back:** This will return to the message inbox.

The 'Delete' and 'Back' options are also available when a message in the Outbox is viewed.

7.8 MUTE ADJUST MENU

The Mute Adjust menu allows the user to select the threshold at which the radio makes weaker or distorted received audio signals available to the user.

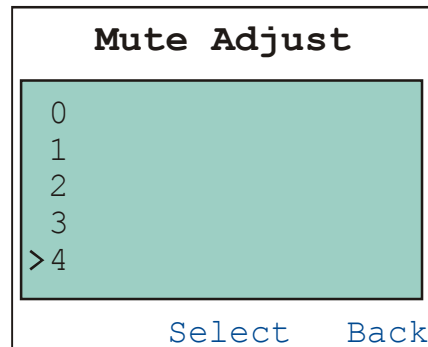

Figure 29. Mute Adjust Menu.

The default Mute Adjustment range is from 0 – 15. The mute adjustment setting will be applied to all the radio's analogue channels.

The SDP600 series radios have a carrier noise mute and it is recommended that a default mute setting of 4 is used. This means that, with a setting of 4, the mute will open at the point where an analogue signal is sufficiently noise free to be intelligible.

Other settings are as follows:

- **0** No muting. Allows all decodable signals to the radio user's audio output device (loudspeaker, headset etc.).
- **4** Normal default setting.
- **8** Only reasonably strong signals will be heard.
- **15** Only very strong or near perfect signals will be heard.

Use the ▼ and ▲ keys to adjust the mute threshold. Press the 'Select' key to save the selected mute setting and return to the previous menu level.

Direct access to the 'Mute Adjust' screen from other screens can also be programmed to one of the function buttons with the FPP.

7.9 BACKLIGHT MENU

The Backlight Menu allows the user to select the timeout period of the control unit's backlight. The 'Backlight' menu is located under the Options menu.

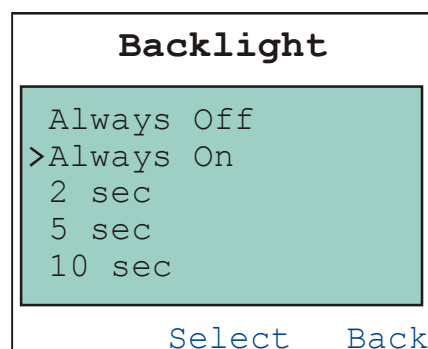

Figure 30. Backlight Menu.

When the Backlight is enabled, the control screen will be illuminated whenever there is any user activity. The backlight will remain on with no further user activity for the set period, after which, the backlight will turn off.

The maximum backlight timeout period is programmed by the FPP. The numerical values on the display are in seconds.

Note.

Received radio traffic events will not prevent the backlight timeout.

Use the ▼ and ▲ keys to select the required backlight timeout period.

To accept and save the setting and return to the previous screen, press the 'Select' key.

7.10 BRIGHTNESS MENU

The Brightness menu allows the User to set the intensity of the control unit's display and key backlighting where this is possible. The 'Brightness' menu is located under the Options menu.

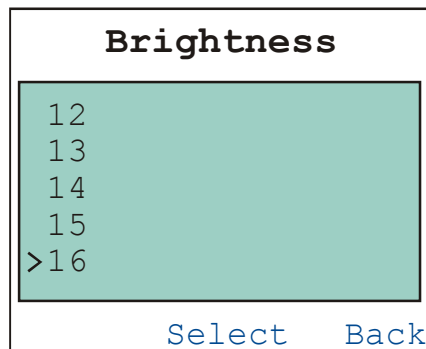

Figure 31. Brightness Menu.

Use the ▼ and ▲ keys to select the required brightness level.

To accept and save the setting and return to the previous screen, press the 'Select' key.

7.11 KEY BEEPS MENU

The Key Beeps Menu allows the user to enable or disable the acoustic feedback signals associated with pressing the function keys on the radio. The 'Keybeeps' menu is located under the Options menu.

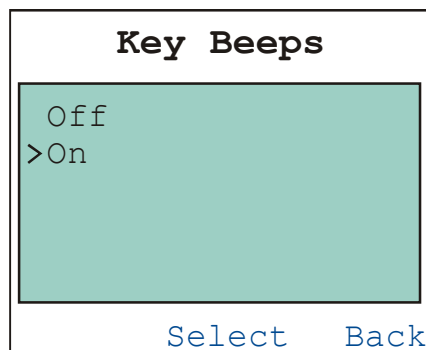

Figure 32. Key Beeps Menu.

Use the ▼ and ▲ keys to select the key beeps On or Off as required.

Press the 'Select' key to initiate the action and return to the previous screen.

7.12 SPEAKER VOLUME MENU

The Speaker Volume Menu allows the user to set the radio start-up value of the audio volume control for user comfort. The 'Speaker Volume' menu is located under the Options menu.

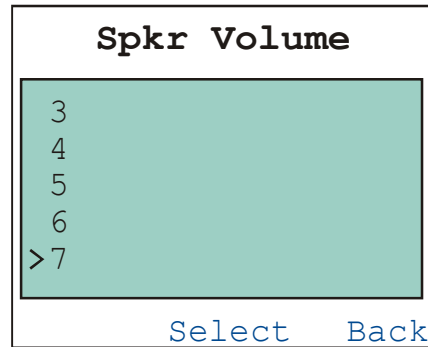

Figure 33. Speaker Volume Menu.

The level can be set in 33 steps over the range 0 to 32, with 0 (zero) delivering no sound, 16 is normal level and 32 giving the maximum possible output from the speaker.

Use the ▼ and ▲ keys to select the relative speaker volume level. A beep will sound at the indicated level each time the setting is changed.

To accept and save the setting and return to the previous screen, press the 'Select' key.

7.13 ALERT VOLUME MENU

The Alert Volume menu allows the user to set the offset of the Alert Volume in relation to the current Volume setting. Thus, the alert tones can be made louder or softer than the main voice audio.

The 'Alert Volume' menu is located under the Options menu.

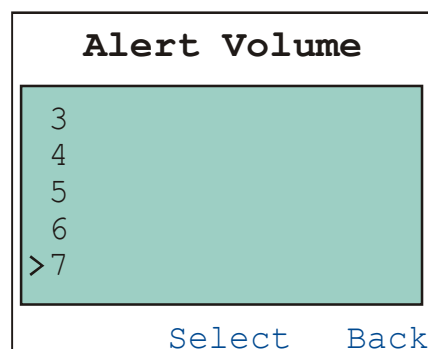

Figure 34. Alert Volume Menu.

The level can be set in 33 steps over the range 0 to 32, with 0 (zero) being about the same as the voice level.

Use the ▼ and ▲ keys to select the relative alert volume level. A beep will sound at the indicated level each time the setting is changed.

To accept and save the setting and return to the previous screen, press the 'S' key.

Note.

A minimum Alert Level may be set by the FPP to ensure that the Alerts can always be heard from the speaker.

7.14 RADIO STATUS MENU

The Radio Status menu allows the User to view the condition of various parameters for the radio. These include RSSI, Battery Level, Accelerometer Orientation and the GPS co-ordinates.

When accessed, the Radio Status menu will open on the RSSI screen. The other parameters can be viewed by using the ▼ and ▲ keys to select the required screen.

The Radio Status menu is typically located under to Settings menu.

7.14.1 RSSI

The RSSI screen displays the signal quality parameters of the received RF signal. The current display is in dBm re 50 Ω and 1 mW, and the reading is typically accurate to within ± 2 dBm between -120 dBm and -50 dBm, if the radio has been correctly calibrated. For example, -90 dBm is a strong signal and -130 dBm is no signal.

The RSSI screen will also display the Bit Error Rate (BER) for slots one and two. RSSI and BER are typically used to indicate signal quality.

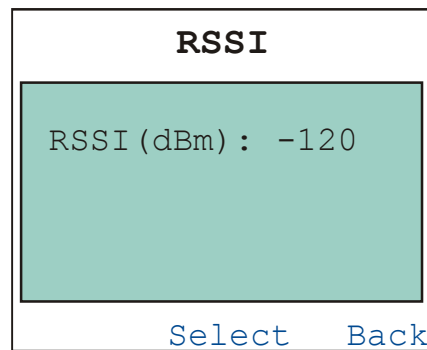

Figure 35. Radio Status Menu – RSSI Screen.

The RSSI/BER will be displayed until either the 'Back' key is pressed to return to the next highest menu level or the 'Select' key is pressed which will return to the main channel menu.

7.14.2 Battery Level

The Battery Level screen displays details of the battery fitted to the radio. The details displayed include the type of battery, the rating of the battery in milliampere-hours, and the usage time left for the battery.

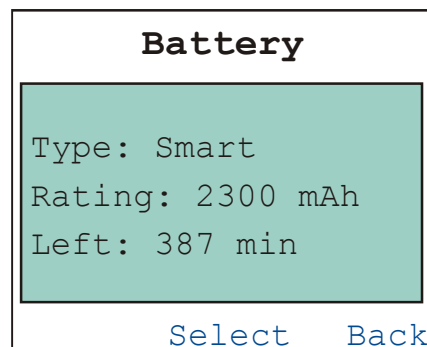

Figure 36. Radio Status Menu – Battery Level Screen.

7.14.3 Accelerometer Orientation

The Accelerometer Orientation is used during the Man Down mode. The Accelerometer Orientation screen displays the “raw” data from the accelerometer so its functionality can be checked.

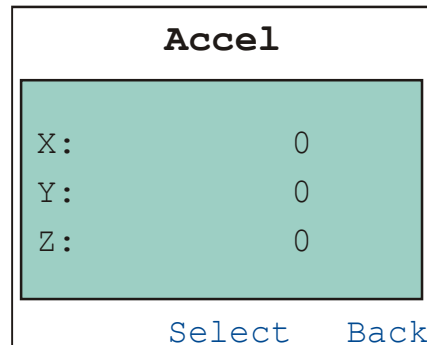

Figure 37. Radio Status Menu – Accelerometer Orientation Screen.

During the Man Down “initialisation period”, the screen displays the three measured axis (left-right, up-down and front-back) of acceleration of the radio. During this “initialisation period”, it is important that the radio be held in the position that it will normally be worn in order to “train” the radio with its normal orientation. Consequently, any significant deviation from this remembered orientation will be sensed. The display should read 0, 0, 0 when in its trained position.

7.14.4 GPS

The GPS screen displays the GPS co-ordinates (Latitude and Longitude) for the location of the radio. It also shows the age (time) since the GPS fix was obtained.

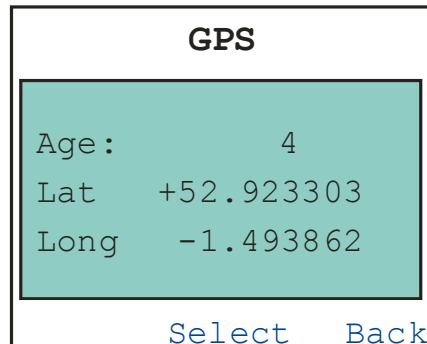

Figure 38. Radio Status Menu – GPS Screen.

7.15 SCAN MENU

The Scan menu allows the User to manually start and stop the channel scanning process on the current channel, if the channel is programmed as a “scan” channel in the FPP.

This Scan function can also be programmed to a toggle key.

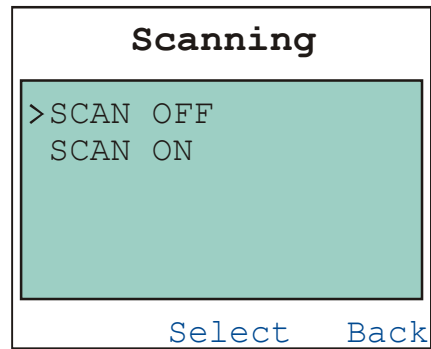

Figure 40. Scan Menu.

Use the ▼ and ▲ keys to select either the Scan On or Scan Off function. Press the 'Select' key initiate the action.

7.16 DISPLAY TEST

The Display Test Menu allows the user to set the select various test that will check different aspects of the radio's display.

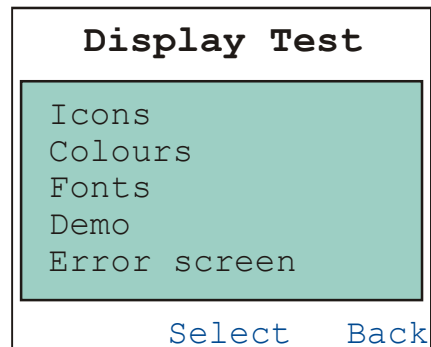

Figure 42. Display Test Menu.

Use the ▼ and ▲ keys to select the required test. Press the 'Select' key initiate the test.

Press the 'Back' key to end the test and return to the Display Test menu.

Display test that are currently available include:

- Icons;
- Colours;
- Fonts;
- Font Small;
- Font Medium;
- Font Large;
- Big X;
- Blank;
- Demo; and
- Error Screen.

8 SPECIAL FUNCTIONS

Special functions can be programmed to each of the keys/buttons on the SDP660 Portable Radio by the FPP. These special functions can be simple short cuts to specific menus or an on/off toggle facility for specific actions.

8.1 CHANNEL UP AND DOWN

These function keys will change the channel in the upward or downward directions.

8.2 ZONE UP AND DOWN

These function keys will change the zone in the upward or downward directions.

8.3 SCAN ON/OFF

These function keys will start and stop Scanning.

8.4 SKIP

The Skip function removes a scan channel from the scan list if the Skip button is pressed while stopped on that channel. The channel is only restored to the list when the channel is re-selected.

8.5 TALK AROUND ON/OFF

On a repeater channel only, a Talk Around function key allows the radio to transmit on the base station's output channel, so the user can talk directly to other radios on the channel, while the repeater is out of service or out of range.

When the key is pressed again (or the Channel is changed) the mobile's Tx channel reverts to its normal setting.

Talk Around mode is indicating to the user by a double beep at the start of each PTT.

8.6 LOW POWER

The Low Power function key forces the radio to low power. Pressing the function button again puts the radio back to the power level defined for the current channel. The "forced low power state" is not affected by channel/zone changes.

8.7 GO TO CHANNEL A, B, C OR D

This function allows specific zones and channels to be allocated to the keys rather than having to navigate through the menu system or using the ▲ and ▼ buttons.

8.7.1 Go To Contact A, B,C or D

This function allows the first four contact entries to be allocated to the keys rather than having to navigate through the menu system.

8.8 MENU

The Menu function key is used for accessing the menu system.

8.9 ZONE, CHANNEL, CONTACT AND MUTE

These are specific functions that provide direct access to the 'Channel', 'Zone', 'Contact' and 'Mute Adjust' menus.

8.10 RESET

The Reset function is usually assigned to the F6 key, and is used as a cancel function when in a menu or as a backspace when entering keypad dial-strings.

8.11 SPEAKER MUTE

The speaker mute function key will mute the audio output to the speaker. Pressing the function button again will again allow audio to be heard at the speaker.

8.12 MAN DOWN

The Man Down function provides support for the radio's automatic alarm sequence to be executed if the radio's inbuilt accelerometer senses certain unusual patterns in the orientation and movement of the radio.

The detection process uses an orientation "learning" period, immediately after the man down function is enabled, to establish the how the radio is normally held.

Once this is established, any significant and prolonged deviation from this orientation or an unexpected acceleration is considered to be an alarm event.

The radio also senses normal walking movement. If this stops for a period of time, this is also considered an alarm event.

Once the Man Down function is triggered, a warning beep will sound and the operator has a set time to disarm the sending of an Alarm Status using a programmed "Man Down" button (see buttons).

The Man Down system sequence is:

- Radio's man down system is enabled by selecting the Man Down function by pressing the allocated Man Down button.
- Radio uses a 3D accelerometer to determine the direction of the gravity's 1 g downward acceleration. The direction of this force is averaged during the "training" time.
- Once trained, the gravity component of the acceleration is removed, leaving only movement, impacts and mis-orientation acceleration to be sensed.
- User movement is monitored for the normal patterns of acceleration associated with the walking movement.
- Mis-orientation is indicated by the gravity force not being cancelled by the "trained" counter-force.
- Falls, impacts and other unexpected trauma can be sensed by sudden accelerations that exceed the force of gravity.
- If any of these events occur, the Man Down audible alert is triggered.
- The user has the set time to cancel the alert or the radio will enter the emergency alarm mode (see Alarm).
- Then the Man Down system uses the radio's emergency automatic voice transmission sequencer, programmed by the Alarm settings, to monitor the audio at the scene of the incident.

8.13 LONE WORKER

Lone Worker is used to initiate emergency alarm mode when the user is unresponsive after a predetermined time. A data message is also sent to the device management software (via the gateway) indicating that the worker may be incapacitated.

The Lone Worker countdown is reset after any user activity with the radio- either PTT or “Lone Worker” button are pressed

8.14 DMR ALL CALL DIAL STRING

This function is used as a short sequence of key presses for “All Call” dial string (*****#). In order to initiate All Call, the user should press PTT within 5 seconds after “DMR All Call” button is pressed.

9 DIAL STRINGS

The dial plan specifies the sequence of key-presses which may be entered by the user via the SDP660 to initiate connectivity to a remote party using another terminal in the network. Additionally, dial strings may be entered to alter a terminal's behaviour or configuration without initiating a call.

Dial strings may be entered via the keypad or stored in the contacts lists

9.1 Call Initiation Formats

These dial string specifications are used to initiate calls to remote parties.

Type	Dial string	Notes
Individual call.	nnnnnnn#	nnnnnnn may be less than 7 digits for abbreviated dialling (more significant digits come from dialling unit's own address)
All Call – All units	*****#	

9.2 Call modifiers

Dial string modifiers are used to alter the attributes of a call. They are prefixed to a dialled number. Modifiers. 1,5,6,8 and 9 may be combined. 8 and 9 are mutually exclusive. Eg: #81*nn...#

Call type	Dial string	Notes
Status Call	#0ss*nn...n#	ss = status number
Broadcast call	#1*gg...g#	gg.. = TGID destination, may contain * digits
Open Channel Voice Mode	#5*nn..n#	
Force talkgroup service	#6*nn..n#	
Highest priority call	#8*nn...n#	Places the highest priority call (priority 3)
Emergency Call	#9*nn..#	

9.3 MS Behaviour commands

These dial strings don't initiate a call, they modify the units configuration or behaviour in some way.

Type	Dial string	Notes
Cancel pending call request or cancel existing call	##	
Display own identity	#48*# or #48#	
Display own talkgroup table	#49*# or #49#	Displays the current talkgroup table (the list of IDs considered to be group addresses). A scrollable list of group IDs are displayed on the radio's screen. First implemented in Firmware release the R1.1 release series (R1.1.x for SDP600)

10 ACCESSORIES

The accessories that are available for the SDP660 Portable Radio are listed below in **Table 6**. Contact Simoco for further information.

Table 6. SDP660 DMR Portable Radio Accessories.

Part No.	Description	Notes
PAR-600BATL2	SDP Standard 2200 mAh Li-ion Battery	
PAR-600BATL3*	SDP High Capacity 3000 mAh Li-ion Battery	* Available Q2 2013
PAR-9180LMS2-2	Speaker Microphone with two buttons	Combined speaker and microphone for light duty use incorporating two programmable function keys.
PAR-600LMS4	Speaker Microphone with four buttons	Combined medium duty speaker and microphone incorporating four programmable function keys.
PAR-9180LMW1	Speaker Microphone – IP67	
TBC*	SDP Standard Case	* Available Q2 2013
TBC*	SDP Heavy Duty Case	* Available Q2 2013
PAR-600CRG1	SDP Single Charger Unit Excludes Power Supply (PA-ADAPTOR)	Charger capable of charging one portable radio at a time.
PA-ADAPTOR-UK	SDP Single Charger PSU UK	230 V AC with 3 pin UK fitting
PA-ADAPTOR-EU	SDP Single Charger PSU EU	230 V AC with 3 pin EU fitting
PA-ADAPTOR-SA	SDP Single Charger PSU SA	230 V AC with 3 pin SA fitting
PA-PSU1A5	SDP Single Charger PSU	Excludes Mains Cord (PA-ACCORD-XX8)
PAR-600CRG2	SDP Dual Charger Unit Excludes Power Supply (PA-PSU3A0)	Charger for two portable radios
PA-PSU-3A5	SDP Dual Charger PSU	
PA-ACCORD-UK8	UK Mains Cord for PA-PSU3A0	IEC C7 to UK 3 Pin, 1.8 m
PA-ACCORD-EU8	EU Mains Cord for PA-PSU3A0	IEC C7 to Euro 2 Pin, 1.8 m
PA-ACCORD-SA8	SA Mains Cord for PA-PSU3A0	IEC C7 to SA 3 Pin, 1.8 m
PAR-600GRG6*	SDP Six Way Charger with separate Power Supply	Charger for up to six portable radios. * Available Q2 2013
6102 500 00531	VHF helical Stubby Antenna	136 MHz – 174 MHz. * Available Q2 2013
6102 500 00541*	VHF Moulded Helical Antenna	Un-cut 136 Mhz – 174 MHz (includes cutting chart). * Available Q2 2013
6102 500 00431	UHF Whip Antenna ¼ Wave	400 MHz – 480 MHz (Green)
6102 500 00441	UHF Helical Antenna	400 MHz – 440 MHz (Orange)
6102 500 00451	UHF Helical Antenna	435 MHz – 485 MHz (White)
PAR-600CLIP	SDP 2.5" Belt Clip	Belt Clip for belt widths of up to 50 mm. The clip slots onto the rear of the battery.
PA-LMEP	SDP 1 wire Surveillance Kit	(Rx only)
PA-ACON	SDP Antenna to BNC Adapter	

Part No.	Description	Notes
PAR-9180PRLDU	SDP Programming Lead USB	Universal Serial Bus (USB) programming lead for use with the FPP when configuring the radio.
SA-600IMD	Intelligent Man-Down License	
SA-600MST*	Multi-Site Trunking License	* Available Q2 2013

APPENDIX A

ALERT TONES AND MESSAGES

ALERT TONES

The Alert Tones supported by the SDP600 Series Portable Radio are listed below in **Table A1**.

Table A1. Alert Tones.

Tone	Frequency, Tone Duration, Repeats	Description
Key Beep	940 Hz 60 ms	Generated by key presses. Key Beeps can be enabled or disabled in the FPP. Also used when Rotary Knob is changed.
Error Beep	440 Hz 50 ms x5	Generated by invalid key or unsuccessful radio events.
Normal Alert	440 Hz 320 ms	If attempt to skip channel if only 1 remaining channel in scan group.
Power-Off Complete	880 Hz 1 sec	Alert tone generated after radio saves its data and is ready to power down.
PTT Grant	1000 Hz 30 ms	Generated after PTT request granted and radio starts transmitting.
Call Alert	2000 Hz 100 ms x5	When receiving a message.
Emergency	600 Hz 160 ms, 1800 Hz 100 ms	Generate a short confidence beep when alarm mode is activated. This short beep can be enabled/disabled in FPP.
Man Down	1000 Hz 100 ms, 1152 Hz 100 ms 1400 Hz 100 ms, 1600 Hz 100 ms	Generate at low volume during after FPP defined 'Tilt Delay'. If Man-Down still down, then generate at full volume for FPP defined 'Alert Delay' period.
Times Up Alert	(940 Hz 60 ms, 0 Hz 1 sec) x5	5 short beeps repeated at 1 second intervals. Used 5 sec before Transmit limit timer expires and 5 sec before Lone Worker time limit expires.



SIMOCO GROUP

Global Headquarters: Field House, Uttoxeter Old Road, Derby DE1 1NH

UK: Tel: 08717 411 050
Fax: 08717 411 049

International: Tel: +44 (0) 1332 375 671
Fax: +44 (0) 1332 375 672

www.simocogroup.com