



SDP650 PORTABLE RADIO

USER MANUAL

TNM-U-E-0115, Issue – 1.4
June 2015



Field House,
Uttoxeter Old Road
Derby
DE1 1NH
Tel: +44 (0) 1332 375500
FAX: +44 (0) 1332 375501
<http://www.simocogroup.com>



1270 Ferntree Gully Road,
Scoresby
Victoria, 3179
Australia
Tel: +61 (0)3 9730 3999
FAX: +61 (0)3 9730 3988
<http://www.simocogroup.com>

© Simoco 2015

PREFACE

DECLARATION

This User Manual covers the Digital Mobile Radio (DMR) Operating Instructions for the SDP650 Portable Radio Transceiver.

Any performance figures quoted are subject to normal manufacturing and service tolerances. The right is reserved to alter the equipment described in this manual in the light of future technical development.

Changes or modifications not expressly approved by the party responsible for compliance could void the user's authority to operate the equipment.

COPYRIGHT

All information contained in this document is the property of Simoco. All rights are reserved. This document may not, in whole or in part, be copied, photocopied, reproduced, translated, stored, or reduced to any electronic medium or machine-readable form, without prior written permission from Simoco.

COMPUTER SOFTWARE COPYRIGHTS

The AMBE+2™ voice coding Technology embodied in this product is protected by intellectual property rights including patent rights, copyrights and trade secrets of Digital Voice Systems, Inc. This voice coding Technology is licensed solely for use within this Communications Equipment. The user of this Technology is explicitly prohibited from attempting to extract, remove, decompile, reverse engineer, or disassemble the Object Code, or in any other way convert the Object Code into a human-readable form. U.S. Patent Nos. #6,912,495 B2, #6,199,037 B1, #5,870,405, #5,826,222, #5,754,974, #5,701,390, #5,715,365, #5,649,050, #5,630,011, #5,581,656, #5,517,511, #5,491,772, #5,247,579, #5,226,084 and #5,195,166.

DISCLAIMER

There are no warranties extended or granted by this document. Simoco accepts no responsibility for damage arising from use of the information contained in the document or of the equipment and software it describes. It is the responsibility of the user to ensure that use of such information, equipment and software complies with the laws, rules and regulations of the applicable jurisdictions.

EQUIPMENT AND MANUAL UPDATES

In the interests of improving the performance, reliability or servicing of the equipment, Simoco reserves the right to update the equipment or this document or both without prior notice.

ERRORS AND OMISSIONS

The usefulness of this publication depends upon the accuracy and completeness of the information contained within it. Whilst every endeavour has been made to eliminate any errors, some may still exist. It is requested that any errors or omissions noted should be reported to either of the following who are part of the Simoco group:



Field House
Uttoxeter Old Road, Derby.
DE1 1NH. UK
Tel: +44 (0) 871 741 1050
E-mail: customer.service@simocogroup.com



1270 Ferntree Gully Road, Scoresby
Victoria. 3179
Australia
Tel: +61 (0)3 9730 3999
E-mail: inquiry.aus@simocogroup.com

DOCUMENT HISTORY

Issue	Date	Comments
1.0	January 2013	Initial Issue.
1.1	July 2013	Additional General Precaution added, plus changes to Support page email addresses.
1.2	August 2013	
1.3	October 2013	Details of Technical Support Ticket System added to Support page.
1.4	9 June 2015	FCC Part 15 Compliance added to WARNINGS page, plus changes to RF Exposure Compliance Distances for Bodyworn applications (Table 1). Details of Duplex Operation included (Section 4.9).

RELATED DOCUMENTS

1. **TNM-M-E-0033. SDP600 Series DMR Portable Radio Transceivers – Service Manual.**
2. **TNM-U-E-0117. SDP650 Portable Radio – Brief User Guide.**
3. **TNM-U-E-0118. PAR-600CRG1 Single Rapid Charger – SDP650/660 Instruction Manual.**

To order printed copies of this or any of the above publications, please contact Simoco. See the **Support** page for contact information.

A comprehensive list of documentation is available for download on the Simoco website <http://www.simocogroup.com> via the Partner Portal.

TABLE OF CONTENTS

Page

Title Page	1
Preface	2
Table of Contents (This List)	4
List of Figures	6
List of Tables	6
Personal Safety	7
Warnings	7
Compliance with RF Energy Exposure Guidelines (United States and Canada).....	9
General Notes	12
Simoco Support	13
Abbreviations	15
Glossary	16
1 INTRODUCTION	17
1.1 OVERVIEW.....	17
1.2 CONFIGURATION.....	17
1.3 FEATURES.....	17
2 GETTING STARTED.....	18
2.1 PREPARING THE RADIO FOR USE.....	18
2.1.1 Charging the Battery	18
2.1.1.1 Procedure	18
2.1.2 Fitting the Battery	19
2.1.3 Fitting the Antenna	19
2.1.4 Fitting the Belt Clip	20
2.1.5 Fitting Audio Accessory/Programming Cable	20
2.2 CONFIGURATION.....	20
3 FRONT PANEL CONTROLS	21
4 FUNCTIONS AND FACILITIES	23
DISPLAY.....	23
4.1 SWITCH ON/SWITCH OFF	23
4.2 ADJUSTING THE VOLUME	23
4.3 SELECTING A ZONE.....	24
4.4 SELECTING A CHANNEL.....	24
4.5 MAKING A CALL (TRANSMITTING)	24
4.6 RECEIVING	25
4.6.1 Received Individual Calls	25
4.7 EMERGENCY ALARM.....	25
4.7.1 Receiving Emergency Calls.....	25
4.7.2 Making an Emergency Call	25
4.8 SCAN FUNCTIONS	26

4.8.1	Scan Screen	26
4.9	DUPLEX OPERATION	27
4.9.1	Setup – Infrastructure.....	27
4.9.2	Setup – SDP650	27
4.9.3	Receiving Duplex Calls on the SDP650	27
4.9.4	Initiating Duplex Calls from the SDP650.....	27
4.9.5	Disconnecting the call	27
5	MENU SYSTEM	29
5.1	MENU NAVIGATION	30
6	MENU SCREENS	31
6.1	CHANNEL MENU	31
6.2	ZONE MENU	31
6.3	SETUP MENU	32
6.4	USER OPTIONS MENU	32
6.5	MUTE ADJUST MENU	32
6.6	CONTACT MENU	33
6.7	RADIO INFORMATION.....	34
6.8	RSSI MENU.....	34
6.9	CALL LOG	34
6.10	SCAN MENU	35
6.11	CONTRAST MENU	35
6.12	ALERT VOLUME MENU	36
6.13	SPEAKER VOLUME MENU	36
6.14	KEY BEEPS	36
6.15	BACKLIGHT	37
6.16	BRIGHTNESS MENU.....	37
7	SPECIAL FUNCTIONS	39
7.1	CHANNEL UP AND DOWN	39
7.2	ZONE UP AND DOWN.....	39
7.3	SCAN ON/OFF	39
7.4	SKIP.....	39
7.5	TALK AROUND ON/OFF.....	39
7.6	LOW POWER	39
7.7	Go To CHANNEL A, B, C OR D.....	39
7.7.1	Go To Contact A, B, C or D.....	39
7.8	MENU.....	39
7.9	ZONE, CHANNEL, CONTACT AND MUTE	39
7.10	RESET.....	40
7.11	SPEAKER MUTE.....	40
7.12	MAN DOWN	40
7.13	LONE WORKER.....	40
8	ACCESSORIES.....	42

APPENDICES

A ALERT TONES AND MESSAGES.

LIST OF FIGURES

	Page
Figure 1. Fitting the Battery.....	19
Figure 2. Fitting the Antenna.....	19
Figure 3. Fitting the Belt Clip.....	20
Figure 4. Fitting Audio Accessory/Programming Cable.....	20
Figure 5. SDP650 Controls.....	21
Figure 6. Default screen.....	23
Figure 7. Typical display sequence after Switch On.....	23
Figure 8. Duplex Setup in FPP.....	27
Figure 9. FPP – PTT TX Control for Duplex Call.....	28
Figure 10. FPP – Earpiece Volume and Mic Gain settings.....	28
Figure 11. Menu Navigation (Example).....	30
Figure 12. Channel Menu.....	31
Figure 13. Zone Menu.....	31
Figure 14. Setup Menu.....	32
Figure 15. User Options Menu.....	32
Figure 16. Mute Adjust screen.....	33
Figure 17. Contact Menu screen.....	33
Figure 18. Radio Information Menu.....	34
Figure 19. Radio Information screens.....	34
Figure 20. RSSI Menu.....	34
Figure 21. Call Log Menu screen.....	35
Figure 22. Scan Menu.....	35
Figure 23. Contrast Menu screen.....	35
Figure 24. Alert Volume Menu screen.....	36
Figure 25. Speaker Volume Menu.....	36
Figure 26. Key Beeps Menu screen.....	37
Figure 27. Backlight Menu screen.....	37
Figure 28. Brightness Menu screen.....	37

LIST OF TABLES

	Page
Table 1. RF Exposure Compliance Distances.....	11
Table 2. RF Exposure Compliance DMR Duplex (2.5 Watts Burst Power).....	11
Table 3. Charge Indications.....	19
Table 4. SDP650 – Controls.....	22
Table 5. LED Indications.....	22
Table 6. SDP650 DMR Portable Radio Accessories.....	42
Table A1. Alert Tones.....	44

PERSONAL SAFETY

SAFETY PRECAUTIONS

These Safety Precautions, Warnings and Cautions advise personnel of specific hazards which may be encountered when using the equipment covered in this manual and that control measures are required to prevent injury to personnel, and damage to equipment and/or the environment.

Before using this equipment, personnel are to acquaint themselves with all risk assessments relevant to the work site and the task. They must then comply with the control measures detailed in those risk assessments.

References covering safety regulations, health hazards and hazardous substances are detailed under the **WARNINGS** section below. These are referred to in this user manual when they are encountered.

GENERAL PRECAUTIONS

Do NOT operate your portable radio, without a hands-free kit, whilst driving a vehicle.

Do NOT operate your radio in an explosive atmosphere – unless the radio's level of IECEx approval is approved for use in that atmosphere.

Obey the 'Turn Off Two-way Radios' signs where these are posted, e.g. on a petrol station forecourt.

Do NOT touch the antenna while the radio is transmitting.

Do NOT use or store the batteries above +60 °C.

Do NOT dispose of batteries in a fire.

Do NOT operate the radio if the antenna has become disconnected or damaged.

Only recharge batteries in an approved battery charger.

HAZARDOUS SUBSTANCES

Before using any hazardous substance or material, the user must be conversant with the safety precautions and first aid instructions:

- On the label of the container in which it was supplied.
- On the material Safety Data Sheet.
- In any local Safety Orders and Regulations.

WARNINGS

Lithium Batteries



WARNING
LITHIUM BATTERIES. THIS EQUIPMENT USES LITHIUM ION BATTERIES. REFER TO THE CONTROL OF SUBSTANCES HAZARDOUS TO HEALTH REGULATIONS (COSHH) 2002 AND/OR THE APPROPRIATE SAFETY DATA SHEET.

Radio Frequency Radiation



WARNING

RADIO FREQUENCY RADIATION. A RADIO FREQUENCY (RF) RADIATION HAZARD EXISTS IN THIS EQUIPMENT. TO AVOID RF INJURY, DO NOT TOUCH THE ANTENNA WHEN THE TRANSMITTER IS IN USE. DO NOT OPERATE TRANSMITTER WITH THE ANTENNA DISCONNECTED.

FCC Part 15 Compliance



THIS DEVICE COMPLIES WITH PART 15 OF THE FCC RULES. OPERATION IS SUBJECT TO THE CONDITION THAT THIS DEVICE DOES NOT CAUSE HARMFUL INTERFERENCE.

Dangerous Voltages

Dangerous voltages exist in this equipment, for the appropriate Safety precautions, refer to the relevant Electrical Safety Regulations appropriate to the country of operation.



WARNING

DANGEROUS VOLTAGES. DANGEROUS VOLTAGES EXIST IN ALL THE BATTERY CHARGERS USED WITH THIS RADIO. FOR THE APPROPRIATE SAFETY PRECAUTIONS REFER TO THE RELEVANT ELECTRICAL SAFETY REGULATIONS APPROPRIATE TO THE COUNTRY OF OPERATION.

HINTS FOR USING THE RADIO

When transmitting, hold the radio a few centimetres from your mouth and speak across it, rather than into it. The microphone is located near the bottom left hand corner of the portable radio.

Keep the length of your conversation to a minimum to conserve battery life.

When it is possible to move location, avoid making calls from known poor signal-strength areas such as the radio systems fringe areas (limit of range) or from screened or shadowed areas, e.g. an underground car park or underpass.

COMPLIANCE WITH RF ENERGY EXPOSURE GUIDELINES (UNITED STATES AND CANADA)

RF ENERGY EXPOSURE AWARENESS AND CONTROL INFORMATION AND OPERATIONAL INSTRUCTIONS FOR FCC OCCUPATIONAL USE REQUIREMENTS

Before using your Simoco portable two-way radio, read this important RF energy awareness and control information and operational instructions to ensure compliance with the Federal Communication Commission's (FCC's) RF exposure guidelines.

NOTICE.

This radio is intended for use in Occupational/Controlled conditions in a portable application where users have full knowledge of their exposure and can exercise control over their exposure to meet the occupational limits in FCC/ICNIRP and International Standards. This radio device is NOT authorised for general population consumer use.

This two-way radio uses electromagnetic energy in the Radio Frequency (RF) spectrum to provide communications between two or more users over a distance. It uses RF energy or radio waves to send and receive calls. RF energy is one form of electromagnetic energy. Other forms include, but are not limited to, electric power, sunlight and x-rays. RF energy, however, should not be confused with these other forms of electromagnetic energy, which, when used improperly, can cause biological damage. Very high levels of x-rays, for example, can damage tissues and genetic material.

Experts in science, engineering, medicine, health and industry work with organizations to develop standards for safe exposure to RF energy. These standards provide recommended levels of RF exposure for both workers and the general public. These recommended RF exposure levels include substantial margins of protection. All Simoco two-way radios are designed, manufactured and tested to ensure they meet government established RF exposure levels. In addition, manufacturers also recommend specific operating instructions to users of two-way radios. These instructions are important because they inform users about RF energy exposure and provide simple procedures on how to control it. Please refer to the following websites for more information on what RF energy exposure is and how to control your exposure to assure compliance with established RF exposure limits.

<http://transition.fcc.gov/oet/rfsafety/rf-faqs.html>

<http://www.osha.gov/SLTC/radiofrequencyradiation/>

Federal Communications Commission Regulations

The FCC rules require manufacturers to comply with the FCC RF energy exposure limits for portable two-way radios before they can be marketed in the United States (US). When two-way radios are used as a consequence of employment, the FCC requires users to be fully aware of and able to control their exposure to meet occupational requirements. Simoco two-way radios have an exposure awareness label attached to the equipment directing users to specific awareness information. Do not remove this exposure awareness label from the device. Additionally, your Simoco user manual or separate safety booklet includes information and operating instructions required to control your RF exposure and to satisfy compliance regulations.

Compliance with RF Exposure Standards

Simoco two-way radios are designed and tested to comply with a number of national and international standards and guidelines (listed below) for human exposure to RF electromagnetic energy. This radio complies with the IEEE (FCC) and International Commission on Non-Ionizing Radiation Protection (ICNIRP) exposure limits for Occupational/Controlled RF exposure environments at operating duty factors of up to 50% talk 50% listen and is authorised by the FCC

for occupational use. In terms of measuring RF energy for compliance with these exposure guidelines, your radio generates measurable RF energy only while it is transmitting (during talking), not when it is receiving (listening) or in standby mode.

Your Simoco two-way radio complies with the following RF energy exposure standards and guidelines:

- United States Federal Communications Commission, Code of Federal Regulations; 47CFR part 2 sub-part J.
- American National Standards Institute (ANSI)/Institute of Electrical and Electronic Engineers (IEEE) C95.1-1992.
- Australian Communications Authority Radio Communications Standard et seq.
- Institute of Electrical and Electronic Engineers (IEEE) C95.1-1999 Edition.
- Industry Canada RSS-102.

RF Exposure Compliance and Control Guidelines and Operating Instructions

To control exposure to yourself and others and ensure compliance with the Occupational/Controlled environment exposure limits always adhere to the following procedures.

Guidelines:

- User awareness instructions should accompany the device when transferred to other users.
- This radio meets the FCC RF exposure guidelines when used with the Simoco accessories supplied or designated for the product. The designated Simoco belt clip type is PAR-600CLIP and the extension speaker microphone types are PAR-9180LMS2-2, PAR-9180LMW1 and PAR-600LMS4. Use of other accessories may not ensure compliance with the FCC's RF exposure guidelines and may violate FCC regulations.
- Do not use this device if the operational requirements described herein are not met.

Instructions:

- The radio transmitter power output is 5 Watts for PTT controlled, held-to-face or bodyworn applications in analogue systems, or for DMR systems, 5 Watts burst power.
- For radios enabled for held-to-ear Duplex operation in DMR systems, the transmitter power output is 2.5 Watts burst power.
- For operation in held-to-face or bodyworn applications, transmit no more than the rated duty factor of 50% of the time. To transmit (talk), push the Push-To-Talk (PTT) button. To receive calls (listen), release the PTT button. Transmitting 50% of the time, or less, is important because the radio generates measurable RF energy exposure only when transmitting (in terms of measuring for standards compliance).
- For operation in DMR systems using Duplex held-to-ear applications, PTT control is not required, but calls should always be kept as short as possible.
- Do not operate the radio without an approved antenna attached, as this may cause the FCC RF exposure limits to be exceeded. With this product, only use an antenna supplied or approved by Simoco.
- When using the radio in Handheld in front of face position, always keep the radio at least 5 cm (2.0 inches) from the face when transmitting. When using the radio in a Bodyworn position, use only Simoco accessories that will ensure the correct compliance distance of at least 12 mm (0.45 inches) from the body. This radio has been tested for RF exposure compliance at the distances listed in **Table 1**.

- For held-to-ear Duplex applications in DMR systems, the radio has been tested for RF exposure compliance as listed in **Table 2**.

Table 1. RF Exposure Compliance Distances.

Frequency Band	Bodyworn	Handheld in front of Face
AC: 136 MHz – 174 MHz	12 mm (0.45 inches)	25 mm (1.0 inches)
TU: 400 MHz – 480 MHz	12 mm (0.45 inches)	25 mm (1.0 inches)
UW: 440 MHz – 520 MHz	12 mm (0.45 inches)	25 mm (1.0 inches)

Table 2. RF Exposure Compliance DMR Duplex (2.5 Watts Burst Power).

Frequency Band	DMR Duplex
UW: 440 MHz – 520 MHz	Held-to-Ear

Approved Accessories

- This radio meets the FCC RF exposure guidelines when used with the Simoco accessories supplied or designated for the product. Use of other accessories may not ensure compliance with the FCCs RF exposure guidelines and may violate FCC regulations.
- To obtain a list of Simoco approved accessories please see the Simoco Group Departmental contact details on the Support page and either contact the relevant Technical Support Helpline or Customer Services, visit the following website, which lists approved accessories:

<http://www.simocogroup.com>

For additional information on exposure or other information, please see the Simoco Group Departmental contact details on the Support page and contact the relevant Technical Support Helpline or Customer Services.

GENERAL NOTES

MANUAL COMPILATION

This manual provides detailed information on the use of the SDP650 DMR Portable Radio Transceiver including Getting Started, Front Panel Controls, Basic Functions and Facilities, Menu System, Menu Screens, Special Functions and Accessories.

Details of both the “default” and “optional” system configurations have been included in this User Manual, therefore, some material may not be relevant to every system. Configuration is dependent upon the specification by the customer when the equipment was ordered and installed.

PAGINATION

This manual is divided into a number of sections, each section deals with one aspect of the system.

Following initial issue, any page that has been amended or updated will also bear an updated reference.

SIMOCO SUPPORT

CONTACT INFORMATION

At Simoco we welcome your comments, feedback and suggestions. Departmental contacts have been provided for your quick reference below.



UK Customer Services

Email:		customer.service@simocogroup.com
Tel:	UK:	08717 411 050
	International:	+44 (0) 1332 375 671
Fax:	UK:	08717 411 049
	International:	+44 (0) 1332 376 672

Sales

E-mail sales@simocogroup.com

Marketing

E-mail marketing@simocogroup.com



Australian Customer Services

Email:		inquiry.aus@simocogroup.com
Tel:	Within Australia:	1300 363 607
	International:	+61 3 9730 3999



US Customer Services

Email: customerservice@simocogroup.com

TECHNICAL SUPPORT

In order to streamline support requests and better serve our customers, at Simoco we utilize a support ticket system. Every support request is assigned a unique ticket number, which customers can use to track the progress and responses online. For reference, Simoco provide complete archives and history of all customer support requests. In order to use the support ticket system, a valid email address is required.

A link to the online Simoco Group Support Centre Ticket Tracking system is provided below:

<http://www.simocogroup.com/ticket/supportcentre.htm>

If you still require further technical assistance after raising a support ticket, please contact us via the email addresses or via the Technical Support Helpline numbers below.

Technical Support Email Addresses

Simoco EMEA: techsupport@simocogroup.com

Simoco Australasia: inquiry.aus@simocogroup.com

Simoco Americas: techsupport@simocogroup.com

Technical Support Helplines

Simoco EMEA: Tel: UK: 08717 411 040
International: +44 (0) 1332 375 671

Simoco Australasia: Tel: Within Australia: 1300 363 607
International: +61 3 9730 3999

ABBREVIATIONS

The following abbreviations are used through out this document. Whenever practicable, wherever the abbreviation is first used the full meaning is given with the abbreviation in parenthesis, after that only the abbreviation will be used.

LIST OF ABBREVIATIONS

Abbreviation	Meaning
AC	Alternating Current
ANSI	American National Standards Institute
CC	Colour Code
COSHH	Control Of Substances Hazardous to Health
CTCSS	Continuous Tone Controlled Squelch System
DCS	Digital Coded Squelch
DMR	Digital Mobile Radio
DSP	Digital Signals Processor
FCC	Federal Communications Commission
FDMA	Frequency Division Multiple Access
FOACSU	Full Off Air Call Set Up
FPP	Field Personality Programmer
GPS	Global Positioning System
ICNIRP	International Commission on Non-Ionizing Radiation Protection
ID	Identification
IECEX	International Electrotechnical Commission system for the certification to standards for electrical equipment for Explosives atmospheres.
IEEE	Institute of Electrical and Electronics Engineers
LCD	Liquid Crystal Display
LED	Light Emitting Diode
OACSU	Off Air Call Set Up
PABX	Private Automatic Branch Exchange
PSTN	Public Switched Telephone Network
PTT	Push (Press) To Talk
RF	Radio Frequency
RSSI	Received Signal Strength Indicator
Rx	Receiver
SDM	Simoco Digital Mobile
SDP	Simoco Digital Portable
SUID	Subscriber Unit Identification
TGID	Talk Group Identification
Tx	Transmitter
UID	Unit Identification
US	United States

GLOSSARY OF TERMS

The table below contains a list of the common terms used through out this document and their meanings.

Term	Meaning
'.....'	Reference to a setting or feature (exactly as it is displayed) that may be selected or enabled either directly or through a software application, e.g. 'Menu', 'Control', 'Switch'.
Channel	A logical combination of RF Frequency, Default Talk Group Identity (TGID), other channel associated parameters (CTCSS, scan etc)
CTCSS	A sub-audio tone used for validating a received signal (also known as a PL tone).
FPP	Field Personality Programmer or Field Programmer. A Software Application used for configuring the radio options and parameters.
Monitor	Mode of Radio Receive. Any DMR signal regardless of Colour Code or TGID will be heard.
Normal Mute	Mode of Radio Receive. Only signals with matching Colour Code will be heard.
Push To Talk	The action or signal that causes the equipment to be placed into transmit mode or to be keyed.
Radio Unit ID	Unique identifier allocated to each radio (range: 0 – 16,000,000).
Scanning	A process of selecting the first-found, permitted signal from one of several possible radio channels carrying different signals, by sequentially scanning the channels.
Selective	Mode of Radio Receive. Only signals with matching Colour Code and TGID or Unit ID will be heard.
Vote/voting	A process to select a permitted radio signal of adequate signal quality from one of several possible radio channels carrying the same signal, by sequentially scanning the channels before and at the start of signal reception.
Zone	A collection of channels (usually organised by functional group of users).

1 INTRODUCTION

1.1 OVERVIEW

The SDP600 Series Radios are versatile Digital Signal Processor (DSP) controlled, two-way portable radios. The SDP600 Series Radio is available in a number of frequency bands for specific applications.

The radios are software programmable and can be customised to the operational requirements of a customer's particular fleet. Simoco representatives can help in programming the radio facilities to meet a customer's present and future requirements.

A comprehensive range of accessories are available to compliment the SDP600 Series Radios including: chargers, antennas, remote speaker microphones, covert/surveillance kits, holsters and carry cases. Refer to Simoco for comprehensive descriptions and pricing.

The SDP650 model offers seven function keys but no keypad.

This User Manual describes the facilities that are currently available and can be programmed into the SDP650 Series Radios.

1.2 CONFIGURATION

Before the SDP650 radio can be used it must be configured using the Field Personality Programmer (FPP). The configuration process loads the customised channels, signalling and user options so that the radio will operate with the user's system.

1.3 FEATURES

The SDP650 portable radio has the following features:

- Integrated Man Down – motion and positional sensor for full employee safety.
- IP67 performance for best in class resistance to water and dust.
- Ear-piece speaker for full-duplex calling mode.
- Bluetooth, enhances the radio with wireless accessories and applications.
- Integral Global Positioning System (GPS) Antenna for dedicated satellite performance placed optimally within the radio.
- High output main speaker for loud & clear digital audio.
- 7-colour Light Emitting Diode (LED) with all-round viewing for clear indication of radio status.
- Easy access to emergency button for no-doubt notification.
- Ergonomic push-to-talk.
- Selector knob enhances usability, for control of volume and brings smart-phone speed-scrolling to the radio.
- IP67 rated side-connector.
- Battery life 40% greater than equivalent analogue and Frequency Division Multiple Access (FDMA) technologies.
- Simple display for easy four character channel identification.
- Two side programmable keys and two front programmable keys.
- Easy access up-and-down channel change.

2 GETTING STARTED

This User Manual covers the basic operation of the Simoco SDP650 Digital Portable radios.

The radios are software programmable and can be customised to the operational requirements of a customer's specific needs. Simoco representatives can help in programming the radio facilities to meet a customer's present and future requirements.

Users should check with their Simoco dealer or system administrator about the features programmed into the radio and specifically about:

- Whether any preset conventional channels are programmed into the radio?
- Which buttons have been programmed to access other features?
- The optional accessories that may be required?

2.1 PREPARING THE RADIO FOR USE

2.1.1 Charging the Battery



WARNING

LITHIUM BATTERIES. THIS EQUIPMENT USES LITHIUM ION BATTERIES. REFER TO THE PERSONAL SAFETY PAGES.

The SRP650 radio is powered by a 2200 mAh Lithium Ion battery. To avoid damage and comply with warranty terms, the battery should be charged with a Simoco Standard Battery charger.

For best performance, new batteries should be charged for 5 hours before initial use.

2.1.1.1 Procedure

This charging procedure assumes that the PAR-600CRG1 Single Rapid Charger is used. For full details on this charger, please refer to TNM-U-E-0118, PAR-600CRG1 Single Rapid Charger – SDP650/660 Instructional Manual [3].

- 1 Connect the AC power adapter to an AC mains supply and to the socket on the back of the charger.
- 2 Switch on the mains power. The Red LED on the charger will flash briefly. The charger is now in standby mode.
- 3 Switch the radio off.
- 4 Place the battery pack, or the radio with the battery attached, into the charging slot on the charger.
- 5 Check that the Red LED on the charger is illuminated.
- 6 The fast charging process will be initiated. When the battery pack is fully charged, the Green LED on the charger will be illuminated (see **Table 3** overleaf).

Table 3. Charge Indications.

Charge State	LED States	
	Red LED	Green LED
Battery absent	Off	Off
Fast Charge	On	Off
Charge Complete	Off	On
Charge suspended (High or Low Temp)	1 Hz Flashing	Off

2.1.2 Fitting the Battery

Insert the battery into the bottom of the radio. (See arrow 1 in **Figure 1** below).

Press down slightly on the battery release clip located at the top of the battery until a click is heard. (See arrow 2).



Figure 1. Fitting the Battery.

To remove the battery, turn the radio off. Slide the battery release clip downwards to release the battery.

2.1.3 Fitting the Antenna

With the radio turned off, locate the antenna in its threaded socket and turn clockwise to tighten.



Figure 2. Fitting the Antenna.

To remove the antenna, ensure the radio is turned off and turn the antenna counterclockwise.

2.1.4 Fitting the Belt Clip

Align the belt clip with the grooves of the belt clip housing on the back of the battery. Push the belt clip downwards until a click is heard.

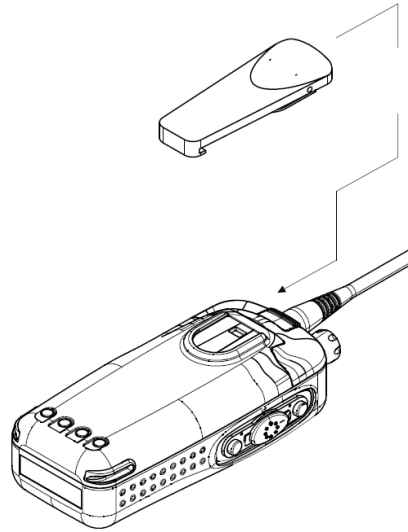

Figure 3. Fitting the Belt Clip.

2.1.5 Fitting Audio Accessory/Programming Cable

- 1 On the side of the radio, release the retaining screw and remove the accessory socket cover.
- 2 On the audio accessory/programming cable, locate the tab lug of the connector into either the top or bottom tab hole on the side of the radio as required (see **Figure 4** below).
- 3 Tighten the screw to secure the audio accessory/programming cable to the radio.



Figure 4. Fitting Audio Accessory/Programming Cable.

2.2 CONFIGURATION

Before the SDP650 radio can be used it must be configured using the FPP. The configuration process loads the customised channels, signalling and user options so that the radio will operate with the user's system.

3 FRONT PANEL CONTROLS

The SDP650 portable Radios have the following features:

- Multiple programmable dedicated Function Buttons.
- Function buttons also have a second function provided by a longer button press.
- Multi-coloured LED for a clear indication of radio status.
- Simple display for easy four character channel identification.



The Controls of the SDP650 Portable radio are shown below in **Figure 5**.



Figure 5. SDP650 Controls.

The functions of each of the controls are detailed overleaf in **Table 4**.

Table 4. SDP650 – Controls.

No.	Control	Label	Function
1	Tx/Rx/Power LED		Multi coloured LED. See Table 4 below for full details of colour indications.
2	Volume		Multifunction knob. Provides volume control (rotate clockwise to increase the volume; counterclockwise to decrease the volume). Also provides channel and zone selection, in conjunction with side-buttons F6 and F13.
3	Earpiece		
4	Antenna		
5	Function Key F5		Prog. function key. Default – Emergency/Alarm .
6	Function Key F6		Prog. function key. Allows multifunction knob to select zone if held down.
7	PTT		Push To Talk. Hold the radio 10 cm from the mouth. Press and hold the PTT switch and speak. Release the PTT switch to listen.
8	Function Key F13		Prog. function key. Allows multifunction knob to select channel if held down.
9	Display		
10	Function Key F1	–	Prog. function key. Default – Menu Select .
11	Function Key F11		Prog. function key. Default – Start Call .
12	Function Key F12		Prog. function key. Default – End Call, Cancel, power On/Off .
13	Function Key F4	=	Prog. function key. Default – Back .
14	Nav-Up F7	▲	Prog. function key. Default – Up key for scrolling.
	Nav-Down F8	▼	Prog. function key. Default – Down key for scrolling.
15	Microphone		

The details of the multi-coloured LED indications are contained below in **Table 5**.

Table 5. LED Indications.

LED	Colour	Meaning
○	LED Off.	Radio is in idle state (no call activity).
●	Green	Receiving a valid incoming signal.
⦿	Green Flashing	Radio in talk-back hang time. (FPP defined parameter for digital channel).
●	Red	Radio is transmitting.
⦿	Red Flashing	Emergency Mode active. This is a FPP defined parameter
⦿	Orange Flashing	Low Battery.

4 FUNCTIONS AND FACILITIES

DISPLAY

The display shows text information relevant to the selected Menu Screen.



Figure 6. Default screen.

The **Name** field (e.g. C1s1) shows the selected entry from the current screen (e.g. from the Channel List).

The F1 button is used to access the available Menu options. Where menu selection is not required, this button can be reprogrammed to perform other functions in this screen.

The Nav Up (▲) and Nav Down (▼) buttons scroll up and down through the available selections within a Menu Screen.

The F1, F2, F3 and F4 buttons are programmable function buttons, in this screen.

4.1 SWITCH ON/SWITCH OFF

Press and hold down the On/Off button for approximately 2 seconds to switch the radio ON.

The display will illuminate and briefly show an “Opening Message” (arranged by your dealer) and the Selcall Identity of the radio (if used).

After a brief time the display will show the selected channel (see **Figure 7** below), at which time the radio is ready for use.

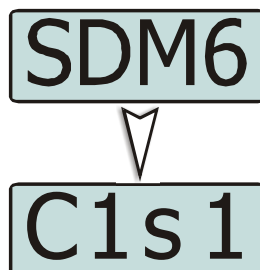

Figure 7. Typical display sequence after Switch On.

Pressing and holding the On/Off button for approximately 2 seconds will switch the radio Off.

If the radio Inactivity Timer is enabled, the radio will automatically turn off after several hours of inactivity (i.e. no buttons pressed). The radio will emit warning beeps for 10 seconds prior to switching off. Pressing any button will reset this timer.

The radio can also be set up to switch on automatically with the Vehicle Ignition whenever the vehicle is started.

4.2 ADJUSTING THE VOLUME

After turning the radio on, to adjust the volume, rotate the volume control knob clockwise to increase it or counter-clockwise to decrease it.

4.3 SELECTING A ZONE

Zones are groups of channels that are intended to be used in a particular geographical or functional zone (e.g. North, South, Security, Fire Control). The radio supports up to 40 zones, each with a maximum of 250 channels. A radio must have at least one zone defined to be functional and a channel may be used in more than one zone.

A Zone can be selected as follows:

- 1 Through menu selection:
 - 1.1 Go to the Zone menu, use the ▲ and ▼ keys to choose the required zone and press the F1 key to select it.
- 2 By using the function keys:
 - 2.1 From the main default screen, a zone can quickly be selected by pressing the 'Zone Up' or 'Zone Down' function keys when these have been programmed.

4.4 SELECTING A CHANNEL

The radio can have up to 2000 channels in its channel database.

A channel can be selected as follows:

- 1 Through menu selection:
 - 1.1 Go to the Channel menu, use the ▲ and ▼ keys to choose the required channel and press the F1 key to select it.
- 2 By using the function keys:
 - 2.1 From the main default screen, a channel can quickly be selected by pressing the 'Channel Up' or 'Channel Down' function keys when these have been programmed.

4.5 MAKING A CALL (TRANSMITTING)

Select the Zone/Channel required on which to make the call.

To avoid interfering with other users of the channel, listen first to ensure no transmissions are occurring.

To transmit, to the selected channel's default radio talk group, hold the radio or microphone about 10 cm in front of the mouth and press the PTT switch. Wait until the radio indicates that the Tx is transmitting and then speak clearly in a normal conversational manner.

In most systems it is important to wait a short time (0.5 secs) between pressing the PTT button and commencing to speak. This allows the transmission path to be properly established (or not) and avoids lost or distorted speech.

On some channels, the radio may provide alert tones to indicate the success or failure of the establishment of the transmission path. Only speak after the tone indicating the transmission's successful establishment. The radio's LED will also turn **Red** to show that the transmitter is active

Use the correct operating procedure and keep transmissions as short as possible.

Release the PTT switch as soon as you have completed your message in order to hear any replies. The radio cannot listen and talk to groups simultaneously.

If you wish to talk to other groups or individuals these can be selected on the contact menu or dialled before pressing the PTT.

Notes:

- (i). A channel may be programmed as Receive-only or Transmit Inhibit, which can disallow PTT. A continuous tone will be heard if PTT is attempted.*
- (ii). A Transmit Limit Timer may be setup that limits a single continuous transmission. The last 10 seconds before the timer expires may be accompanied by warning tones.*

A call can be made as follows:

- 1 Go to the 'Contact' or 'Call Log' menus.
- 2 Use the ▲ and ▼ keys to select the contact you wish to call.
- 3 Press the PTT key to transmit the call.

4.6 RECEIVING

The radio will listen on the displayed Channel. Changing channels can be achieved by either:

- Pressing the ▲ ▼ buttons; or
- Pressing a “Go-to-Channel” Function Button, refer to **Section 7.7**.

When receiving a call, press the PTT key within the preset time period to call back.

4.6.1 Received Individual Calls

Unanswered received Individual calls addressed to the radio are stored in radio memory.

The caller UID may be viewed, answered and deleted by the user as desired.

A newly received individual call addressed to the radio sounds an alert tone periodically until the user presses any key.

If the caller UID of a newly received unanswered call is already in the Call Log list, the old Call Log record of that UID will be replaced by the new record and added to the top of the list.

To view/answer/delete received call records, select the Call Log menu option.

4.7 EMERGENCY ALARM

4.7.1 Receiving Emergency Calls

When an emergency call is being received, a message will be displayed on the default screen 'EMG' indicating the radio unit sending the emergency call.

4.7.2 Making an Emergency Call

When the emergency key is pressed and held for a time determined by the FPP, the radio will change to emergency mode. Under emergency mode, the radio can operate in three FPP configurable modes:

- **Normal.** The radio will continue to respond to PTT, channel change etc.

- **Frozen.** The screen will freeze in the state it was in before the emergency mode became active. The Emergency mode message will not be displayed, thus, showing no sign to the observer that the emergency mode has been triggered.
- **Blank.** The screen will blank giving no indication to others that the radio is in emergency mode.

When emergency mode is triggered, the radio can be configured by the FPP to transmit and receive on a cyclic basis with FPP programmed time periods.

During Tx, the radio will generate an emergency broadcast call on either the currently selected channel or an FPP nominated channel.

Others may listen to the automatic transmissions to hear conversations near the radio.

Turning the radio off and on will disable emergency mode.

4.8 SCAN FUNCTIONS

The Scan Function allows the sequential searching of up to 16 channels, if the selected zone channel is programmed as a Scan channel, for a valid signal (Carrier + CTCSS/DCS tone for Analogue FM or Colour Code for DMR). When found, the radio will stop on that channel until the signal disappears again.

If scanning is enabled on your radio, press the **F4** button from the Main Channel Screen to enter Scan Mode, or select a channel that has been programmed as a scan channel. Once selected, the scanning will either start automatically, if programmed, or the programmed scan function button will need to be pressed. (FPP configurable).

While listening on the channel, the user is able to PTT on that channel. After the signal disappears, the radio will remain listening on the channel for a short time (FPP configurable, typically 3 seconds) before resuming scanning.

If a Priority Channel is assigned to Scan mode, the radio will interleave a check of this channel between each normal Scan channel. The radio may also check the Priority Channel every few seconds while stopped on a channel. If a signal is found on the Priority Channel then the radio will switch to that channel immediately.

4.8.1 Scan Screen

The display screen during scanning shows the name of the current Scan-Group (e.g. West), which can be changed using the ▲ ▼ buttons. (User Scan Groups can be edited by the User).

The Scan Screen does not time-out.

Press the **F4** button to exit to the Main Channel screen.

The ▲ and ▼ buttons allow access to the other screens (not Main Channel Screen). When these other menus time-out, the display returns to the Scan Screen.

In the Scan Screen the function buttons are assigned as follows:

- **F1** Go to other Menus.
- **F3** Skip channel (only while receiving a signal).
- **F4** Exit scanning.

The **F3** button temporarily deletes (skips) the channel from the Scan-Group. Skip is only active when stopped on a channel. Skipped channels are restored when a different Scan Group is selected or if Scan is exited. The Priority Channel cannot be skipped.

4.9 DUPLEX OPERATION

Duplex mode allows telephony calls to be made where users can simultaneously talk and hear the other party, without the need to PTT during transmissions. During operation, the audio is routed through the portables earpiece (located directly above the display).

To activate duplex functionality, this mode must be enabled in both the infrastructure and the terminal, and is applicable only to Tier III (Trunking) systems.

4.9.1 Setup – Infrastructure

In SDMT, on the Subscribers configuration page, ensure that the 'Mode' for the relevant Portable Radio ID is set to 'Duplex Mode'.

4.9.2 Setup – SDP650

In the FPP, on the Systems branch of the navigation tree, ensure that the 'Outgoing Telephony Calls are Duplex' checkbox is selected. See **Figure 8** below.

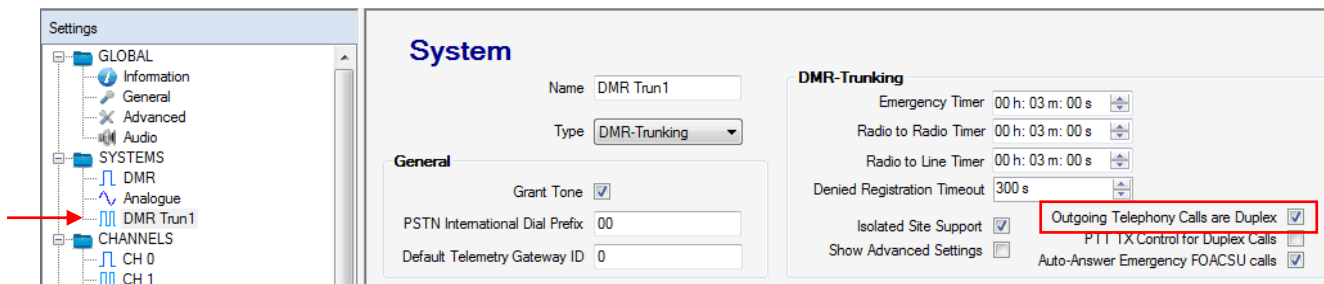

Figure 8. Duplex Setup in FPP.

4.9.3 Receiving Duplex Calls on the SDP650

In a Full Off Air Call Set Up (FOACSU) system, the radio will start ringing. Calls can be answered by pressing either the PTT button or the green connect button.

For Off Air Call Set Up (OACSU) systems, the radio will automatically answer any incoming duplex calls.

For this model, no icons or text notifications are displayed to indicate that this call type is a duplex call.

4.9.4 Initiating Duplex Calls from the SDP650

Duplex calls can only be achieved on the SDP650 radio if the contact is pre-configured within the channels contact list.

To initiate a duplex call, from the main menu select 'PHBK', navigate to the desired contact, and press either the PTT or green dial button. An audible ringing tone will be heard while waiting for the recipient to answer in FOACSU systems.

4.9.5 Disconnecting the call

Duplex calls can be terminated by either party hanging up (radio users press the red End Call/Cancel button), or the 'Radio to Line Timer' expires.

In noisy environments, it is recommended that 'PTT TX Control for Duplex Calls' checkbox is enabled. This prevents the microphone from automatically transmitting continuously and will allow users to PTT to enable the microphone for each transmission. See **Figure 9** below.

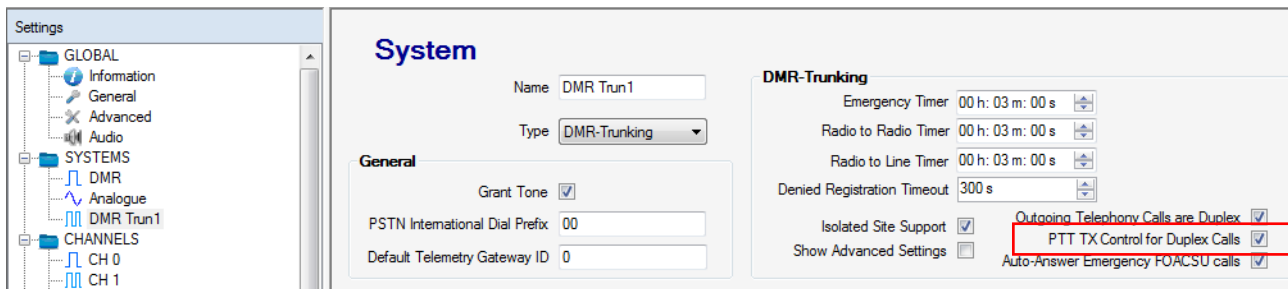

Figure 9. FPP – PTT TX Control for Duplex Call.

If the PABX caller is experiencing any audible feedback or echo, in the FPP under the 'Global' > 'Audio' section, reduce the 'Earpiece Volume Offset' and 'Mic Gain' settings. See **Figure 10** below.

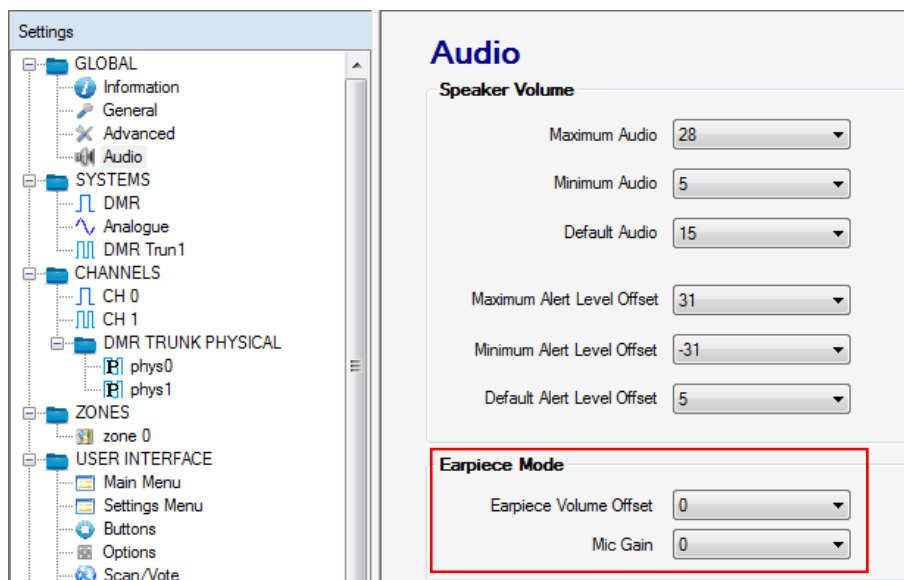

Figure 10. FPP – Earpiece Volume and Mic Gain settings.

5 MENU SYSTEM

This section details the operation of the menu system for the SDP650 Portable Radio.

The SDP650 radio software uses a programmed menu structure to enable the operator to access the radio options. The structure of the menu can be configured using the FPP to meet a customer's specific needs. In simple configurations, no menu can be programmed. An example menu structure for a radio is illustrated overleaf in **Figure 11**.

Pressing the F1 key from the top-level channel screen enters the menu system. The F4 is generally the "Back" key.

The possible menus are:

- Channel.
- Zone (this is usually the first menu as it is often accessed).
- Contact.
- Radio Info.
- Mute Adjust.
- User Options.
- Settings.
- Backlight.
- Brightness.
- Contrast.
- Key Beeps.
- Speaker Volume.
- Alert Volume.
- Radio Status.
- Help.
- Display Test
- Test Mode.
- Text Message.
- Call Log.

The presence and order of the above menu selections is determined by the FPP configuration.

The **Settings** menu is a special case entry. **Settings** is a subgroup that can have any of the list of menu selections assigned to it. This means that, if required, the lesser used selections can be partly hidden away under the Setup subgroup but still remain accessible.

The order and presence of the Settings subgroup selections is determined by the FPP. For instance **Info**, **Radio Status** and **Contrast** could be placed under Settings.

The **Options** menu group is also a menu subgroup. This subgroup contains the five configuration options of: Backlight; Brightness; Speaker Volume; Alert Volume; and Key Beeps.

5.1 MENU NAVIGATION

Pressing the F1 key selects Menu mode from the main Channel Screen. Once in menu mode, the ▼ and ▲ keys cycle through the menus.

To exit Menu mode, press the F4 key or the Menu timeout will exit automatically. Generally, pressing the F4 key while in a menu backs up to the next highest level of menu and the F1 key selects the menu option.

The ▼ and ▲ keys are used to navigate through a list of options such as channels, or to increase/decrease a value.

Note: Example menus only shown. Other Menus may be configured with the FPP.

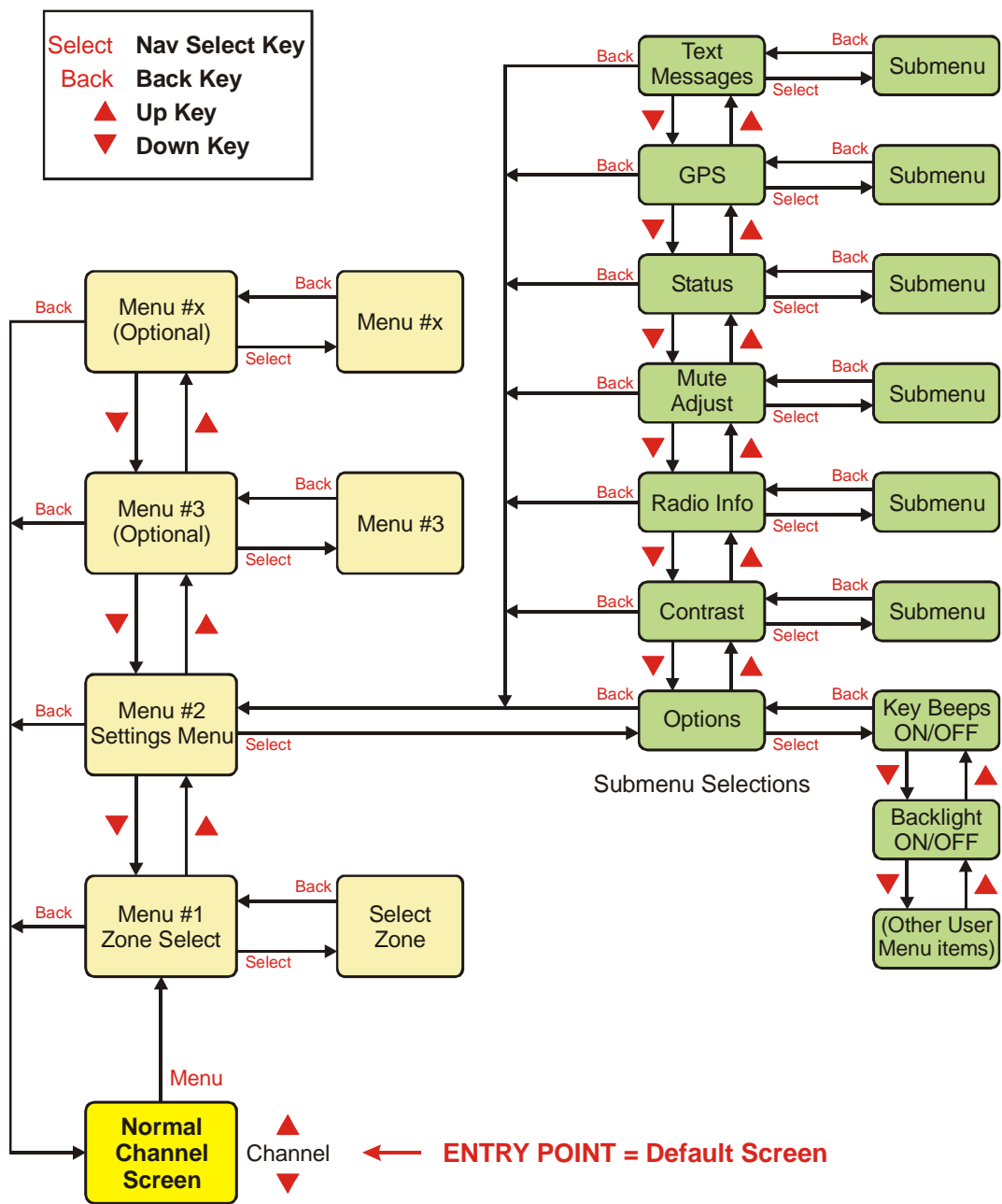

Figure 11. Menu Navigation (Example).

6 MENU SCREENS

The menu structure on the SDP650 is configurable using the FPP. A system administrator usually tailors the order and presence of the menu options to specific customer requirements.

This section describes all the menus that are currently available.

Normally, the menus are divided into three menu lists. These are the Main Menu list, the Setup Menu list and the User Options Menu list.

In the default configuration, the Main Menu contains the Channel, Zone and Setup menus. This allows access to the second 'Setup' menu level.

The Main Menu can be accessed from the default screen by selecting the F1 button.

To access any of the menu options from the Main, Setup or User Options Menus, use the ▲ and ▼ keys to scroll through the lists until the required menu option is displayed and then press the F1 button.

Pressing the F4 key at any point will go back to the previous screen.

6.1 CHANNEL MENU

The Channel menu allows the user to select the communication channel to be used within a Zone.

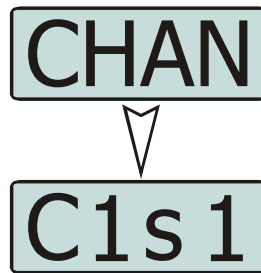

Figure 12. Channel Menu.

The Channel Screen shows the currently selected channel. Use the ▲ and ▼ keys to scroll through the other available channels and press the F1 key to select it.

Radio channels may be configured with the FPP as specific frequencies or as auto-scan types. When an auto-scan channel is selected, it will immediately go into scan mode. Selecting another non-auto-scan channel will stop the scan.

6.2 ZONE MENU

The Zone menu allows the user to change Zones. A Zone is normally defined as a group of radio channels with a common operational role.

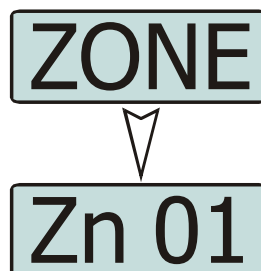

Figure 13. Zone Menu.

Use the ▼ and ▲ keys to choose the required Zone. Press the F1 key to select the required Zone. The radio will return to the default screen and select the first channel in the new Zone.

Direct access to the 'Zone' menu from other screens can also be programmed to one of the function buttons with the FPP.

6.3 SETUP MENU

The Setup Menu allows the user to access a programmable selection of the menu options. These menu options can be programmed into the Setup Menu with the FPP. The FPP User can choose to add any, all or none of the menu options to the Setup menu as required. If the Setup Menu option is not included in the Main Menu list, the Setup Menu will not be accessible to the radio user.



Figure 14. Setup Menu.

From the Setup menu screen, press F1 to access the sub-menu options. Using the ▼ and ▲ keys, scroll through the available Setup sub-menu options. Press the F1 key to access the menu option required.

The Setup menu structure may include, for example:

- Radio Info (Radio software and hardware information);
- RSSI (Received Signal Strength Indication);
- Test Mode;
- Mute Adjust; or
- Help.

6.4 USER OPTIONS MENU

The User Options menu allows the user access to a preset selection of menu options for user radio interface configuration items. These include the backlight timeout period, the backlight brightness, the display contrast, speaker and alert tone volume control limitations, and the key beeps function.



Figure 15. User Options Menu.

From the User Options menu screen, press F1 to access the sub-menu options. Using the ▼ and ▲ keys, scroll through the available sub-menu items. Press the F1 key to access the menu option required.

If required, these user option functions can also be assigned directly to the radio's function buttons.

Information on each of the User Options menu items is contained later in this section.

6.5 MUTE ADJUST MENU

The Mute Adjust menu allows the user to select the threshold at which the radio makes weaker or distorted received audio signals available to the user.

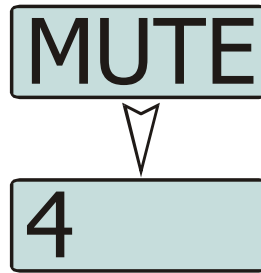

Figure 16. Mute Adjust screen.

The default Mute Adjustment range is from 0 – 15. The mute adjustment setting will be applied to all the radio's analogue channels.

The SDM600 series radios have a carrier noise mute and it is recommended that a default mute setting of 4 is used. This means that, with a setting of 4, the mute will open at the point where an analogue signal is sufficiently noise free to be intelligible.

Other settings are as follows:

- **0** No muting. Allows all decodable signals to the radio user's audio output device (loudspeaker, headset etc.).
- **4** Normal default setting.
- **8** Only reasonably strong signals will be heard.
- **15** Only very strong or near perfect signals will be heard.

Use the ▼ and ▲ keys to adjust the mute threshold. Press the F1 key to save the selected mute setting and return to the previous screen.

Direct access to the 'Mute Adjust' screen from other screens can also be programmed to one of the function buttons with the FPP.

6.6 CONTACT MENU

The Contact Menu allows user to select the communication entity they wish to call, e.g. individual radio unit (UID or SUID), talk group of radio units (TGID), dialled external network access gateway (phone, internet, other radio networks, dispatchers), and PABX/PSTN.

Up to 20 Contact Lists can be created and programmed into the Radio with the FPP. Each Contact List can have up to 600 entries. Each Contact List is assigned on a per "Channel" basis in the Zone set up section of the FPP.

Therefore, the Contact list displayed via the Contact menu is the Contact List assigned to the radio's currently selected Channel. This ensures that a user can't select a Contact who uses a different mode than the one selected.

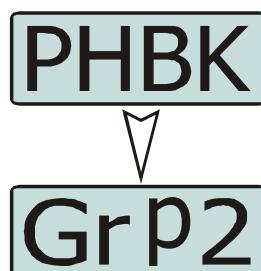

Figure 17. Contact Menu screen.

Use the ▼ and ▲ keys to scroll through the available contacts.

Pressing the PTT key will place a call to the selected contact.

6.7 RADIO INFORMATION

The Radio Information menu provides the User with information about the specific radio such as the Radio ID, Serial Number, Software Version, etc.

The 'Radio Info' screens are read-only screens.

Press the F1 key to access the different information screens. Using the ▼ and ▲ keys, select the required radio information item from the list.

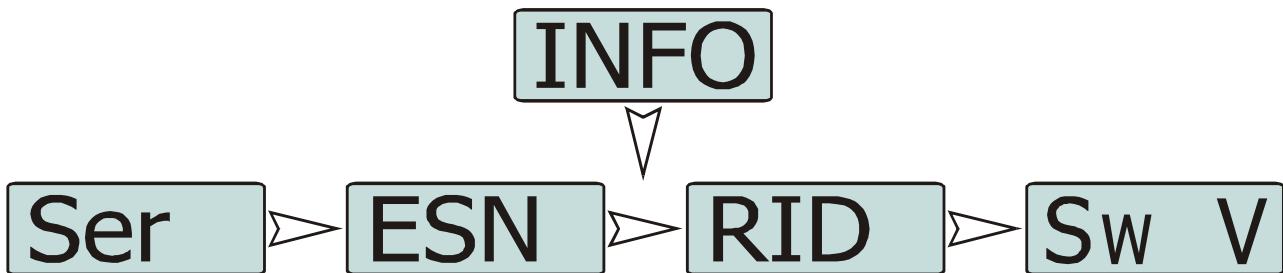

Figure 18. Radio Information Menu.

Press the F1 key to display the specific information screen. Press the F4 key to return to the next highest menu level.

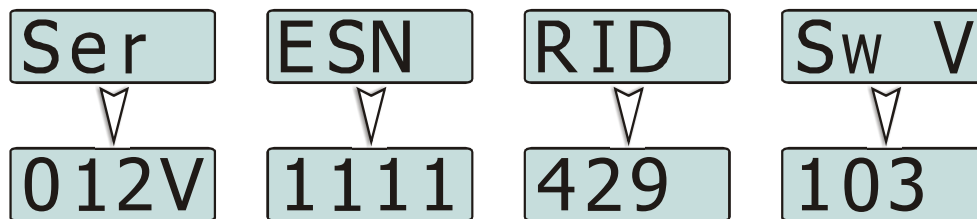

Figure 19. Radio Information screens.

6.8 RSSI MENU

The RSSI menu displays the signal strength of the received RF signal. The current display is in dBm re 50 Ω and 1 mW, and the reading is typically accurate to within ±2 dBm.

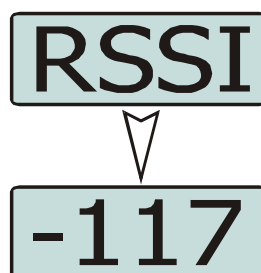

Figure 20. RSSI Menu.

A lower RSSI number indicates a stronger signal, i.e. -80 dBm is a stronger signal than -100 dBm.

6.9 CALL LOG

The Call Log menu displays the list of received individual call records for the radio. The most recently received call record is displayed at the top of the list.

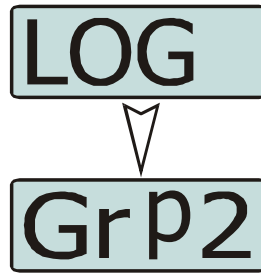

Figure 21. Call Log Menu screen.

The stored record will display either the name of the caller from the phone book or, if the ID is not known to the Contact list, the user ID will be displayed.

The Call Log list can be used like the Contacts menu to re-call radio entities that have called before.

The ▼ and ▲ keys can be used to scroll through the Call Log. Pressing the F1 key will display the details of selected call record.

Pressing the PTT key will place a call to the selected contact.

To return to the previous Menu level, press the F4 key.

6.10 SCAN MENU

The Scan menu allows the User to manually start and stop the channel scanning process on the current channel, if the channel is programmed as a “scan” channel in the FPP.

This Scan function can be programmed to a toggle key.

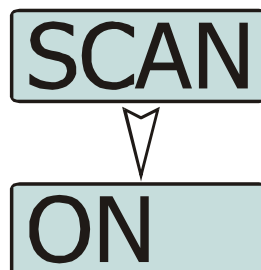

Figure 22. Scan Menu.

Use the ▼ and ▲ keys to select either the scan On or Off function. Press the F1 key initiate the action.

6.11 CONTRAST MENU

The Contrast menu allows the user to change the “contrast” of control units display (when adjustable). This optimises the LCD display drives for the best contrast at varying viewing angles and lighting conditions.

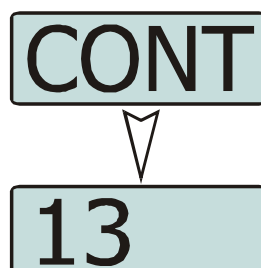

Figure 23. Contrast Menu screen.

Use the ▼ and ▲ keys to choose the required contrast level. Press the F1 key to save the selected contrast level and return to the main default screen.

6.12 ALERT VOLUME MENU

This menu allows the user to set the offset of the Alert Volume in relation to the current Volume setting. Thus, the alert tones can be made louder or softer than the main voice audio.

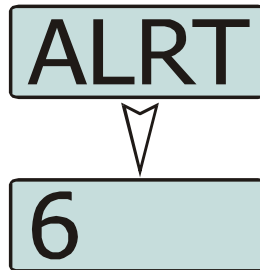

Figure 24. Alert Volume Menu screen.

The level can be set in 33 steps over the range 0 to 32, with 0 (zero) being about the same as the voice level.

Use the ▼ and ▲ keys to select the relative alert volume level. A beep will sound at the indicated level each time the setting is changed.

To accept and save the setting and return to the previous screen, press the F1' key.

Note.

A minimum Alert Level may be set by the FPP to ensure that the Alerts can always be heard from the speaker.

6.13 SPEAKER VOLUME MENU

This menu allows the User to set the start-up value of the radio's audio volume control for user comfort.

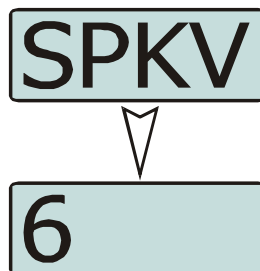

Figure 25 Speaker Volume Menu.

The level can be set in 33 steps over the range 0 to 32, with 0 (zero) delivering no sound, 16 is normal level and 32 giving the maximum possible output from the speaker.

Use the ▼ and ▲ keys to select the relative speaker volume level. A beep will sound at the indicated level each time the setting is changed.

To accept and save the setting and return to the previous screen, press the F1 key.

6.14 KEY BEEPS

The Key Beeps menu allows the User to enable or disable the acoustic feedback signals associated with pressing the function keys on the control unit.

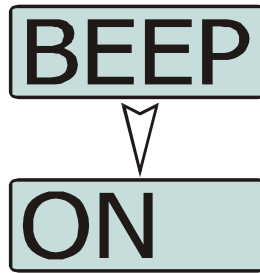

Figure 26. Key Beeps Menu screen.

Use the ▼ and ▲ keys to select the key beeps On or Off as required.

Press the F1 key to initiate the action and return to the main default screen.

6.15 BACKLIGHT

The Backlight menu allows the User to select the timeout period of the control unit's backlight.

When the Backlight is enabled, the control screen will be illuminated whenever there is any user activity. The backlight will remain on with no further user activity for the set period, after which, the backlight will turn off.

The maximum backlight timeout period is programmed by the FPP. The numerical values on the display are in seconds. The choices available for the backlight timeout period are: Always Off; Always On, 2, 5, 10 and 20 secs.

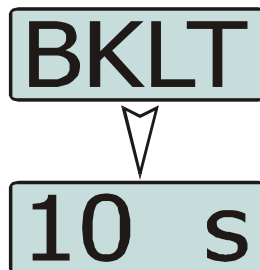

Figure 27. Backlight Menu screen.

Note.

Received radio traffic events will not prevent the backlight timeout.

Use the ▼ and ▲ keys to select the required backlight timeout period.

To accept and save the setting and return to the previous screen, press the F1 key.

6.16 BRIGHTNESS MENU

The Brightness menu allows the User to set the intensity of the control unit's display and key backlighting where this is possible.

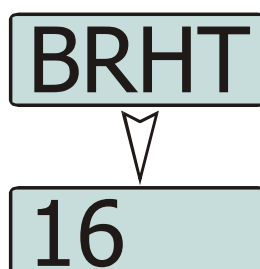

Figure 28. Brightness Menu screen.

Use the ▼ and ▲ keys to select the required brightness level.

To accept and save the setting and return to the main default screen, press the F1 key.

7 SPECIAL FUNCTIONS

Special functions can be programmed to each of the keys/buttons on the SDP650 Portable Radio by the FPP. These special functions can be simple short cuts to specific menus or an on/off toggle facility for specific actions.

7.1 CHANNEL UP AND DOWN

These function keys will change the channel in the upward or downward directions.

7.2 ZONE UP AND DOWN

These function keys will change the zone in the upward or downward directions.

7.3 SCAN ON/OFF

These function keys will start and stop Scanning.

7.4 SKIP

The Skip function removes a scan channel from the scan list if the Skip button is pressed while stopped on that channel. The channel is only restored to the list when the channel is re-selected.

7.5 TALK AROUND ON/OFF

On a repeater channel only, a Talk Around function key allows the radio to transmit on the base station's output channel, so the user can talk directly to other mobiles on the channel, while the repeater is out of service or out of range.

When the key is pressed again (or the Channel is changed) the mobile's Tx channel reverts to its normal setting.

Talk Around mode is indicating to the user by a double beep at the start of each PTT.

7.6 LOW POWER

The Low Power function key forces the radio to low power. Pressing the function button again puts the radio back to the power level defined for the current channel. The "forced low power state" is not affected by channel/zone changes.

7.7 GO TO CHANNEL A, B, C OR D

These functions allow specific zones and channels to be allocated to the keys rather than having to navigate through the menu system or using the ▲ and ▼ buttons.

7.7.1 Go To Contact A, B, C or D

This function allows the first four contact entries to be allocated to the keys rather than having to navigate through the menu system.

7.8 MENU

The Menu function key is used for accessing the menu system.

7.9 ZONE, CHANNEL, CONTACT AND MUTE

These are specific functions that provide direct access to the 'Channel', 'Zone', 'Contact' and 'Mute Adjust' menus.

7.10 RESET

The Reset function is usually assigned to the F6 key, and is used as a cancel function when in a menu or as a backspace when entering keypad dial-strings.

7.11 SPEAKER MUTE

The speaker mute function key will mute the audio output to the speaker. Pressing the function button again will again allow audio to be heard at the speaker.

7.12 MAN DOWN

The Man Down function provides support for the radio's automatic alarm sequence to be executed if the radio's inbuilt accelerometer senses certain unusual patterns in the orientation and movement of the radio.

The detection process uses an orientation "learning" period, immediately after the man down function is enabled, to establish how the radio is normally held.

Once this is established, any significant and prolonged deviation from this orientation or an unexpected acceleration is considered to be an alarm event.

The radio also senses normal walking movement. If this stops for a period of time, this is also considered an alarm event.

Once the Man Down function is triggered, a warning beep will sound and the operator has a set time to disarm the sending of an Alarm Status using a programmed "Man Down" button (see buttons).

The Man Down system sequence is:

- The radio's man down system is enabled by pressing the allocated Man Down button.
- The radio uses a 3D accelerometer to determine the direction of the gravity's 1 g downward acceleration. The direction of this force is averaged during the "learning" time.
- Once trained, the gravity component of the acceleration is removed, leaving only movement, impacts and mis-orientation acceleration to be sensed.
- User movement is monitored for the normal patterns of acceleration associated with the walking movement.
- Mis-orientation is indicated by the gravity force not being cancelled by the "trained" counter-force.
- Falls, impacts and other unexpected trauma can be sensed by sudden accelerations that exceed the force of gravity.
- If any of these events occur, the Man Down audible alert is triggered.
- The user has the set time to cancel the alert or the radio will enter the emergency alarm mode (see Alarm).
- Then the Man Down system uses the radio's emergency automatic voice transmission sequencer, programmed by the Alarm settings, to monitor the audio at the scene of the incident.

7.13 LONE WORKER

Lone Worker is used to initiate emergency alarm mode when the user is unresponsive after a predetermined time. A data message is also sent to the device management software (via the gateway) indicating that the worker may be incapacitated.

The Lone Worker countdown is reset after any user activity with the radio, i.e. either PTT or “Lone Worker” buttons are pressed.

8 ACCESSORIES

The accessories that are available for the SDP650 Portable Radio are listed below in **Table 6**. Contact Simoco for further information.

Table 6. SDP650 DMR Portable Radio Accessories.

Part No.	Description	Notes
PAR-600BATL2	SDP Standard 2200 mAh Li-ion Battery	
PAR-9180LMS2-2	Speaker Microphone with two buttons	Combined speaker and microphone for light duty use incorporating two programmable function keys.
PAR-600LMS4	Speaker Microphone with four buttons	Combined medium duty speaker and microphone incorporating four programmable function keys.
PAR-9180LMW1	Speaker Microphone – IP67	
TBC*	SDP Standard Case	* Available Q2 2013
TBC*	SDP Heavy Duty Case	* Available Q2 2013
PAR-600CRG1	SDP Single Charger Unit Excludes Power Supply (PA-ADAPTOR)	Charger capable of charging one portable radio at a time.
PA-ADAPTOR-UK	SDP Single Charger PSU UK	230 V AC with 3 pin UK fitting
PA-ADAPTOR-EU	SDP Single Charger PSU EU	230 V AC with 3 pin EU fitting
PA-ADAPTOR-SA	SDP Single Charger PSU SA	230 V AC with 3 pin SA fitting
PA-PSU1A5	SDP Single Charger PSU	Excludes Mains Cord (PA-ACCORD-XX8)
PAR-600CRG2	SDP Dual Charger Unit Excludes Power Supply (PA-PSU3A0)	Charger for two portable radios
PA-PSU-3A5	SDP Dual Charger PSU	
PA-ACCORD-UK8	UK Mains Cord for PA-PSU3A0	IEC C7 to UK 3 Pin, 1.8 m
PA-ACCORD-EU8	EU Mains Cord for PA-PSU3A0	IEC C7 to Euro 2 Pin, 1.8 m
PA-ACCORD-SA8	SA Mains Cord for PA-PSU3A0	IEC C7 to SA 3 Pin, 1.8 m
PAR-600GRG6*	SDP Six Way Charger with separate Power Supply	Charger for up to six portable radios. * Available Q2 2013
6102 500 00531	VHF helical Stubby Antenna	136 MHz – 174 MHz. * Available Q2 2013
6102 500 00541*	VHF Moulded Helical Antenna	Un-cut 136 Mhz – 174 MHz (includes cutting chart). * Available Q2 2013
6102 500 00431	UHF Whip Antenna ¼ Wave	400 MHz – 480 MHz (Green)
6102 500 00441	UHF Helical Antenna	400 MHz – 440 MHz (Orange)
6102 500 00451	UHF Helical Antenna	435 MHz – 485 MHz (White)
PAR-600CLIP	SDP 2.5" Belt Clip	Belt Clip for belt widths of up to 50 mm. The clip slots onto the rear of the battery.
PA-LMEP	SDP 1 wire Surveillance Kit	(Rx only)
PA-ACON	SDP Antenna to BNC Adapter	
PAR-9180PRLDU	SDP Programming Lead USB	Universal Serial Bus (USB) programming lead for use with the FPP when configuring the radio.

Part No.	Description	Notes
SA-600IMD	Intelligent Man-Down License	
SA-600MST*	Multi-Site Trunking License	* Available Q2 2013

APPENDICES

A1 ALERT TONES AND MESSAGES

ALERT TONES

The Alert Tones supported by the SDP600 Series Portable Radios are listed below in **Table A1**.

Table A1. Alert Tones.

Tone	Frequency, Tone Duration, Repeats	Description
Key Beep	940 Hz 60 ms	Generated by key presses. Key Beeps can be enabled or disabled in the FPP. Also used when Rotary Knob is changed.
Error Beep	440 Hz 50 ms x5	Generated by invalid key or unsuccessful radio events.
Normal Alert	440 Hz 320 ms	If attempt to skip channel if only 1 remaining channel in scan group.
Power-Off Complete	880 Hz 1 sec	Alert tone generated after radio saves its data and is ready to power down.
PTT Grant	1000 Hz 30 ms	Generated after PTT request granted and radio starts transmitting.
Call Alert	2000 Hz 100 ms x5	When receiving a message.
Emergency	600 Hz 160 ms, 1800 Hz 100 ms	Generate a short confidence beep when alarm mode is activated. This short beep can be enabled/disabled in FPP.
Man Down	1000 Hz 100 ms, 1152 Hz 100 ms 1400 Hz 100 ms, 1600 Hz 100 ms	Generate at low volume during after FPP defined 'Tilt Delay'. If Man-Down still down, then generate at full volume for FPP defined 'Alert Delay' period.
Times UP Alert	(940 Hz 60 ms, 0 Hz 1 sec) x5	5 short beeps repeated at 1 second intervals. Used 5 sec before Transmit limit timer expires. Used 5 sec before Lone Worker time limit expires.



SIMOCO GROUP

Global Headquarters: Field House, Uttoxeter Old Road, Derby DE1 1NH

UK: Tel: 08717 411 050
Fax: 08717 411 049

International: Tel: +44 (0) 1332 375 671
Fax: +44 (0) 1332 375 672

www.simocogroup.com