

RICOH

Digital Camera

RICOH WG-M1

Operating Manual

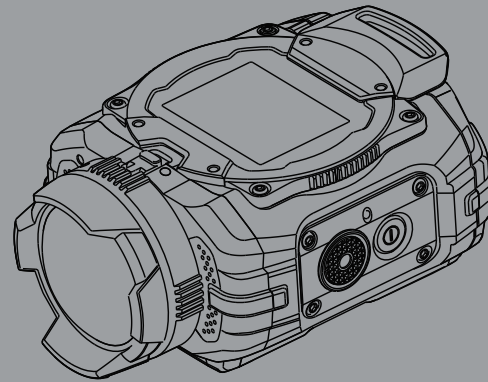

To ensure the best performance from your camera, please read the Operating Manual before using the camera.

Thank you for purchasing RICOH WG-M1.

Please read this manual before using the camera in order to get the most out of all the features and functions. Keep this manual safe, as it can be a valuable tool in helping you to understand all the camera's capabilities.

Regarding copyrights

Images taken using the RICOH WG-M1 that are for anything other than personal enjoyment cannot be used without permission according to the rights as specified in the Copyright Act. Please take care, as there are cases where limitations are placed on taking pictures even for personal enjoyment during demonstrations, performances or of items on display. Images taken with the purpose of obtaining copyrights also cannot be used outside the scope of use of the copyright as laid out in the Copyright Act, and care should be taken here also.

Regarding trademarks

- microSDHC logo is a trademark of SD-3C, LLC.
- Microsoft, Windows and Windows Vista are registered trademarks of Microsoft Corporation in the United States of America and other countries.
- Macintosh, Mac OS, OS X and App Store are trademarks of Apple Inc., registered in the U.S. and other countries.
- Google and Google Play are trademarks of Google Inc.
- HDMI, the HDMI logo, and High-Definition Multimedia Interface are trademarks or registered trademarks of HDMI Licensing, LLC in the United States and/or other countries.
- Intel, Intel Core, and Pentium are trademarks of Intel Corporation in the U.S. and/or other countries.
- This product is licensed under the AVC Patent Portfolio License for the personal use of a consumer or other uses in which it does not receive remuneration to (i) encode video in compliance with the AVC standard ("AVC video") and/or (ii) decode AVC video that was encoded by a consumer engaged in a personal activity and/or was obtained from a video provider

licensed to provide AVC video. No license is granted or shall be implied for any other use.

Additional information may be obtained from MPEG LA, LLC.

See <http://www.mpegla.com>.

- All other trademarks are the property of their respective owners.

- Throughout this manual, the following symbols are used to help you locate information quickly and easily:
 -  Indicates useful information.
- In introducing you how to operate this camera, the following symbol may appear to facilitate your understanding:
 - [Item properties] : The optional properties in the camera interface are indicated by the symbol 「 」 .

To users of this camera



- Do not use or store this device in the vicinity of equipment that generates strong electromagnetic radiation or magnetic fields.

Strong static charges or the magnetic fields produced by equipment such as radio transmitters could interfere with the monitor, damage the stored data, or affect the product's internal circuitry and cause camera misoperation.

- The liquid crystal panel used in the display is manufactured using extremely high precision technology. Although the level of functioning pixels is 99.99% or better, you should be aware that 0.01% or fewer of the pixels may not illuminate or may illuminate when they should not. However, this has no effect on the recorded image.
- There is a possibility that the illustrations and the display screen in this manual are different from the actual product.
- In this manual, the generic term "computer(s)" refers to either a Windows PC or a Macintosh hereafter.
- In this manual, the term "battery(ies)" refers to any type of batteries used for this camera and accessories.

Using Your Camera Safely

We have paid close attention to the safety of this product. When using this product, we request your special attention regarding items marked with the following symbols.

-  **Warning** This symbol indicates that violating this item could cause serious personal injuries.
-  **Caution** This symbol indicates that violating this item could cause minor or medium personal injuries, or loss of property.

About the Camera

 **Warning**

- Do not attempt to take the camera apart or modify the camera. High voltages are present within the camera, and there is a danger of electric shock if the camera is taken apart.
- If the inside of the camera should become exposed as a result of, for example, the camera being dropped, please do not under any circumstances touch such exposed portions, as there is a danger of receiving an electric shock.
- Wrapping the strap of the camera around your neck is also dangerous. Please take care that small children do not hang the strap around their necks.
- If any irregularities occur during use, such as smoke or a strange odor, stop use immediately, remove the battery or the power adapter, and contact your nearest service center. Continuing to use the product can cause a fire or electric shock.

 **Caution**

- Some portions of the camera heat up during use, so please take care, as there is a risk of low temperature burns if such portions are held for long periods of time.
- Should the LCD be damaged, be careful of glass fragments. Also, be careful not to allow the liquid crystal to get on your skin, in your eyes, or in your mouth.
- Depending on your individual factors or physical condition, the use of the camera may cause itching, rashes or blisters. In case of any abnormality, stop using the camera and get medical attention immediately.

About the Power Adapter

 **Warning**

- Always use the power adapter exclusively developed for this product, with the specified power and voltage. Using a power adapter not exclusive to this product, or using the exclusive power adapter with an unspecified power or voltage can cause a fire, electric shock, or camera breakdown. The specified voltage is 100- 240V AC.
- Do not disassemble or modify the product. This can cause a fire or electric shock.
- If the generation of smoke or strange odor from the product or other abnormality occurs, immediately discontinue its use and consult your nearest service center. Continuing to use the product can cause a fire or electric shock.
- If water should happen to get inside the product, consult your nearest service center. Continuing to use the product can cause a fire or electric shock.
- If a thunder storm should occur while using the power adapter, unplug it and discontinue use. Continuing to use the product can cause damage to the equipment, fire, or electric shock.
- Wipe off the plug of the power adapter if it becomes covered with dust. Dust on the plug may cause a fire.

 **Caution**

- Do not place heavy objects on the USB cable, allow heavy objects to drop onto it or allow it to become damaged due to excessive bending. If the USB cable becomes damaged, consult your nearest service center.
- Do not short or touch the output terminals of the product while it is still plugged in.
- Do not plug in the power adapter with wet hands. This can cause an electric shock.
- Do not subject the product to strong impacts or allow it to drop onto a hard surface. This can cause a malfunction.
- Do not use the power adapter to charge a battery other than the rechargeable lithium-ion battery DB-65. This can cause overheating, explosion, or power adapter failure.
- To reduce the risk of hazards, use only a CSA/UL certified power supply cord set, cord is Type SPT-2 or heavier, minimum NO.18 AWG copper, one end with a molded-on male attachment plug cap (with a specified NEMA configuration), and the other is provided with a molded-on female connector body (with a specified IEC nonindustrial type configuration) or the equivalent.

About the Battery

 **Warning**

- Be sure to store the battery out of the reach of small children. Placing it in their mouths may cause an electric shock.
- If any leakage from the battery should come in contact with your eyes, it may cause a loss of sight. Flush your eyes with clean water and get medical attention immediately. Do not rub them.

 **Caution**

- Only use the specified battery with this camera. Use of other batteries may cause an explosion or fire.
- Do not disassemble the battery. Disassembling the battery may cause an explosion or leakage.
- Remove the battery from the camera immediately if it becomes hot or begins to smoke. Be careful not to burn yourself during removal.
- Keep wires, hairpins, and other metal objects away from the + and - contacts of the battery.
- Do not short the battery or dispose of the battery in fire. This can cause an explosion or fire.
- If any leakage from the battery should come in contact with skin or clothes, it may cause irritation to the skin. Wash the affected areas thoroughly with water.
- Precautions for DB-65 Battery Usage:
 - Use designated charger only.
 - Do not incinerate, disassemble, short, use in high temp.

Keep the Camera and Accessories Out of the Reach of Small Children

 **Warning**

- Be sure to keep the camera and its accessories out of the reach of small children.
 1. Injuries may result from the product falling or from unexpected movement.
 2. Suffocation may result from wrapping the strap around the neck.
 3. Small accessories such as battery or a microSD Card may be swallowed. Seek medical attention immediately if an accessory is accidentally swallowed.

Care to be Taken During Handling

Before Starting Use

- When the camera has not been used for a long time, confirm that it is still working properly, particularly prior to taking important pictures (such as at a wedding or when traveling). Contents of the recording cannot be guaranteed if recording, playback or transferring your data to a computer, etc. is not possible due to a malfunction of your camera or recording media (microSD Card), etc.
- The lens on this camera is not interchangeable. The lens is not removable.

About the Battery and Power Adapter

- Storing the battery fully charged may decrease the battery performance. Avoid storing it especially in high temperatures.
- If the battery is left inserted and the camera is not used for a long time, the battery will over-discharge and shorten the battery's service life.
- Charging the battery a day before use or on the day of use is recommended.
- The power adapter supplied with the camera is for exclusive use with this camera. Do not use it with any other equipment.

Cautions when Carrying and Using the Camera

- Do not use or store the camera in a hot environment or under direct sunlight.
- Hot and humid places should be avoided. Particular care should be taken regarding vehicles, which can become very hot inside.
- The temperature range in which the camera can be used is -10°C to 40°C (14°F to 104°F).
- The liquid crystal display will become black at high temperatures but will return to normal at normal temperatures.
- The response speed of the liquid crystal display becomes slow at low temperatures. This is due

to the properties of the liquid crystal and is not a malfunction.

- If the camera is subjected to rapid temperature changes, condensation may form on the inside and outside of the camera. Therefore put the camera in a bag or plastic bag and take the camera out when the difference in temperature has subsided.
- Avoid contact with garbage, mud, sand, dust, water, toxic gases, or salts. These could cause the camera to breakdown. Wipe the camera to dry off any rain or water drops.
- Please do not press forcefully on the display. This could cause it to break or malfunction.
- Be careful not to sit down with the camera in you back pocket as this may damage the exterior of the camera or the display.
- When using a tripod with the camera, be careful not to overtighten the screw in the tripod socket on the camera.

About Repairs

- Do not clean the product with organic solvents such as thinner, alcohol or benzine.
- Use a lens brush to remove dust accumulated on the lens. Never use a spray blower for cleaning as it may damage the lens.

About Storage

- Avoid storing the camera where pesticides and chemicals are handled. Remove the camera from its case and store it in a well-ventilated place to prevent the camera from becoming moldy during storage.
- Avoid using or storing the camera where it may be exposed to static electricity or electrical interference.
- Avoid using or storing the camera in direct sunlight or in locations where it may be exposed to rapid changes in temperature or to condensation.
- Periodic checks are recommended every 1 to 2 years in order to maintain high performance.

Others

- Care should be taken when removing the microSD Card immediately after using the camera, as the card may be hot.
- Keep the battery/card cover closed and do not remove the microSD Card or turn the camera off while the data is being played back or saved to the card, or the camera is connected to a computer with the USB cable, as this may cause the data to be lost or the card to be damaged.
- Do not bend the microSD Card or subject it to violent impact. Keep it away from water and store away from high temperature.
- Do not remove the microSD Card during formatting as this may damage the card and render it unusable.
- The data on the microSD Card may be lost in the following circumstances. We do not accept any liability for data that is deleted
 1. when the microSD Card is mishandled by the user.
 2. when the microSD Card is exposed to static electricity or electrical interference.
 3. when the microSD Card has not been used for a long time.
 4. when the microSD Card is ejected or the batteries are removed while the card is being accessed.
- If it is not used for a long time, the data on the card may become unreadable. Be sure to regularly make a backup of important data on a computer.
- Be sure to format microSD Card that are unused or have been used on another camera.
- Please note that deleting data, or formatting the microSD Card or the built-in memory does not completely erase the original data. Deleted files can sometimes be recovered using commercially available software. It is user's responsibility to ensure the privacy of such data.

Regarding Waterproof, Dustproof, and Shockproof Design

- This camera is provided with a waterproof/dustproof design complying with JIS waterproof grade 8 and JIS dustproof grade 6 (equivalent to IP68).
- The camera satisfies our drop test (2 m height onto a 5 cm thick plywood surface) complying with MIL-Standard 810F Method 516.5-Shock testing.
- The camera satisfies our test for the waterproof, dustproof, and shockproof performance, but this does not guarantee it will remain free of trouble or damages.
- Waterproof performance is not guaranteed if the camera is exposed to impact such as being dropped or hit.
- Be sure to attach the underwater lens protector O-LP1532 included in the package to the camera when using the camera in the water. Waterproof performance is guaranteed only when the camera is equipped with the lens protector.

Precautions Before Using the Camera in the Water

Check the Following Before Going Near the Water

- Make sure that there are no cracks or scratches on the rubber seal of the battery/card cover.

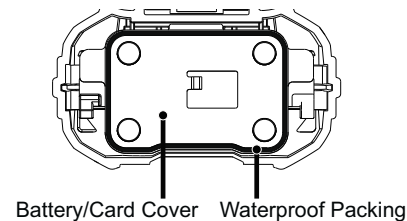

- Make sure there are no foreign objects (dust, sand, hair, lint or liquid) on the rubber seals or the surface they contact before closing the battery/card cover. Wipe off any foreign objects with a clean lint-free cloth.
- Close the battery/card cover properly until it click. Otherwise water may get in and damage the camera.

Be Careful Near the Water

- Avoid opening the battery/card cover when near the waterside or with wet hands. Wait until the camera is completely dry before changing the battery or the microSD Card. Avoid changing the battery or card where the camera is likely to get wet or dirty, and make sure that your hands are dry.
- The camera will sink if dropped in water, so be sure to attach the strap and slip the strap over your wrist when using the camera in or near water.
- To enhance the waterproof performance of the camera, the front of the lens is protected by glass. As any dirt or water on the glass will affect the quality of pictures taken, the glass should be kept clean at all times.

Precautions When Using the Camera in the Water

- Do not use the camera deeper than 10 meters underwater. Do not use the camera underwater for more than 60 minutes consecutively.
- Do not open the battery/card cover underwater.
- Do not use in hot water or in a hot spring.
- Do not apply excessive force to the camera, for example diving into water with it. Doing so may compromise the waterproof performance of the camera or cause the cover to open.
- Leaving the camera on the sand at the beach may cause the camera to exceed its operating temperature or cause the speaker or microphone to become blocked with sand.
- Avoid subjecting the camera to substantial vibrations, shocks, or pressure as this may cause a

loss in waterproof performance. If the camera is subjected to substantial vibrations, shocks or pressure, take your camera to your nearest service center and have it checked.

- Avoid getting sunscreen or sun oil on the camera as it may cause discoloration of the surface. If any oil gets on the camera, wash it off immediately with warm water.
- Sudden and extreme changes in temperature may cause condensation to form in and on the camera. Keep the camera in a bag or case to reduce the difference in temperature.

Precautions After Using the Camera in the Water

- Do not open the battery/card cover if the camera is wet. Wipe off any water with a clean lint-free cloth.
- The inside surface of the cover may get wet when it is opened. Wipe off any water that is on the cover.
- Wiping off the camera while there is sand or dust on it may scratch the surface of the camera. Make sure that the battery/card cover is firmly closed before washing the camera in tap water. After washing the camera, dry it with a soft cloth.
- Wipe off any dirt or sand on the waterproof packing or the packing contact surface. The camera's waterproof performance may be compromised by loose packing or cracks or dents in the packing or packing contact surface. If there is any such damage, contact your nearest service center.
- If the camera is very dirty or after it has been used in the sea, make sure that it is turned off and the battery/card cover is firmly closed before rinsing it under running tap water or leaving it in a bowl of clean water for a short time (2 or 3 minutes).

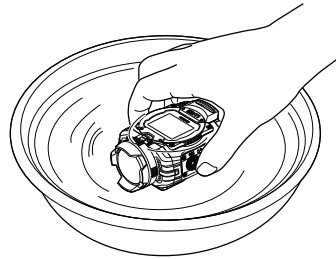

- Avoid cleaning with agents such as soapy water, mild detergents, or alcohol as this may compromise the waterproof performance of the camera.
- To maintain the waterproof performance of the camera, you are recommended to change the waterproof packing once a year. Contact your nearest service center regarding changing the packing. (A charge will be made.)
- The camera's accessories are not waterproof (excluding underwater lens protector O-LP1532.).

Contents

Using Your Camera Safely.....	4
Care to be Taken During Handling.....	8
Regarding Waterproof, Dustproof, and Shockproof Design	11
Contents	15
Getting Ready.....	19
Accessories Included.....	19
Part Names	21
Attaching the Carabiner Strap	23
Attaching and Removing the Lens Protector	24
Installing Battery and Memory Card	26

Charging	28
Introduction to Various Button Functions	29
Operation Method	31
Turn On / Off	31
Set your Language, Date and Time after the first power-on	32
LCD Screen Display	33
Introduction to Basic Operation of Recording and Shooting	34
LCD Screen Display under Playback Mode	36
Introduction to Basic Operation of Playback	37
Introduction to the Setting Mode of Menu Options	41
Menu Introduction	42

Introduction to General Settings	43
Introduction to Mode Settings	47
Movie Settings Introduction	48
Still Settings Introduction	55
AP Settings Introduction	58
Smart Device APP Operating Method	61
Position Service Function	61
APP Home	63
Playback	63
Remote Viewfinder.....	73
About	76

Connection Port Introduction	77
Connect to a Computer.....	77
HDMI Connected TV Output.....	78
Appendices.....	79
Main Specifications.....	79
Prompts and Warning Messages.....	84
Using the WG Flat Adhesive Mount O-CM1531	87
Warranty Policy	90

Getting Ready

Accessories Included

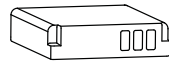

Rechargeable lithium-ion battery
DB-65

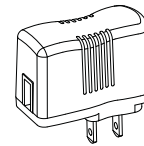

Power adapter
GAC-03



USB cable
I-USB152

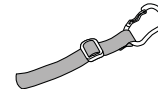

Carabiner strap
O-ST153



Quick start guide

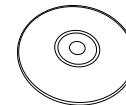

Operating Manual
(CD-ROM)

 The plug shape of the power adapter may vary depending on the country or region. The actual item may vary from the drawing.

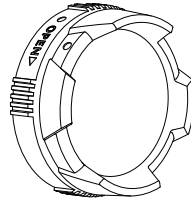

Lens protector
O-LP1531

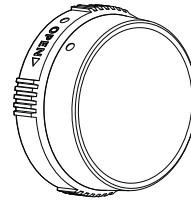

Underwater lens protector
O-LP1532

- 📖 Lens protector O-LP1531 has been installed on the product when leaving factory.
- 📖 In order to guarantee the waterproof and dustproof performance, please make sure to attach the lens protector to the camera all the time. Waterproof performance is guaranteed only when the camera is equipped with the underwater lens protector O-LP1532.

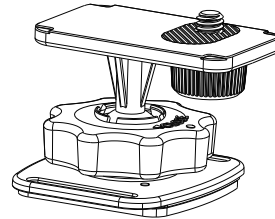

WG Flat Adhesive Mount
O-CM1531

Part Names

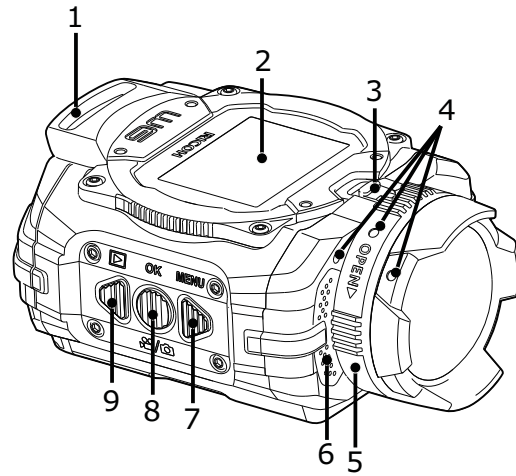

1	Strap Lug
2	LCD Screen
3	Lens Protector Lock
4	Alignment Points
5	Lens Protector
6	Microphone
7	Menu Button / Direction Button (Upper)
8	OK Button
9	Playback Button / Direction Button (Lower)

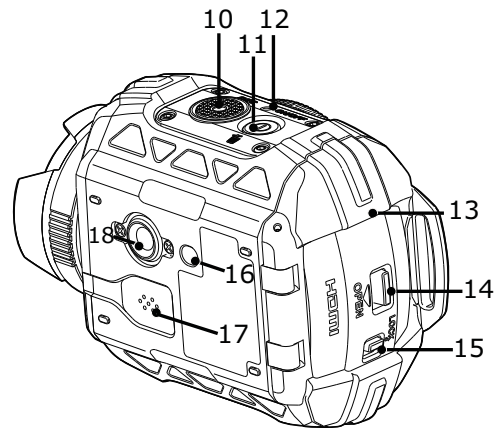

10	Video Recording Button / Shutter Button
11	Power Button / Delete Button
12	Status Indicator
13	Battery / Card Cover
14	Cover Open Switch
15	Cover Lock
16	Positioning Hole
17	Speaker
18	Tripod Socket

Attaching the Carabiner Strap

Attach the carabiner strap supplied with the camera.

1. Pass the end of the strap through the strap lug on the camera.
2. Fix the end of the strap to the stopper.

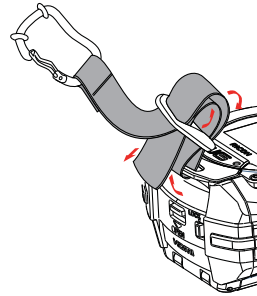

Protective rubber ring

The carabiner has rubber rings to prevent damage to the display. These rubber rings cushion the impact when the carabiner hits the display.

Be sure to adjust the position of the rubber rings as shown in the figure below for the best results before using the carabiner strap.

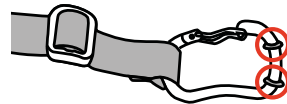

Attaching and Removing the Lens Protector

Two types of replaceable lens protectors are provided for the product. Please put the lens protector on all the time to ensure the waterproof and dustproof performance.

Lens protector O-LP1531:

Applicable for general use. Do not use underwater.

Visual angle in the air is about 160° (*1). Will not focus underwater.

(*1) Still, 4:3, Field of View: Wide

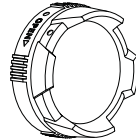

Underwater Lens protector O-LP1532:

Applicable for use in water.

Visual angle in the air is about 130° (*2), and visual angle in water is about 90° (*2).

(*2) Still, 4:3, Field of View: Underwater

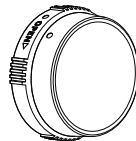

Steps for removing the lens protector:

1. Slide the lens protector lock in the direction shown by arrow ①, and rotate the lens protector in the direction shown by arrow ②.

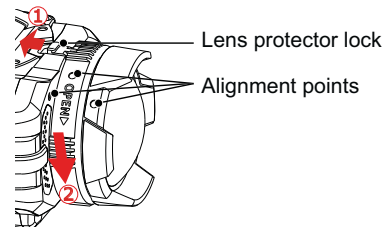

2. When three alignment points are in a straight line, remove the lens protector.

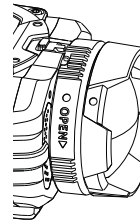

Steps for installing the lens protector:

Slide the lens protector lock in the direction shown by arrow ①. When three alignment points are in a straight line, rotate the lens protector in the direction shown by arrow ② until it clicks.

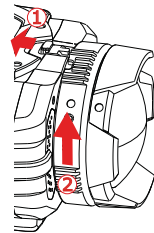

When the product is exposed to fluctuations in temperature, condensation may form on the inside surface of the lens protector. If this happens, remove the lens protector, clean it with a soft, dry, lint-free cloth, and then reinstall in the lens.

Installing Battery and Memory Card

1. Open the battery/card cover

First, move the cover lock to the right (①), and push down on the cover open switch (②) to open the battery/card cover around the axis in the downward direction.

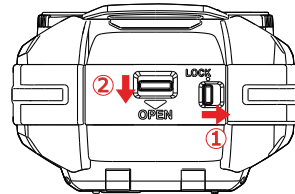

2. Insert the battery into the battery compartment according to the negative and positive directions as illustrated in the following picture.

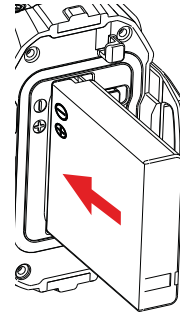

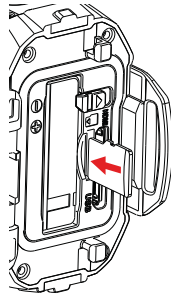

3. Insert the memory card into the card slot according to the direction illustrated in the picture when the product is turned off. When inserting a memory card, make sure to match the notch of the card and of the card slot. Do not push forcibly the memory card into the card slot.



4. Close the battery/card cover

Close the battery/card cover around the axis in the upward direction until it clicks, and move the cover lock to the left.

-  Memory card (refers to microSD card or microSDHC card) is optional, which is not included in the product package and needs to be purchased separately. It is recommended to use a memory card of Class 4 or higher.
-  To remove the memory card, please open the battery/card cover and gently push the memory card. After it is ejected, remove the card carefully.
-  The product will automatically turn off if the memory card is inserted and extracted when the product is on.

Charging

Please charge after the product is turned off.

1. Connect the product to the power adapter with the USB cable.
2. Then insert the plug of the power adapter to the power outlet for charging.

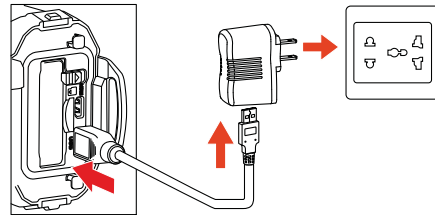



After the battery is stored for a long period, use the supplied power adapter to charge the battery prior to use.

Charging indicator:
Red flash: Charging
The indicator will go out once charging is finished, and the camera will be powered off automatically.





To have maximum battery life, charge the battery for at least 4 hours the first time.



The longest charging time is 200 minutes (it depends on ambient temperature and charging condition). Please charge the battery indoors between 0°C and 40°C (32°F to 104°F).

Introduction to Various Button Functions





-  Viewfinder status refers to viewfinder of recording and shooting.
-  To save power, if the product is not operated for 30 seconds, it will automatically enter the LCD off status (power saving mode). Pressing any button can wake LCD.

Video mode or shooting mode:

Button	Name	Menu Status	Viewfinder Status	During Video Recording
	Power Button / Delete Button	-	Display all the hidden information	-
		Press and hold: turn off the product		
	OK Button	Confirm selection	Switch between video mode and shooting mode	-
	Menu Button / Direction Button (Upper)	Switch menu	Enter the mode setting interface	-
	Playback Button / Direction Button (Lower)	Switch menu	Enter playback mode	-
	Video Recording Button / Shutter Button	Enter viewfinder status (except Wireless feature)	Start recording / Shoot a photo	Stop recording

-  In the viewfinder status, when the Motion detection or Time Lapse function is set to be enabled, press  to enter the state of preparing for video recording.

Playback mode:

Button	Name	Photo Playback	Movie Playback		
			Playing Back	Fast Forwarding / Rewinding	Pausing
	Power Button / Delete Button	Delete	Back to the initial state of the movie		
		Press and hold: turn off the product			
	OK Button	Photo file: no action Movie file: start playback	Pause	Normal speed playback	Continue to play back
	Menu Button / Direction Button (Upper)	Previous File	Rewind	Rewind	Previous Frame
	Playback Button / Direction Button (Lower)	Next File	Forward	Forward	Next Frame
	Video Recording Button / Shutter Button	Enter viewfinder status	-		

Operation Method

Turn On / Off

Turn on:

When the power is off, press and hold ① for more than 2 seconds to turn on the product; or press and hold ⏮ for more than 2 seconds to turn on the product and enter playback mode.

Turn off:

When the power is on, press and hold ① for more than 2 seconds to turn off the product.

Set your Language, Date and Time after the first power-on

Please set at the first time you use.

1. Press and hold the ① to turn on the product and enter the language selection screen;
2. Press ◀ or ▶ to select language;
3. After pressing ⏺ button to select desired language, the product will enter [Date / Time] setting screen;
4. Press ◀ or ▶ to adjust the date and time display format, and press ⏺ to confirm the display format;
5. In the date and time options, press ◀ or ▶ to adjust the values, and press ⏺ to confirm;
6. After confirming, 📷 automatically appears in a frame. Press ⏺ to enter the viewfinder status.

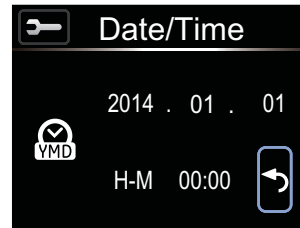

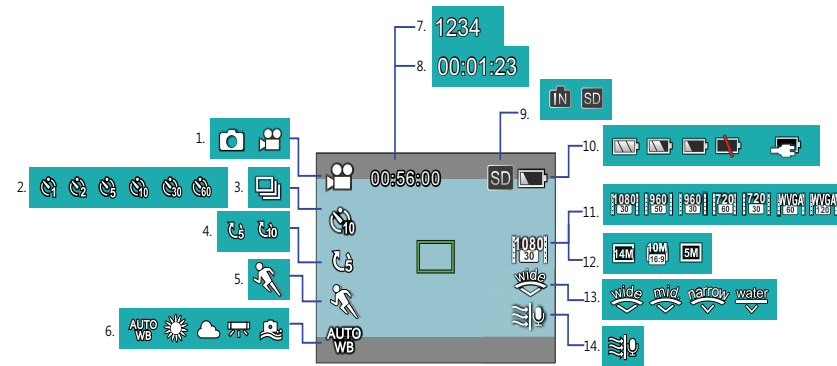

LCD Screen Display





- | | |
|--------------------------------------|--|
| 1. Mode Display | 8. Remaining Recording Time Display |
| 2. Time Lapse Display | 9. Internal Memory / Memory Card Display |
| 3. Burst Shot Display | 10. Battery Status Display |
| 4. Loop recording Display | 11. Movie Size Display |
| 5. Motion detection Display | 12. Still Size Display |
| 6. White Balance Display | 13. Field of View Display |
| 7. Number of remaining shots Display | 14. Wind Cut Display |

 Some icons will automatically hide after 2 seconds. Press **ⓘ** to display all current setting.

  Indicates 16:9 display range.

  Indicates 4:3 display range.

Introduction to Basic Operation of Recording and Shooting

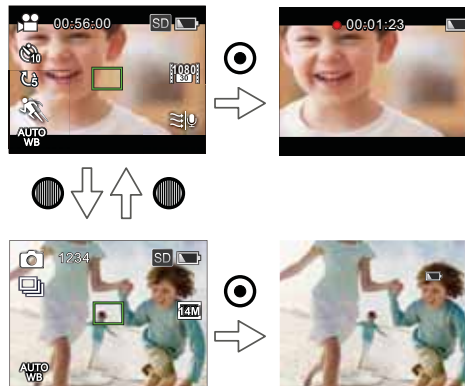

1. Enter the viewfinder status, and press  to switch between video mode and shooting mode;
2. Align the lens to the object to be recorded, and press  for video recording or shooting;
3. Under the video mode, repress the  to stop recording.

 The longest recording time is 25 minutes at one time.

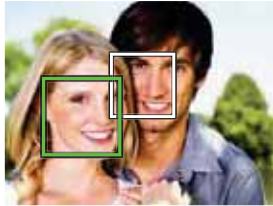

Under shooting mode, when the product detects a human face, a green focus frame will appear. When two or more human faces are detected, a green main focus frame and a white secondary focus frame will appear.



 When in shooting and video mode, the LCD may turn off to save power. Pressing  will turn on the LCD and immediately initiate / terminate recording. Pressing any other button will only turn on the LCD.

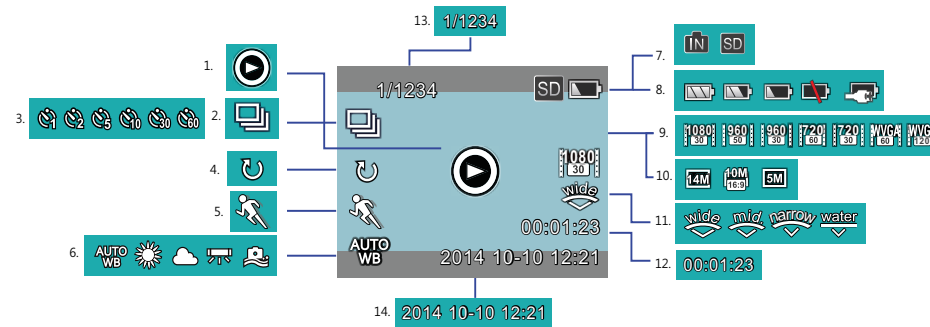

LCD Screen Display under Playback Mode





- | | | |
|---|--|---|
| 1. Movie Display | 10. Still Size Display | Some icons will automatically hide after 2 seconds. |
| 2. Burst Shot Display | 11. Field of View Display | |
| 3. Time Lapse Display | 12. Movie Time Length Display | only displayed when playing back the movie file. |
| 4. Loop recording Display | 13. Display of Current number of Shots / Total Number of Shots | |
| 5. Motion detection Display | 14. Shooting Time and Date Display | Indicates 16:9 display range. |
| 6. White Balance Display | | |
| 7. Memory Card or Internal Memory Display | | Indicates 4:3 display range. |
| 8. Battery Status Display | | |
| 9. Movie Size Display | | |

Introduction to Basic Operation of Playback

Single Photo:

1. When in viewfinder status, press  to enter the playback mode of video and pictures;
2. Display movie or picture files on the LCD screen;
3. Press  or  to view the movies or pictures stored in the memory card or internal memory.

 Press  to return to the viewfinder status.

 When the memory card is inserted, only files in the memory card will be displayed, files on internal memory will not be displayed.

 If there are no files in the memory card or internal memory, a no image warning will appear.

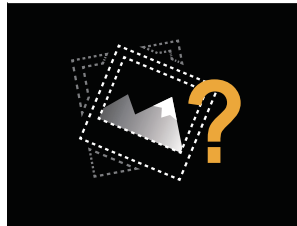

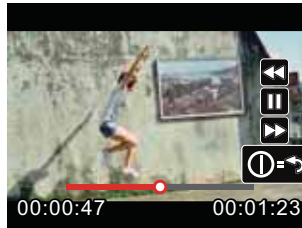

Movie Playback:

1. Select movie to be played back, and press  to start movie playback.



2. When playing back the movie, an operation guidance will appear on the screen. You can press buttons to perform the corresponding functions.

Press  : Movie playback rewind, multiple presses will fasten the speed: x2 / x4 / x8 / x16

Press  : Movie playback forward, multiple presses will fasten the speed: x2 / x4 / x8 / x16

Press  : Under normal playback mode, the movie playback will be paused; under the forward, rewind or pause status, normal speed playback will be recovered

Press  : Movie playback back to the initial state

Movie playback rewind or forward:

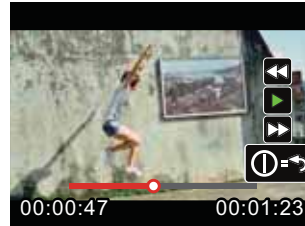

Movie playback pause:

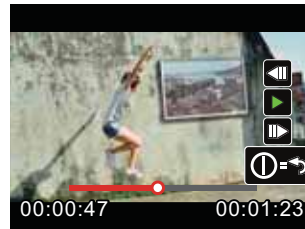

 There will be no sound output during rewinding or forwarding.

Movie or Picture Delete:



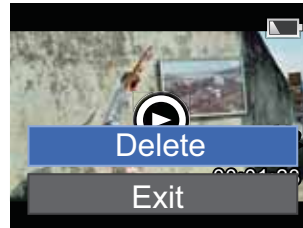







1. Select the movies or photos to be deleted, and press **ⓘ** to enter the Delete screen. Press **▶** or **◀** to select [Delete] , and press **Ⓚ** to confirm.
2. After a movie or a photo is successfully deleted, the LCD will display the next movie or photo. If you wish to delete additional files, please repeat the above step.
3. If you want to exit the Delete screen, select [Exit] , and press **Ⓚ** to confirm.



ⓘ Movie and / or pictures cannot be restored after being deleted.

ⓘ A protected file cannot be deleted.

Introduction to the Setting Mode of Menu Options

1. Under the viewfinder status, press  to enter the setting menu;
2. Press  or  to select [Mode Settings] , [Movie Settings] , [Still Settings] , [AP Settings] and [General Settings] ;
3. Select one item (except for [Mode Settings]), press  to enter the secondary level menu interface;
4. Press  or  to select one item, and press  to enter the tertiary menu interface;
5. Press  or  to select one item, and press  confirm. Select [Exit] and press  to back to the first level menu interface.



In the menu interface (except for the Wireless connecting status in AP Settings), press  to return to the viewfinder status.

Menu Introduction

First Level Menu	Mode Settings	Movie Settings	Still Settings	AP Settings	General Settings
Secondary Level Menu	Movie	Movie Size	Still Size		Sound Settings
	Still	Time Lapse	Burst Shot		Power Off
		Loop recording	Field of View		Wireless Power Saving
		Field of View	White Balance		Date / Time
		Motion detection	Exit		Language
		Wind Cut		-	Format
		White Balance			Copy to Card
		Exit			Reset Settings
				FW Version	
				Screen rotate	
				Exit	





Introduction to General Settings

11 options in [General Settings] of the first level menu:

- [Sound Settings]
- [Power Off]
- [Wireless Power Saving]
- [Date / Time]
- [Language]
- [Format]
- [Copy to Card]
- [Reset Settings]
- [FW Version]
- [Screen rotate]
- [Exit]

Sound Settings

There are 4 options in [Sound Settings] :

-  Volume 1
-  Volume 2
-  Volume 3
-  Off

Power Off

Power Off means the product will automatically shut down in 60 seconds after the LCD is off.

There are 2 options in [Power Off] :



-  Off
-  60 seconds

 The Power Off will be invalid during recording, movie playing back and wireless connecting.

Wireless Power Saving











Wireless Power Saving mode means that after 30 seconds of remote-controlled recording with the APP, the wireless connection will automatically disconnect, but the product will continue to record until it is turned off. Wireless Power Saving mode will prolong battery life.

There are 2 options in [Wireless Power Saving] :

-  Off
-  Enable





Date / Time

Date and time can be set when the product is turned on for the first time. If you wish to change the date or time thereafter, please operate as the following.

1. Enter [Date / Time] in the secondary level interface and press  to confirm;
2. Press  or  to adjust the date and time display format, and press  to confirm the display format;
3. In the date and time options, press  or  to adjust the values, and press  to confirm;
4. After the setting is completed, select , and press  to return to [Date / Time] in the secondary level interface;
5. Press  to return to the viewfinder status.

Language

The language can be set when the product is turned on for the first time. If you wish to change the language thereafter, please operate as the following.

1. Enter [Language] in the secondary level interface and press  to confirm;
2. Press  or  to select language;
3. Press  to confirm and back to [Language] in the secondary level interface;
4. Press  to return to the viewfinder status.

Format

Format can clear all data stored in the memory card or memory (including protected movies and photos).

There are 2 options in [Format] :



-  Cancel
-  Confirm

 When a memory card is inserted, only the card can be formatted. If you need to format the internal memory, remove the memory card first.

Copy to Card

Copy to Card is to copy the files in the internal memory to the memory card.

There are 2 options in [Copy to Card] :

-  Cancel
-  Confirm





When the memory card cannot be detected by the product, options will not be displayed on [Copy to Card] interface.

Reset Settings

Reset Settings can reset all product settings to the factory defaults.

There are 2 options in [Reset Settings] :

-  Cancel
-  Confirm

FW Version



FW Version can display the current firmware version.

Screen rotate

When this function is enabled, the display on the LCD screen will rotate 180 degrees (up and down).



Images transferred from the camera can be played back on your computer with a software that supports image rotation.

There are 2 options in [Screen rotate] :







-  Off
-  Enable





Introduction to Mode Settings

2 options in 「Mode Settings」 of the first level menu:

-  「Movie」 : for recording movies
-  「Still」 : for shooting photos

Mode Settings method of operation:

1. After selecting  or  options, press  to confirm.
2. Press  to enter the viewfinder status, and display your selected  or  status.

 Under the viewfinder status, directly press  to switch  or  status.

Movie Settings Introduction

There are 8 options in first level menu [Movie Settings] :

- [Movie Size]
- [Time Lapse]
- [Loop recording]
- [Field of View]
- [Motion detection]
- [Wind Cut]
- [White Balance]
- [Exit]

Movie Size

Movie Size indicates the image resolution during recording.

There are 7 options in [Movie Size] :

 [1080p30] : 1920×1080 (30fps)

 [960p50] : 1280×960 (50fps)



 [960p30] : 1280×960 (30fps)

 [720p60] : 1280×720 (60fps)









 [720p30] : 1280×720 (30fps)





 [WVGA60] : 848×480 (60fps)

 [WVGA120] : 848×480 (120fps)

 When selecting , the product shoots ultra high speed movies, and plays back with normal 30 fps speed, in order to capture visually indistinguishable moments easily.

 When selecting , the maximum recordable time is 60 seconds. When the time reaches 60 seconds, the product will automatically stop recording and return to the viewfinder status.







-  When selecting , the sound cannot be recorded.
-  When selecting , [Time Lapse] , [Loop recording] or [Motion detection] cannot be enabled.
-  When selecting , [Time Lapse] or [Loop recording] cannot be enabled.
-  The longest recording time is 25 minutes at one time.
-  Please use a memory card (Class 4 or above) for video recording.

Movie Size	Image Size	Frame Rate	The maximum recording time (4GB)
 1080p30	1920×1080	30fps	31min. 39sec.
 960p50	1280×960	50fps	31min. 39sec.
 960p30	1280×960	30fps	49min. 40sec.
 720p60	1280×720	60fps	35min. 11sec.
 720p30	1280×720	30fps	1hr. 3min. 45sec.
 WVGA60	848×480	60fps	1hr. 3min. 43sec.
 WVGA120	848×480	120fps	35min. 10sec.

Time Lapse



Time Lapse enables the recording of an interval of time, and splices the frames together to present a condensed video which usually requires a long period of time to complete.

There are 7 options in [Time Lapse] :







-  Off
-  1 second
-  2 seconds
-  5 seconds
-  10 seconds
-  30 seconds
-  60 seconds

Time Lapse method of operation:

1. After selecting Time Lapse time, press  to back to the viewfinder status. LCD will display corresponding icons;

2. Press , the LCD will display red font time countdown;
3. Press  again to finish recording.





-  Movie Size cannot be set to  or .
-  The sound cannot be recorded.
-  When Loop recording or Motion detection is enabled, the Time Lapse feature cannot be used.
-  The longest recording time is 25 minutes at one time.



Loop recording

Loop recording allows to record independent segments of movies according to selected time length. The product will continually record movies until the video recording button is pressed to terminate recording. When the memory card is full, the product will overwrite the recorded files to record another movies circularly.







There are 3 options in [Loop recording] :

-  Off
-  5 minutes
-  10 minutes

Loop recording method of operation:

1. After selecting Loop recording time, press  to return to the viewfinder status. LCD will display corresponding icons;
2. Press  to start recording;
3. Press  again to finish recording.



-  Movie Size cannot be set to  or .
-  When Time Lapse or Motion detection is enabled, the Loop recording feature cannot be used.
-  Loop recording feature can only be used when there is a memory card in the product.
-  Turn off the product when the Loop recording function is enabled and then restart the product. You'll find the Loop recording function is still enabled.



Field of View



Field of View sets the viewing angle.

There are 4 options in [Field of View] :

-  Wide
-  Medium
-  Narrow
-  Underwater

Field of View method of operation:



1. After selecting the Field of View angle, press  to return to the viewfinder status. LCD will display corresponding icons;
2. Press  to start recording;
3. Press  again to finish recording.

 Medium or Narrow can only be selected when the Movie Size is set to . If a Movie Size other than  is selected under Medium or Narrow status, the product will automatically set the Field of View to Wide.



Motion detection

Motion detection means that if the product detects moving objects entering into the LCD screen, it will automatically start recording. During the recording process, if there is no moving object detected for 10 consecutive seconds, the recording will pause automatically.

There are 2 options in [Motion detection] :

-  Off
-  Enable

Motion detection method of operation:

1. After the Motion detection is enabled, press  to back to the viewfinder status. LCD will display corresponding icons;
2. Press . If the product detects moving objects, it will automatically start recording;
3. The product will stop recording when there is no moving object detected for 10seconds;
4. When the object moves again, the product will start recording automatically, and this time it will regenerate a video file;
5. Press  to stop recording.

When Motion detection is enabled, Time Lapse or Loop recording setting cannot be performed.

Movie Size cannot be set to 

Motion detection interface icon:

- ① Indicates the total time of recording
- ② Indicates the time of the recording
- ③ Indicates the total time from the beginning of recording



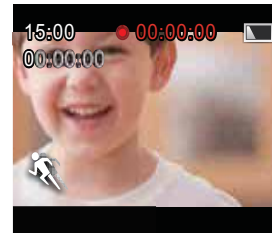

When the memory card is full, ① will become red font and flashes for 2 seconds.





Wind Cut

Wind Cut reduces noise caused by wind.

There are 2 options in [Wind Cut] :

-  Off
-  Enable

Wind Cut method of operation:





1. After the Wind Cut is enabled, press  to return to the viewfinder status. LCD will display corresponding icons;
2. Press  to start recording;
3. Press  again to finish recording.





White Balance

White Balance means that the user adjusts the color temperature under different light sources to ensure that the colors of the subjects are reproduced correctly.

There are 5 options in [White Balance] :

-  AWB
-  Daylight
-  Cloudy
-  Fluorescent
-  Underwater

White Balance method of operation:

1. After the White Balance is set, press  to return to the viewfinder status. LCD will display corresponding icons;
2. Press  to start recording;
3. Press  again to finish recording.

Still Settings Introduction

There are 5 options in first level menu [Still Settings] :

- [Still Size]
- [Burst Shot]
- [Field of View]
- [White Balance]
- [Exit]

Still Size

Still Size indicates the number of pixels for still pictures.

There are 3 options in [Still Size] :

- [14M] : 4320×3240(4:3)
- [10M] : 4320×2432(16:9)
- [5M] : 2592×1944(4:3)

Number of photos that can be stored on a 4GB memory card:

Still Size	Approximate maximum number of images
14M	911 shots
10M	1208 shots
5M	2391 shots



Burst Shot

Burst Shot allows ten photos to be captured continuously at one time.

There are 2 options in [Burst Shot] :

-  Off
-  Enable

Burst Shot method of operation:

1. After Enable in Burst Shot is selected, press  to return to the viewfinder status. LCD will display corresponding icons;
2. Press  to start Burst Shot shooting. It will stop after 10 photos are taken.



Field of View

Field of View sets the viewing angle.

There are 4 options in [Field of View] :

-  Wide
-  Medium
-  Narrow
-  Underwater

Field of View method of operation:





1. After selecting the Field of View angle, press  to return to the viewfinder status. LCD will display corresponding icons;
2. Press  to shoot.

 When the still size is set to [5M] , Medium and Narrow cannot be enabled.



White Balance

White Balance means that the user adjusts the color temperature under different light sources to ensure that the colors of the subjects are reproduced correctly.

There are 5 options in [White Balance] :

-  AWB
-  Daylight
-  Cloudy
-  Fluorescent
-  Underwater

White Balance method of operation:

1. After an option of the White Balance is selected, press  to return to the viewfinder status. LCD will display corresponding icons;
2. Press  to shoot.

AP Settings Introduction

The camera can be wirelessly connected with your smart device.

Please review the following items before your first connection:

1. Your smart device system version needs to be iOS 6.0-7.1 or Android 4.0-4.3. If not, please upgrade your smart device system version first.
2. Please do not use in places having high intensity magnetic field, electrostatic and electric wave interference (for example near a microwave oven), which may cause failure in receiving signals.
3. Please maintain a distance between the camera and the smart device less than 10 meters (32.8 feet) without signal shielding interference.
4. Please do not use wireless connection function on a plane.
5. The camera and the smart device can only be connected one to one.
6. When the temperature of the battery is too high.
 - ① AP setting cannot be enabled;
 - ② Wireless connection will be automatically disconnected.

Connection setting method of the camera and the smart device:

Step 1: Install the dedicated application on the smart device.

Download the dedicated application (WG-M1) from Google Play or App Store, and install it on your smart device.

Step 2: Setting up the camera

Press in the viewfinder status, select [AP Settings], and press to enable wireless connection function so that the SSID screen in [AP mode] appears. SSID and WPA2 password messages are displayed in the screen.



SSID screen

Wireless connection process takes about 30 seconds. During this process, only is activated.

Press or to select , then press to change the WPA2 password.

If there is a need to turn off wireless, press button or press after selecting , so that the selection interface appears. Select , press to turn off wireless.

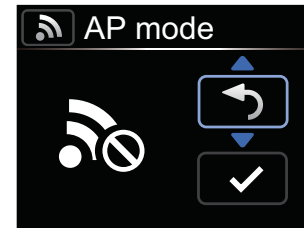

Wireless connection interrupted screen

Step 3: Setting up the smart device

1. Enable the wireless function of the smart device to search surrounding wireless devices;
2. Select the name of the camera to be connected (RICOH-WG-M1_XXXX), and input the eight-digit digital password displayed next to WPA2-PSK on the camera;

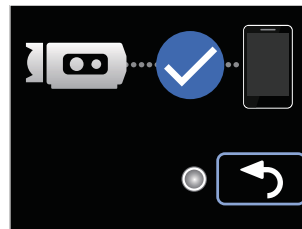





Wireless connected screen

If press  , the camera returns to the SSID interface.

3. Click the icon  to enable the application (APP hereafter).



APP connected screen

If there is a need to interrupt the connection, press  , so that the connection interrupted screen appears. Press  or  to select  , press  to interrupt the connection and return to the SSID screen.

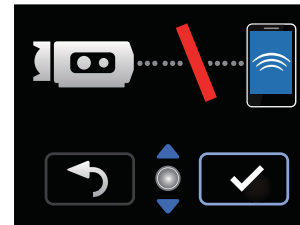

Connection interrupted screen

Smart Device APP Operating Method

Position Service Function

The APP supports the position service function on your device. It can record GPS information in the photo files. This function is not supported for movie files.

Android system:

1. When the APP is enabled for the first time, it may prompt that 「WG-M1” would like to use your current location」. If the position service of the smart device is not enabled, you can select whether to enable the position service or not according to prompting in the interface.
2. When the APP is enabled for the second time or later, if the position service function has been enabled already, the interface will directly turn to the home page of the APP; and if the position service function is not enabled, you can select whether to enable the position service or not according to prompting in the interface.

iOS system:

1. When the APP is enabled for the first time, if the position service is enabled, it will prompt whether to not ["WG-M1" would like to use your current location] ; if the position service is disabled, it will prompt [Turn on location services to allow "WG-M1" to determine your location] ; and if clicking [setting] , the smart device position service setting interface will appear.
2. When the APP is enabled for the second time or later, status of position service will be as follows:



Position service state selected at the first-time enabling of the APP	The second-time or later enabling of the APP	
	The position service is enabled	The position service is Off
Enable	Enable the position service	A prompting message [Turn on location services to allow "WG-M1" to determine your location] will appear; and if clicking [setting] , the smart device position service setting interface will appear.
Off	A prompting message that [Location services is disabled for WG-M1. Please exit WG-M1 , then go to 'Settings; General; Location Services' and enable the service for WG-M1.] ; and if clicking [OK] , the APP home interface will appear. Besides, the position service will be automatically disabled.	

APP Home

Enter APP Home interface, and three options are displayed:

- [Playback] : enter playback mode
- [Remote Viewfinder] :
enter the viewfinder status
and control the camera to
shoot by using the smart
device
- [About] : check the version of the
APP.



In the interface of the APP, click  to return to the previous stage of interface. But in index playback and Remote Viewfinder states, click  to return to the APP home directly.

Playback

Click [Playback] in the APP Home to enter the playback mode.



There are two playback options in the playback mode:

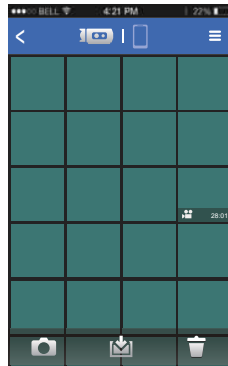

- Index playback
(camera / smart device)
- Single photo (movie / photo)

Index playback (camera / smart device)



1. In the APP Home, click [Playback] to enter the index playback state, and enter the photo album of the camera.

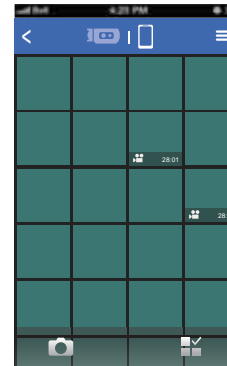

-  : enter the Remote Viewfinder status (See Page 73 for explanations.)
-  : download files in the camera into the smart device (See Page 66 for explanations.)
-  : delete files (See Page 67 for explanations.)

2. When you press the  icon, images that you downloaded to the smart device appear as thumbnails. When you press the  icon, return to the thumbnail display of images stored on the camera.



-  : enter the Remote Viewfinder status (See Page 73 for explanations.)
-  : Select multiple photos

Enter the selection interface after selecting , and click thumbnails so that files can be selected. Clicking the same thumbnail for the second time will cancel the selection.

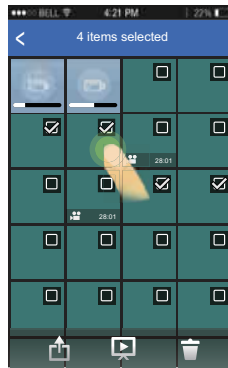

-  : share
-  : slide play
-  : delete

Setting function

Click  at the right upper corner of the interface so that the setting interface can appear.

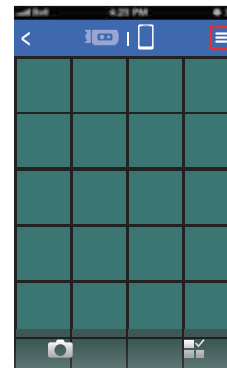





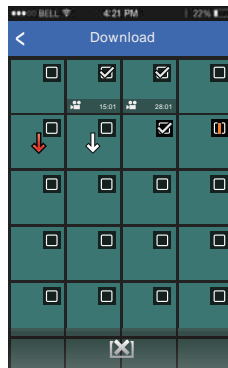

Cache can be wiped in the Android system.

Cache can be wiped in the iOS, where login and logout accounts also can be set.



Download function

In the index playback interface of the camera, click  to enter the download mode. Select a file to begin downloading.



-  : downloading
-  : wait downloading
-  : the download is complete
-  : cancel download
-  : fail in downloading



 You can choose up to 20 files at the same time.

 In the index playback interface, clicking  or  will pause downloading. Download will restart when the playback interface appears again.

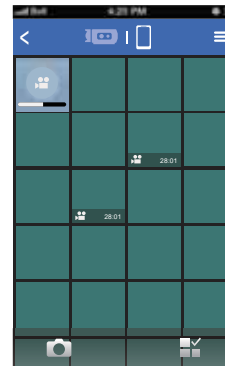
 Downloading will be continued after switching to the index interface of the smart device, and the downloading progress bar will be displayed.



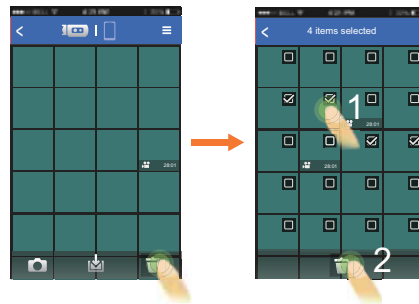

Delete function

1. In the index playback interface of the camera, click  to enter the selection interface. Select the files to be deleted, click  again to choose whether or not to delete the files.



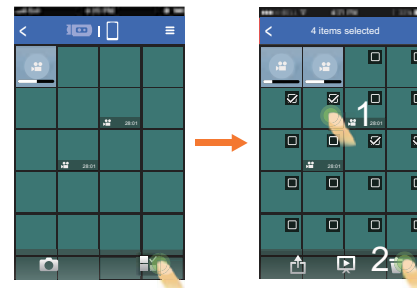

 The files which are being downloaded and wait downloading cannot be deleted.

2. In the index playback interface of the smart device, click  to enter the selection interface. Select the files to be deleted, click  to choose whether or not to delete the files.





 No select box icon is displayed on the file which is being downloaded.

Slide play function

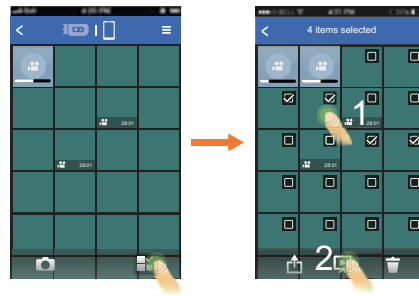

1. In the index playback interface of the smart device, click  to enter the selection interface;
2. Firstly, select the files to be played, and then click  to start slide play;
3. If no file is selected, directly click  so that all files will be played.



 Clicking a photo in slide play will stop the playback and the single photo interface will appear.

 When playing movie in a slide, only the first frame is displayed; clicking the movie will stop slide play and the movie play interface will appear.

Share function

1. In the index playback interface of the smart device, click  to enter the selection interface.
2. Select the files to be shared, and click  to pop up the share option.

 Share option will differ according to the settings of the smart device.

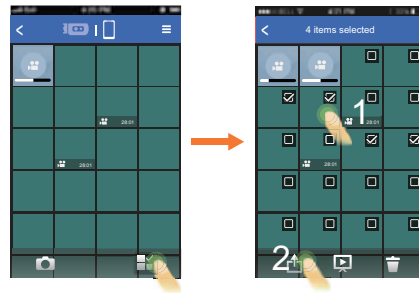





Single Photo

In the index playback interface, the single photo interface will appear if a single file is clicked.

Previous and next files can be displayed by scrolling.





100% enlargement screen will appear by double clicking one single photo, and the original dimension will be recovered by double clicking again.

1. Executable operations in single photo playback of the files at the camera side:

-  : enter the Remote Viewfinder status (See Page 73 for explanations.)
-  : download the files on the camera into the smart device
-  : delete
-  : start playing back movie/pause (only iOS system)



2. Executable operations in single photo playback of the files on the smart device:

-  : share
-  : slide play
-  : edit
-  : delete
-  : start playing back movie/pause (only iOS system)



Edit function

1. Editing photo files:

Click  to enter the effect interface, where filter effects, brightness adjustment and modeling effects can be set.

• Filter effects:

The filter effects have 23 types. More effect options can be viewed by sliding the effect option bar from side to side.

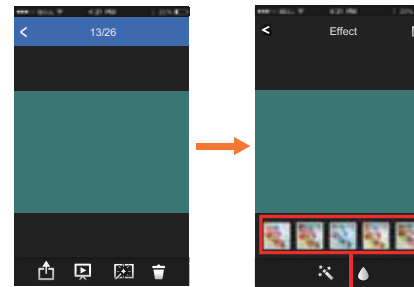

Effect option bar

• Brightness adjustment effects:

 : Off

 : Auto

• Modeling effects:

 : Off

 : Round shape

 : Belt-like shape (lateral direction)





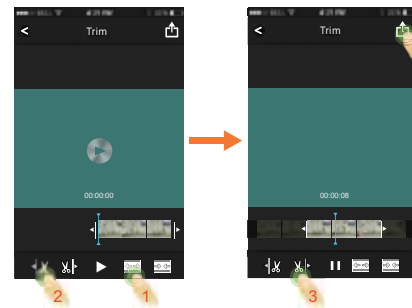

First, click the desired effect and then click

 to select the options of 「Save」 or 「Cancel」, or select the location to share the file.





2. Editing movie files:

Click  to enter the trim interface.



-  and  : play movies
-  : increase the number of frames
-  : shorten the number of frames
-  : trim starting point
-  : trim finishing point

Steps of movie trim:

- ① Click  or  to increase or shorten the number of frames.
- ② Slide the quick browse bar from side to side so that the vertical line stays on a frame to be cut, and click  to select the trim starting point.
- ③ Slide the quick browse bar again to the left so that the vertical line stays on a frame to be cut, and click  to select the trim finishing point.
- ④ Click  to select the option of [Save] or [Cancel], or select the location to share the file.





Remote Viewfinder





Click [Remote Viewfinder] in the APP Home to enter the viewfinder status, and control the camera to shoot by using the smart device.

 The files shot through the APP are saved in the camera.

The setting parameters of the camera are displayed at the tops of the video mode and the shooting mode interfaces on the smart device.

Movie Size: [1080p30]
[960p50]
[960p30]
[720p60]
[720p30]
[WVGA60]
[WVGA120]

Field of View:  Wide
 Medium
 Narrow
 Underwater

White Balance:  AWB
 Daylight
 Cloudy
 Fluorescent
 Underwater



Still Size: 14M
10M-16:9
5M

Burst Shot:  Single
 Burst Shot

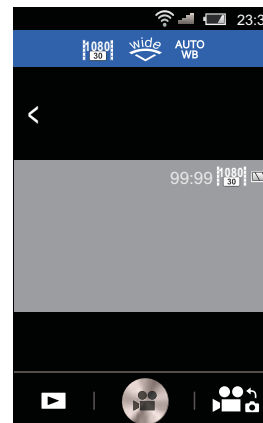

 The characteristics of these parameters are the same as the camera.

Video mode:



-  : enter the index playback state on the camera.
-  : start video recording / stop video recording
-  : switch to the shooting mode from the video mode

Video mode method of operation:

1. Click icons at the top of the interface to set corresponding parameters.
2. Click  to start video recording, and click  to stop video recording.
3. Click  to enter the index playback state.



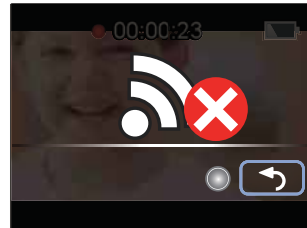

In Wireless Power Saving enabled state, a prompting message about breaking of wireless connection in 30 seconds will be popped up when video recording on the smart device. At this moment, if the user does not stop video recording, wireless online will be automatically disconnected, and the wireless disconnection message will be displayed while video recording is continued on the camera.



Shooting mode:

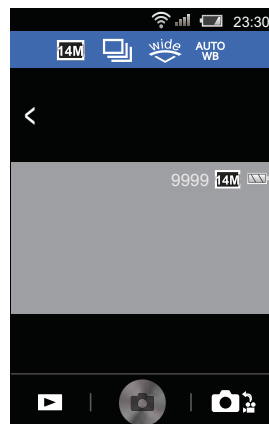

Shooting mode method of operation:

1. Click icons at the top of the interface to set corresponding parameters.
2. Click  to shoot photos.
3. Click  to enter the index playback state.



About

Click [About] in the APP Home, so that the version of the APP can be checked.

-  : enter the index playback state on the camera.
-  : shoot photos
-  : switch to the video mode from the shooting mode

Connection Port Introduction

Connect to a Computer

You can use the USB cable to connect the camera and copy (transmit) images to a computer.

Transferring images to your computer

Follow the steps below to connect the camera to a computer.

1. Make sure the computer is turned on.
2. Connect one end of the supplied USB cable to the USB port on your camera.
3. Connect the other end of the USB cable to an available USB port on your computer.
4. The computer will automatically detect the camera as a removable drive. Double-click the Computer icon on the desktop to locate the removable drive and to copy folders and files in the drive to a directory on your PC.
5. After the transmission is complete, disconnect the USB cable according to the instructions specifying how to safely / remove USB devices.

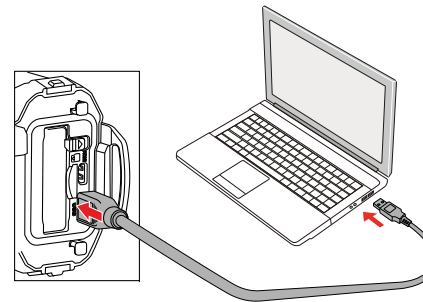

Viewing Images on Computer

Display transferred images on a standard image viewer etc. that an OS has. For details about viewing images, see the help menu on the viewer.

Supported OS=>Windows: Windows Vista® / Windows® 7 / Windows® 8 / Windows® 8.1

Macintosh: Mac OS X 10.6, OS X 10.7 / 10.8 / 10.9



If a memory card is inserted in the product, only files in the memory card will be read. If needing to read the files in the internal memory, please pull out the memory card before connecting to the computer.

HDMI Connected TV Output

The product is capable of realizing movie and photo playback on a TV through an HDMI cable.

Steps:

1. Open the battery/card cover of the product, connect one end of an HDMI cable (not included) to a TV which is up to the HDMI standard (the TV and the product both need to be turned on) and the other end to the cable to the HDMI port of the product;
2. The product will automatically enter the playback mode after the connection is complete. The operating method is the same as [Introduction to Basic Operation of Playback] on page 37.

Appendices

Main Specifications

Type	Compact Digital Still Camera	
Number of effective pixels	Approx. 14 megapixels	
Image sensor	1/2.3 inch CMOS	
Number of recorded pixels	Still	(4:3) 14M: 4320×3240 5M: 2592×1944 (16:9) 10M: 4320×2432
	Movie	1920×1080(30fps) 1280×960(50fps) 1280×960(30fps) 1280×720(60fps) 1280×720(30fps) 848×480(60fps) 848×480 (120fps)
Sensitivity	Automatic (ISO 100 - 800)	
File format	Still	JPEG (Exif 2.3), DCF2.0
	Movie	MOV/H.264, 30fps/50fps/60fps/120fps, PCM system, stereo sound
Storage media	Built-in memory (approx. 100MB), microSD Memory Card / microSDHC Memory Card	

Approximate Image Storage Capacity and Recording Time

Still

	Built-in Memory	4GB microSD Memory Card
14M (4320×3240)	24 pictures	911 pictures
10M (4320×2432)	32 pictures	1208 pictures
5M (2592×1944)	64 pictures	2391 pictures

- The image storage capacity is for reference only. The actual image storage capacity may vary depending on the microSD Memory Card and the subject.

Movie

	Built-in Memory	4GB microSD Memory Card
1920×1080.30fps	46sec.	31min. 39sec.
1280×960.50fps	46sec.	31min. 39sec.
1280×960.30fps	1min. 15sec.	49min. 40sec.
1280×720.60fps	52sec.	35min. 11sec.
1280×720.30fps	1min. 38sec.	1hr. 3min. 45sec.
848×480.60fps	1min. 38sec.	1hr. 3min. 43sec.
848×480.120fps	52sec.	35min. 10sec.



- The above figures are based on our standard shooting conditions and may vary depending on the subject, shooting conditions and type of the microSD Memory Card used.
- You can continue recording until the recording time reaches 25 minutes (only 848×480.120fps is 60 seconds) per a recording.



White balance	AWB, Daylight, Cloudy, Fluorescent, Underwater	
Lens	Focal Length: 3mm (approx. 16.8mm in 35mm format equivalent) Brightness: F2.8 Lens Construction: 6 elements in 6 groups (2 aspherical elements) Maximum field of view: Still image approx. 160° (4:3 wide) Movie approx. 137° (1280 x 960)	
Image stabilization	Electronic image stabilization (movie only)	
Display	1.5-inch LCD, approx. 115,000 dots	
Playback modes	Photo playback, Movie playback	
Focus	Type	Fixed focus
	Focus range	In air (Lens protector O-LP1531, Underwater lens protector O-LP1532): 60cm - ∞ Underwater (Underwater lens protector O-LP1532): 80cm - ∞
Exposure control	AE Metering	AiAE, Face AE (not switchable)
Shooting modes	Still, Movie, Time Lapse, Loop recording, Motion detection	
Face detection	10 people's faces	
Drive modes	Still: Single, Burst Shot	



Power source	Rechargeable lithium-ion battery: DB-65		
Battery life	Image Storage Capacity	Approx. 350 pictures (using specified battery)	The number of pictures is an estimated value based on our measurements. Actual number may vary according to usage conditions.
	Movie Recording Time	Approx. 150 minutes (using specified battery)	The time is an estimated value based on our measurements. Actual number may vary according to usage conditions.
	Playback Time	Approx. 400 minutes (using specified battery)	The time is an estimated value based on our measurements. Actual number may vary according to usage conditions.
Interfaces	USB 2.0 (high-speed compatible), HDMI port (Type D)		
Wireless interface	<ul style="list-style-type: none"> • Standard: 802.11b/g/n • Frequency: 2.4GHz band • Security: WPA2 		
Dimensions	Approx. 66.5 (W)×42.5 (H)×89.5 (D) mm (excluding operating or protruding parts)		

Weight	Approx. 190g (including battery, memory card, and Lens protector O-LP1531)
	Approx. 151g (excluding battery, memory card, and Lens protector)
Accessories	Rechargeable lithium-ion battery DB-65 Power adapter GAC-03 USB cable I-USB152 Carabiner strap O-ST153 Quick start guide Operating Manual(CD-ROM) Lens protector O-LP1531 Underwater lens protector O-LP1532 WG Flat Adhesive Mount O-CM1531

Prompts and Warning Messages

Message	Description	Solution
	<ul style="list-style-type: none"> ■ The file folders in the memory card have reached the maximum number (999), the images will not be saved. ■ Too much folders in memory card will result in longer power up time. 	<ul style="list-style-type: none"> ■ Copy the images to your PC and format the memory card.
	<ul style="list-style-type: none"> ■ The memory card is full. 	<ul style="list-style-type: none"> ■ Delete unwanted images.
	<ul style="list-style-type: none"> ■ The internal memory is full. 	<ul style="list-style-type: none"> ■ Delete unwanted images.

Message	Description	Solution
	<ul style="list-style-type: none"> ■ The memory card still cannot be recognized after format. ■ An error occurs when reading the memory card. ■ Interruption problem is encountered in the period of writing in the memory card during the video recording or shooting process. 	<ul style="list-style-type: none"> ■ Format the memory card.
	<ul style="list-style-type: none"> ■ The internal memory can't be identified after being formatted. ■ Interruption problem is encountered in the period of writing in the internal memory during the video recording or shooting process. 	<ul style="list-style-type: none"> ■ Format the internal memory.
	<ul style="list-style-type: none"> ■ When a memory card lower than Class 4 is used to record an HD movie, the writing speed is too slow and recording will not continue. 	<ul style="list-style-type: none"> ■ Use a memory card with Class 4 or higher.

Message	Description	Solution
	<ul style="list-style-type: none"> ■ The battery is used up. It is a warning indicating that the camera is going to shut down. 	<ul style="list-style-type: none"> ■ Replace a new battery. ■ Replace a fully charged battery.
	<ul style="list-style-type: none"> ■ The message will be displayed when the temperature of the battery is too high during recording. 	<ul style="list-style-type: none"> ■ Remove the battery after the product is turned off. You can continue to use the battery when it cools.
	<ul style="list-style-type: none"> ■ When the AP setting is enabled, the message will be displayed when the temperature of the battery is too high. 	<ul style="list-style-type: none"> ■ Remove the battery after the product is turned off. You can continue to use the battery when it cools.

Using the WG Flat Adhesive Mount O-CM1531

This accessory included in the package fixes our digital camera on a flat surface.

Please read the instructions below carefully for safe use.

 **Warning** Do not install this product in vehicles in a way which might hinder driving operations or cause accidents resulting from dropping the product. Do not operate the camera while driving.

 **Caution** Always observe the following cautions. Otherwise, your camera may fall off and result in injuries, damages or submerging.

1. Make sure to install the camera onto the appurtenant camera platform securely.

2. Make sure to install the mount in an intended object securely.

3. Tighten the nut securely so that it will not loosen.

If not followed, could result in injuries, damages or submerging.

Precautions When Using This Product

- Do not disassemble or modify this product.
- Make sure to use our genuine repair parts for replacement.
- Do not leave this product sitting in direct sunlight or high humidity.
- This product set up with a camera will sink if dropped in water. Be careful and prevent its falling by using a gear such as a fall protection strap (commercially available) when using this product on a ship etc.

Optional repair parts are available for this product :

WG Repair Parts 1 O-CM1474 (Double-sided adhesive tape)

WG Repair Parts 2 O-CM1475 (Nut)

How to Install the Mount

1. Align the screw to the tripod socket of the camera. Rotate the screw for fixing.

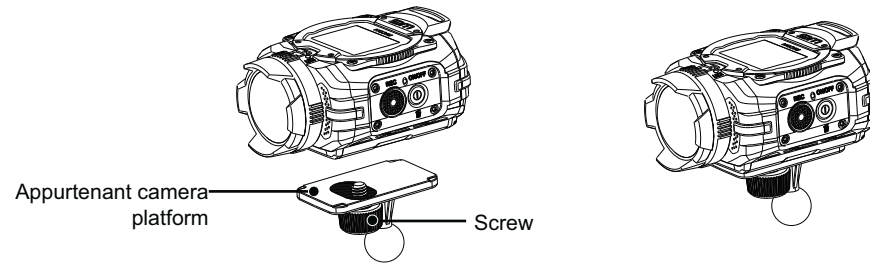

2. Inset the appurtenant camera platform with the nut into the adhesive mount and tighten the nut to fix them.

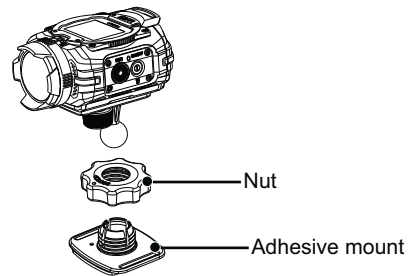

3. Peel off a seal stuck to the underside of the adhesive mount to fix this product on a flat surface such as a table. The angle of the mounted camera can be adjusted by loosening the nut. Make sure to tighten the nut securely once the angle is determined.

Caution:

- Make sure to fix this product on a flat surface without irregularities or roughness after wiping off dirt or oil on it.
- Do not twist this product forcedly after fixing since its adhesion may weaken. Make sure to use an optional double-sided adhesive tape (WG Repair Parts 1 O-CM1474) for replacing a used adhesive instead of reusing it.
- Remove this product carefully. Otherwise, the mounting surface may damage or its painting may peel off depending on the conditions.
- The nut may loosen during the travelling. Make sure to follow the proper procedures to install this product securely.
- We shall not be held liable for any damages, malfunctions, losses or accidents of your camera or this product resulting from tipping over or dropping the product.

Warranty Policy

All our cameras purchased through authorized bona fide photographic distribution channels are guaranteed against defects of material or workmanship for a period of twelve months from the date of your purchase. Service will be rendered, and defective parts will be replaced without cost to you within that period, provided the camera does not show evidence of impact, sand or liquid damage, mishandling, tampering, battery or chemical corrosion, operation contrary to operating instructions, or modification by an unauthorized repair shop. The manufacturer or its authorized representatives shall not be liable for any repair or alterations except those made with its written consent and shall not be liable for damages from delay or loss of use or from other indirect or consequential damages of any kind, whether caused by defective material or workmanship or otherwise; and it is expressly agreed that the liability of the manufacturer or its representatives under all guarantees or warranties, whether expressed or implied, is strictly limited to the replacement of parts as hereinbefore provided. No refunds will be made on repairs by non-authorized service facilities.

Procedure During 12-month Warranty Period

Any camera which proves defective during the 12-month warranty period should be returned to the dealer from whom you purchased the camera or to the manufacturer. If there are no representatives of the manufacturer in your country, send the camera to the manufacturer, with postage prepaid. In this case, it will take a considerable length of time before the camera can be returned to you owing to the complicated customs procedures required. If the camera is covered by warranty, repairs will be made and parts replaced free of charge, and the camera will be returned to you upon completion of servicing. If the camera is not covered by warranty, regular charges of the manufacturer or of its representatives will apply. Shipping charges are to be borne by the owner. If your camera was purchased outside of the country where you wish to have it serviced during the warranty period, regular handling and servicing fees may be charged by the manufacturer's representatives in that country. Notwithstanding this, your camera returned to the manufacturer will be serviced free of charge according to this procedure and warranty policy. In any case, however, shipping charges and customs clearance fees to be borne by the sender. To prove the date of your purchase when required, please keep the receipt or bills covering the purchase of your camera for at least a year. Before sending your camera for servicing, please make sure that you are sending it to the manufacturer's authorized representatives or their approved repair shops, unless you are sending it directly to the manufacturer. Always obtain a quotation for the service charge, and only after you accept the quoted service charge, instruct the service station to proceed with the servicing.

- This warranty policy does not affect the customer's statutory rights.
- The local warranty policies available from our distributors in some countries can supersede this warranty policy. Therefore, we recommend that you review the warranty card supplied with your product at the time of purchase, or contact our distributor in your country for more information and to receive a copy of the warranty policy.

 The CE Mark is a Directive conformity mark of the European Union.

For customers in USA

STATEMENT OF FCC COMPLIANCE

This device complies with Part 15 of the FCC Rules. Operation is subject to the following two conditions: (1) This device may not cause harmful interference, and (2) this device must accept any interference received, including interference that may cause undesired operation. Changes or modifications not approved by the party responsible for compliance could void the user's authority to operate the equipment. This equipment has been tested and found to comply with the limits for a Class B digital device, pursuant to part 15 of the FCC Rules. These limits are designed to provide reasonable protection against harmful interference in a residential installation. This equipment generates, uses and can radiate radio frequency energy and, if not installed and used in accordance with the instructions, may cause harmful interference to radio communications. However, there is no guarantee that interference will not occur in a particular installation. If this equipment does cause harmful interference to radio or television reception, which can be determined by turning the equipment off and on, the user is encouraged to try to correct the interference by one or more of the following measures:

- Reorient or relocate the receiving antenna. Increase the separation between the equipment and receiver. Connect the equipment into an outlet on a circuit different from that to which the receiver is connected.
- * Consult the dealer or an experienced radio/TV technician for help.

For customers in Canada

This Class B digital apparatus complies with Canadian ICES-003.

This device complies with Industry Canada licence-exempt RSS standard(s). Operation is subject to the following two conditions: (1) this device may not cause interference, and (2) this device must accept any interference, including interference that may cause undesired operation of the device.

Industry Canada ICES-003 Compliance Label:

CAN ICES-3 (B)/NMB-3(B)

Le présent appareil est conforme aux CNR d'Industrie Canada applicables aux appareils radio exempts de licence. L'exploitation est autorisée aux deux conditions suivantes : (1) l'appareil ne doit pas produire de brouillage, et (2) l'utilisateur de l'appareil doit accepter tout brouillage radioélectrique subi, même si le brouillage est susceptible d'en compromettre le fonctionnement.

Pour les utilisateurs au Canada

Cet appareil numérique de la classe B est conforme à la norme NMB-003 du Canada.

FOR CALIFORNIA, U.S.A. ONLY

Perchlorate Material-special handling may apply. The lithium battery used in this camera contains perchlorate material, which may require special handling.

See www.dtsc.ca.gov/hazardouswaste/perchlorate

Declaration of Conformity

According to 47CFR, Parts 2 and 15 for

Class B Personal Computers and Peripherals

We: RICOH IMAGING AMERICAS CORPORATION

Located at: 633 17 Street, Suite 2600, Denver, Colorado 80202, U.S.A.

Phone: 800-877-0155 Fax: 303-790-1131

Declare under sole responsibility that the product identified herein complies with 47CFR Parts 2 and 15 of the FCC rules as a Class B digital device. Each product marketed is identical to the representative unit tested and found to be compliant with the standards. Records maintained continue to reflect the equipment being produced can be expected to be within the variation accepted, due to quantity production and testing on the statistical basis as required by 47CFR §2.909. Operation is subject to the following two conditions: (1) This device may not cause harmful interference, and (2) This device must accept any interference received, including interference that may cause undesired operation. The above named party is responsible for ensuring that the equipment complies with the standards of 47CFR §15.101 to §15.109.

Product Name: Digital Camera

Model Number: RICOH WG-M1

Contact person: Customer Service Manager

Date and Place: October, 2014, Colorado

Information for Users on Collection and Disposal of Old Equipment and Used Batteries



1. In the European Union

These symbols on the products, packaging and/or accompanying documents mean that used electrical and electronic equipment and batteries should not be mixed with general household waste.

Used electrical/electronic equipment and batteries must be treated separately and in accordance with legislation that requires proper treatment, recovery and recycling of these products.



By disposing of these products correctly you will help ensure that the waste undergoes the necessary treatment, recovery and recycling and thus prevent potential negative effects on the environment and human health which could otherwise arise due to inappropriate waste handling.

If a chemical symbol is added beneath the symbol shown above, in accordance with the Battery Directive, this indicates that a heavy metal (Hg = Mercury, Cd = Cadmium, Pb = Lead) is present in the battery at a concentration above an applicable threshold specified in the Battery Directive.

For more information about collection and recycling of used products, please contact your local authorities, your waste disposal service or the point of sale where you purchased the products.

2. In other countries outside the EU

These symbols are only valid in the European Union. If you wish to discard used products, please contact your local authorities or dealer and ask for the correct method of disposal.

For Switzerland: Used electrical/electronic equipment can be returned free of charge to the dealer, even when you don't purchase a new product. Further collection facilities are listed on the home page of www.swico.ch or www.sens.ch.

RICOH IMAGING COMPANY, LTD.	2-35-7, Maeno-cho, Itabashi-ku, Tokyo 174-8639, JAPAN (http://www.ricoh-imaging.co.jp)
RICOH IMAGING EUROPE S.A.S	112 Quai de Bezons, B.P. 204, 95106 Argenteuil Cedex, FRANCE (http://www.ricoh-imaging.fr)
RICOH IMAGING DEUTSCHLAND GmbH	Am Kaiserkai 1, 20457 Hamburg, GERMANY (http://www.ricoh-imaging.de)
RICOH IMAGING UK LTD.	PENTAX House, Heron Drive, Langley, Slough, Berks SL3 8PN, U.K. (http://www.ricoh-imaging.co.uk)
RICOH IMAGING AMERICAS CORPORATION	633 17th Street, Suite 2600, Denver, Colorado 80202, U.S.A. (http://www.us.ricoh-imaging.com)
RICOH IMAGING CANADA INC.	5520 Explorer Drive Suite 300, Mississauga, Ontario, L4W 5L1, CANADA (http://www.ricoh-imaging.ca)
RICOH IMAGING CHINA CO., LTD.	23D, Jun Yao International Plaza, 789 Zhaojiabang Road, Xu Hui District, Shanghai, 200032, CHINA (http://www.ricoh-imaging.com.cn)

<http://www.ricoh-imaging.co.jp/english>

• Specifications and external dimensions are subject to change without notice.

54891EN

Copyright © RICOH IMAGING COMPANY, LTD. 2014

201408