



User Guide

Sportster 5

Satellite Radio

Congratulations on the Purchase of your new SIRIUS Sportster SP5 Plug-n-Play Radio

Your new SIRIUS Sportster™ SP5 Plug-n-Play Radio lets you enjoy SIRIUS® Satellite Radio's digital entertainment anywhere you've installed the SUPH1C SIRIUS Universal Plug and Play Home Kit, SUPV1C SIRIUS Universal Plug and Play Vehicle Kit, or the SUBX1C SIRIUS Plug and Play Universal Boombox (each sold separately). Use this manual to familiarize yourself with all of SIRIUS Sportster's features and capabilities. For the latest information about this and other SIRIUS Sportster products and accessories, visit <http://siriuscanada.ca>.



Table of Contents

TABLE OF CONTENTS.	4
WARNING AND SAFETY INFORMATION.	6
FCC Information	6
Canadian Compliance	7
General Precautions	7
Warnings	8
COPYRIGHTS & TRADEMARKS	10
PACKAGE CONTENTS.	11
INSTALLATION.	14
Installing the Vehicle Dock	14
Installing the Magnetic Antenna	21
Antenna Mounting	22
Cable Routing	24
Tips	32
Connecting the Cigarette Lighter Adapter	37
Docking Your SIRIUS Radio	37
Connecting Your SIRIUS Radio to Your Vehicle's Audio System	38
Subscribing to the SIRIUS Service	44
CONTROLS	45
SIRIUS Sportster SP5 Front Panel	45
Remote Control Buttons	48
Vehicle Dock Reference Guide.	51
OPERATION	52
Display Screen Information	52
Navigating Menus and Lists	53
Display (Disp) Button	53
Search Modes (Preset, Category, Channel, Artist, Song Title)	55

Direct Tuning	58
Channel Presets	58
Jump Button	60
Memory (MEMO) and Song Seek (S-Seek) Functions.	61
Sports Alert	69
Instant Replay	70
FM Presets Button	74
MENU OPTIONS	75
Sirius ID	76
Settings	77
FM Transmitter	78
Display Settings	79
S-Seek alert settings	83
Audio Level	84
Channel Preview	85
Factory Default	86
Parental Control	87
Sports Alerts	89
Sports Selections.	90
NASCAR	90
NFL, NBA, NHL, College football, college basketball	92
Clock.	94
Alarm.	95
Program Alert	96
Auto Shutdown.	97
Sleep Mode	97
Signal Indicator	98
SPECIFICATIONS.	100
WARRANTY	101
SIRIUS ID	102

Warning and Safety Information

FCC Information

This device complies with part 15 of the FCC Rules. Operation is subject to the following two conditions:

1. This device may not cause harmful interference, and
2. This device must accept any interference received, including interference that may cause undesired operation.

Note: This equipment has been tested and found to comply with the limits for a CLASS B digital device, pursuant to Part 15 of the FCC Rules. These limits are designed to provide reasonable protection against harmful interference when the equipment is operated in a commercial environment. This equipment generates, uses, and can radiate radio frequency energy and, if not installed and used in accordance with the instructions, may cause harmful interference to radio communications. However, there is no guarantee that interference will not occur in a particular installation. If this equipment does cause harmful interference to radio or television reception, which can be determined by turning the equipment off and on, the user is encouraged to try to correct the interference by one or more of the following measures:

1. Reorient or relocate the receiving antenna.
2. Increase the separation between the equipment and the receiver.
3. Connect the equipment into an outlet on a circuit different from that to which the receiver is connected.
4. Consult the dealer or an experienced radio/TV technician for help.

WARNING

Changes or modifications not expressly approved by the manufacturer could void the user's authority to operate the equipment.

Canadian Compliance

This Class B digital apparatus complies with Canadian ICES-003.

Cet appareil numérique de la classe B est conforme à la norme NMB-003 du Canada.

General Precautions

Liquid Crystal Precautions

If the LCD screen on the SIRIUS Sportster is damaged, do not touch the liquid crystal fluid. If any of the following situations happen, take the action indicated:

1. If the liquid crystal fluid comes in contact with your skin, wipe the skin area with a cloth and then wash the skin thoroughly with soap and running water.
2. If the liquid crystal fluid gets into your eye, flush the eye with clean water for at least 15 minutes. Seek medical care.
3. If the liquid crystal fluid is ingested, flush your mouth thoroughly with water. Drink large quantities of water and induce vomiting. Seek medical care.

Safety Precautions

Be sure to observe the following warnings. Failure to follow these safety instructions and warnings may result in a serious accident.

- Do not operate the SIRIUS SP5 in a way that might divert your attention from driving safely. As a driver, you alone are responsible for safely operating your vehicle in accordance with traffic safety laws at all times.

- Do not install the unit where it may obstruct your view through the windshield, or of your vehicle's indicator displays.
- Do not install the unit where it may hinder the function of safety devices such as an airbag. Doing so may prevent the airbag from functioning properly in the event of an accident.
- Be sure the unit is installed as described in these installation instructions and the instructions which accompany each accessory kit. SIRIUS Satellite Radio is not responsible for issues arising from installations which were not installed according to the instructions.
- To avoid short circuits, do not open the unit, and never put or leave any metallic objects (coins, tools, etc.) inside the unit.
- If the unit emits smoke or unusual odors, turn the power off immediately, and disconnect the unit from any power source.
- Do not drop the unit or subject it to strong shocks.
- If the unit doesn't seem to be working properly, turn the unit off, wait 10 seconds, and then turn it on again.
- The installation and use suggestions contained in this manual are subject to any restrictions or limitations that may be imposed by applicable law. The purchaser should check applicable law for any restrictions or limitations before installing and/or operating this unit.

Warnings

Operating Temperature

The radio is designed to operate between -20° to +85° C (-4° to +185° F). Avoid leaving the radio in a vehicle or elsewhere where the temperature may fall outside this range. Extreme temperatures or extreme temperature fluctuations can degrade the performance of the LCD display screen, and possibly damage it.

Cleaning and Maintenance

If the radio or accessories become dirty, turn the power off and wipe them clean with a soft cloth. Do not use hard cloths, strong cleaning fluids, paint thinner, alcohol, or other volatile solvents to clean. These may cause damage to the radio.

Cigarette Lighter Adapter

The Vehicle Dock cannot be powered directly from a vehicle's 12VDC power system. It must be powered from the vehicle's cigarette lighter or similar power port using the included Cigarette Lighter Adapter or an equivalent DC power adapter (see your local electronics dealer). Connecting the Vehicle Dock directly to the vehicle's 12VDC power system may result in damage to the Vehicle Dock or SIRIUS radio, or both.

Copyrights & Trademarks

© 2007 SIRIUS Satellite Radio Inc. All Rights Reserved.

® "SIRIUS", the SIRIUS dog logo, channel names and logos are trademarks of SIRIUS Satellite Radio Inc. "NFL" and the NFL Shield logo, and the NFL Sunday Drive name and logo are registered trademarks of the National Football League. "NHL" and the NHL Shield are registered trademarks of the National Hockey League. "NBA" and the NBA silhouette logo are registered trademarks of NBA Properties Inc. All other trademarks, service marks, sports team names, album art, and logos are the property of their respective owners. All Rights Reserved.

™ "Sportster" is a trademark of SIRIUS Satellite Radio.

Portions of the software on this radio are licensed under the eCos License. Distribution of eCos requires that the eCos source code be made available to SIRIUS Satellite Radio customers. The eCos License and eCos source code are available to the public at <http://www.sirius.com/ecoslicense>.

SIRIUS Satellite Radio reserves all rights to all radio software not covered under the eCos license. This includes all portions of radio software that were not distributed to SIRIUS as part of the eCos operating system.

Hardware, subscription and activation fee required. For full Terms & Conditions, visit <http://sirius.com>. Prices and programming are subject to change. Not available in HI and AK. Equipment and subscription sold separately. Installation required with some equipment.

Package Contents

The following items are included with your SIRIUS Sportster SP5 radio:



Sportster SP5 Radio



Remote Control

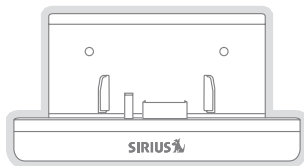

Vehicle Dock

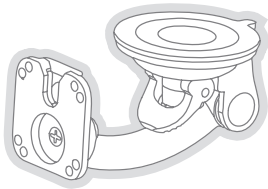

Suction Cup Mount

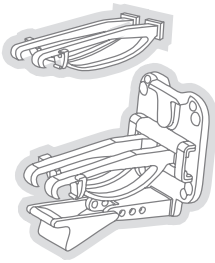

**Vent Mount &
Extended Vent Hooks**

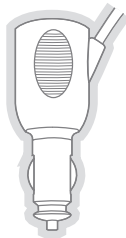

**Cigarette Lighter
Adapter**



**Magnetic
Antenna**



**Antenna
Cover/Tail**



**Mounting
Screws**



**Alcohol
Wipe**

Unpack your SIRIUS Sportster SP5 carefully and make sure that everything shown is present. If anything is missing or damaged, or if your SIRIUS Sportster radio fails to operate, notify your dealer immediately. It is recommended that you retain the original carton and packing materials in case you need to ship your radio in the future.

Installation

SIRIUS suggests that you have your Sportster SP5 professionally-installed in your vehicle. Professional installation provides an experienced technician to install this product in your vehicle, advice for selecting a suitable mounting location for the Vehicle Dock, installation of the antenna, and proper routing of all the necessary wires and cables. If the locations of your SIRIUS radio and your vehicle's FM antenna make the performance of your SIRIUS radio's built-in FM transmitter within your vehicle poor, a professional installer will have the necessary accessories to install an optional FM Direct Adapter or audio cable to connect the audio output of the Vehicle Dock directly to your vehicle's audio system. Ask your SIRIUS retailer if they provide professional installation services, or can recommend a professional installation service.

Installing the Vehicle Dock

When installing the vehicle dock in your vehicle, choose a location that will not block your vision, interfere with the vehicle controls, or obstruct the air bag. The location should be easily accessible and provide good visibility of the display, and should not be located where it will be in direct sunlight which will affect the visibility of the radio's display screen.

The mounting accessories necessary to install the vehicle dock in a vehicle are provided. *Figure 1* shows two examples of the SIRIUS radio mounted in a vehicle: **A** is the suction cup mount method, and **B** is the vent mount method using the vent mount clip.

Note: The supplied suction cup mount and vent mount should work in most vehicles. If your installation requires a different mounting option, check with a local electronics retailer for other compatible mounts that are available separately.

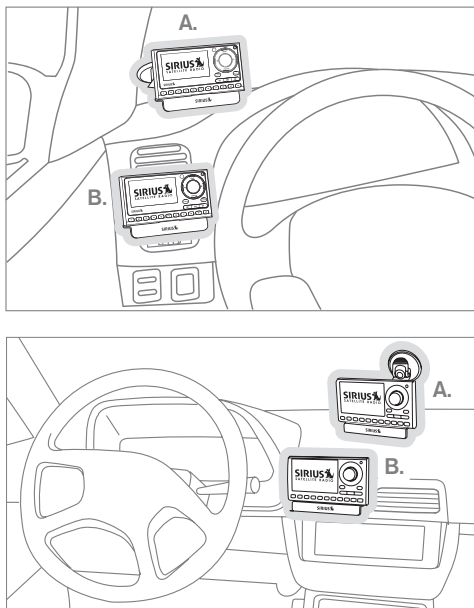

Figure 1

Depending upon the mounting location you select in your vehicle, the mount should be attached to the vehicle dock and installed as described in the following sections.

Suction Cup Mount Method (A)

The suction cup mount may be attached to your vehicle's windshield. Before attaching the suction cup mount to your windshield, you should check your state and local laws for regulations regarding mounting this device on your windshield.

To mount the vehicle dock using the suction cup mount, assemble the mount as follows:

1. Attach the vehicle dock to the suction cup mount using the provided screws. (See *Figure 2*.)

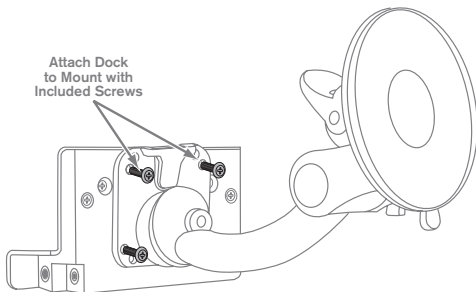

Figure 2

2. Clean the area where you are attaching the suction cup with the supplied alcohol wipe.

3. Be sure the cam lever is up (as shown in *Figure 3*) and position the suction cup mount on the windshield or other location you have chosen. Press the cam lever all the way down towards the base of the mount until it locks to firmly adhere the suction cup. (To unlock the suction cup, lift the lever up.)

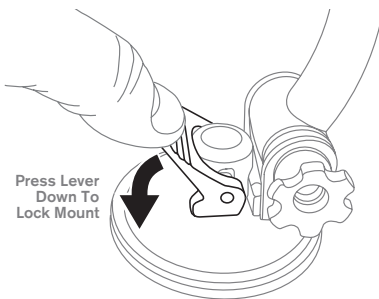

Figure 3

Vent Mount Method (B)

To mount the vehicle dock using the vent mount method, install the vent mount as follows:

1. If the vent louvers in your vehicle are recessed, you may need to use the longer vent hooks with the vent mount. Refer to *Figure 4* and install the longer vent hooks into the vent mount. Be sure to observe the orientation of the vent hooks as shown.
2. Attach the vent mount to the vehicle dock using the provided screws. (See *Figure 5*.)

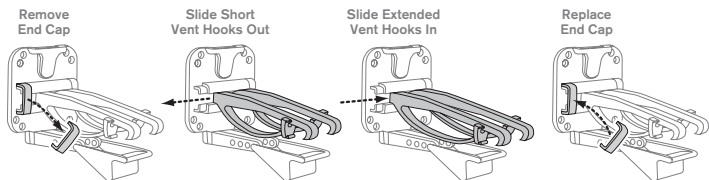

Figure 4

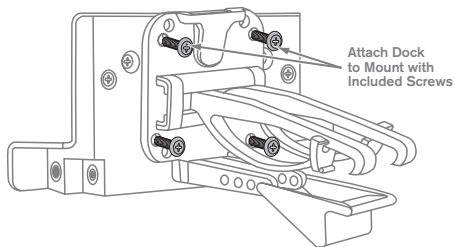

Figure 5

3. Refer to *Figure 6* and attach the vent mount to a heating/air conditioning vent in your vehicle. Position the two tension springs **A** against a vent louver **B**. Then push the vent mount into the vent, far enough so that the hooks **C** drop down and hook the rear of the vent louver (see *Figure 7*). Once the hooks have grasped a vent louver, the tension springs **A** will keep the vent mount hooked to the louver.

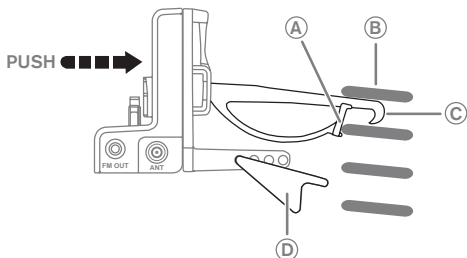

Figure 6

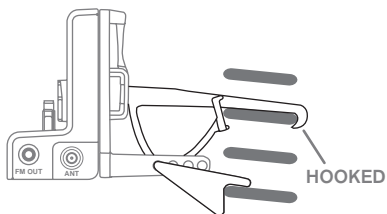

Figure 7

4. The angle of the vehicle dock may be changed by changing the position of foot **D** on the vent mount to a different adjustment hole. (See *Figure 8*.)

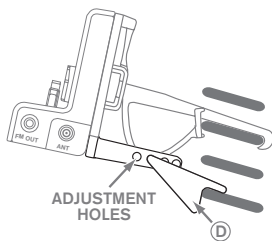

Figure 8

Installing the Magnetic Antenna

Caution

Because adhesive is used in the installation of the Rubber Antenna Cover/Tail, we recommend that you install the antenna at or above room temperature (68° F). The adhesive on the Rubber Cover/Tail may not adhere properly to the vehicle roof at temperatures lower than this. Warmer temperatures will also make it easier to route of the antenna cable through the rubber molding around the windows and in other areas in the vehicle. Maximum adhesion usually occurs within 72 hours at room temperature, so you should avoid car washes as well as other contact with the antenna and Rubber Cover/Tail during this 72 hour period.

Warning

Be sure not to cut, damage, or puncture the external jacket of the antenna cable during the installation procedure. Damage to the antenna cable can degrade the SIRIUS signal or make it unavailable, and can also cause water to intrude via the cable into the antenna causing the antenna to fail.

Do not lengthen or shorten the antenna cable by cutting it. Doing so will cause the antenna to not function properly.

Installation

Installing the magnetic antenna consists of two steps:

- Mounting the magnetic antenna and Rubber Antenna Cover/Tail on the vehicle
- Routing the antenna cable through the vehicle to the Vehicle Dock

ANTENNA MOUNTING

The SIRIUS Magnetic Mount Vehicle Antenna has a strong magnetic mount designed to hold it in place during normal driving conditions (highway/city). This also makes the antenna easy to remove for transferring it to other vehicles.

Figure 9 shows the optimal mounting location for the antenna on several types of vehicles. These mounting positions should be observed when installing the antenna:

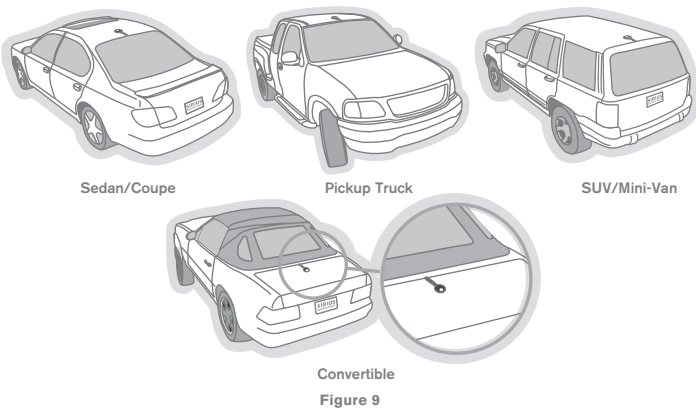

- **Sedan/Coupe/SUV/Mini-Van:** Install the antenna at the rear center of the roof, near the rear window.
- **Pickup Truck:** Install the antenna at the front center of the roof, near the windshield.
- **Convertible:** Install the antenna at the front center of the trunk lid, near the rear window.

The SIRIUS antenna needs to have an **unobstructed area of 3 inches by 3 inches around it**. It is important to mount the antenna where no obstructions will block the antenna from receiving the SIRIUS signal. Objects which can obstruct the antenna could be a roof rack, a sunroof, a roof-mounted cargo container, another antenna, etc. If your vehicle has a potential obstruction, be sure that the SIRIUS antenna is mounted at least 3 inches away from it (but no closer than 3 inches from the roof edge, or trunk lid in the case of a convertible).

Note: Read the **DO** and **DO NOT** installation tips beginning on page 32 for additional antenna installation information.

Follow this procedure to mount the antenna:

1. Select an appropriate mounting position for your type of vehicle that has an unobstructed area of 3 inches by 3 inches around the antenna.
2. Attach the Rubber Cover/Tail to the antenna, as shown in *Figure 10*, and press the antenna cable into the rubber cover/tail. The Rubber Cover/Tail will help to position the antenna the correct distance from the edge of the roof or trunk lid.

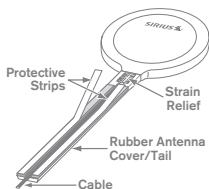

**Magnetic Antenna
(Upside-Down)**

Figure 10

3. Clean the surface area of the vehicle where you will be installing the antenna with the alcohol prep pad.

4. Peel the protective material from the adhesive strips (see *Figure 10*, on page 23) and press the rubber Cover/Tail firmly into place on the vehicle.
5. Double check that the location of the antenna and rubber cover/tail are correct, and continue to press firmly down on the Rubber Cover/Tail for another 30 seconds. At room temperature (68° F), maximum adhesion usually occurs within 72 hours. During this period, avoid car washes and other contact with the antenna and the Rubber Antenna Cover/Tail.

CABLE ROUTING

After you have mounted the antenna you can route the antenna cable to the SIRIUS Vehicle Dock. Separate antenna cable routing procedures are provided for each type of vehicle: Sedan/Coupe, Pickup Truck, SUV/Mini-Van and Convertible.

Note that additional breakout illustrations for each step of the antenna cable routing procedures can be found on the SIRIUS website at <http://siriuscanada.ca>. Click on the **Install/Activate** link and then follow the link for the **Car Installation Tips**.

Sedan/Coupe Antenna Cable Routing Procedure

Figure 11 shows how the antenna cable should be routed from the antenna to your SIRIUS radio in a sedan/coupe.

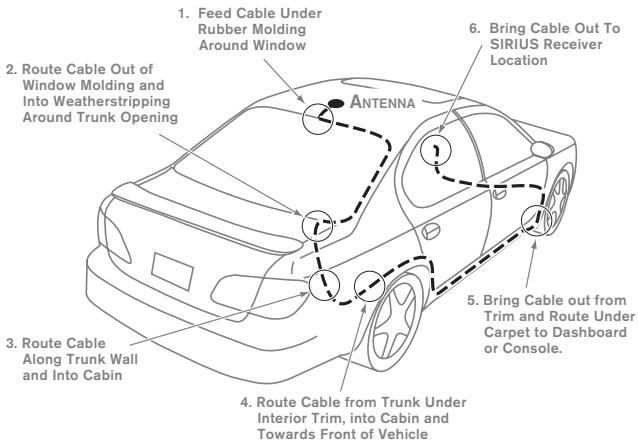

Figure 11

Follow these detailed cable installation instructions:

1. Feed the cable from the antenna underneath the rubber molding around the rear window. Use a plastic putty knife or similar object to lift the rubber molding around the rear window and tuck the antenna cable underneath the molding. Route the antenna cable around and down the window to the lowest point. If your rear window does not have rubber molding, SIRIUS recommends consulting with a professional installer.

2. Route the antenna cable out of the window molding and into the rubber weather stripping around the trunk opening. Lift the weather stripping from the opening and tuck the cable inside it, then replace the weather stripping. To avoid sharp bends in the cable, run the cable inside of the weather stripping for a few inches, then remove the cable from the weather stripping inside of the trunk. Keep the cable away from hinges, gears, etc., that could damage it.
3. Route the cable out from the rubber weather stripping and along the trunk wall. Continue routing the cable into the cabin through a conduit or along an existing wiring harness.
4. Route the cable through the main cabin area under the interior trim, towards the front of the vehicle. Use the plastic putty knife to lift the plastic trim just enough to tuck the cable under underneath. Avoid side airbag locations on back pillars and above the doors. (Airbag locations are marked with "SRS" logos.) Be careful not to crimp or cut the cable.
5. Bring the cable out from the trim near the firewall and route it under the carpet toward the dashboard or console. Coil any excess cable in a hidden location, such as under the carpet, keeping it away from any vehicle pedals or controls. Secure the excess cable with wire ties.
6. Bring the end of the cable out at the SIRIUS Vehicle Dock location. Leave yourself enough cable so you can easily connect it to the antenna connector on the Vehicle Dock.

Pickup Truck Antenna Cable Routing Procedure

Figure 12 shows how the antenna cable should be routed from the antenna to your SIRIUS radio in a pickup truck.

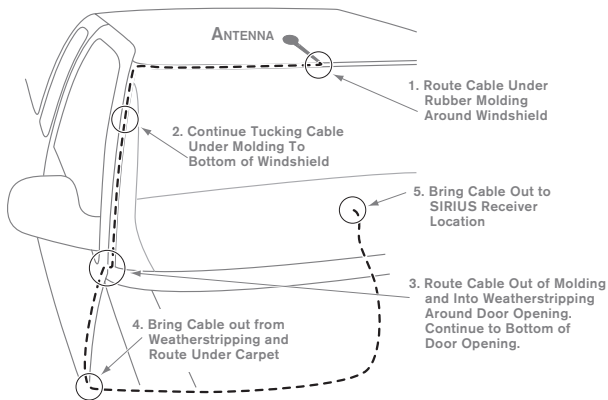

Figure 12

Follow these detailed cable installation instructions:

1. Use a plastic putty knife or similar tool to lift the rubber molding around the windshield and tuck the antenna cable underneath it.
2. Continue tucking the cable underneath the windshield molding around the windshield to the lowest corner.

3. At the lowest corner of the windshield, route the cable out of the windshield molding and into the rubber weather stripping around the door opening. Lift the weather stripping from the opening and tuck the cable inside it, then replace the weather stripping. Run the cable inside of the weather stripping to the bottom of the door opening.
4. Pull the cable out of the weather stripping at the bottom of the door opening and route it under the carpet toward the dashboard. Coil any excess cable in a hidden location, such as under the carpet, keeping it away from any vehicle pedals or controls. Secure the excess cable with wire ties.
5. Bring the end of the cable out at the SIRIUS Vehicle Dock location. Leave yourself enough cable so you can easily connect it to the antenna connector on the Vehicle Dock.

SUV/Mini-Van Antenna Cable Routing Procedure

Figure 13 (on page 29) shows how the antenna cable should be routed from the antenna to your SIRIUS radio in an SUV or a Mini-Van.

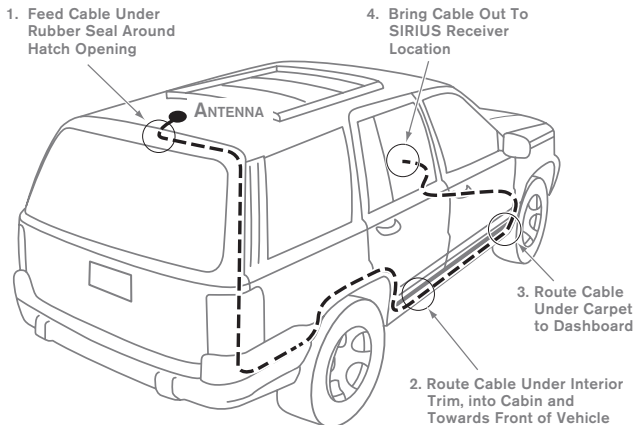

Figure 13

Follow these detailed cable installation instructions:

1. Feed the antenna cable underneath the rubber weather stripping of the rear tailgate window/door and route the cable along the rear hatch. Lift the weather stripping from the opening and tuck the cable inside it, then replace the weather stripping. Pull the cable out from weather stripping and route it into the cabin under the interior trim. Avoid hinges or gears that could crimp or cut the cable.
2. Route the cable through the SUV's main cabin area under the interior trim, towards the front of the vehicle. Use a plastic putty knife to lift the plastic trim just enough to tuck the cable under underneath. Avoid side airbag locations on back pillars and above the doors. (Airbag locations are marked with "SRS" logos.) Be careful not to crimp or cut the cable.

- Bring the cable out from the trim near the firewall and route it under the carpet toward the dashboard or console. Coil any excess cable in a hidden location, such as under the carpet, keeping it away from any vehicle pedals or controls. Secure the excess cable with wire ties.
- Bring the end of the cable out at the SIRIUS Vehicle Dock location. Leave yourself enough cable so you can easily connect it to the antenna connector on the Vehicle Dock.

Convertible Antenna Cable Routing Procedure

Figure 14 shows how the antenna cable should be routed from the antenna to your SIRIUS radio in a convertible.

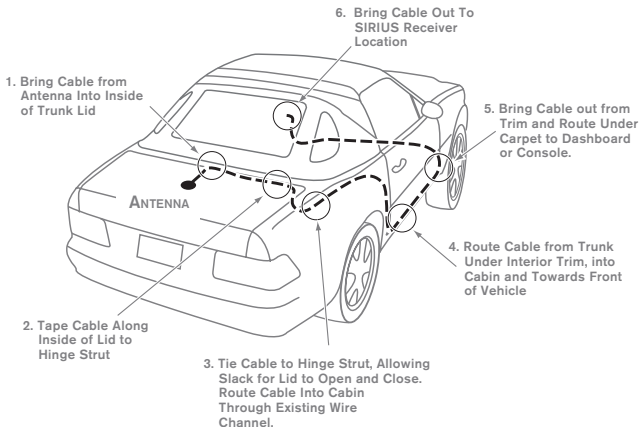

Figure 14

Follow these detailed cable installation instructions:

1. Bring the cable from the antenna into the trunk at the front edge of the trunk lid. Keep any bends in the cable loose. Tape or tie the cable along the inside of the trunk lid to the trunk lid hinge strut.
2. Allow enough slack in the cable so the trunk lid can easily open and close and keep the cable away from hinges, gears, etc., that could crimp or cut it. Route the cable along the trunk wall and into the cabin through a conduit or along an existing wiring harness.
3. Route the cable through the main cabin area under the interior trim, towards the front of the vehicle. Use a plastic putty knife to lift the plastic trim just enough to tuck the cable under underneath. Avoid side airbag locations on back pillars and above the doors. (Airbag locations are marked with "SRS" logos.) Be careful not to crimp or cut the cable.
4. Bring the cable out from the trim near the firewall and route it under the carpet toward the dashboard or console. Coil any excess cable in a hidden location, such as under the carpet, keeping it away from any vehicle pedals or controls. Secure the excess cable with wire ties.
5. Bring the end of the cable out at the SIRIUS Vehicle Dock location. Leave yourself enough cable so you can easily connect it to the antenna connector on the Vehicle Dock.

TIPS

The following **DO** and **DO NOT** antenna mounting tips illustrate how to install the antenna for optimal performance, and also illustrate where the antenna should not be installed.

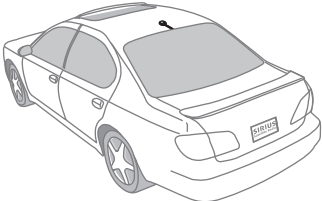
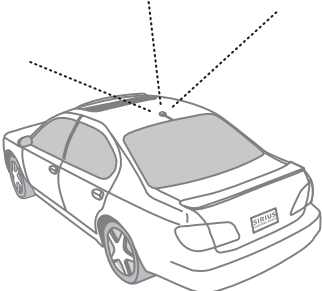
DO	Mount the antenna on the roof, at least 3 inches from the edge.	 A line drawing of a sedan from a rear three-quarter view. A small antenna is mounted on the roof, positioned very close to the rear edge of the roofline.
DO	Mount the antenna on the roof where it has a clear view of the sky in all directions.	 A line drawing of a sedan from a rear three-quarter view. An antenna is mounted in the center of the roof. Three dashed lines radiate upwards from the antenna, representing a clear view of the sky in multiple directions.

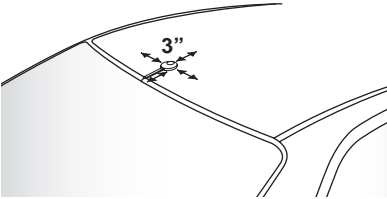
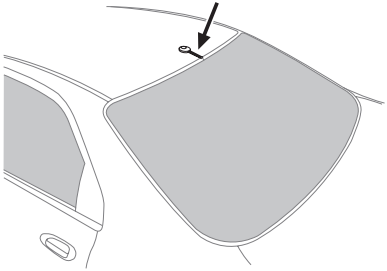
DO	Mount the antenna on the roof where it has at least 3 inches of clear space around it.	 A line drawing of a car's roof showing the antenna location. A circle with a crosshair is drawn around the antenna base, with arrows pointing outwards to a square boundary. The text "3''" is written above the circle, indicating the required clear space around the antenna.
DO	Use the supplied Rubber Tail Cover to protect the antenna cable.	 A line drawing of a car's rear roof area. A large, dark gray, trapezoidal rubber tail cover is shown being applied to the antenna cable. An arrow points to the cover, and a small circular detail of the cover's edge is shown below the main drawing.

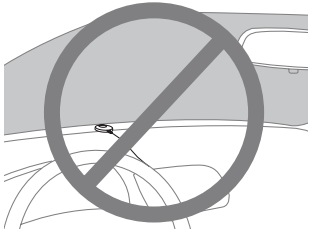
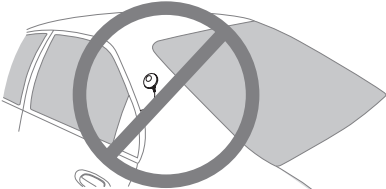
DO NOT	Don't mount the antenna inside the vehicle, for example, on the dashboard.	
DO NOT	Don't mount the antenna on any of the vehicle's front, back or side pillars.	

**DO
NOT**

Don't mount the antenna close to a roof rack. Adjust the rack so it's further away from the antenna or move the antenna closer to the center of the roof.

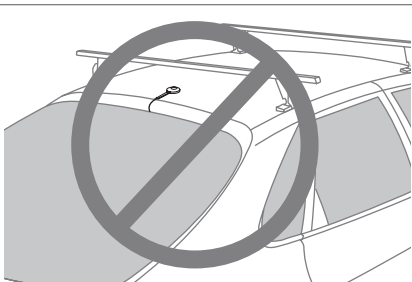

**DO
NOT**

Don't mount the antenna close to another antenna. Mount it at least 3 inches away.

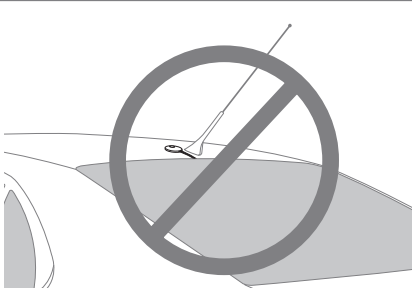

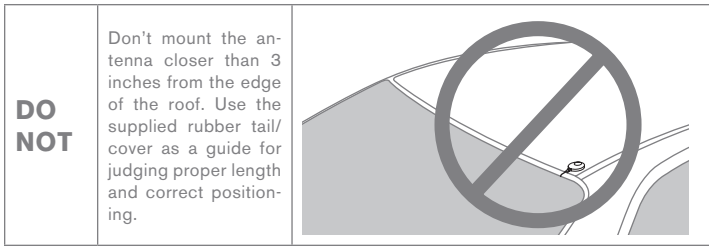

After you've routed the cable to the SIRIUS Vehicle Dock, connect the antenna cable to the ANT connection on the right side of the Vehicle Dock. (See *Figure 15*.)

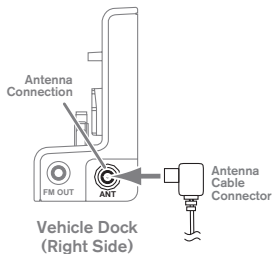

Figure 15

Connecting the Cigarette Lighter Adapter

Connect the provided cigarette lighter adapter to the 5VDC connector on the back of the Vehicle Dock. (See *Figure 16*.)

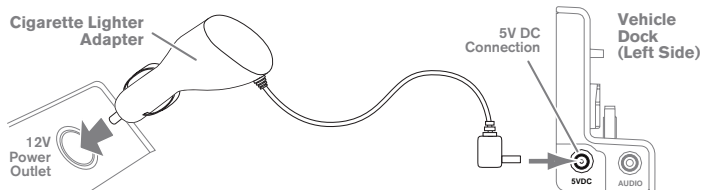

Figure 16

Note: Do not power the Vehicle Dock directly from your vehicle's 12VDC power system without using the Cigarette Lighter Adapter. This could damage the Vehicle Dock, your SIRIUS radio or both.

Docking Your SIRIUS Radio

To place your SIRIUS SP5 into the Vehicle Dock, align the radio against the rear of the Dock so that the rails on the Dock fit into the mounting slots in the back of the radio (*Figure 17*). Slide the radio all the way down onto the Dock so that it fits firmly.

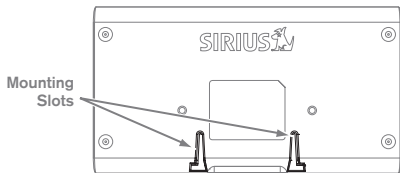

Figure 17

Connecting Your SIRIUS Radio to Your Vehicle's Audio System

There are two ways to connect your SIRIUS Sportster SP5 to your vehicle's audio system: Direct Connection or Wireless Connection. Which one will perform best in your vehicle depends on your vehicle's audio system.

For the latest information go to <http://www.siriuscanada.ca/en/install/vehicle.aspx>.

Direct Wired Audio Connection

If your vehicle's audio system has an "Aux In" or "LINE IN" jack it is the best-quality audio connection you can use for your SIRIUS radio. (And if the Aux In or LINE IN connector is located somewhere on the front of your vehicle radio or elsewhere in the cabin, this is also the easiest way to connect your SIRIUS radio.)

1. Purchase an audio cable that matches the connection type of your vehicle's audio system and your SIRIUS Vehicle Dock at your local electronics retailer.
 - The Vehicle Dock requires a male $\frac{1}{8}$ " stereo connector.
2. Plug the cable's male $\frac{1}{8}$ " stereo connector into the AUDIO jack on the left side of the Vehicle Dock. Plug the other end into the Aux In/LINE IN connector on your vehicle's audio system. (See *Figure 18*.)

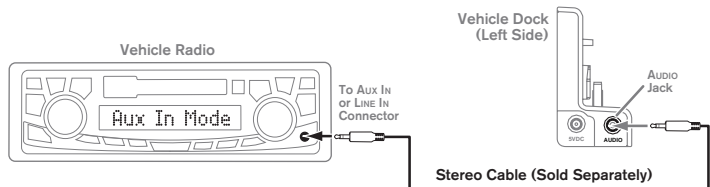

Figure 18

Direct FM Audio Connection

If your vehicle's audio system does not have an Aux In/Line In connection, a SIRIUS FM Direct Adapter (sold separately) will provide the next best quality connection between your SIRIUS radio and your vehicle radio. You will listen to your SIRIUS radio through your car radio's FM tuner, but the SIRIUS FM Direct Adapter connects your vehicle's FM radio directly to your SIRIUS radio's FM Out jack, eliminating the outside static and interference you sometimes experience when using a wireless FM connection. (See *Figure 19*.)

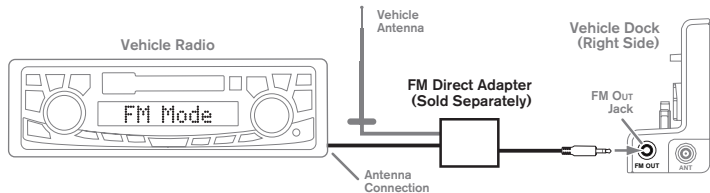

Figure 19

NOTE: Professional installation may be required. See your local SIRIUS retailer. The SIRIUS FM Direct Adapter is available at your local SIRIUS retailer or at <http://shop.siriusscanada.ca>. Follow to the instructions included with the FM Direct Adapter.

Cassette Adapter

If your vehicle's audio system has a cassette player you can purchase a cassette adapter from your local electronics retailer or from SIRIUS at <http://shop.sirius.com>. Plug the adapter's connector into the AUDIO jack on the left side of the Vehicle Dock, and insert the adapter into your vehicle's cassette player. (See *Figure 20*.)

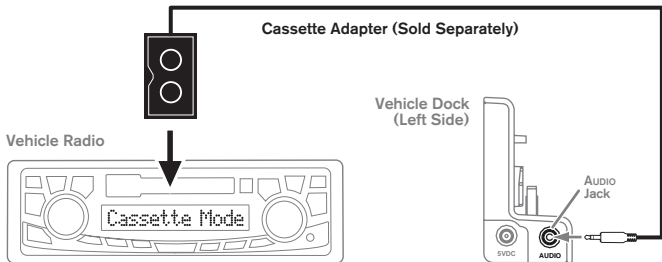

Figure 20

Note: Refer to the cassette adapter's instructions for correct use.

Wireless Connection

If you cannot connect your SIRIUS radio directly to your vehicle's audio system, your SIRIUS radio contains an FM transmitter that will 'broadcast' its audio to your vehicle's FM radio.

To use this you need to tune the SIRIUS receiver's FM transmitter to an FM frequency that's not being used in your area (If you use an FM channel that is being used by a local broadcaster, it will interfere with the performance of your SIRIUS radio.) See *Figure 21*, opposite..

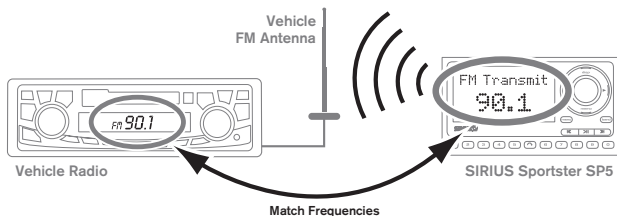

Figure 21

1. Tune through your vehicle radio's FM channels to find an FM channel (between 88.1MHz and 107.9MHz) that is not broadcasting in your area.
2. Once you have located an FM channel that is not broadcasting in your area, save it as a preset on your vehicle radio. This will become your SIRIUS preset.
3. Dock your SIRIUS receiver and turn its power ON. Wait for the Channel Update to finish before pressing any buttons.
4. Press and hold the FM Presets button (see *Figure 22*, left). The MENU OPTIONS screen will appear. Rotate the Knob to highlight SETTINGS and press the Knob to select it.
5. The SETTINGS screen will appear (see *Figure 22*, right). Rotate the Knob to highlight FM TRANSMITTER and press the Knob to select it.

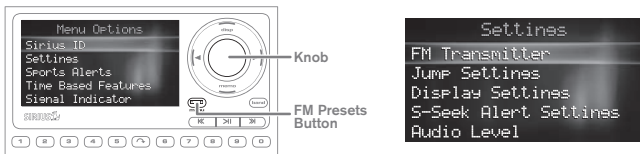

Figure 22

6. The FM TRANSMITTER screen will appear (see *Figure 23*, left). Rotate the knob to highlight SET FM PRESETS and press the Knob to select it.



Figure 23

7. The SET FM PRESETS screen will appear (see *Figure 23*, right). FM1 will be highlighted. (FM1 is factory-set to 88.1MHz. This may not be the best frequency for your area.)
8. Press the Knob to select FM1. The SET FM PRESET 1 screen will appear (see *Figure 24*, left).



Figure 24

9. Rotate the Knob to highlight the FM frequency that matches the channel that you preset on your vehicle radio in *Step 2* on page 41, then press the Knob to select it. (See *Figure 24*, right.)

To listen to your SIRIUS radio, turn your SIRIUS radio ON, then turn your vehicle's FM radio ON and press the SIRIUS preset you set in *Step 2* on page 41.

TIP: If you regularly travel between cities with different active FM channels, you may need to find channels that are not broadcasting in each city. Your SIRIUS Sportster SP5

can store up to 5 preset FM transmit channels (see *Figure 23*, right), so you can easily switch to the best FM channel for each city.

- To switch the FM transmit preset, press the FM Presets button on either the SP5 front panel or the remote.

If you're not sure which FM channels are not broadcasting in your home or travel cities, you can also go to <http://www.siriuscanada.ca/en/install/frequency.aspx> and search for a suggested FM channel based on your zip code.

Installing the FM Transmitter Antenna

The FM Transmitter Antenna (FMTA) brings the FM signal transmitted by your SIRIUS radio closer to your vehicle's FM antenna to provide a strong FM signal for good reception. To install the FTMA:

1. Connect the FMTA to the vehicle dock. Insert the FMTA 2.5 mm plug into the FM OUT connector of the vehicle dock. (See *Figure 25*, left.)
2. Position FMTA inside the vehicle. The FMTA wire should be run with the power adaptor wire, and placed on the dash board or even placed under the dash pad (if possible). (See *Figure 25*, right.) If your Sportster is mounted to the center console, the FTMA wire should be run along console.
3. Hide the wires. Depending on the position of your Sportster, hide the wires by tucking them into the seams in the dash board or the console seams where possible.

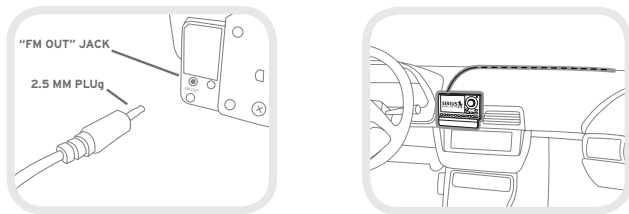

Figure 25

Subscribing to the SIRIUS Service

Before you can listen to the SIRIUS service, you need to subscribe to the SIRIUS Satellite Radio service. To subscribe, do the following:

1. Be sure that your SIRIUS Sportster SP5 is correctly installed, is properly docked in the Vehicle Dock, and that the antenna is oriented to receive the SIRIUS signal.
2. Turn on the SP5. After the startup sequence, it will update the SIRIUS channel line-up. Wait until the channel updates have completed before pressing any buttons.
3. Once the channels have been updated, the radio will automatically tune to channel 184 and the display will change to *Call 1-888-539-SIRIUS to Subscribe*. You will not be able to listen to any other channels until you activate your SIRIUS subscription.
4. Use the SP5's Knob to tune to channel 0 to display your SP5's unique 12-digit SIRIUS ID Number (SID). You can also tune to channel 0 by using the remote control: Press the SELECT button, then the 0 (zero) button, and then the SELECT button again. The SID number is also available on your SP5's packaging, and may also be accessed by pressing the MENU button and selecting SIRIUS ID. Write the SID number down.
5. Have your credit card handy and contact SIRIUS on the Internet at: <https://activate.siriuscanada.ca/> and follow the prompts to activate your subscription. You can also call SIRIUS toll-free at **1-888-539-SIRIUS** (1-888-539-7474).
6. When you have successfully subscribed to the SIRIUS service your SP5 will display an alert. To continue, press the Knob.

You are now ready to begin enjoying SIRIUS Satellite Radio's digital entertainment, and can tune to other channels!

Controls

SIRIUS Sportster SP5 Front Panel

Figure 26 and the section following identify and describe the SIRIUS Sportster SP5's buttons and controls.

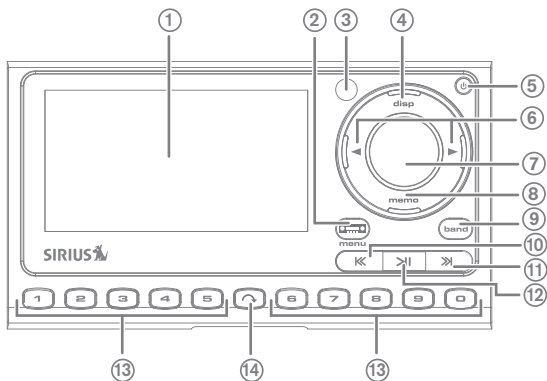

Figure 26

1. **Color LCD Display Screen:** Provides information about the SP5's operation, the program that is playing and other programming that is available.
2. **FM Presets/MENU Button:** Lets you select between the different FM preset frequencies used by the SP5's built-in internal FM transmitter. Press-and-hold accesses Menu options to make setup and feature changes.
3. **IR Receiver:** Receives IR signals from the included remote control.
4. **Display (DISP) Button:** Pressing and releasing this button changes the text size of artist names and song titles on the display screen. Pressing and holding this button displays the last screen viewed in the Channel List mode (see page 53).
5. **Power Button:** Turns the SP5 ON and OFF.
6. **Category Buttons:** Press-and-release navigates through the CATEGORY LIST screens which display the SIRIUS channel categories. Pressing and holding the buttons increase or decrease the display's brightness, or lets you adjust the Auto Brightness settings, depending on the option selected in the Menu Options (see page 80).
7. **Rotary Knob/Select Button:** Rotating the Knob navigates through the different display screens; pressing the Knob makes selections of items highlighted on the display screen. Rotating clockwise increases the channel number (down the list), and moves down when in a menu list; rotating counterclockwise decreases the channel number (up the list), and moves up in when in a menu list. When not in a menu or list, pressing the Knob selects the channel entered using the Preset Number buttons.
8. **Memory (MEMO) Button (S-Seek Function):** Pressing and releasing this button saves artist names and song titles. You can store up to 30 artist/song title combinations, including favorite teams and traffic channels. Pressing and holding the MEMO button will enter the recall mode, displaying the stored artist/song titles.
9. **Band Button:** Pressing and releasing this button switches between the preset banks A, B, and C, which hold 10 presets each for a total of 30. Pressing and holding this button switches to the My PRESETS category, which lets you see what artists and songs are playing on each of your stored presets.

- 10. Rewind Button:** Used to rewind through content saved to Instant Replay. Pressing and releasing this button rewinds to the beginning of the song or program. Pressing and holding rewinds by time through the saved content.
- 11. Fast-Forward Button:** Used to fast-forward through Instant Replay saved content. Pressing and releasing this button fast-forwards to the beginning of the next song or program. Pressing and holding fast-forwards by time through the saved content.
- 12. Play/Pause Button:** Pauses and replays live or time-shifted content from the currently tuned channel. Pressing and holding this button displays the list of Saved content.
- 13. Number Buttons (0 – 9):** Set and select preset channels. Also used to directly-select channels.
- 14. Jump Button:** Jumps to a preset favorite channel. Pressing the button again returns back to the original channel.

Remote Control Buttons

Figure 27 and the section following identify the remote control's buttons.

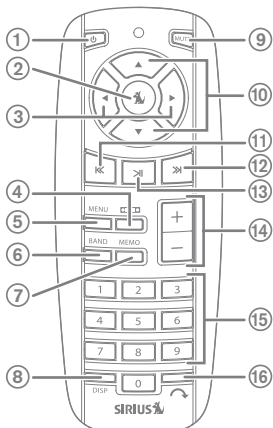

Figure 27

1. **Power Button:** Turns the SP5 ON and OFF.
2. **Select Button:** Selects items highlighted in a list; hold-down to jump to the previously-received channel. When not in a menu or list, pressing the Select button selects the channel entered using the number buttons.

3. **Category Buttons:** Press and release navigates through the CATEGORY LIST screens which display the SIRIUS channel categories. Pressing and holding the buttons increase or decrease the display's brightness, or lets you adjust the Auto Brightness settings, depending on the option selected in the Menu Options (see page 80)
4. **FM Presets Button:** Selects between the different FM preset frequencies used by the SP5's built-in internal FM transmitter.
5. **MENU Button:** Accesses the MENU OPTIONS to make setup and feature changes.
6. **BAND Button:** Pressing and releasing this button switches between the preset banks A, B, and C, which hold 10 presets each for a total of 30. Pressing and holding this button switches to the My PRESETS category, which lets you see what artists and songs are playing on each of your stored presets.
7. **Memory (MEMO) Button (S-Seek Function):** Pressing and releasing this button saves artist names and song titles. You can store up to 30 artist/song title combinations. Pressing and holding will enter the recall mode, displaying the stored artist/song titles.
8. **Display (DISP) Button:** Pressing and releasing this button changes the text size of artist names and song titles on the display screen. Pressing and holding this button displays the last screen viewed in the Channel List mode (see page 53).
9. **MUTE Button:** Mutes the SP5's audio output.
10. **Channel UP/DOWN Buttons:** Navigates through channels and display screens.
11. **Rewind Button:** Used to rewind through content saved to Instant Replay. Pressing and releasing this button rewinds to the beginning of the song or program. Pressing and holding rewinds by time through the saved content.
12. **Fast-Forward Button:** Used to fast-forward through Instant Replay saved content. Pressing and releasing this button fast-forwards to the beginning of the next song or program. Pressing and holding fast-forwards by time through the saved content.
13. **Play/Pause Button:** Pauses and replays live or time-shifted content from the currently tuned channel. Pressing and holding this button displays the list of Saved content.
14. **VOL+ / VOL- Buttons:** Increases or decreases the audio volume.
15. **Number Buttons (0-9):** Select channels directly and select preset channels.

16. Jump Button: Jumps to a preset favorite channel. Pressing the button again returns back to the original channel.

Remote Control Battery Installation

To install the remote control battery, turn the remote control over and locate the battery cover near the bottom edge. Open the battery compartment and place the battery in the compartment with the + side of the battery facing up. Replace the battery cover on the remote control. See *Figure 28*.



Figure 28

Vehicle Dock Reference Guide

Figure 29 and the section following identify and describe the Vehicle Dock's features and connectors.

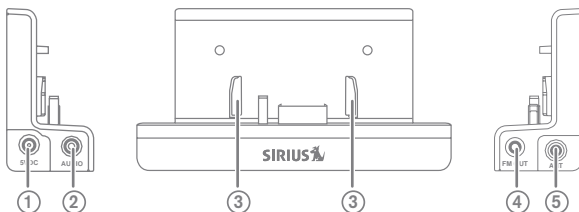

Figure 29

1. **DC5V Power Connector:** Power connection for the supplied cigarette lighter adapter (see page 37).
2. **Audio Out (Audio) Connector:** Audio output for directly connecting to your vehicle's audio system (see pages 38 & 40).
3. **Docking Rails:** Fit-into slots in the back of the SP5 to secure it while it is docked (see page 37).
4. **FM Out Connector:** FM output for use with the optional FM Direct Adapter (see page 39).
5. **Antenna (Ant) Connector:** Connection for the supplied magnetic antenna (see page 36).

Operation

Display Screen Information

Your SIRIUS Sportster SP5's display screen provides information about the operation of the radio, such as the currently tuned channel, song or show being played, artist name, time and other information. This screen is referred to as the *Default* screen in this manual. *Figure 30* identifies the information displayed when listening to a typical broadcast.

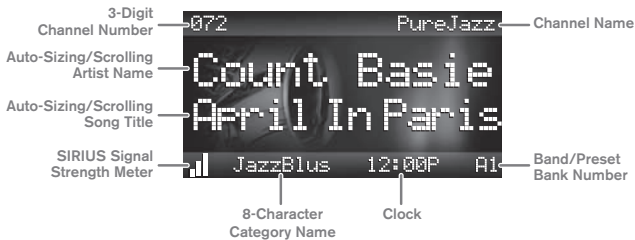

Figure 30

Whenever you power the SP5 **ON**, the previously-selected channel will automatically begin playing, and the currently-playing artist name and song title will be displayed.

Navigating Menus and Lists

The menu and list structures in your SIRIUS Sportster SP5 are navigated by turning the Knob to scroll through a menu or list to highlight your choice, and then pressing the Knob to select the choice. When using the remote control, menus and lists are navigated by pressing the Channel UP/DOWN buttons, and then pressing the SELECT button to select the choice.

Display (DISP) Button

Pressing and releasing the DISP button while the Default screen is displayed toggles between the 2-line artist name/song title text and large character displayed text (see *Figure 31*). The large character format will change the character size and cause the field to scroll from right to left. This feature is useful when viewing the display screen from a distance. Note that the displayed text will scroll only if the length of the artist or title cannot be viewed in its entirety.



2-Line Text Format



Large Text Format

Figure 31

Pressing and holding the DISP button for 1½ seconds enters the Channel List mode. Once the Channel List mode is active, repeatedly pressing and releasing the DISP button will cycle the display between these four screens (see *Figure 32*):

- **Combination List Screen:** Displays a list of channel numbers and names along with the currently-playing song titles and artist names on each channel.
- **Channel Name Screen:** Displays a list of channel numbers and channel names.
- **Artist Name Screen:** Displays a list of the currently-playing artists on each channel.
- **Song Title Screen:** Displays a list of the currently-playing songs on each channel.

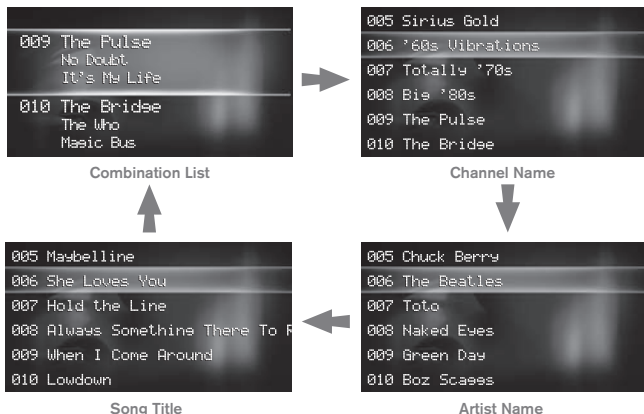

Figure 32

To exit the Channel List mode and return to the Default screen, press and hold the DISP button.

Search Modes (Preset, Category, Channel, Artist, Song Title)

You can search for and select music four ways on your Sportster SP5: by category, by channel, by artist, and by song title.

Searching Categories

If you want to browse different entertainment categories, press either Category button to activate the Category Search mode, which will display a list of the currently-playing artists and currently-playing song titles on the different channels of the currently-active category.

1. Use the Category buttons to scroll through the music and entertainment categories (see *Figure 33*). Note that your preset channels will be displayed as the MY PRESETS category.
2. When the category you want is displayed (for example, *Pop*), use the Knob to browse the available channels within the category (on the remote, use the Channel UP/DOWN buttons). When the desired channel is highlighted, press the Select button to select it. The channel will be selected and the display will revert to the Default screen for the selected channel.

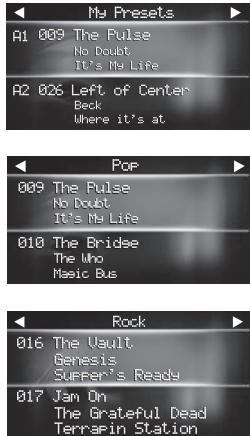
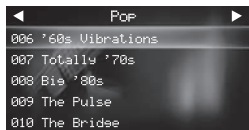
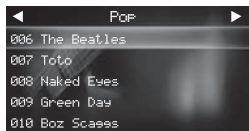

Figure 33

- Pressing the DISP button while in the category search mode will cycle between the category's channel names, the currently-playing artist names, and the currently-playing song titles to enable you to preview what is playing on other channels before making a selection. (See *Figure 34*.) When the channel/artist/song you want is highlighted, press the Select button. The channel will be selected and the display will revert to the Default screen for the selected channel.
- To exit the Category mode without changing to a new channel, press and hold the DISP button for one second.



Channel Name



Artist Name

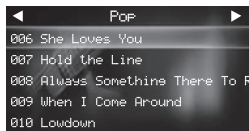

Song Title

Figure 34

Searching Channels (Channel List Mode)

It is possible to search for a different channel while listening to your current channel. Be sure that the display shows the Default display screen prior to the following steps:

1. Press and hold the DISP button for two seconds to activate the channel list mode. The channel list screen be displayed, showing all available channels regardless of category. Pressing the DISP button while in the channel list mode will change between channel name, artist name, and song title (see *Figure 35*). You can use this feature to search for a specific artist, song, or show that may be playing at the time.
2. Turn the Knob to locate the channel you want (on the remote, use the Channel UP/DOWN buttons).
3. Press the Select button to select the channel. To exit the channel list mode without changing to a new channel, press and hold the DISP button for one second.

Note: If you are in the channel list mode and viewing a sports category channel list (NFL® Zone, NHL® Zone, NBA® Zone), pressing the DISP button will toggle between the team names and the current score of any live play-by-play game.

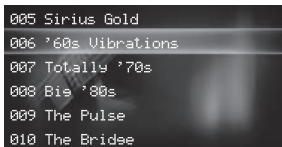

005 Sirius Gold
006 '60s Vibrations
007 Totally '70s
008 Bis '80s
009 The Pulse
010 The Bridge

Channel Name

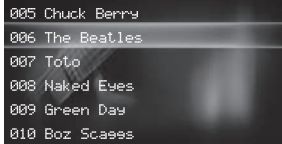

005 Chuck Berry
006 The Beatles
007 Toto
008 Naked Eyes
009 Green Day
010 Boz Scaggs

Artist Name

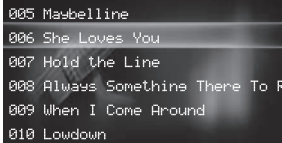

005 Maybelline
006 She Loves You
007 Hold the Line
008 Always Somethine There To R
009 When I Come Around
010 Lowdown

Song Title

Figure 35

Direct Tuning

Channels can be directly accessed by pressing and releasing the Knob and then using the 0 – 9 keys to enter the desired channel number (see *Figure 36*). Once the desired number has been entered, the channel will change and the display will revert to the Default screen for the selected channel. The SP5 will tune the channel immediately if three numbers are entered (for example, “0”, “0”, “7”), but if just one or two digits are entered, the radio will tune to the new channel after three seconds.

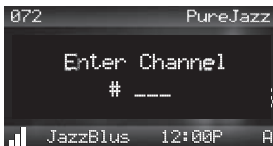

Figure 36

Channel Presets

Channel presets lets you store up to 30 of your favorite channels as presets for quick access with the press of a button.

Setting Channel Presets

Presets are stored in three banks, A, B, and C, each containing 10 channel presets.

1. Press the **BAND** button to activate the preset bank you want. The selected bank is shown in the lower right corner of the Default display screen (see *Figure 30*, on page 52).
2. Select the channel you want to preset.
3. Press and hold for two seconds the numbered preset button (0 – 9) in which you want to store the channel.

4. The selected preset number will flash and then remain lit on the display to show that it has been memorized.

If the preset button you selected already has a channel stored in it, the preset will be replaced with the newly stored channel.

Recalling Channel Presets

The 10 presets in the active bank (A, B, or C) can be selected by pressing the 0 through 9 buttons.

1. Press the **BAND** button to activate the preset bank you want. The selected bank is shown in the lower right corner of the default display screen.
2. Press the desired preset button 0 – 9 to select the preset. The channel will change and the display will revert to the Default screen for the new channel, with the preset shown in the lower right corner.

Pressing and holding the **BAND** button displays the **MY PRESETS** screen (see below).

MY PRESETS SCREEN

You can use the Knob to quickly see what's playing on all of your presets:

1. Press and hold the **BAND** button to activate the **MY PRESETS** screen (see *Figure 37*).

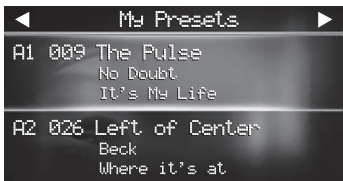

Figure 37

2. Turn the Knob in either direction to move through the presets. When the preset you want to listen-to is highlighted, press the **Select** button to tune to it.

Turning the Knob will cycle through all of the stored presets by preset bank and number (for example, A-1, A-2...B-1, B-2...C-1,C-2...). Continuing to turn the Knob after the last stored preset is displayed will return back to the first stored preset.

To exit the MY PRESETS screen and return to Default display screen, press and hold the BAND button.

Jump Button

Your SIRIUS Sportster SP5 features a special button called Jump. This button can be programmed to jump to a channel which is accessed frequently and temporarily such as weather, news, or sports. The JUMP button lets you quickly tune to a specific channel and then tune back to the original channel by pressing the button again (see *Figure 38*).

Refer to Jump SETTINGS on page 79 for information on configuring the JUMP button.

If the JUMP button is set to *JumpSet*, pressing the JUMP button will immediately tune to the programmed channel. Pressing the JUMP button again will return to the channel to which you had been listening immediately prior to pressing the JUMP button.

Note: The JUMP button setting remains the same regardless of which preset bank is currently selected.

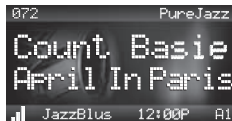

Figure 38

Memory (MEMO) and Song Seek (S-Seek) Functions

Your Sportster SP5 lets you to capture and store information (artist, song, sports team, or traffic city) about the programming on the currently-tuned channel, up to a total of 50 items. The SP5 then continuously searches all the SIRIUS channels and alerts you when a match to a saved program is being played. When a sports team (or teams) are stored in memory, at the time the radio is initially powered on, you will be alerted when the sports teams are playing in a game being broadcast. Also, while listening to your SIRIUS radio, you will be alerted should one of the teams begin to play a game.

Storing Artist Names, Song Titles, and Sports Teams to Memory

If you are listening to a song or other entertainment channel, or a sports team, and wish to save the artist, song, or sports team selection to memory for future S-Seek alerts, do the following:

For Artist Names or Song Titles: If the currently tuned-channel is a music or entertainment channel, momentarily press and release the MEMO button. The radio will display a menu to choose to store the artist name or the song title (see *Figure 39*).

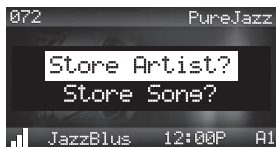

Figure 39

If either the artist name or song title is not available to save, the choice will be displayed as unavailable (see *Figure 40*).



Figure 40

Turn the Knob (on the remote, use the Channel UP/DOWN buttons) to highlight STORE ARTIST or STORE SONG (when available) and press the Select button to save the current selection to memory.

If both the artist and song are available to save, you will be prompted again to save whichever one you haven't yet saved, song title or artist name. If you do not wish to save, press the MEMO button to exit.

For Sports Events: If the currently-tuned channel is an NFL, NBA, NHL, NASCAR or college play-by-play sports broadcast, momentarily press and release the MEMO button. The SP5 will display a menu to choose which sports team (or for NASCAR, which car number) should be saved to memory (see *Figure 41*)

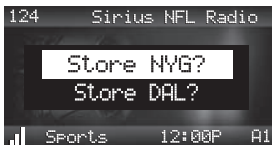

Figure 41

If either of the teams is not available to save, that team will be displayed as unavailable (see *Figure 42*).

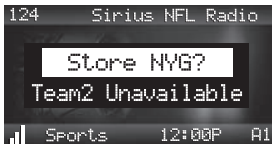

Figure 42

Turn the Knob (on the remote, use the Channel UP/DOWN buttons) to highlight the desired sports team or car number (when available) and press the Select button to save the current selection to memory.

The next screen will ask which kind of alert you wish to have (see *Figure 43*).



Figure 43

ALERT: INITIAL will provide a pop-up alert when the team you have chosen is playing a game; **All** will provide a pop-up alert when the team you have chosen is playing a game, and when the score for the game is updated.

TICKER: Displays the information (including the channel that is carrying the game) for the team continually during a game they are playing. The currently-playing artist and song title will still be visible when the ticker is active.

Turn the Knob (on the remote, use the Channel UP/DOWN buttons) to highlight the desired alert and press the Select button to choose the desired alert setting. To save your selection turn the Knob to highlight DONE and press the Select button. If you do not want to save, press the MEMO button to exit.

The radio will then revert to the last active display mode.

If the new alert was successfully stored in memory, an **ARTIST/SONG/GAME STORED** pop-up screen followed by an **X USED/Y EMPTY** screen will be displayed for one and two seconds respectively. **X** is the total number of listings stored in memory, and **Y** is the total number of memory listings still available for storage (see *Figure 44*).

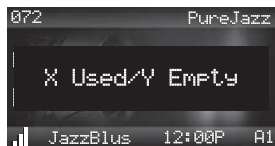

Figure 44

If all of the memory spaces are full when you press the MEMO button, a MEMORY FULL screen will be displayed for one second (see *Figure 45*).



Figure 45

A REPLACE-CANCEL screen will then be displayed (see *Figure 46*).



Figure 46

Turn the Knob (on the remote, use the Channel UP/DOWN buttons) to highlight whether to replace an existing alert or cancel saving the alert to memory, and press the Select button. If you chose to cancel saving the alert, the SP5 will revert to the last active display mode. If you chose to replace an existing alert, a listing of all the alerts stored in memory will be displayed (see *Figure 47*).



Figure 47

Each listing will be preceded by an icon that identifies the type of listing: a musical note for songs, a happy face for artists and a flag for sports teams/cars.

Turn the Knob (on the remote, use the Channel UP/DOWN buttons) to highlight the alert that you would like to replace and press the Select button to store the new alert. If the new alert was successfully stored in memory, the ARTIST/SONG/GAME STORED pop-up screen followed by the X USED/Y EMPTY screen will be displayed for one and two seconds respectively (see *Figure 44*, on page 64). The SP5 will then revert to the last active display mode.

Viewing Program Information stored in Memory

To view the program information stored in memory:

1. Press and hold the MEMO button for three seconds to enter the S-Seek Browse mode. The program information stored in memory will be displayed in one-at-a-time page format.
2. Use the Knob (on the remote, use the Channel UP/DOWN buttons) to scroll through the listings. This function allows you to review previously stored program information. The information will be displayed as sports league or college/team name or artist name/song title (see *Figure 48*).

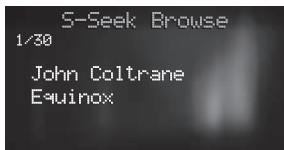

Figure 48

Deleting a Song Title Stored in Memory

To delete a song title stored in memory:

1. Press and release the Select button while in S-SEEK mode. A pop-up screen displaying various selectable options will be displayed (see *Figure 49*).

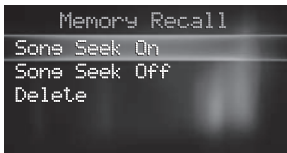

Figure 49

2. Turn the Knob (on the remote, use the Channel UP/DOWN buttons) to highlight the DELETE option.
3. Press the Select button. A DELETE confirmation screen will appear (see *Figure 50*).

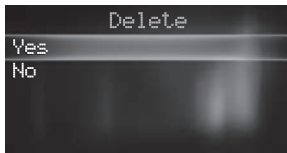

Figure 50

4. To permanently delete the program from your list, use the Knob (on the remote, use the Channel UP/DOWN buttons) to highlight YES and press the Select button to confirm. The S-Seek Browse mode screen (*Figure 48*, on page 66) will return.

Activating the Song (S-Seek) Alert

When S-Seek alerts are enabled, whenever the Sportster SP5 is on it automatically searches the channels to determine if a match exists with the program information stored in radio's memory. If one or more matches are found, a S-SEEK ALERT pop-up screen appears (see *Figure 51*, left) and an audible beep tone is heard, indicating that a match was found. If more than one match is found the My SIRIUS SEEKS screen appears (see *Figure 51*, right), and you can use the Knob (on the remote, use the Channel UP/DOWN buttons) to select the song that you wish to listen to. If you do not make a selection within 10 seconds, the screen will revert to the last active display screen and tuning mode.

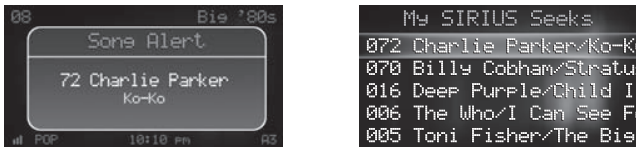

Figure 51

To turn on S-Seek alerts:

1. Press and hold the MEMO button for three seconds to enter the S-Seek mode.
2. Press the Select button. A pop-up screen displaying three selectable options, SONG SEEK ON, SONG SEEK OFF and DELETE are displayed (see *Figure 49*, on page 67).
3. Use the Knob (on the remote, use the Channel UP/DOWN buttons) to highlight the SEEK ON option.
4. Press the Select button to turn on S-Seek alerts.

SPORTS ALERT

Your SIRIUS Sportster SP5 can automatically identify when your favorite sports team is playing. When a game is found, a **SPORTS ALERT** is displayed listing the sports events which are currently being played (see *Figure 52*, left). Press the Select button to tune to the event. If more than one match is found the **My SPORTS ZONE** screen appears (see *Figure 52*, right), and you can use the Knob (on the remote, use the Channel UP/DOWN buttons) to select the game that you wish to hear.



Figure 52

Refer to the *Sports Alert* section on page 90 for information on setting your favorite sports teams. You can also use the S-Seek feature to add sports alerts for additional teams. Refer to the *For Sports Events* paragraph on page 63 for more information.

Instant Replay

The SIRIUS Sportster SP5 is capable of storing the audio of the channel that you're listening to for later playback (up to approximately 44 minutes, depending upon the channel to which you are tuned). As soon as you tune to a channel, the radio automatically begins storing the audio, enabling you to rewind at any time to replay the audio again.

- **PLAY/PAUSE Button** : If you are unable to continue listening to a channel, but don't want to miss the broadcast, pressing the PLAY/PAUSE button will mute the audio and mark the point in the broadcast so you can use Instant Replay to resume listening at a later time. **Pressing and releasing** the PLAY/PAUSE button again while the SP5 is muted begins playing the stored audio from the point at which the program was paused. During Instant Replay playback, the SP5 continues to store the channel's live audio.

Pressing and holding the PLAY/PAUSE button changes the display to a listing of the artist's names in the stored audio, from the most recent to the oldest, beginning with an entry called LIVE. Pressing the button toggles the display between the artist name list and the song/program title list (see *Figure 53*). Use the Knob to highlight a song to play and press the Select button to select it. Choosing LIVE exits the Instant Replay mode, and the SP5 resumes playing the live broadcast.



Figure 53

- **FAST-FORWARD Button** **⏩** : This fast-forwards through the stored audio. **Pressing-and-releasing** the **FAST-FORWARD** button forwards to the start of the next song or program in the stored audio and playback automatically begins from there. Repeatedly pressing and releasing the **Fast-Forward** button continues to move forward in the stored audio to the starts of each song or program until the end of the stored audio is reached. When the end of the stored audio is reached, you will hear a beep (if the Power-Up Tone option is enabled, see page 80), the SP5 will exit the Instant Replay mode and resume playing the live broadcast. **Pressing-and-holding** the **FAST-FORWARD** button for one second advances the Instant Replay playback forward in 10-second intervals, which increases to 15- and then 30-second intervals the longer you press the button. Playback begins immediately when you release the button. When you reach the end of the stored audio you will hear a beep, the SP5 will exit the Instant Replay mode and resume playing the live broadcast.
- **REWIND Button** **⏪** : This rewinds (moves backwards) through the stored audio. **Pressing-and-releasing** the **REWIND** button rewinds to the start of the current song or program in the stored audio, and playback automatically begins. Repeatedly pressing and releasing the **REWIND** button continues to move backwards in the stored audio to the start of each previous song or program until the beginning of the stored audio is reached. If you reach the beginning of the stored audio you will hear a beep (if the Power-Up Tone option is enabled, see page 80) and Instant Replay playback automatically begins. Depending upon where in a particular broadcast the channel was selected, the start of a song or program may not be available in memory. If this occurs, playback will start from where the audio began to be stored. **Pressing-and-holding** the **REWIND** button for one second rewinds the Instant Replay playback in 10-second intervals, which increase to 15- and then 30-second intervals the longer you press the button. Playback begins immediately when you release the button. If you reach the beginning of the stored audio while rewinding you will hear a beep and playback will automatically begin.

Note: When the radio is tuned to another channel, all audio stored in the Instant Replay memory is erased and the tuned channel begins to play. Tuning to another channel may automatically occur if another feature of the radio has been programmed to do so.

- **Progress Bar.** While playing from Instant Replay memory, status information is shown at the bottom of the SP5's display screen (see *Figure 54*).

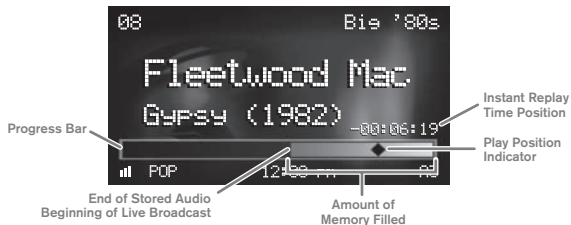

Figure 54

As the Instant Replay memory fills, the Progress Bar fills from the right side, providing a visual indication of how much of the Instant Replay memory is filled. The end of the bar indicates the end of the stored audio, where the live broadcast begins. When all available memory has been used, the bar will be completely filled all the way to the left.

A diamond-shaped Play Position Indicator is superimposed over the Progress Bar, indicating the current playback position in the Instant Replay memory. When you are playing the stored audio, this indicator will move to the left, showing the progression of the playback through the Instant Replay memory. When you pause the playback, the Play Position Indicator will stop moving, indicating your current position in the Instant Replay memory.

While you are in the playback mode, the radio continues to store the audio from the channel. Obviously, you will be unable to “catch up” to the live broadcast during playback, as new audio is being stored at the same rate at which you are playing back the stored audio. You can use the FAST-FORWARD button to skip ahead or exit the Instant Replay mode, and begin listening to the live broadcast again.

When paused, and the Instant Replay memory is 10 seconds from becoming full, you will hear two beeps (if the Power-Up Tone option is enabled). When the memory is full, the SP5 will automatically begin playback, and will continue to store the channel audio, overwriting the oldest portion of the audio previously stored.

The Instant Replay Time Position indicates the exact amount of time the Play Position Indicator is behind the live broadcast, expressed as Hours:Minutes:Seconds, and displayed as a negative number. For example, if -00:02:40 is displayed, this would indicate that the Play Position Indicator is 2 minutes and 40 seconds behind the live broadcast.

When you put Instant Replay into the Fast-Forward, Rewind or Pause Modes, icons appear on the screen to indicate the active mode (see *Figure 55*).



Instant Replay
Fast-Forward Mode



Instant Replay
Rewind Mode



Instant Replay
Pause Mode

Figure 55

FM Presets Button

If you are using a wireless connection between your SIRIUS SP5 and your vehicle's audio system (see page 41), you can easily select between the five different FM transmitter preset frequencies by pressing the FM Presets/MENU button (or pressing the FM Presets button on the remote).

1. Press the FM Presets/MENU button (on the remote, press the FM Transmitter button). The currently-stored FM preset will appear (see *Figure 56*). The SP5's FM transmitter 'broadcasts' on the FM frequency shown.



Figure 56

2. To switch the SP5's FM transmitter to the next stored FM preset, press the FM Presets/MENU button again (on the remote, press the FM Presets button again). The SP5's FM transmitter now broadcasts on this FM Preset 2's frequency (see *Figure 57*). Each press of the FM Presets/MENU button (or each press of the FM Presets button on the remote) will change to the next FM Preset. (Pressing the FM Presets/MENU button while FM Preset 5 is active will change back to FM Preset 1.)



Figure 57

Note: To set or change the FM Preset frequencies, see *FM Transmitter*, on page 78.

Menu Options

Menu Options allows you to set and/or change the various features and settings of your SIRIUS Sportster SP5. To enter the menu options, press and release the MENU button. The MENU OPTIONS screen will be displayed (see *Figure 58*).

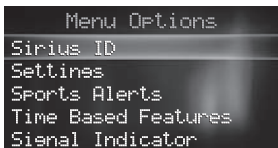

Figure 58

Use the Knob (on the remote, use the Channel UP/DOWN buttons) to highlight selections in the menu lists and press in the Select button to select them. To exit a menu, press the MENU button.

The following selections (shown in bold text) are available from the MENU OPTIONS screen, and allow you to change the parameters for the items listed under the heading:

Sirius ID

Settings

- FM Transmitter
- Jump Settings
- Display Settings
- S-Seek Alert Settings
- Audio Levels
- Channel Preview
- Factory Default
- Parental Control

Sports Alerts

Time Based Features

- Clock
- Alarm
- Program Alert
- Sleep Mode
- Auto Shutdown

Signal Indicator

Each of these menu options is explained in the following sections. Note that if a selection is not made within 10 seconds, the SP5 will exit the MENU OPTIONS screen and revert back to the Default display screen.

Sirius ID

This displays your 12-digit SIRIUS ID (SID) number (see *Figure 59*). The SID is unique to each SIRIUS radio, and is required to activate your SIRIUS service. We recommend that you write this number in the space provided near the end of this user guide. No adjustments are allowed in this mode. To exit, press the Select button or press the MENU button.

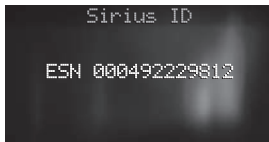

Figure 59

Settings

The Settings menu allows you access the following settings:

- FM Transmitter
- Jump Settings
- Display Settings
- S-Seek Alert Settings
- Audio Levels
- Channel Preview
- Factory Default
- Parental Control

Press the MENU button, then highlight and select SETTINGS. The SETTINGS screen will appear (see *Figure 60*).



Figure 60

FM TRANSMITTER

The FM TRANSMITTER menu option allows you to enable or disable the SP5's built-in FM transmitter, and select up to 5 different FM transmitter frequencies.

FM Presets

1. Select the FM TRANSMITTER menu option. The FM TRANSMITTER screen will appear. See *Figure 61*, left.



Figure 61

2. Highlight FM and press the Select button to select ON or OFF. (Selecting OFF turns the SP5's FM transmitter OFF.)
3. Highlight and select SET FM PRESETS. The SET FM PRESETS screen will appear (see *Figure 61*, center).
4. FM1 is factory-set to 88.1MHz. This may not be the best frequency for your area. To change it, highlight and select FM1. The SET FM PRESET 1 screen will appear (see *Figure 61*, right).
5. Highlight an FM frequency that's not being used by a broadcaster in your area, then press the Select button to select it. The SET FM PRESETS screen will return.
6. Repeat Steps 4 and 5 to set FM transmitter frequency presets FM2 – FM5.

Note: To switch the FM transmitter preset frequency while listening to your SP5, press the FM Presets/MENU button on the SP5 front panel, or press the FM Presets button on the remote.

DISPLAY SETTINGS

You can control the SP5's Auto Dimmer feature, adjust the brightness and contrast of the SP5's color LCD display screen, and can select from 15 different color options for the screen and the SP5's buttons:

Select the DISPLAY SETTINGS menu option. The Display Settings screen will appear (see *Figure 62*). Select one of the following options:



Figure 62

BRIGHTNESS: You can manually set the brightness for the LCD backlight and the front-panel buttons, and you can control the action of the SP5's auto dimmer feature. When you select the Brightness option, the Brightness screen will appear (see *Figure 63*, left).



Figure 63

MANUAL: The Manual Brightness screen will appear (see *Figure 63*, right). Use the Knob to manually adjust the display's brightness. The bar graph on the display screen will move to indicate the change. When you're finished, press the MENU button to exit.

- Setting the brightness to the lowest setting enables a *Dark Mode* that extinguishes all illumination except for 5 seconds after any button is pressed. This is useful when using the Sleep Mode (see page 98).

Note: You can increase and reduce the screen brightness without entering the Menu system by pressing and holding the Category < and > buttons (see pages 45 – 46).

AUTOMATIC: This lets you control the SP5's auto dimmer feature. The auto dimmer will automatically dim the SP5's display in low-light conditions, and will automatically brighten the display when the ambient light is bright.

1. When the AUTO BRIGHTNESS screen appears (see *Figure 64*), use the Knob to highlight either the "L" or "H" indicator.



Figure 64

- The "L" indicator controls how much the SP5's display will automatically dim in low-light conditions. The "H" indicator controls how much the SP5's display will automatically brighten in high ambient light conditions.
2. Use the Category <> buttons to adjust the value of the highlighted indicator.
3. Use the Knob to highlight the other indicator and use the Category <> buttons to set its value.
4. Press the Select button to save the settings and return to the BRIGHTNESS screen.
 - Pressing the MENU button will cancel your settings and return to the BRIGHTNESS screen.

Contrast: This setting adjusts the relationship between the background and the text on the LCD display screen. The bar graph on the display screen will move to indicate the change (see *Figure 65*). When you're finished, press the MENU button to exit



Figure 65

Color Options: You can select from 15 different color combinations for the SP5's LCD screen background and text, and the front-panel button backlight color. Selecting COLOR OPTIONS activates the COLOR OPTIONS screen. Turning the Knob (on the remote, pressing the Channel UP/DOWN buttons) will cycle the SP5 through the following color combinations:

SCREEN BACKGROUND	SCREEN TEXT	BUTTON BACKLIGHT
Blue	White	Blue
Blue	Amber	Blue
Green	White	Green
Pink	White	Pink
Red	White	Red
Amber	White	Amber
Aqua	White	Aqua
White	Blue	Blue
Dark Gray	Blue	Blue
Dark Gray	Red	Red
Dark Gray	White	White
Dark Gray	Green	Green
Dark Gray	Amber	Amber
Dark Gray	Pink	Pink
Dark Gray	Aqua	Aqua

Note: The screen background, screen text and button backlight colors will change in real-time as you turn the Knob or press the Channel UP/DOWN buttons.

S-SEEK ALERT SETTINGS

This menu lets you turn S-Seek ON or OFF, turn the audible alert tone ON or OFF, turn the on-screen alerts ON or OFF and browse all of the S-Seek memory entries. In addition, you can clear all 50 S-Seek entries.

1. Select the S-SEEK ALERT SETTINGS menu option (see *Figure 66*).

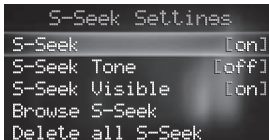

Figure 66

2. The following S-Seek options are available:

S-SEEK: Turns the S-Seek function ON or OFF.

S-SEEK TONE: Turns the audible S-Seek alert ON or OFF.

S-SEEK VISIBLE: Turns the on-screen S-Seek alerts ON or OFF (see *Figures 51 & 52* on pages 68 & 69).

BROWSE S-SEEK: Lets you look-through all of your S-Seek memory entries.

DELETE ALL S-SEEK: This clears all S-Seek memory entries. When selected, a CLEAR ALL MEMORY confirmation screen will be displayed. Select YES to clear all S-Seek entries or No to cancel.

AUDIO LEVEL

You can adjust the audio output level of your Sportster SP5 to match the levels of the other source components in your audio system, or to fine-tune the audio level for best performance. This is important when using both the included Vehicle Dock or the optional Home Docking Station. The audio level setting affects both the Audio Output and the FM transmitter output audio levels.

1. Select the **AUDIO LEVEL** menu option. The **AUDIO LEVEL** screen will appear (see *Figure 67*).



Figure 67

2. The **POWER-UP TONE** sounds when the SP5 powers ON or OFF. Use the Select button to cycle between ON and OFF.
3. Highlighting and selecting **AUDIO LEVEL** displays the **AUDIO LEVEL** screen, which has a "-" sign to the left and a "+" sign to the right (see *Figure 68*). Use the Knob (on the remote, use the Channel UP/DOWN buttons) to adjust to the desired audio output level.

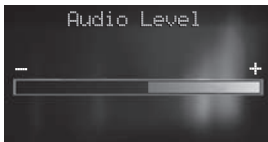

Figure 68

CHANNEL PREVIEW

Activating Channel Preview lets you browse what's on other channels when the Default Screen is active. Normally, when the Default Screen is active, rotating the Knob or pressing a Channel UP or DOWN button on the remote automatically tunes the Sportster SP5 to the next higher or lower channel. When Channel Preview is active, rotating the Knob or using the Channel UP/DOWN buttons will change the display to show what's on the next higher or lower channel while the SP5 remains tuned to the channel you're listening to.

- If you want to listen to the new channel, press the Select button. If you don't press the Select button, after 5 seconds the SP5's display reverts back to the Default Display.

To activate Channel Preview:

1. In the SETTINGS screen (see page 77), highlight the CHANNEL PREVIEW option (see *Figure 69*).

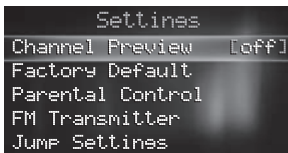

Figure 69

2. Use the Select button to cycle between ON and OFF. (Default is OFF.)

FACTORY DEFAULT

The FACTORY DEFAULT option will restore all the original factory settings in your SIRIUS Sportster SP5. Note that factory default will *not* reset the lock code if you have changed it from the default lock code (see page 88). To perform a factory default reset:

1. Select the Factory Default menu option. The FACTORY DEFAULT screen will appear (see *Figure 70*, left).



Figure 70

2. Use the Select button to choose YES or No. Choosing No will cancel the operation and return to the MENU OPTIONS screen. If you choose YES you will be asked to confirm your choice (see *Figure 70*, right). Choosing YES again reverts the following SP5 parameters to their original factory settings:

- All presets revert to empty
- Reset to Normal Tuning Mode
- Reset to Default screen
- Reset previous power state setting to: Off
- FM Frequency Setting: 88.1MHz
- FM Transmitter: On
- Sports Alert: Clear all favorite teams
- Jump Settings: Clear jump setting
- Display Brightness: 80%
- Display Contrast: 50%
- Auto Memory Search: On
- Clear all S-Seek stored entries
- Audio Level: -3dB
- Power-Up and S-Seek Tones: On
- Clock Format: 12 Hour
- Clock Time Zone: Eastern Time Zone
- Clock Daylight Savings Time: Observed
- Alarm: Off
- Alarm Time: Cleared (12:00pm)
- Program Alert: Off
- Program Alert Time: Cleared (12:00pm)
- Program Alert Day: Cleared (Monday)
- Program Alert Channel: Cleared (184)
- Auto Shutdown: Disabled
- Sleep Mode: Off

PARENTAL CONTROL

Your SIRIUS Sportster SP5 has the ability to lock channels you do not want others (such as children) to access without your permission. Locked channels will not appear when browsing channels with the Knob or Channel Select buttons. When the anyone tries to access a locked channel using the Direct Tuning function (see page 58), an ENTER CODE screen will be displayed and the channel won't be accessed until the correct code is entered.

Locking or Unlocking a Channel

To lock or unlock a channel:

1. Select the PARENTAL CONTROL menu option. The PARENTAL CONTROL screen will appear (see *Figure 71*, left).

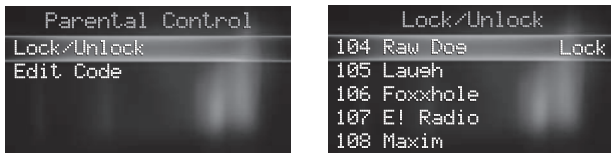

Figure 71

2. Select the LOCK/UNLOCK menu option. You will need to enter the lock code to proceed. Refer to *Changing the Lock/Unlock Code*, on page 88 for information on how to set the lock code.
3. Once you enter the lock code the LOCK/UNLOCK screen will appear (see *Figure 71*, right). Highlight the channel you wish to lock or unlock from the channel list. Pressing the Select button will either add the word *Lock* next to the channel name to indicate that the channel will be locked, or unlock a locked channel by removing the word *Lock*.

Changing the Lock/Unlock Code

The first time you access the LOCK/UNLOCK menu, you must enter the default lock code. The default lock code is **0 0 0 0**. You can keep this code or change it. To change the lock code:

1. Select the PARENTAL CONTROL menu option. The PARENTAL CONTROL screen will appear (see *Figure 71*, on page 87)
2. Select the EDIT CODE menu option. The ENTER CODE screen will appear (see *Figure 72*).



Figure 72

3. Enter the default lock code (**0 0 0 0**) or the current lock code if you have changed it from the default code.
4. The NEW CODE prompt will be displayed. Enter your new four digit code using the 0 – 9 number buttons. You will then be prompted to enter the new code again to confirm.
5. When the new lock code is confirmed, the lock code is changed.

Note: You can use this same procedure to change the lock code again after you have changed it from the default code.

Sports Alerts

The Sports Alerts screen lets you store your favorite sports teams and NASCAR car numbers in memory. (You may select multiple teams/cars within each sport or league.) Your SIRIUS Sportster SP5 will constantly scan the channels and will alert you when a team or car you stored in memory is playing a game or running a race, or when there is a score update for a team, depending upon which options you have chosen for each team or car number. Sports teams which you have selected and which are currently playing will be displayed in a category called *My Sports Zone*.

Select SPORTS ALERTS from the Menu Options. The SPORTS ALERTS screen will appear (see *Figure 73*).



Figure 73

The following options are available:

- **SELECTIONS:** Lets you store teams/car numbers in memory and select the types of alerts (Pop-Up Alert and/or Sports Ticker) you want to appear when they are playing. (See Selections, on page 90 for details.) The bracketed number indicates the total number of teams and car numbers you have selected.
- **ALERT:** Use the Select button to turn the pop-up alert ON or OFF for all selected teams or car numbers. See page 69 for Alert details.
- **TICKER:** Use the Select button to turn the Sports Ticker ON or OFF for all selected teams or car numbers. See page 93 for details about the Sports Ticker.

SPORTS SELECTIONS

Choose SELECTIONS from the SPORTS ALERTS screen (see *Figure 75*, on page 90). The SPORTS SELECTIONS screen will appear (see *Figure 74*). Highlight and select the category of the team/car number you wish to add (NASCAR, NFL, NBA, NHL, College Football, College Basketball). The bracketed numbers indicate the number of teams/car numbers you have already selected for each category.



Sports Selections	
NASCAR	[2]
NFL	[12]
NBA	[9]
NHL	[0]
Collesse Football	[14]

Figure 74

NASCAR

The NASCAR screen will appear when you select NASCAR (see *Figure 75*, left).



Figure 75

1. Highlight SELECT CARS, then press the Select button. The SELECT CARS screen will appear (see *Figure 75*, center).
2. To select a driver's car number, highlight and select ADD NEW CAR?. Enter the driver's car number on the ADD NEW CAR screen that appears (see *Figure 75*, right). After you enter the number, press the Select button. Repeat this for each driver you want to follow. (You can select a maximum of 5 cars.)

Selecting the **ALL CARS** option notifies you when any NASCAR driver is racing. You can choose to be notified either by the pop-up NASCAR Alert, by the NASCAR ticker, or by both (see *Figure 76*, below):

- Pressing the Select button will select **TICKER** (a check-mark will appear in the adjacent box). Pressing the Select button again will select **ALERT**.
- Pressing the Select button a third time will deselect **TICKER** (the check-mark will disappear); pressing the Select button a fourth time will deselect **ALERT**.



Figure 76

When you're done selecting drivers/car numbers, press the Menu button. The NASCAR screen will return (see *Figure 75*, left, on page 90). Select the types of NASCAR alerts you want:

RACE ALERT: Displays a pop-up alert when any race featuring your selected cars is running (see *Figure 76*, left). The alert will show the driver's name/car number and the channel carrying the race. Use the Select button to choose **ON** or **OFF**.

TICKER: Displays information for races featuring your selected car numbers continually while races are running (see *Figure 76*, right). The currently-playing artist and song title will still be visible when the ticker is active. Use the Select button to choose **ON** or **OFF**.

NFL, NBA, NHL, COLLEGE FOOTBALL, COLLEGE BASKETBALL

When you select one of the above leagues on the SPORTS SELECTIONS screen (see *Sports Selections*, on page 90), that league's screen will appear (see *Figure 77*, left). Note that although the NFL is shown here, the screens for all the leagues contain the same options.



Figure 77

To Select Teams:

1. Highlight and select **SELECT TEAMS**. The **SELECT NFL TEAMS** screen will appear (see *Figure 77*, right).
2. Select the teams you want to follow (you can select as many teams as you wish). Note that for college teams, you will be alerted for all teams playing for that college. There are 30 college teams currently licensed for broadcast by SIRIUS.
3. For each team you select you can choose to be notified either by a pop-up Sports Alert (see *Figure 52*, on page 69), by the league's ticker (see *Figure 78*, on page 93), or by both:
 - a) Use the Knob to highlight the team you want to follow. Selecting the **ALL TEAMS** option notifies you when any teams in the league are playing.
 - b) While the team is highlighted, pressing the Select button will select **TICKER** (a check-mark will appear in the adjacent box). Pressing the Select button again will select **ALERT**.
 - c) Pressing the Select button a third time will deselect **TICKER** (the check-mark will disappear); pressing the Select button a fourth time will deselect **ALERT**.
4. Repeat Step 3 for each team you want to follow.

League Settings:

The NFL screen (*Figure 77*, on page 92) lets you turn Alerts and/or the Ticker ON and OFF for all of your selected teams in the league without having to do so for each team individually:

GAME ALERT: A pop-up alert will be displayed when any of your selected teams is playing, and when the team(s) begin playing a game. Use the Select button to choose ON or OFF.

ALL SCORES ALERT: Provides the same alerts as the GAME ALERT, and also alerts you when the scores for the team(s) are updated. Use the Select button to choose ON or OFF.

TICKER: Displays the information (including the channel that is carrying the game) for the teams you have selected continually during a game they are playing (see *Figure 78*). The currently-playing artist and song title will still be visible when the ticker is active. Use the Select button to choose ON or OFF.

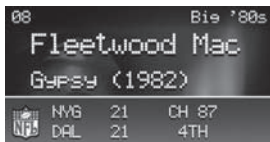

Figure 78

Time-Based Features

Time-Based Features menu lets you access the **CLOCK**, **ALARM**, **PROGRAM ALERT**, **AUTO SHUTDOWN**, and **SLEEP MODE** functions.

Press the **MENU** button and select **TIME BASED FEATURES**. The **TIME BASED FEATURES** screen will appear (see *Figure 79*).



Figure 79

CLOCK

The **CLOCK** screen (see *Figure 80*) allows you to setup the clock that appears on the Default Screen, based on the format desired and the time zone in which you reside. The actual time is provided via the SIRIUS satellite signal, and will automatically update your SP5.

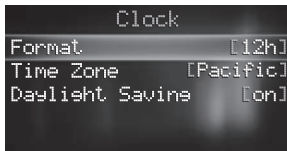

Figure 80

Format: Displays the time in either a 12-hour (default) or 24-hour (military) format.

TIME ZONE: Since the clock adjusts the time automatically, it is important to specify your time zone. Select from the list of the available time zones:

(GMT-9:00) Alaska Time Zone

(GMT-8:00) Pacific Time Zone

(GMT-7:00) Mountain Time Zone

(GMT-6:00) Central Time Zone

(GMT-5:00) Eastern Time Zone

(GMT-4:00) Atlantic Time Zone

(GMT-3:30) Newfoundland Time Zone

DAYLIGHT SAVINGS TIME: Select **ON** if your area observes Daylight Savings Time; select **OFF** if your area does not.

ALARM

The **ALARM** screen (see *Figure 81*) lets you to set your Sportster SP5 to turn **ON** at a specific time. The last selected channel prior to shutdown will play when the SP5 powers-on.



Figure 81

ALARM TIME: This lets you set the alarm time. Use the Category < and > buttons and the Knob to select the time when you want the SP5 to power on. (The default time is 12:00 PM). When the desired time is displayed, press the **SELECT** button.

ALARM TYPE: This lets you set the alarm to activate at the same time every day, the same time each weekday or only on the days you select.

ALARM: Select **ON** to activate the alarm; select **OFF** to de-activate the alarm.

Snooze function: When the alarm turns the SP5 ON, pressing any button will mute the audio and turn the backlight off for 8 minutes, after which time the audio and backlight will turn ON again. Pressing the SELECT button will cancel the alarm function until the next day but leave the SP5's audio ON; pressing the POWER button will turn the SP5 OFF.

PROGRAM ALERT

The PROGRAM ALERT screen (see *Figure 82*) allows you to program the SP5 to switch to a selected channel at a specific time. The SP5 must be powered ON for this feature to function. After highlighting an item, use the Select button to make your choices.



Figure 82

PROGRAM DAY: You can set the Program Alert to activate every day, weekdays only, weekends only, or on a specific day.

PROGRAM TIME: Use the Category < and > buttons and the Knob to set the time the SP5 will switch to the selected channel. AM or PM will change automatically when the AM or PM threshold has been exceeded. When the desired time is displayed, press the Select button.

PROGRAM CHANNEL: Select the channel you want the SP5 to play.

PROGRAM ALERT ON/OFF (Default is Off): Select ON to enable Program Alert; select OFF to disable Program Alert.

AUTO SHUTDOWN

The **AUTO SHUTDOWN** screen (see *Figure 83*) lets you program the SP5 to automatically shut OFF after a one-hour period of inactivity (no button presses or other user intervention).



Figure 83

After 59 minutes of inactivity, a beep tone will sound and a **CANCEL AUTO SHUTDOWN** display prompt appears on the screen to allow you to delay the automatic shutdown. Pressing the **Select** button will reset the *Auto Shutdown* for another 1-hour period.

SLEEP MODE

The **SLEEP MODE** screen (see *Figure 84*) lets you program the SP5 to shut OFF after a selected period of time.

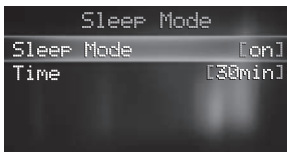

Figure 84

SLEEP MODE ON/OFF: Activates and de-activates the Sleep Mode function.
TIME: Select the desired amount of time (15/30/45/60 minutes) before the SP5 shuts OFF.

Signal Indicator

When using the optional Home Docking Station or Boombox indoors, it is important to aim the antenna for maximum signal reception. The SIGNAL INDICATOR screen (see *Figure 85*) visually shows the strength of the satellite and terrestrial signals being received by the SP5. (Refer to the Home Docking Station installation guide for more information about properly orienting the antenna.)

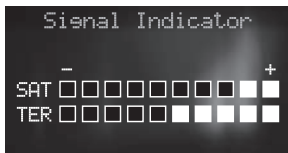

Figure 85

The SAT bar graph indicates the strength of the satellite signal strength; the TER bar graph indicates the strength of the terrestrial signal strength (if available).

Troubleshooting

Symptom	Solution
SIRIUS Sportster does not power on	Blown fuse, or the power cable is not properly connected. Check for a bad fuse and check power cable connection
SIRIUS Sportster displays: <i>Antenna Not Detected</i>	The satellite antenna is not connected to the radio dock. Check the satellite antenna connection to the dock.
SIRIUS Sportster displays: <i>Acquiring Signal</i>	No satellite signal is being received. Check for obstacles over or around the satellite antenna. Change the vehicle location to eliminate nearby obstacles (bridges, overpasses, trees, buildings, etc.).
Audio static or loss of clarity	The FM frequency contains static. Locate a quiet FM frequency on your vehicle radio and set the FM transmitter frequency of the SIRIUS Sportster to match. If using the AUX audio connector, check the cable connections.
No sound	The audio cables are not connected, or the FM radio is set to the wrong frequency. Check the audio cables at the radio and the radio. Tune the FM radio to the same FM frequency the SIRIUS radio is tuned.

Specifications

Satellite Frequencies.....	2322.293/2330.207 MHz
Terrestrial Frequencies	2326.250MHz
Power Requirements	5.2 Volts, Negative Ground, DC
Audio Output.....	2.8V (normal); 3.0V (max.) (Peak-to-Peak)
Total Harmonic Distortion (THD).....	<0.3%
Signal-to-noise (S/N).....	Greater than 75dB
Operation Temperature.....	-20° to +85° C (-4° to +185° F)
Radio Dimensions (Length x Height x Depth).....	114.2mm x 62.5mm x 16.9mm (4.5" x 2.5" x 0.6")
Radio Weight	121g (4.2 oz.)
Remote Control Dimensions (Width x Height x Depth).....	41mm x 105mm x 18mm (1.6" x 4.1" x 0.7")
Remote Control Battery Requirements.....	CR2025
Cigarette Lighter Adapter Fuse Requirement.....	.2A Slow Blow
Cigarette Lighter Adapter Cable Length	1.8m (6ft.)
Cigarette Lighter Adapter Operating Temperature.....	-20° to +85° C (-4° to +185° F)
Antenna Type.....	Low Profile Magnetic
Antenna Cable Length	21' (single micro-cable)
Antenna Connector Type.....	SMB (right-angle)
Audio Out Interface	1/8" / 3.5mm Stereo Jack

Warranty

12 Month Warranty

SIRIUS Canada Inc. (the "Company") warrants to the original retail purchaser of this product that should this product or any part thereof, under normal use and conditions, be proven defective in material or workmanship within 12 months from the date of original purchase, such defect(s) will be replaced with new or reconditioned product (at the Company's option) without charge for parts and labor. To obtain repair or replacement within the terms of this Warranty, the product is to be delivered with proof of warranty coverage (e.g. dated bill of sale), specification of defect(s), transportation prepaid, to the location shown below under WARRANTY RETURN.

This Warranty does not extend to the elimination of externally generated static or noise, to correction of antenna problems, to costs incurred for installation, removal or reinstallation of the product, or to damage to tapes, compact discs, speakers, accessories, or vehicle electrical systems.

This Warranty does not apply to any product or part thereof which, in the opinion of the Company, has suffered or been damaged through alteration, improper installation, mishandling, misuse, neglect, accident, or by removal or defacement of the factory serial number/bar code label(s). THE EXTENT OF THE COMPANY'S LIABILITY UNDER THIS WARRANTY IS LIMITED TO THE REPAIR OR REPLACEMENT PROVIDED ABOVE AND, IN NO EVENT, SHALL THE COMPANY'S LIABILITY EXCEED THE PURCHASE PRICE PAID BY PURCHASER FOR THE PRODUCT.

This Warranty is in lieu of all other express warranties or liabilities. ANY IMPLIED WARRANTIES, INCLUDING ANY IMPLIED WARRANTY OF MERCHANTABILITY, SHALL BE LIMITED TO THE DURATION OF THIS WRITTEN WARRANTY. ANY ACTION FOR BREACH OF ANY WARRANTY HEREUNDER INCLUDING ANY IMPLIED WARRANTY OF MERCHANTABILITY MUST BE BROUGHT WITHIN A PERIOD OF 48 MONTHS FROM DATE OF ORIGINAL PURCHASE. IN NO CASE SHALL THE COMPANY BE LIABLE FOR ANY CONSEQUENTIAL OR INCIDENTAL DAMAGES FOR BREACH OF THIS OR ANY OTHER WARRANTY, EXPRESS OR IMPLIED, WHATSOEVER. No person or representative is authorized to assume for the Company any liability other than expressed herein in connection with the sale of this product. Some states do not allow limitations on how long an implied warranty lasts or the exclusion or limitation of incidental or consequential damage so the above limitations or exclusions may not apply to you. This Warranty gives you specific legal rights and you may also have other rights which vary from state to state.

WARRANTY RETURN: To obtain a replacement within the terms of this Warranty, please return product to an authorized Sirius Canada retailer or call Erikson Consumer Customer Service at (800) 567-3275 for an authorized Sirius retailer near you; proof of purchase and description of defect are required. Products to be returned to an approved warranty station must be shipped freight prepaid.

SIRIUS ID

Write down the SIRIUS ID (SID) of your SIRIUS Sportster 5 in the space provided below.

SID: _____



SIRIUS Customer Service: 1-888-539-7474
customer care@siriuscanada.ca

SIRIUS Canada Inc.
135 Liberty Street, 4th Floor
Toronto, Ontario M6K 1A7
1-888-539-7474
<http://www.siriuscanada.ca>



<http://siriuscanada.ca>

SIRIUS Canada Inc.
135 Liberty Street, 4th Floor
Toronto, Ontario M6K 1A7

1-888-539-7474