

# Installing the FM Coupler in your vehicle

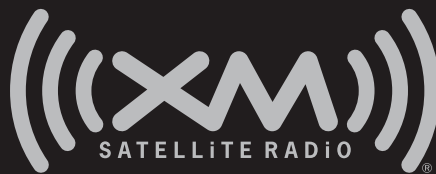

## FCC Information

Please note that the power cable supplied with your device includes permanently attached ferrite beads at each end. It is the responsibility of the user to use the cable with the ferrite beads.

The user is cautioned that changes or modifications not expressly approved by XM Satellite Radio, Inc. can void the user's authority to operate this device.

This device complies with Part 15 of the FCC Rules. Operation is subject to the following two conditions: (1) This device may not cause harmful interference, and (2) this device must accept any interference received, including interference that may cause undesired operation.

This equipment has been tested and found to comply with the limits for a Class B digital device, pursuant to Part 15 of the FCC Rules. These limits are designed to provide reasonable protection against harmful interference in a residential installation.

This equipment generates, uses and can radiate radio frequency energy and, if not installed and used in accordance with the instructions, may cause harmful interference to radio communications. However, there is no guarantee that interference will not occur in a particular installation. If this equipment does cause harmful interference to radio or television reception, which can be determined by turning the equipment off and on, the user is encouraged to try to correct the interference by one or more of the following measures:

- Reorient or relocate the receiving antenna.
- Increase the separation between the equipment and receiver.
- Connect the equipment into an outlet on a circuit different from that to which the receiver is connected.
- Consult the dealer or an experienced radio/TV technician for help.

## Table of Contents

Installing the FM Coupler Overview	4
Installation Locations	5
Installation Setup	6
Option 1 External FM Antenna Coupling Clip Installation	8
External FM Antenna Routing	9
Option 2 Internal On Glass Antenna Coupling Clip Installation	11
Internal On Glass Antenna Routing	14
Additional Information	15

## Installing the FM Coupler Overview

To install the FM Coupler, first find a suitable location that works in your vehicle. You need to determine the location of your vehicle's FM Antenna and properly route the FM Coupler cables to your FM antenna.

Your vehicle's FM antenna will be located in one of seven common locations:

1. front fender
2. rear fender
3. roof top front
4. roof top rear
5. adhered to top of windshield
6. adhered to top of rear window
7. adhered to rear side glass (in some SUVs)

For best audio performance, install the FM Coupler by either clipping it directly to an external antenna (locations 1 through 4) or against an interior on-glass antenna using the additional window Contact Bracket (locations 5 through 7). The remainder of this document provides step by step fm coupler installation instructions.

## Installation Locations

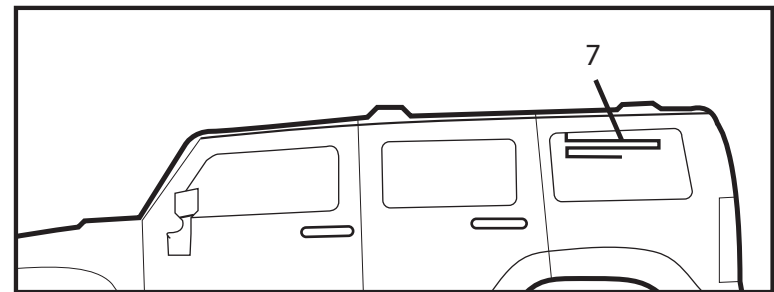
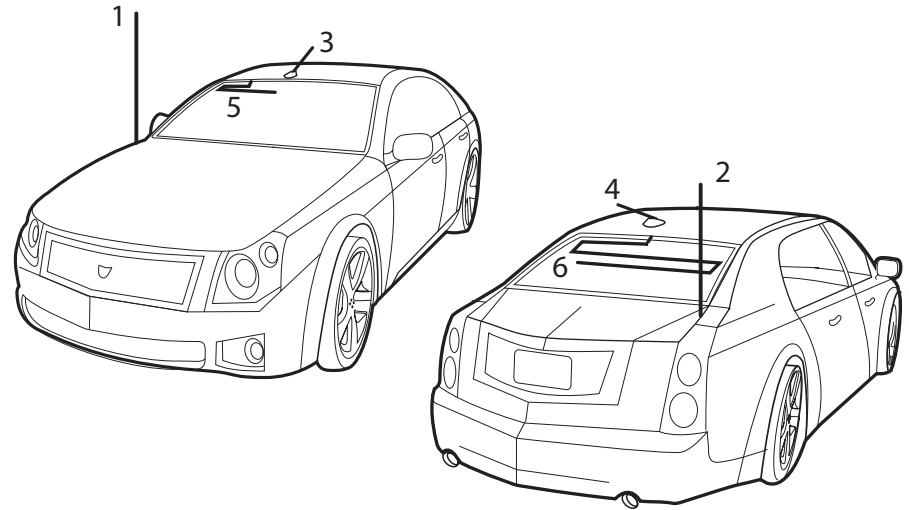

## Installation Setup

### The following steps will guide you through the installation of your FM Coupler

1. Install your XM Radio in your vehicle as described in your XM Radio User Manual but do not connect the XM antenna plug to the dock at this time.
2. Connect the FM Coupler input cable to the XM radio or vehicle dock antenna input.
3. Connect the XM Antenna to the FM Coupler antenna input, located on the coupler module about 2 feet from the end of the input cable. Tuck any excess input cable and the coupler module behind dash or in another hidden location for a professional looking installation.
4. Locate your vehicles FM antenna and determine the best routing method to get the FM Coupler output cable to the FM antenna. (For external antennas (figure a), the Coupling Clip needs to be routed outside the vehicle. For internal on glass antennas (figure b), all routing is inside the passenger compartment and the Contact Bracket is used.
5. To route the output cable with Coupling Clip to your vehicle FM antenna, follow the instructions on the next pages . There are separate instructions for external antenna vs the internal on glass antenna. Follow the instructions that apply to your vehicle's antenna type. (This guide assumes you have already installed your XM antenna per the instructions in your XM radio user guide. The positions of the XM antenna in the illustrations below is for example only. There is no need to change your XM antenna installation.)

6

## Installation Setup

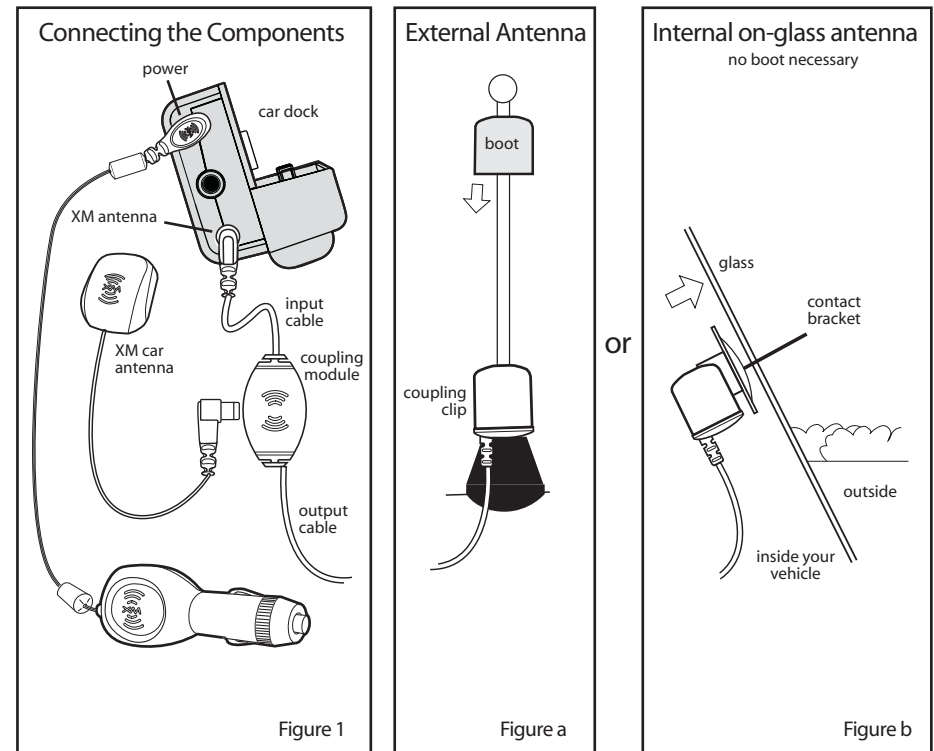

7

## Option 1: External Antenna Coupling Clip Installation

### Step 1:

If you have an external or roof mount FM antenna, attach the Coupling Clip directly to the base of the antenna as illustrated below. Cover the Clip with the rubber boot provided to protect and secure the clip. Secure the cable inside the trunk or hood to avoid interference or accidental damage. Installing the Coupling Clip first will avoid having excess cable outside the vehicle.

- Snap the antenna clip into place
- Slide the boot over the top of your antenna.
- Slide the boot down the antenna so it covers the clip

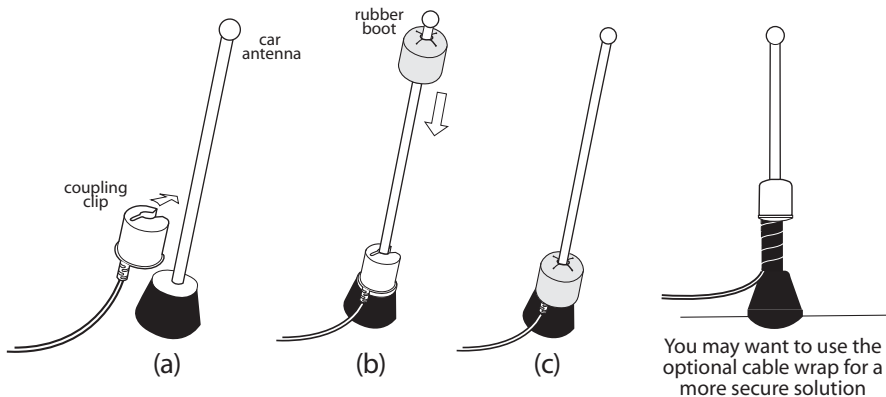

8

## External Antenna Routing

### Step 2:

In the front, route the cable across the weather seal near the bottom of the door to reduce water leaks. Once inside the car tuck the FM coupler output cable into the door jam up to the dash or under the carpet as shown in figure 2.

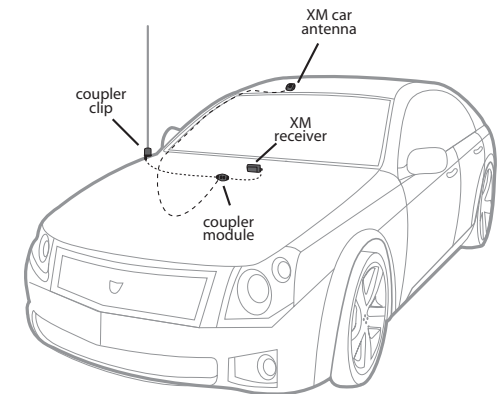

Figure 2

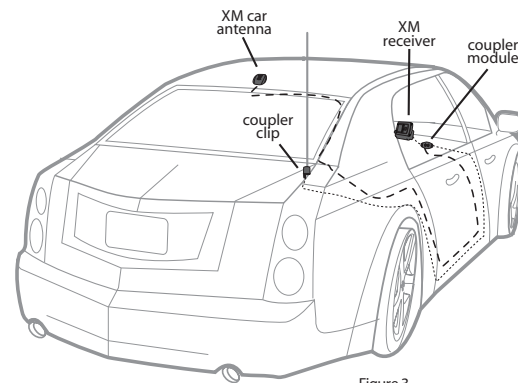

Figure 3

In the rear, Always cross the weather seal at the lowest part of the trunk to reduce water leaks. Route the cable into the trunk through available wire channels. Route through the rear passenger compartment. Tuck the cable under the door jam trim or under the carpet to the XM Receiver as shown in figure 3.

9

## Option 2: Internal On Glass Antenna Coupling Clip Installation

### Identifying the On Glass FM Antenna

#### Useful Information for Step 1:

**CAUTION:** Do not attach the contact bracket to the rear defogger elements. In some vehicles they look similar to the FM Antenna.

You can distinguish the FM Antenna Elements from the Defogger Elements by several key features.

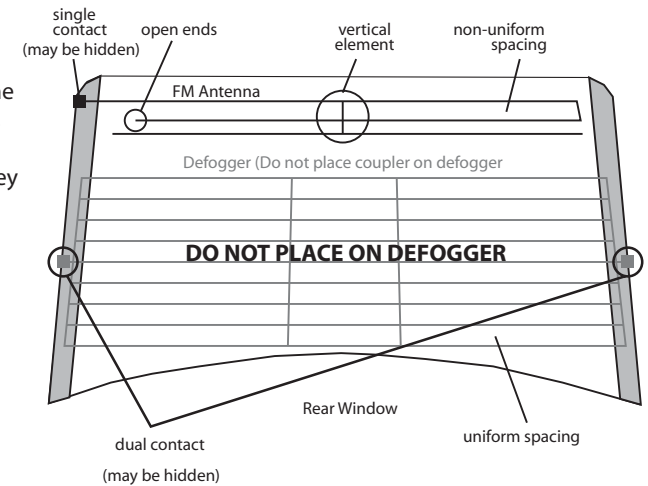

1. The FM antenna is typically found on the top 6 to 8 inches of the rear window and the Defogger is below.
2. The FM antenna has open ends (connected to nothing) and the Defogger does not.

## Internal On Glass Antenna Coupling Clip Installation

3. The FM antenna will have a single contact point and the Defogger will have two, which are typically on opposite sides of the window. (The contact points may be hidden behind interior liners or exterior glass tinting but the key is to locate where the elements go off the window edge. The FM antenna will have only one location where the defogger can have two or more.)

### Step 1:

Install the Contact Bracket on the interior window surface over the antenna element using the adhesive pad provided and the following steps. It may be mounted either vertical or horizontal depending on the portion of the antenna element most easily accessed. Select a bracket position that allows room to attach the Coupling Clip and cleanly run cables. Install the on glass antenna coupling clip before routing the cable to avoid excess cable outside your vehicle

- a. Clean the mounting location on the glass for the Contact Bracket with the included surface preparation kit.
- b. Remove the red liner from the adhesive pad and press the Contact Bracket firmly at the identified mounting location on the glass. You can also view the alignment through the glass from outside the vehicle.
- c. The Contact Bracket has alignment arrows on the side opposite the adhesive pads. These arrows indicate the contact strip location on the base of the bracket. Align the arrows with the on glass antenna element to ensure you make direct contact between the strip and the antenna element. Press and hold the Contact Bracket in place for 10 to 15 seconds.
- d. Once the Bracket is in place, attach the Coupling Clip to the flange on the Bracket and route any excess cable behind liners for a professional look.

## Internal On Glass Antenna Coupling Clip Installation

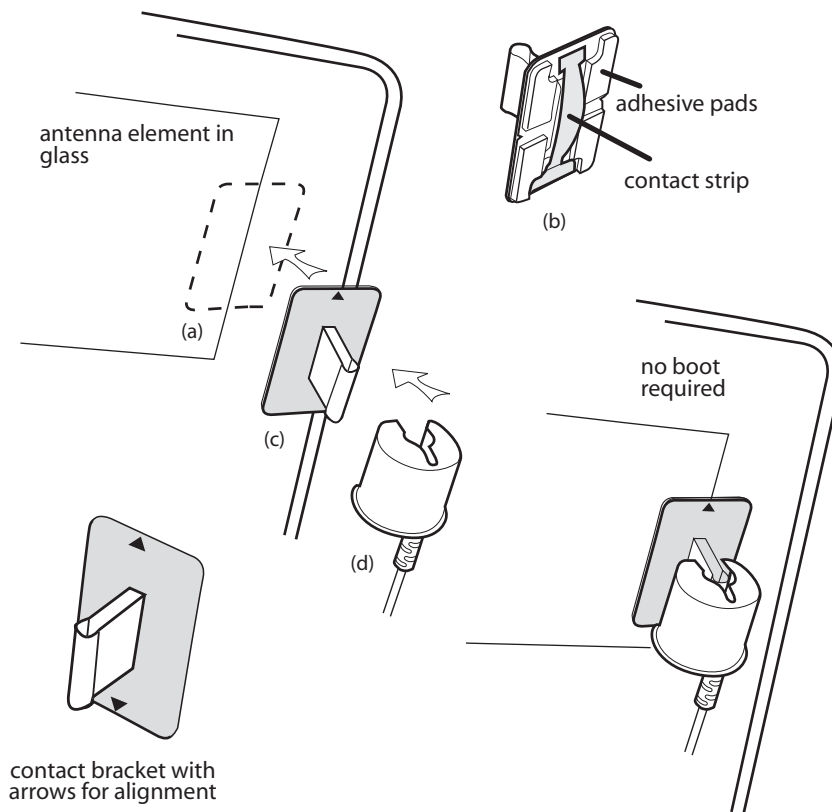

## Internal On Glass Antenna Routing

### Step 2:

In the front, route the FM coupler output cable from the antenna element, along the window edge, down to the window liner along to the floor up to the dash as shown in figure 4.

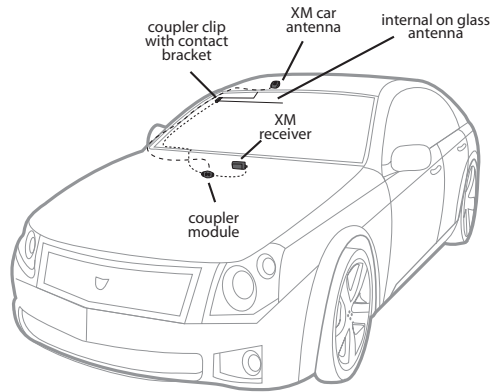

Figure 4

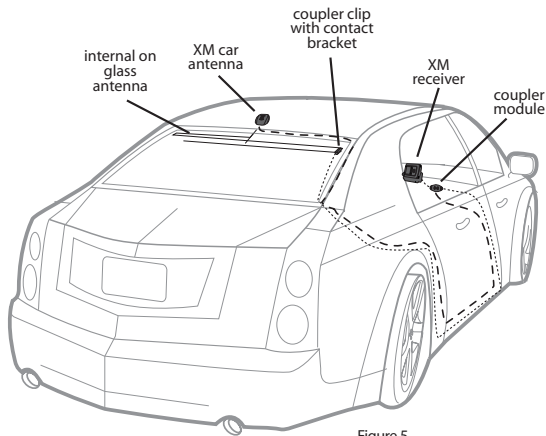

Figure 5

In the rear, route the FM coupler output cable from the antenna element, along the window edge, down to the window liner. From the rear passenger compartment tuck the cable under the carpet or door jam trim up to the front dash to the XM Receiver. See figure 5.

## Additional Information

**Note:** When routing the FM Coupler cable use pre-existing wire channels whenever possible to avoid loose wires on the interior of the vehicle which are susceptible to damage and to maintain a professional looking installation. Route cable carefully by taking notice of how doors open and close, as well as how seats move when they are adjusted so you can be certain there is ample clearance provided for the cable.

Avoid inadvertent damage that may be caused by kinking, crimping, twisting or chafing the cables. Secure and tie wrap the excess cable under your dash board, between the seat and the console, or on the floor under a seat or floor mat. Securing the excess cable will help to prevent it from interfering with the everyday use of your vehicle, improve the appearance of the installation, and avoid any undesirable accidental damage to the cables that might result in loss of satellite signal or FM Coupler performance.



