

sportscaster™

YOUR SEASON TICKET TO XM SATELLITE RADIO

XM Satellite Radio Receiver



Instruction Manual

Model R101



Advanced Global Technology, LLC.



Important: This manual contains important safety and operating information. Please read, understand, and follow the instructions in this manual. Failure to do so could result in personal injury, death, and/or damage to your Sportscaster, accessories, and/or to your vehicle or property.

Please note that the power cable that has been supplied with your device is supplied with permanently attached ferrite beads. It is the responsibility of the user to use the supplied cable with the ferrite beads.

The user is cautioned that changes or modifications not expressly approved by XM Satellite Radio, Inc. can void the user's authority to operate this device.

This device complies with Part 15 of the FCC Rules. Operation is subject to the following two conditions: (1) This device may not cause harmful interference, and (2) this device must accept any interference received, including interference that may cause undesired operation.

This equipment has been tested and found to comply with the limits for a Class B digital device, pursuant to Part 15 of the FCC Rules. These limits are designed to provide reasonable protection against harmful interference in a residential installation.

This equipment generates, uses and can radiate radio frequency energy and, if not installed and used in accordance with the instructions, may cause harmful interference to radio communications. However, there is no guarantee that interference will not occur in a particular installation. If this equipment does cause harmful interference to radio or television reception, which can be determined by turning the equipment off and on, the user is encouraged to try to correct the interference by one or more of the following measures:

- Reorient or relocate the receiving antenna.
- Increase the separation between the equipment and receiver.
- Connect the equipment into an outlet on a circuit different from that to which the receiver is connected.
- Consult the dealer or an experienced radio/TV technician for help.

 Changes or modifications to the unit not expressly approved by AGT can void your authority to operate this equipment.

 **IMPORTANT:** The FCC and FAA have not certified the AGT XM Sportscaster Satellite Radio Receiver for use in any aircraft (neither portable nor permanent installation). Therefore, AGT cannot support this type of application or installation.

 This is the safety alert symbol. It is used to alert you to potential personal injury hazards. Obey all safety messages that follow this symbol to avoid possible injury or death.

Table of Contents

A Brief History	4	Personalizing Your Sportscaster	14
About Advanced Global Technology	4	FM Transmitter	14
About XM Satellite Radio	4	Frequencies	14
Let's Get Started	5	Audio Level	15
First, some important reminders	5	Tuning Options	16
Controls	6	Manual Tune	16
Display	6	Auto Tune	16
Remote Control	7	Display Options	17
Activating Your Sportscaster	8	Contrast	17
Installation	9-11	Brightness	18
Mounting to the Dashboard or Console	9	Cycle Display	18
Mounting to the Windshield	10	Scrolling	19
Mounting in the Home	10	BackLight Timeout	20
Using the Portable Battery Kit	11	Clock Features	21
Listening to XM	12	Alarm	21
Tuning Categories and Channels	12	Sleep	22
Categories	12	Auto Shutdown	23
Direct Tuning via Remote Control (only)	12	Format	24
Channels 0 and 1	12	Time Zone	25
FAV (Favorite Channels)	12	Daylight Savings	26
Storing Favorites	13	Defaults	27
Exceptions to Storing Favorites	13	Antenna Aiming	28
Customizing Your Favorites	13	Other Things You Should Know	29
Move Favorite to Top	13	Troubleshooting	29
Deleting Favorites	14	Warranty	30
Exiting Favorites Mode	14	Warranty Information	30
		Warranty Service Provided	30
		Warranty Service Not Provided	30
		What to Do for Warranty Service	31
		To Obtain Warranty Service	31

A Brief History

Thank you for purchasing the new AGT Sportscaster Satellite Radio Receiver-smaller, lighter, and more versatile than any receiver available.

- Mount your Sportscaster into cradles that are easily installed in your vehicle or your home. Connect your Sportscaster's power, and antenna connectors and you are ready to enjoy XM Satellite Radio.
- A built-in FM transmitter allows you to hear XM programming on your car FM radio, using an unused frequency on the FM band.
- Available accessory kits make your Sportscaster useable in the home or on the go.

About Advanced Global Technology

Advanced Global Technology (AGT) is a worldwide leader in mobile, home and portable electronics and audio technology. With its exciting line of satellite radio products, AGT offers a broad portfolio of products to answer a wide variety of information and entertainment needs-in the vehicle, home, office, and portable environments.

About XM Satellite Radio

XM Satellite Radio is the nation's leading provider of satellite radio with more than 6 million subscribers. XM offers more than 160 digital radio channels: 100% commercial-free music channels, ranging from hip hop to opera, rock to bluegrass, big band to reggae; 71 talk radio channels, including news, sports, comedy, and children's programming; and 21 channels of round-the-clock traffic and weather reports. Subscribers pay \$12.95 a month for the XM service, which was named Best Radio Service by the music industry's leading magazine Billboard at the 2004 Digital Entertainment Awards. Exclusive programming on XM includes Major League Baseball® games for every team, all season long. You can listen to XM on a variety of satellite radio receivers for the vehicle, home, and portable use. In-dash XM radios are available in more than 120 vehicle models for the 2006 model year. XM is broadcast via satellite from coast to coast, so you can listen to XM continuously as you travel across the country.

* To receive the XM service, you must subscribe to XM. Available in the continental United States and Canada only. Satellite radio reception depends on the ability of the antenna to receive a signal. The signal may not be available in buildings or if obstructed (e.g., by mountains, trees, bridges, etc).

Let's Get Started

First, some important reminders:

We know you're eager to turn on your new Sportscaster and listen to XM, but please take a moment to read through this instruction manual.

 **Warning:** This manual contains important safety and operating information. Please read, understand, and follow the instructions in this manual. Failure to do so could result in personal injury, death, and/or damage to your Sportscaster, accessories, and/or to your vehicle or property.

 **Warning:** When using this product it is always important to keep your eyes on the road and your hands on the wheel. Not doing so could result in injury and/or death to you or to others and/or in property damage.

 **Caution:** Use your Sportscaster only with the enclosed components or approved accessories. Do not modify wires or other connectors in any way; you could cause a malfunction, which could damage your Sportscaster and will void your warranty.

 **Caution:** Refrain from using food or drinks near your Sportscaster. Spilling food or drinks on the unit can damage it. Also, improperly installing the antenna cable can cause leaks, which can damage your Sportscaster and/or your vehicle.

 **Caution:** If you're not going to operate your vehicle for an extended period of time (e.g. parking garage while on vacation) unplug your Sportscaster receiver from the cigarette lighter adapter.

Controls

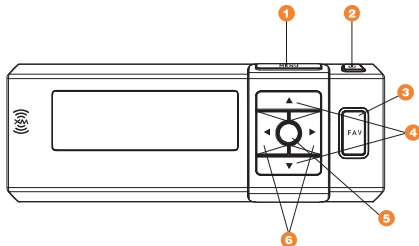

1. **Menu** - access advanced features and personalized settings
2. **Power** - turns the SportsCaster on or off
3. **Fav (Favorites)** - store up to 30 of your favorite channels
4. **Up and Down Arrows** - change channels, menu options
5. **Select** - enter, change display mode options
6. **Right and Left Arrows** - change categories, menu options

Display



1. **Signal Strength Indicator** - 1 to 3 bars
2. **Power Connection Indicator** - displayed when connected to external power
3. **Battery Indicator** - displays battery strength and charging status
4. **Alarm Indicator** - displayed when alarm clock feature is active
5. **Mute** - displayed when mute button is pressed from the remote control
6. **Auto Off Indicator** - displayed when auto shutdown feature is active
7. **Sleep Indicator** - displayed when sleep mode feature is active
8. **Fav (Favorites)** - displayed when favorite tuning mode is active
9. **Additional Info** - channel name, channel number, category name, artist, song title, time and other information.

Remote Control

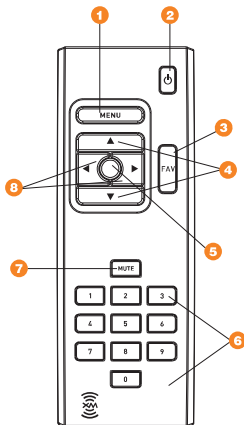

1. **Menu** - access advanced features and personalized settings
2. **Power** - turns the Sportscaster on or off
3. **Fav (Favorites)** - store up to 30 of your favorite channels
4. **Up and Down Arrows** - change channels, menu options
5. **Select** - enter, change display mode options
6. **Numbers** - enter a channel directly
7. **Mute** - turns audio off
8. **Right and Left Arrows** - change categories, menu options

Activating Your Sportscaster

Use the Up and Down Arrow buttons to tune Channel 0, then push the Select button. You should see an 8-character XM Radio ID in the display. (The XM Radio ID is also Printed on the package.)



Please write the XM Radio ID here:

--	--	--	--	--	--	--	--

Note: Carefully check your XM Radio ID. **The letters I, O, S, and F are not used.**

Activate your XM Satellite Radio service by contacting XM at <http://activate.xmradio.com> or by calling 1.800.XM.RADIO (1.800.967.2346). You will need your XM Radio ID and a major credit card.

XM will send a signal from the satellites to activate the full channel lineup. Activation normally takes 10 to 15 minutes, but during peak busy periods, you may need to keep your Sportscaster on for up to an hour to complete the activation process. When you can access the full channel lineup on your Sportscaster, you're done!

Warning: When using this product it is always important to keep your eyes on the road and your hands on the wheel. Not doing so could result in injury and/or death to you or to others and/or in property damage.

Warning: Failure to do so could result in personal injury, death, and/or damage to your Sportscaster, accessories, and/or to your vehicle or property.

Installation

Mounting to the Dashboard or Console

If using the AMPs mounting holes to fasten the Sportscaster car mount to your dash or console, Bolt or screw the Sportscaster car mount in place and proceed to step 3. AMPs is the standard hole spacing used in most mobile phone mounts.

1. Remove the protective film from one side of the supplied double sided tape. Press firmly to secure the tape to the bottom of the car mount. (Figure 1).
2. Remove the protective film from the remaining side of the double sided tape. Place the car mount in the appropriate location on the vehicle's dash or console and press firmly. (Figure 2).
3. Push the Sportscaster into the car mount until it locks into place. (Figure 3).
4. Connect the DC Power, antenna and audio connectors (if required) to the appropriate jacks. (Figure 3). Use the cassette adapter if your vehicle's audio system has a built-in cassette player.
5. For best reception, place the XM antenna on the vehicle's metallic roof, at least 6" from any window or sunroof. It can be placed in the front, middle, or rear of the roof. (Figure 4).
6. For instructions on installing your FM Transmitter please refer to the Coupler Installation Guidelines.
7. To remove the Sportscaster, push the release tab on the top of the car mount upward and pull the Sportscaster forward.

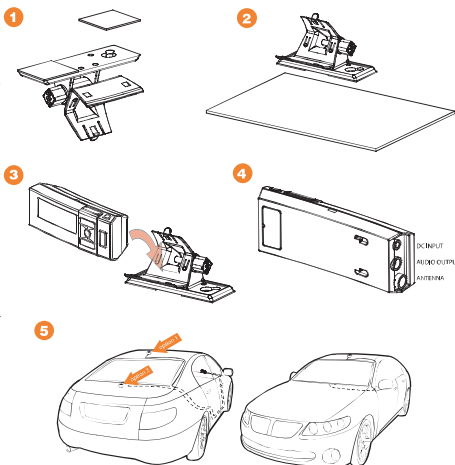

If the car is a convertible, you may mount the antenna on the metal trunk lid. It should be at least 4" from the rear window. Ensure that the antenna and cable don't interfere with the opening or closing of the convertible top or the trunk lid.

Installation

Mounting to the Windshield

1. Insert the 2 suction cups into the larger side of the holes on the car mounting bracket and slide outward to lock in place. (Figure 1).
2. Loosen the thumb screw and rotate the Sportscaster car mount to the appropriate angle for your vehicle's windshield. Retighten the thumb screw. Place the suction cups on the Sportscaster car mount in an appropriate location on your windshield. Press firmly to secure the car mount in place. (Figure 2).
3. Push the Sportscaster into the car mount until it locks into place. (Figure 3).
4. Connect the DC Power, antenna and audio connectors (if required) to the appropriate jacks. (Figure 3). Use the cassette adapter if your vehicle's audio system has a built-in cassette player.
5. For best reception, place the XM antenna on the vehicle's metallic roof, at least 6" from any window or sunroof. It can be placed in the front, middle, or rear of the roof. (Figure 4).
6. For instructions on installing your FM Transmitter please refer to the Coupler Installation Guidelines.
7. To remove the Sportscaster, push the release tab on the top of the car mount upward and pull the Sportscaster forward.

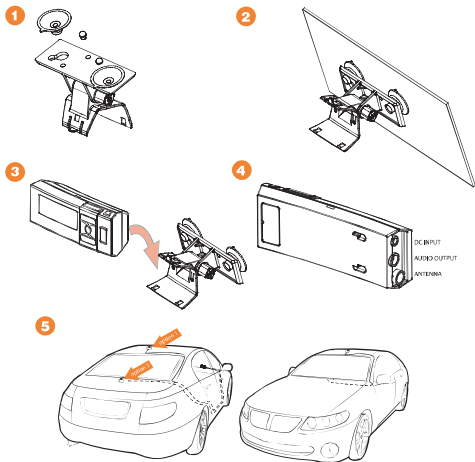

If the car is a convertible, you may mount the antenna on the metal trunk lid. It should be at least 4" from the rear window. Ensure that the antenna and cable don't interfere with the opening or closing of the convertible top or the trunk lid.

Installation

Mounting in the Home

1. Push the Sportscaster into the home mount until it locks into place. (Figure 1).
2. Connect the AC Power and antenna to the appropriate jacks. (Figure 2).
3. Connect the audio cable to the appropriate jack. (Figure 3).
4. Place the antenna on a window or an exterior wall so that it points south. (Figure 4).
5. To Remove the Sportscaster, push the release tab on the top of the home mount upward and pull the Sportscaster forward.

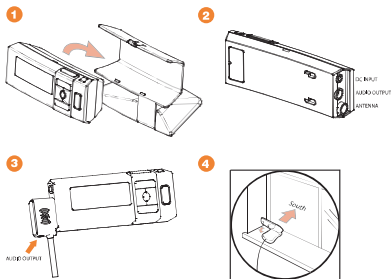

Installation

Using the Portable Battery Kit

1. Attaching the battery to your Sportscaster is simple. First, install battery by lining up the battery with the slots in the back of your Sportscaster. Next, slide the battery into place until it is locked. (Figure 1). For a complete charge, the battery must be charged for approximately 3 hours. The battery life is approximately 4 hours.
2. To attach the belt clip onto your Sportscaster, push the Sportscaster into the belt clip until it locks into place. (Figure 2).
3. Plug the connector of the integrated XM antenna headset into the connectors with the wire exiting upwards as shown in (Figure 3).
4. To remove the Sportscaster, push the release tab on the top of the belt clip upward and pull the sportscaster forward.

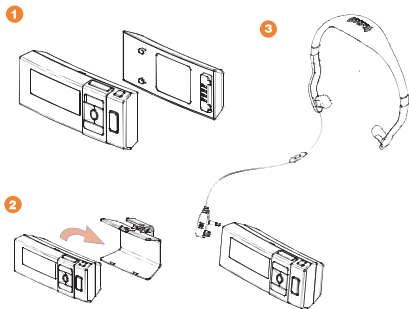

Listening to XM

Tuning Categories and Channels

Categories

The XM channels are arranged by categories. Pressing the select button enters first channel in that category. The Left and Right Arrow buttons move SportsCaster forward or backward through the available XM categories. The Up and Down Arrow buttons are then used to tune to a channel from within the selected category. After displaying the desired channel, press the select button to tune that channel.

You can tune through all the available XM channels using the "All Channels" Category option within the Category listings.

Direct Tuning via Remote Control (only)

You can select a channel directly by entering its channel number with the Remote Control numeric buttons. Channel 12 can be entered as "1", followed by "2", and pressing the select button. You may also input "0", followed by "1", and "2".

Note: Channel numbers which do not have channels assigned to them, that are blocked, or that are not authorized for the SportsCaster will not be displayed during navigation.

Channels 0 and 1

You can navigate to channel 0 or 1 from within the "All Channels" Category option or by direct tuning via the Remote Control. Channel "0" displays the Radio ID, Channel "1" is the XM preview channel

FAV (Favorite Channels)

The FAV feature allows you to store up to 30 of your favorite channels. Press the FAV button and the display will show the following:

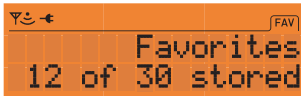

The top line will show FAV, the lower line shows the number of Favorites stored out of the 30 locations available (X of 30 stored).

Storing Favorites

If you would like to store a favorite channel, tune to the desired channel and press the FAV button for 2 seconds. The message "Favorite Stored" is displayed on the first line, the lower line will display the Channel Name and Channel Number for 3 seconds.

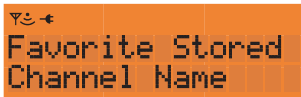

Exceptions to Storing Favorites

If 30 favorites are already stored, SportsCaster will indicate that the favorite locations are full.

If a channel has already been stored, the channel cannot be stored again. In this case the Favorite Exists message will appear:

Tuning Favorites

There are two ways to tune to your Favorite channels:

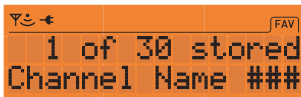

1. With each press of the FAV button the SportsCaster moves through the stored Favorites in succession. Favorites are accessed in the order they are stored.
2. Press the Up and Down Arrow buttons to navigate forward or backward through the stored Favorites.

Customizing Your Favorites

Move Favorite to Top

You can move any stored Favorite channel to the first position in your Favorites list. To move the favorite channel you are currently listening to, press and hold the Select button down for 2 seconds. The following message appears on the display.



Deleting Favorites

To delete a Favorite channel, tune to that channel while in FAV mode. Press and hold the FAV button down for 2 seconds. The following message will appear.

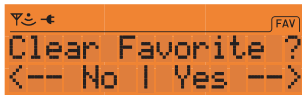

Select Yes to delete that channel. A confirmation message indicating Favorite Cleared is displayed. Select No to return to the first stored favorite.

Exiting Favorites Mode

Press either the Left or Right Arrow buttons to Category tune and exit Favorites mode. The FAV indicator will be deactivated on the display.

Personalizing Your Sportscaster

You can easily adapt your Sportscaster to suit your listening habits. Simply press the Menu button to see the options you can customize. Pressing the Menu button enters the menu options mode. The menus are then navigated using a combination of the Select, Menu, and the Up/Down/Left/Right Arrow buttons.

Any Menu option that has a sub-menu is displayed with a right-facing arrow. The Up/Down Arrow buttons then move through the options in that sub menu. Pressing the Right Arrow or Select button will enter the submenu(s).

When a menu option is selected the display flashes to indicate the selection is stored. The menu button backs out of the previous menu level. The Sportscaster returns to the initial display of the current submenu.

FM Transmitter



Frequencies

This feature will enable the Sportscaster to broadcast XM content via a FM frequency between 88.1MHz to 107.9MHz. The FM Transmitter is disabled when either in battery mode or when the audio output jack is in use.



Note: The FM Transmitter's default setting is OFF.

1. Press the Menu button to enter the Setup Menu.
2. Press the Up and Down Arrow buttons to navigate to FM Transmitter.
3. Press the Select or Right Arrow button to enter the FM Transmitter sub menu.
4. Press the Up or Down Arrow buttons to navigate to Frequencies and choose an available frequency that is not being used by an FM Broadcaster in your area.
5. Press the Select button to store the frequency.

Note: The FM frequency you select may need to be changed when traveling. This is due to the differences in signal strength of local FM stations and is not a problem with your Sportscaster.

Audio Level



The Audio Level option adjusts the Sportscasters audio output. There are 10 levels of adjustment available.

1. Press the Menu button to enter the Setup Menu.
2. Press the Up or Down Arrow button to navigate to Audio Level.
3. Press the Select or Right Arrow button to enter the Audio Level sub menu.
4. Press the Left or Right Arrow button to adjust the audio level to your comfort.
5. Press the Select button to store the new setting.



Note: The default setting is level 6.

Tuning Options



The Tuning Options are used to set the method that channels are tuned. There are two tuning options available.

Manual Tune

Manual Tune mode allows the user to choose channels by viewing the programming

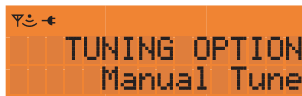

and tuning the desired channel only after pressing the Select button.

1. Press the Menu button to enter the Setup Menu.
2. Press the Up or Down Arrow button to navigate to Tuning options.
3. Press the Select or Right Arrow button to enter the Tuning Options sub menu.
4. Press the Up or Down Arrow button to navigate to Manual Tune.
5. Press the Select or Right Arrow button to set Manual Tune mode.

Note: The default setting is Manual Tune.

Auto Tune

Auto Tune will tune to each channel when the channel is viewed without pressing the Select button.



1. Press the Menu button to enter the Setup Menu.
2. Press the Up or Down Arrow button to navigate to Tuning Options.
3. Press the Select or Right Arrow button to enter the Tuning Options sub menu.
4. Press the Up or Down Arrow button to navigate to Auto Tune.
5. Press the Select or Right Arrow button to set Auto Tune mode.

Note: Channel selection using the remote control keypad is always tuned automatically.

Display Options



Contrast

This option is used to adjust the Sportscasters display contrast. There are 10 levels of adjustment available.



1. Press the Menu button to enter the Setup Menu.
2. Press the Up or Down Arrow buttons to navigate to Display Options.
3. Press the Select or Right Arrow button to enter the Display Options sub menu.
4. Press the Up or Down Arrow buttons to navigate to Contrast.
5. Press the Select or Right Arrow button to enter the Contrast setting screen
6. Press the Left or Right Arrow button to adjust the contrast to your desired level.
7. Press the Select button to store the new setting.



Note: The default setting is level 6.

Brightness

This option is used to adjust the Sportscasters display brightness. There are 10 levels of adjustment available.



1. Press the Menu button to enter the Setup Menu.
2. Press the Up or Down Arrow button to navigate to Display Options.
3. Press the Select or Right Arrow button to enter the Display Options sub menu.
4. Press the Up or Down Arrow button to navigate to Brightness.
5. Press the Select or Right Arrow button to enter the Brightness setting screen
6. Press the Left or Right Arrow button to set the brightness to your desired level.
7. Press the Select button to store the new setting.



Note: The default setting is level 6.

Cycle Display

This option alternates the sportscaster through the three available display modes at five second intervals. See below for a description of the available views.



There are 3 display views.

1. Artist/Song Title View - Artist is on the top line, Song Title is on the bottom.
2. Category/Channel View - Category Name is on the top line, Channel Info is on the bottom.
3. Time/Artist-Song Title View - Current time is on the top line, Artist-Song are on the bottom.



Note: The default setting is Cycle Display Off.

1. Press the Menu button to enter the Setup Menu.
2. Press the Up or Down Arrow buttons to navigate to Display Options.
3. Press the Select or Right Arrow button to enter the Display Options sub menu.
4. Press the Up or Down Arrow buttons to navigate to Cycle Display.
5. Press the Select or Right Arrow button to enter the Cycle Display sub menu.
6. Press the Up or Down Arrow buttons to select On or Off.
7. Press the Select or Right Arrow button to store the new setting.

Scrolling

This option defines the way information is displayed. There are two modes available Scroll Display and Page Display. Scroll Display shows the information that extends beyond the available 16 characters on the display by scrolling the text from right to left. Page Display shows the current viewable text that will fit on the screen, and then replaces it with the missing text.



1. Press the Menu button to enter the Setup Menu.
2. Press the Up or Down Arrow buttons to navigate to Display Options.
3. Press the Select or Right Arrow button to enter the Display Options sub menu.
4. Press the Up or Down Arrow buttons to navigate to Scrolling.
5. Press the Select or Right Arrow button to enter the Scrolling sub menu.
6. Press the Up or Down Arrow button to select Scroll Display or Page Display.
7. Press the Select or Right Arrow button to store the new display setting.



Note: The default setting is Scrolling Display.

BackLight Timeout

This option powers the Sportscaster's backlight Off after a preset time has elapsed. This feature is only active when using the Portable Battery Kit to power your Sportscaster.



1. Press the Menu button to enter the Setup Menu.
2. Press the Up or Down Arrow buttons to navigate to Display Options.
3. Press the Select or Right Arrow button to enter the Display Options sub menu.
4. Press the Up or Down Arrow buttons to navigate to Timeout.
5. Press the Select or Right Arrow button to enter the Backlight Timeout screen.
6. Press the Up or Down Arrow buttons to select either Off, 1, 3 or 5 minutes.
7. Press the Select or Right Arrow button to enter the desired time.



Note: The default setting for the BackLight Timeout is Off.

Clock Features

This menu option will allow access to all of the time based features available with the Sportscaster.



Alarm

This option powers the Sportscaster on at a preset time. The Alarm feature will only operate if the Sportscaster is currently powered off and able to receive XM Satellite Radio signal. Settings for the Alarm are permanently stored and still active after Sportscaster is powered off. When Alarm feature is enabled the Alarm indicator will be active on the display.



1. Press the Menu button to enter the Setup Menu.
2. Press the Up or Down Arrow buttons to navigate to Clock features.
3. Press the Select or Right Arrow button to enter the Clock features sub menu.
4. Press the Up or Down Arrow buttons to navigate to Alarm.
5. Press the Select or Right Arrow button to enter the Alarm screen.
6. Press the Up or Down Arrow buttons to navigate to On/Off.
7. Press the Select or Right Arrow button to enter the Alarm On/Off sub menu.
8. Press the Up or Down Arrow button to navigate to Alarm On or Alarm off.
9. Press the Select or Right Arrow button to place the Alarm in the desired state.



Note: The default setting for the Alarm is off.

To set the Alarm Time first repeat steps 1-5.

6. Press the Up or Down Arrow buttons to navigate to Time.
7. Press the Select or Right Arrow button to enter the Alarm Time sub menu.
8. Press the Up or Down Arrow button to select the first hour digit.
9. Press the Right Arrow button to move to the next digit.
10. Continue steps 8-9 until the desired time is shown including AM or PM.
11. Press the Select button to set the Alarm time.



Sleep

This option powers the Sportscaster Off after a preset time has elapsed. You can use the Sportscaster normally and not interrupt the Sleep timer countdown. Sleep settings are not active after the Sportscaster is powered off. When Sleep mode is activated, the Sleep indicator will be visible on the display.



1. Press the Menu button to enter the Setup Menu.
2. Press the Up or Down Arrow buttons to navigate to Clock features.
3. Press the Select or Right Arrow button to enter the Clock features sub menu.
4. Press the Up or Down Arrow buttons to navigate to Sleep.
5. Press the Select or Right Arrow button to enter the Sleep setting screen.
6. Press the Up or Down Arrow buttons to select either Off, 15, 30, 45 or 60 minutes.
7. Press the Select or Right Arrow button to enter the desired Sleep time.



Note: The default setting for the Sleep Timer is Off.

Auto Shutdown

This option powers off the Sportscaster after a 1-hour period of no user activity. After 59-minutes of inactivity, an Auto Shutdown notice appears. If the Select button is pressed, Auto Shutdown is cancelled.



1. Press the Menu button to enter the Setup Menu.
2. Press the Up or Down Arrow buttons to navigate to Clock features.
3. Press the Select or Right Arrow button to enter the Clock features sub menu.
4. Press the Up or Down Arrow buttons to navigate to Auto Shutdown.
5. Press the Select or Right Arrow button to enter the Auto Shutdown sub menu.
6. Press the Up or Down Arrow button to select Enable or Disable.
7. Press the Select or Right Arrow button to store the Auto Shutdown setting



Note: The default setting for Auto Shutdown is Disable.

Format

This option selects either a 12-hour or 24-hour (military) time display format.



1. Press the Menu button to enter the Setup Menu.
2. Press the Up or Down Arrow buttons to navigate to Clock features.
3. Press the Select or Right Arrow button to enter the Clock features sub menu.
4. Press the Up or Down Arrow buttons to navigate to Format.
5. Press the Select or Right Arrow button to enter the Format sub menu.
6. Press the Up or Down Arrow button to select 12 Hour or 24 Hour.
7. Press the Select or Right Arrow button to store the desired Clock Format.



Note: The default setting for Format is 12 Hour time display.

Time Zone

This option allows you to select the appropriate time zone for your area.



1. Press the Menu button to enter the Setup Menu.
2. Press the Up or Down Arrow buttons to navigate to Clock features.
3. Press the Select or Right Arrow button to enter the Clock features sub menu.
4. Press the Up or Down Arrow buttons to navigate to Time Zone.
5. Press the Select or Right Arrow button to enter the Time Zone sub menu.
6. Press the Up or Down Arrow button until the appropriate Time Zone is shown.
7. Press the Select or Right Arrow button to store the desired Time Zone.



Note: Eastern (GMT-5:00) is the default setting

Daylight Savings

This option will enable the clock to automatically adjust when your time zone observes daylight savings time.



1. Press the Menu button to enter the Setup Menu.
2. Press the Up or Down Arrow buttons to navigate to Clock features.
3. Press the Select or Right Arrow button to enter the Clock features sub menu.
4. Press the Up or Down Arrow buttons to navigate to Daylight Savings.
5. Press the Select or Right Arrow button to enter the Daylight Savings sub menu.
6. Press the Up or Down Arrow button to select the correct daylight savings setting.
7. Press the Select or Right Arrow button to store the daylight savings setting.

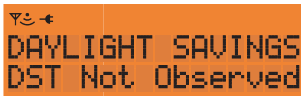

Note: DST Observed is the default setting.

Defaults



This option is used to return the Sportscaster to the original "factory" settings. Restoring defaults resets all settings to the factory defaults.

1. Press the Menu button to enter the Setup Menu.
2. Press the Up or Down Arrow buttons to navigate to Defaults.
3. Press the Select or Right Arrow button to enter the Defaults sub menu.
4. Press the Select or Right Arrow button to enter the Restore Defaults selection screen.
5. Press the Left or Right Arrow button to Select Yes or No.



Antenna Aiming



This option presents feedback indicating the strength of satellite and terrestrial signals. Use this screen to place your antenna in the optimal position to receive the XM broadcast.

1. Press the Menu button to enter the Setup Menu.
2. Press the Up or Down Arrow buttons to navigate to Antenna Aiming.
3. Press the Select or Right Arrow button to enter the signal strength indicator.



SAT. indicates satellite signal strength.

TER. indicates terrestrial ground repeater signal strength.

Troubleshooting

Your Sportscaster should provide you with trouble-free performance without needing any servicing. If it does not appear to be working properly, first try to remedy the problem by following these steps:

1. Attach all connections firmly and securely.
2. Ensure the cigarette lighter adapter or auxiliary power socket is clean and free of corrosion.
3. Check the adapter fuse by unscrewing the ribbed end of the adapter. If required, replace with a 2-amp fuse only. If your cigarette lighter adapter does not have a removable end cap, then it is equipped with an internal fuse that resets itself after it is left unpowered for a period of time.

If you see this on the display:

You should:

NO SIGNAL

Cause: The XM signal is being blocked.

Move your Sportscaster away from the obstructed area (e.g., an underground garage).

CHECK ANTENNA

Cause: Possible problem with XM antenna

Connect the antenna. Make sure the cable and connectors are not damaged or kinked.

OFF AIR

Cause: The channel selected is not currently broadcasting.

Tune to another channel.

UPDATING

Cause: Your Sportscaster is being updated with the latest encryption code.

Simply wait until the update is completed.

Cause: You may have tried to tune to a channel that you have blocked or that you cannot receive with your subscription package.

To receive that channel, contact XM Satellite Radio at 1.800.967.2346.

Warranty Information

One-Year Limited Warranty

This limited warranty sets forth all **Advanced Global Technology** responsibilities regarding your product. There are no other expressed or implied warranties from **Advanced Global Technology**.

Warranty Service Provided

If you purchased the product new from a retail vendor, **Advanced Global Technology** warrants the equipment against defects in material and workmanship for a period of one (1) year from the original date of purchase. This warranty is in lieu of all other express warranties. This warranty begins when you purchase the product and continues for one (1) year unless you sell or rent the unit, in which case the warranty stops.

Advanced Global Technology disclaims any implied warranty, including the warranty of merchantability and the warranty of fitness for a particular purpose, as of the date of one year from your original purchase of the product **Advanced Global Technology** assumes no responsibility for any special, incidental, or consequential damages.

This warranty gives you specific legal rights and you may have other rights which vary from state to state. Some states do not allow the exclusion or limitations of special, incidental, or consequential damages or limitations on how long a warranty lasts, so the above exclusion or limitation may not apply to you.

Warranty Service Not Provided

This warranty does not cover damage resulting from accident, misuse, abuse, improper installation or operation, lack of reasonable care, unauthorized modification, or the affixing of any attachment not provided by **Advanced Global Technology** with the equipment, and/or loss of parts. This warranty is voided in the event any unauthorized person opens, alters, or repairs the product.

All **Advanced Global Technology** equipment being returned for repair must be suitably packaged.

What to Do for Warranty Service

During the first thirty (30) days, a defective product is eligible for over-the-counter exchange at the retailer from whom it was purchased. After thirty (30) days, the defective product should be returned to the authorized service center. Please allow a minimum of 2-3 weeks for the return of your product. For the shipping address of the authorized service center, call one of the telephone numbers given below.

Your product will be repaired or replaced if examination by the service center determines the product is defective. Products received damaged as a result of shipping will require you to file a claim with the carrier prior to repair. A product received with missing parts or with damage due to abuse, inadequate packing or some other noncompliance with this limited warranty will be returned to you C.O.D., freight collect.

Note: A product received which was not made by Advanced Global Technology or which is not defective as determined by our test procedures will not be repaired and will be returned to you C.O.D., freight collect.

To Obtain Warranty Service

- Provide proof of the date of purchase within the package.
- Prepay all shipping costs to the authorized service center.
- Include a return shipping address within the package.

Please retain your sales receipt, the carton, the packing materials, and the printed material. The original carton is the best shipping container for the Product should you have to return it.

For your reference:

Model Number _____ XM Radio ID _____ Serial Number _____

Date of Purchase _____ Where Purchased _____

**Advanced Global Technology Customer Service Telephone Number:
1-877-SUPT-ACT (787-8248)**

Visit Us on the Web: www.advancedgt.com



Advanced Global Technology, LLC.

Advanced Global Technology, LLC
P.O. Box 2060
New York, NY 10156-2060
U.S.A.
Customer Service (1) 877.SUPT.AGT

www.advancedgt.com

AGT, Sportscaster name and related logos are
trademarks of Advanced Global Technology, LLC.

XM name and related logos are registered
trademarks of XM Satellite Radio Inc.

 Printed on Recycled Paper
©2006 Advanced Global Technology, LLC. All rights reserved.