

# SiriusXM XMH

## Dock & Play Radio + Vehicle Kit User Guide



**SiriusXM**  
SATELLITE RADIO



If you experience problems with the operation  
or performance of your SiriusXM product,

**DO NOT RETURN THIS PRODUCT TO YOUR RETAILER.**

Call SiriusXM Listener Care at 1-866-746-7961  
and speak to one of our service representatives.



## Table of Contents

<b>Introduction</b> .....	5	<b>Where Else Can You Use Your XMH?</b> .....	69
Features.....	6	<b>Configuring Your XMH</b> .....	71
Safety and Care Information.....	7	Radio ID.....	72
What's in the Box?.....	9	Channel Tuning.....	72
XMH Button Functions.....	10	Find Available FM Channels in	
PowerConnect Vehicle Dock.....	11	Your Area.....	73
<b>Vehicle Installation</b> .....	13	Set and Select an FM Channel.....	76
Step 1: Choose a Location for Your		Jump Settings.....	79
Radio.....	14	Set Brightness.....	80
Step 2: Install the Dash or Vent Mount	16	Set Audio Level.....	81
Step 3: Mount the Magnetic Mount		Signal Indicator.....	82
Antenna.....	20	Factory Settings.....	83
Step 4: Route the Magnetic Mount		Demo Mode.....	86
Antenna Cable.....	26	Auto Shut Off.....	87
Step 5: Connect the Magnetic Mount		Using the Vehicle Dock From the	
Antenna and PowerConnect Power		Universal Xpress Car Kit.....	88
Adapter.....	37	Turn FM Transmitter On/Off.....	89
Step 6: Connect the Audio.....	38	<b>Troubleshooting</b> .....	91
<b>Subscribe</b> .....	47	<b>Product Specifications</b> .....	97
<b>Using Your XMH</b> .....	51	Patent Information.....	99
The Main Display.....	52	Environmental Information.....	99
Navigation Basics.....	53	<b>SiriusXM 90-Day Limited</b>	
Listening to Satellite Radio.....	55	<b>Warranty</b> .....	103
FM Presets.....	59		
<b>Special Features</b> .....	61		
Pause & Replay.....	62		
Parental Controls.....	64		

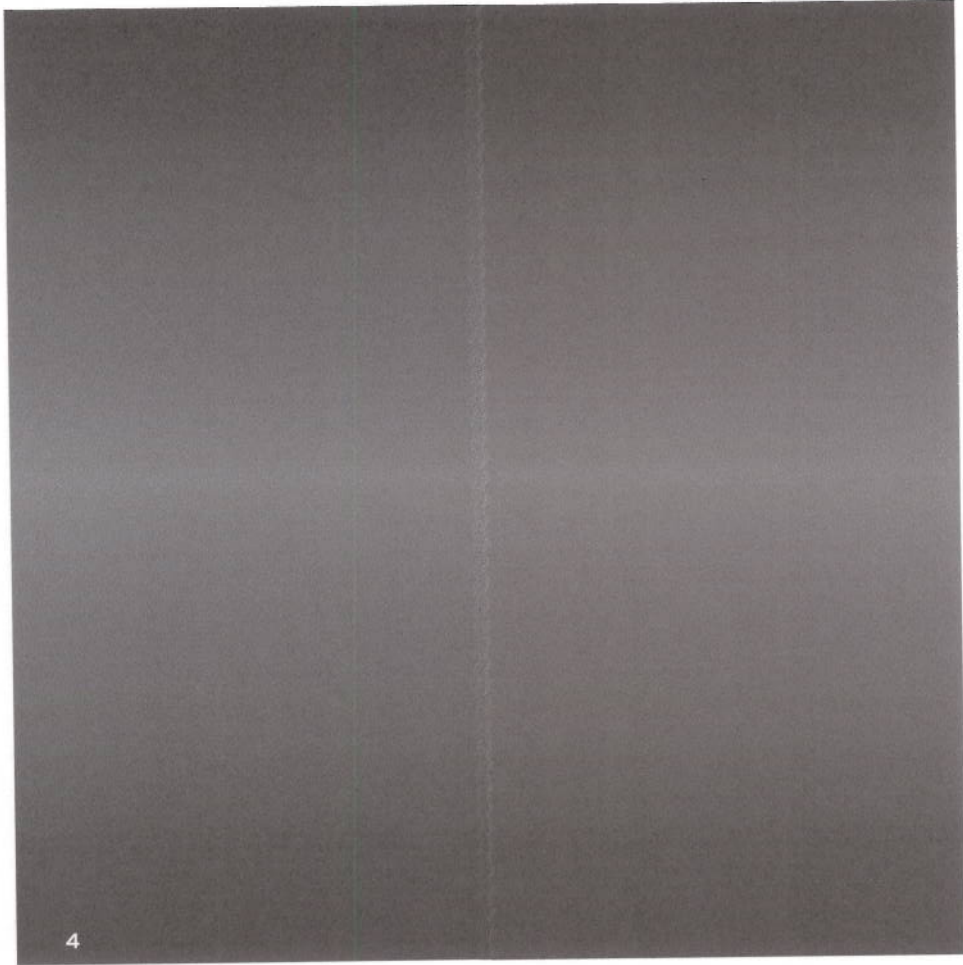

# Introduction

## Introduction

### Features

#### **Thank you for purchasing the XM XMH with Vehicle Kit!**

XM XMH has these exciting features to enhance your overall experience:

- Hear SiriusXM through your existing vehicle radio with easy, do-it-yourself installation.
- Large vibrant color display to view artist name, song title, and all channel information with color backgrounds, channel graphics, and channel icons.
- Pause, rewind and replay live Satellite Radio.
- Browse other channels while listening to the current one.
- View artist name, song title, and channel information on the large color display.
- Store your favorite channels for one touch access.
- Easily lock and unlock channels with mature content.
- One-Touch Jump™ to traffic and weather for the city of your choice from a list of 22 of the most congested cities, or to the previous channel to which you were listening.
- Listen in multiple vehicles, at home, in the office or outdoors - all with just one subscription.
- Vehicle Kit included – add accessories for your home, office, or other vehicles.

**Please read through this User Guide before using your XMH!**

## Safety and Care Information



**IMPORTANT!** Self installation instructions and tips are provided for your convenience. It is your responsibility to determine if you have the knowledge, skills, and physical ability required to properly perform an installation. SiriusXM shall have no liability for damage or injury resulting from the installation or use of any SiriusXM or third party products. It is your responsibility to ensure that all products are installed in adherence with local laws and regulations and in such a manner as to allow a vehicle to be operated safely and without distraction. SiriusXM product warranties do not cover the installation, removal or reinstallation of any product.

- Do not expose to extreme temperatures (above 140°F or below -4°F, or above 60°C or below -20°C).
- Do not expose to moisture. Do not use device near or in water. Do not touch the device with wet hands.
- Do not let any foreign matter spill into device.
- Do not store in dusty areas.
- Do not expose to chemicals such as benzene and thinners. Do not use liquid or aerosol cleaners. Clean with a soft damp cloth only.
- Do not expose to direct sunlight for a prolonged period of time, and do not expose to fire, flame, or other heat sources.
- Do not try to disassemble and/or repair device yourself.
- Do not drop your device or subject it to severe impact.
- Do not place heavy objects on device.
- Do not subject device to excessive pressure.
- If the LCD screen is damaged, do not touch the liquid crystal fluid.

## Introduction

### Warning!

- Opening the case may result in electric shock.
- If the liquid crystal fluid comes in contact with your skin, wipe the skin area with a cloth and then wash the skin thoroughly with soap and running water. If the liquid crystal fluid comes into contact with your eyes, flush the eyes with clean water for at least 15 minutes and seek medical care. If the liquid crystal fluid is ingested, flush your mouth thoroughly with water. Drink large quantities of water, and induce vomiting. Seek medical care.
- Make sure that you insert the *PowerConnect™* Power Adapter all the way into the vehicle's cigarette lighter or power adapter socket.
- If you are using *PowerConnect* as your audio connection option, it is advisable not to insert a multi-outlet adapter into the same vehicle cigarette lighter or power adapter socket to simultaneously power other devices. Some multi-outlet adapters can prevent the *PowerConnect* feature from working properly.
- When using this product, it is always important to keep your eyes on the road and hands on the steering wheel. Not doing so could result in personal injury, death, and/or damage to your device, accessories, and/or to your vehicle or other property.
- Vehicle installation, service activation, and Radio configuration functions should not be performed while driving. Park your vehicle in a safe location before beginning installation.
- This product contains chemicals known to the State of California to cause cancer and birth defects or other reproductive harm.

Your device should be placed in your vehicle where it will not interfere with the function of safety features, e.g., deployment of airbags. Failure to correctly place device may result in injury to you or others, if the unit becomes detached during an accident and/or obstructs the deployment of an airbag.



## What's in the Box?

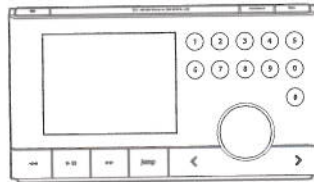

XMH Radio

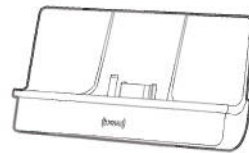

PowerConnect Vehicle Dock



Aux In Cable



Dash Mount

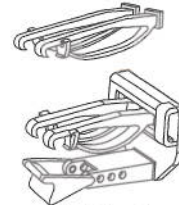

Vent Mount  
and Extended  
Vent Clamps



Cable  
Routing Adapter



Magnetic Mount  
Antenna

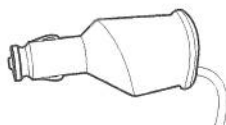

PowerConnect Power  
Adapter



Antenna & Dash Mount  
Alcohol Preparation Pads

# Introduction

## XMH Button Functions

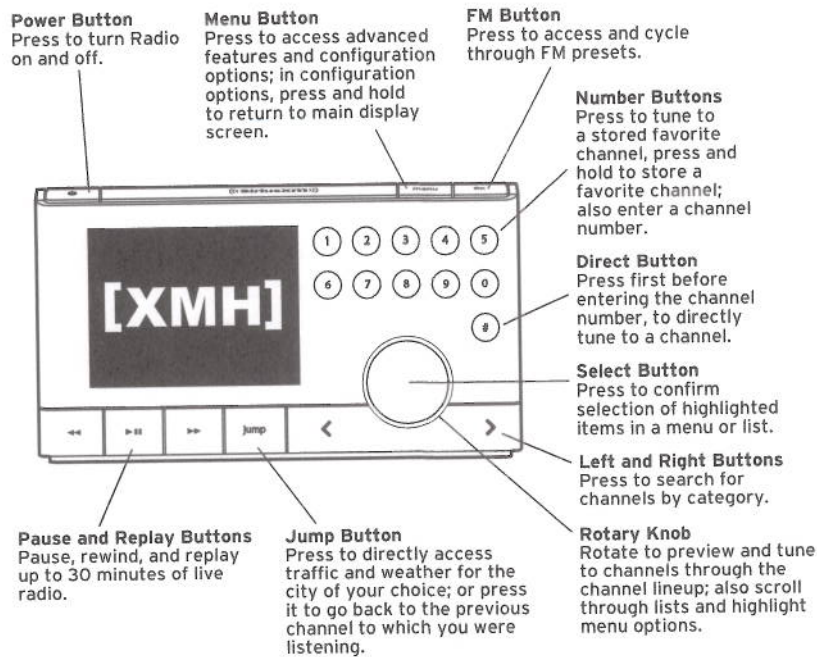

## PowerConnect Vehicle Dock

### Color-Coded Connections

The color-coded *PowerConnect* Vehicle Dock makes it simple to connect. Just match the colors on the cable ends to the colors on the dock to see what goes where.

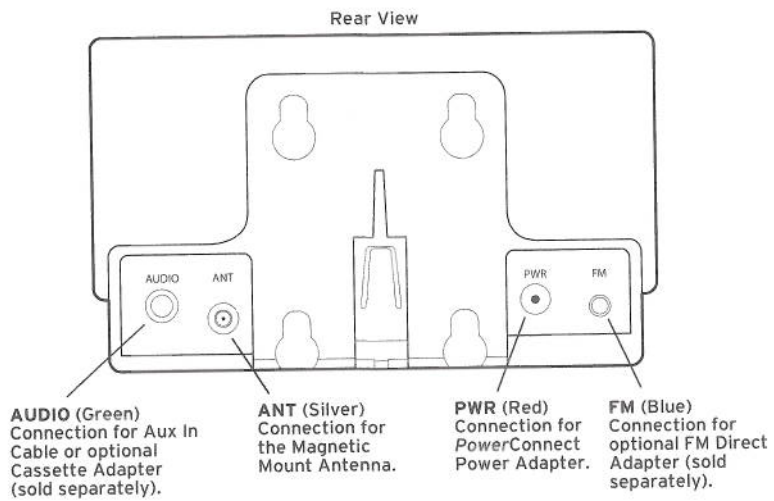

## Introduction

### Wire Guide

The PowerConnect Vehicle Dock has a wire guide at the top rear that can help you to organize the cables and wires connected to the dock. If you need to bring a cable or wire from one side of the dock to the other, utilize the wire guide by looping the cable through the wire guide as shown.

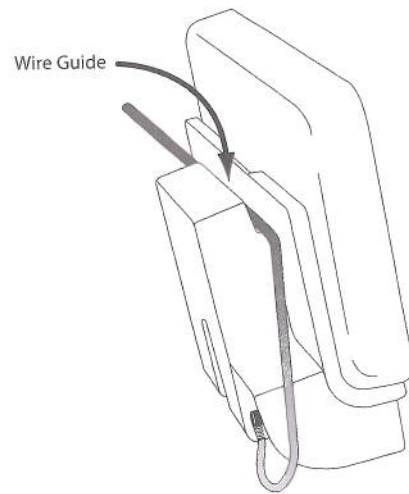

## Vehicle Installation

## Vehicle Installation



**WARNING! DO NOT** attempt to install XMH while driving. Park your vehicle in a safe location before beginning installation.

### Step 1: Choose a Location for Your Radio

When installing XMH in your vehicle, choose a location where it will not block your vision, interfere with the controls, or obstruct the air bag. The location should be easily accessible and provide good visibility of the display, and should not be located where it will be in direct sunlight, which will affect the visibility of the display screen.

Several examples of XMH mounted in a vehicle are shown: **A** is the on dash method using the Dash Mount, and **B** is the vent clip method using the Vent Mount.

Option 1

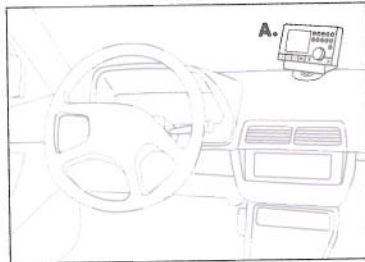

Option 2

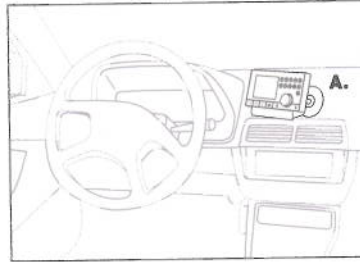



Option 3

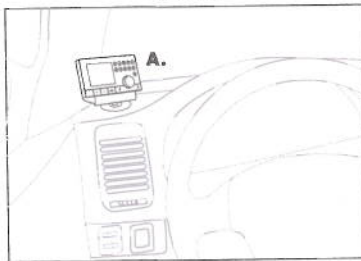

Option 4

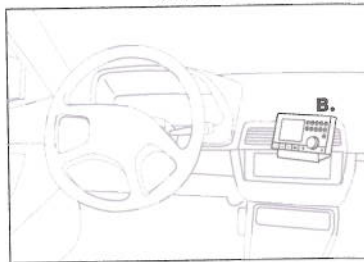

Option 5

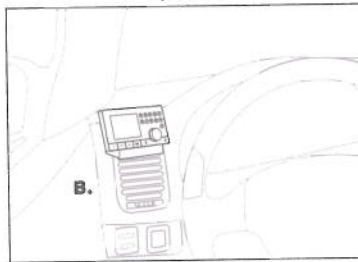

## Vehicle Installation

### Step 2: Install the Dash or Vent Mount

Depending on your situation, you can either choose to use the Dash Mount or the Vent Mount.

 **IMPORTANT!** When you install the chosen mount, do not attach the dock to the mount. All cables should be attached to the dock prior to connecting the dock to the mount.

#### Installing the Dash Mount:

 **CAUTION!** The adhesive used on the Dash Mount may be difficult to remove. Do not install this mount on leather surfaces (contact your vehicle dealer if you are unsure about your dash surface), and make sure the air temperature is at least 60°F (15°C) during installation. If it's not at least 60°F, turn on the heater in your vehicle to bring the temperature up to 60°F.

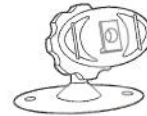

- 1 Locate a flat surface for the Dash Mount. Make sure there is ample room for the PowerConnect Vehicle Dock and XMH Radio when installed.
- 2 Set the orientation of the Dash Mount before adhering it. Loosen the knob and adjust the adhesive foot for the location you selected in "Step 1: Choose a Location for Your Radio" on page 14:

- Option 1 & Option 3 should be oriented as I.
- Option 2 should be oriented as II.

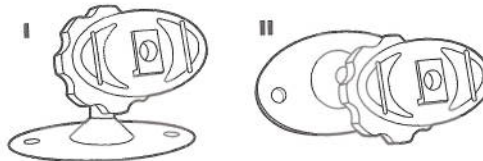



- 3** The dock mounting plate can be tilted in different directions. Adjust as necessary for your particular vehicle. When the orientation is correct, tighten the knob.

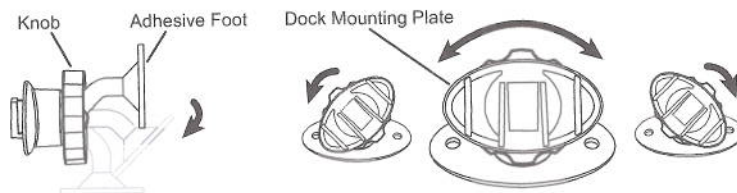

- 4** Clean the surface with the alcohol preparation pad and let it dry thoroughly.

- 5** Peel off the adhesive liner. Position, press, and hold the Dash Mount in place for 30 seconds.

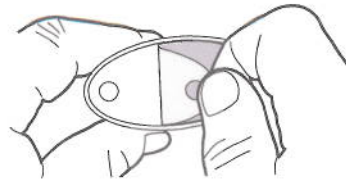

**IMPORTANT!** Allow the Dash Mount adhesive to cure (dry) for a minimum of 2-4 hours before using the mount. The best adhesion occurs after 24 hours.

**TIP!** To remove, carefully lift the adhesive pad with your fingers or a spoon. Warming the pad with a hair dryer for several minutes will help soften the adhesive.

## Vehicle Installation

### Installing the Vent Mount:

- 1 Locate a vent with horizontal louvers sturdy enough to hold your PowerConnect Vehicle Dock and Radio.
- 2 If the vent louvers in your vehicle are recessed, you may need to use the longer vent clamps with the Vent Mount. If so, remove the shorter vent clamps and install the longer ones into the Vent Mount. Be sure to observe the orientation of the vent clamps as shown.
- 3 Push the Vent Mount onto the vehicle vent as shown (1) until it hooks on the rear of the vent louver (2).

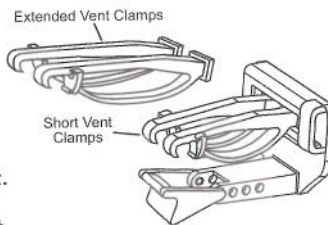

Remove End Cap



Slide Short Vent Clamps Out

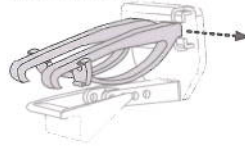

Slide Extended Vent Clamps In

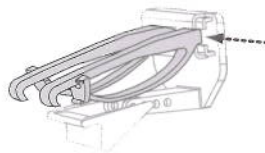

Replace End Cap



- 4 Rest the foot against the bottom of the vent (2), and adjust the tilt of the Vent Mount by repositioning the foot to a different adjustment hole (3).

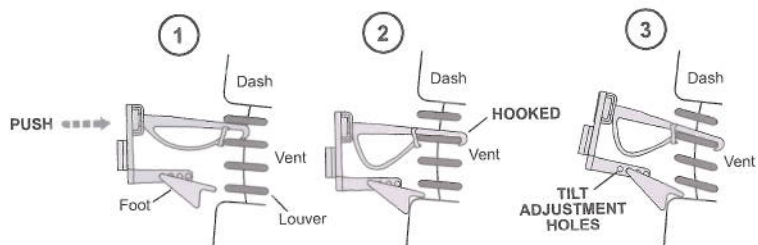

To remove the Vent Mount, push the mount into the vent. Then lift up until disengaged from the rear of the vent louver, and remove the Vent Mount.

## Vehicle Installation

### Step 3: Mount the Magnetic Mount Antenna

Mount the Magnetic Mount Antenna on the outside of your vehicle, on a horizontal surface that will always face the sky. The antenna contains a strong magnet which will stick to any metal part of your vehicle, but will not damage the vehicle.

#### *To install the Magnetic Mount Antenna:*

- 1 Choose the best location for your antenna considering your vehicle type. Pay particular attention to any accessories that you may have like luggage racks and how frequently you may use them.



**Sedan/Coupe:** We recommend mounting the antenna just above either the front windshield or the back window as shown.

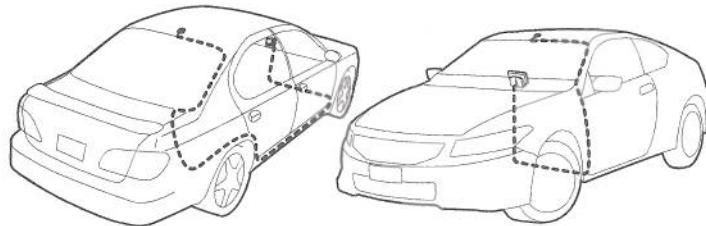

**SUV:** We recommend mounting the antenna at the rear of the roof as shown.

**Convertible:** We recommend mounting the antenna at the leading edge of the trunk as shown.

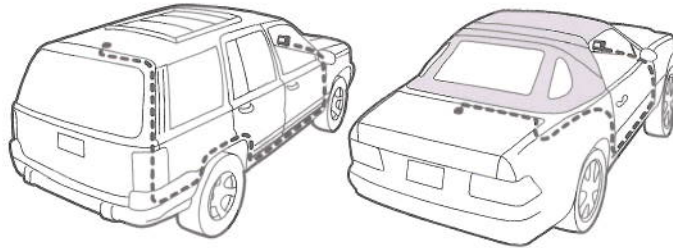

**Pickup Truck:** We recommend mounting the antenna just above the front windshield as shown.



**IMPORTANT!** Consult a professional installer if your vehicle roof or hood is non-metallic (i.e., fiberglass), or you have difficulty finding a location for your antenna.

- 2 Clean the surface of the selected mounting location using the alcohol preparation pad and let it dry thoroughly.

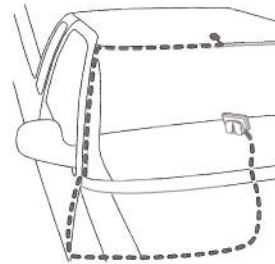

## Vehicle Installation

- 3 If you are installing the antenna at the roof edge, or hood edge, install the Cable Routing Adapter to direct the antenna cable downward.

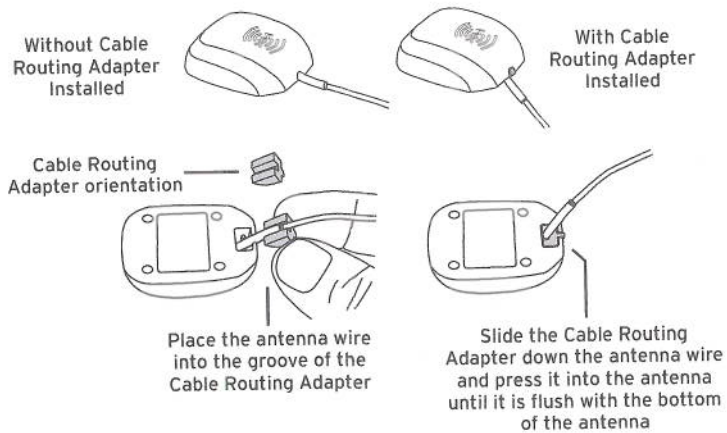

- 4 Place the antenna in the location you selected. Follow the Tips and Cautions shown on the next several pages.

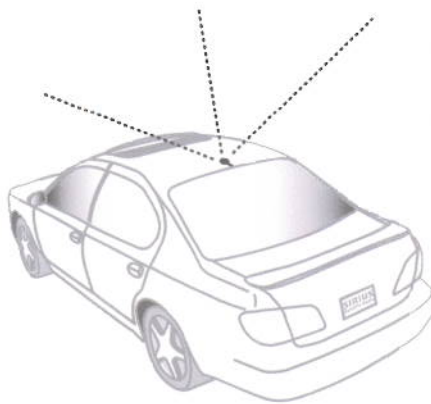

**TIP!** Mount the antenna on the roof (for most vehicles) or trunk (for convertibles) where it has a clear view of the sky in all directions.

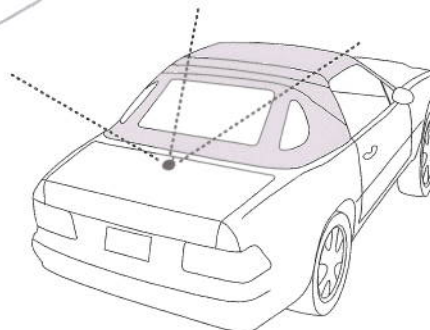



## Vehicle Installation

 **CAUTION!** Don't mount the antenna inside the vehicle, for example, on the dashboard.

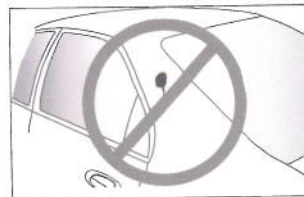

 **CAUTION!** Don't mount the antenna on any of the vehicle's front, back or side pillars.



 **CAUTION!** Don't mount the antenna close to a roof rack. Adjust the rack so it's further away from the antenna or move the antenna closer to the center of the roof.

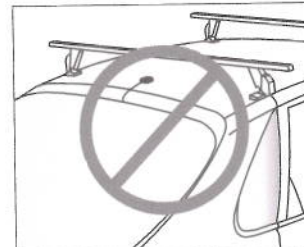





**CAUTION!** Don't mount the antenna close to another antenna. Mount it at least 3 inches away.

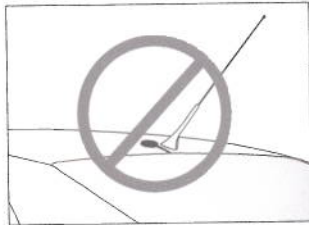

## Vehicle Installation

### Step 4: Route the Magnetic Mount Antenna Cable

Before you begin routing the antenna cable, read these general instructions for how to route and hide the antenna cable. Then route your antenna cable according to the instructions which follow for your specific type of vehicle.

Use a blunt plastic putty knife, a credit card, a plastic knife, or a similar blunt tool to lift the rubber window moulding

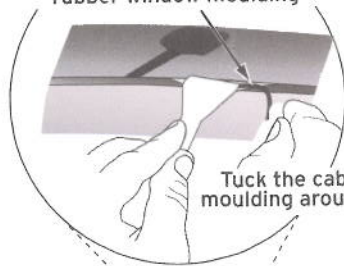

Tuck the cable under the moulding around the window

Feed cable under rubber moulding around window

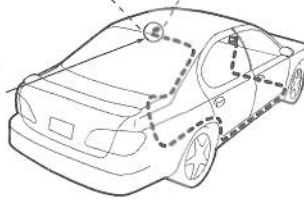

Route cable out from under rear windshield moulding and tuck into weatherstripping around trunk opening  
Avoid sharp bends by running cable through weatherstripping for several inches

Pull weatherstripping from trunk opening

Tuck cable into weatherstripping. Route cable through weatherstripping several inches to avoid sharp bends

Pull cable out of weatherstripping and route through trunk to cabin

Route cable out of window moulding and into weatherstripping around trunk opening

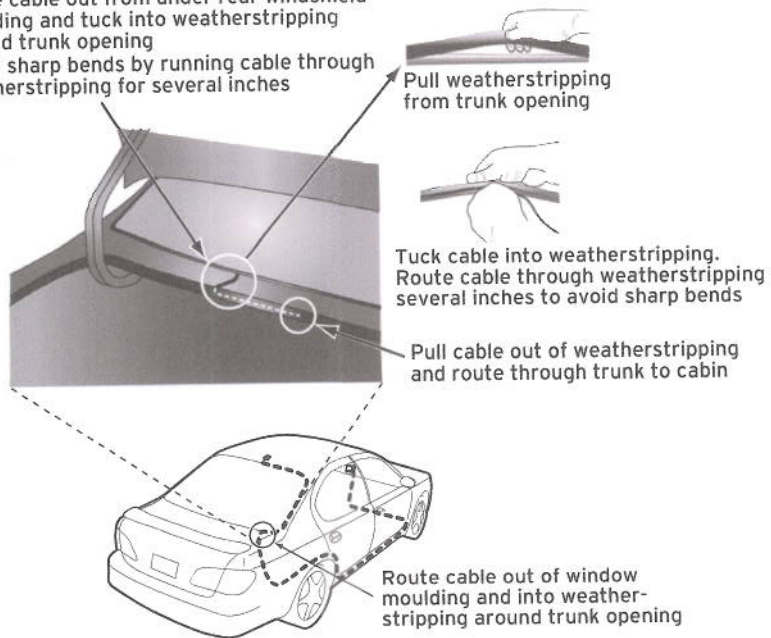

## Vehicle Installation

Bring cable out of weatherstripping and into trunk

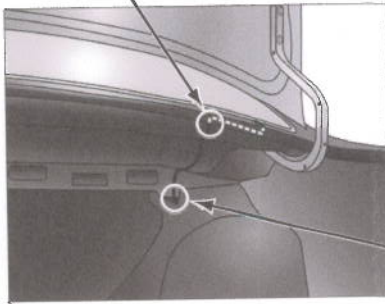

Route cable along trunk wall and into cabin through gap or conduit, along existing wiring harness

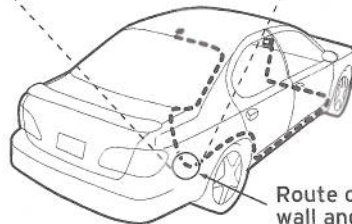

Route cable along trunk wall and into cabin

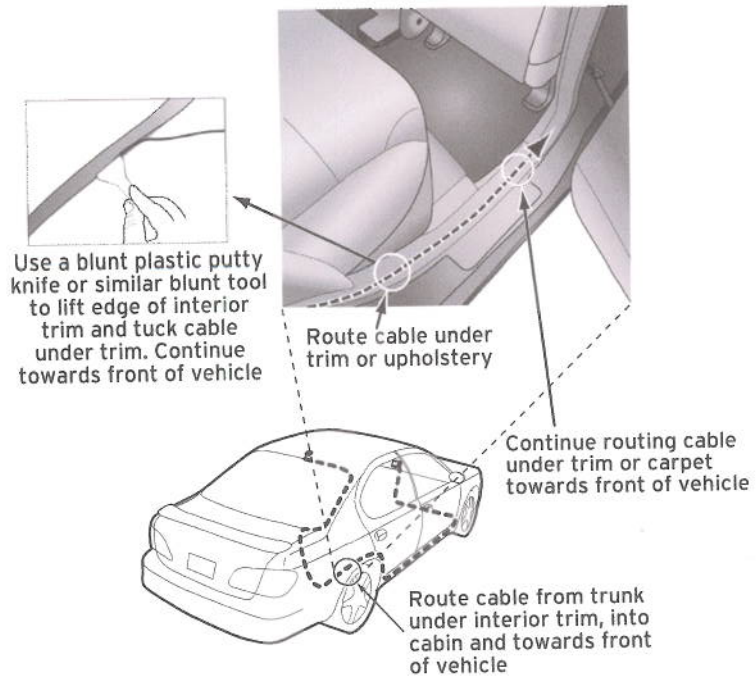

## Vehicle Installation

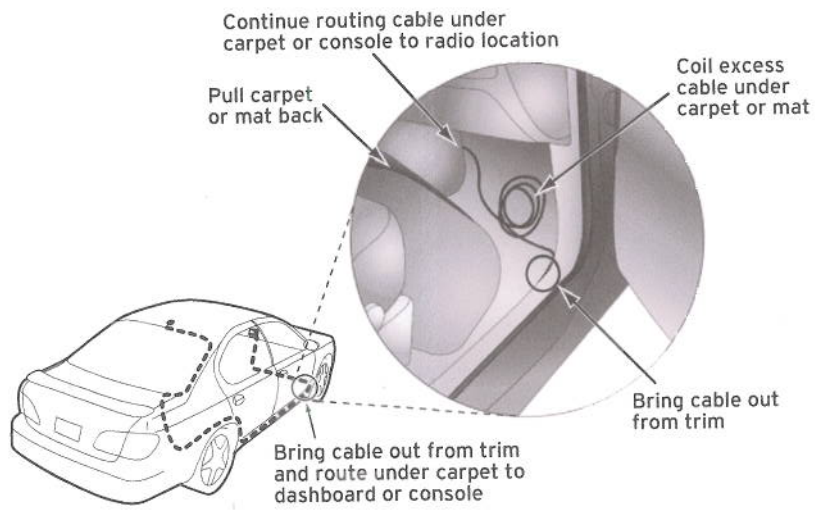

**TIP!** Always be careful to include enough slack in your cable to accommodate open doors or trunk lids. Use things typically found around the home, like electrical tape, to secure cables in areas so that hinges do not pinch the cable with the door. Hide any excess cable in the trim.

### Sedan/Coupe With Antenna Placed at the Rear of the Roof:

- 1 Feed the antenna cable from the antenna underneath the rubber molding around the rear window. Use a blunt plastic putty knife or similar blunt tool to lift the rubber molding around the rear window and tuck the antenna cable underneath the molding. Route the antenna cable around and down the window to the lowest point. If your rear window does not have rubber molding, we recommend consulting a professional installer.
- 2 Route the antenna cable out of the window molding and into the rubber weather stripping around the trunk opening. Lift the weather stripping from the opening and tuck the cable inside it, then replace the weather stripping. To avoid sharp bends in the cable, run the cable inside the weather stripping for a few inches, then remove the cable from the weather stripping inside the trunk. Keep the cable away from hinges, gears, etc., that could damage it.
- 3 Route the cable out from the rubber weather stripping and along the trunk wall. Continue routing the cable into the vehicle cabin through a conduit or along an existing wiring harness.
- 4 Route the cable through the main cabin area under the interior trim, towards the front of the vehicle. Use a blunt plastic putty knife or similar blunt tool to lift the plastic trim just enough to tuck the cable underneath. Avoid side airbag locations on back pillars and above the doors. Airbag locations are marked with "SRS" logos. Be careful not to crimp or cut the cable.

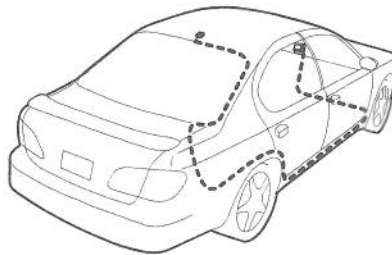

## Vehicle Installation

- 5 Bring the cable out from the trim near the front of the cabin and route it under the carpet toward the dashboard or console. Coil any excess cable in a hidden location, such as under the carpet, keeping it away from any vehicle pedals or controls. Secure the excess cable with wire ties (purchased separately).
- 6 Bring the end of the cable out at the *PowerConnect* Vehicle Dock location. Leave yourself enough cable so you can easily connect it to the antenna connector of the dock.
- 7 Continue with "Step 5: Connect the Magnetic Mount Antenna and *PowerConnect* Power Adapter" on page 37.

### Sedan/Coupe With Antenna Placed at the Front of the Roof

- 1 Feed the antenna cable from the antenna underneath the rubber molding around the windshield. Use a blunt plastic putty knife or similar blunt tool to lift the rubber molding around the windshield and tuck the antenna cable underneath the molding. Route the antenna cable around and down the windshield to the lowest point.
- 2 At the lowest corner of the windshield, route the cable out of the windshield molding and into the rubber weather stripping around the door opening. Lift the weather stripping from the opening and tuck the cable inside it, then replace the weather stripping. Run the cable inside of the weather stripping to the bottom of the door opening.
- 3 Pull the cable out of the weather stripping at the bottom

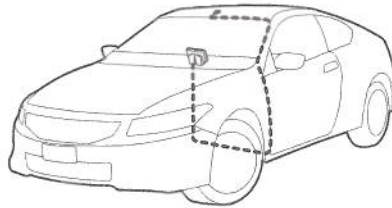



of the door opening and route it under the carpet toward the dashboard. Coil any excess cable in a hidden location, such as under the carpet, keeping it away from any vehicle pedals or controls. Secure the excess cable with wire ties.

- 4 Bring the end of the cable out at the *PowerConnect Vehicle Dock* location. Leave yourself enough cable so you can easily connect it to the antenna connector of the dock.
- 5 Continue with "Step 5: Connect the Magnetic Mount Antenna and *PowerConnect Power Adapter*" on page 37.

#### **Sport Utility Vehicle (SUV)**

- 1 Feed the antenna cable underneath the rubber weather stripping of the rear tailgate window/door and route the cable along the rear hatch. Lift the weather stripping from the opening and tuck the cable inside it, then replace the weather stripping. Pull the cable out from weather stripping and route it into the cabin under the interior trim. Avoid hinges or gears that could crimp or cut the cable.
- 2 Route the cable through the SUV's main cabin area under the interior trim, towards the front of the vehicle. Use a blunt plastic putty knife or similar blunt tool to lift the plastic trim just enough to tuck the cable underneath. Avoid side airbag locations on back pillars and above the doors. Airbag locations are marked with "SRS"

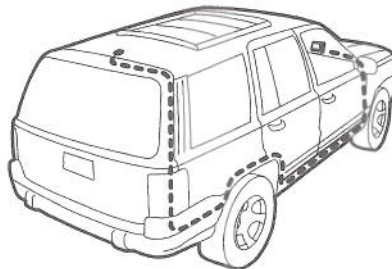

## Vehicle Installation

logos. Be careful not to crimp or cut the cable.

- 3 Bring the cable out from the trim near the front of the cabin and route it under the carpet toward the dashboard or console. Coil any excess cable in a hidden location, such as under the carpet, keeping it away from any vehicle pedals or controls. Secure the excess cable with wire ties (purchased separately).
- 4 Bring the end of the cable out at the *PowerConnect* Vehicle Dock location. Leave yourself enough cable so you can easily connect it to the antenna connector of the dock.
- 5 Continue with "Step 5: Connect the Magnetic Mount Antenna and *PowerConnect* Power Adapter" on page 37.

### Convertible

- 1 Bring the antenna cable from the antenna into the trunk at the front edge of the trunk lid. Keep any bends in the cable loose. Tape or tie the cable along the inside of the trunk lid to the trunk lid hinge strut.
- 2 Allow enough slack in the cable so the trunk lid can easily open and close and keep the cable away from hinges, gears, etc., that could crimp or cut it. Route the cable along the trunk wall and into the cabin through a conduit or along an existing wiring harness.
- 3 Route the cable through the main cabin area under the interior trim, towards the front of the vehicle. Use a blunt plastic putty knife or similar blunt tool to lift the plastic trim just enough to tuck the cable under

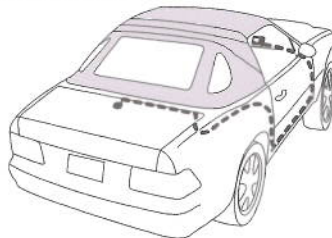

underneath. Avoid side airbag locations on back pillars and above the doors. Airbag locations are marked with "SRS" logos. Be careful not to crimp or cut the cable.

- 4 Bring the cable out from the trim near the front of the cabin and route it under the carpet toward the dashboard or console. Coil any excess cable in a hidden location, such as under the carpet, keeping it away from any vehicle pedals or controls. Secure the excess cable with wire ties (purchased separately).
- 5 Bring the end of the cable out at the *PowerConnect Vehicle Dock* location. Leave yourself enough cable so you can easily connect it to the antenna connector of the dock.
- 6 Continue with "Step 5: Connect the Magnetic Mount Antenna and *PowerConnect Power Adapter*" on page 37.

#### Pickup Truck

- 1 Use a blunt plastic putty knife or similar blunt tool to lift the rubber molding around the windshield and tuck the antenna cable underneath it.
- 2 Continue tucking the cable underneath the windshield molding around the windshield to the lowest corner.
- 3 At the lowest corner of the windshield, route the cable out of the windshield molding and into the rubber weather stripping around the door opening. Lift the weather stripping from the opening and tuck the cable inside it, then replace

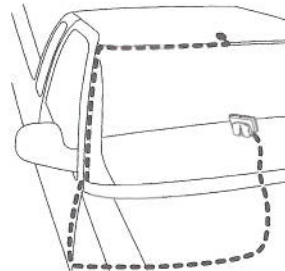

## Vehicle Installation

the weather stripping. Run the cable inside of the weather stripping to the bottom of the door opening.

- 4** Pull the cable out of the weather stripping at the bottom of the door opening and route it under the carpet toward the dashboard. Coil any excess cable in a hidden location, such as under the carpet, keeping it away from any vehicle pedals or controls. Secure the excess cable with wire ties.
- 5** Bring the end of the cable out at the *PowerConnect Vehicle Dock* location. Leave yourself enough cable so you can easily connect it to the antenna connector of the dock.
- 6** Continue with "Step 5: Connect the Magnetic Mount Antenna and *PowerConnect Power Adapter*" on page 37.

**Step 5: Connect the Magnetic Mount Antenna and  
PowerConnect Power Adapter**

- 1** Plug the Magnetic Mount Antenna into the silver ANT connector on the *PowerConnect* Vehicle Dock.

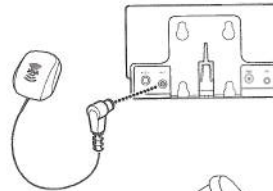

- 2** Insert the *PowerConnect* Power Adapter into your vehicle's cigarette lighter or power adapter socket.

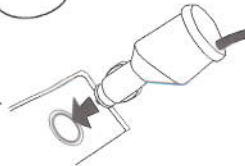

- 3** Plug the *PowerConnect* Power Adapter into the red PWR connector on the dock.

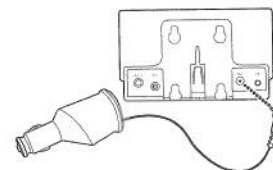

## Vehicle Installation

### Step 6: Connect the Audio

To play XM audio through your vehicle's stereo or FM radio, decide on one of the following audio connection options:

- **Option 1: Best:** Use the provided **Aux In Cable** if your vehicle's stereo system has an auxiliary input connection or jack. Refer to your vehicle's owners manual to find the location of the auxiliary input jack, or consult the vehicle dealer.



**TIP!** The auxiliary input jack may be located on the face plate of the vehicle radio, on the back of the radio, anywhere on the front dash panel, inside the glove compartment, or inside the center console in between the front seats.

- **Option 2: Better:** Use a **Cassette Adapter** if your vehicle has a built-in cassette player. Cassette Adapters are sold separately and can be purchased from an electronics retailer, or go to [www.siriusxm.com/accessories](http://www.siriusxm.com/accessories).
- **Option 3: Good:** Use the **PowerConnect** feature of XMH. **PowerConnect** plays the audio through your vehicle's FM radio.
- **Option 4: Best:** Use the **FM Direct Adapter**. If none of the previous three audio connection options will work in your vehicle, then you will need to use the FM Direct Adapter (FMDA) (sold separately). The FMDA needs to be installed by a professional installer and directly connects XMH to your vehicle's FM radio. To learn more, check with the retailer where you bought your Radio, or go to [www.siriusxm.com/accessories](http://www.siriusxm.com/accessories).

Follow the installation instructions in the next several sections for the audio connection option that you have selected.

### Option 1: Aux In Cable Installation Instructions

- 1 Plug one end of the Aux In Cable into the **green AUDIO** connector on the dock.



- 2 Plug the other end into the auxiliary input jack of your vehicle's stereo system.
- 3 Attach the dock to the mount.
- 4 Insert your XMH into the dock.
- 5 Power on your XMH by pressing the **Power button**.

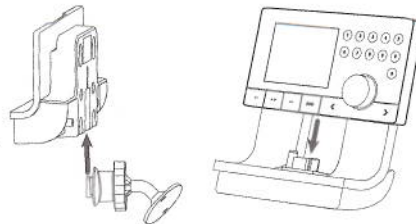

- 6 Be sure the vehicle is outside and the antenna has a clear view of the sky. Verify that you are receiving the XM signal. There should at least be one bar on the lower left corner of the main display screen that denotes antenna signal strength. You can also press **menu** and then turn the **Rotary Knob** to scroll to and highlight **Signal Indicator**. Press the **Select button**. The **Satellite** and **Terrestrial** bars show the strength of the signal being received. If the signal reception is

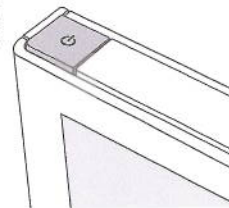

## Vehicle Installation

good, press and hold **menu** to return to the main display screen.

- 7** Ensure XMH is tuned to channel 1, the XM Preview channel. Upon power up, XMH should tune to channel 1 by default, when it's not yet activated. If it's not on channel 1, refer to "Listening to Satellite Radio" on page 55 to learn about how to tune a channel.
- 8** Turn on your vehicle's stereo system. Set it to play from the auxiliary input source. You should hear XM channel 1 through your vehicle's stereo system. You are now ready to activate your XMH.
- 9** The audio level output of XMH can be increased or decreased as necessary to match the audio levels of other sources in your vehicle. Refer to "Set Audio Level" on page 81.

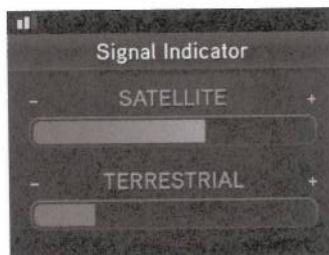

If the signal reception is good, showing at least one bar in the lower left corner of the display, but there is no XM audio, be sure the vehicle's stereo system is set to the auxiliary input source (step 4). Also be sure that the audio level is set high enough to be heard (step 5). Refer to "Troubleshooting" on page 92 for additional help.



### Option 2: Cassette Adapter Installation Instructions

- 1 Plug the Cassette Adapter into the **green AUDIO** connector on the dock.
- 2 Insert the Cassette Adapter into the vehicle's cassette deck. You may need to turn on your vehicle's stereo system in order to do so.

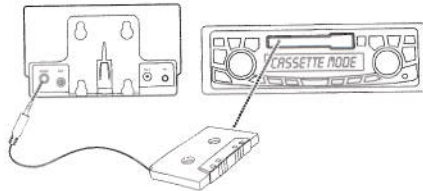

- 3 Attach the dock to the mount.
- 4 Insert your XMH into the dock.
- 5 Power on your XMH by pressing the **Power button**.

- 6 Be sure the vehicle is outside and the antenna has a clear view of the sky. Verify that you are receiving the XM signal. There should at least be one bar on the lower left corner of the main display screen that denotes antenna signal strength. You can also press **menu** and then turn the **Rotary Knob** to scroll to and highlight **Signal Indicator**. Press the **Select button**. The Satellite and Terrestrial bars show the strength of the signal being received. If the signal reception is

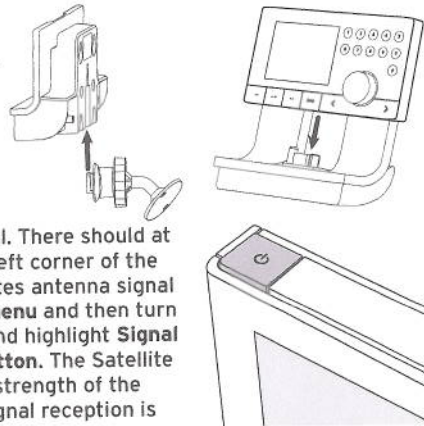

## Vehicle Installation

good, press and hold **menu** to return to the main display screen.

- 7 Ensure XMH is tuned to channel 1, the XM Preview channel. Upon power up, XMH should tune to channel 1 by default, when it's not yet activated. If it's not on channel 1, refer to "Listening to Satellite Radio" on page 55 to learn about how to tune a channel.
- 8 Turn on your vehicle's stereo system. Set it to play from the auxiliary input source. You should hear XM channel 1 through your vehicle's stereo system. You are now ready to activate your XMH.
- 9 The audio level output of XMH can be increased or decreased as necessary to match the audio levels of other sources in your vehicle. Refer to "Set Audio Level" on page 81.

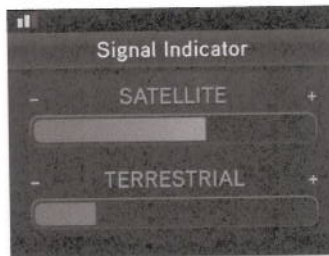

If the signal reception is good, showing at least one bar in the lower left corner of the display, but there is no XM audio, be sure the vehicle's stereo system is set to the cassette source (step 4). Also be sure that the audio level is set high enough to be heard (step 5). Refer to "Troubleshooting" on page 92 for additional help.

### Option 3: PowerConnect Installation Instructions

- 1 Attach the dock to the mount.
- 2 Insert your XMH into the dock.
- 3 Power on your XMH by pressing the **Power button**.

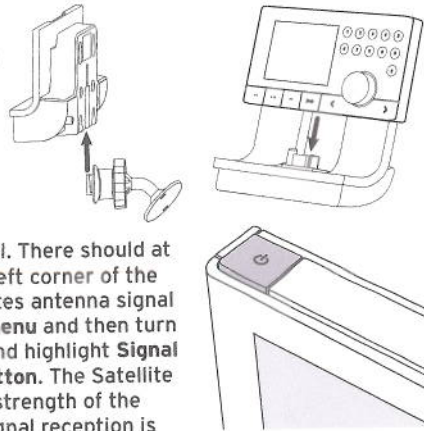

- 4 Be sure the vehicle is outside and the antenna has a clear view of the sky. Verify that you are receiving the XM signal. There should at least be one bar on the lower left corner of the main display screen that denotes antenna signal strength. You can also press **menu** and then turn the **Rotary Knob** to scroll to and highlight **Signal Indicator**. Press the **Select button**. The Satellite and Terrestrial bars show the strength of the signal being received. If the signal reception is good, press and hold **menu** to return to the main display screen.

- 5 You'll first need to find an available FM channel. An available FM channel is one that's not being used by an FM radio station in your area. When you tune your FM radio to an available channel, you should only hear static or silence - not talk or music. We recommend one of the following methods to find an available FM channel:

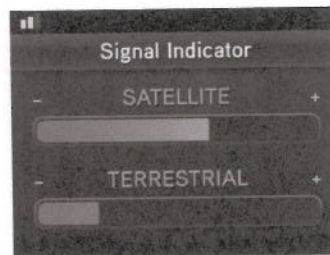

## Vehicle Installation

- a. Use the SiriusXM FM Channel Finder at [www.siriusxm.com/fmchannel](http://www.siriusxm.com/fmchannel). Go to the website and enter your zip code. The Channel Finder will suggest a list of available FM channels in your area. For convenience, write down or print out the list.

**OR**

- b. Manually tune through your local FM channels on your vehicle's FM radio. Locate and create a list of channels that aren't being used by any FM radio station. Write down the list. Once you have created your list of available FM channels, you will need to find the one that provides the best match for XMH.



**TIP!** You'll need to use the 'Manual' tune function on your vehicle's FM radio to tune through every FM channel one-by-one. Turn on your vehicle's FM radio. Start at 88.1 and use the 'Manual' tune function on your vehicle's FM radio to tune through each FM channel one-by-one (88.1 followed by 88.3 etc.) to locate channels that aren't being used by a local FM radio station. Write down each FM channel that has only static or silence on it, until you reach 107.9.

- 6 Ensure XMH is tuned to channel 1, the XM Preview channel. Upon power up, XMH should tune to channel 1 by default, when it's not yet activated. If it's not on channel 1, refer to "Listening to Satellite Radio" on page 55 to learn about how to tune a channel.
- 7 Pick the first FM channel on your list from step 5. Turn on your vehicle's FM radio (if you have not already done so) and tune it to this FM channel.



**NOTE!** If you are using the Vehicle Dock from the Universal Xpress Car Kit instead of the PowerConnect Vehicle Dock which came with your XMH, you will

have to disable AUX Detect. Refer to "Using the Vehicle Dock From the Universal Xpress Car Kit" on page 88, and complete the additional instructions before continuing with the next step. The audio connection will be through your vehicle's FM radio, but it is not PowerConnect.

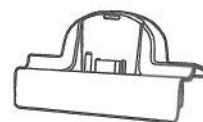

MATCH FM CHANNELS

**8** Set your XMH to transmit on the same FM channel that you have selected in step 7:

- i. Press **menu**.
- ii. Turn the **Rotary Knob** to scroll to and highlight **FM Settings** and press the **Select** button.
- iii. **FM Channels** will be highlighted. If it is not highlighted, turn the **Rotary Knob** to scroll to and highlight **FM Channels**. Press the **Select** button.
- iv. Turn the **Rotary Knob** to scroll to and highlight the storage location **FM 2** and press the **Select** button.
- v. Tune to the available FM channel you choose in step 3. Press **<** and **>** to tune in steps of .2, i.e., 99.3

