



onyX^{EZ} USER GUIDE

Dock & Play Radio
with Vehicle Kit



Table of Contents

Introduction	3
Features	3
Safety and Care Information.....	4
What's in the Box?	6
Onyx EZ Functions	7
PowerConnect Vehicle Dock.....	8

Vehicle Installation

Step 1: Choose a Location for Your Radio	10
Step 2: Install the Dash or Vent Mount	12
Step 3: Mount the Magnetic Mount Antenna	16
Step 4: Route the Magnetic Mount Antenna Cable	22
Step 5: Connect the Magnetic Mount Antenna and PowerConnect Power Adapter	33
Step 6: Connect the Audio	34

Subscribe

Using Your Onyx EZ

The Main Display	45
Navigation Basics	46
Listening to Satellite Radio	48
FM Presets	52
Parental Controls.....	54

Where Else Can You Use Your Onyx EZ?

Configuring Your Onyx EZ

Radio ID.....	60
Find Available FM Channels in Your Area	61
Set and Select an FM Channel	63
Jump Settings	66
Set Brightness or Contrast	67
Set Audio Level	68
Signal Indicator	69
Factory Settings	70
Demo Mode	73
Auto Shut Off.....	74
Using the Vehicle Dock From the Universal Xpress Car Kit.....	76
Turn FM Transmitter On/Off	77

Troubleshooting

Product Specifications

Patent and Environmental Information

FCC Statement

Copyrights and Trademarks.....

Owners Record

Introduction

Features

Thank you for purchasing the XM Onyx EZ with Vehicle Kit!

XM Onyx EZ has these exciting features to enhance your overall experience:

- Hear SiriusXM through your existing vehicle radio with easy, do-it-yourself installation.
- View artist name, song title, and channel information on the large color display.
- Store your favorite channels for one touch access.
- Easily lock and unlock channels with mature content.
- One-Touch Jump™ to traffic and weather for the city of your choice from a list of 22 of the most congested cities, or to the previous channel to which you were listening.
- Listen in multiple vehicles, at home, in the office or outdoors - all with just one subscription.
- Vehicle Kit included — add accessories for your home, office, or other vehicles.

Please read the entire User Guide before using your Onyx EZ!

Introduction

Safety and Care Information



IMPORTANT! Self installation instructions and tips are provided for your convenience. It is your responsibility to determine if you have the knowledge, skills, and physical ability required to properly perform an installation. SiriusXM shall have no liability for damage or injury resulting from the installation or use of any SiriusXM or third party products. It is your responsibility to ensure that all products are installed in adherence with local laws and regulations and in such a manner as to allow a vehicle to be operated safely and without distraction. SiriusXM product warranties do not cover the installation, removal or reinstallation of any product.

- Do not expose to extreme temperatures (above 140°F or below -4°F, or above 60°C or below -20°C).
- Do not expose to moisture. Do not use device near or in water. Do not touch the device with wet hands.
- Do not let any foreign matter spill into device.
- Do not store in dusty areas.
- Do not expose to chemicals such as benzene and thinners. Do not use liquid or aerosol cleaners. Clean with a soft damp cloth only.
- Do not expose to direct sunlight for a prolonged period of time, and do not expose to fire, flame, or other heat sources.
- Do not try to disassemble and/or repair device yourself.
- Do not drop your device or subject it to severe impact.
- Do not place heavy objects on device.
- Do not subject device to excessive pressure.
- If the LCD screen is damaged, do not touch the liquid crystal fluid.

Introduction

Warning!

- Opening the case may result in electric shock.
- If the liquid crystal fluid comes in contact with your skin, wipe the skin area with a cloth and then wash the skin thoroughly with soap and running water. If the liquid crystal fluid comes into contact with your eyes, flush the eyes with clean water for at least 15 minutes and seek medical care. If the liquid crystal fluid is ingested, flush your mouth thoroughly with water. Drink large quantities of water, and induce vomiting. Seek medical care.
- Make sure that you insert the *PowerConnect* Power Adapter all the way into the vehicle's cigarette lighter or power adapter socket.
- If you are using *PowerConnect* as your audio connection option, it is advisable not to insert a multi-outlet adapter into the same vehicle cigarette lighter or power adapter socket to simultaneously power other devices. Some multi-outlet adapters can prevent the *PowerConnect* feature from working properly.
- When using this product, it is always important to keep your eyes on the road and hands on the steering wheel. Not doing so could result in personal injury, death, and/or damage to your device, accessories, and/or to your vehicle or other property.
- Vehicle installation, service activation, and Radio configuration functions should not be performed while driving. Park your vehicle in a safe location before beginning installation.
- This product contains chemicals known to the State of California to cause cancer and birth defects or other reproductive harm.

Your device should be placed in your vehicle where it will not interfere with the function of safety features, e.g., deployment of airbags. Failure to correctly place device may result in injury to you or others, if the unit becomes detached during an accident and/or obstructs the deployment of an airbag.

Introduction

What's in the Box?

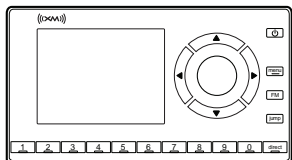

Onyx EZ Radio

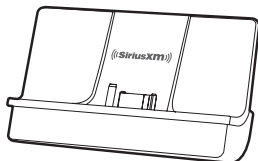

PowerConnect™ Vehicle Dock

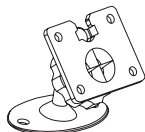

Dash Mount



Aux In Cable

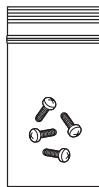

Screws (4)

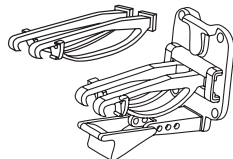

Vent Mount and
Extended Vent Clamps



Cable
Routing Adapter

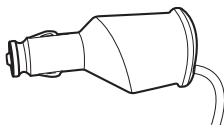

PowerConnect Power
Adapter



Magnetic Mount
Antenna



Antenna & Dash Mount
Alcohol Preparation Pads

Introduction

Onyx EZ Functions

Up and Down Buttons

Press to preview and tune to channels through the channel lineup; also press to scroll through lists and highlight menu items.

Left and Right Buttons

Press to search for channels by category.

Power Button

Press to turn Radio on and off.

Select Button

Press to confirm selection of highlighted items in a menu or list.

Menu Button

Press to access advanced features and configuration options; in configuration options, press and hold to return to main display screen.

FM Button

Press to access and cycle through FM presets.

Jump Button

Press to directly access traffic and weather for the city of your choice; or press it to go back to the previous channel to which you were listening.

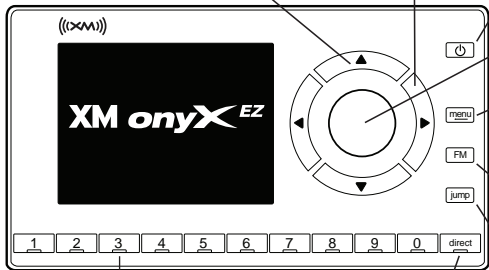

Number Buttons

Press to tune to a stored favorite channel, press and hold to store a favorite channel; also enter a channel number.

Direct Button

Press first before entering the channel number, to directly tune to a channel.

Introduction

PowerConnect Vehicle Dock

Color-Coded Connections

The color-coded *PowerConnect* Vehicle Dock makes it simple to connect. Just match the colors on the cable ends to the colors on the dock to see what goes where.

Rear View

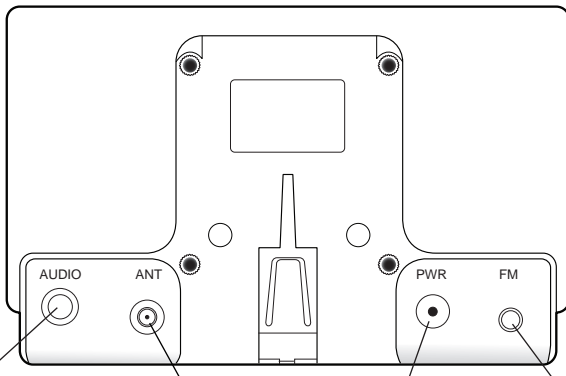

AUDIO (Green)
Connection for Aux In
Cable or optional
Cassette Adapter
(sold separately).

ANT (Silver)
Connection for
the Magnetic
Mount Antenna.

PWR (Red)
Connection for
PowerConnect
Power Adapter.

FM (Blue)
Connection for
optional FM
Direct Adapter
(sold separately).

Introduction

Wire Guide

The *PowerConnect* Vehicle Dock has a wire guide at the top rear that can help you to organize the cables and wires connected to the dock. If you need to bring a cable or wire from one side of the dock to the other, utilize the wire guide by looping the cable through the wire guide as shown.

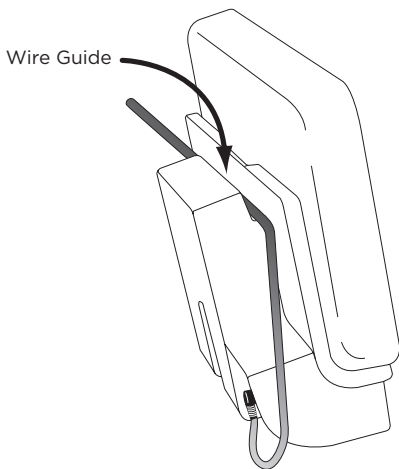

Vehicle Installation



WARNING! DO NOT attempt to install Onyx EZ while driving. Park your vehicle in a safe location before beginning installation.

Step 1: Choose a Location for Your Radio

When installing Onyx EZ in your vehicle, choose a location where it will not block your vision, interfere with the controls, or obstruct the air bag. The location should be easily accessible and provide good visibility of the display, and should not be located where it will be in direct sunlight, which will affect the visibility of the display screen.

Several examples of Onyx EZ mounted in a vehicle are shown: **A** is the on dash method using the Dash Mount, and **B** is the vent clip method using the Vent Mount.

Option 1

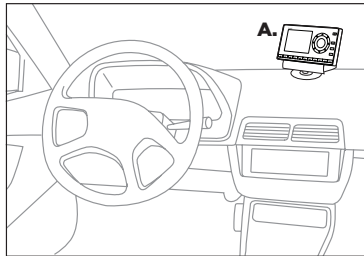

Option 2

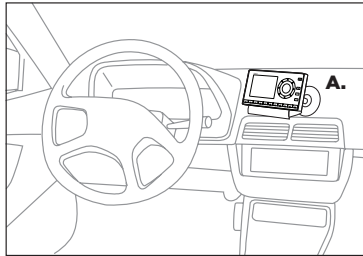

Vehicle Installation

Option 3

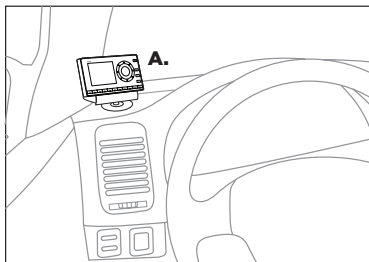

Option 4

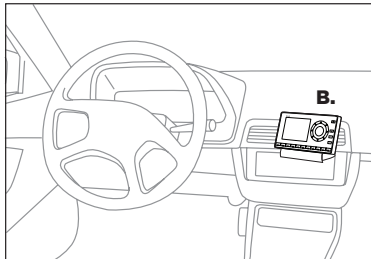

Option 5

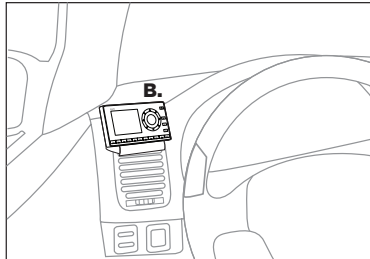

Vehicle Installation

Step 2: Install the Dash or Vent Mount

Follow the instructions on the next several pages for the mounting method you have selected.



NOTE! The *PowerConnect* Vehicle Dock included with Onyx EZ is compatible with the T-slot style Dash and Vent Mounts. If you have an existing Dash Mount or Vent Mount in your vehicle, you can continue to use it with this dock, and skip this step.

Installing the Dash Mount:



CAUTION! The adhesive used on the Dash Mount may be difficult to remove. Do not install this mount on leather surfaces (contact your automobile dealership if you are unsure about your dash surface), and make sure the air temperature is at least 60°F (15°C) during installation. If it's not at least 60°F, turn on the heater in your vehicle to bring the temperature up to 60°F.

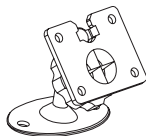

1. Locate a flat surface for the Dash Mount. Make sure there is ample room for the *PowerConnect* Vehicle Dock and Onyx EZ Radio when installed.
2. Set the orientation of the Dash Mount before adhering it. Loosen the knob and adjust the adhesive foot for the location you selected in “Step 1: Choose a Location for Your Radio” on page 10.
 - Option 1 & Option 3 should be oriented as **I**.
 - Option 2 should be oriented as **II**.
3. The dock mounting plate can

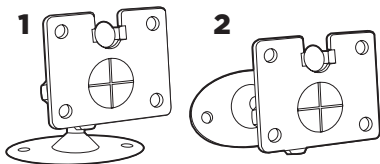

Vehicle Installation

be tilted in different directions. Adjust as necessary for your particular vehicle. When the orientation is correct, tighten the knob.

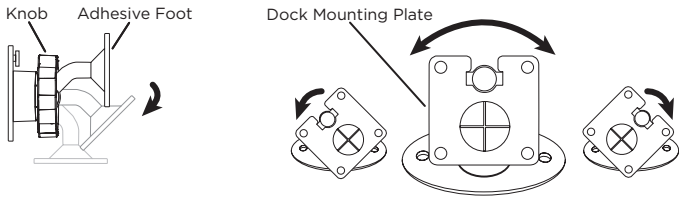

4. Attach the Dash Mount to the *PowerConnect* Vehicle Dock using the 4 provided screws.
5. Before you attach the Dash Mount to the dash, skip ahead and finish the remainder of the vehicle installation so that the cables are attached to the dock.
6. Once the cables have been attached to the dock, clean the mounting surface in the vehicle with the alcohol preparation pad and let it dry thoroughly.
7. Peel off the adhesive liner. Position, press, and hold the Dash Mount in place for 30 seconds.

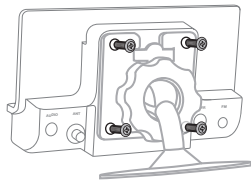

IMPORTANT! Allow the Dash Mount adhesive to cure (dry) for a minimum of 2-4 hours before using the mount. The best adhesion occurs after 24 hours.



TIP! To remove the Dash Mount, carefully lift the adhesive pad with your fingers or a spoon. Warming the pad with a hair dryer for several minutes will help soften the adhesive.

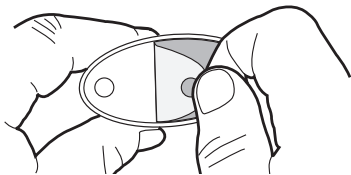

Vehicle Installation

Installing the Vent Mount:



IMPORTANT! To make the cable connections easier, wait until after you have connected all the cables to the dock before you attach the Vent Mount to a vent.

1. Locate a vent with horizontal louvers sturdy enough to hold your *PowerConnect* Vehicle Dock and Onyx EZ Radio.
2. If the vent louvers in your vehicle are recessed, you may need to use the longer vent clamps with the Vent Mount. If so, remove the shorter vent clamps and install the longer ones into the Vent Mount. Be sure to observe the orientation of the vent clamps as shown.

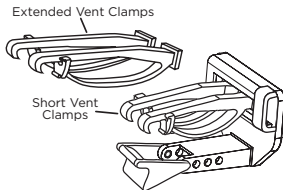

Remove End Cap

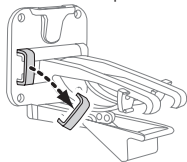

Slide Short Vent Clamps Out

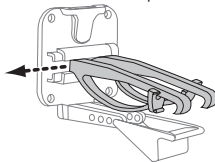

Slide Extended Vent Clamps In

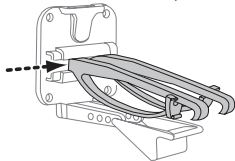

Replace End Cap

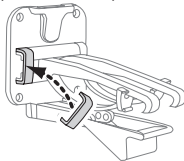

Vehicle Installation

3. Attach the Vent Mount to the *PowerConnect Vehicle Dock* using the 4 provided screws.
4. Before you attach the Vent Mount to the vent, skip ahead and finish the remainder of the vehicle installation so that the cables are attached to the dock.

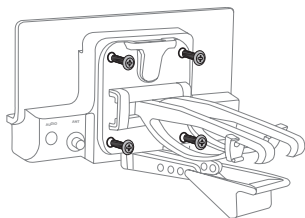

Note! For greater clarity, the next illustration does not show the dock attached to the Vent Mount, however, the dock should be attached before continuing.

5. Once the cables have been attached to the dock, push the Vent Mount onto the vehicle vent as shown (1) until it hooks on the rear of the vent louver (2).

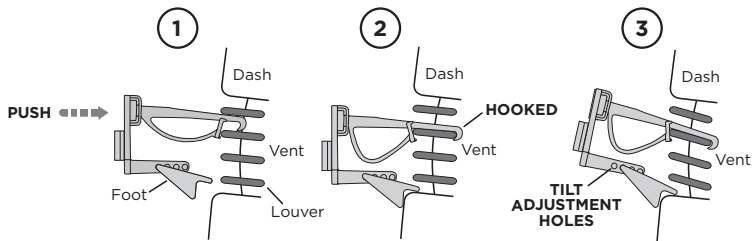

6. Rest the foot against the bottom of the vent (2), and adjust the tilt of the Vent Mount by repositioning the foot to a different adjustment hole (3).



TIP! To remove the Vent Mount, push the mount into the vent. Then lift up until disengaged from the rear of the vent louver, and remove the Vent Mount.

Vehicle Installation

Step 3: Mount the Magnetic Mount Antenna

Mount the Magnetic Mount Antenna on the outside of your vehicle, on a horizontal surface that will always face the sky. The antenna contains a strong magnet which will stick to any metal part of your vehicle, but will not damage the vehicle.

To install the Magnetic Mount Antenna:

1. Choose the best location for your antenna considering your vehicle type. Pay particular attention to any accessories that you may have like luggage racks and how frequently you may use them.



Sedan/Coupe: We recommend mounting the antenna just above either the front windshield or the back window as shown.

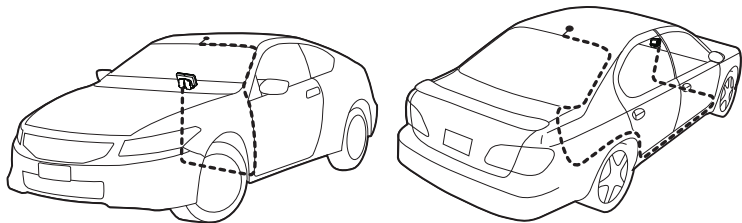

Vehicle Installation

SUV: We recommend mounting the antenna at the rear of the roof as shown.

Convertible: We recommend mounting the antenna at the leading edge of the trunk as shown.

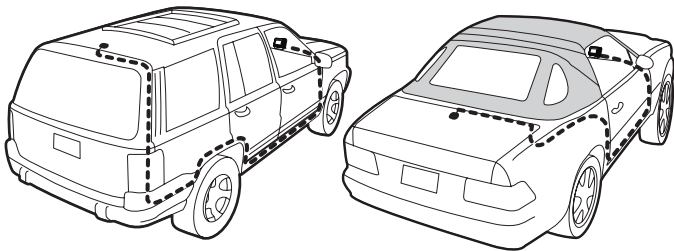

Pickup Truck: We recommend mounting the antenna just above the front windshield as shown.



IMPORTANT! Consult a professional installer if your vehicle roof or hood is non-metallic (i.e., fiberglass), or you have difficulty finding a location for your antenna.

2. Clean the surface of the selected mounting location using the alcohol preparation pad and let it dry thoroughly.

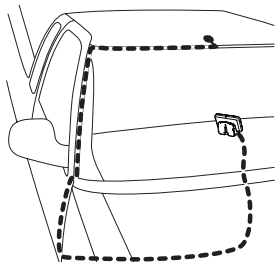

Vehicle Installation

- 3** If you are installing the antenna at the roof edge, or hood edge, install the Cable Routing Adapter to direct the antenna cable downward.

Without Cable
Routing Adapter
Installed



With Cable
Routing Adapter
Installed



Cable Routing
Adapter orientation

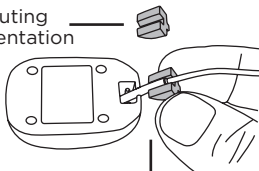

Place the antenna
wire into the groove
of the Cable Routing
Adapter

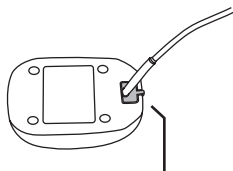

Slide the Cable Routing
Adapter down the antenna
wire and press it into the
bottom of the antenna

Vehicle Installation

- 4 Place the antenna in the location you selected. Follow the Tips and Cautions shown on the next several pages.

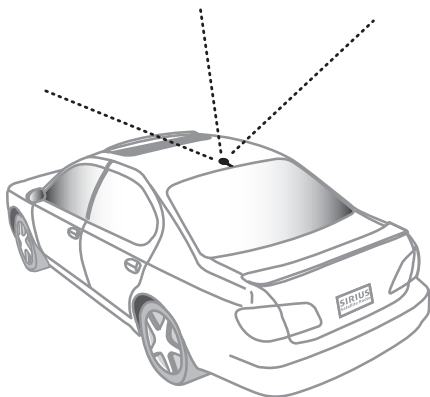

TIP! Mount the antenna on the roof (for most vehicles) or trunk (for convertibles) where it has a clear view of the sky in all directions.

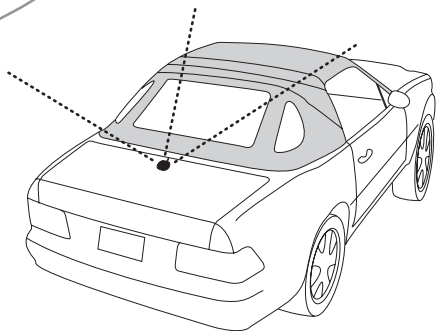

Vehicle Installation



CAUTION! Don't mount the antenna inside the vehicle, for example, on the dashboard.

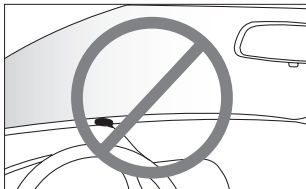

CAUTION! Don't mount the antenna on any of the vehicle's front, back or side pillars.

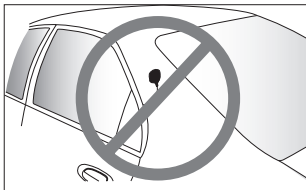

CAUTION! Don't mount the antenna close to a roof rack. Adjust the rack so it's further away from the antenna or move the antenna closer to the center of the roof.



Vehicle Installation



CAUTION! Don't mount the antenna close to another antenna. Mount it at least 3 inches away.

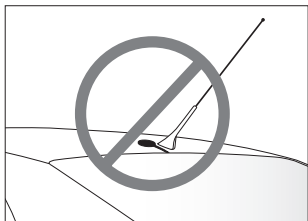

Vehicle Installation

Step 4: Route the Magnetic Mount Antenna Cable

Before you begin routing the antenna cable, read these general instructions for how to route and hide the antenna cable. Then route your antenna cable according to the instructions which follow for your specific type of vehicle.

Use a blunt plastic putty knife, a credit card, a plastic knife, or a similar blunt tool to lift the rubber window moulding

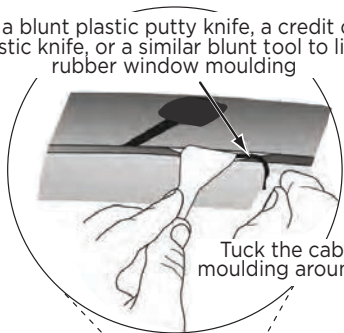

Tuck the cable under the moulding around the window

Feed cable under rubber moulding around window

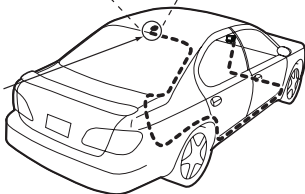

Vehicle Installation

Route cable out from under rear windshield moulding and tuck into weatherstripping around trunk opening
Avoid sharp bends by running cable through weatherstripping for several inches

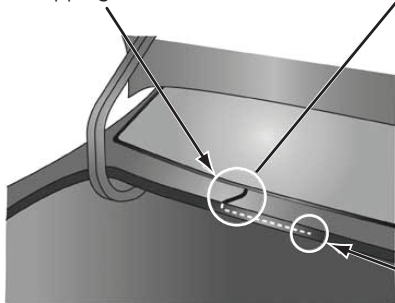

Pull weatherstripping from trunk opening



Tuck cable into weatherstripping. Route cable through weatherstripping several inches to avoid sharp bends

Pull cable out of weatherstripping and route through trunk to cabin

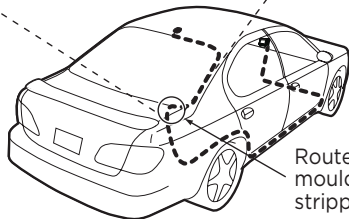

Route cable out of window moulding and into weatherstripping around trunk opening

Vehicle Installation

Bring cable out of weatherstripping and into trunk

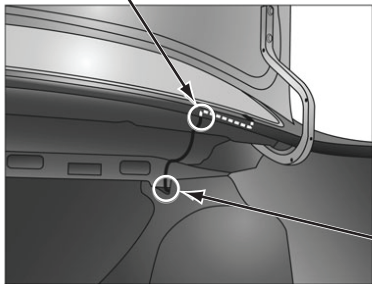

Route cable along trunk wall and into cabin through gap or conduit, along existing wiring harness

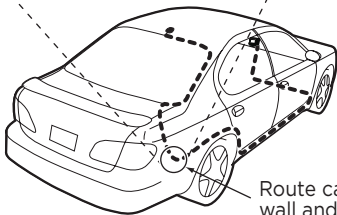

Route cable along trunk wall and into cabin

Vehicle Installation

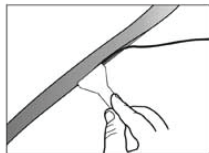

Use a blunt plastic putty knife or similar blunt tool to lift edge of interior trim and tuck cable under trim. Continue towards front of vehicle

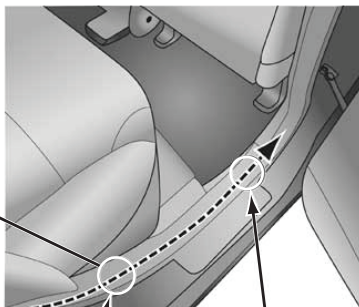

Route cable under trim or upholstery

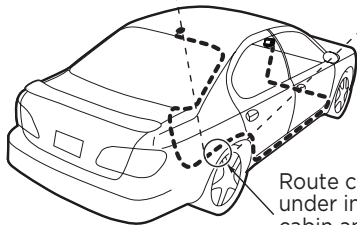

Route cable from trunk under interior trim, into cabin and towards front of vehicle

Continue routing cable under trim or carpet towards front of vehicle

Vehicle Installation

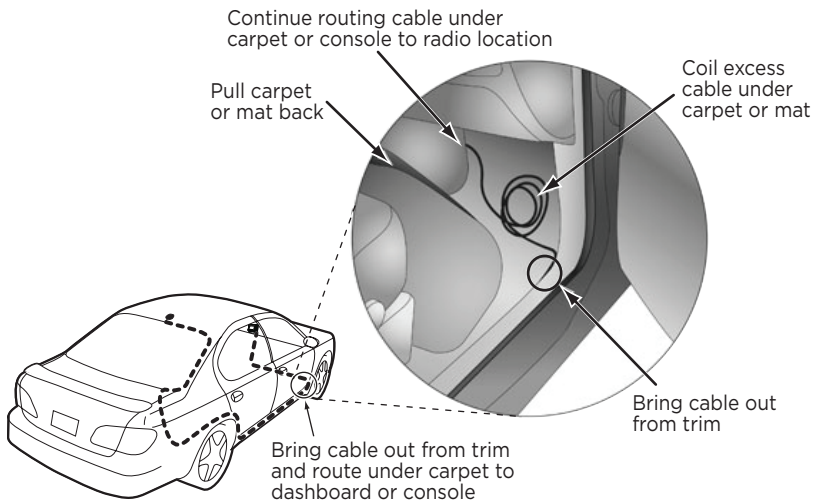

TIP! Always be careful to include enough slack in your cable to accommodate open doors or trunk lids. Use things typically found around the home, like electrical tape, to secure cables in areas so that hinges do not pinch the cable with the door. Hide any excess cable in the trim.

Vehicle Installation

Sedan/Coupe With Antenna Placed at the Rear of the Roof:

- 1.** Feed the antenna cable from the antenna underneath the rubber molding around the rear window. Use a blunt plastic putty knife or similar blunt tool to lift the rubber molding around the rear window and tuck the antenna cable underneath the molding. Route the antenna cable around and down the window to the lowest point. If your rear window does not have rubber molding, we recommend consulting a professional installer.
- 2.** Route the antenna cable out of the window molding and into the rubber weather stripping around the trunk opening. Lift the weather stripping from the opening and tuck the cable inside it, then replace the weather stripping. To avoid sharp bends in the cable, run the cable inside the weather stripping for a few inches, then remove the cable from the weather stripping inside the trunk. Keep the cable away from hinges, gears, etc., that could damage it.
- 3.** Route the cable out from the rubber weather stripping and along the trunk wall. Continue routing the cable into the vehicle cabin through a conduit or along an existing wiring harness.
- 4.** Route the cable through the main cabin area under the interior trim, towards the front of the vehicle. Use a blunt plastic putty knife or similar blunt tool to lift the plastic trim just enough to tuck the cable under underneath. Avoid side airbag locations on back pillars and above the doors. Airbag locations are marked with “SRS”

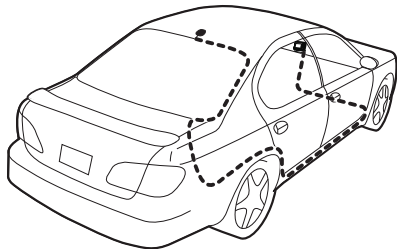

Vehicle Installation

logos. Be careful not to crimp or cut the cable.

5. Bring the cable out from the trim near the front of the cabin and route it under the carpet toward the dashboard or console. Coil any excess cable in a hidden location, such as under the carpet, keeping it away from any vehicle pedals or controls. Secure the excess cable with wire ties (purchased separately).
6. Bring the end of the cable out at the *PowerConnect* Vehicle Dock location. Leave yourself enough cable so you can easily connect it to the antenna connector of the dock.
7. Continue with “Step 5: Connect the Magnetic Mount Antenna and *PowerConnect* Power Adapter” on page 33.

Sedan/Coupe With Antenna Placed at the Front of the Roof

1. Feed the antenna cable from the antenna underneath the rubber molding around the windshield. Use a blunt plastic putty knife or similar blunt tool to lift the rubber molding around the windshield and tuck the antenna cable underneath the molding. Route the antenna cable around and down the windshield to the lowest point.
2. At the lowest corner of the windshield, route the cable out of the windshield molding and into the rubber weather stripping around the door opening. Lift the weather stripping from the opening and tuck the cable inside it, then replace the weather stripping. Run the cable inside of the weather stripping to the bottom of the door

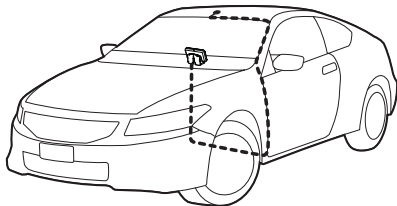

Vehicle Installation

opening.

3. Pull the cable out of the weather stripping at the bottom of the door opening and route it under the carpet toward the dashboard. Coil any excess cable in a hidden location, such as under the carpet, keeping it away from any vehicle pedals or controls. Secure the excess cable with wire ties.
4. Bring the end of the cable out at the *PowerConnect Vehicle Dock* location. Leave yourself enough cable so you can easily connect it to the antenna connector of the dock.
5. Continue with “Step 5: Connect the Magnetic Mount Antenna and *PowerConnect Power Adapter*” on page 33.

Sport Utility Vehicle (SUV)

1. Feed the antenna cable underneath the rubber weather stripping of the rear tailgate window/door and route the cable along the rear hatch. Lift the weather stripping from the opening and tuck the cable inside it, then replace the weather stripping. Pull the cable out from weather stripping and route it into the cabin under the interior trim. Avoid hinges or gears that could crimp or cut the cable.
2. Route the cable through the SUV's main cabin area under the interior trim, towards the front of the vehicle. Use a blunt plastic putty knife or similar blunt tool to lift the plastic trim just enough to tuck the cable

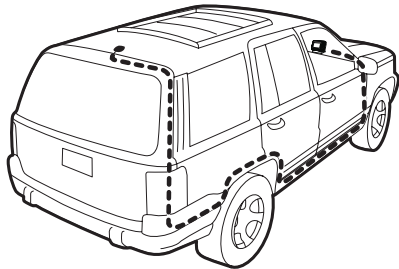

Vehicle Installation

under underneath. Avoid side airbag locations on back pillars and above the doors. Airbag locations are marked with “SRS” logos. Be careful not to crimp or cut the cable.

3. Bring the cable out from the trim near the front of the cabin and route it under the carpet toward the dashboard or console. Coil any excess cable in a hidden location, such as under the carpet, keeping it away from any vehicle pedals or controls. Secure the excess cable with wire ties (purchased separately).
4. Bring the end of the cable out at the *PowerConnect* Vehicle Dock location. Leave yourself enough cable so you can easily connect it to the antenna connector of the dock.
5. Continue with “Step 5: Connect the Magnetic Mount Antenna and *PowerConnect* Power Adapter” on page 33.

Convertible

1. Bring the antenna cable from the antenna into the trunk at the front edge of the trunk lid. Keep any bends in the cable loose. Tape or tie the cable along the inside of the trunk lid to the trunk lid hinge strut.
2. Allow enough slack in the cable so the trunk lid can easily open and close and keep the cable away from hinges, gears, etc., that could crimp or cut it. Route the cable along the trunk wall and into the cabin through a conduit or along an existing wiring harness.
3. Route the cable through the main cabin area under the interior trim,

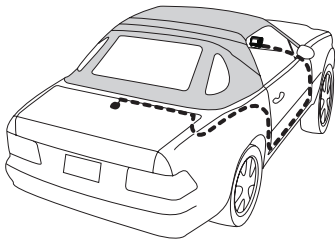

Vehicle Installation

towards the front of the vehicle. Use a blunt plastic putty knife or similar blunt tool to lift the plastic trim just enough to tuck the cable under underneath. Avoid side airbag locations on back pillars and above the doors. Airbag locations are marked with “SRS” logos. Be careful not to crimp or cut the cable.

4. Bring the cable out from the trim near the front of the cabin and route it under the carpet toward the dashboard or console. Coil any excess cable in a hidden location, such as under the carpet, keeping it away from any vehicle pedals or controls. Secure the excess cable with wire ties (purchased separately).
5. Bring the end of the cable out at the *PowerConnect* Vehicle Dock location. Leave yourself enough cable so you can easily connect it to the antenna connector of the dock.
6. Continue with “Step 5: Connect the Magnetic Mount Antenna and *PowerConnect* Power Adapter” on page 33.

Pickup Truck

1. Use a blunt plastic putty knife or similar blunt tool to lift the rubber molding around the windshield and tuck the antenna cable underneath it.
2. Continue tucking the cable underneath the windshield molding around the windshield to the lowest corner.
3. At the lowest corner of the windshield, route the cable out of the windshield molding and into the rubber weather

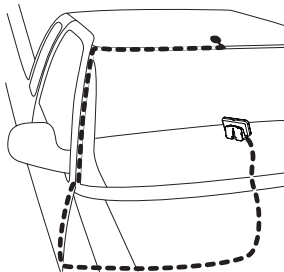

Vehicle Installation

stripping around the door opening. Lift the weather stripping from the opening and tuck the cable inside it, then replace the weather stripping. Run the cable inside of the weather stripping to the bottom of the door opening.

- 4.** Pull the cable out of the weather stripping at the bottom of the door opening and route it under the carpet toward the dashboard. Coil any excess cable in a hidden location, such as under the carpet, keeping it away from any vehicle pedals or controls. Secure the excess cable with wire ties.
- 5.** Bring the end of the cable out at the *PowerConnect* Vehicle Dock location. Leave yourself enough cable so you can easily connect it to the antenna connector of the dock.
- 6.** Continue with “Step 5: Connect the Magnetic Mount Antenna and *PowerConnect* Power Adapter” on page 33.

Vehicle Installation

Step 5: Connect the Magnetic Mount Antenna and PowerConnect Power Adapter

1. Plug the Magnetic Mount Antenna into the **silver ANT** connector on the *PowerConnect* Vehicle Dock.

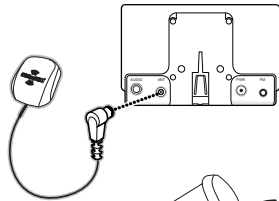

2. Insert the *PowerConnect* Power Adapter into your vehicle's cigarette lighter or power adapter socket.

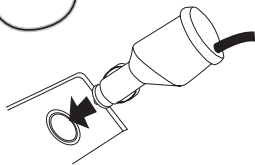

3. Plug the *PowerConnect* Power Adapter into the **red PWR** connector on the dock.

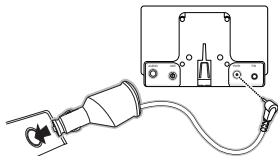

Vehicle Installation

Step 6: Connect the Audio

To play XM audio through your vehicle's stereo or FM radio, decide on one of the following audio connection options:

- **Option 1: Best:** Use the provided **Aux In Cable** if your vehicle's stereo system has an auxiliary input connection or jack. Refer to your vehicle's owners manual to find the location of the auxiliary input jack, or consult the vehicle dealer.



TIP! The auxiliary input jack may be located on the face plate of the vehicle radio, on the back of the radio, anywhere on the front dash panel, inside the glove compartment, or inside the center console in between the front seats.

- **Option 2: Better:** Use a **Cassette Adapter** if your vehicle has a built-in cassette player. Cassette Adapters are sold separately and can be purchased from an electronics retailer, or go to www.siriusxm.com/accessories.
- **Option 3: Good:** Use the **PowerConnect** feature of Onyx EZ. *PowerConnect* plays the audio through your vehicle's FM radio.
- **Option 4: Best:** Use the **FM Direct Adapter**. If none of the previous three audio connection options will work in your vehicle, then you will need to use the FM Direct Adapter (FMDA) (sold separately). The FMDA needs to be installed by a professional installer and directly connects Onyx EZ to your vehicle's FM radio. To learn more, check with the retailer where you bought your Radio, or go to www.siriusxm.com/accessories.

Follow the installation instructions in the next several sections for the audio connection option that you have selected.

Vehicle Installation

Option 1: Aux In Cable Installation Instructions

1. Plug one end of the Aux In Cable into the **green AUDIO** connector on the dock.

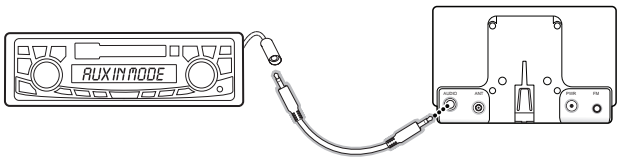

2. Plug the other end into the auxiliary input jack of your vehicle's stereo system.
3. If you are using the vent mounting method, attach the Vent Mount to the vehicle vent.
4. Insert your Onyx EZ into the dock.
5. Power on your Onyx EZ by pressing the **Power button**.
6. Be sure the vehicle is outside and the antenna has a clear view of the sky. Verify that you are receiving the XM signal. There should be at least two bars on the lower left corner of the main display screen that denotes antenna signal strength. You can also press **menu** and then press ▼ to scroll to and highlight **Signal Indicator**. Press the **Select button**. The Satellite and Terrestrial bars show the strength of the signal being received. If the signal reception is good, press and hold **menu** to return to the main display screen.

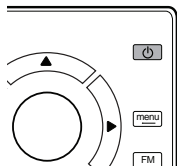
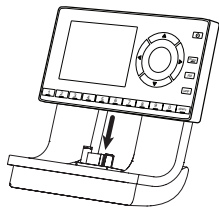

Vehicle Installation

7. Ensure Onyx EZ is tuned to channel 1, the XM Preview channel. Upon power up, Onyx EZ should tune to channel 1 by default, when it's not yet activated. If it's not on channel 1, refer to "Listening to Satellite Radio" on page 48 to learn about how to tune a channel.
8. Turn on your vehicle's stereo system. Set it to play from the auxiliary input source. You should hear XM channel 1 through your vehicle's stereo system. You are now ready to activate your Onyx EZ.
9. Go back to "Step 2: Install the Dash or Vent Mount" on page 12 and finish installing the Dash or Vent Mount. Then the installation is complete.
10. The audio level output of Onyx EZ can be increased or decreased as necessary to match the audio levels of other sources in your vehicle. Refer to "Set Audio Level" on page 68.

If the signal reception is good, showing at least two bars in the lower left corner of the display, but there is no XM audio, be sure the vehicle's stereo system is set to the auxiliary input source (step 8). Also be sure that the audio level is set high enough to be heard (step 10). Refer to "Troubleshooting" on page 79 for additional help.

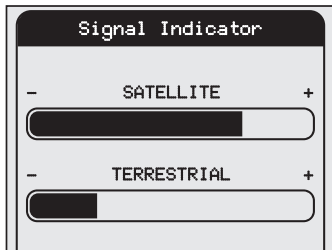

Vehicle Installation

Option 2: Cassette Adapter Installation Instructions

1. Plug the Cassette Adapter into the **green AUDIO** connector on the dock.
2. Insert the Cassette Adapter into the vehicle's cassette deck. You may need to turn on your vehicle's stereo system in order to do so.

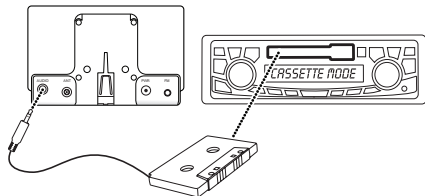

3. If you are using the vent mounting method, attach the Vent Mount to the vehicle vent.
4. Insert your Onyx EZ into the dock.
5. Power on your Onyx EZ by pressing the **Power button**.
6. Be sure the vehicle is outside and the antenna has a clear view of the sky. Verify that you are receiving the XM signal. There should be at least two bars in the lower left corner of the main display screen that denotes antenna signal strength. You can also press **menu** and then press ▼ to scroll to and highlight **Signal Indicator**. Press the **Select button**. The Satellite and Terrestrial bars show the strength of the signal being received. If the signal reception is good, press and hold **menu** to return to the main

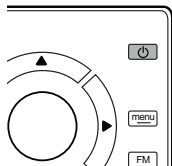
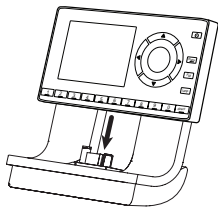

Vehicle Installation

display screen.

7. Ensure Onyx EZ is tuned to channel 1, the XM Preview channel. Upon power up, Onyx EZ should tune to channel 1 by default, when it's not yet activated. If it's not on channel 1, refer to "Listening to Satellite Radio" on page 48 to learn about how to tune a channel.
8. Turn on your vehicle's stereo system. Set it to play from the auxiliary input source. You should hear XM channel 1 through your vehicle's stereo system. You are now ready to activate your Onyx EZ.
9. Go back to "Step 2: Install the Dash or Vent Mount" on page 12 and finish installing the Dash or Vent Mount. Then the installation is complete.
10. The audio level output of Onyx EZ can be increased or decreased as necessary to match the audio levels of other sources in your vehicle. Refer to "Set Audio Level" on page 68.

If the signal reception is good, showing at least two bars in the lower left corner of the display, but there is no XM audio, be sure the vehicle's stereo system is set to the cassette source (step 4). Also be sure that the audio level is set high enough to be heard (step 5). Refer to "Troubleshooting" on page 79 for additional help.

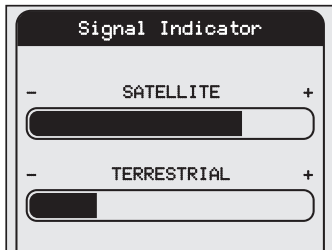

Vehicle Installation

Option 3: *PowerConnect* Installation Instructions

1. If you are using the vent mounting method, attach the Vent Mount to the vehicle vent.
2. Insert your Onyx EZ into the dock.
3. Power on your Onyx EZ by pressing the **Power button**.
4. Be sure the vehicle is outside and the antenna has a clear view of the sky. Verify that you are receiving the XM signal. There should be at least two bars in the lower left corner of the main display screen that denotes antenna signal strength. You can also press **menu** and then press ▼ to scroll to and highlight **Signal Indicator**. Press the **Select button**. The Satellite and Terrestrial bars show the strength of the signal being received. If the signal reception is good, press and hold **menu** to return to the main display screen.
5. You'll first need to find an available FM channel. An available FM channel is one that's not being used by an FM radio station in your area. When you tune your FM radio to an available channel, you should only hear static or silence – not talk or music. We recommend one of the following methods to find an available FM channel:
 - a. Use the SiriusXM FM Channel

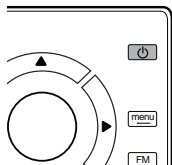
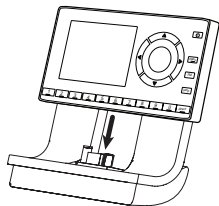

Vehicle Installation

Finder at www.siriusxm.com/fmchannel. Go to the website and enter your zip code. The Channel Finder will suggest a list of available FM channels in your area. For convenience, write down or print out the list.

OR

- Manually tune through your local FM channels on your vehicle's FM radio.

Locate and create a list of channels that aren't being used by any FM radio station. Write down the list. Once you have created your list of available FM channels, you will need to find the one that provides the best match for Onyx EZ.

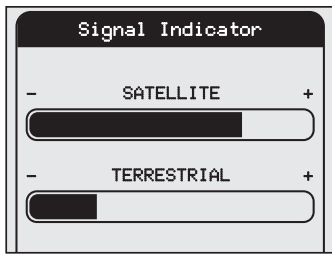

TIP! You'll need to use the 'Manual' tune function on your vehicle's FM radio to tune through every FM channel one-by-one. Turn on your vehicle's FM radio. Start at 88.1 and use the 'Manual' tune function on your vehicle's FM radio to tune through each FM channel one-by-one (88.1 followed by 88.3 etc.) to locate channels that aren't being used by a local FM radio station. Write down each FM channel that has only static or silence on it, until you reach 107.9.

- Ensure Onyx EZ is tuned to channel 1, the XM Preview channel. Upon power up, Onyx EZ should tune to channel 1 by default, when it's not yet activated. If it's not on channel 1, refer to "Listening to Satellite Radio" on page 48 to learn about how to tune a channel.
- Pick the first FM channel on your list from step 5. Turn on your vehicle's FM radio (if you have not already done so) and tune it to this FM channel.



NOTE! If you are using the Vehicle Dock from the Universal Xpress Car Kit instead of the PowerConnect Vehicle Dock which came with your Onyx EZ, you will have to disable AUX Detect. Refer to "Using the Vehicle Dock From the Universal Xpress Car Kit" on page 76, and complete the additional

Vehicle Installation

instructions before continuing with the next step. The audio connection will be through your vehicle's FM radio, but it is not *PowerConnect*.

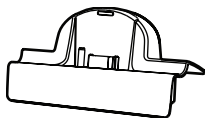

8. Set your Onyx EZ to transmit on the same FM channel that you have selected in step 7:

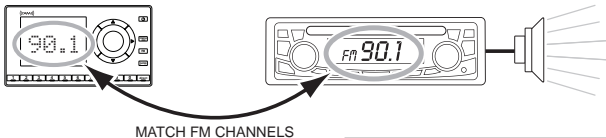

- i. Press **menu**.
- ii. Press ▼ to scroll to and highlight **FM Settings** and press the **Select button**.
- iii. **FM Channels** will be highlighted. If it is not highlighted, press ▼ to scroll to and highlight **FM Channels**. Press the **Select button**.
- iv. Press ▼ to scroll to and highlight the storage location **FM 2** and press the **Select button**.
- v. Tune to the available FM channel you choose in step 3. Press ◀ and ▶ to tune in steps of .2, i.e., 99.3 to 99.5. Press ▼ and ▲ to tune in steps of 1, i.e., 99.3 to 100.3. Press the **Select button** to select the FM channel.

FM Channels		
FM 1	97.9	current
FM 2	---	---
FM 3	---	---
FM 4	---	---
FM 5	---	---

99.3 FM

Set your vehicle radio to the above channel to enable audio.

Vehicle Installation

- vi. Start Using** is highlighted. Press the **Select** button.
- vii.** The FM channel you selected will be confirmed on the display screen. Onyx EZ will tune to the FM channel.
- 9.** You should hear XM channel 1 through your vehicle's FM radio. If you are satisfied with the sound quality, the installation is complete. You are now ready to activate your Onyx EZ.
- 10.** Go back to "Step 2: Install the Dash or Vent Mount" on page 12 and finish installing the Dash or Vent Mount. Then the installation is complete.
- 11.** If the selected FM channel doesn't work well for you, work down the list of FM channels until you find one with which you are satisfied. Each time, you will need to tune your vehicle's FM radio to the FM channel and then set your Onyx EZ to transmit on the same FM channel (steps 7 & 8).

If the signal reception is good, showing at least two bars in the lower left corner of the display, but there is no XM audio, verify that both Onyx EZ and your vehicle's FM radio are tuned to the same FM channel (steps 7 & 8). Also ensure the chosen FM channel is a suitable one to use in your area (step 5). Verify that nothing is plugged into the **AUDIO** connector on the *PowerConnect* Vehicle Dock. Refer to "Troubleshooting" on page 79 for additional help.

Option 4: FM Direct Adapter (FMDA) Installation

The FMDA needs to be installed by a professional installer. Professional installation can help improve your Radio's reception and significantly reduce the visibility of wires. To learn more, check with the retailer where you bought your Radio, or go to www.siriusxm.com/accessories.

Subscribe

You can follow either the general activation and subscription process or use the on-board activation guide to activate your Onyx EZ and subscribe to the XM service.

General activation and subscription process:

Subscribe to the XM service by following these steps:

1. Make sure your Onyx EZ is turned on, tuned to XM Preview channel 1, and receiving the XM signal so that you can hear the XM audio.
2. Make a note of the XM Radio ID. You can find it:
 - by selecting **Radio ID** in menu items
 - on channel 0 (zero)
 - on a label on the bottom of the gift box
 - on the label on the back of your Onyx EZ



NOTE! The XM Radio ID does not use the letters I, O, S, or F.



*The phone number shown above may differ from the one shown on your Onyx EZ. All numbers are valid.

3. To subscribe:
 - Online: Go to **www.siriusxm.com/activatenow** to access or set up an online account, subscribe to the service, and activate your Radio.
 - OR
 - By phone: Call **1-866-635-2349**.

Activation usually takes 10 to 15 minutes after you have completed the subscription process, but may take up to an hour. We recommend that your Radio remain on until subscribed. Once subscribed, the Radio will receive

Subscribe

and you can tune to channels in your subscription plan.

Press ▲ or ▼ to tune to other channels, and ◀ or ▶ to browse the different categories of channels. Learn what all the buttons do by turning to “Navigation Basics” on page 46.

Activation guide:

For your convenience, Onyx EZ has an on-board activation guide. You can activate your radio and subscribe to the XM service by using this guide, where you will be guided step-by-step through the subscription process. To access and use the guide, simply follow these steps:

1. Turn Onyx EZ on and press the **menu button**.
2. **Activate Radio** will be highlighted. Press the **Select button**.
3. Follow the directions on each successive screen until you complete the subscription process.



Using Your Onyx EZ

The Main Display

When listening to a channel, information about the channel and what is currently playing is displayed.

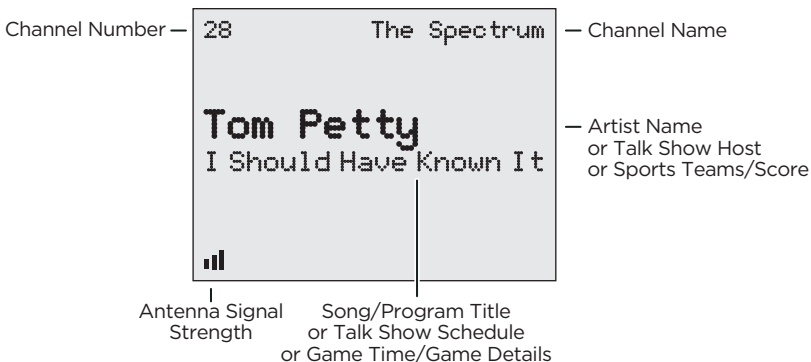

Using your Onyx EZ

Navigation Basics

Power Button

Pressing the **Power button** turns Onyx EZ On or Off.



Navigation Buttons

Pressing **Left**, **Right**, **Up**, and **Down** navigates through various features and functions of Onyx EZ.



- **Left ◀ or Right ▶ button:** Displays the channel categories such as Rock, Pop, Sports, Talk/News, etc. Repeated presses cycle through the categories one at a time. Also, decreases or increases the settings of various menu options such as Brightness, Audio Level, etc.
- **Up ▲ or Down ▼ button (press and release):** Immediately tunes to the next or previous channel in the channel lineup. Also, scrolls through lists and highlights an item in the list.
- **Up ▲ or Down ▼ button (press and hold):** Continuously scrolls through any list. While on the main display screen, continuously scrolls through the channel lineup and briefly displays the information of each channel. When the button is released, Radio tunes to the last channel it had scrolled to in the channel lineup.

Select Button

Pressing the **Select button** selects a highlighted item in a list and confirms settings.



Using Your Onyx EZ

Menu Button



Pressing **menu** displays various options to make setup and feature changes. Pressing **menu** when in menu options returns to the previous menu option screen until menu options is exited. Pressing and holding **menu** returns to the main display screen in most instances.

FM Button



Pressing **FM** provides easy tuning of FM presets for optimized *PowerConnect* performance. Repeatedly pressing **FM** displays and cycles through the list of preset FM channels one at a time. The Radio automatically tunes to the displayed FM channel. Pressing and holding **FM** accesses the FM Settings menu. It is not available when Aux In Cable or Cassette Adapter is used for audio connection.

Jump Button



Depending on how it is configured, pressing **jump** either tunes to the channel broadcasting traffic and weather conditions of a city of your choice, selected from a list of the 22 most congested cities, or tunes to the previous channel that was being played. Pressing it again returns it to the original channel.

Direct Button



Pressing **direct** prompts for the entry of a channel number using the number buttons. Once the channel number is entered, the Radio directly tunes to the new channel.

Number Buttons



Each number button stores a favorite channel in its button location and provides one touch access to it afterward. Number buttons also directly tune to a channel when the channel number is entered after pressing **direct**.

Using your Onyx EZ

Listening to Satellite Radio

Tune to a channel:

1. Press and release ▲ and ▼ to immediately tune to the next or previous channel.
2. Press and hold ▲ and ▼ to quickly scroll through the channels. Release to tune to the channel that is displayed.

View a category:

Channels are organized into categories to make it easier for you to find the ones that suit your taste.

1. To view channels in a category in list mode press ◀ or ▶.
2. Scroll through the category using ▲ and ▼, and find the channel you want to tune.
3. Press the **Select button** to select the channel, or press ◀ or ▶ to view channels in the previous or next category.

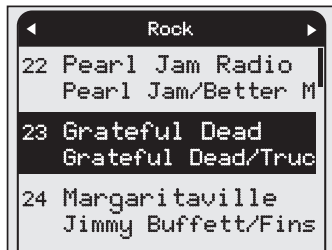

TIP! To briefly listen to each channel in the category, scroll to and highlight Scan at the end of the category list and press the **Select button**. Refer to "Scanning Channels in a Category" on page 51 to learn more about Scan.

Using Your Onyx EZ

Direct Tune

A channel can be tuned directly by entering the channel number using the number buttons.

1. To directly tune to a channel press **direct**.
2. Use the number buttons **0-9** to enter the channel number and wait a moment until the channel is tuned, or press the **Select button** to immediately tune to the channel.

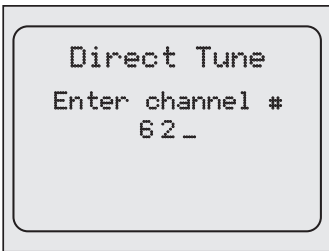

Return to Main Display Screen

Pressing and holding **menu** in most instances will return you to the main display screen. In some cases, you may need to follow the instructions on the display screen.

Jump

Depending upon how you configure the mode, pressing **jump** will either go to the traffic and weather channel for the city of your choice, which you select from a list of the 22 most congested cities, or go to the previous channel to which you were listening.

If Jump is set to **Traffic**, when you press **jump** and the traffic/weather broadcast of your selected city is not immediately available, a message will be displayed at the bottom of the screen to indicate that a jump is pending. Once the traffic/weather report is ready to be broadcast, the Radio will

Using your Onyx EZ

automatically tune to the traffic/weather channel. Since a channel may broadcast the traffic and weather reports of more than one city, you may have to wait a few minutes for the broadcast of your selected city.

If Jump is set to **Last Channel**, pressing **jump** will immediately tune to the previous channel to which you were listening.

Pressing **jump** while a jump is pending will cancel the jump. Pressing **jump** after the Radio has tuned to the traffic/weather or desired channel, will return it back to the channel to which you had been listening immediately prior to pressing **jump**.



TIP! By default **jump** is configured to tune to a traffic/weather channel. To select a city for traffic and weather, or to configure **jump** to tune to the last channel to which you were listening, refer to “Jump Settings” on page 66.

Favorite Channels

You can set up to 10 of your favorite channels so you can easily access them. Each favorite channel can be assigned to a number button.

To assign a favorite channel to a number button:

1. Tune to the desired channel.

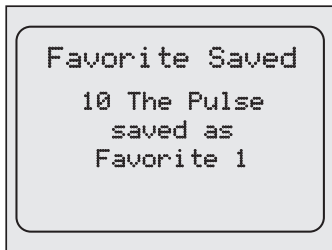
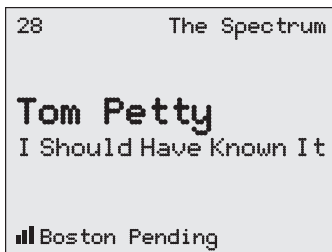

Using Your Onyx EZ

2. Press and hold a number button between **0-9** that you want to assign to that favorite channel. An advisory with the channel number and name will be displayed on the screen confirming that the channel has been assigned.

To listen to a favorite channel:

1. Press the number button between **0-9** that was assigned to the desired favorite channel. Onyx EZ will tune to that channel.



TIP! When you are at the main display screen, press ◀ to see your list of favorite channels. Scroll to highlight a favorite and press the **Select button** to listen to that channel.

Scanning Channels in a Category

You can scan a category and listen to each channel for 10 seconds before Onyx EZ automatically tunes to the next channel. If you want to stay tuned to the channel being played and stop the scan, just press the **Select button**.

To scan a category:

1. Press ◀ or ▶ until the desired category is displayed.

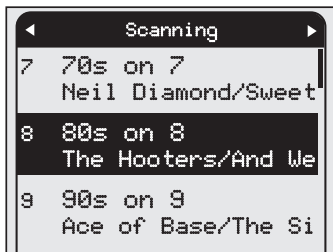
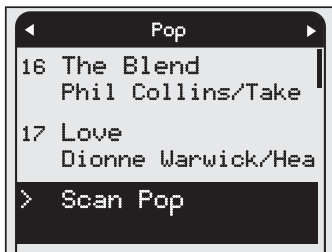

Using your Onyx EZ

2. Scroll down to highlight the last item in the category which will be **Scan** and the category name.
3. Press the **Select button**. The scan will begin.
4. Press the **Select button** to stop the scan, and to continue to listen to the channel currently being played, or press ▼ or ▲ to return to the channel you were listening to before you began the scan.

FM Presets

FM presets make it easy to quickly access stored FM channels and choose a new FM channel from them.

Use FM presets when you use *PowerConnect* or the *FMDA* to listen to your Onyx EZ through your vehicle's FM radio. (Refer to "Option 3: *PowerConnect* Installation Instructions" on page 39 for more information.)

To use a different FM preset:

1. Press **FM** to display the current FM preset.
2. To display and select the next FM preset, press **FM**. The Radio will tune to the displayed FM channel. If the preset is the one you want, press **menu** or wait for the screen to time out.
3. Repeatedly pressing **FM** will cycle through the FM presets.

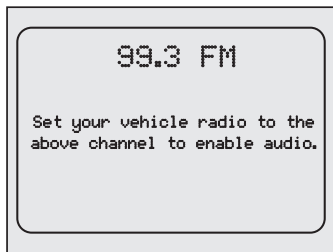

Using your Onyx EZ

4. Set your vehicle's FM radio to the same FM channel.



IMPORTANT! You need to ensure that your vehicle's FM radio is tuned to the same FM channel.



TIP! To configure the list of preset FM channels, you need to find available FM channels in your area. Refer to "Find Available FM Channels in Your Area" on page 61. Next, refer to "Set and Select an FM Channel" on page 63.



103.7 FM

Set your vehicle radio to the above channel to enable audio.

Special Features

Parental Controls

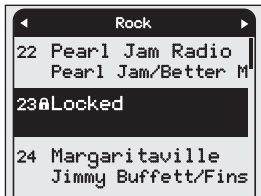

Onyx EZ has a parental control feature which allows you to lock access to channels, or lock access to an entire category. A 4-digit code controls access to the locked channel or locked category.

When you browse a category, the number of the locked channel will be shown but not the artist and song/program information. Instead, a lock icon  and the word "Locked" is shown. If you scroll through the channels using  and , the locked channels are skipped and are neither displayed, nor tuned.



If you attempt to tune to a locked channel, either by using direct tune or through the category list, you'll be prompted to enter your 4-digit code. When the correct code is entered, you'll be able to tune to and listen to the channel. All locked channels become unlocked and remain unlocked until you turn Onyx EZ Off, and back On. In the category list, the previously locked channels will show an unlocked icon .

To turn Parental Controls On (or Off):

1. Press **menu**.
2. Press  to scroll to and highlight **Parental Controls**. Press the **Select button**.
 - If this is the first time you want to turn on Parental Controls, **Parental Ctrl**s will be highlighted. Press the **Select button**. You will be prompted to select a 4-digit code:
 - i. For each digit, press one of the **0-9** keys (or press  or  to

Special Features

- select digits) and then press **▶** to advance to the next digit. (Press **◀** if you need to go back and edit a previous digit.)
- ii. When you have selected all 4 digits of your code press the **Select button**.
 - iii. The Code Confirmation screen will be displayed. For your records, write down the code you have selected. Press the **Select button**. Continue with step 3.
- If you had previously selected a 4-digit code you will be prompted to enter your code:
- i. For each digit, press one of the **0-9** keys (or press **▼** or **▲** to select digits) and then press **▶** to advance to the next digit. (Press **◀** if you need to go back and edit a previous digit.)
 - ii. When you have selected all 4 digits of the code press the **Select button**.
- 3.** At the “Parental Controls” screen, **Parental Ctrl**s will be highlighted. Press the **Select button** to turn parental control On (or press the **Select button** to turn parental control Off).
- 4.** Press and hold **menu** to return to the main display screen.

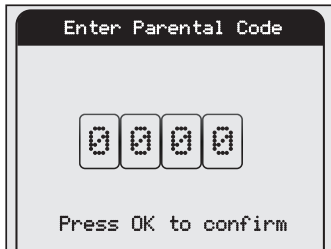
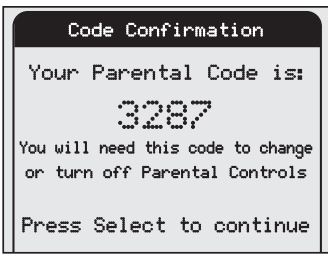

Special Features

To lock (or unlock) channels or categories:

1. Press **menu**.
2. Press ▼ to scroll to and highlight **Parental Controls**. Press the **Select button**.
3. You will be prompted to enter the 4-digit code. For each digit, press one of the **0-9** keys (or press ▼ or ▲ to select digits) and then press ► to advance to the next digit. (Press ◀ if you need to go back and edit a previous digit.)
4. When you have entered all 4 digits of the code press the **Select button**.
5. If **Parental Ctrl**s is shown as Off, press the **Select button** to turn it On, otherwise continue with the next step.
6. At the “Parental Controls” screen, Press ▼ to scroll to and highlight **Locked Channels**. Press the **Select button**.
7. A list of all the categories and the channels in each category will be displayed. Press ▼ and ▲ to scroll to and highlight a channel or category you want to lock. Press the **Select button**. A lock icon 🔒 will be displayed to the left of the channel or category you locked. (To unlock a locked channel or category, simply highlight the locked

Locked Channels

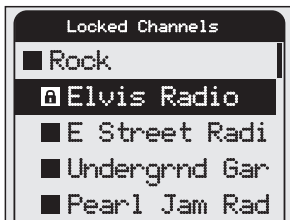

Locked Categories



Special Features

channel or category and press the **Select button**. The lock icon will disappear indicating the channel or category is unlocked.)

8. You can continue to lock and unlock as many channels or categories as you wish. When you are finished, press and hold **menu** to return to the main display screen.

To change your code:

1. Press **menu**.
2. Press ▼ to scroll to and highlight **Parental Controls**. Press the **Select button**.
3. You will be prompted to enter your existing 4-digit code. For each digit, press one of the **0-9** keys (or press ▼ or ▲ to select digits) and then press ► to advance to the next digit. (Press ◀ if you need to go back and edit a previous digit.)
4. When you have entered all 4 digits of the code press the **Select button**.
5. If **Parental Ctrl**s are shown as Off, press the **Select button** to turn it On, otherwise continue with the next step.
6. At the “Parental Controls” screen, Press ▼ to scroll to and highlight **Change My Code**. Press the **Select button**.
7. You will be prompted to enter a new 4-digit code. For each digit, press one of the **0-9** (or press ▼ or ▲ to select digits) keys and then press ► to advance to the next digit. (Press ◀ if you need to go back and edit a

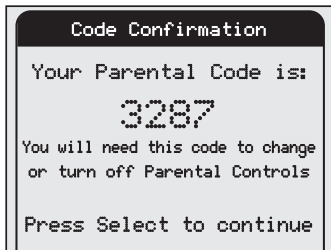

Special Features

previous digit.)

8. The Code Confirmation screen will be displayed. For your records, write down the code you have selected. Press the **Select button**.
9. Press and hold **menu** to return to the main display screen.

To listen to a locked channel:

There are two ways to tune to a channel which has been locked. The first is to directly tune to the locked channel, and the second is to select the locked channel from a category list.

1. Directly tune to or select the locked channel:

To directly tune to a locked channel:

- i. Press **direct** and enter the channel number using the **0-9** keys.

To select a locked channel from the category list:

- i. Press ◀ or ▶ to view the category list of the locked channel to which you wish to tune.
 - ii. Press ▼ to scroll to and highlight the locked channel. Press the **Select button**.
- 2 You will be prompted to enter your existing 4-digit code. For each digit, press one of the **0-9** keys (or press ▼ or ▲ to select digits) and then press ▶ to advance to the next digit. (Press ◀ if you need to go back and edit a previous digit.)
 - 3 When you have entered all 4 digits of the code, press the **Select button**. If your code is correct the channel will be tuned. All locked channels become unlocked and remain unlocked until you turn Onyx EZ Off, and back On. In the category list, the previously locked channels will show an unlocked icon .

Where Else Can You Use Your Onyx EZ?

SiriusXM offers a variety of accessories that allow you to adapt your Onyx EZ to your lifestyle and enhance your listening experience. With these accessories, you can effortlessly take your Satellite Radio listening experience from your vehicle to your home or office or on the go – all with a single subscription.

- In Your Home, Office, etc. – With a Home Kit, you can play your Onyx EZ through your existing stereo system or powered speakers.
- In Your Other Vehicles – With Vehicle Kits, you can enjoy your Onyx EZ in other vehicles.
- In Almost Any Location You Like – With a portable Sound System you have the freedom to listen to your Onyx EZ where and when you want, from your kitchen or den, to the office, to outside on the deck, or at a picnic.

For more information on XM accessories or to purchase an accessory, please visit your local retailer or www.siriusxm.com/accessories.

Configuring Your Onyx EZ

Radio ID

Your Onyx EZ has an 8 character alphanumeric ID which uniquely identifies your Radio. This ID is used during the subscription process.

To display the Radio ID:

1. Press **menu**.
2. **Radio ID** will be highlighted. If it is not highlighted, press ▼ to scroll to and highlight **Radio ID**. Press the **Select button**. The Radio ID will be displayed.
3. Press and hold **menu** to return to the main display screen.



Configuring Your Onyx EZ

Find Available FM Channels in Your Area

Before attempting any of the procedures below, you should park your vehicle in a safe location. Do not attempt to set up your FM channels or any Onyx EZ function while driving.

PowerConnect allows you to listen to SiriusXM through your existing vehicle radio. You will first need to find an available FM channel, which is a channel that is not being used by an FM radio station in your area. When you tune your vehicle's FM radio to an available channel, you should only hear static or silence – not talk or music.

Once you have found an available FM channel, you'll need to tune Onyx EZ and your vehicle's radio to the same FM channel to receive XM audio through your vehicle's radio.

We recommend one of the following methods to find an available FM channel:

1. Use the SiriusXM FM Channel Finder

Use the SiriusXM FM Channel Finder at www.siriusxm.com/fmchannel. Go to the website and enter your zip code. The Channel Finder will suggest a list of available FM channels in your area. For convenience, write down or print out the list.

Tune Onyx EZ to a favorite XM channel (or to channel 1, if it's not activated). Turn on your vehicle's FM radio. Pick the first FM channel on your Channel Finder list and tune the FM radio to that channel. If you do not hear a local FM station broadcast, then tune Onyx EZ to the same FM channel. (Refer to "Set and Select an FM Channel" on page 63.) You should hear the XM channel through your vehicle's radio. If you are satisfied with the sound quality, you're done! If this FM channel doesn't work well for you, work down the list until you find an FM channel that allows you to hear XM clearly.

Configuring Your Onyx EZ

OR

2. Manually tune through your local FM channels

Manually tune through your local FM channels on your vehicle's FM radio. Turn on your vehicle's FM radio. Start at 88.1 and use the 'Manual' tune function on your vehicle's FM radio to tune through each FM channel one-by-one (88.1 followed by 88.3 etc.) to locate channels that aren't being used by a local FM radio station. Write down each FM channel that has only static or silence on it, until you reach 107.9. Once you have created your list of available FM channels, you will need to find the one that provides the best match for Onyx EZ.

Tune Onyx EZ to a favorite XM channel (or to channel 1, if it's not activated). Pick the first FM channel on your list and tune the FM radio to that channel. Then tune Onyx EZ to the same FM channel. (Refer to "Set and Select an FM Channel" on page 63.) You should hear the XM channel through your vehicle's radio. If you are satisfied with the sound quality, you're done! If this FM channel doesn't work well for you, work down the list until you find an FM channel that allows you to hear XM clearly.



NOTE! You may find an FM channel with static or silence that does not work with Onyx EZ. It is possible that some type of inaudible interference is present that prevents reception of the XM broadcast. Your only options are to use another FM channel or a different audio connection method.



TIP! If you regularly drive from one location to another, such as your daily commute, you may need to use different FM channels along your route for best performance. If this is the case, we recommend saving the best FM channels as presets on your FM radio and Onyx EZ. Then you simply select and match the best channel for the area you are in.



TIP! It will be much more difficult to find available FM channels in large cities than in most suburban or rural locations. A direct audio connection using the Aux In Cable, Cassette Adapter, or professional installation is your best

Configuring Your Onyx EZ

solution if you drive in or near large metropolitan areas.



NOTE! The SiriusXM FM Channel Finder relies on data from the Federal Communications Commission. The data may not reflect the latest stations in your area. In addition, local geography and weather conditions can impact reception, so your results may be different from the list.



NOTE! The performance of FM radios are different, based on manufacturer and vehicle style. Some may not work well with the type of FM transmitter used by Onyx EZ. This is why we recommend a direct audio connection using the Aux In Cable or Cassette Adapter if they can be used in your vehicle. Professional installation can also resolve almost any performance issue.

Set and Select an FM Channel

Onyx EZ allows you to easily store (i.e., preset) up to 5 different FM channels. At any time, you can select any one of these 5 FM presets to hear SiriusXM through your existing vehicle radio. Having a choice of 5 FM presets also makes it easy to switch to the appropriate FM channel as you travel from one area to another. Each FM preset is stored in its own storage location. You can easily add or edit the FM preset in any one of the 5 storage locations.



IMPORTANT! Onyx EZ and the vehicle's FM radio need to be tuned to the same FM channel in order to hear the audio.



TIP! The FM 1 storage location is preset with

To set and select an FM preset:

1. Press **menu**.
2. Press ▼ to scroll to and highlight **FM Settings** and press the **Select** button.
3. **FM Channels** will be highlighted. If it is

FM Channels	
FM 1	97.9
FM 2	99.3 <small>current</small>
FM 3	100.3
FM 4	---
FM 5	---

Configuring Your Onyx EZ

not highlighted, press ▼ to scroll to and highlight **FM Channels**. Press the **Select button**.

4. Press ▼ to scroll to and highlight the storage location (FM 1 to FM 5) you want to set and press the **Select button**. You can choose among the following options:
 - i. If the chosen storage location is empty (denoted by “---”), or if the storage location contains the FM preset currently being used (denoted by “current”), then the FM channel tuning screen is displayed.
 - ii. If the chosen storage location has an FM preset that is not currently being used, and you want to edit it, **Edit Channel** is highlighted. Press the **Select button**. The FM channel tuning screen is displayed.
 - iii. If the chosen storage location has an FM preset that is not currently being used, and you want to start using it, press ▲ to highlight **Start Using** and press the **Select button**. Skip to step 7.
5. Press ◀ and ▶ to tune to the desired FM channel in steps of .2, i.e., 99.3 to 99.5. Press ▼ and ▲ to tune to the desired channel in steps of 1, i.e., 99.3 to 100.3. Press the **Select button** to select the FM channel.
6. If you are editing the storage location

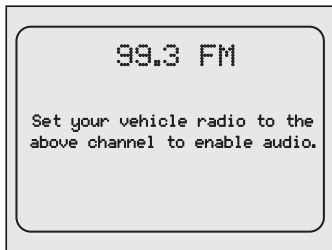

Configuring Your Onyx EZ

that has the “current” FM preset, skip to step 7. Otherwise, **Start Using** will be highlighted. Press the **Select button**.



NOTE! You can also set an FM preset without having to start using it right away. Just press **menu** and exit the screen.

- 7 The chosen FM channel will be confirmed on the display screen and Onyx EZ will tune to that FM channel.
- 8 Set your vehicle’s FM radio to same FM channel.



IMPORTANT! You’ll first need to find a suitable FM channel that is unused or available in your area.

To quickly select an FM preset:

1. Press **FM** to display the current FM preset.
2. To display and select the next FM preset, press **FM**. Onyx EZ will tune to the displayed FM channel. If the preset is the one you want, press **menu** or wait for the screen to time out.
3. Repeatedly pressing **FM** will cycle through the FM presets.
4. Set your vehicle’s FM radio to same FM channel.

99.3 FM

Set your vehicle radio to the above channel to enable audio.

103.7 FM

Set your vehicle radio to the above channel to enable audio.

Configuring Your Onyx EZ

Jump Settings

The **jump** button can be configured to either jump to the traffic and weather for the city of your choice from a list of 22 of the most congested cities, or to jump back to the last channel to which you were listening. When configuring for traffic/weather, you'll need to select your city.

To configure jump:

1. Press **menu**.
2. Press ▼ to scroll to and highlight **JUMP Settings** and press the **Select button**.
3. **Mode** will be highlighted with either **Last Channel** or **Traffic/Weather**. If you want to change the mode, press the **Select button**. Otherwise, just leave it as shown. (Repeatedly pressing the **Select button** toggles between the choices.)
4. If you have selected **Last Channel**, press and hold **menu** to return to the main display screen. If you have selected **Traffic/Weather** continue with step 5.
5. Press ▼ to scroll to and highlight **Set Location** and press the **Select button**.
6. A list of cities will be displayed. Press



Configuring Your Onyx EZ

▼ to scroll to and highlight your desired location and press the **Select button**.

7. The **JUMP Settings** screen will display the location you selected. Press and hold **menu** to return to the main display screen.

Set Brightness or Contrast

To change the display's brightness or contrast:

1. Press **menu**.
2. Press ▼ to scroll to and highlight **Display Settings** and press the **Select button**.
3. Press the **Select button** to change the brightness, or press ▼ to scroll to and highlight **Contrast** and press the **Select button**.
4. Press ◀ to decrease or ▶ to increase the brightness or contrast of the display.
5. Press the **Select button** to confirm the brightness or contrast setting.
6. Press and hold **menu** to return to the main display screen.

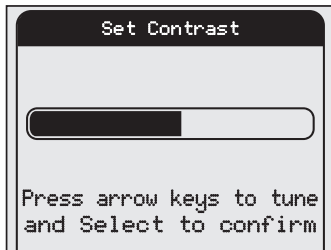
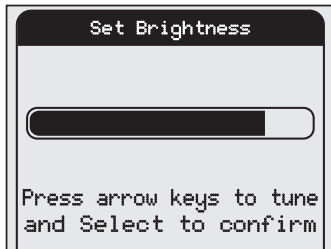

Configuring Your Onyx EZ

Set Audio Level

The audio level of Onyx EZ can be adjusted when an audio connection is made between the dock and the vehicle's stereo system. Audio level is used to adjust Onyx EZ's volume level to match the volume of other audio sources you may use, such as a CD player, other FM stations, or an MP3 player.

Do not use the audio level as a volume control. Use the volume control on your vehicle's stereo instead.

To adjust the audio level:

1. Press **menu**.
2. Press ▼ to scroll to and highlight **Audio Level** and press the **Select button**.
3. Press ◀ to decrease or ▶ to increase the audio level.
4. Press the **Select button** to confirm the new audio level.
5. Press and hold **menu** to return to the main display screen.

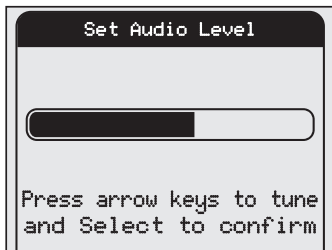

Configuring Your Onyx EZ

Signal Indicator

For best reception, your Magnetic Mount Antenna should have an unobstructed view of the XM satellites. In large cities, there are terrestrial transmitters (ground repeaters) to help increase the signal coverage.

Your Onyx EZ can display the received strength of the satellite and terrestrial signals being received.

To display the signal strength:

1. Press **menu**.
2. Press ▼ to scroll to and highlight **Signal Indicator** and press the **Select button**.
3. The Satellite and Terrestrial bars show the strength of the signal being received.
4. Reposition the antenna if you are having trouble receiving the signal. Be sure your vehicle is outside with an unobstructed view of the sky.
5. Press and hold **menu** to return to the main display screen.

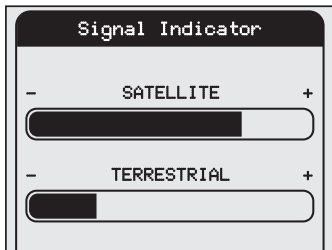

Configuring Your Onyx EZ

Factory Settings

The factory settings menu has two choices, **AUX Detect** and **Restore Defaults**.

AUX Detect

AUX Detect allows Onyx EZ to automatically detect a connection made to the **AUDIO** connector of the *PowerConnect* Vehicle Dock by an Aux In Cable or Cassette Adapter. AUX Detect is enabled by default.



IMPORTANT! If you are using the *PowerConnect* Vehicle Dock which came with your Onyx EZ, AUX Detect should remain enabled.

If you are using the older model Vehicle Dock from the Universal Xpress Car Kit, and plan to use *PowerConnect* or FM/DA as the audio connection option, you will need to disable AUX Detect. Please read the additional instructions, “Using the Vehicle Dock From the Universal Xpress Car Kit” on page 76. Once AUX Detect is disabled, you’ll have to turn the FM Transmitter On. Refer to “Turn FM Transmitter On/Off” on page 77.

To disable AUX Detect:

(Do this only when using the older model Vehicle Dock.)

1. Press **menu**.
2. Press ▼ to scroll to and highlight **Factory Settings** and press the **Select button**.

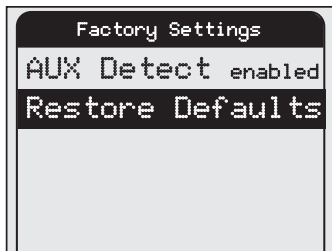

Configuring Your Onyx EZ

- AUX Detect** should be highlighted and show as enabled. Press the **Select button** to toggle the setting.
- A warning screen will be displayed. Press the **Select button** to confirm that you want to disable AUX Detect.
- If you want to cancel press **menu** to return to **Factory Settings**. AUX Detect will remain enabled.
- AUX Detect will show as disabled. Press and hold **menu** to return to the main display screen.

Disable AUX Detect?

Disable only if using vehicle dock from Universal Xpress Car Kit. Otherwise, leave it enabled.

Press Select to confirm or menu to cancel

To enable AUX Detect

(Do this when the Radio is transferred to the *PowerConnect* Vehicle Dock from an older model Vehicle Dock.)

- Press menu.
- Press ▼ to scroll to and highlight **Factory Settings** and press the **Select button**.
- AUX Detect** will be highlighted and show as disabled. Press the **Select button** again to toggle the setting to enabled.
- Press and hold **menu** to return to the main display screen.

Configuring Your Onyx EZ

Restore Defaults

You can clear all of your personal settings, such as favorite channels, FM presets, etc., and return the Radio to its original out-of-the-box settings.

To reset Onyx EZ to factory defaults:



NOTE! Restoring defaults permanently removes all personal settings.

1. Press **menu**.
2. Press ▼ to scroll to and highlight **Factory Settings** and press the **Select button**.
3. Press ▼ to scroll to and highlight **Restore Defaults** and press the **Select button**.
4. A warning screen will be displayed. If you are certain that you want to reset your Onyx EZ to the default settings, press the **Select button** to confirm.
5. If you want to cancel, press **menu** to return to **Factory Settings**.

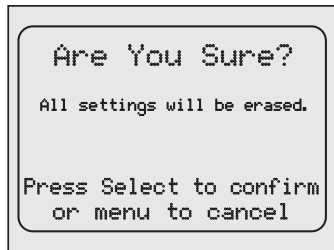

Configuring Your Onyx EZ

Demo Mode

Your Onyx EZ has a demo mode that starts playing when, for a prolonged period of time (more than 5 minutes), the Radio either detects it's not connected to the antenna, or the antenna stops receiving a signal. It disappears when the antenna is connected properly or when the Radio starts receiving a signal. You can also exit demo mode at any time, by pressing and holding the **Select button** for 10 seconds. If desired, you can also manually put Onyx EZ in demo mode.

The ability for Onyx EZ to enter demo mode is enabled by default. If you don't want Onyx EZ to ever enter the demo mode, you can disable the demo feature. You can enable it again at another time if desired.

To enable or disable the demo mode:

1. Press **menu**.
2. Press ▼ to scroll to and highlight **Demo Mode** and press the **Select button**.
3. **Status** will be highlighted. Press the **Select button** to toggle the setting between enabled or disabled. (Repeatedly pressing the **Select button** toggles between the choices.)
4. If you have selected disabled, press and hold **menu** to return to the main display screen. If you have selected enabled continue with step 5.
5. Press ▼ to scroll to and highlight **Enter Demo Mode** and press the

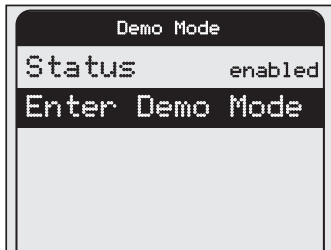

Configuring Your Onyx EZ

Select button. The demo mode will start in 10 seconds.

6. To exit demo mode at any time, press and hold the **Select button** for 10 seconds.

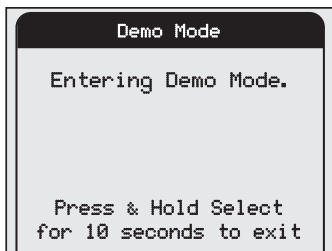

Auto Shut Off

Onyx EZ will automatically shut off after 8 hours of inactivity, i.e., when no buttons have been pressed. This feature prevents the vehicle battery from being discharged if you forget to turn your Onyx EZ off.

When Onyx EZ is about to shut off, the message **Auto Shut Off, Started auto shut off due to inactivity** is displayed, followed by **Press any button to cancel**. If you wish to continue listening, press any button.



Configuring Your Onyx EZ

To enable or disable Auto Shut Off:

1. Press **menu**.
2. Press ▼ to scroll to and highlight **Auto Shut Off** and press the **Select button** to enable or disable Auto Shut Off.
3. Press and hold **menu** to return to the main display screen.

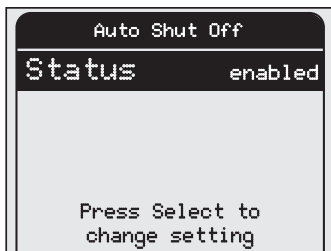

Configuring Your Onyx EZ

Using the Vehicle Dock From the Universal Xpress Car Kit

If you have chosen to use the Vehicle Dock from the Universal Xpress Car Kit rather than the *PowerConnect* Vehicle Dock included with your Onyx EZ Radio, you will need to complete some additional installation steps. When you have completed these additional steps, you can continue with the installation of your Onyx EZ.

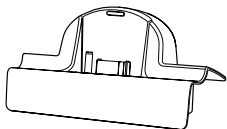

When you are using the Universal Xpress Vehicle Dock, the screen will initially display “AUX Connected” when you power on your Onyx EZ. Ignore this message. Once you have completed the steps below, it will not be displayed again.



If you are connecting the audio through your vehicle's FM radio (SureConnect or FMDA):

1. Disable the AUX Detect feature. Refer to “AUX Detect” on page 70, and disable AUX Detect.
2. Turn the FM Transmitter in Onyx EZ On. Refer to “Turn FM Transmitter On/Off” on page 77, and turn the FM Transmitter On.
3. Continue with the installation.

If you are connecting the audio using the Aux In Cable or Cassette Adapter:

1. Disable the AUX Detect feature. Refer to “AUX Detect” on page 70, and disable AUX Detect.



TIP! The FM Transmitter must be Off. To verify that the FM Transmitter is Off, refer to “Turn FM Transmitter On/Off” on page 77.

2. Continue with the installation.

Configuring Your Onyx EZ

Turn FM Transmitter On/Off

Turning the FM Transmitter On applies only if you are using the older model Vehicle Dock from the Universal Xpress Car Kit, and plan to use *SureConnect* or FMDA as the audio connection option.

You'll have to turn On the FM Transmitter under the **FM Settings** menu. However, before you can access the **FM Settings** menu, you first need to disable AUX Detect. Refer to "AUX Detect" on page 70. Once you have disabled AUX Detect, the **FM Settings** menu will be accessible.

To turn the FM Transmitter On:

1. Press **menu**.
2. Press ▼ to scroll to and highlight **FM Settings** and press the **Select button**.
3. **FM Transmitter** will be highlighted. Press the **Select button** to toggle the setting from Off to On.
4. The **FM Channels** menu item will now be accessible, allowing you to tune Onyx EZ and the FM radio in your vehicle to the same FM channel.

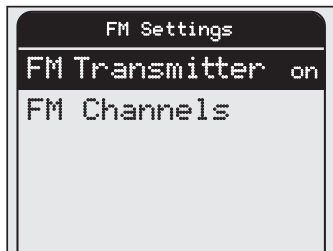

TIP! Onyx EZ is programmed with FM channel 97.9 as the default setting.

Configuring Your Onyx EZ

To turn the FM Transmitter Off:

If you are using the older model Vehicle Dock from the Universal Xpress Car Kit, and plan to use the Aux In Cable or a Cassette Adapter as the audio connection option, you'll have to turn the FM Transmitter under the **FM Settings** menu in Onyx EZ Off, if it was previously turned On.

1. Press **menu**.
2. Press ▼ to scroll to and highlight **FM Settings** and press the **Select button**.
3. **FM Transmitter** will be highlighted. Press the **Select button** to toggle the setting from On to Off.
4. A warning message will be displayed advising you to connect the Aux In Cable. Press the **Select button** to confirm that you want to turn off the FM Transmitter.
5. Press and hold **menu** to exit.



Troubleshooting

Onyx EZ has been designed and built to be trouble-free but if you experience a problem, try this:

- Check that all connections are firm and secure.
- Make sure the vehicle power socket is clean and free of corrosion.
- Make sure you have connected Onyx EZ as described in this User Guide. Verify that the *PowerConnect* Power Adapter is plugged into the vehicle's cigarette lighter or power adapter socket, and that the LED on the *PowerConnect* Power Adapter is lit (on). If not, your vehicle may need to be running to provide power to the socket.

If you see this on the screen: Try this:

Acquiring Signal	<ul style="list-style-type: none">• Make sure that the vehicle is outdoors with a clear view of the sky.• Make sure the Magnetic Mount Antenna is mounted outside of the vehicle.• Move the antenna away from any obstructed area. For example, if you are parked in an underground garage, you should receive a signal after leaving the garage.
Check Antenna Connection	<ul style="list-style-type: none">• Make sure that the antenna cable is firmly and securely plugged into the <i>PowerConnect</i> Vehicle Dock. Make sure the cable is not bent or broken.• Turn Onyx EZ Off, then On, to reset this message.• If the message persists, most likely the Magnetic Mount Antenna cable has been damaged. Replace the antenna.
Channel Off Air	<ul style="list-style-type: none">• The channel you've selected is not currently broadcasting. Tune to another channel.

Troubleshooting

If you see this on the screen:	Try this:
Loading	<ul style="list-style-type: none">• Your Onyx EZ is acquiring audio or program information. This message usually goes away in a few seconds.
Updating	<ul style="list-style-type: none">• Your Onyx EZ is updating with the latest encryption code. Wait until the update is done.• You may be trying to tune to a channel that is blocked or unavailable. Tune to another channel.
—	<ul style="list-style-type: none">• No program information, such as artist name, song title, or channel exists.
If this happens:	Try this:
You do not receive all the channels to which you subscribed	<ul style="list-style-type: none">• Ensure that you have subscribed to the service by following the steps in “Subscribe” on page 43.• Go to www.siriusxm.com/refresh and follow the directions to refresh your Radio.• Call 1-866-635-2349 for further assistance.
Audio sounds too soft	<ul style="list-style-type: none">• Raise the volume of your stereo system or increase the audio level of your Onyx EZ until the sound quality improves. Refer to “Set Audio Level” on page 68.
No audio when using the Aux In Cable or Cassette Adapter	<ul style="list-style-type: none">• Check all cables between your Onyx EZ and your vehicle’s stereo system for a firm and secure connection.• Ensure you have selected the proper input source on your vehicle’s stereo system.• Increase the audio level of Onyx EZ. Refer to “Set Audio Level” on page 68.• If you are using the Vehicle Dock that came with the Universal Xpress Car Kit, ensure that the FM Transmitter in Onyx EZ is turned Off.

Troubleshooting

If this happens:	Try this:
Audio fades or has static when listening	<ul style="list-style-type: none">• Check all cables for a firm and secure connection.• If you are using <i>PowerConnect</i> to listen via your vehicle's FM radio, and the problem persists, it most likely is interference from another commercial or broadcast FM station. You will need to find an unused or available FM channel in your area. Refer to "Find Available FM Channels in Your Area" on page 61.• If you are using <i>PowerConnect</i>, and you cannot solve the audio problem, try connecting the audio using the Aux In Cable or a Cassette Adapter. (Refer to page 35 and page 37.) If you cannot use those solutions, consider using an FM Direct Adapter. (Refer to page 42.)
No audio when using <i>PowerConnect</i> or FMDA	<ul style="list-style-type: none">• Check that your Onyx EZ and your vehicle's FM radio are tuned to the same FM channel.• For <i>PowerConnect</i>, ensure you are using the <i>PowerConnect</i> Vehicle Dock and <i>PowerConnect</i> Power Adapter.• If you are using the Vehicle Dock that came with the Universal Xpress Car Kit, ensure that the FM Transmitter in Onyx EZ is turned On. Refer to "Turn FM Transmitter On/Off" on page 77.

Troubleshooting

If this happens:	Try this:
No song title or artist name is displayed	<ul style="list-style-type: none">• The information may not be available or updates may be in progress.
Traffic and Weather channels sound different from other channels	<ul style="list-style-type: none">• These channels use a different audio technology than other channels so they often sound different from other channels.
The demo is playing	<ul style="list-style-type: none">• Your Magnetic Mount Antenna is not connected or you are not receiving the signal. Check that the antenna is connected properly and is not obstructed.• Press and hold the Select button for 10 seconds to exit Demo Mode.• You can disable Demo Mode. Refer to “Demo Mode” on page 73.

Product Specifications

System

Power Requirements:	9-16 V DC, 500 mA (max)
Operating Temperature:	-4°F to +140°F (-20°C to +60°C)
Audio Output:	1.0 V _{rms} (max)

Onyx EZ Radio

Dimensions:	4.5 in (W) x 2.4 in (H) x 0.7 in (D) 115 mm (W) x 61 mm (H) x 17 mm (D)
Weight:	3.4 oz (95 g)

PowerConnect Vehicle Dock

Dimensions:	4.0 in (W) x 2.4 in (H) x 1.2 in (D) 102 mm (W) x 63 mm (H) x 31 mm (D)
Weight:	1.6 oz (46 g)
Audio Connector:	1/8 in (3.5 mm) female
Antenna Connector:	SMB male

PowerConnect Power Adapter

Dimensions:	3.7 in (W) x 1.7 in (H) x 1.3 in (D) 94 mm (W) x 43 mm (H) x 34 mm (D)
Weight:	2.4 oz (69 g)
Input / Output:	9-16 V DC / 5 V DC, 1.5 A
Cable Length:	4 ft 7 in (1.4 m)

Vehicle Antenna

Type:	XM Magnetic Mount
Connector:	SMB female, right angle
Cable Length:	23 ft (7.0 m)

Aux In Cable

Connectors:	1/8 in (3.5 mm) stereo male to 1/8 in (3.5 mm) stereo male
Cable Length:	4 ft (1.2 m)

Patent and Environmental Information

Patent Information

It is prohibited to, and you agree that you will not, copy, decompile, disassemble, reverse engineer, hack, manipulate, or otherwise access and/or make available any technology incorporated in this product. Furthermore, the AMBE® voice compression software included in this product is protected by intellectual property rights including patent rights, copyrights, and trade secrets of Digital Voice Systems, Inc. The software is licensed solely for use within this product. The music, talk, news, entertainment, data, and other content on the Services are protected by copyright and other intellectual property laws and all ownership rights remain with the respective content and data service providers. You are prohibited from any export of the content and/or data (or derivative thereof) except in compliance with applicable export laws, rules and regulations. The user of this or any other software contained in a Sirius XM Radio Inc is explicitly prohibited from attempting to copy, decompile, reverse engineer, hack, manipulate or disassemble the object code, or in any other way convert the object code into human-readable form.

Environmental Information

Follow local guidelines for waste disposal when discarding packaging and electronic appliances.

Perchlorate Material - special handling may apply. See www.dtsc.ca.gov/hazardouswaste/perchlorate (Applicable to California, U.S.A.)

FCC Statement

The user is cautioned that changes or modifications not expressly approved by Sirius XM Radio Inc. can void the user's authority to operate this device.

This device complies with Part 15 of the FCC Rules. Operation is subject to the following two conditions:

1. This device may not cause harmful interference.
2. This device must accept any interference received, including interference that may cause undesired operation.

This equipment has been tested and found to comply with the limits for a Class B digital device, pursuant to Part 15 of the FCC Rules. These limits are designed to provide reasonable protection against harmful interference in a residential installation.

This equipment generates, uses, and can radiate radio frequency energy and, if not installed and used in accordance with the installation instructions, may cause harmful interference to radio communications. However, there is no guarantee that interference will not occur in a particular installation. If this equipment does cause harmful interference to radio or television reception, which can be determined by turning the equipment off and on, the user is encouraged to try to correct the interference by one or more of the following measures:

- Reorient or relocate the receiving antenna of the affected receiver.
- Increase the separation between the SiriusXM equipment and the affected receiver.
- Connect the SiriusXM equipment into an outlet on a circuit different from that to which the affected receiver is connected.
- Consult the dealer or an experienced radio/TV technician for help.

WARNING! The FCC and FAA have not certified this Satellite Radio Receiver for use in any aircraft (neither portable nor permanent installation). Therefore, Sirius XM Radio Inc. cannot support this type of application or installation.

Copyrights and Trademarks

© 2012 Sirius XM Radio Inc. “Sirius”, “XM” and all related marks and logos are trademarks of Sirius XM Radio Inc. and its subsidiaries. “BBC” and “Radio One” are trademarks of the British Broadcasting Corporation and are used under license. BBC logo © BBC 1996. Radio 1 logo © BBC 2001. Cosmopolitan® is a registered trademark of Hearst Communications, Inc. Elvis Radio logo © EPE Reg. U.S. Pat & TM off. IndyCar (and Design) are registered trademarks of Brickyard Trademarks, Inc., used with permission. Major League Baseball trademarks and copyrights are used with permission of Major League Baseball Properties, Inc. Visit the official website at MLB.com. Games subject to availability and change and may not include all spring training games. All rights reserved. NASCAR® is a registered trademark of the National Association for Stock Car Auto Racing, Inc. The NBA identifications are the intellectual property of NBA Properties, Inc. and the respective NBA member teams. © 2011 NBA Properties, Inc. © 2011 NFL Properties LLC. All NFL-related trademarks are trademarks of the National Football League. NHL and the NHL Shield are registered trademarks of the National Hockey League. © NHL 2011. All NHL logos and marks and NHL team logos and marks depicted herein are the property of the NHL and the respective teams and may not be reproduced without the prior written consent of NHL Enterprises, L.P. The Home Ice© channel is a registered trademark of XM Satellite Radio Inc. The Swinger Golfer logo is a registered trademark of PGA TOUR, Inc. Visit www.siriusxm.com/channellineup for updates. All programming/channel lineup/XM service subject to change or preemption. All other marks and logos are the property of their respective owners. All rights reserved.

IMPORTANT NOTICE: REQUIRED SUBSCRIPTION

Hardware and subscription sold separately, and activation fee required. Other fees and taxes may apply. **Subscriptions governed by SiriusXM Customer Agreement; see www.siriusxm.com.** Prices and programming are subject to change. **Service automatically renews into the subscription Package you choose (which may differ from the Package which arrived with the Radio), for additional periods of the same length, and automatically bills at the then current rates, after any complimentary trial or promotional period ends, until you call us at 1-866-635-2349 to cancel.** XM U.S. Satellite service available only to those at least 18 years of age in the 48 contiguous USA and DC, while SiriusXM Internet Radio is available throughout our satellite area and also AK, HI and PR.

Owners Record

The Radio model number is located below and the XM Radio ID is located on the label on the back of Onyx EZ.

Record the XM Radio ID in the space provided below. Refer to these numbers whenever you call your dealer regarding this product.

Radio Model Number: XEZ1

XM Radio ID: _____

Sirius XM Radio Inc.
1221 Avenue of the Americas
New York, NY 10020

1.866.635.2349

siriusxm.com

© 2012 Sirius XM Radio Inc.

XEZIVKUG 121105a