



Xpress^R



user guide
XMCK20

Quick Start

1. Set up your Xpress^R
2. Activate your XM subscription online <http://activate.xmradio.com> or by phone 1 800 XM RADIO (1-800-967-2346)
3. Listen to XM*
4. Manage your channels using presets

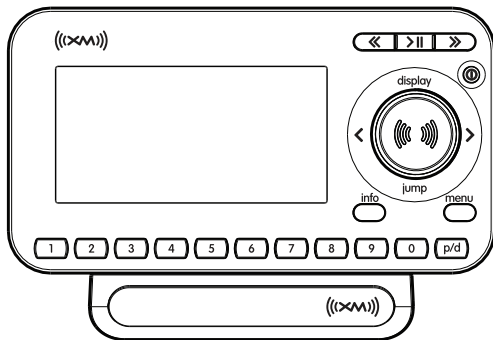

*Hardware and required monthly subscription sold separately. Installation cost and other fees and taxes, including a one-time activation fee may apply. Subscription fee is consumer only. XM products, programming, services, and fees are subject to change, at any time, without notice. Channels with frequent explicit language are indicated with an XL. Channel blocking is available for XM radio receivers by calling 1-800-XM-RADIO. Subscriptions subject to Customer Agreement available at xmradio.com. XM service only available in the 48 contiguous United States. ©2007 XM Satellite Radio Inc. All rights reserved.

Introduction	4	Menu Options	37
Features.....	4	Change Display	37
Safety Instructions.....	5	Edit Alerts.....	39
What's in the Box	7	Stocks	41
Xpress ^R Controls	8	Info Extras	42
Remote	9	Channel Access	43
Using this Guide	10	Antenna Aiming	45
Vehicle Installation	11	Set Time	46
Mounting the XM Antenna	14	Factory Defaults.....	49
Installing the Vent or Swivel Mount	15	FM Modulator	49
How to Receive XM Through your Car's Stereo	18	Line Out	51
Making Your FM Radio an XM Radio ..	22	Set Tone	52
Activation	25	Customer Support	53
Using your Xpress^R	27	Troubleshooting	54
Xpress^R Controls		Specifications	56
Listening to Live XM.....	28	Product Registration	58
Direct Entry	29	Patent Information	59
Using Presets.....	29	FCC Statement	60
Categories	30	Warranty	61
Jump	30		
Info	31		
Display.....	31		
30-Minute Replay	33		
TuneSelect	36		

Features

Congratulations on your purchase of the Audiovox Xpress[®]™. Your new Xpress[®] includes:

Multi channel monitoring, view six channels at once

View current and previous channels at the same time

Shortcut to FM frequencies

Scan music category

30 minute Replay- Pause and replay up to 30 minutes of live broadcast.

GameSelect- Finds your favorite sport and team events.

TuneSelect- Finds your favorite songs by song title or artist name if they are currently playing on any XM channel.

Personalized Stock and Sports Tickers- Track your favorite stocks and sports scores on your Xpress[®]'s display while listening to your favorite music.

A bright, white LED backlit display with "Auto Dimming" capabilities.

Enjoy XM's 170 channels from coast to coast, with over 80,000 hours of entertainment each month. XM offers musical choice, variety, and discovery – worlds beyond your own collection – plus a wide range of news, sports, talk, comedy, kids, and entertainment channels. Hear XM live, or replay what you missed.

We recommend that you read the entire manual before using your Xpress[®].

Safety Instructions

Please read and understand all the instructions to avoid injury to yourself and/or damage to your Xpress[®]. Please be aware that XM claims no responsibility for damage from data loss due to breakdown, repair, or other causes.

Xpress[®] Digital Audio Player

- Do not expose to extreme temperatures (above 140°F or below -4°F, or above 60°C or below -20°C).
- Do not expose to moisture. Do not use Xpress[®] near or in water.
- Do not let any foreign matter spill into Xpress[®].
- Do not expose to chemicals such as benzene and thinners. Do not use liquid or aerosol cleaners. Clean with a soft damp cloth only.
- Do not expose to direct sunlight, fire, flame or other heat sources for a prolonged period.
- Do not try to disassemble and/or repair Xpress[®] yourself.
- Do not drop your Xpress[®] or subject it to severe impact.
- Do not place heavy objects on Xpress[®].
- Do not subject Xpress[®] to excessive pressure.
- Do not touch the Xpress[®] with wet hands.
- Do not store in dusty areas.

Caution: Opening the case may result in electric shock.

Caution: The uninsulated parts inside the power adapter and cradle may cause electric shock or fire. For your safety, please do not open these components. Do not let metallic objects, such as necklaces or coins, come into contact with the power adapter plugs.

Caution: To avoid electric shock, use the power adapter only with an outlet that matches the shape of the adapter's plug.

Caution: Make sure that you insert the adapter's plug all the way into the outlet.

Caution: Do not plug several devices into the same electrical outlet.

Important: Always read and understand the user guide to prevent problems.

Warning: Use the power adapter and cradle away from water sources to avoid fire or electric shock.

Environmental Information

- Follow local guidelines for waste disposal when discarding packaging and electronic appliances.
- Your Satellite Radio receiver is packaged with cardboard, polyethylene, etc., and does not contain any unnecessary materials.

▲ Warnings

- When using this product it is always important to keep your eyes on the road and hands on the wheel. Not doing so could result in personal injury, death, and/or damage to your Xpress[®] Receiver, accessories, and/or to your vehicle or other property.
- Xpress[®] should be placed in your vehicle where it will not interfere with the function of safety features, e.g., deployment of airbags. Failure to correctly place Xpress[®] may result in injury to you or others if the unit becomes detached during an accident and/or obstructs the deployment of an airbag.

What's in the Box?

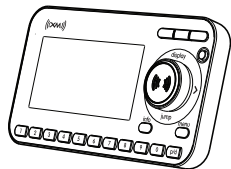

Xpress^R

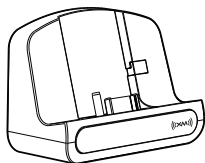

Car Cradle

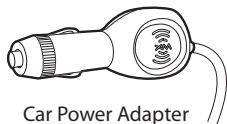

Car Power Adapter

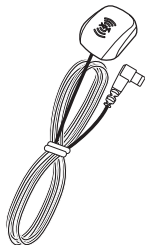

XM Car Antenna

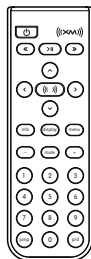

Remote Control

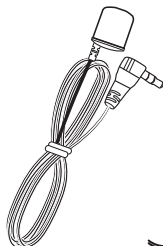

XM SureConnect

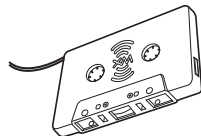

Cassette Adapter



Swivel Mount



Swivel Mount Preparation Kit

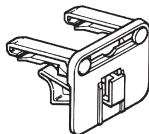

Vent Mount

Xpress^R Functions

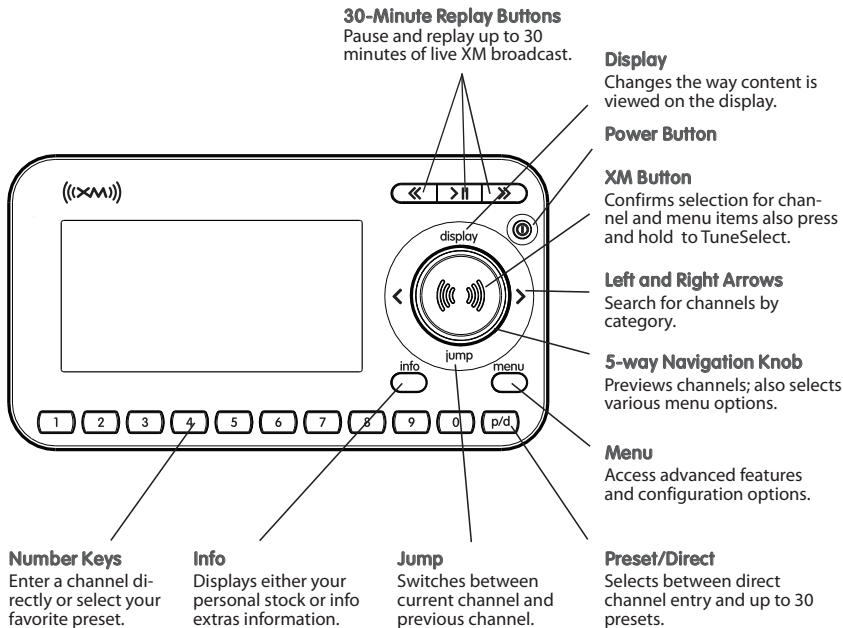

Remote Control Functions

Power Button

30-Minute Replay Buttons

Pause and replay up to 30 minutes of live XM broadcast

XM Button

Confirms selected channel or menu options.

info

Displays either your personal stock or info extras information.

Mute

Silences live or replayed XM content.

Number Keys

Enter a channel directly or select your favorite preset.

Jump

Switches between current channel and previous channel

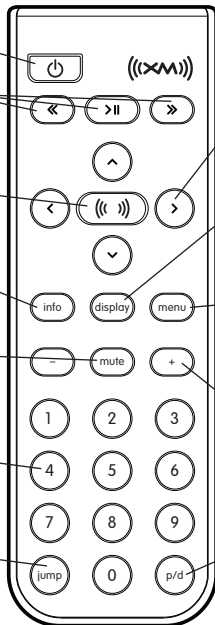

Arrow Buttons

Select menu entries, change channels.

Display

Changes the way content is viewed on the display

Menu

Access advanced features and configuration options.

+ and -

Change channels or control volume for audio system (sold separately)

Preset/Direct

Selects between direct channel entry and up to 30 presets.

Using the 5-way Navigation Knob

The knob not only rotates, but it toggles. To toggle the knob, press on the edge and in the direction you want to toggle.



Press center button
(XM button)

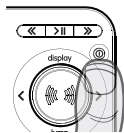

Toggle right

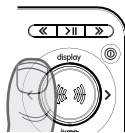

Toggle left

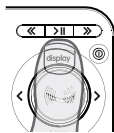

Toggle up

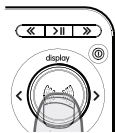

Toggle down

Using This Guide

Throughout this guide, you will see instructions such as Select **Menu** → **Antenna Aiming**. This tells you to perform the following actions:

1. Press the **Menu** button.
2. You will see a menu icon that represents “Antenna Aiming.” Rotate knob to highlight **Antenna Aiming**, then press the **XM** button to select it.

Not all of the menu items described in this guide may appear on your Xpress^R display. Some menu items will only be seen when Xpress^R is used in an accessory home kit or boombox (Sold Separately).



vehicle installation

Vehicle installation

Every vehicle is different; for your safety, follow all instructions carefully. Consult a professional installer if you have questions.

1. To begin, first decide which method of installation is best for your vehicle:

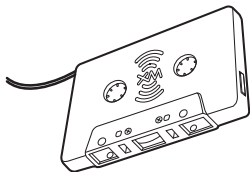

Cassette Adapter

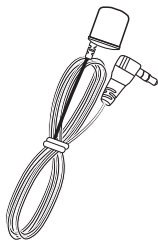

XM SureConnect

Cassette Adapter: Use the cassette adapter if your vehicle's audio system has a built in cassette player.

XM SureConnect: You can listen to your Xpress[®] through your car stereo by using Xpress[®]'s built-in FM modulator and the XM SureConnect. Simply find an unused FM frequency on the stereo and set your Xpress[®] to transmit on that same frequency. See your XM SureConnect installation guide.

FM Direct Adapter: The third option is the FM Direct Adapter (sold separately). We recommend professional installation if you choose to use this method of install.

Audio input: Some vehicles come with an audio input jack. If your vehicle has this type of input you can simply use a mini audio cable (sold separately).

2. Once you have chosen your method of installation, next decide where in your vehicle you would like to mount your Xpress^R. The two included methods are vent mount and swivel mount:

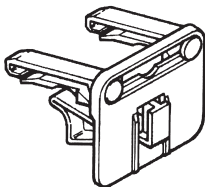

Vent Mount

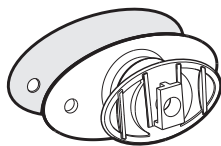

Swivel Mount

3. Next decide the best location for your XM antenna. Mount this antenna to the roof or trunk of the vehicle. During installation, make sure you are outdoors and the antenna is not obstructed by tall buildings.
4. Finally you will connect all of the plugs to the car cradle and lock your Xpress^R into place. Once in place you can activate your Xpress^R.

Now that you have all of the parts you need, you are ready to begin installing your Xpress^R.

Step 1: Mounting the XM Antenna

Mount the XM antenna to the roof or trunk of the vehicle. During installation, make sure you are outdoors and the antenna is not obstructed by tall buildings. For best results mount the XM antenna to the outside of your vehicle. Below are the recommended options.

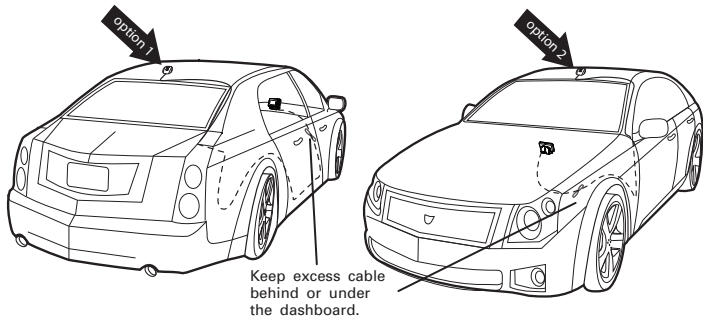
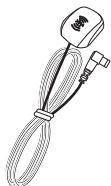

The XM antenna contains a strong magnet, allowing it to stick to any metal parts of your vehicle.

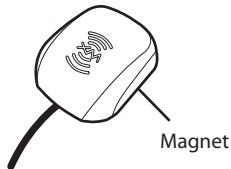

Step 2: Installing the Vent Mount or Swivel Mount

Installing the vent mount

To install the vent mount, find a horizontal vent that is strong enough to hold your Xpress^R and car cradle. To remove the vent mount, push it into the vent and lift upwards slightly to release the mount's hooks from the vent vane.

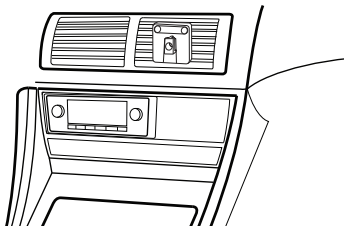
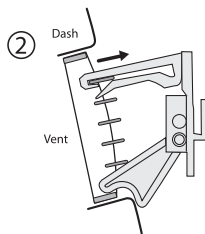
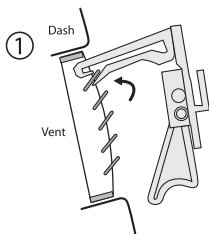

Some parts of the vent mount can be adjusted to better suit your vent.

Installing the swivel mount

To install the swivel mount, first find a suitable location. The swivel mount's adhesive is very strong and may be difficult to remove. Do not install this mount on leather surfaces and make sure the air temperature is at least 60°F (15°C).

Clean the mounting surfaces with the surface preparation kit.

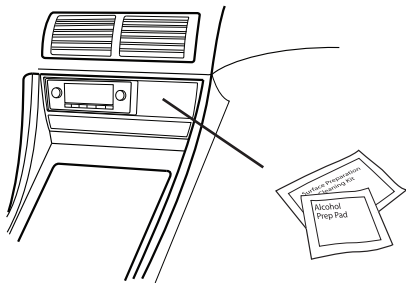

Peel away the adhesive liner and firmly press the swivel mount to the surface for 30 seconds. Allow 24 hours before using the mount

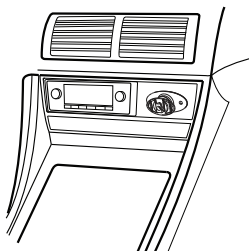
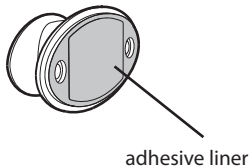

You can orient your swivel different ways to accommodate the space available in your vehicle.

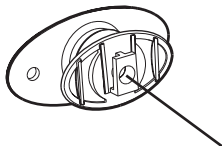

You can adjust this screw to adjust the tension of the mount with a screwdriver.

If you need to remove the mount, carefully lift the adhesive pad with your fingers or a spoon. Warming with a hair dryer for several minutes will help soften the adhesive. Your swivel mount comes with an extra adhesive pad.

Step 3: How to receive XM through your car stereo

There are several methods of receiving XM through your car stereo

Cassette Adapter: Use the cassette adapter if your vehicle's audio system has a built in cassette player.

XM SureConnect: You can listen to your Xpress[®] through your vehicle's audio system by using Xpress[®]'s built-in FM modulator and the XM SureConnect. Simply find an unused FM frequency on the stereo and set your Xpress[®] to transmit on that same frequency. **For XM SureConnect install, please see your XM SureConnect Installation guide.**

Professional Wired: The third option is the FM Direct Adapter (sold separately). We recommend professional installation if you choose to use this method of install.

Audio input: Some vehicles come with an audio input jack. If your vehicle has this type of input you can simply use a mini audio cable (sold separately).

Plug the antenna, power adapter, and either the cassette adapter or XM SureConnect into the car cradle as shown on the next page. The FM Direct Adapter is not pictured.

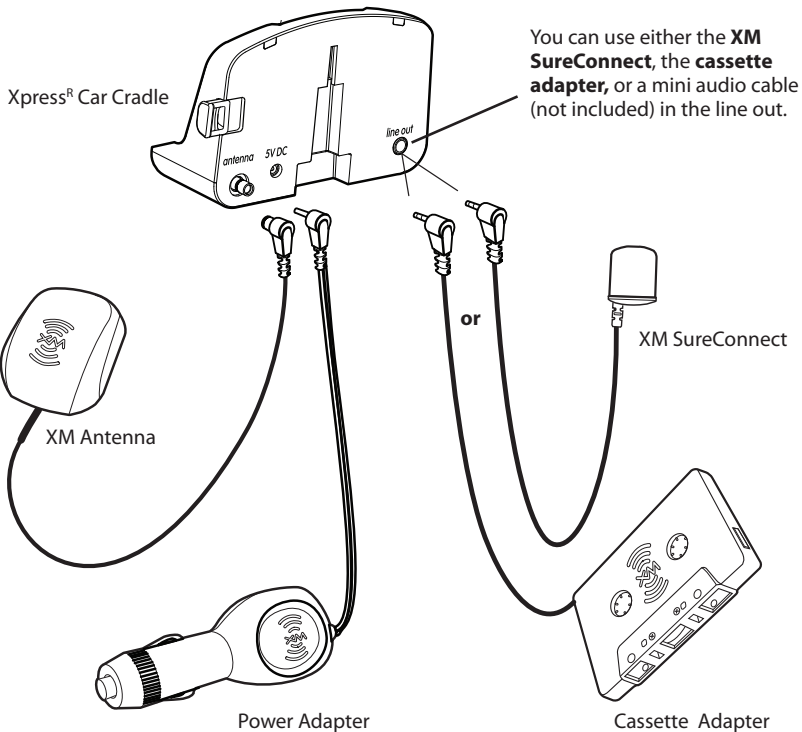

Once you have all of the cables correctly connected you can lock your Xpress[®] into the car cradle.

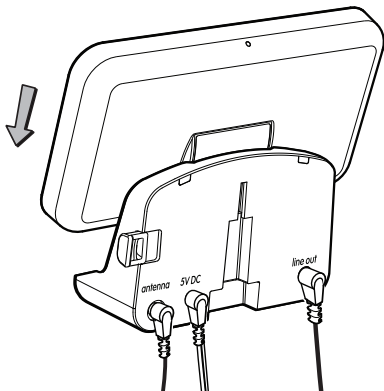
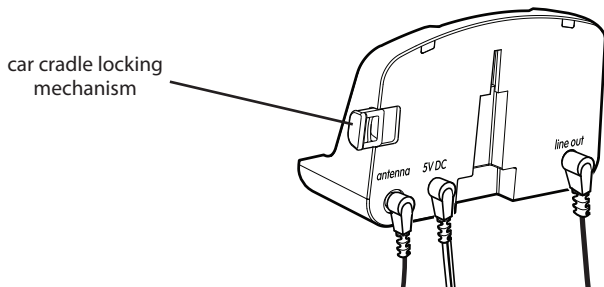

Slide your Xpress[®] into the car cradle until it is in place.

Note: Make sure the car cradle is in the unlocked position before inserting your Xpress[®].

Slide the locking mechanism into place. This ensures that your Xpress^R always stays in place.

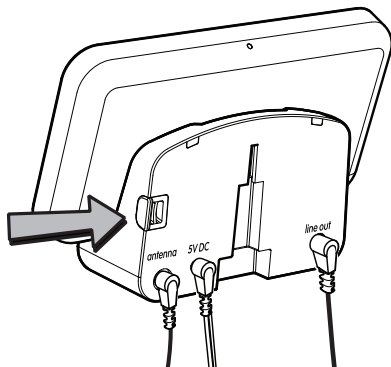

If you haven't already done so, hook the car cradle to the mount.

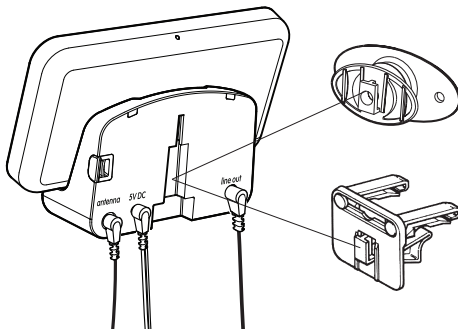

Now that your Xpress[®] is all set up, it is time to power it up. If you are using the XM SureConnect you will need to read Step 4. If you are using the cassette adapter you are all finished and ready to move on to activation on page 26.

Step 4: Making Your Vehicle's FM Radio an XM Radio

Your Xpress[®] contains a built-in FM modulator that transmits the XM audio signal to your vehicle's FM radio.

First, turn on your car stereo. You will need to find a suitable FM frequency in order to get the best sound. A suitable FM frequency is an unused frequency or weak station that is not located near a strong FM station in your area. Follow the steps below for more help:

1. Go to www.xmradio.com/fmlocator for recommended FM frequencies in your area.
2. Enter your local USPS Zip Code.
3. You will see the recommended FM frequencies in your area. Try the "vacant" channels first.
4. Set your vehicle's FM radio to one of the recommended frequencies. Now set your XM receiver to the same frequency using the menu settings. For more information, see FM Frequency on page 49
5. If the audio quality is not satisfactory, you can repeat these steps by choosing another frequency.

You will see a chart that looks like this:

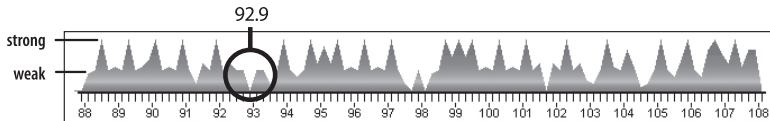

This chart represents the FM channels in the Washington, DC area. The spikes represent the strength of the FM channel. Someone in DC would choose a “vacant” channel like 92.9 that is unused and located between two weaker channels.

Sample Search Results for Major US Markets:

City:	Zip Code:	FM Channels:
New York City	10199	88.5, 91.9, 95.1
Los Angeles	90052	99.1, 101.5, 107.9
Chicago	60607	89.1, 90.7, 91.1
Houston	77201	88.1, 95.1, 97.3
Washington, DC	20090	92.9, 97.7, 98.1

Next, power on your Xpress[®]. Be sure all of your cables are properly connected. Go to channel 1, this is the preview channel. You will not hear any sound through your vehicle’s audio system until you have chosen an FM Frequency.

Note: Xpress[®] will automatically enter a demo mode if either of these two conditions exists:

1. If your XM antenna is not connected and your Xpress[®] is not activated.
2. If your XM antenna is connected, you are not receiving a signal, and your Xpress[®] is not activated.

Note: Your XM radio may not modulate on each of the frequencies shown on the Radio-Locator site. Check your Xpress[®] for the frequencies that are usable for you.

Press **Menu** → **FM Modulator**  → **FM Frequency**.
Match the frequency to the frequency you see on your car's FM radio

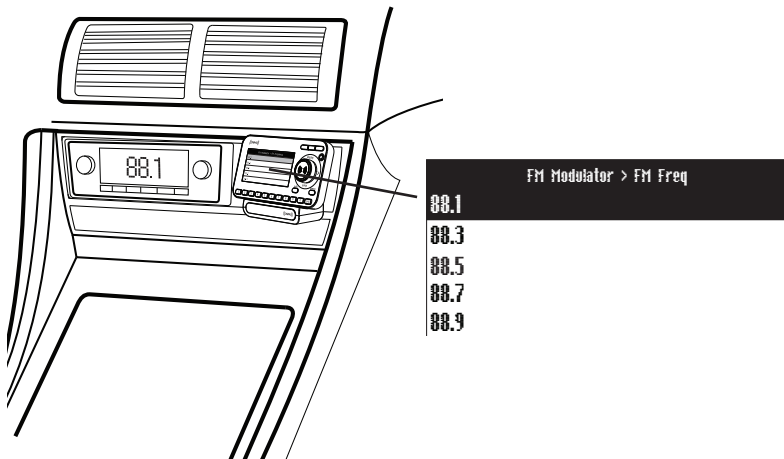

Now you should be able to hear your Xpress[®] through your FM stereo. If you can't hear any sound please check all of your connections and be sure your XM antenna is not obstructed. Visit Troubleshooting (page 54) for more information.

Now you will learn how to activate and use your Xpress[®].

2

activation

Before you can listen to XM content, you must activate your Xpress[®].

1. Set up your Xpress[®], car cradle, power adapter, and antenna (pages 11- 24). Make sure Xpress[®] can receive the XM signal.
2. Find the 8-character XM Radio ID, which is printed on the package or on the back of your Xpress[®]. Or select XM channel 0 to view the Radio ID. Record the Radio ID here for reference:

--	--	--	--	--	--	--	--

The XM Radio ID does not use the letters I, O, S, or F.

4. Activate your XM Satellite Radio service online at <http://activate.xmradio.com> or by calling 1 800 XM RADIO (1-800-967-2346). You will need a major credit card. The website will walk you through activation, selecting a service plan, and creating an XM account.

XM will send a signal from the satellites to activate the full channel lineup. Activation normally takes 10 to 15 minutes, but during peak busy periods you may need to keep your Xpress[®] on for up to an hour. When you can access the full channel lineup on your Xpress[®], you're finished!

3

using your Xpress[®]

Listening to Live XM

Turn on your Xpress[®]. Subscribe to XM (page 26) if you haven't done so already.



Selecting Channels

Rotate the knob to scroll through the list of channels. Press the **XM** button to select that channel. You can also set up Xpress[®] so that you do not have to press the **XM** button to select a channel. See "Direct Tune" on page 43.

- OR -

Press the number keys on your Xpress[®] or the remote that correspond to the channel number.

- OR -

Pressing one of the preset buttons that correspond to the channel number. When you've entered a valid channel number, your Xpress[®] will tune to that channel within 2 seconds.

Direct Entry

1. Press the **p/d** button until the word “Direct” appears in the display.
2. Press the number keys corresponding to the channel number. For example, for channel 31, press **3** followed by **1**. You can select the channel faster by pressing the **XM** button after entering the channel number.

Using Presets

There are 30 presets in all; each bank (A, B, and C) holds 10 presets. Press the “p/d” button to select the proper bank. Use these banks to organize your favorite channels or to create separate preset banks for additional users to enjoy. To set a channel preset:

1. Tune to the desired channel.
2. Press the **p/d** button until the appropriate “Preset” bank (Preset A, B, or C) appears in the display.
3. Press and hold the number key that corresponds to the preset you would like to set. Xpress[®] beeps when the channel is stored.

To select a stored preset:

1. Press the **p/d** button until the appropriate “Preset” bank (Preset A, B, or C) appears in the display.
2. Press one of the number keys. Xpress[®] will tune to that channel.

Categories

XM channels are organized into categories, or genres, such as "Rock," "Jazz," or "News."

To find a channel by category:

1. Toggling the knob left and right will display categories
2. Rotate knob and press the **XM** button to select a channel

Preset categories are displayed within categories only when channels are assigned to those presets (see Using Presets).

When you are browsing the channels by category you have the option to Scan all channels in that category, or to revert back to the all channels list.

When you choose scan, each channel in the category plays for 5 seconds. To stop scanning, press the XM button to select that channel.

While a category is being scanned, the word "Scan" will flash on and off.

Classical	
XM Classics	110
Vox!	112
XM Pops	113
>Scan Classical	
>All Channels	

Jump

Press the **jump** button to switch to the channel that was previously being listened to. Pressing the **jump** button more than once allows you to switch between two channels at a time. Display mode 4 allows you to view both current channel and previous channel at the same time.

Info

Press the **info** button to display either stock quotes or Info Extras. See pages 41 and 42 for more information on each of these features.

Display

Press the **display** button to change the way you view the content on the display. There are 4 different display modes.

XM Cafe	45
	REM
	Drive

Display mode 1
(single channel large font)

Tal	Direct	5:13
XM Cafe		45
		REM
		Drive

Display mode 2 (single channel)

Tal	Direct	5:14	All Channels
XM Cafe	45	XMU	43
		REM	Fred
		Drive	XM Cafe
			Top Tracks
			Ethel

Display mode 3 (split display with 6 channels)

Tal	Direct	5:15	Previous Channel
XM Cafe	45	Bluesville	74
		REM	B.B. King
		Drive	Take it Home

Display mode 4
(split display with previous channel)

Turning the knob in display modes 1, 2 and 4 display the “All Channels” list with the current channel you are listening to as the highlighted channel. Turning the knob in display mode 3 scrolls through the displayed channel list. When using left and right arrow to view categories, turning the knob scrolls through the channels within that category.

Display Mode 3

When in display mode 3, you can view channel names, artist names or song titles in the displayed channel list. To change the way this content is displayed the channel list must be active. Turn the knob or toggle the knob in either the left or right direction to make the displayed channel list active.

Tal	Direct	5:14	All Channels
XM Cafe	45	XMU	43
	REM	Fred	44
	Drive	XM Cafe	45
		Top Tracks	46
		Ethel	47

Be sure a channel within the displayed channel list is highlighted before pressing “display.” If it is not highlighted you will switch to display mode 4 instead.

Channel name is displayed

Tal	Direct	5:14	All Channels
XM Cafe	45	Coldplay	43
	REM	U2	44
	Drive	REM	45
		Led Zeppelin	46
		Red Hot Chili Pe	47

Artist name is displayed

Tal	Direct	5:14	All Channels
XM Cafe	45	Clocks	43
	REM	New Year's Day	44
	Drive	Drive	45
		Whole Lotta Lov	46
		Snow (Hey Oh)	47

Song title is displayed

If you have channels assigned to your presets, channel numbers will be displayed with the preset number rather than the channel number.

Tit	Preset A-1	11:55	Preset A
Ethel	47	Ethel	A-1
	Coldplay	U-POP	A-2
	Clocks	Fuego sp	A-3
		>Scan Preset A	
		>View All Channels	

Channel numbers assigned to your current preset will be displayed with the preset number rather than the channel number.

You can revert back to “All Channels” by selecting “View All Channels”. You can also scan each preset channel.

You are able to view your presets by channel name, artist name, or song title by pressing “display.” Be sure that one of the channels is highlighted before pressing “display.” (See page 32 for more information). You can also toggle left and right to view categories.

30-Minute Replay

30-Minute Replay gives you the opportunity to “hear that again.” This feature applies to the current listening session only. Turning your Xpress® off removes all tracks from the up-to-30 minute buffer.

Both display modes 3 and 4 display a list of replayed tracks. To navigate through the “replay list”, you can either rotate the knob and press the “XM” button or press the replay buttons to select a track.

Display mode 2 (single channel)

Display updates as new track begins.

Replay Status Bar represents the total replay session

Displays elapsed time of current track within the replay buffer.

Space between white bars represents tracks within total replay session.

Displays total time of current track within the replay buffer.

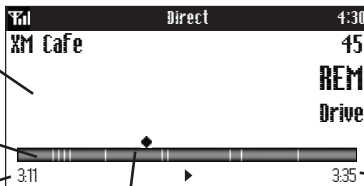

Display modes 3 and 4

Ttl	Direct	5:35	Replay List
XM Cafe	45	U-POP	29
	REM	U-POP	29
	Drive	XM Cafe	45
		XM Cafe	45
		XM Cafe	45

At the bottom left of the table, there is a small replay status bar with '3:11' on the left and a white triangle pointing right.

Both split display modes (6 channels mode and view previous channel) display a list of replay content. You can choose to display artist names, song titles or channel names within the replay list by pressing **display**.

Older info is displayed at the bottom of the list. As new content is added, it appears at the top of the list.

In display mode 1 (large font) you will only see play, pause, rewind, or fast-forward symbol in the top right corner next to the channel number, when in replay mode.



When you are in Display mode 1 (large font) or Display mode 2 (single channel), you can access the replay list by turning the knob. You can change the way the information is displayed by pressing "display" while the list is visible.

Navigating Replay

1. Press the ◀ button. If a track has been playing for less than 5 seconds, Xpress[®] rewinds to the beginning of the previous track. If the track has been playing for longer than 5 seconds, Xpress[®] rewinds to the beginning of the current track. Upon entering the replay buffer, Xpress[®] will display "Replay" on the display.
2. Pressing the ◀ button again skips backward to previous tracks in the order they played. Xpress[®] allows you to access up to 30 minutes of previously listened to live broadcast. Press and hold ◀ for 3 seconds to skip to the beginning of your replay list.
3. Pressing the ▶ button skips forward in the track list.
4. To exit 30-Minute Replay and return to the live XM broadcast, press and hold the ▶ button for 3 seconds; Xpress[®] will display "LIVE" on the display.

To Pause a Track

1. Press the >|| button. The pause icon appears in the display.
2. To resume playback from where you had paused, press the >|| button again.
3. To return to the live XM broadcast, press and hold the >> button until Xpress[®] beeps and displays "LIVE" on the display.

TuneSelect

TuneSelect finds your favorite artist or song whenever they're currently being played on any XM channel. Xpress[®] can track up to 20 of your favorite artists or songs.

To TuneSelect a song or artist:

1. At any live display press and hold the knob for 3 seconds
2. Choose between TuneSelecting the artist or TuneSelecting the song
3. When any song or artist in your TuneSelect list is currently playing on any other XM channel, Xpress[®] will alert you audibly and visually. Tune to that channel by pressing the **XM** button.

To edit your TuneSelect list see "Edit Alerts" under the Menu Items page. When you attempt to add more than 20 artists or songs, your Xpress[®] will give you the option to replace one of your previously saved selections

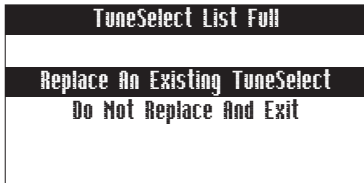
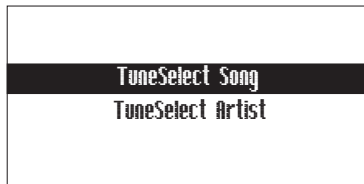

Menu Options

When your Xpress[®] is in the car cradle (and using either SureConnect or FM Direct accessory to transmit audio), and you press **Menu**, your display will look like this:

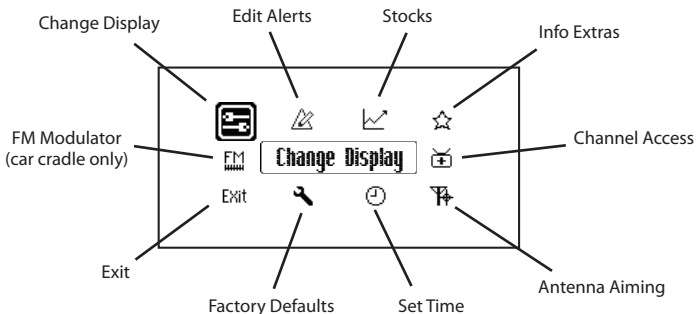

Note: pressing the **Menu** or toggling the knob left, allows you to back out of any menu.

Change Display

Display Settings

To change the display's brightness, contrast, backlight timer, and Auto Dimming status:

1. Press the **Menu** button, scroll to **Change Display** → **Display Settings**.
2. Rotate knob to scroll through items on display.
3. Press the **XM** button to select an item.
4. Rotate knob to adjust the selected item.
5. Press the **XM** button to confirm your selection.
6. Then press either the **Menu** button or toggle the knob to the left repeatedly until you return to normal operation.

Leaving the Auto Dimming feature "off" means the user has to manually adjust the brightness of the display. Enabling the Auto Dimmer (turning it "On") means that Xpress® adjusts the brightness of the display for daytime and night time mode.

Display Scrolling

At times cold weather can negatively affect the visual quality of scrolling text. Display scrolling can be enabled or disabled globally. By default Display Scrolling is set to "On". When Display Scrolling is set to "On", all on display items such as Artist Name, Song Title, Info Extras, and Stock information that need to scroll have the ability to do so. Setting Display Scrolling to "Off" disables all items from scrolling allowing only to page.

To disable all display scrolling:

1. Press the **Menu** button, scroll to **Change Display → Display Scrolling (On)**

A confirmation display will be displayed stating Display Scrolling is "Off". All on display information will Page instead.

To enable all display scrolling:

1. Press the **Menu** button, scroll to **Change Display → Display Scrolling (Off)**

A confirmation display will be displayed stating Display Scrolling is "On"

Edit Alerts

Edit TuneSelect

TuneSelect finds your favorite artist or song whenever they're currently being played on any XM channel. To edit your TuneSelect list:

Press the **Menu** button, scroll to **Edit Alerts → Edit TuneSelect**.

A list of songs and or artists that have been TuneSelected will be displayed. Select an artist or song to change its alert status or choose to delete the TuneSelect. Xpress® can track up to 20 of your favorite artists and songs.



TuneSelected by song



TuneSelected by artist



Alert is turned off for that item

Edit GameSelect

Adding sports and teams at the info extras menu in which XM broadcasts (see page 42) automatically adds those sports and teams to your GameSelect list. GameSelect finds and alerts you as to whenever your favorite sports and teams are being played on any other XM channel. Xpress® will store up to 50 GameSelects. To edit your GameSelect list:

Press the **Menu** button, scroll to **Edit Alerts** → **Edit GameSelect**.

A list of sports and teams that you have added will be displayed. Select a sport or team to change its alert status. Xpress® can track up to 50 of your sports and teams.

Note: You will only receive a GameSelect alert on those events in which XM broadcasts.

All Alerts

Selecting All Alerts changes the status of all alerts globally. By default All Alerts are “On”.

To disable All Alerts:

1. Press the **Menu** button, scroll to **Edit Alerts** → **All Alerts (On)**

A confirmation display will be displayed stating All Alert is "Off". All audible and display alerts are disabled.

To enable All Alerts:

1. Press the **Menu** button, scroll to **Edit Alerts** → **All Alerts (Off)**
2. Enable any GameSelect or TuneSelect alert when all alerts are set to "Off".

A confirmation display will be displayed stating All Alert is "On". All audible and display alerts are enabled.

Stocks

XM Satellite Radio broadcasts information such as sports scores, stocks, and other features. Xpress[®] can track up to 20 of your favorite stock symbols, displaying the price and daily movement on the display.*

To add a stock symbol:

1. Press the **Menu** button, scroll to **Stocks** → **Add Stocks**
2. Use the scroll wheel (or remote) to select each letter in the desired stock symbol. Press the **XM** button after each letter.
3. Press the **XM** button to confirm and save the stock symbol in memory.
4. Press the **Info** button once to view your personal Stock Ticker at any live XM display.



*You can track any stock and most indices listed on the NYSE, AMEX, or NASDAQ. Market information is delayed approximately 25 minutes. Stock data provided by ComStock, Inc.

Note: Xpress[®] has an embedded list of more than 9,000 regularly traded stock symbols that helps complete partial entries and prevents you from entering a non-existent symbol.

To erase a stock symbol:

1. Press the **Menu** button, scroll to **Stocks** → **Erase Stocks**
2. Xpress[®] displays a list of the stock symbols you have created. Highlight stocks by using the scroll wheel and select a stock using the **XM** button to make your choice. Choose **yes** from the decision display to erase the stock symbol. Erasing the stock symbol will remove it from the list.
3. Press the **Menu** button several times to return to normal operation.

Info Extras

XM Satellite Radio will broadcast additional information such as sports scores and other useful information features. Xpress[®] can track up to 50 of your favorite Sports and or Teams.

To Choose Sports or Teams:

1. Press the **Menu** button, scroll to Info Extras> Sports. A list of sports will be displayed.
2. scroll to highlight a sport or team.
3. Press the **XM** button to select that sport or team. The “-” symbol in front of the sport or team will be replaced with a “+” symbol. The “+” symbol being added to the front of the sport or team indicates:
 - The sport or team is added to your info extras.
 - The sport or team information will be displayed at any live XM display.

- The sport or team is added to your GameSelect list if broadcast on XM. GameSelect finds and alerts you when your favorite sports and teams are being played on any other XM channel. To Edit your GameSelect list see page 40.

Note: You will only receive a GameSelect alert on those events in which XM broadcasts.

4. Press the **Info** button to view your info extras on any live XM display.

XM	Direct	5:13
XM Cafe		45
		REM
		Drive
Sports		
	Sports scores provided	

XM	Direct	5:13
XM Cafe		45
		REM
		Drive
Stocks		
	Stock Quotes provided	

Channel Access

Direct Tune

Normally, as you scroll through live XM channels while rotating the knob, you can preview the channel list before selecting one channel. Xpress[®] does not switch to that channel until you push the XM button. You can change this behavior so that Xpress[®] automatically tunes to the channel that you're previewing.

To enable Direct Tune:

1. Press the **Menu** button, scroll to **Channel Access** → **Direct Tune (Off)**

A confirmation display will be displayed stating Direct Tune is "On". Xpress[®] will automatically tune to the channel that you preview.

To disable Direct Tune:

1. Press the **Menu** button, scroll to **Channel Access** → **Direct Tune (On)**

A confirmation display will be displayed stating Direct Tune is "Off". Xpress® returns to its default state: you have to push the **XM** button to switch to a channel

Channel Skip/Add

You can simplify the list of channels that you see when you browse through categories or the all channels list by selecting channels to skip.

To skip a channel:

1. Press the **Menu** button, scroll to **Channel Access** → **Channel Skip/Add**
2. Xpress® displays a list of channels. By default, a "+" is in front of each channel. The "+" symbol indicates the channel is not skipped within the channel list.
3. To skip a channel, use the scroll wheel to highlight a channel. Press the **XM** button to change the "+" to a "-". The "-" symbol indicates the channel is skipped within the channel list.
4. To add a channel back to the channel list, use the scroll wheel to highlight a skipped channel. Press the **XM** button to change the "-" to a "+".
5. Pressing either the **Menu** button or toggle the **XM** button to the left, Xpress® displays a confirmation display stating the channel list has been updated.

Explicit Language Channels

Those channels identified with a “xL” in front of the channel name are “Explicit Language Channels”. You can choose to skip all “Explicit Language Channels” by performing the following steps:

1. Press the **Menu** button, scroll to **Channel Access** → **Explicit Language Channels (On)**

A confirmation display will be displayed stating all Explicit Language channels are “Off”. All Explicit Language channels will be removed from the channel list and the channel list at the channel skip/add sub menu.

To add all “Explicit Language Channels” to the channel list:

1. Press the **Menu** button, scroll to **Channel Access** → **Explicit Language Channels (Off)**

A confirmation display will be displayed stating all Explicit Language channels are “On”.

Note: You can still tune to skipped channels by entering the channel number (in direct entry mode) or by pressing a preset (in preset mode) if that channel has already been stored. This is not considered an appropriate method for performing “parental control.” Channel Skip/Add should not be used as a form of parental control. To completely block access to an XM channel, contact XM Listener Care at **1-800-XM-RADIO (1-800-967-2346)** or online at **<http://www.xmradio.com/parentalcontrols/index.jsp>**.

Aiming the Antenna

For optimal reception of XM's live satellite signal, your Xpress[®] antenna should have an unobstructed view of the XM satellites in the southern sky. In large cities, XM also has a network of ground repeaters to help increase the signal coverage.

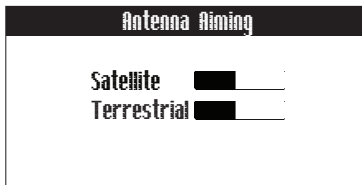

Your Xpress[®] can help you aim the antenna to pull in the strongest possible signal.

1. Press the **Menu** button, scroll to **Antenna Aiming**
2. Slowly turn and tilt the antenna. The "Satellite" and "Terrestrial" signal bars will change. Find the position that gives the strongest signal strength on either "Satellite" or "Terrestrial."
3. The antenna aiming display remains as long as it's needed to help you position the antenna. When you've found the best position, press the "menu" button or left toggle repeatedly to exit the menu.
4. Select XM channel 1. You should be able to listen to the XM Preview Channel.

Set Time

Set Clock

Select Time Zone

The time is automatically set using the XM signal. To set the correct time for your location:

1. Press the **Menu** button, scroll to **Set Time** → **Set Clock** → **Select Time Zone**

Scroll through the list of time zones and select your time zone, the Xpress^R clock will update.

Daylight Savings Time

You can also choose whether or not to adjust your settings for daylight savings time.

1. Press the **Menu** button, scroll to **Set Time** → **Set Clock** → **Daylight Savings Time**

12/24 Hour Mode

To display time in 12 or 24 hour format, select the desired format by **Set Time** → **Set Clock** → **12/24 Hour Mode**.

Automatic Power

Normally, Xpress^R turns on whenever it receives power. To disable automatic power:

1. Press the **Menu** button, scroll to **Set Time** → **Automatic Power (On)**

When Automatic power is set to "Off", you must now use the power button to turn Xpress^R on and off.

To enable automatic power:

1. Press the **Menu** button, scroll to **Set Time** → **Automatic Power (Off)**

Xpress^R turns on automatically whenever it receives power.

Sleep Timer (Home stand option only, sold seperately)

Options: OFF, 15 Minutes, 30 Minutes, 45 Minutes, and 1 Hour

Your Xpress[®] has a sleep timer that can automatically shut off the unit after a period of time. By default, the sleep timer is set to "Off". Perform the following steps to adjust the sleep timer for your Xpress[®]:

1. Press the "menu" button, scroll to **Set Time** → **Sleep Timer**
2. Select the desired time period.
3. Press the **XM** button; you will receive a confirmation display displaying your selection.
4. To reset the sleep timer, you can:
 - restart Xpress[®]
 - wait for Xpress[®] to automatically shut down. On restart Xpress[®] returns to its default state: Sleep timer "Off".
 - select the "Off" option from the **Set Time** → **Sleep Timer menu**

Delayed Power Off (car cradle option only)

Options: OFF, 60 Minutes, 90 Minutes, 120 Minutes, and 180 minutes

If the cigarette lighter is always powered, you can set Xpress[®] to automatically turn off after 60 to 180 minutes after you turn it on.

1. Press the **Menu** button, scroll to **Set Time** → **Delayed Power Off**
2. Select the desired time period.

3. Press the **XM** button; you will receive a confirmation display displaying your selection.

The setting is saved even if you turn Xpress[®] off. The “Delayed Power Off” setting is only active when you use the Xpress[®] car cradle. To reset the “Delayed Power Off” to “OFF” (meaning Xpress[®] will not automatically shut down in its car cradle):

1. Press the “menu” button, scroll to **Set Time** → **Delayed Power Off**
2. Select **Off**
3. Press the **XM** button; you will receive a confirmation display displaying your selection.

Factory Defaults

This feature erases all of your personal settings in the presets, TuneSelect, GameSelect, Stock Ticker, and Sports Ticker and resets all other settings to the original factory configuration.

1. Press the **Menu** button, scroll to **Factory Defaults**
2. Confirm by selecting **Yes**, or cancel by selecting **No**.

FM Modulator

FM Frequency

If you choose to use the FM modulator to listen to XM in your vehicle, you will need to find a suitable FM frequency in order to get the best sound. A suitable FM frequency is an unused frequency or weak station that is not located near a strong FM station in your area. (See page 22).



After selecting a FM Frequency, you will be given the choice to add that Frequency to your "FM Presets". Creating a list of FM Presets is a valuable shortcut for those people who need to change FM Frequencies often. You can assign a FM Frequency to FM Presets by:

-Press any 0-9 buttons to assign that frequency to that number.

-Or-

-Scroll to any FM-# and press the **XM** button to assign that frequency to that number (For more information, see FM Preset on page 50).

FM Modulator > FM Preset		
95.9	FM-1	FM-6
97.3	FM-2	FM-7
107.7	FM-3	FM-8
	FM-4	FM-9
	FM-5	FM-0

FM Level

When listening to your Xpress® using the FM modulator, you can adjust its volume level to match other audio sources (your CD player, other FM stations, or MP3 player).

1. Press the **Menu** button, scroll to **FM Modulator** → **FM Level**
2. Rotate the knob counter clockwise to decrease the FM Level or rotate the knob clockwise to increase the FM Level.
3. Press the **XM** button to accept changes.

A confirmation display will be displayed stating FM Level has been "Updated".

FM Presets

Creating a list of FM Presets is a valuable shortcut for those people who need to change FM Frequencies often. There are three ways to access the FM Presets menu:

1. Press the **Menu** button, scroll to **FM Modulator** → **FM Frequency**. After choosing a frequency the FM Presets list will be displayed.
2. Press the **Menu** button, scroll to **FM Modulator** → **FM Presets**.
3. Press and hold **Jump** for 3 seconds at any live XM display.

To select a FM Frequency from the FM Preset menu, either:

Press a number key on your XpressR that has a FM Frequency assigned to it

-OR-

Scroll to any FM-# that has a FM Frequency assigned to it and press the XM button

To exit the FM Presets list do one of the following:

1. Press the **Menu** button
2. Select a FM Preset
3. After 30 seconds the display will time out

Line Out Level

There are two methods of connecting the Line Out on the Xpress[®] car cradle directly to your car's stereo to transmit audio:

1. Using the cassette adapter
2. If you car stereo has an audio input called "Aux In"

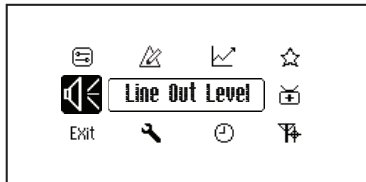

Either of these methods will give you the best audio quality. When using either of these methods to transmit audio through your car's stereo, you can adjust Xpress[®]'s audio level to match other audio sources.

1. Press the **menu** button, scroll to **Line Out Level**
2. Rotate the knob counter clockwise to decrease the Line Out Level or rotate the knob clockwise to increase the Line Out Level.
3. Press **XM** button to accept changes. A confirmation display will be displayed stating Line Out Level has been "Updated".

Do not use the Line Out Level menu item as a volume control; use the volume control on your car stereo instead. Line out level is used to adjust the volume level to match other audio sources (your CD player, other FM stations, or MP3 player).

Set Tone (Audio system option)*

You can adjust the bass and treble to suit the kind of music you're listening to.

1. Press the **menu** button, scroll to and select "Set Tone"
2. Rotate knob to highlight either "Bass" or "Treble".
3. Press the **XM** button to select an item.
4. Rotate knob clockwise to increase levels and rotate knob counter clockwise to decrease levels.
5. Press the XM button to confirm your selection.
6. Then press either the menu button or toggle the knob to the left repeatedly until you return to normal operation.

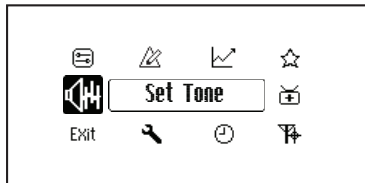

*Audio Systems are sold separately

5

Customer Support

Troubleshooting

Xpress[®] is designed and built to provide you with trouble-free performance without the need for servicing. If it does not appear to be functioning properly, follow these troubleshooting steps first to try to remedy the situation yourself:

1. Attach all connections firmly and securely.
2. Make sure the cigarette lighter/auxiliary power socket is clean and free of corrosion.
3. If you have installed Xpress[®] in a vehicle and it does not power on, check the 12V adapter fuse by unscrewing the ribbed end of the 12V adapter. If required, replace with a 1-amp fuse only. If the 12V adapter does not have a removable end-cap, it has an internal fuse that resets itself after it is left unplugged for a period of time.

If you see this on the display:	You should:
No Signal	Something is blocking the XM signal. Move your XM antenna away from the obstructed area (e.g., an underground garage). Make sure the XM antenna is mounted outside of the vehicle.
Antenna	Be sure that the antenna cable is fully inserted on the connector. Make sure the cable is not bent or broken. Turn Xpress [®] off, then on, to reset this message.
Off Air	The channel you've selected is not currently broadcasting. Tune to another channel.
Loading	Your Xpress [®] is acquiring audio or program information from the XM signal. This message should disappear in a few seconds in good signal conditions.
Updating	XM is updating your Xpress [®] with the latest encryption code. Simply wait a few seconds until the update is done. – OR – You may be attempting to tune to a channel that is blocked or unavailable.
--- (no artist or title)	No program information, such as artist name, song title, or channel exists.

If this happens:	You should:
Xpress [®] shuts off unexpectedly.	Check whether you set the sleep timer, and set it to "Off" if desired. Check whether "Vehicle Mode/Delayed Power Off" is set, and set it to "Off" if desired. Xpress [®] remember the "Vehicle Mode" setting even when you turn the device off.
You do not receive all the XM channels you have subscribed to.	Check tipped any channels (page 43). If you still do not receive all channels, your Xpress [®] may not be activated. Contact XM Satellite Radio. See page 26.
No audio.	Check all connections between your Xpress [®] and your stereo system.
No song title or artist name is displayed.	Nothing is wrong with your Xpress [®] . That information may be in the process of being updated. Some channels, such as news and sports, may not have such information.
No audio when listening to Xpress [®] through an FM radio.	Check that your Xpress [®] and your radio are tuned to the same FM frequency.
Audio fades or has static when listening	You might be hearing interference from another FM station. First check all cables for a proper connection on your Xpress [®] car dock. If the problem persists, you might be hearing interference from another FM station. Set your Xpress [®] and your radio to a different FM frequency.
Audio sounds too soft	Raise or lower the FM audio level until the sound quality improves.
XM Instant Traffic and Weather channels sound different than other channels	Nothing is wrong with your Xpress [®] . These channels use a different audio technology than the other XM channels

Specifications

Xpress ^R	
Dimensions	115 mm (W) x 63 mm (H) x 16 mm (D) 4.5 in (W) x 2.5 in (H) x 0.6 in (D)
Weight	128 g 4.5 oz
Audio output	3.5 mm mini-stereo jack
Antenna connector (home and car cradle)	RF SMB
External power	Voltage: 5 V DC Current: 2000 mA Polarity: --  +

Remote	
Dimensions	40 mm (W) x119 mm (H) x 14 mm (D) 1.5 in (W) x 4.7 in (H) x 0.55 in (D)
Weight	40 g 1.4 oz
Battery	Type: CR2032 Voltage: 3 V
Model Numbers	
Xpress [®]	XMCK20
XPress universal home kit	XMHU20
XPress universal car kit	XM CU20

Product Registration

1. Register your product. We will keep the details of your purchase on file to help you refer to this information in the event of an insurance claim such as loss or theft.
2. Receive updates on the latest products and technologies.
3. Download owner's manuals, order product catalogues, research new products, and much more.



For Customer Service
Visit Our Website At
www.audiovox.com
Product Information, Photos,
FAQ's Owner's Manuals

IMPORTANT (Serial Number) The serial number of this device is located on the back of this unit. For your own security and convenience, be sure to record this number for future warranty claims.

Serial Number: _____

Patent Information

Technology. It is prohibited to, and you agree that you will not, copy, decompile, disassemble, reverse engineer, hack, manipulate, or otherwise access and/or make available any technology incorporated in receivers compatible with the XM Satellite Radio system. Furthermore, the AMBE (r) voice compression software included in this product is protected by intellectual property rights including patent rights, copyrights, and trade secrets of Digital Voice Systems, Inc. The software is licensed solely for use within this product. The music, talk, news, entertainment, data, and other content on the Services are protected by copyright and other intellectual property laws and all ownership rights remain with the respective content and data service providers. You are prohibited from any export of the content and/or data (or derivative thereof) except in compliance with applicable export laws, rules and regulations. The user of this or any other software contained in an XM Radio is explicitly prohibited from attempting to copy, decompile, reverse engineer, hack, manipulate or disassemble the object code, or in any other way convert the object code into human-readable form.

FCC Statement

Please note that the power cable that has been supplied with your device is supplied with permanently attached ferrite beads. It is the responsibility of the user to use the power cable with the ferrite beads.

The user is cautioned that changes or modifications not expressly approved by XM Satellite Radio Inc. can void the user's authority to operate this device.

This device complies with Part 15 of the FCC Rules. Operation is subject to the following two conditions:

- (1) This device may not cause harmful interference.
- (2) this device must accept any interference received, including interference that may cause undesired operation.

This equipment has been tested and found to comply with the limits for a Class B digital device, pursuant to Part 15 of the FCC Rules. These limits are designed to provide reasonable protection against harmful interference in a residential installation.

This equipment generates, uses, and can radiate radio frequency energy and, if not installed and used in accordance with the installation instructions, may cause harmful interference to radio communications. However, there is no guarantee that interference will not occur in a particular installation. If this equipment does cause harmful interference to radio or television reception, which can be determined by turning the equipment off and on, the user is encouraged to try to correct the interference by one or more of the following measures:

- Reorient or relocate the receiving antenna of the affected receiver.
- Increase the separation between the XM equipment and the affected receiver.
- Connect the XM equipment into an outlet on a circuit different from that to which the affected receiver is connected.
- Consult the dealer or an experienced radio/TV technician for help.



Warning: The FCC and FAA have not certified this Satellite Radio Receiver for use in any aircraft (neither portable nor permanent installation). Therefore, XM Satellite Radio cannot support this type of application or installation

6

Warranty

**AUDIOVOX®****12 Month Limited Warranty**

AUDIOVOX ELECTRONICS CORPORATION (the Company) warrants to the original retail purchaser of this product that should this product or any part thereof, under normal use and conditions, be proven defective in material or workmanship within 12 months from the date of original purchase, such defect(s) will be repaired or replaced with new or re-conditioned product (at the Company's option) without charge for parts and repair labor.

To obtain repair or replacement within the terms of this Warranty, the product is to be delivered with proof of warranty coverage (e.g. dated bill of sale), specification of defect(s), transportation prepaid, to an approved warranty station or the Company at the address shown below.

This Warranty does not extend to the elimination of externally generated static or noise, to costs incurred for installation, removal or reinstallation of the product, damage to speakers, accessories, or vehicle and home electrical systems, malfunction of satellite transmissions, repeater signal or receiver unit.

This Warranty does not apply to any product or part thereof which, in the opinion of the Company, has suffered or been damaged through alteration, improper installation, mishandling, misuse, neglect, accident, or by removal or defacement of the factory serial number/bar code label(s).

THE EXTENT OF THE COMPANY'S LIABILITY UNDER THIS WARRANTY IS LIMITED TO THE REPAIR OR REPLACEMENT PROVIDED ABOVE AND, IN NO EVENT, SHALL THE COMPANY'S LIABILITY EXCEED THE PURCHASE PRICE PAID BY PURCHASER FOR THE PRODUCT.

This Warranty is in lieu of all other express warranties or liabilities. ANY IMPLIED WARRANTIES, INCLUDING ANY IMPLIED WARRANTY OF MERCHANTABILITY, SHALL BE LIMITED TO THE DURATION OF THIS WRITTEN WARRANTY. ANY ACTION FOR BREACH OF ANY WARRANTY HEREUNDER INCLUDING ANY IMPLIED WARRANTY OF MERCHANTABILITY MUST BE BROUGHT WITHIN A PERIOD OF 48 MONTHS FROM DATE OF ORIGINAL PURCHASE. IN NO CASE SHALL THE COMPANY BE LIABLE FOR ANY CONSEQUENTIAL OR INCIDENTAL DAMAGES FOR BREACH OF THIS OR ANY OTHER WARRANTY, EXPRESS OR IMPLIED, WHATSOEVER. No person or representative is authorized to assume for the Company any liability other than expressed herein in connection with the sale of this product.

Some states do not allow limitations on how long an implied warranty lasts or the exclusion or limitation of incidental or consequential damage so the above limitations or exclusions may not apply to you. This Warranty gives you specific legal rights and you may also have other rights which vary from state to state.

U.S.A. : AUDIOVOX ELECTRONICS CORPORATION, 150 MARCUS BLVD., HAUPPAUGE, NEW YORK 11788 1-800-645-4994

CANADA : CALL 1-800-645-4994 FOR LOCATION OF WARRANTY STATION SERVING YOUR AREA



Audiovox Electronics Corporation
150 Marcus Blvd.
Hauppauge, New York 11788
U.S.A.
1 800 645 4994

www.audiovox.com

XM name and related logos are trademarks of XM Satellite Radio Inc.

♻️ Printed on Recycled Paper
©2007 Audiovox Electronics Corporation. All rights reserved.

XMCK20