

XMp3i

POWERCONNECT™ VEHICLE KIT

User Guide



SIRIUS  | 
S A T E L L I T E R A D I O

Table of Contents

Introduction	5
Features	6
Safety and Care Information	7
Software Version	9
What's in the Box?	10
Remote Control Functions	11
<i>PowerConnect</i> Vehicle Dock	12
Vehicle Installation	13
Step 1: Choose a Location for Your Radio	14
Step 2: Install the Dash or Vent Mount	16
Step 4: Route the Magnetic Mount Antenna Cable	25
Step 5: Connect the Magnetic Mount Antenna and <i>PowerConnect</i> Power Adapter ...	37
Step 6: Connect the Audio	38
Appendix: How To Find Available FM Channels	47
Troubleshooting	51
Product Specifications	57
Patent Information	59
Environmental Information	59

Introduction

Features

Congratulations on your purchase of the XMp3i™ *PowerConnect*™ Vehicle Kit!

Your new Vehicle Kit has everything you need to play your XMp3i™ or Pioneer XMp3™ Radio through your vehicle's stereo.

- Take your Radio on the road: No need for a second subscription. Listen to live or recorded Satellite Radio programming, plus your MP3s and WMA's, directly through your vehicle's stereo system.
- Easy to install: Revolutionary SIRIUS | XM *PowerConnect* FM Transmitter works through your vehicle's radio* with easy Do-It-Yourself installation. The color-coded Vehicle Dock makes it simple to connect.
- Easily change channels and volume: Included Remote Control lets you or your passengers easily adjust the Radio.
- Stay charged: Charges your Radio while you listen.

And for the latest information about this and other SIRIUS | XM products and accessories, visit www.xmradio.com or your favorite retailer.

Please read the entire User Guide before installing the Vehicle Kit!

*FM Radio required, or use the included Aux In Cable. The Vehicle Kit Will also work with a Cassette Adapter (sold separately).

Safety and Care Information



IMPORTANT! Always read and understand all the instructions to avoid injury to yourself and/or damage to your device. SIRIUS XM Radio Inc. disclaims all responsibility for damage from data loss due to breakdown, repair, or other causes.

- Do not expose to extreme temperatures (above 140°F or below -4°F, or above 60°C or below -20°C).
- Do not expose to moisture. Do not use device near or in water. Do not touch the device with wet hands.
- Do not let any foreign matter spill into device.
- Do not store in dusty areas.
- Do not expose to chemicals such as benzene and thinners. Do not use liquid or aerosol cleaners. Clean with a soft damp cloth only.
- Do not expose to direct sunlight for a prolonged period of time, and do not expose to fire, flame, or other heat sources.
- Do not try to disassemble and/or repair device yourself.
- Do not drop your device or subject it to severe impact.
- Do not place heavy objects on device.
- Do not subject device to excessive pressure.

WARNING!

- Opening the case may result in electric shock.
- Make sure that you insert the *PowerConnect* Power Adapter's plug all the way into the outlet.

Introduction

- For optimal audio performance, insert the *PowerConnect* Power Adapter directly into your vehicle's cigarette lighter/power outlet. Don't use an intermediary device, such as a dual vehicle power adapter for multiple devices.
- When using this product, it is always important to keep your eyes on the road and hands on the wheel. Not doing so could result in personal injury, death, and/or damage to your device, accessories, and/or to your vehicle or other property.
- Vehicle installation and radio configuration functions should not be performed while driving. Park your vehicle in a safe location before beginning installation.
- This product contains chemicals known to the State of California to cause cancer and birth defects or other reproductive harm.

Your device should be placed in your vehicle where it will not interfere with the function of safety features, e.g., deployment of airbags. Failure to correctly place device may result in injury to you or others, if the unit becomes detached during an accident and/or obstructs the deployment of an airbag.

State and Local Driving Restrictions

States or localities may prohibit driving with a suction mount on the windshield. (See California Vehicle Code Section 26708(a); Minnesota Statutes 2008, Section 169.71). When driving in these areas, the dash mounting option should be used instead. Check your state or local laws for any applicable restrictions. SIRIUS XM Radio Inc. does not take any responsibility for any fines, penalties or damages that may be incurred as a result of disregarding this notice.

Software Version

For this XMP3i™ PowerConnect Vehicle Kit to operate properly, your Radio must be running Software Version 1.19 or later.

Check your Radio to see if it is running the correct Software Version. The Software Version is displayed momentarily on the screen when you turn on your Radio.



If your Radio does not display **V1.19** or higher, please go to www.xmradio.com/xmp3update for easy-to-follow instructions to update the Software.

Introduction

What's in the Box?

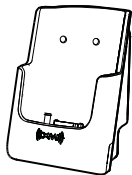

PowerConnect Vehicle Dock

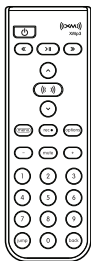

Remote Control



Aux In Cable



Dash Mount

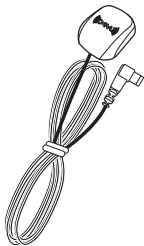

Magnetic Mount
Antenna

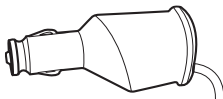

PowerConnect
Power Adapter



Alcohol
Preparation Pads

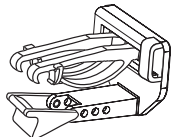
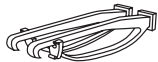

Vent Mount
and Extended
Vent Clamps



TIP! For other accessories you can add to your Vehicle Kit such as a Cassette Adapter for vehicles with a cassette player, to professional installation if you'd rather leave your in-vehicle setup to the experts - just visit xmradio.com/accessories or your favorite retailer.

Remote Control Functions

Power Button

30-Minute Replay Buttons

Pause and replay up to 30 minutes of live XM programming.

Select Button

Press to confirm highlighted selections.

Menu

Go to Live XM, My Music Library, Auto Recordings, or Settings.

Number Keys

Enter a channel number directly to tune to the channel.

Jump

Switches between current channel and previously tuned channel.

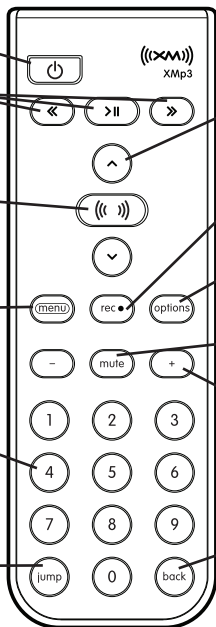

Arrow Buttons

Navigates through lists and highlights list items.

Record

Record a song or a channel. Also schedule a recording and set channel to auto record.

Options

Displays a menu in context according to what you are doing.

Mute

Silences the audio.

+ and -
Change channels or control volume for audio system (sold separately).

Back

Return to previous screen. Press and hold to return to the previous channel.

PowerConnect Vehicle Dock

Color-Coded Connections

The color-coded *PowerConnect* Vehicle Dock makes it simple to connect, just match the colors on the cable ends to the colors on the dock to see what goes where.

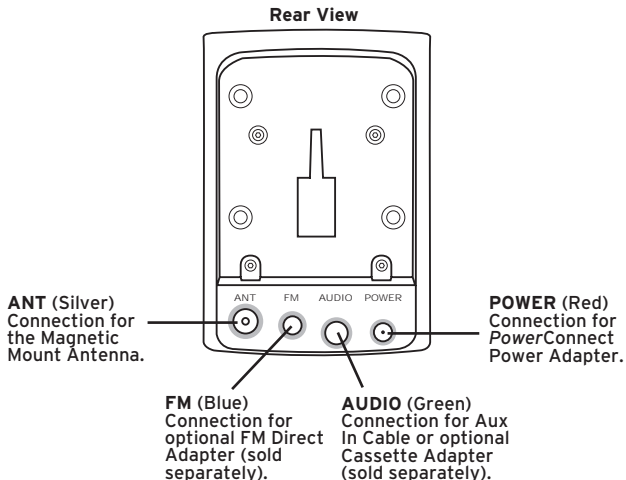

Vehicle Installation

Vehicle Installation

Step 1: Choose a Location for Your Radio

When installing the *PowerConnect* Vehicle Dock in your vehicle, choose a location where it will not block your vision, interfere with the controls, or obstruct the air bag. The location should be easily accessible and provide good visibility of the display, and should not be located where it may be in direct sunlight, which will affect the visibility of the display screen.

Here are some examples of the dock (with a radio) mounted using either the Dash Mount or the Vent Mount.

DASH MOUNT - Option 1

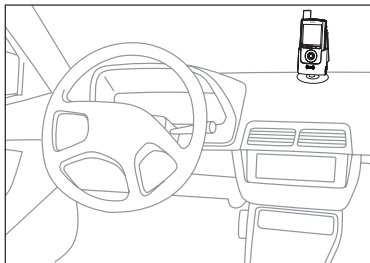

DASH MOUNT - Option 2

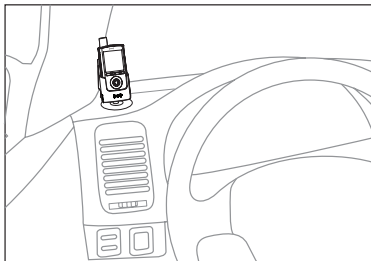

DASH MOUNT - Option 3

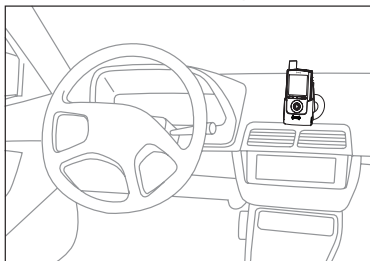

VENT MOUNT - Option 1

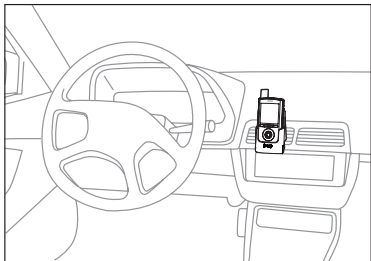

VENT MOUNT - Option 2

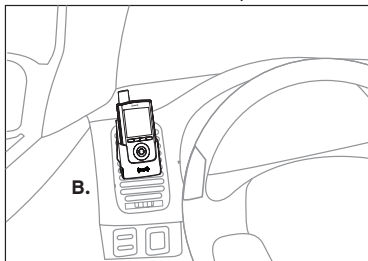

Vehicle Installation

Step 2: Install the Dash or Vent Mount

Depending on your situation, you can either choose to use the Dash Mount or the Vent Mount.



IMPORTANT! When you install the chosen mount, do not attach the dock to the mount yet. All cables should be attached to the dock prior to connecting the dock to the mount.

Installing the Dash Mount:



CAUTION! The adhesive used on the Dash Mount may be difficult to remove. Do not install this mount on leather surfaces (contact your automobile dealership if you are unsure about your dash surface), and make sure the air temperature is at least 60°F (15°C) during installation. If it's not at least 60°F, turn on the heater in your vehicle to bring the temperature up to 60°F.

- 1 Locate a flat surface for the Dash Mount. Make sure there is ample room for the *PowerConnect* Vehicle Dock and radio when installed.
- 2 Set the orientation of the Dash Mount before adhering it. Loosen the knob and adjust the adhesive foot for the location you selected in "Step 1: Choose a Location for Your Radio" on page 14.

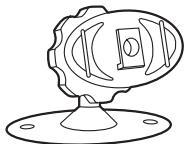

DASH MOUNT - Option 1 and DASH MOUNT - Option 2 should be oriented like the image above.

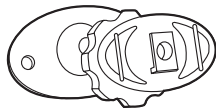

DASH MOUNT - Option 3 should be oriented like the image above.

- 3** The dock mounting plate can be tilted in different directions. Adjust as necessary for your particular vehicle. When the orientation is correct, tighten the knob.

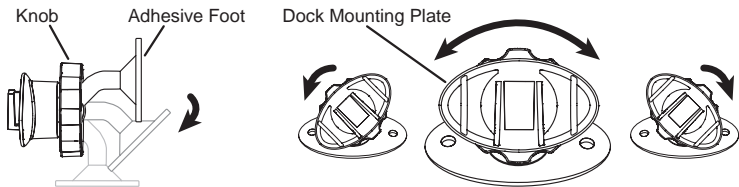

- 4** Clean the surface with the alcohol preparation pad and let it dry thoroughly.
- 5** Peel off the adhesive liner. Position, press, and hold the Dash Mount in place for 30 seconds.

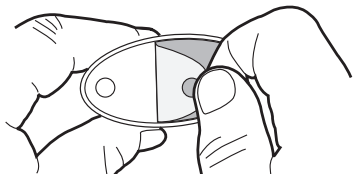

IMPORTANT! Allow the Dash Mount adhesive to cure (dry) for at least 24 hours before using the mount.



TIP! To remove, carefully lift the adhesive pad with your fingers or a spoon. Warming the pad with a hair dryer for several minutes will help soften the adhesive. Be careful not to overheat the surface with the hair dryer or you may damage the surface or Dash Mount.

Vehicle Installation

Installing the Vent Mount:

- 1 Locate a vent with horizontal louvers sturdy enough to hold your PowerConnect Vehicle Dock and radio.
- 2 If the vent louvers in your vehicle are recessed, you may need to use the longer vent clamps with the Vent Mount. If so, remove the shorter vent clamps and install the longer ones into the Vent Mount. Be sure to observe the orientation of the vent clamps as shown.

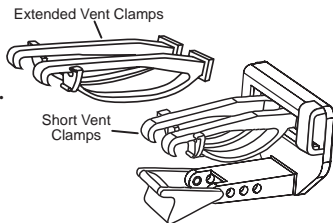

Remove End Cap

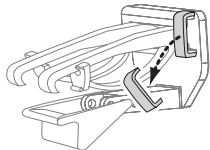

Slide Short Vent Clamps Out

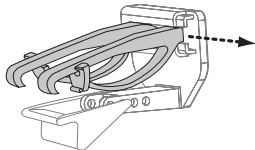

Slide Extended Vent Clamps In

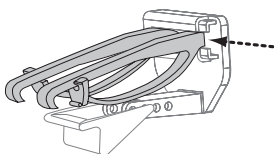

Replace End Cap

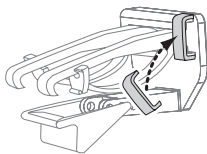

- 3** Push the Vent Mount onto the vehicle as shown (1) until it hooks on the rear of the vent louver (2).
- 4** Rest the foot against the bottom of the vent (2), and adjust the tilt of the Vent Mount by repositioning the foot to a different adjustment hole (3).

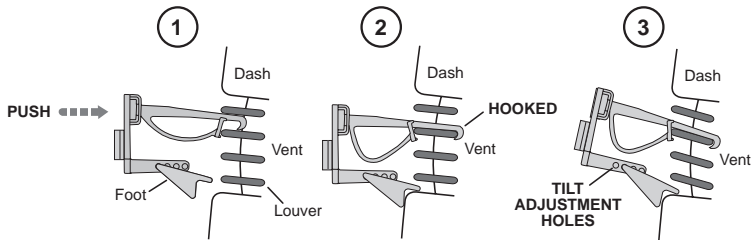

To remove the Vent Mount, push the mount into the vent. Then lift up until disengaged from the rear of the vent louver, and remove the Vent Mount.

Vehicle Installation

Step 3: Mount the Magnetic Mount Antenna

The Magnetic Mount Antenna contains a strong magnet which will stick to any metal part of your vehicle, but will not damage the vehicle.

To install the Magnetic Mount Antenna:

- 1 Choose the best location for the Magnetic Mount Antenna considering your vehicle type. Pay particular attention to any accessories that you may have like luggage racks and how frequently you may use them.

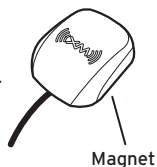

Sedan/Coupe: We recommend mounting the antenna just above either the front windshield or the back window as shown.

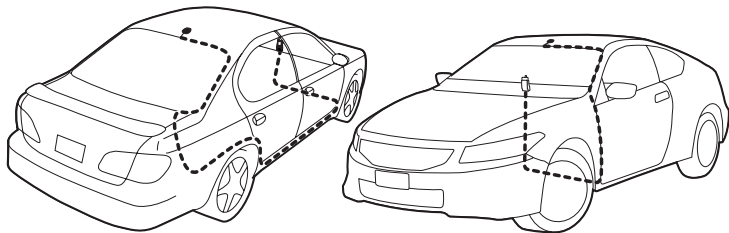

SUV: We recommend mounting the antenna at the rear of the roof as shown.

Convertible: We recommend mounting the antenna at the leading edge of the trunk as shown.

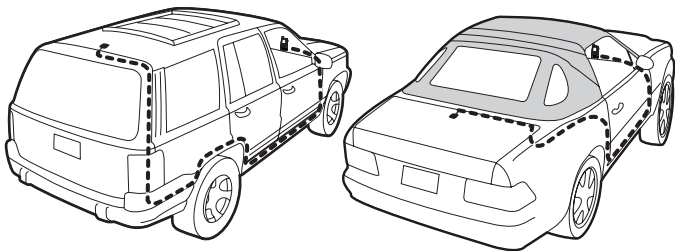

Pickup Truck: We recommend mounting the antenna just above the front windshield as shown.

- 2** Clean the surface of the selected mounting location using the alcohol preparation pad and let it dry thoroughly.

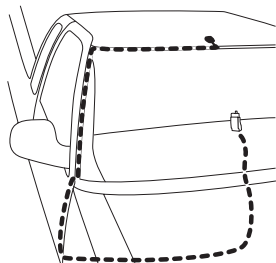

Vehicle Installation

- 3** Place the antenna in the location you selected. Follow the Tips and Cautions shown on the next several pages.

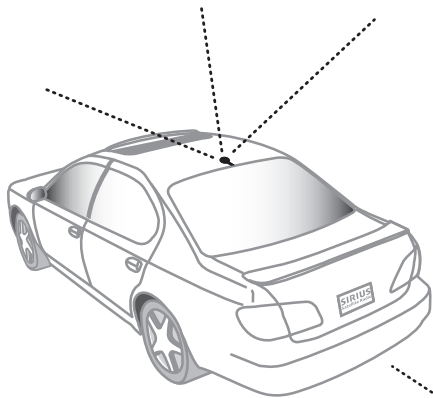

TIP! Mount the antenna on the roof (for most vehicles) or trunk (for convertibles) where it has a clear view of the sky in all directions.

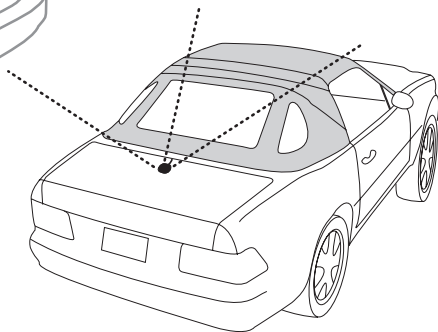



CAUTION! Don't mount the antenna inside the vehicle, for example, on the dashboard.

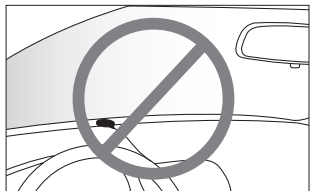

CAUTION! Don't mount the antenna on any of the vehicle's front, back or side pillars.

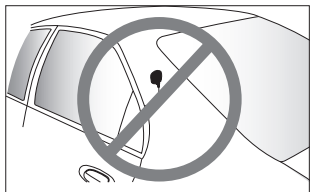

CAUTION! Don't mount the antenna close to a roof rack. Adjust the rack so it's further away from the antenna or move the antenna closer to the center of the roof.

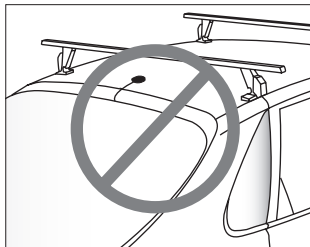

Vehicle Installation



CAUTION! Don't mount the antenna close to another antenna. Mount it at least 3 inches away.

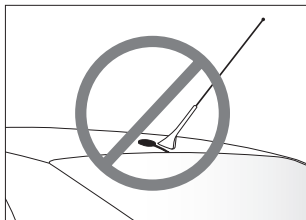

TIP! Always be careful to include enough slack in your cable to accommodate open doors or trunk lids. Use things typically found around the home, like electrical tape, to secure cables in areas so that hinges do not pinch the cable with the door. Hide any excess cable in the trim.

Step 4: Route the Magnetic Mount Antenna Cable

Before you begin routing the antenna cable, read these general instructions for how to route and hide the antenna cable. Then route your antenna cable according to the instructions which follow for your specific type of vehicle.

Use a blunt plastic putty knife, a credit card, a plastic knife, or a similar blunt tool to lift the rubber window moulding

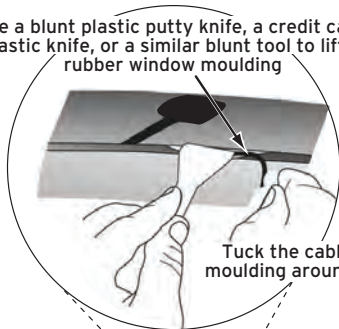

Tuck the cable under the moulding around the window

Feed cable under rubber moulding around window

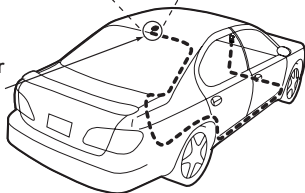

Vehicle Installation

Route cable out from under rear windshield moulding and tuck into weatherstripping around trunk opening
Avoid sharp bends by running cable through weatherstripping for several inches

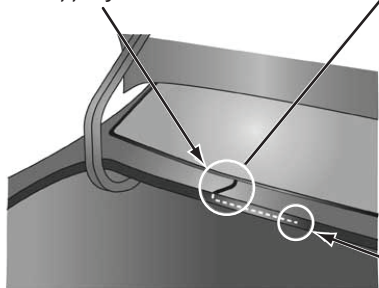

Pull weatherstripping from trunk opening

Tuck cable into weatherstripping. Route cable through weatherstripping several inches to avoid sharp bends

Pull cable out of weatherstripping and route through trunk to cabin

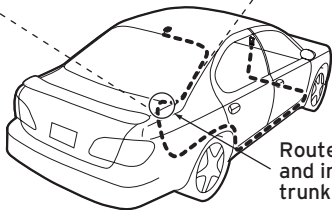

Route cable out of window moulding and into weatherstripping around trunk opening

Bring cable out of weatherstripping and into trunk

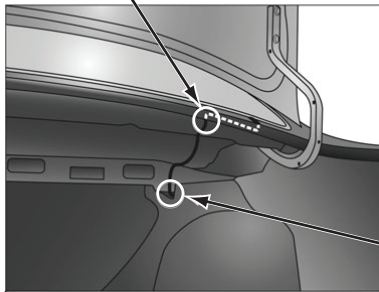

Route cable along trunk wall and into cabin through gap or conduit, along existing wiring harness

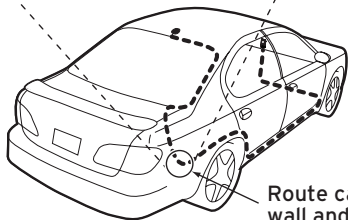

Route cable along trunk wall and into cabin

Vehicle Installation

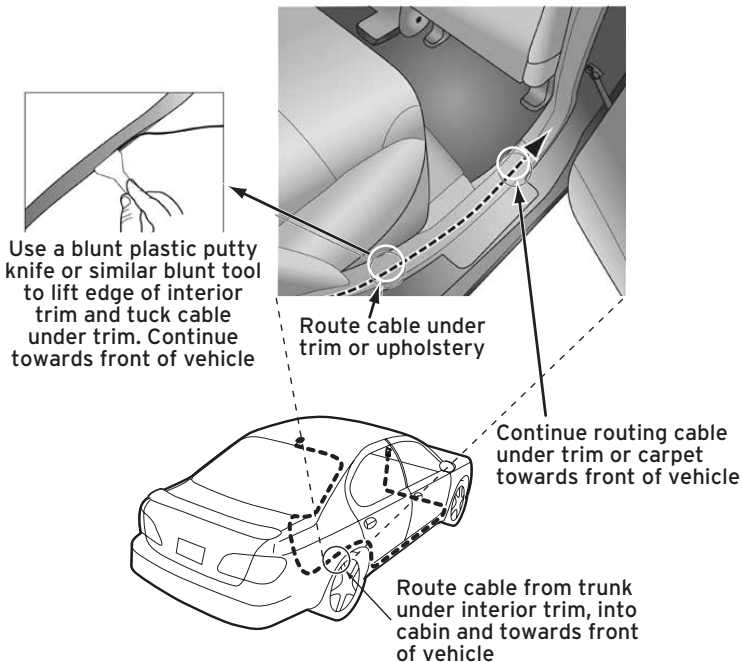

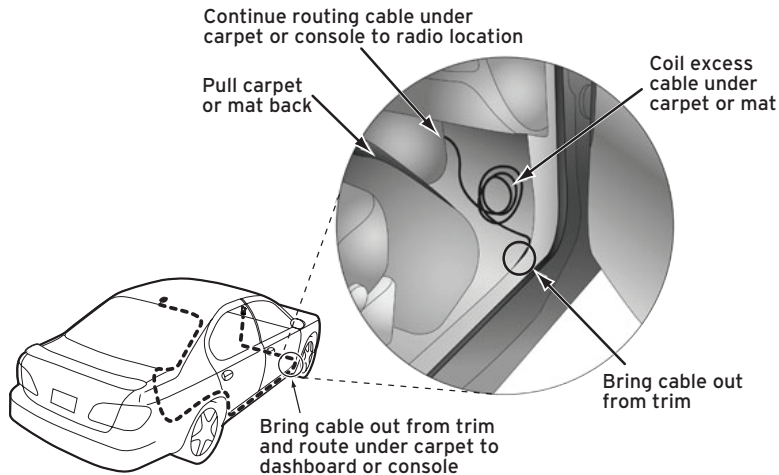

TIP! Always be careful to include enough slack in your cable to accommodate open doors or trunk lids. Use things typically found around the home, like electrical tape, to secure cables in areas so that hinges do not pinch the cable with the door. Hide any excess cable in the trim.

Vehicle Installation

3 Route the cable:

• Sedan/Coupe With the Antenna Placed at the Rear of the Roof:

1. Feed the antenna cable from the antenna underneath the rubber molding around the rear window. Use a blunt plastic putty knife or similar blunt tool to lift the rubber molding around the rear window and tuck the antenna cable underneath the molding. Route the antenna cable around and down the window to the lowest point. If your rear window does not have rubber molding, we recommend consulting a professional installer.
2. Route the antenna cable out of the window molding and into the rubber weather stripping around the trunk opening. Lift the weather stripping from the opening and tuck the cable inside it, then replace the weather stripping. To avoid sharp bends in the cable, run the cable inside the weather stripping for a few inches, then remove the cable from the weather stripping inside the trunk. Keep the cable away from hinges, gears, etc., that could damage it.
3. Route the cable out from the rubber weather stripping and along the trunk wall. Continue routing the cable into the vehicle cabin through a conduit or along an existing wiring harness.

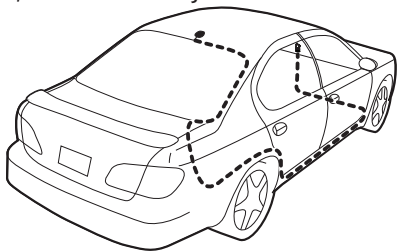

4. Route the cable through the main cabin area under the interior trim, towards the front of the vehicle. Use a blunt plastic putty knife or similar blunt tool to lift the plastic trim just enough to tuck the cable under underneath. Avoid side airbag locations on back pillars and above the doors. Airbag locations are marked with "SRS" logos. Be careful not to crimp or cut the cable.
5. Bring the cable out from the trim near the front of the cabin and route it under the carpet toward the dashboard or console. Coil any excess cable in a hidden location, such as under the carpet, keeping it away from any vehicle pedals or controls. Secure the excess cable with wire ties (purchased separately).
6. Bring the end of the cable out at the *PowerConnect* Vehicle Dock location. Leave yourself enough cable so you can easily connect it to the antenna connector of the dock.
7. Continue with "Step 5: Connect the Magnetic Mount Antenna and *PowerConnect* Power Adapter" on page 37.

Vehicle Installation

- **Sedan/Coupe With the Antenna Placed at the Front of the Roof:**

1. Feed the antenna cable from the antenna underneath the rubber molding around the windshield. Use a blunt plastic putty knife or similar blunt tool to lift the rubber molding around the windshield and tuck the antenna cable underneath the molding. Route the antenna cable around and down the windshield to the lowest point.
2. At the lowest corner of the windshield, route the cable out of the windshield molding and into the rubber weather stripping around the door opening. Lift the weather stripping from the opening and tuck the cable inside it, then replace the weather stripping. Run the cable inside of the weather stripping to the bottom of the door opening.
3. Pull the cable out of the weather stripping at the bottom of the door opening and route it under the carpet toward the dashboard. Coil any excess cable in a hidden location, such as under the carpet, keeping it away from any vehicle pedals or controls. Secure the excess cable with wire ties.
4. Bring the end of the cable out at the *PowerConnect* Vehicle Dock location. Leave yourself enough cable so you can easily connect it to the antenna connector of the dock.
5. Continue with "Step 5: Connect the Magnetic Mount Antenna and *PowerConnect* Power Adapter" on page 37.

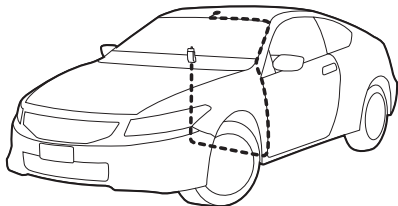

• SUV:

1. Feed the antenna cable underneath the rubber weather stripping of the rear tailgate window/door and route the cable along the rear hatch. Lift the weather stripping from the opening and tuck the cable inside it, then replace the weather stripping. Pull the cable out from weather stripping and route it into the cabin under the interior trim. Avoid hinges or gears that could crimp or cut the cable.
2. Route the cable through the SUV's main cabin area under the interior trim, towards the front of the vehicle. Use a blunt plastic putty knife or similar blunt tool to lift the plastic trim just enough to tuck the cable under underneath. Avoid side airbag locations on back pillars and above the doors. Airbag locations are marked with "SRS" logos. Be careful not to crimp or cut the cable.
3. Bring the cable out from the trim near the front of the cabin and route it under the carpet toward the dashboard or console. Coil any excess cable in a hidden location, such as under the carpet, keeping it away from any vehicle pedals or controls. Secure the excess cable with wire ties (purchased separately).

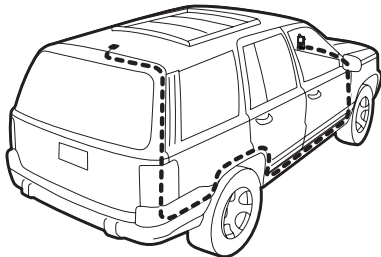

Vehicle Installation

4. Bring the end of the cable out at the *PowerConnect Vehicle Dock* location. Leave yourself enough cable so you can easily connect it to the antenna connector of the dock.
5. Continue with “Step 5: Connect the Magnetic Mount Antenna and *PowerConnect Power Adapter*” on page 37.

- **Convertible:**

1. Bring the antenna cable from the antenna into the trunk at the front edge of the trunk lid. Keep any bends in the cable loose. Tape or tie the cable along the inside of the trunk lid to the trunk lid hinge strut.
2. Allow enough slack in the cable so the trunk lid can easily open and close and keep the cable away from hinges, gears, etc., that could crimp or cut it. Route the cable along the trunk wall and into the cabin through a conduit or along an existing wiring harness.
3. Route the cable through the main cabin area under the interior trim, towards the front of the vehicle. Use a blunt plastic putty knife or similar blunt tool to lift the plastic trim just enough to tuck the cable underneath. Avoid side airbag locations on back pillars and above the doors. Airbag locations are marked with “SRS” logos. Be careful not to crimp or cut the cable.

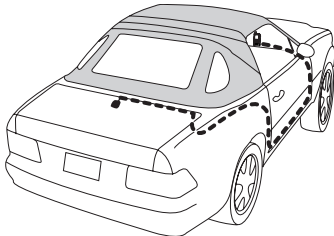

4. Bring the cable out from the trim near the front of the cabin and route it under the carpet toward the dashboard or console. Coil any excess cable in a hidden location, such as under the carpet, keeping it away from any vehicle pedals or controls. Secure the excess cable with wire ties (purchased separately).
5. Bring the end of the cable out at the *PowerConnect Vehicle Dock* location. Leave yourself enough cable so you can easily connect it to the antenna connector of the dock.
6. Continue with “Step 5: Connect the Magnetic Mount Antenna and *PowerConnect Power Adapter*” on page 37.

Vehicle Installation

• Pickup Truck:

1. Use a blunt plastic putty knife or similar blunt tool to lift the rubber molding around the windshield and tuck the antenna cable underneath it.
2. Continue tucking the cable underneath the windshield molding around the windshield to the lowest corner.
3. At the lowest corner of the windshield, route the cable out of the rubber weather stripping around the door opening. Lift the weather stripping from the opening and tuck the cable inside it, then replace the weather stripping. Run the cable inside of the weather stripping to the bottom of the door opening.
4. Pull the cable out of the weather stripping at the bottom of the door opening and route it under the carpet toward the dashboard. Coil any excess cable in a hidden location, such as under the carpet, keeping it away from any vehicle pedals or controls. Secure the excess cable with wire ties.
5. Bring the end of the cable out at the *PowerConnect Vehicle Dock* location. Leave yourself enough cable so you can easily connect it to the antenna connector of the dock.
6. Continue with "Step 5: Connect the Magnetic Mount Antenna and *PowerConnect Power Adapter*" on page 37.

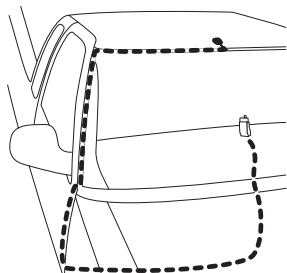

Step 5: Connect the Magnetic Mount Antenna and PowerConnect Power Adapter

- 1 Plug the Magnetic Mount Antenna into the **silver ANT** connector on the *PowerConnect* Vehicle Dock.

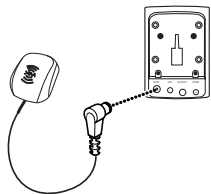

- 2 Insert the *PowerConnect* Power Adapter into your vehicle's cigarette lighter or power adapter socket.

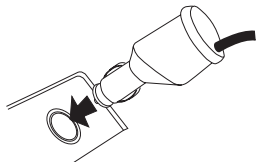

- 3 Plug the *PowerConnect* Power Adapter into the **red PWR** connector on the dock.

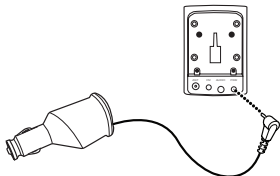

Vehicle Installation

Step 6: Connect the Audio

To play audio through your vehicle's stereo or FM radio, decide on one of the following audio connection options:

- **Option 1: Best:** Use the included **Aux In Cable** if your vehicle's stereo system has an auxiliary input connection. Refer to your vehicle's owners manual to find the location of the auxiliary input jack, or consult the vehicle dealer.



TIP! The auxiliary input jack may be located on the face plate of the vehicle radio, on the back of the radio, anywhere on the front dash panel, inside the glove compartment, or inside the center console in between the front seats.

- **Option 2: Better:** Use a **Cassette Adapter** if your vehicle has a built-in cassette player. Cassette Adapters are sold separately and can be purchased from an electronics retailer, or go to xmradio.com/accessories.
- **Option 3: Good:** Use the **PowerConnect** feature in your radio. **PowerConnect** plays the audio through your vehicle's FM radio.
- **Option 4: Best:** Use the **FM Direct Adapter**. If none of the previous three audio connection options will work in your vehicle, then you will need to use the FM Direct Adapter (FMDA) (sold separately). The FMDA needs to be installed by a professional installer and directly connects the radio to your vehicle's FM radio. To learn more, check with the retailer where you bought your radio, or go to www.xmradio.com/accessories.

Follow the installation instructions in the next several sections for the audio connection option that you have selected.

Option 1: Aux In Cable Installation Instructions

- 1 Plug one end of the Aux In Cable into the **green AUDIO** connector on the dock.

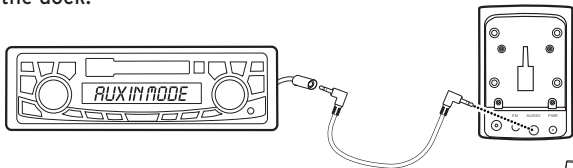

- 2 Plug the other end into the auxiliary input jack connection system of your vehicle's stereo system.

- 3 Insert the dock into the mount.

- 4 Insert your Radio into the dock.

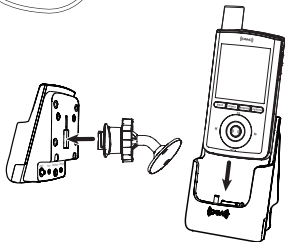

- 5 Power on your Radio sliding the **Power/Lock** switch down.

- 6 Be sure the vehicle is outside and the antenna has a clear view of the sky. Verify that you are receiving the XM signal. There should be at least one bar on the lower left corner of the main display screen that denotes antenna signal strength. You can also press **menu** and then press **▼** to scroll to and highlight **Signal Indicator**. Press the **Select** button. The Satellite

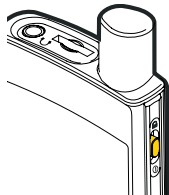

Vehicle Installation

and Terrestrial bars show the strength of the signal being received. If the signal reception is good, repeatedly press **back** to return to the main display screen.

- 7 Ensure that your radio is tuned to channel 1. Upon power up, the radio should tune to channel 1 by default, when it's not yet activated. If it's not on channel 1, refer to the User Guide which accompanied your radio to learn about how to tune a channel.
- 8 Turn on your vehicle's stereo system. Set it to play input from the auxiliary input source.
- 9 You should hear XM channel 1 through your vehicle's stereo system. Now sit back and enjoy Satellite Radio.
- 10 The audio level output of the radio can be increased or decreased as necessary to match the audio levels of other sources in your vehicle. Refer to the User Guide which accompanied your radio for instructions.

If the signal reception is good, but there is no audio when tuned to channel 1, be sure the vehicle's stereo system is set to the correct source, i.e., auxiliary input source (step 8). Also be sure that the audio level is set high enough to be heard (step 10). Refer to "Troubleshooting" on page 52 for additional help.



Option 2: Cassette Adapter Installation Instructions

- 1 Plug the Cassette Adapter into the **green AUDIO** connector on the dock.
- 2 Insert the Cassette Adapter into the vehicle's cassette deck. You may need to turn on your vehicle's stereo system in order to do so.
- 3 Insert the dock into the mount.
- 4 Insert your Radio into the dock.
- 5 Power on your Radio sliding the **Power/Lock** switch down.
- 6 Be sure the vehicle is outside and the antenna has a clear view of the sky. Verify that you are receiving the XM signal. There should at least be one bar on the lower left corner of the main display screen that denotes antenna signal strength. You can also press **menu** and then press ▼ to scroll to and highlight **Signal Indicator**. Press the **Select** button. The Satellite and Terrestrial bars show the strength of the

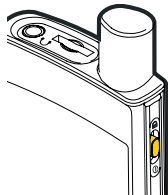
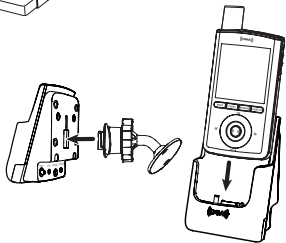
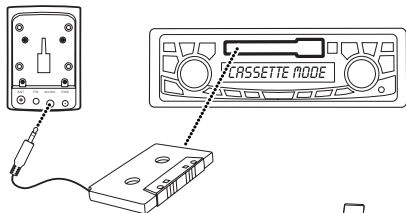

Vehicle Installation

signal being received. If the signal reception is good, repeatedly press **back** to return to the main display screen.

- 7** Ensure your radio is tuned to channel 1. Upon power up, your radio should tune to channel 1 by default, when it's not yet activated. If it's not on channel 1, refer to the User Guide which accompanied your radio to learn about how to tune a channel.
- 8** If you haven't done so, turn on your vehicle's stereo system. Set it to play input from the cassette source.
- 9** You should hear XM channel 1 through your vehicle's stereo system. Now sit back and enjoy Satellite Radio.
- 10** The audio level output of the radio can be increased or decreased as necessary to match the audio levels of other sources in your vehicle. Refer to the User Guide which accompanied your radio for instructions.

If the signal reception is good, but there is no audio when tuned to channel 1, be sure the vehicle's stereo system is set to the correct source, i.e., cassette source (step 8). Also be sure that the audio level is set high enough to be heard (step 10). Refer to "Troubleshooting" on page 52 for additional help.



Option 3: PowerConnect Installation Instructions

- 1 Insert the dock into the mount.
- 2 Insert your Radio into the dock.
- 3 Power on your Radio sliding the **Power/Lock** switch down.
- 4 Be sure the vehicle is outside and the antenna has a clear view of the sky. Verify that you are receiving the XM signal. There should at least be one bar on the main display screen that denotes antenna signal strength. You can also refer to the User Guide which accompanied your radio, and display the **Antenna Aiming** screen. The Satellite and Terrestrial bars show the strength of the signal being received. If the signal reception is good, repeatedly press **back** to return to the main display screen. You are ready to make the audio connection.
- 5 You'll now need to find an available FM channel to listen to the XM audio through your vehicle's FM

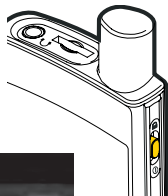
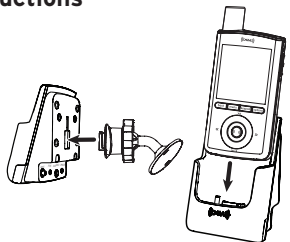

Vehicle Installation

radio. Refer to “How To Find Available FM Channels In Your Area” on page 48.

- 6 Ensure that your radio is tuned to channel 1. Upon power up, your radio should tune to channel 1 by default, when it's not yet activated. If it's not on channel 1, refer to the User Guide which accompanied your radio to learn about how to tune a channel.
- 7 Pick the first FM channel on your list from step 5. Turn on your vehicle's FM radio (if you have not already done so) and tune it to this FM channel.
- 8 Set your Radio to transmit on the same FM channel that you selected in step 7. Refer to the User Guide which accompanied your Radio for instructions on how to do this.

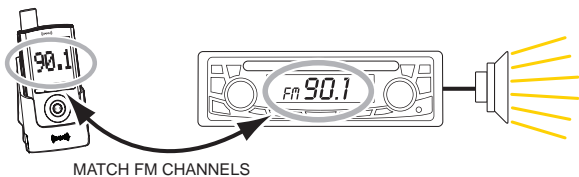

- 9 You should hear XM channel 1 through your vehicle's FM radio. If you are satisfied with the sound quality, you're done! Now sit back and enjoy Satellite Radio.
- 10 If the selected FM channel doesn't work well for you, work down the

list of FM channels until you find one that allows you to hear XM clearly. Each time, you will need to tune your vehicle's FM radio to the FM channel and then set your radio to transmit on the same FM channel (steps 7 & 9).

If the signal reception is good, but there is no XM audio when tuned to channel 1, verify that your radio's FM Transmitter is On (step 8), and that both the FM Transmitter and your vehicle's FM radio are tuned to the same FM channel (steps 7 & 9). Also ensure the chosen FM channel is a suitable one to use in your area (step 5). Verify that nothing is plugged into the **AUDIO** connector on the *PowerConnect Vehicle Dock*. Refer to "Troubleshooting" on page 52 for additional help.

Option 4: FM Direct Adapter (FMDA) Installation

The FMDA needs to be installed by a professional installer. Professional installation can help improve your radio's reception and significantly reduce the visibility of wires. To learn more, check with the retailer where you bought your radio, or go to xmradio.com/accessories.

Your installer will help you get set up, but if you travel away from your local area, you will want to familiarize yourself with the section called "How To Find Available FM Channels In Your Area" on page 48.

Appendix: How To Find Available FM Channels

How To Find Available FM Channels In Your Area

An available FM channel is one that is not being used by an FM radio station in your area. When you tune your FM radio to an available channel, you should only hear static or silence – not talk or music. Once you have found an available channel, you need to tune your Satellite Radio's built-in transmitter to the same channel to receive XM sound through your vehicle's radio.

We recommend one of the following methods to find an available FM channel:

1 Use the SIRIUS | XM FM Channel Finder

Use the SIRIUS | XM FM Channel Finder at www.xmradio.com/fmchannel. Go to the website and enter your zip code. The Channel Finder will suggest a list of available FM channels in your area. For convenience, write down or print out the list.

Now, tune your Satellite Radio to a favorite XM channel (or to channel 1, if it's not yet activated). Turn on your vehicle's FM radio. Pick the first FM channel on your Channel Finder list and tune the FM radio to that channel. If you do not hear a local FM station broadcast, then tune your Satellite Radio to the same FM channel. (Consult your Satellite Radio's User Guide if you are unsure how to tune it to the same FM channel.) You should hear the XM channel through your vehicle's radio. If you are satisfied with the sound quality, you're done! If this FM channel doesn't work well for you, work down the Channel Finder list until you find an FM channel that allows you to hear XM clearly.

OR

2 Manually tune through your local FM channels

Manually tune through your local FM channels on your vehicle's FM radio. Turn on your vehicle's FM radio. Start at 88.1 and use the 'Manual' tune function on your vehicle's FM radio to tune through each FM channel one-by-one (88.1 followed by 88.3 etc.) to locate channels that aren't being used by a local FM radio station. Write down each FM channel that has only static or silence on it, until you reach 107.9. Once you have created your list of available FM channels, you will need to find the one that provides the best match for your Satellite Radio.

Now, tune your Satellite Radio to a favorite XM channel (or to channel 1, if it's not yet activated). Pick the first FM channel on your list and tune the FM radio to that channel. Then tune your Satellite Radio to the same FM channel. (Consult your Satellite Radio's User Guide if you are unsure how to tune it to the same FM channel.) You should hear the XM channel through your vehicle's radio. If you are satisfied with the sound quality, you're done! If this FM channel doesn't work well for you, work down your list until you find an FM channel that allows you to hear XM clearly.



NOTE! You may find an FM channel with static or silence that does not work with your Satellite Radio. It is possible that some type of inaudible interference is present that prevents reception of the broadcast. Your only options are to use another FM channel or a different audio connection method.

Appendix: How To Find Available FM Channels



TIP! If you regularly drive from one location to another, such as your daily commute, you may need to use different FM channels along your route for best performance. If this is the case, we recommend saving the best FM channels as presets on your FM radio and on your Satellite Radio. Then you simply select and match the best channel for the area you are in.



TIP! It will be much more difficult to find available FM channels in large cities than in most suburban or rural locations. A direct audio connection using the Aux In Cable, Cassette Adapter, or professional installation is your best solution if you drive in or near large metropolitan areas.



NOTE! The SIRIUS | XM FM Channel Finder relies on data from the Federal Communications Commission. The data may not reflect the latest stations in your area. In addition, local geography and weather conditions can impact reception, so your results may be different from the list.



NOTE! The performance of FM radios are different, based on manufacturer and vehicle style. Some may not work well with the type of FM transmitter used by your Satellite Radio. This is why we recommend a direct audio connection using the Aux In Cable or Cassette Adapter if they can be used in your vehicle. Professional installation can also resolve almost any performance issue.

Troubleshooting

Troubleshooting

Your Vehicle Kit has been designed and built to be trouble-free, but if you experience a problem, try this:

- Check that all connections are firm and secure.
- Make sure the vehicle power socket is clean and free of corrosion.
- Make sure you have connected the radio as described in this installation guide. Verify that the *PowerConnect* Power Adapter is plugged into the vehicle's cigarette lighter or power adapter socket and that the LED on the *PowerConnect* Power Adapter is lit (on). If not, your vehicle may need to be running to provide power to the socket.

If you see this on the screen:	Try this:
Acquiring Signal	<ul style="list-style-type: none">• Make sure that the vehicle is outdoors with a clear view of the sky.• Make sure the Magnetic Mount Antenna is mounted outside of the vehicle.• Move your antenna away from any obstructed area. For example, if you are parked in an underground garage, you should receive a signal after leaving the garage.
Check Antenna Connection	<ul style="list-style-type: none">• Make sure that the Magnetic Mount Antenna cable is firmly and securely plugged into the <i>PowerConnect</i> Vehicle Dock. Make sure the cable is not bent or broken.• Turn the radio off, then on, to reset this message.• If the message persists, most likely the antenna cable has been damaged. Replace the antenna.

If you see this on the screen:	Try this:
Channel Off Air	<ul style="list-style-type: none"> • The channel you've selected is not currently broadcasting. Tune to another channel.
Loading	<ul style="list-style-type: none"> • Your radio is acquiring audio or program information. This message usually goes away in a few seconds.
Updating	<ul style="list-style-type: none"> • Your radio is being updated with the latest encryption code. Wait until the update is done. • You may be trying to tune to a channel that is blocked or unavailable. Tune to another channel.
–	<ul style="list-style-type: none"> • No program information, such as artist name, song title, or channel exists.
If this happens:	Try this:
You do not receive all the channels to which you subscribed	<ul style="list-style-type: none"> • If you have not yet activated your service, refer to the User Guide which accompanied your radio. • Go to www.xmradio.com/refresh and follow the directions refresh your radio. • Call 1-800-967-2346 for further assistance.
No audio when using the Aux In Cable or Cassette Adapter	<ul style="list-style-type: none"> • Check all cables between your radio and your vehicle's stereo system for a firm and secure connection. • Ensure you have selected the proper input source on your vehicle's stereo system. • Ensure that the FM Transmitter in the radio is turned Off, and increase the audio level of the radio. Refer to the User Guide which accompanied your radio for instructions.

Troubleshooting

If this happens:	Try this:
Audio sounds too soft	<ul style="list-style-type: none">• Raise the volume of your stereo system or increase the audio level of your radio until the sound quality improves. Refer to the User Guide which accompanied your radio for instructions.
Audio fades or has static when listening	<ul style="list-style-type: none">• Check all cables for a firm and secure connection.• If you are using <i>PowerConnect</i> or the <i>FMDA</i> to listen via your vehicle's FM radio, and the problem persists, it most likely is interference from another commercial or broadcast FM station. You will need to find an unused or available FM channel in your area. Refer to step 5 on page 43.• If you are using <i>PowerConnect</i>, and you cannot solve the audio problem, try connecting the audio using the <i>Aux In Cable</i> or a <i>Cassette Adapter</i>. (Refer to page 39 and page 41.) If you cannot use those solutions, consider using an <i>FM Direct Adapter</i>. (Refer to page 45.)
No audio when using <i>PowerConnect</i> or <i>FMDA</i>	<ul style="list-style-type: none">• Check that your radio and your vehicle's FM radio are tuned to the same FM channel.
No song title or artist name is displayed	<ul style="list-style-type: none">• The information may not be available or updates may be in progress.
Traffic and Weather channels sound different from other channels	<ul style="list-style-type: none">• These channels use a different audio technology than other channels so they often sound different from other channels.

If this happens:	Try this:
The radio shuts off unexpectedly	<ul style="list-style-type: none">• If Power Off is set, the radio will turn off after the selected length of time in the Vehicle Dock. Set Power Off to Off.
The demo is playing	<ul style="list-style-type: none">• Your Magnetic Mount Antenna is not connected or you are not receiving the signal. Check that the antenna is connected properly and is not obstructed.

Product Specifications

Product Specifications

PowerConnect Vehicle Dock

Dimensions	57.0 mm (W) x 81.6 mm (H) x 45.2 mm (D) 2.2 in (W) x 3.2 in (H) x 1.8 in (D)
Weight	49 grams (1.7 oz)
FM Connector	2.5 mm female
Audio Connector	3.5 mm female
Antenna Connector	SMB male
Power Connector	4.8 mm female

PowerConnect Power Adapter

Dimensions	94 mm (w) x 43 mm (H) x 34 mm (D) 3.7 in (W) x 1.7 in (H) x 1.3 in (D)
Weight	69 g (2.4 oz)
Input/Output	9-16 V DC / 5 V DC, 1.5 A
Cable Length	1.4 m (4 ft 7 in)

Vehicle Antenna

Type	XM Magnetic Mount
Connector	SMB female, right angle
Cable Length	6.4 m (21 ft)

Aux In Cable

Connectors	3.5 mm to 3.5 mm stereo male/male
Cable Length	1.2 m (4 ft)

Remote Control

Dimensions	40 mm (W) x 119 mm (H) x 14 mm (D) 1.6 in (W) x 4.7 in (H) x 0.6 in (D)
Weight	40 g (1.4 oz)
Battery	CR2032 (3 V)

Patent and Environmental Information

Patent Information

It is prohibited to, and you agree that you will not, copy, decompile, disassemble, reverse engineer, hack, manipulate, or otherwise access and/or make available any technology incorporated in this product. Furthermore, the AMBE™ voice compression software included in this product is protected by intellectual property rights including patent rights, copyrights, and trade secrets of Digital Voice Systems, Inc. The software is licensed solely for use within this product. The music, talk, news, entertainment, data, and other content on the Services are protected by copyright and other intellectual property laws and all ownership rights remain with the respective content and data service providers. You are prohibited from any export of the content and/or data (or derivative thereof) except in compliance with applicable export laws, rules and regulations. The user of this or any other software contained in a SIRIUS | XM radio is explicitly prohibited from attempting to copy, decompile, reverse engineer, hack, manipulate or disassemble the object code, or in any other way convert the object code into human-readable form.

Environmental Information

Follow local guidelines for waste disposal when discarding packaging and electronic appliances.

Your Vehicle Kit is packaged with cardboard, polyethylene, etc., and does not contain any unnecessary materials.

FCC Statement

The user is cautioned that changes or modifications not expressly approved by SIRIUS XM Radio Inc. can void the user's authority to operate this device.

This device complies with Part 15 of the FCC Rules. Operation is subject to the following two conditions:

1. This device may not cause harmful interference.
2. This device must accept any interference received, including interference that may cause undesired operation.

This equipment has been tested and found to comply with the limits for a Class B digital device, pursuant to Part 15 of the FCC Rules. These limits are designed to provide reasonable protection against harmful interference in a residential installation.

This equipment generates, uses, and can radiate radio frequency energy and, if not installed and used in accordance with the installation instructions, may cause harmful interference to radio communications. However, there is no guarantee that interference will not occur in a particular installation. If this equipment does cause harmful interference to radio or television reception, which can be determined by turning the equipment off and on, the user is encouraged to try to correct the interference by one or more of the following measures:

- Reorient or relocate the receiving antenna of the affected receiver.
- Increase the separation between the SIRIUS | XM equipment and the affected receiver.
- Connect the SIRIUS | XM equipment into an outlet on a circuit different from that to which the affected receiver is connected.
- Consult the dealer or an experienced radio/TV technician for help.

WARNING! The FCC and FAA have not certified Satellite Radio Receiver use in any aircraft (neither portable nor permanent installation). Therefore, SIRIUS XM Radio Inc. cannot support this type of application or installation.

Copyrights and Trademarks

Hardware and subscription sold separately. Activation fee, other fees, and taxes required. Installation required with some equipment. Except for the MiRGE radio, and as specifically provided, SIRIUS and XM Radios and accessories are compatible only with their respective subscription service. Subscriptions governed by, as applicable, the SIRIUS Terms & Conditions available at sirius.com, or the XM Customer Agreement available at xmradio.com. Prices and programming are subject to change. SIRIUS XM U.S. Service only available in the 48 contiguous United States and D.C. Service available in Canada; see www.siriuscanada.ca or www.xmradio.ca.

© 2009 SIRIUS XM Radio Inc. SIRIUS, XM and all related marks and logos are trademarks of SIRIUS XM Radio Inc. and its subsidiaries. All other trademarks, service marks and logos are the property of their respective owners. All rights reserved.

WARNING: This product contains chemicals known to the State of California to cause cancer and birth defects or other reproductive harm.

xmradio.com

SIRIUS XM Radio Inc.
1221 Avenue of the Americas
New York, NY 10020

1.800.967.2346

© 2009 SIRIUS XM Radio Inc.

XMp3i™ PowerConnect Vehicle Kit User Guide (XMP31VKUG1109) 111209b