



Samsung Electronics America, Inc.
400 Valley Road
Mount Arlington, NJ 07856
1-800-SAMSUNG (1-800-726-7864)
www.samsung.com

XM respects copyrights. This device is for personal use only. XM Programming stored on the device cannot be transferred off the unit. Download legally. Buy digital music from XM+Napster.

The XM name, related logo, and NeXus are trademarks of XM Satellite Radio Inc. All rights reserved.

YP-X5X
YP-X5Z

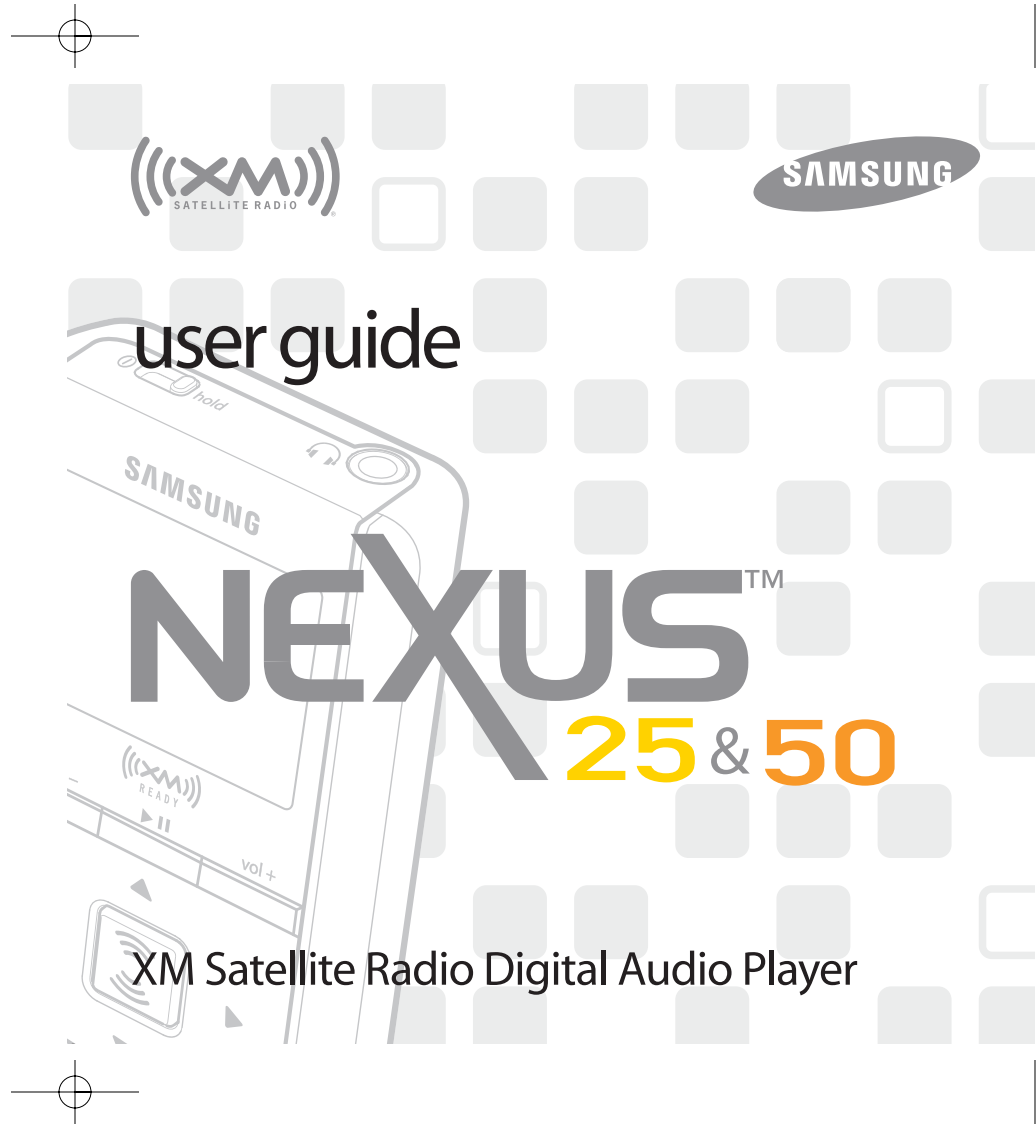

Quick Start

1. Charge battery for at least 8 hours (page 12).
2. Set up your player (page 18).
3. Activate your XM subscription (page 17).
4. Listen to and record live XM* (pages 24 and 28).
5. Listen to recorded content on the go (page 32).
6. Manage your songs and playlists from your computer (page 51).
7. Buy songs from XM+Napster (page 50).

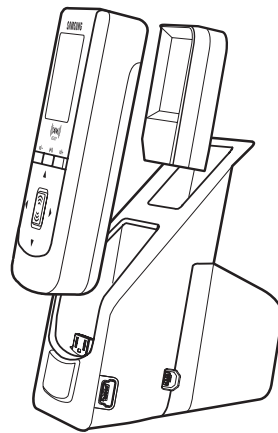

*Hardware and required monthly subscription sold separately. Installation cost and other fees and taxes, including a one-time activation fee may apply. Subscription fee is consumer only. XM products, programming, services, and fees are subject to change, at any time, without notice. Channels with frequent explicit language are indicated with an XL. Channel blocking is available for XM radio receivers by calling 1-800-XM-RADIO. Subscriptions subject to Customer Agreement available at xmradio.com. XM service only available in the 48 contiguous United States. ©2006 XM Satellite Radio Inc. All rights reserved.

Contents

Introduction	4	Purchasing Music	50
Features.....	4	Organizing Your Music	51
Safety Instructions.....	7	Disconnecting the Player from the PC	55
What's in the Box.....	10	Listening to XM Radio Online (XMRO)....	56
Charging the Battery.....	12	Using Your CDs or MP3/WMA Files	57
Player Controls	13	Updating NeXus Firmware	60
Using the Controls	14	Settings	62
Player Display.....	15	FM Frequency.....	62
Remote.....	16	Audio	64
Subscribing to XM	17	Display	65
Using Your Player Alone	18	Channel Access.....	66
Setup	18	Time	67
Live XM	24	Sleep Timer	67
Recording XM.....	28	Memory Partition	68
Listening to Recorded XM Content.....	32	Restoring Factory Defaults	69
Organizing Your Music	33	Customer Support	70
Using Your Player with a PC ..	42	Troubleshooting	70
System Requirements	42	Specifications	73
Setup	43	Patent Information	75
Registering with XM+Napster	46	FCC Statement	76
What Can You Do with XM+Napster?	49	Warranty.....	77
Exploring	49		

Introduction

Features

Congratulations on your purchase of the Samsung NeXus™ – our newest digital audio player plus XM® Satellite Radio.

Like any digital audio player, you can enjoy listening to your music anywhere you go. But NeXus offers more: dock the player into a home or vehicle cradle, plug in the XM Passport and an antenna, and access XM's 160 channels from coast to coast, with over 80,000 hours of entertainment each month. XM offers musical choice, variety, and discovery – worlds beyond your own collection – plus a wide range of news, sports, talk, comedy, kids, and entertainment channels. Hear XM live, or save XM programming on your NeXus to listen at your leisure.

We've also teamed up with Napster, a leading provider of online music. Imagine discovering a new artist on XM and then, with just a few clicks of a mouse, buying high-fidelity tracks and albums by that artist. It's that simple.

We also provide you with the XM+Napster program that lets you manage all your music – XM tracks, songs you purchase from Napster, and MP3/WMA files you rip from your CDs – on one integrated package on your Microsoft® Windows® PC.

One device, all the music you could ever hope for, and the easiest way to find the music you want – now that's a music experience!

Introduction

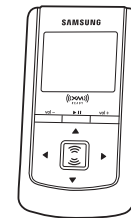

NeXus, Undocked

- Listen to recorded XM content and MP3/WMA files
- Manage your music

ENG

NeXus + Cradle + Antenna

- Listen to live XM*, recorded XM*, and MP3/WMA files
- Listen at home or in your car (Car Accessory Kit YA-CP200 sold separately); you only have to carry your NeXus player and the XM Passport between locations
- Manage your music

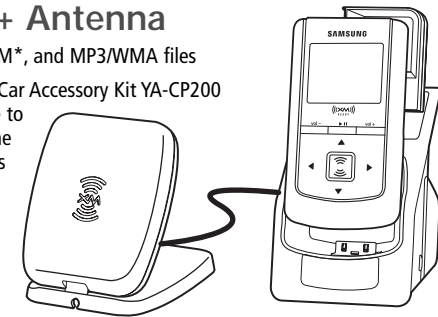

*Hardware and required monthly subscription sold separately. Installation cost and other fees and taxes, including a one-time activation fee may apply. Subscription fee is consumer only. XM products, programming, services, and fees are subject to change, at any time, without notice. Channels with frequent explicit language are indicated with an XL. Channel blocking is available for XM radio receivers by calling 1-800-XM-RADIO. Subscriptions subject to Customer Agreement available at xmradio.com. XM service only available in the 48 contiguous United States. ©2006 XM Satellite Radio Inc. All rights reserved.

Introduction

NeXus + Cradle + Antenna + PC

- Manage your music using NeXus or the PC
- Listen to XM Radio Online
- Purchase music from XM+Napster and transfer purchased music to your NeXus player



Introduction

Safety Instructions

NeXus Digital Audio Player

Please read and understand all the instructions to avoid injury to yourself and/or damage to the player.

Do not expose to extreme temperatures (above 140°F or below -4°F, or above 60°C or below -20°C).

Do not expose to moisture. Do not use this product near water.

Do not let any foreign matter spill into the player.

Do not expose to chemicals such as benzene and thinners. Do not use liquid or aerosol cleaners. Clean with a soft damp cloth only.

Do not expose to direct sunlight or heat sources for a prolonged period.

Do not try to disassemble and/or repair the player yourself.

Do not subject the unit to severe impact.

Do not place heavy objects on the player.

Do not subject the player to excessive pressure.

Do not touch the charger with wet hands.

Do not store in dusty areas.

Please be aware that Samsung claims no responsibility for damage from data loss due to breakdown, repair, or other causes.

Introduction

Earbuds and Headphones

Follow traffic safety instructions

- Do not use the earbuds while driving an automobile or riding a bicycle. It's not only dangerous, but against the law.

Protect your ears

- Do not turn up the volume too high. Doctors warn against prolonged exposure to high volume.
- Stop using the player or turn the volume down if you have ringing in your ears.
- Take care so that the earbud cable is not caught by your arm or other objects while walking or exercising.

Environmental Information

Follow local guidelines for waste disposal when discarding packaging, batteries, and electronics appliances.

Your player is packaged with cardboard, polyethylene, etc., and does not contain any unnecessary materials.

Introduction

Battery Charger Safety

Caution: Opening the case may result in electric shock.

Caution: The uninsulated parts inside the power adapter and cradle may cause electric shock or fire. For your safety, please do not open these components. Do not let metallic objects such as necklaces or coins come into contact with the power adapter plugs or battery terminal.

Caution: To avoid electric shock, use the power adapter only with an outlet that matches the shape of the adapter's plug.

Caution: Make sure that you insert the adapter's plug all the way into the outlet.

Caution: To avoid the risk of fire, do not charge longer than 12 hours.

Caution: Do not plug several devices into the same electrical outlet.

Important: Always read and understand the user guide to help prevent problems.

Warning: Use the power adapter and cradle away from water sources to avoid fire or electric shock.

Introduction

What's in the Box

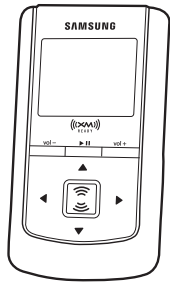

NeXus player
(NeXus 25: YP-X5X, NeXus 50: YP-X5Z)

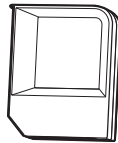

XM Passport



Battery

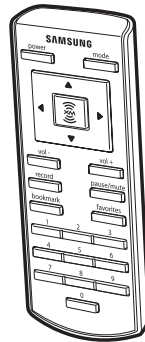

Remote

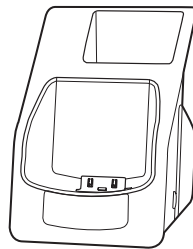

Home dock/cradle
(YA-CD200)

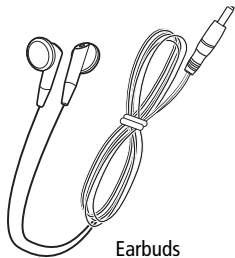

Earbuds
(EP-360)



Carrying
case/holster

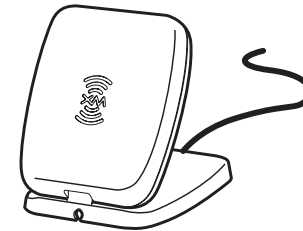

Home XM antenna

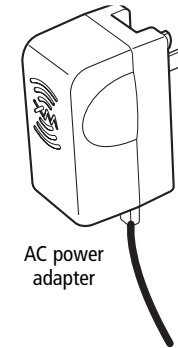

AC power
adapter

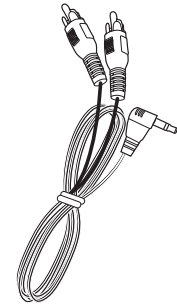

RCA audio cable

Also included:
USB cable
User guide
XM+Napster install CD

Introduction

Introduction

Charging the Battery

Charge the battery for at least 8 hours before using your player for the first time, or if you have not used it for several months. When charging, make sure the ambient temperature is between 32°F and 113°F (0°C to 45°C).

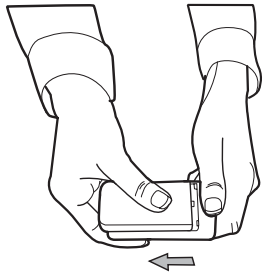

1. Open battery compartment.

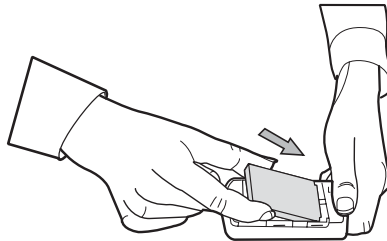

2. Insert battery into player.

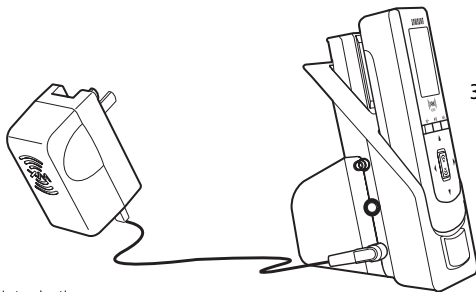

3. Plug adapter into cradle and wall socket.

Introduction

Player Controls

Power button – Slide left to turn power on or off. Slide right to “hold” controls, preventing you from accidentally pressing a button.

Arrow buttons – Select menu entries, change channels, cycle through categories, skip to next or previous songs, and more

Home cradle

Audio, power, and antenna connections

IR window – Point the remote here

Earbud jack

Display

XM Passport

Pause/Mute – Pause playback or mute live XM

Volume

XM button – Start here; press to access channels, playlists, menus, and confirm selections

Digital antenna jack

USB jack

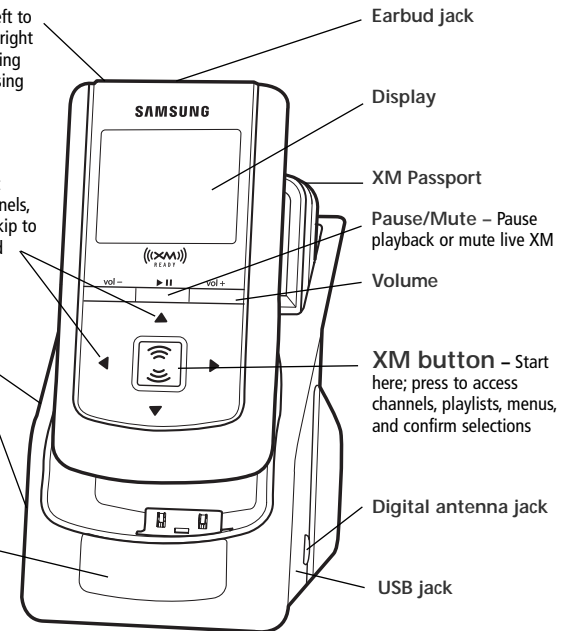

Introduction

Using the Controls

Throughout this guide, you will see instructions such as "Select **XM** → **Settings** → **Setup** → **Antenna Aiming**." This tells you to perform the following actions:

1. Press the **XM** button.
2. The displayed menu's last option is "Settings." Press the down arrow button to highlight "Settings," then press the **XM** button to select it.
3. The next displayed menu's third option is "Setup." Again, press the down arrow button to highlight "Setup," and press the **XM** button to select it.
4. The last menu's second option is "Antenna Aiming." Press the down arrow button to highlight "Antenna Aiming," then the **XM** button to select it.

Not all of the menu items described in this guide may appear on your NeXus display. For example, if you have not recorded any XM content and have not stored any MP3 or WMA files, you will not see "My Music" if you press the **XM** button while listening to live XM.

NOTE: Remember that pressing the left arrow button generally allows you to "back out" of any menu.

Introduction

Player Display

Available memory – Black portion indicates amount of storage available. White portion indicates amount of storage taken up by locked XM songs (page 35). "!" indicates that there is less than 3 minutes of storage available. In "Live XM" mode, you will see a signal strength indicator instead.

While listening to "Live XM," this box shows the channel name. During "My Music," this box indicates whether you're viewing all songs, or songs by a particular artist, channel, category, or recording session.

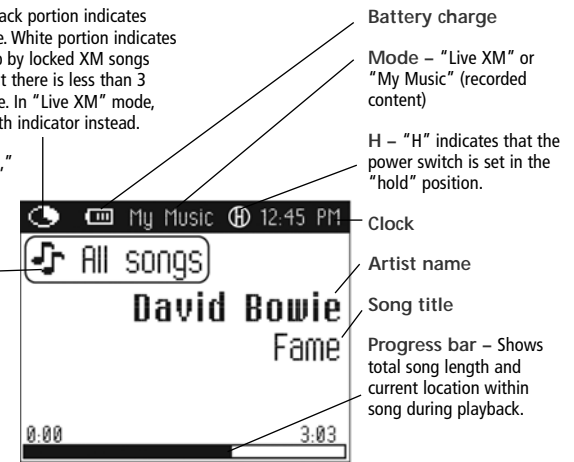

Additional symbols:

play	track assigned to a playlist
reverse or fast-forward through track	PC track is assigned to a playlist
pause	XM track is locked
skip to previous or next track	repeat track
PC track (MP3 or WMA file)	play tracks randomly

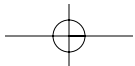

Introduction

Subscribing to XM

Remote

Power button

Left arrow button – Pressing the left arrow button also allows you to “back out” of any menu you have selected

Volume

Record – Press and release to start recording a song, or to stop recording. Press and hold to start recording a channel. If you’re already recording a channel, pressing and holding this button ends recording after the current song.

Bookmark – Tag interesting songs or tracks

Numeric keypad – Select XM channels by channel number

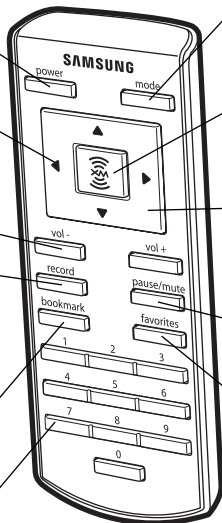

Mode – “Live XM” or “My Music” (recorded content)

XM button – Access menus and confirm selections

Arrow buttons – Select menu entries, change channels, cycle through categories, skip to next or previous songs, and more

Pause/Mute – Pause playback or mute live XM

Favorites – Go to favorite channels

Before you can listen to or record XM content, you must activate your player.

1. Set up your player, cradle, power adapter, and antenna (page 18 or page 20). Make sure the XM Passport is inserted in the cradle and that the player can receive the XM signal.
2. Place NeXus in the “Live XM” mode (page 24).
3. Find the 8-character XM Radio ID, which is printed on the XM Passport and on the package. Or select XM channel 0 to view the Radio ID. Record the Radio ID here for reference:

--	--	--	--	--	--	--	--

The XM Radio ID does not use the letters I, O, S, or F.

4. Activate your XM Satellite Radio service online at <http://activate.xmradio.com> or by calling 1-800-XM-RADIO (1-800-967-2346). You will need a major credit card.

XM will send a signal from the satellites to activate the full channel lineup. Activation normally takes 10 to 15 minutes, but during peak busy periods, you may need to keep your player on for up to an hour. When you can access the full channel lineup on your player, you’re done!

ENG

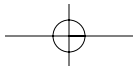

Using Your Player Alone

Setup: At Home

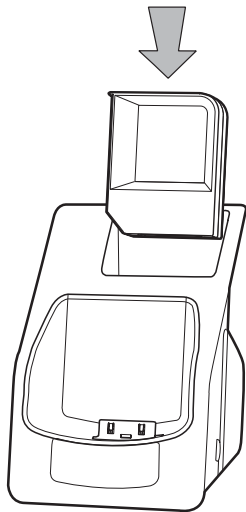

1. Insert XM Passport into home cradle.

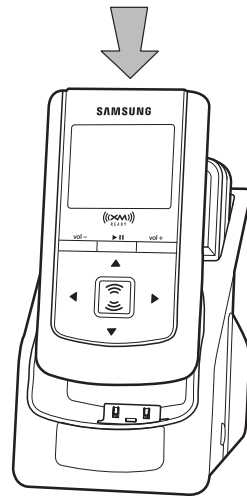

2. Insert player into home cradle.

Using Your Player Alone

3. Connect NeXus to your audio system. Connect power adapter and home antenna. Point antenna toward the southern sky through a window.

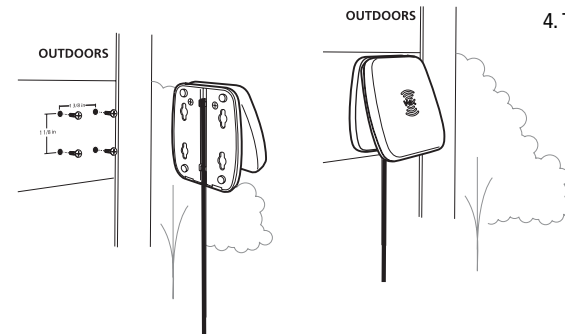
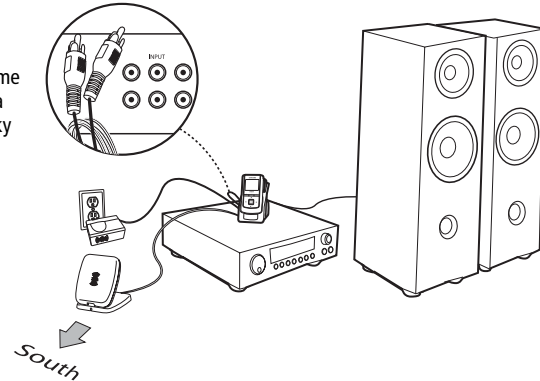

4. To optimize signal reception, you may mount the home antenna outdoors, facing south. Make sure the antenna is not blocked by buildings or trees.

ENG

Using Your Player Alone

Setup: In a Vehicle

(requires Car Accessory Kit, sold separately)

Every vehicle is different; for your safety, follow all instructions carefully. Consult a professional installer if you have questions.

You can listen to your Samsung NeXus through your car stereo by using the FM transmitter built into the optional car cradle. Simply find an unused FM frequency on your car stereo and set NeXus to transmit on that same frequency.

1. Mount antenna to the roof or trunk of the vehicle. During installation, make sure you are outdoors and the antenna is not obstructed by tall buildings.

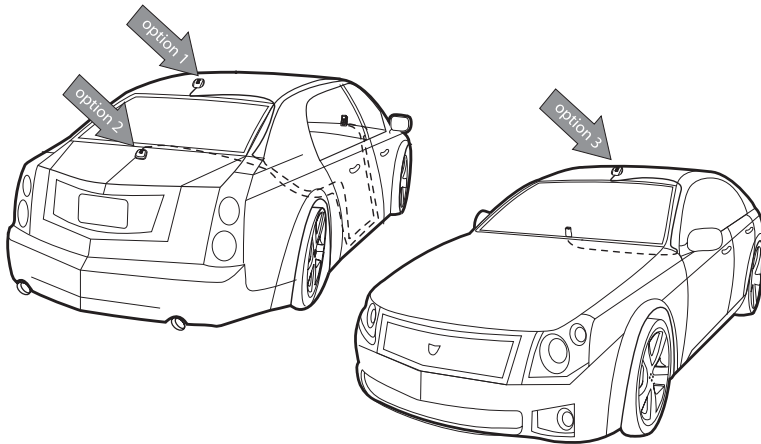

Using Your Player Alone

2. Insert XM Passport and player into car cradle.

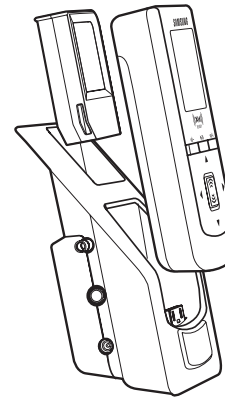

3. Connect car cradle to antenna cable and power adapter.

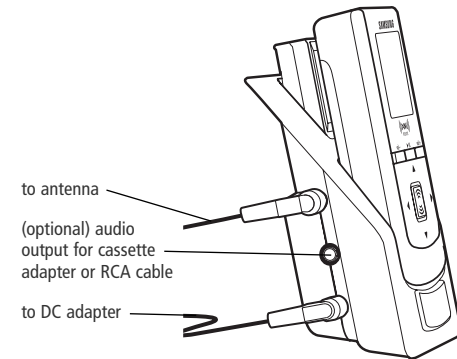

Using Your Player Alone

4. To install the swivel mount, first find a suitable location. The swivel mount's adhesive is very strong and may be difficult to remove. Do not install this mount on leather surfaces and make sure the air temperature is at least 60°F (15°C).

Clean the mounting surface with the surface preparation kit. Peel away the adhesive liner and firmly press the swivel mount to the surface for 30 seconds. Allow 24 hours before using the mount.

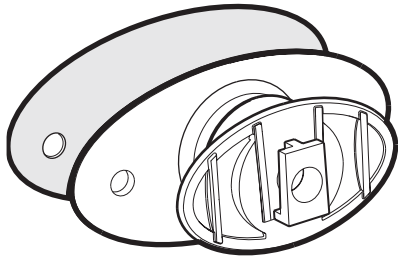

You can adjust the tension of the mount with a screwdriver.

If you need to remove the mount, carefully lift the adhesive pad with your fingers or a spoon. Warming with a hair dryer for several minutes will help soften the adhesive.

Using Your Player Alone

5. To install the vent mount, find a horizontal vent that is strong enough to hold your NeXus and its cradle. To remove the vent mount, push it into the vent and lift upwards slightly to release the mount's hooks from the vent vane.

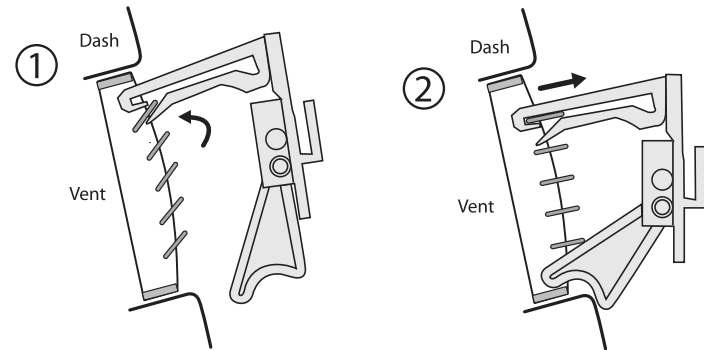

6. Find an unused FM frequency on your car stereo.
 7. Set your NeXus to the same FM frequency. (Refer to the section marked "Settings," "FM Frequency.")
 8. Tune NeXus to XM channel 1. You should be able to hear XM through your car stereo.

Using Your Player Alone

Live XM

NOTE: You must dock your NeXus in its cradle, with the XM Passport, power adapter, and antenna connected, and power it on for a total of 8 hours a month. This authenticates your XM subscription and ensures that you can continue to enjoy your recorded XM content and live XM programming.

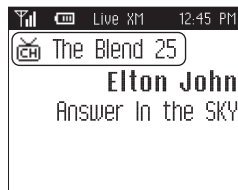

Turn on the player. Subscribe to XM (page 17) if you haven't done so already.

If you see "Live XM" at the top of the display, you're listening to XM content that is currently being broadcasted from the satellites.

If you see "My Music" on the display, perform these steps to hear live XM:

1. Press the **XM** button to display the menu.
2. Use the arrow buttons to highlight "Live XM" and press the **XM** button to select it.

Using Your Player Alone

Selecting Channels

Press the up or down arrow buttons to scroll through the list of channels.

– OR –

Press the number keys on the remote that correspond to the channel number.

– OR –

1. Press the left arrow button on the player. You will see a virtual keypad on the display.

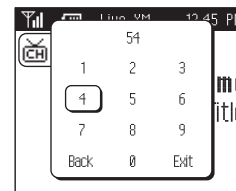

2. Use the arrow buttons to select the digits corresponding to the channel number. Press the **XM** button after highlighting each digit.

3. When you've entered a valid channel number, the player will tune to that channel after 2 seconds.

Using Your Player Alone

Favorite Channels

You can save your favorite channels in an easily accessible list.

1. While you're tuned to a channel, press the **XM** button.
2. Select **Favorite Channels** → **Add Channel**.
3. To remove a channel from the "Favorites" list, select **XM** → **Favorite Channels** → **Remove Favorite Ch** → (channel name) → **Remove Channel**.
4. Once you've saved your favorites, you can quickly access the list. From the "Live XM" screen, simply press the right arrow button to see your "Favorites" list. Press the up and down arrow buttons, then the **XM** button to select the desired channel.

Using Your Player Alone

Categories

XM channels are organized into categories, or genres, such as "Rock," "Jazz," or "News." To find a channel by category:

1. Push the right arrow button one or more times. The category name appears in the display. "Favorites" is your first category if you have designated any channel as a "favorite channel."
2. When you've found the category you want, press the up or down arrow buttons to select a channel.
3. Choose **Select** to tune to that channel.

ENG

Using Your Player Alone

Recording XM

Your NeXus enables you to record XM content for personal use. You may record XM content while listening to live XM or by scheduling a recording session. You can then listen to recorded XM content on the go. You can also personalize your XM content by creating playlists for every mood and occasion.*

To record XM content, you must dock NeXus in its cradle, install XM Passport, and attach the antenna and power adapter.

Recording a Single Song

1. While you're listening to live XM, select **XM → Record → Record Song**. Don't worry if you miss the beginning of the song; your NeXus captures the entire song even if you start up to 45 seconds after the beginning of the song, as long as you're already tuned to that channel.
2. By selecting "Record Song," you instruct your NeXus to stop recording at the end of the song.
3. To stop recording immediately, press the **XM** button and select **XM → Record → Stop Recording**. If you change channels, NeXus automatically stops recording.
4. Alternatively, you can continue recording the channel you're listening to by selecting **XM → Record → Record Channel**. Recording will not stop until you select **XM → Record → Stop Recording**.

SHORTCUT: To immediately start recording at any time, press and hold the **XM** button until you see the "Recording ..." message on the display.

*XM content cannot be removed from the NeXus digital audio player. If you wish to own a complete, high-fidelity version of digital content on demand, you should purchase content from XM+Napster. This allows you to store the content on multiple devices.

Using Your Player Alone

Recording a Channel

1. While you're listening to live XM, select **XM → Record → Record Channel**. You will record the channel you're currently listening to.
2. To stop recording immediately, select **XM → Record → Stop Recording**. If you change channels, NeXus automatically stops recording.
3. Alternatively, you can choose to stop recording at the end of the song you're currently listening to by selecting **XM → Record → Record Song**.

Scheduling a Recording Session

You can set NeXus to record XM at a later time. To record live XM, you must dock NeXus in its cradle, and attach the antenna, XM Passport, and power adapter.

1. To schedule a recording session, select **XM → Record → Schedule Recording → New Session**.
2. The "Edit Session" display allows you to set various options. Use the up and down arrow buttons to adjust each entry. Press the **XM** button to accept the entry and move to the next option.

Using Your Player Alone

The screenshot shows the 'Scheduled Rec' menu with the following options: 'When Today', 'Start Time 12:00 PM', 'End Time 1:00 PM', 'Channel 82', and 'Accept'. Callouts provide the following instructions:

- You can choose to schedule a session for "Today," "Everyday," or a specific "Date."
- Set start and stop times using the up and down arrow buttons. If the session length exceeds the available memory, you will record over the oldest XM tracks in the memory, so you'll always have the latest content.
- Choose the channel you want recorded.
- Choose "Accept" to save the session. You can also edit the session. To cancel, press the left arrow button.

- To edit an existing session, select **XM** → **Record** → **Schedule Recording**. You will see a list of sessions. Highlight the session you wish to edit.

The screenshot shows the 'Scheduled Rec' menu with the following options: '<New Session>', 'Ethel 11/23/06', 'The 70s Everyday 3', and 'Fox News Today 8a'.

You may not see all the sessions that you scheduled in the past. Sessions that have expired are automatically removed from the list.

Using Your Player Alone

- Choose **Edit Session** to change the session's options.
- To delete a session, choose **Cancel Session**.

At the scheduled time, your recording session will begin if NeXus is docked in its cradle. NeXus may be powered on or off, but you **must** attach the power adapter. Remember that when you schedule a recording session, you are instructing NeXus to switch to the desired channel.

Using Your Player Alone

Listening to Recorded XM Content (My Music)

You are listening to XM content that you have recorded when you see "My Music" at the top of the display.

1. To switch to "My Music" from "Live XM," select **XM** → **My Music**.
2. Press the up and down arrow buttons to scroll through the list of songs that you have recorded on NeXus. Highlight the song you want to listen to, then select **Play** to start playing from that song.
3. Alternatively, while you're listening to a song, simply press the right arrow button to skip to the next song. Press the left arrow button to skip to the previous song.
4. While you're listening to a song, you can also press and hold the right arrow button to fast forward through that song. Press and hold the left arrow button to reverse through the song.

NOTE: In order to access your XM content you have recorded on NeXus, you must (1) maintain an active XM Satellite Radio subscription, and (2) dock your NeXus to its cradle, XM Passport, power adapter, and antenna for a total of 8 hours a month.

Using Your Player Alone

Organizing Your Music

Finding Your Music

All songs and tracks that are stored in your NeXus are normally played in the order that they were recorded or transferred into the player. You can also sort the selections by artist, category, channel, or recording session.

1. While listening to recorded tracks in "My Music," select **XM** → **Find**.
2. To sort your stored music by artist, select **Artists**.



View all songs on your NeXus.

You can also sort songs by artist, category, channel, or recording session.

Using Your Player Alone

- Press the up or down arrow buttons to scroll through the list of artists. Press the **XM** button to select an artist.

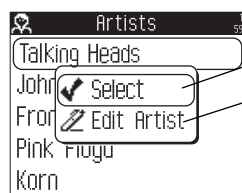

Shows the artist's songs in alphabetical order.

Opens the Edit window, allowing you to add an artist to a playlist, lock or unlock all the artist's songs, or delete all the artist's songs.

- Once you've selected an artist, you will see a list of the artist's songs that you have recorded.
- Select the song you want to hear using the arrow and **XM** buttons. Select **Play** to begin playing that song.
- To return to the list of artists, press **XM** → **Find** → **Artists** and select another artist as in steps 3 and 4.
- You can also sort your tracks by categories or by channels. WMA and MP3 songs show the category or genre that they are assigned to using their ID3 tags, which may or may not be the same as the XM category. WMA and MP3 songs are also assigned to a channel named "MP3/WMA."

SHORTCUT: As soon as you've highlighted an artist or a song, simply press the right arrow button to start playback.

Using Your Player Alone

Locking and Unlocking XM Content

When you record XM, your NeXus records over the oldest XM tracks first. This ensures that you always hear the latest XM content. You can "lock" a song or track to prevent NeXus from recording over it. Locked songs occupy memory on your NeXus and reduce your recording time. Remember that you can buy high-fidelity songs or albums from XM+Napster that can be stored either on your NeXus or on your PC.

- While you're listening to a song in "My Music," press the up or down arrow buttons to view the list of songs.
- Highlight the song you want to lock.
- Select **XM** → **Edit Song** → **Lock Song**.
- The locked song is indicated with a padlock symbol to the left of the song title.
- To unlock a song, highlight the song in the list and select **XM** → **Edit Song** → **Unlock Song**.

SHORTCUT: To lock the song that you're currently listening to, press and hold the **XM** button, then select **Lock Song**.

You can also lock all songs by an artist, in a category, or in a channel. To lock all songs by an artist:

- Select **XM** → **Organize** → **Artists** → (artist name) → **Lock Artist**.
- All songs by this artist are displayed with a padlock symbol to the left of the song title.

If you add a song to a playlist, that song is automatically locked.

Using Your Player Alone

Playlists – Adding Songs

You can create one or more custom lists, called playlists. Each playlist is an index of songs that play in a certain order. You can create a “morning drive” playlist, a “workout” playlist, a “best of” playlist, and more.

1. To add a song to a playlist, first select a song using the up or down arrow buttons. The song may be a recorded XM track, an MP3 track, or a WMA track, including songs purchased through XM+Napster.
2. Select **XM** → **Edit Song** → **Add to Playlist**.
3. You can choose to add the song to an existing playlist, or to create a new playlist. To choose an existing playlist, simply highlight and select the playlist name. To create a new playlist, choose **New Playlist** and use the virtual keyboard to name that playlist.
4. The display confirms by showing “Song Added.”
5. Adding a song to a playlist automatically locks that song.

SHORTCUT: To add the song that you’re currently hearing to a playlist, press and hold the **XM** button, then select **Add to Playlist**.

You can add a song to more than one playlist.

You can also add all songs by an artist to a playlist; select **XM** → **Organize** → **Artists** → **(artist name)** → **Add to Playlist**. You can also add all songs in a particular XM channel or category to a playlist.

Using Your Player Alone

Playlists - Removing Entries

After creating a playlist, you can edit it by rearranging its entries or by removing entries. Remember that removing a song from one playlist does not remove it from any other playlist, and does not delete that song from NeXus.

To remove one or more songs from a playlist:

1. Select **XM** → **Playlists** → **(playlist name)** → **Edit Playlist** → **Remove Songs**.
2. Use the up and down arrow buttons to highlight a song.
3. Press **XM** → **Select Song**. The song’s name will be displayed in gray.
4. Use the up and down arrow buttons to highlight another song, and press the **XM** button to select that song. Do this for all the songs you want to remove. (If you press the right arrow button, you automatically select that song for deletion and advance to the next song.)
5. Select **XM** → **Remove Song** → **Yes**.
6. NeXus confirms by displaying “Songs Removed.”

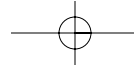

Using Your Player Alone

Playlists – Playing

1. Select **XM** → **Playlists** → (playlist name) → **Select**.
2. Choose a song you want to hear and press the **XM** button.
3. You will see the following options:



- Play songs in the order listed in the playlist, starting from the selected song.
- Play songs in random order, starting from the selected song. To cancel random play, select a song but choose "Play" instead of "Random."
- Repeat the selected song. To cancel repeat play, select a song but choose "Play" instead of "Repeat Song."

4. To exit a playlist and return to all songs, select **XM** → **Find** → **All Songs**.

Using Your Player Alone

Playlists – Renaming

To rename a playlist:

1. Select **XM** → **Playlists** → (playlist name) → **Edit Playlist** → **Rename Playlist**.
2. Use the virtual keyboard to change the name of the playlist.
3. Select "OK" when you're done.

ENG

Using Your Player Alone

Bookmarking Songs

"Bookmarks" are a great way to remember interesting songs. You can view all your bookmarks through the XM+Napster application, look up information about the artist or album, or purchase a complete, high-fidelity version of the song that you may play on multiple devices through XM+Napster. You may also purchase songs by the same artist through XM+Napster.

To bookmark a song in My Music:

1. Press the up or down arrow buttons until you've highlighted the song you want to bookmark.
2. Press **XM** → **Edit Song** → **Bookmark**.
3. NeXus confirms by displaying "Info Added."

To bookmark a song in "Live XM":

1. Select **XM** → **Bookmark**.
2. NeXus confirms by displaying "Info Added."

SHORTCUT: To bookmark the song that you're currently listening to, press and hold the **XM** button, then select **Bookmark**. You can only bookmark recorded XM tracks, not MP3 or WMA tracks.

Using Your Player Alone

Deleting Songs

When you're no longer interested in a song or track, you can delete it from your NeXus. "Deleting" a song permanently erases it from memory, and is different from "removing" a song from a playlist.

To delete one song from My Music:

1. Press the up or down arrow buttons until you've highlighted the song you want to delete.
2. Press **XM** → **Edit Song** → **Delete** → **Yes**.
3. NeXus confirms the song is erased by displaying "Song Deleted."

SHORTCUT: To delete the song that you're currently listening to, press and hold the **XM** button, then select **Delete**.

To delete multiple songs from My Music:

1. Select **XM** → **Organize** → **Songs** → **All Songs**.
2. Use the up and down arrow buttons to highlight a song.
3. Press **XM** → **Select Song**. The song's name will be displayed in gray.
4. Use the up and down arrow buttons to highlight another song, and press the **XM** button to select that song. Do this for all the songs you want to remove.
5. Select **XM** → **Delete Song(s)** → **Yes**.
6. NeXus confirms that the songs are erased by displaying "Songs Deleted."

Using Your Player with a PC

System Requirements

The PC system must meet the following requirements:

- Intel® Pentium®-class CPU
- Microsoft Windows XP Home SP2, Windows XP Professional SP2, or Windows 2000 SP4 operating system*
- At least 64 MB of RAM
- At least 100 MB of available hard disk space
- Internet Explorer 5.1 or higher
- Windows Media Player 9 or higher; Windows Media Player 10 recommended for Windows XP
- Active Internet connection; we recommend a broadband (cable, DSL, or fiber) connection for optimal performance

*The following operating systems are not supported: Windows 95, Windows 98, Windows NT, Windows Me, Mac OS.

Using Your Player with a PC

Setup

To connect your NeXus to your PC:

1. If you haven't done so already, disconnect your NeXus and its cradle from your PC.
2. Insert the XM+Napster CD into your computer's CD or DVD drive.
3. The software should start automatically. You should see the following screen on your PC:



Click here to begin the installation.

Click here only if you need to install these individual components.

Click here when you're done with the installation procedure.

Follow the directions indicated on the screen. If you have any questions about the XM+Napster software, see the XM+Napster FAQs at <http://napster.xmradio.com>.

Using Your Player with a PC

4. Reboot your PC if necessary, then restart the XM+Napster program.
5. Set up NeXus as shown and plug the USB cable into the PC.

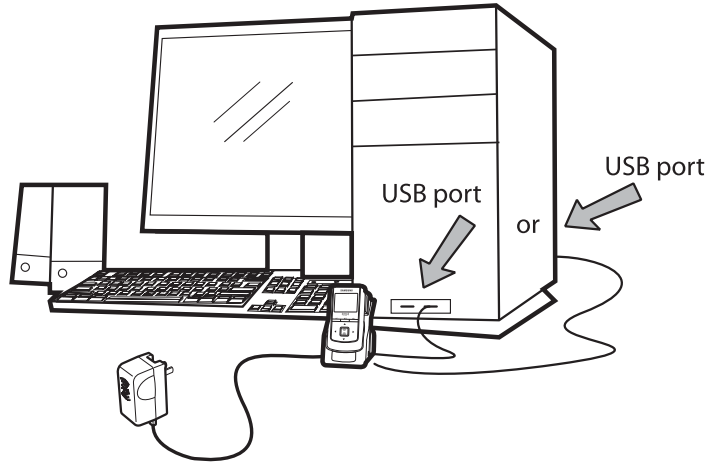

WARNING: Use only the USB supplied in the package. Other USB cables may not allow your NeXus to charge its battery or communicate with your PC.

Using Your Player with a PC

6. Your PC should recognize NeXus. Close any file folders that appear on your screen. You can manage the contents of NeXus entirely by using the XM+Napster program.
7. When taking your NeXus with you, you must disconnect NeXus from the PC by following the procedure described in "Disconnecting the Player from the PC" (page 55).

Using Your Player with a PC

Registering with XM+Napster

Choose either the XM+Napster Light service or the XM+Napster service. XM+Napster Light allows you to buy individual songs or albums whenever you want. XM+Napster lets you stream music to your PC for an additional monthly subscription.

	XM+Napster	XM+Napster Light
Manage XM content and MP3/WMA files on your NeXus	✓	✓
Transfer MP3/WMA files from your PC to your NeXus	✓	✓
Buy individual songs or albums to keep forever, burn to CD and transfer onto your NeXus player	✓	✓
Additional monthly subscription with XM+Napster required	✓	
Download and listen to all the Napster music you want on your PC	✓	
Listen to 70+ radio stations on your PC from XM Radio Online	✓	✓
Community and music discovery tools	✓	

Using Your Player with a PC

To register, follow these steps:

1. Click **File / Sign In** on the XM+Napster application. Click on the link for new members.
2. Follow the directions indicated on the registration display. You must have your active XM Radio ID and billing ZIP code to register.



Using Your Player with a PC

- If you choose XM+Napster, you must provide a valid credit card. Registering for XM+Napster Light does not require a credit card; you only need one when you purchase individual songs or albums. Simply select "Start XM+Napster Light" instead of entering your billing information.



For XM+Napster, enter your credit card information.

For XM+Napster Light, simply click here.

- The next time you use XM+Napster, sign in with your user name and password to access the XM+Napster service. You can also use the XM+Napster software off-line, without signing in, and still retain the ability to manage your NeXus.

Using Your Player with a PC

What Can You Do with XM+Napster?

Using XM+Napster, you can:

- Manage songs, playlists, and recording sessions on your Samsung NeXus
- Transfer MP3 and WMA files between NeXus and your PC
- Explore and purchase music from XM+Napster's enormous online store
- Listen to XM Radio Online

Exploring

Explore XM+Napster's online store and community, with over 1.5 million songs, 100,000 albums, and 80,000 artists.

Search by entering an artist name, song title, or album.



Drag and drop tracks or albums onto the "playlist/radio" pane to play them on your PC.

Using Your Player with a PC

Purchasing Music

The XM+Napster store allows you to stream, download, or buy songs or albums.

- Stream – Listen to a song while your PC is connected to the Internet.
- Download – Store music on your PC. You can listen to these songs anytime, even if your PC is off-line.
- Buy – Purchase the track or album. You can transfer these songs to your Samsung NeXus at any time.



“buy only” – Only available to buy or to sample a 30-second clip from XM+Napster

“download” – Available to buy, download, or stream from XM+Napster

Using Your Player with a PC

Organizing Your Music

The “Folder” pane lets you view the tracks stored on NeXus or on your PC, playlists, recording sessions, bookmarks, and more. Click on the desired folder to see its contents on the main pane.

View and manage all the XM content you recorded, WMA, and MP3 tracks on your NeXus and your PC.

Drag and drop tracks or albums onto the “playlist/radio” pane to play them on your PC.

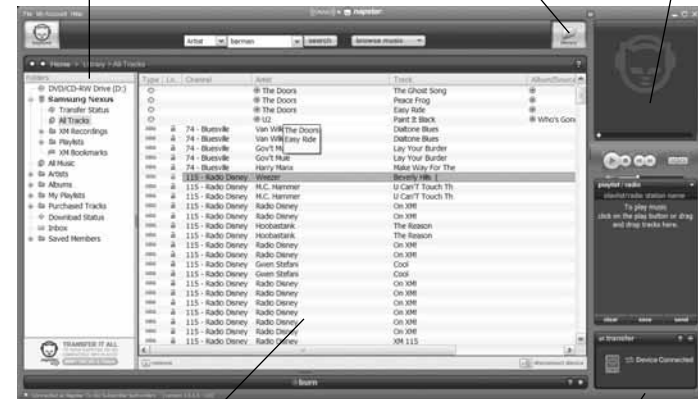

The main pane shows the contents of a folder.

Drag and drop purchased tracks onto the “transfer” pane to move them from your PC to your NeXus.

Using Your Player with a PC

Recording Sessions

View and edit your NeXus recording sessions by selecting **Library / NeXus / XM Recordings** on the XM+Napster application.

Create a new recording session or view an existing session.

Enter the options for the recording session.

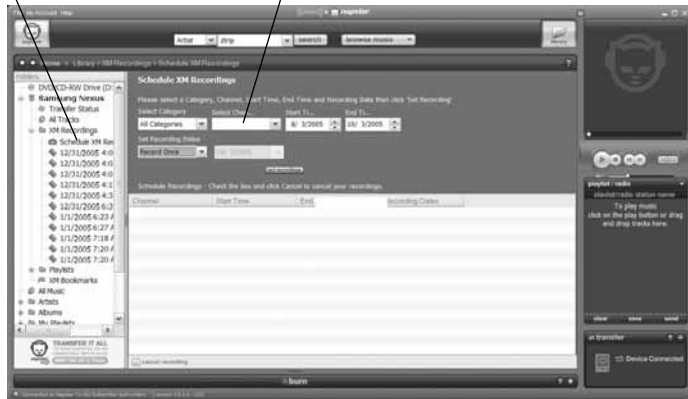

Using Your Player with a PC

Playlists

You can manage your NeXus playlists using XM+Napster. Simply dock your NeXus in its cradle, then select **Library / NeXus / Playlists**. You can create new playlists or edit or delete any playlists that are stored in your NeXus.

You can also create and manage playlists for any music content stored on your PC. Select **Library / My Playlists**.

To add a track to any playlist, select that track on the main pane and drag it to the playlist name in the "Folder" pane. Alternatively, right-click on the track name, then select the playlist you want to add the track to.

You can move a PC playlist onto your NeXus by dragging that playlist name into the **Library / NeXus / Playlists** line. When you move tracks and playlists onto your NeXus, you may have to purchase that content from XM+Napster, if you have not done so already.



Using Your Player with a PC

Transferring Between PC and NeXus



To transfer a track or playlist from your PC to your NeXus, drag and drop the track or playlist onto the "transfer" pane on the lower right-hand side of the XM+Napster application.

You can only transfer songs that you have purchased from XM+Napster or songs that you have ripped from your audio CDs.

Using Your Player with a PC

Disconnecting the Player from the PC

Before you remove your NeXus from its dock or unplug the USB cable from the dock or the PC, you must disconnect using one of the following methods:

- In Windows: right-click on the **Safely Remove Hardware** icon , which is on the right side of the Windows taskbar. Select "USB Mass Storage Device," and click on **Stop**.
- On XM+Napster: click on the **Disconnect Device** icon  **disconnect device** or select **File / Disconnect portable device**.

If you want to connect NeXus to your PC again, re-insert NeXus into its cradle.

Using Your Player with a PC

Listening to XM Radio Online (XMRO)

XM Radio Online gives you access to over 75 channels of the same amazing programming you hear on XM Satellite Radio, plus 10 select AOL Radio channels for even more choices.

To access XM Radio Online, click on **Home / Radio / XM Radio Online**. Then simply choose your desired channel from the channel list.

Save favorite channels in the preset buttons by dragging a channel onto the desired button. Note that these presets are not the same as the "Favorite Channels" on your NeXus.



You can enjoy XM Radio Online anywhere you have a PC and a high-speed connection. Remember that you cannot save or transfer XMRO programming onto your NeXus.

Using Your Player with a PC

Using Your CDs or MP3/WMA Files

Ripping Your CDs

Use the XM+Napster application to rip tracks from a CD into your Napster library.

1. Insert an audio CD into your PC's CD drive.
2. Click on **Library**, then click on the CD icon in the "Folders" pane. You will see a listing of the CD tracks in the main pane.
3. Click the **Rip** icon    on the bottom of the main pane. By default, the tracks will be encoded into the WMA format at 128 kbps. You can change this setting by clicking **File / Options / CD Options**.

Using Your Player with a PC

Importing Tracks into XM+Napster

If you already created MP3 or WMA files in your computer, you can import them into your Napster library.

1. Click **File / Import Tracks to My Library ...**
2. Follow the directions on the screen.

WARNING: Though you can transfer files other than MP3 or WMA types to your NeXus, those files cannot be played as audio files. Furthermore, do not attempt to format the NeXus storage; doing so may cause damage to the player.

Burning CDs

Transfer MP3 and WMA files onto a recordable CD or DVD. Please note that the content recorded from XM cannot be burned onto a CD or DVD or otherwise transferred off your NeXus.

1. Insert a recordable CD or DVD into your PC's CD/DVD drive.
2. Click **Library**.
3. Pull up the **Burn** screen at the bottom of the main pane.
4. Drag and drop tracks into the "Burn" pane.
5. When you've finished selecting tracks, click **Burn Disc**.

Updating NeXus Firmware

Occasionally we make improvements to the NeXus firmware, which is the software that makes your NeXus player work. Updating the firmware is a quick and easy process.

Remember that:

- Your NeXus must be docked in its cradle with a power adapter and must be connected to your PC
- Your PC must be connected to the Internet

Using XM+Napster

If you have installed and use XM+Napster, it automatically checks the firmware when you connect NeXus to your PC. XM+Napster notifies you when it's necessary to update the firmware. Simply follow the instructions.

Don't worry if you miss a firmware update. XM+Napster will always check whether your NeXus needs an update or not.

Updating NeXus Firmware



Using the Update Tool

If you don't use XM+Napster, you can update the NeXus firmware manually.

1. Insert the XM+Napster CD in your PC's CD-ROM or DVD drive. The XM+Napster software should start automatically.
2. Click on **Browse CD**.
3. Click on **Utils**, then click on **XM Firmware Update Client**.
4. Follow the instructions on the PC screen.

You can run this firmware update tool at any time. If the firmware needs to be updated, the tool will install it automatically. If the firmware is already up-to-date, nothing happens.

For more information, please see the XM+Napster FAQs at <http://napster.xmradio.com>.

Settings

Settings

FM Frequency

(requires car dock)

When listening to your NeXus through your vehicle's FM radio, set your NeXus player and the FM radio to the same frequency.

1. Find an unused FM frequency on your FM radio.
2. Select **XM** → **Settings** → **FM Frequency**.
3. Use the up and down arrow buttons to choose the proper frequency. You should hear XM programming over your FM radio when your NeXus and radio frequencies match.
4. Press the **XM** button to confirm your selection.

Aiming the Antenna

For optimal reception of XM's live satellite signal, your NeXus antenna should have an unobstructed view of the XM satellites in the southern sky. In large cities, XM also has a network of ground repeaters to help increase the signal coverage.

Your NeXus can help you aim the home antenna to pull in the strongest possible signal.

1. Press the **XM** button to display the menu.
2. Using the arrow and **XM** buttons, select **Settings** → **Setup** → **Antenna Aiming**.
3. Slowly turn and tilt the antenna. The signal bars on the display will change. Find the position that gives at least four bars on either "Satellite" or "Terrestrial."

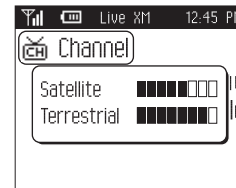

4. The antenna aiming screen remains as long as it's needed to help you position the antenna. When you've found the best position, press the left arrow button repeatedly to exit the **Settings** menu.
5. Select XM channel 1. You should be able to listen to the XM Preview Channel.

ENG

Settings

Settings

Audio

Tone

You can adjust the audio tone quality to suit the kind of music you're listening to.

1. Select **XM** → **Settings** → **Preferences** → **EQ Set**.
2. You will see a list of tone characteristics. Use the up, down, and **XM** buttons to select the one you prefer.
3. Press the **XM** button to confirm your selection.

Line Out Level/FM Audio Level

If you connect NeXus to another stereo system, you can adjust NeXus's audio level to match other audio sources. This is not a volume control; use the volume control on your stereo instead.

When your NeXus is plugged into the car cradle, the FM modulator turns on if you do not connect anything to the cradle's audio output. In that case, this level control sets the audio level being transmitted on FM.

1. Select **XM** → **Settings** → **Setup** → **Line Out Level (or FM Audio Level)**.
2. Use the left or right arrow buttons to decrease or increase the audio level.
3. Press the **XM** button to confirm your selection.

Display

Brightness & Contrast

To change the screen's brightness and contrast:

1. Select **XM** → **Settings** → **Preferences** → **Change Display** → **Brightness & Contrast**.
2. Press the up or down arrow buttons to select brightness or contrast.
3. Press the left or right arrow buttons to adjust each level.
4. Press the **XM** button to confirm your selection.

Backlight Timer

Your NeXus screen remains lit for a short time after you press a button. To adjust this time period:

1. Select **XM** → **Settings** → **Preferences** → **Change Display** → **Backlight Timer**.
2. Press the up and down arrow buttons to select the desired time period.
3. Press the **XM** button to confirm your selection.

Settings

Settings

Channel Access

Direct Tune

Normally, as you scroll through live XM channels, you can preview what's playing on each channel before you select it. The NeXus does not switch to that channel until you push the **XM** button. You can change this so that NeXus automatically tunes to the channel that you're previewing.

1. Select **XM** → **Settings** → **Preferences** → **Channel Access** → **Direct Tune**.
2. Select **Direct Tune On**.
3. Press the **XM** button to confirm your selection.

To return NeXus to its default behavior, select **Direct Tune Off**.

Channel Skip/Add

You can simplify the list of channels that you see when you press the up and down arrow buttons. To skip a channel:

1. Select **XM** → **Settings** → **Preferences** → **Channel Access** → **Channel Skip/Add**.
2. You will see a list of channels. Press the **XM** button to skip a channel. That channel will be displayed in reverse type.
3. To add a channel that has been skipped, highlight that channel, then press the **XM** button. The added channel name will be displayed in normal type.
4. Press the left arrow button to return to the **Channel Access** menu.
5. NeXus confirms by displaying "Channel List Updated."

You can still tune to a channel directly by using the virtual keypad to enter its channel number, or by selecting that channel if it's saved in a "Favorite Channels" list.

Channel skip/add should not be used as a form of parental control. To completely block access to an XM channel, contact XM Listener Care at 1-800-XM-RADIO (1-800-967-2346).

Time

1. In "Live XM," the time is automatically set using the XM signal. Otherwise, you can set the time by selecting **XM** → **Settings** → **Setup** → **Set Time** → **Set Clock** → **Set Date & Time**. Press the up and down arrow buttons to set the correct value for each field. Press the **XM** button to advance to the next field.
2. Select **XM** → **Settings** → **Setup** → **Set Time** → **Set Clock** → **Select Time Zone** to set the correct time zone for your location.
3. Your NeXus automatically adjusts for daylight-saving time. To turn this feature off, select **XM** → **Settings** → **Setup** → **Set Time** → **Set Clock** → **Automatic DST** → **No**.
4. To display time in 12- or 24-hour format, select the desired format through **XM** → **Settings** → **Setup** → **Set Time** → **Set Clock** → **12/24 Hour Mode**.

Sleep Timer

Your NeXus has a sleep timer that can automatically shut off the unit after a period of time.

1. Select **XM** → **Settings** → **Setup** → **Set Time** → **Sleep Timer**.
2. Select the desired time period.
3. Press the **XM** button to confirm the selection. Your NeXus will remember this setting the next time you turn on the player.

Settings

Memory Partition

The internal storage in NeXus can store recorded XM content and MP3/WMA files. By default, the storage is divided 50/50, but you can select different memory partitions:

device	setting	typical storage for content recorded from XM	typical storage for PC (MP3 and WMA) tracks
NeXus 25	50/50 XM/PC files	12.5 hours	4 hours
	100% XM	25 hours	0 hours
NeXus 50	50/50 XM/PC files	25 hours	8 hours
	100% XM	50 hours	0 hours

To change the memory partition:

1. Select **XM** → **Settings** → **Setup** → **Memory Partition**.
2. Highlight the desired setting and press the **XM** button.
3. Confirm by selecting **Yes**, or cancel by selecting **No**.

CAUTION: When you change the memory partition, you will erase all your stored XM content and MP3/WMA tracks from your NeXus player.

Settings

Restoring Factory Defaults

To restore all NeXus settings and preferences to a "factory fresh" state:

1. Select **XM** → **Settings** → **Setup** → **Restore Defaults**.
2. You should see this display:

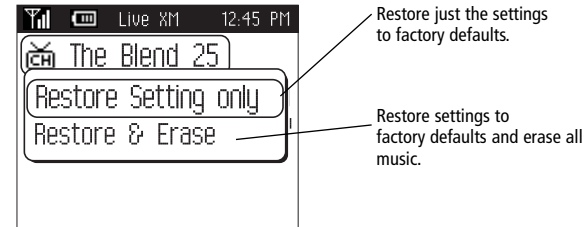

3. Confirm by pressing **Yes**, or cancel by selecting **No**.

Customer Support

Troubleshooting

If you see this on the display:	You should:
No Signal	Something is blocking the XM signal. Move your NeXus away from the obstructed area, e.g. an underground garage.
Check Antenna	Plug the antenna into the home or vehicle cradle. Make sure the antenna wire is not bent or broken.
Off Air	The channel you've selected is not currently broadcasting. Tune to another channel.
Loading	Your NeXus is acquiring audio or program information from the XM signal. This message should disappear in a few seconds in good signal conditions.
Updating	XM is updating your NeXus with the latest encryption code. Simply wait a few seconds until the update is done. – OR – You may be attempting to tune to a channel that is blocked or that you cannot receive with your subscription package. To receive that channel, contact XM Satellite Radio at 1-800-967-2346.
--- (no artist or title)	No program information such as artist name or song title exists.
Channel	You are attempting to tune to a channel that is not available.
Check XM C&P Passport	Check whether the XM Passport is inserted into the cradle. Also check the power connections to the cradle.
All Recording Features Not Available	Activate your XM subscription to enable you to store XM programming on your NeXus.
This Channel Not Available for Recording	Some programming cannot be recorded due to restrictions placed by the content owners.
This Program Not Available for Recording	Some programming cannot be recorded due to restrictions placed by the content owners.
Connect to XM Antenna Within ## Days to Avoid Interruption in Listening to XM Recordings	You must dock your NeXus in its cradle, with the XM Passport and antenna connected, and power it on for at least 8 hours a month. This authenticates your XM subscription and ensures that you can continue to enjoy your recorded XM content and live XM programming.
Please connect to XM Antenna to Confirm Valid Subscription	Dock your NeXus into its cradle, and connect the XM Passport and antenna.
Activation required for playback	Activate your XM subscription.

Customer Support

Troubleshooting

If this happens:	You should:
There is no power or your NeXus shuts off quickly.	Your NeXus battery may be low. Charge the battery by docking your NeXus in the cradle and plugging in the AC adapter.
NeXus shuts off unexpectedly.	Check whether you set the sleep timer, and set it to "Off" if desired. NeXus remembers the sleep timer setting even when you turn the player off.
You do not receive all the XM channels you have subscribed to.	Check that you have not skipped any channels (page 66). If you still do not receive all channels, your NeXus may not be activated. Contact XM Satellite Radio.
No audio.	Check all connections between your NeXus and your stereo system.
No song title or artist name is displayed.	Nothing is wrong with your NeXus. That information may be in the process of being updated. Some channels, such as news and sports, may not have such information.
No audio when listening to NeXus through an FM radio.	Check that your NeXus and your radio are tuned to the same FM frequency.
Audio fades or has static when listening through an FM radio.	You might be hearing interference from another FM station. Set your NeXus and your radio to a different FM frequency.
Audio sounds too soft or is distorted when listening to an FM radio.	Raise or lower the FM audio level until the sound quality improves.
XM Instant Traffic and Weather channels sound different from other channels.	Nothing is wrong with your NeXus. These channels use a different audio technology than the other XM channels.
Controls do not respond.	Check whether the power switch is in the "hold" position. If so, slide it to the center position to unlock the controls.
The controls still refuse to respond, the display does not change, or the backlight does not turn on or off.	Reset your NeXus by removing and re-inserting the battery.
Battery level meter doesn't match the expected charge or playback time.	Fully charge the battery, then use your NeXus until the battery is exhausted. This calibrates the battery level meter.
NeXus does not communicate with your PC.	Check the power and USB connections between the cradle and your PC. Be sure to use the supplied USB cable; any others may prevent your NeXus from charging or communicating properly with your PC. Remove your NeXus from its cradle, then re-insert.

Troubleshooting

If this happens:	You should:
Artist and song title information does not display correctly.	NeXus may not correctly show the artist and song information (ID3 tags) of certain foreign songs.
Cannot transfer songs that were downloaded with Napster To Go™ into NeXus.	NeXus is not compatible with Napster To Go's monthly subscription service. To transfer songs from your PC to your NeXus, you must purchase individual songs or albums from XM+Napster Light or XM+Napster.

Specifications

NeXus Player	
Dimensions	47 mm (W) x 86 mm (H) x 17 mm (D) 1.9 in (W) x 3.4 in (H) x 0.67 in (D)
Weight	130 g 4.4 oz
Storage capacity	Nexus 25: 512 MB Nexus 50: 1 GB
Music file formats	MP3 (64-320 kbps) WMA (64-192 kbps) WMA DRM (Secure WMA) XM content
Audio output	3.5 mm mini-stereo jack
Antenna connector (home and cradles)	RF SMB
Battery	Type: lithium polymer Voltage: 3.7 V Capacity: 1040 mAh
External power	Voltage: 5 V DC Current: 2000 mA Polarity: -  +

ENG

Customer Support

Specifications

Remote	
Dimensions	39 mm (W) x 95 mm (H) x 12 mm (D) 1.5 in (W) x 3.7 in (H) x 0.47 in (D)
Battery	Type: CR2032 Voltage: 3 V
Model Numbers	
NeXus 25 player	YP-X5X
NeXus 50 player	YP-X5Z
Remote	YA-RC200
Home cradle	YA-CD200
Car accessory kit	YA-CP200
Battery	990208
Earbuds	EP-360

Customer Support

Patent Information

Technology. It is prohibited to copy, decompile, disassemble, reverse engineer, hack, manipulate, or otherwise make available any technology incorporated in receivers compatible with the XM Satellite Radio System or that support the XM website, the Online Service or any of its content. Furthermore, the AMBE® voice compression software included in this product is protected by intellectual property rights including patent rights, copyrights, and trade secrets of Digital Voice Systems, Inc. You also agree not to upload, post, transmit or otherwise make available any material that contains software viruses or any other computer code, files, or programs designed to interrupt, disable, or limit the functionality of the XM website or the Online Service. Furthermore, the music, talk, news entertainment, data, and other content on the Services are protected by copyright and other intellectual property laws and all ownership rights remain with the respective content and data service providers. You are prohibited from any export of the data (or derivative thereof) except in compliance with applicable export laws, rules, and regulations. The user of this or any other software contained in an XM Radio or the XM website and all software used in connection with either is explicitly prohibited from attempting to copy, decompile, reverse engineer, or disassemble the object code, or in any other way convert the object code into human-readable form. The software is licensed solely for use within this product.

Customer Support

FCC Statement

This device complies with part 15 of the FCC Rules. Operation is subject to the following two conditions:

1. This device may not cause harmful interference, and
2. This device must accept any interference received, including interference that may cause undesired operation.

CAUTION: Any changes or modifications in construction of this device which are not expressly approved by the party responsible for compliance could void the user's authority to operate the equipment.

NOTE: This equipment has been tested and found to comply with the limits for a Class B digital device, pursuant to part 15 of the FCC Rules. These limits are designed to provide reasonable protection against harmful interference in a residential installation. This equipment generates, uses, and can radiate radio frequency energy and, if not installed and used in accordance with the instructions, may cause harmful interference to radio communications. However, there is no guarantee that interference will not occur in a particular installation.

If this equipment does cause harmful interference to radio or television reception, which can be determined by turning the equipment off and on, the user is encouraged to try to correct the interference by one or more of the following measures:

- Reorient or relocate the receiving antenna.
- Increase the separation between the equipment and receiver.
- Connect the equipment to an outlet on a circuit different from that to which the receiver is connected.
- Consult the dealer or an experienced radio/TV technician for help.

Customer Support

Warranty

Samsung warrants MP3 players as free of defects in material, design, and workmanship for a period of twelve (12) months from the original date of purchase. If during the period of warranty this product proves defective under normal use and service, you should return the product to the retailer from whom it was originally purchased. The liability of Samsung and its appointed maintenance company is limited to the cost of repair and/or replacement of the unit under warranty.

Return of the product for defective reasons should be to the original purchaser; however, Samsung Authorized Dealers and Authorized Service Centers will comply with the warranty on the terms issued to purchasers in the country concerned. **For further information relating to the Authorized Service Centers, contact 1-800-SAMSUNG (1-800-726-7864).**

Customer Support

Warranty Conditions

1. The warranty is only valid when the warranty card is properly completed, and upon presentation of the proof of purchase consisting of original invoice or sales slip confirmation, indicating the date of purchase, dealer's name, model, serial number, and product number. Samsung reserves the right to refuse warranty service if this information has been removed or changed after the original purchase of the product from the dealer.
2. Samsung's obligations are to the repair of the defective part, and at its discretion, replacement of the product (service exchange unit).
3. Warranty repairs must be carried out by an Authorized Samsung Dealer/Service Center. No reimbursement will be made for repairs carried out by non-Samsung Centers, and warranty coverage will not be valid for any repairs or damage caused by such repairs.
4. Repair or replacement under the terms of this warranty does not give right to extension to or a new starting of the period of warranty. Repair or direct replacement under the terms of this warranty may be fulfilled with functionally equivalent service exchange units.
5. The warranty is not applicable in cases other than defects in material, design, and workmanship. The warranty does not cover the following:
 - a. Periodic checks, maintenance, repair, and replacement of parts due to normal wear and tear.
 - b. Abuse or misuse, including but not solely limited to the failure to use this product for its normal purpose or in accordance with Samsung's instructions usage and maintenance.
 - c. Use of the product in conjunction with accessories not approved by Samsung for use with this product.
 - d. Failure of the product arising from incorrect installation or use not consistent with technical or safety standards in current force, or failure to comply with product manual instructions.

Customer Support

- e. Accidents, acts of God, or any cause beyond the control of Samsung caused by lightning, water, fire, public disturbances, and improper ventilation.
- f. Unauthorized modifications carried out for the product to comply with local or national technical standards in countries for which the Samsung product was not originally designed.
- g. Repairs performed by non-authorized service centers such as opening of the product by a non-authorized person.
- h. The model, serial number and product number on the product has been altered, deleted, removed, or made illegible.
6. This warranty does not affect the consumer's statutory rights nor the consumer's rights against the dealer from their purchase/sales agreement.