



IMPORTANT

The Proflame Transmitter is an integrated part of the Proflame System, which consists of these elements:

- Proflame Transmitter, to be used in conjunction with
- Integrated Fireplaces Control (Proflame IFC)

The Proflame Transmitter provides for controlling the following hearth appliance functions:

1. Main Burner On/Off
2. Main Burner flame modulation (6 levels)
3. Choice of standing or intermittent pilot (CP/WPI)
4. Thermostat and Smart thermostat functions
5. Accent light modulation (6 levels)
6. Split flow valve
7. On/Off relay
8. Comfort Fan speed modulation (6 levels)

The Proflame Transmitter uses a streamline design with a simple button layout and informative LCD display (Fig. 1). A Mode Key is provided to index between the features and a Thermostat Key is used to turn on/off or index through Thermostat functions (Fig. 1 & 2). Additionally, a Key Lock feature is provided (Fig. 23).

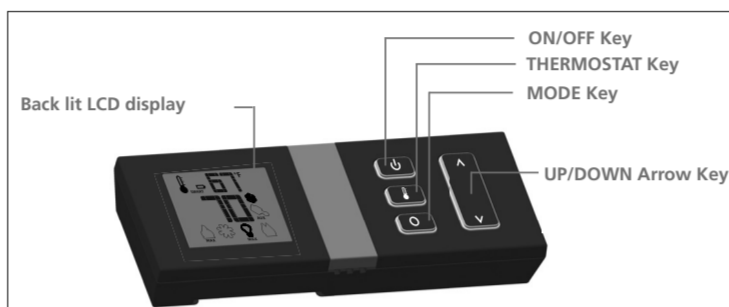

Fig. 1: Proflame Transmitter

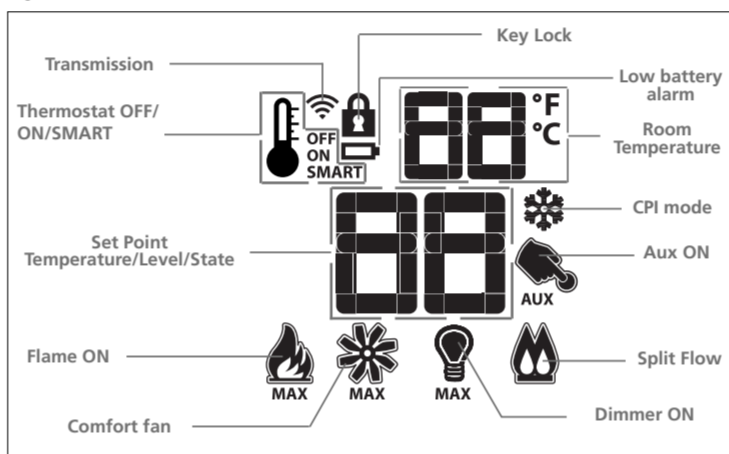

Fig. 2: Transmitter LCD display.

PROFLAME WALL MOUNT TRANSMITTER

USE AND INSTALLATION INSTRUCTIONS



Read the instructions before use.

OPERATING PROCEDURE

Initializing the System for the first time

Power the receiver. Activate the procedure of the receiver address programming, see the receiver instruction (*). The Receiver will "beep" three (3) times to indicate that it is ready to synchronize with a Transmitter. Install the 3 AAA type batteries in the Transmitter battery bay, located on the base of the Transmitter. (fig. 3) With the batteries already installed in the Transmitter, push the On button. The Receiver will "beep" four times to indicate the Transmitter's command is accepted and sets to the particular code of that Transmitter. The system is now initialized.

(* The receiver may be independent or integrated to the IFC hearth appliance control module. The receiver instruction may not be independent when part of the IFC.

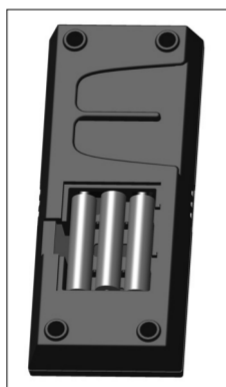

Fig. 3: Battery compartment.

Temperature indication Display

With the system in the "OFF" position, press the Thermostat Key and the Mode Key at the same time. Look at the LCD screen on the Transmitter to verify that a C or F is visible to the right of the Room Temperature display. (Fig. 4 and fig. 5)



Fig. 4: Remote Control display in Fahrenheit.

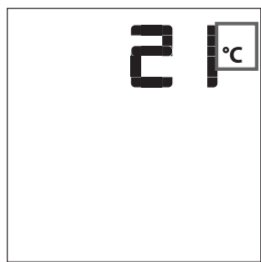

Fig. 5: Remote Control display in Celsius.

Turn on the Appliance

With the system OFF, press the ON/OFF Key on the Transmitter. The Transmitter display will show some other active icons on the screen. At the same time the Receiver will activate the appliance. A single "beep" from the Receiver will confirm reception of the command.

Turn off the Appliance

With the system ON, press the ON/OFF Key on the Transmitter. The Transmitter LCD display will only show the room temperature (Fig. 6). At the same time the Receiver will turn off the appliance. A single "beep" from the Receiver confirms reception of the command.

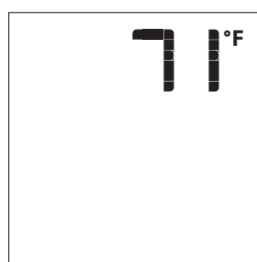

Fig. 6: Remote Control display.

Remote-Flame Control

The Proflame has six (6) flame levels. With the system on, and the flame level at the maximum in the appliance, pressing the Down Arrow Key once will reduce the flame height by one step until the flame is turned off. The Up Arrow Key will increase the flame height each time it is pressed. If the Up Arrow Key is pressed while the system is on but the flame is off, the flame will come on in the high position. (Fig. 7 & 8) A single "beep" will confirm reception of the command.

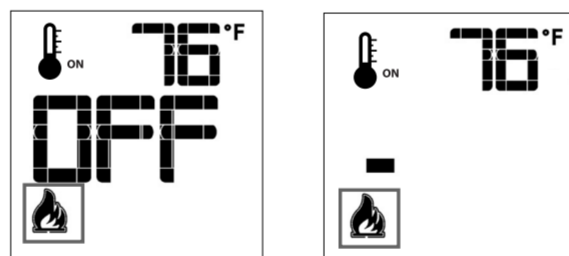

Fig. 7:

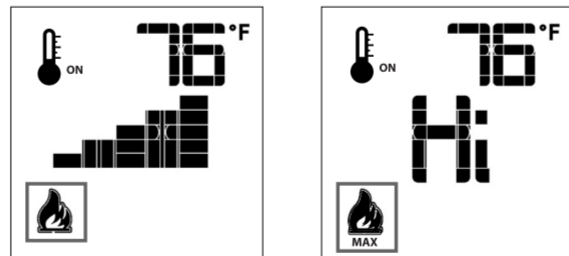

Fig. 8:

Room Thermostat (Transmitter Operation)

The Remote Control can operate as a room thermostat. The thermostat can be set to a desired temperature to control the comfort level in a room. To activate this function, press the Thermostat Key (Fig. 1). The LCD display on the Transmitter will change to show that the room thermostat is "ON" and the set temperature is now displayed (Fig. 9). To adjust the set temperature, press the Up or Down Arrow Keys until the desired set temperature is displayed on the LCD screen of the Transmitter.

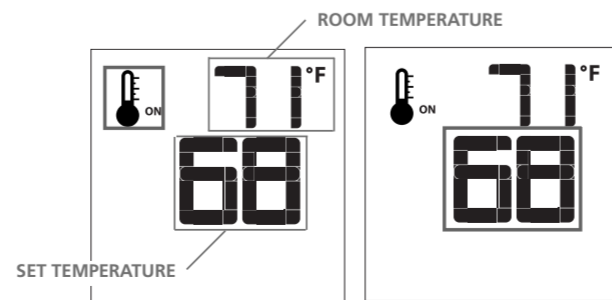

Fig. 9

Fig. 10

TECHNICAL DATA

Remote Control

Supply voltage	4.5 V (three AAA LR03 1.5 V batteries)
Ambient temperature ratings	0 - 50 °C (32 - 122 °F)
Typical operative distance in free air	12 m
Radio frequency	315 MHz (FCC version) 433.92 MHz (CE version)

WARNING

THE TRANSMITTER AND RECEIVER ARE RADIO FREQUENCY DEVICES. PLACING THE TRANSMITTER IN OR NEAR METAL MAY SEVERELY REDUCE THE SIGNAL RANGE.

METALLIC STRUCTURES OR RADIO INTERFERENCES CAN REDUCE THE OPERATIVE DISTANCE OF THE DEVICE DEPENDING ON TYPE OF FIREPLACE, INSTALLATION AND ENVIROMENT.

ATTENTION!

- TURN "OFF" THE MAIN GAS SUPPLY OF THE APPLIANCE DURING INSTALLATION OR MAINTENANCE OF THE RECEIVER DEVICE.
- TURN "OFF" MAIN GAS SUPPLY TO THE APPLIANCE PRIOR TO REMOVING OR REINSERTING THE BATTERIES.
- IN CASE OF REMOTE CONTROL MALFUNCTION TURN OFF THE IFC DEVICE USING THE "ON/OFF" MAIN SWITCH.
- FOR INSTALLATION/MAINTENANCE SWITCH OFF THE IFC DEVICE REMOVING MAIN POWER SUPPLY PLUG.
- THE DEVICE IS NOT SUITABLE FOR THE USE OF RECHARGABLE BATTERIES AND ITS OPERATIVE DISTANCE IS REDUCED WITH LOW BATTERY LEVEL.

WALL MOUNTING

The Proflame remote control is supplied with an adapter for wall mounting. Install the controller 1.5 m above floor level, well away from heat sources, kitchens, doors or windows. Metallic structures or radio interferences can reduce the operative distance of the device. Make sure to attach the adapter in a level plane without any distortion. Proceed as follow:

- Detach the adapter from the body of the remote control; see Fig. A.
- Position the adapter on the wall, mark the points for the fixing holes and drill the wall.
- Fix the adapter on the wall using the mounting hardware supplied with the remote control.
- Insert the remote control onto the adapter as shown in Fig. B.

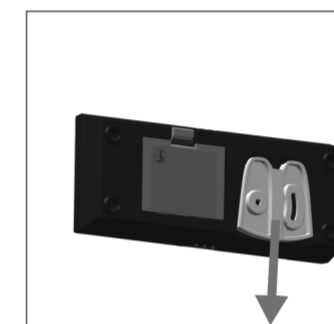

Fig. A: Detach the adapter from the body

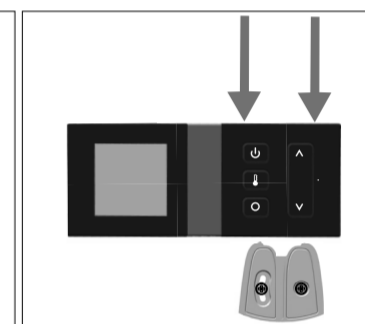

Fig. B: Adapter and remote control

Smart Thermostat (Transmitter Operation)

The Smart Thermostat function adjusts the flame height in accordance to the difference between the set point temperature and the actual room temperatures. As the room temperature gets closer to the set point the Smart Function will modulate the flame down. To activate this function, press the Thermostat Key (Fig. 1) until the word "SMART" appears to the right of the temperature bulb graphic (Fig. 11). To adjust the set temperature, press the Up or Down Arrow Keys until the desired set temperature is displayed on the LCD screen of the Transmitter (Fig. 12).

Note. When Smart Thermostat is activated, manual flame height adjustment is disabled.

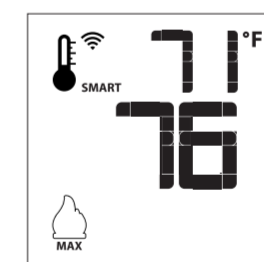

Fig. 11: Smart flame function

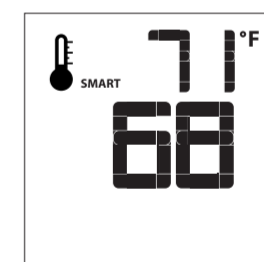

Fig. 12

Fan Speed Control

If the appliance is equipped with a hot air circulating fan, the speed of the fan can be controlled by the Proflame system. The fan speed can be adjusted through six (6) speeds. To activate this function use the Mode Key (Fig.1) to index to the fan control icon (Fig. 13). Use the Up/Down Arrow Keys (Fig.1) to turn on, off or adjust the fan speed (fig. 14). A single "beep" will confirm reception of the command.

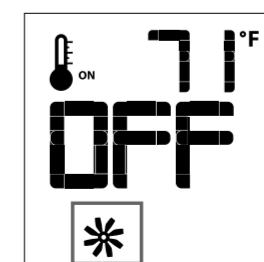

Fig. 13

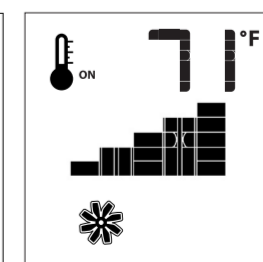

Fig. 14

Remote auxiliary relay control

The auxiliary function controls the AUX relay outlet. To activate this function use the Mode Key (fig. 1) to index to the AUX icon (fig. 15 & 16). Pressing the Up Arrow Key will activate the outlet. Pressing the Down Arrow Key will turn the outlet off. A single "beep" will confirm the reception of the command.

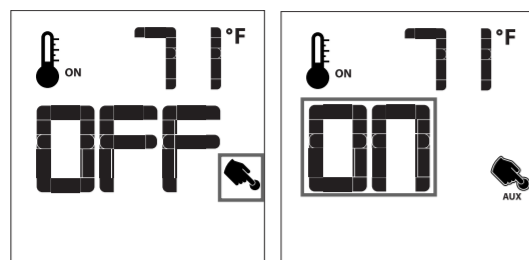

Fig. 15

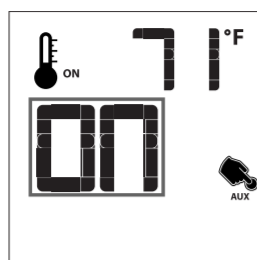

Fig. 16

Continuous Pilot/Intermittent Pilot (CPI/IPI) selection

With the system in "OFF" position press the Mode Key (fig. 1) to index to the CPI mode icon (fig. 17 & 18). Pressing the Up Arrow Key will activate the Continuous Pilot Ignition mode (CPI). Pressing the Down Arrow Key will return to IPI. A single "beep" will confirm the reception of the command.

NOTE: this function is available only with Proflame IFC.

NOTE: If the system is equipped with a CPI/IPI toggle switch:

- Set the CPI/IPI switch to CPI position (switch closed) to enable remote CPI/IPI operation.
- Set the CPI/IPI switch to IPI position (switch open) to disable remote CPI/IPI operation. The system will now work in IPI mode only regardless of the selection on the remote control hand set.

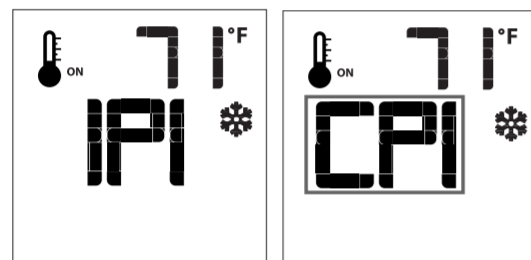

Fig. 17

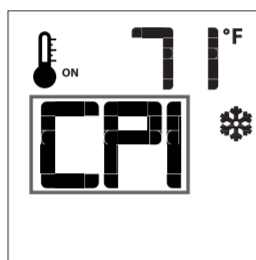

Fig. 18

Remote dimmer control (Light)

The dimmer function controls the Light power outlet by power light control. To activate this function use the Mode Key (fig. 1) to index to the Light icon (fig. 19 & 20). The intensity of the output can be adjusted through six (6) levels. Use the Up/Down Arrow Keys (Fig.1) adjust the output level (fig. 16). A single "beep" will confirm reception of the command.

Note. This function is available only with the Proflame IFC.

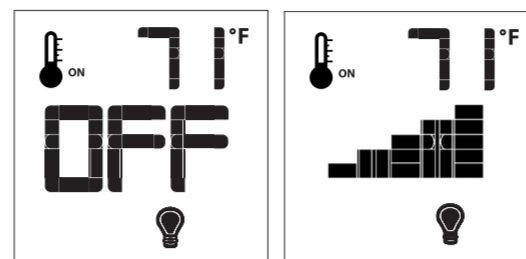

Fig. 19

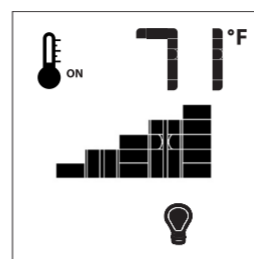

Fig. 20

Split Flow control

The secondary burner is controlled by the split Flow. To activate this function use the Mode Key (fig. 1) to index to the SPLIT FLOW mode icon (fig. 21 & 22). Pressing the Up Arrow Key will activate the secondary burner. Pressing the Down Arrow Key will turn the secondary burner off. A single "beep" will confirm the reception of the command.

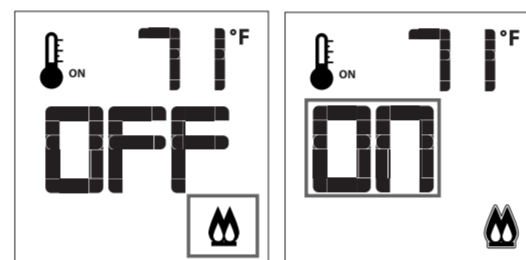

Fig. 21

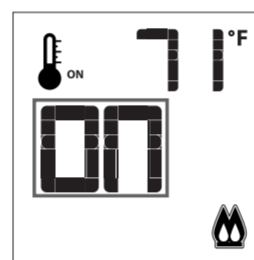

Fig. 22

KEY LOCK

This function will lock the keys to avoid unsupervised operation.

To activate this function, press the MODE and UP Keys at the same time (fig. 23).

To de-activate this function, press the MODE and UP Keys at the same time.

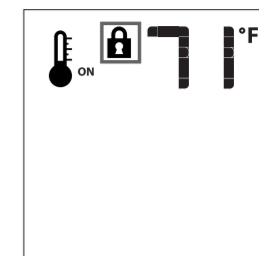

Fig. 23

LOW BATTERY POWER DETECTION

Transmitter

The life span of the remote control batteries depends on various factors: quality of the batteries used, the number of ignitions of the appliance, the number of changes to the room thermostat set point, etc.

When the Transmitter batteries are low, a Battery Icon will appear on the LCD display of the Transmitter (Fig. 24) before all battery power is lost. When the batteries are replaced this icon will disappear.

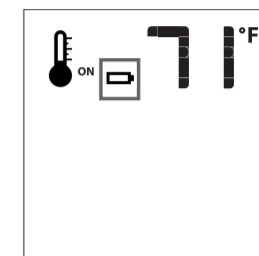

Fig. 24

7

8

9

FCC CONFORMITY (for 315MHz version only)

The "Proflame Wall Mount Transmitter" complies with the following requirements:
- FCC (Federal Communications Commission) Part 15

Operation is subject to the following two conditions:

- (1) This device may not cause harmful interference, and
- (2) This device must accept any interference received, including interference that may cause undesired operation.

Changes or modification not expressly approved by the party responsible for compliance could void the user's authority to operate the equipment.

FCC ID: T99058404300

WARNING

Fire Hazard. Can cause severe injury or death

The Transmitter causes ignition of the appliance. The appliance can turn on suddenly. Keep away from the appliance burner when operating the remote system.

DIMENSIONAL DRAWINGS

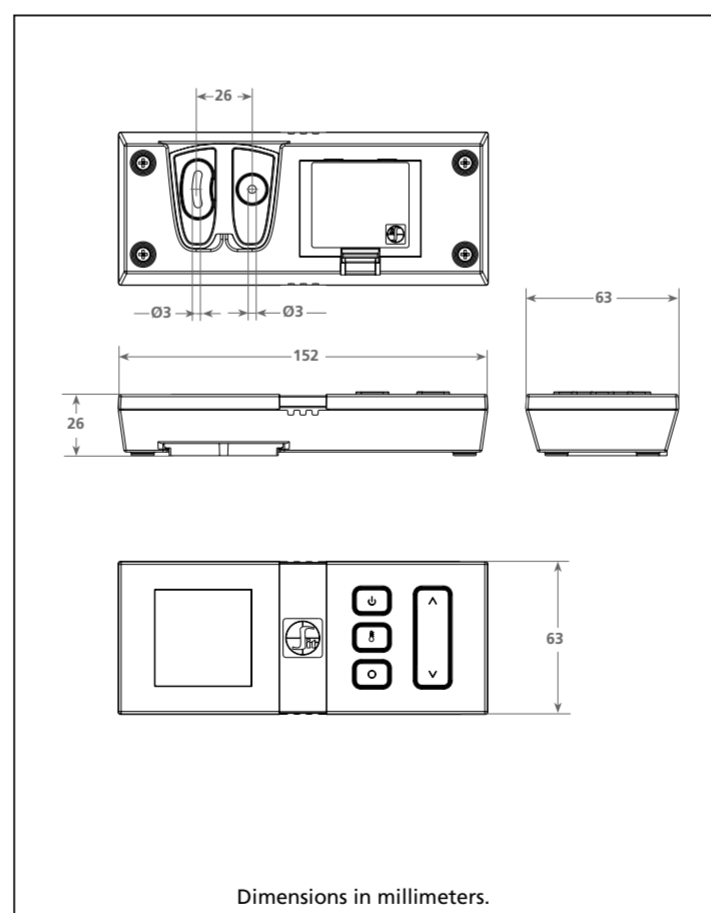

Fig. 24: PROFLAME Transmitter dimensional drawing

10

11