

User Manual

Mode: Elite 7.0L

Read me first

- ◆ Please read this manual before operating your tablet, and keep it for future reference.
- ◆ The descriptions in this manual are based on the default settings.
- ◆ Images and screen shots used in this manual may differ from the actual product.
- ◆ Available features and additional services may vary by device, software or service provider.
- ◆ Our company is not liable for performance issues caused by third-party applications.

CONTENTS

Assembling	1
Unpack	1
Charge the battery	1
Android 5.0 4G network setup	1
Install the SIM card	2
Install the memory card	2
Getting started	2
Turn your device on and off	2
Switch to flight mode	3
Device layout	3
Home screen	4
Task bar	4
Communication	5
Phone	5
Contacts	5
Messaging	6
Email	6
Gmail	7
Connectivity	8
USB Connection	8
Wi-Fi	8
Web	8
Browser	8
Play Store	9
Entertainment	10
Gallery	10
Music	10
Camera	10
Tools	11
Calendar	11
Clock	12
File Manager	12
Sound Recorder	12
Calculator	12
Care & Maintenance	13

Assembling

Unpack

Check your product box for the following items.

- Tablet
- User manual
- Adapter
- USB cable

You can purchase additional accessories from your local retailer.

Charge the battery

Before using the device for the first time, you must charge the battery.

1. You can charge the device with a travel adapter or by connecting the device to a PC with a USB cable.
2. Battery full icon is shown when finished if your device is off.

Warning: Use only original batteries and chargers. Unapproved chargers or cables can cause batteries to explode or damage your device.

Android 5.0 4G network setup

Android Tablets US 4G LTE Access Point Name(APN) Set Up			
AT&T APN Set Up		T-mobile APN Set Up	
Name	ATT Broadband	Name	T-Mobile US
APN	broadband	APN	fast.t-mobile.com
Proxy	Not set	Proxy	Not set
Port	Not set	Port	Not set
Username	Not set	Username	Not set
Password	Not set	Password	Not set
Server	Not set	Server	Not set

MMSC	Not set	MMSC	http://mms.msg.eng.t-mobile.com/mms/
MMS proxy	Not set	MMS proxy	Not set
MMS port	Not set	MMS port	Not set
MCC	310	MCC	310
MNC	410	MNC	260
Authentication Type	None	Authentication Type	None
APN type	default,mms,supl,hipri,fota	APN type	default,mms,supl,hipri,fota
APN protocol	Enabled	APN protocol	IPv4/IPv6
Bearer	Unspecified	Bearer	Unspecified

Install the SIM card

You need to insert a SIM card to use the Phone function when the tablet turning off. To install the SIM card, follow the instructions below.

1. Make sure that the card's gold contacts face into the device.
2. Push the SIM card into the slot until it clicks when it turning off.
3. The tablet have two card slots, they have the same communication function.

Install the memory card

To store additional multimedia files, you need insert a memory card when it turning off.

1. Insert a memory card with the gold contacts facing downwards.
2. Push the memory card into the slot until it clicks, when it turning off.

Notice: Our company uses approved industry standards for memory cards, but some brands may not be fully compatible with your device.

Getting started

Turn your device on and off

To turn on your device, press and hold the power key.

To turn off your device, press and hold the power key, and then tap **OK**.



Switch to flight mode

To use only your device's non-network services, switch to flight mode. Please follow the instructions below to turn on flight mode:

Tap **Settings** → **WIRELESS & NETWORKS** → **More** → **Airplane mode** → **Turn on/off**

Device layout



Icon	Function	Remark
	Power	Press and hold for 2 seconds to turn on or turn off the device.
	Lock	Press to lock the device.
RESET	Reset	Reset hole.
+ VOL -	Volume keys	Adjust the device volume.
	SIM Card	Inset the SIM Card, when the tablet turning off
	TF Card	Inset the Micro SD Card, when the tablet turning off

Home screen

The home screen has multiple panels. Scroll left or right to the panels on the home screen, you can view indicator icons, widgets, shortcuts to applications, and other items.

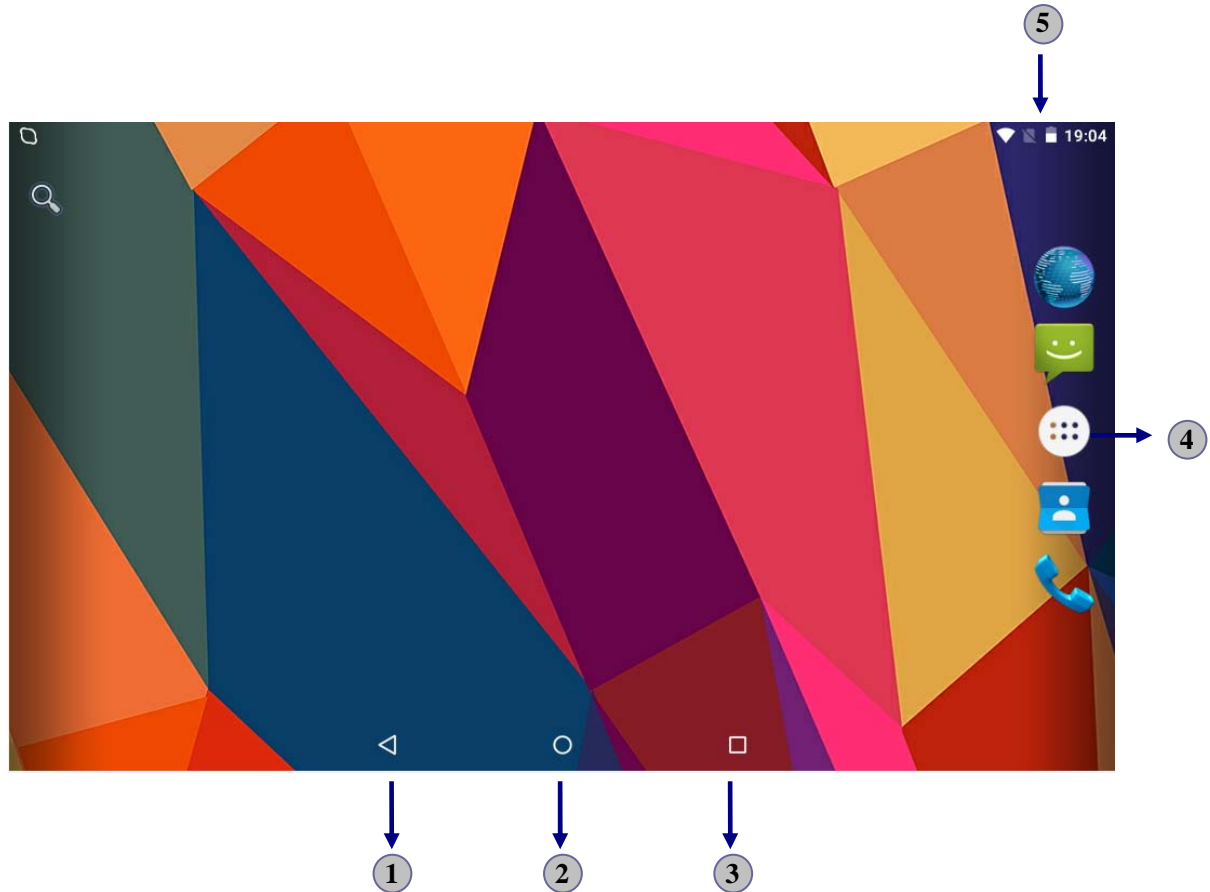

















Task bar

The task bar is shown at the bottom of the screen. It displays commonly used option buttons, battery level indicator, current time and other indicator icons.

1	Return to previous screen.
2	Return to home screen.
3	View the applications you have accessed recently.
4	Open application menu
5	Display notification icons. Tap the notifications area to open the notification panel.

Indicator icons



Icon	Definition	Icon	Definition
	Open Wi-Fi available		Flight mode activated
	Wi-Fi connected		New email
	Signal strength		New text or multimedia message
	Roaming mode		Call in progress
	Uploading data		Missed call
	Downloading data		Call on hold
	Connected to PC		Call diverting activated
	Alarm activated		Battery power level
	Music being played		

Communication

Phone

To use calling functions, tap **Phone** from application list.

◆ Make calls

Press  to show the dial numbers, and  to make the call.

◆ Ringtone & Vibrate

- You can set different ringtones for incoming calls. Select **Settings** → **Sound & notification** → **General** → **Phone ringtone** to open a list of ringtones, select the desired ringtone, and then select **OK** to confirm.
- Turn on **Vibrate** to create a checkmark and the tablet vibrates to notify you of incoming calls.

Contacts

Tap **Contacts** from application list to access contacts.

- **Favorites:** List the contacts that you have set as favorites or the contacts that you have sent message to or dialed.
- **All contacts:** List all your contacts saved in the device memory.



Messaging

Learn to create and send a text or multimedia message, and view or manage messages that you have sent or received.

◆ View messages

1. Tap **Messaging** from application list.
2. Tap the message to view the detailed information.

◆ Create and send SMS

1. Tap  to create a new message.
2. Tap  to add a phone number, or type phone numbers.
3. In **Type message**, enter the text of the message.
4. Select  to send the message.

Email

Before you can send or receive mail on your device, you need to set up an email account and define the email settings correctly. You can define more than 1 mailbox.

◆ Set up your email

1. Tap **Email** from application list.
2. You can use mailbox guide to set up your mailbox, tap **Next** until it's done.
3. If you need to add another email account, tap the option button at the upper right **Settings** → **Accounts** → **Add account**, then set up the email account with the mailbox guide.

When you are finished setting up the email account, the email messages are downloaded to your device. If you have created more than two accounts, you can switch between email accounts. Select an account name at the top left of the screen and select the one you want to retrieve messages from.

◆ Delete your email account

1. Open the application list and select **Email**.
2. Tap the option button at the upper right, then select **Settings** and the email account you want to delete.
3. Tap **Remove account**.

4. Tap **OK** to confirm.

◆ **Create and send email**

1. Open **Email** application.

2. Tap .

3. In **To** field, enter the recipient's email addresses manually and separate them with a comma. Add more recipients by tapping **Cc/Bcc**.

4. To insert attachments, tap the option button at the upper right and select **Attach file**.

5. Enter the subject and the text.

6. Tap **SEND** to send the email.

Gmail

You can retrieve new email messages from the Google Mail webmail service to your inbox.

Before you can send or receive mail on your device, you need to set up a Gmail account.

◆ **Create a Gmail account**

If you don't have a Google Account, tap **New**, then follow the on-screen instructions to create a new one.

◆ **Set up a Gmail account**

If you want to add an existing account, tap **Existing**, enter your email address and password, and then select **Next**, when you are finished setting up the email account, the email messages are downloaded to your device.

◆ **View email messages**

1. When you open the email account, the amount of unread email messages is displayed at the title bar and the unread email messages are displayed in bold.

2. To view an email message, tap it.

3. To mark an important email message, tap the star icon below the date. To cancel the mark, tap the star icon again.

◆ **Create and send an email**

1. Tap .

2. In **To** field, enter the recipient's email addresses manually and separate them with a comma. Add more recipients by tapping **Cc/Bcc**.

3. To insert attachments, tap the option button at the upper right and select **Attach file**.

4. Enter the subject and the text.
5. Tap **SEND** to send the email.

Connectivity

USB Connection

You can connect your device to a PC by a micro USB cable and use it as a removable disk, which allows you access the file directory.

Wi-Fi

With Wi-Fi, you can connect to the internet or other network devices anywhere an access point or wireless hotspot is available.

◆ Activate the Wi-Fi feature

1. Select **Settings** → **Wi-Fi**,
2. Turn on the **Wi-Fi** button, and select a network.

Web

Browser

Tap **Browser** from application list to access to the web.

◆ Browser webpages

1. Select **Browser** to launch a specified homepage.
2. To access a specific webpage, select the URL input field, enter the web address of the webpage, and select **Go**.
3. To zoom in, place two fingers on the screen and spread them apart. To zoom out, move your fingers closer together. You can also double-tap the screen.

◆ Add windows

You can have multiple windows open at one time.

1. To add a new window, tap  at the title bar.
2. To open up a window, tap the title of the window.

3. To close the window, tap  at the title bar.

◆ **Set homepage**

1. Tap the option button at the upper right.
2. Select **Settings**→**General**→**Set homepage**.
3. Enter the web address of the desired webpage.

◆ **Add bookmarks**

While navigating a website, tap  to add current URL to your bookmark list and easily access it later.

◆ **View bookmarks and history**

Tap  to open the bookmark list and the recent history. Tap a bookmark or any entry to display the webpage.

◆ **Customize browser**

To make adjustments in your browser settings, tap the option button at the upper right, and then select **Settings**.

Play Store

Play Store allows you to easily download an abundance of applications directly to your device. Before using the Play Store, you must have a Google Account.

1. From the application list, tap **Play Store**.
2. Sign in to your Google Account.
3. Search for and download applications as desired.
4. Follow the on-screen instructions.

Note

- All applications offered by Play Store are developed by third party. To get the information about the developers, you can read the descriptions of each application.
- Our company is not liable for performance issues caused by third-party applications.

Entertainment

Gallery

To view or organize your images and video clips, or edit and send your files to other devices, or set photos as wallpapers, select **Gallery** from application list.

Note: It takes a few more minutes to enter this application if you store more files.

◆ Supported file formats

Type	Format
Image	JPEG、 GIF、 BMP、 PNG
Video	MPEG4-SP, H264/AVC, H263, VPX, 3GP, 3G2, MP4, MKV, AVI, WEBM

Note: Some files may not play properly depending on how they are encoded.

◆ Play a video

1. Select a folder.
2. Select a video to play.
3. Control playback with the virtual keys.

Music



With Music, you can play music files. The music player supports the following file formats: MP3, AAC, APE, WMA, OGG, WAV, M4A and so on.

Note: Some files may not play properly depending on how they are encoded.

◆ Add music files to your device

Start by transferring files to your device or memory card.

◆ Play music

1. Select a music file.
2. Control playback with the virtual keys.
 -  The current list of songs are randomly shuffled for playback.
 -  Replays the current list when the list ends.
 -  Repeats the current playing song.







Camera

With the camera function, you can capture photos and take videos.



◆ Capture a photo

1. Open the application list and select **Camera**.

Place two fingers on the screen and spread them apart or move fingers closer together to zoom in or zoom out.

Icon	Definition
	Settings
	Change to video mode.
	take photos
	Tap to switch between the front and rear camera lenses
	Smile Mode
	Change to panorama mode to take a landscape photo.
	Adjust the color balance.

◆ Record a video



1. Open the application list and select **Camera**. Tap  to change to video mode.
2. Tap  to start recording. The length of the video recording is restricted by the available space on your storage.
3. Tap  to stop recording. The video is saved automatically to the folder DCIM.
4. After recording videos, select the image viewer icon at the upper right to view the recorded videos.

Tools

Calendar

With the Calendar feature, you can consult the calendar by day, week, or month, create events, and set an alarm to act as a reminder, if necessary.

To access the calendar, tap **Calendar** from application list.

1. To create an event, tap .
 - Fill in the fields, and set category, date, time & an alarm.
 - After you finish, select **DONE**.
2. You can view calendar in different views, Day, Week, Month and All.
3. To delete an entry, tap the event to open it, and then select  → **OK**.

Clock

From application list, tap **Clock**, and then select  to set alarm.



1. Tap  to add alarm.
 - Tap the numeric pad to set alarm time, and then select **AM** or **PM**, when you are finished, tap **OK**.
 - Tap the time to change alarm time.
2. Set alarm time, repeat cycle, and alarm ringtone, taps OK after finished.
3. Tap “cancel” to shut down the alarm, and tap” ring again” , then the alarm will stop ringing for a few minutes.
4. Untick the clock to stop using the clock.
5. Long taping the clock then it can be deleted.

File Manager

Many features of the device, such as images, videos, documents, received attachments and downloaded files or applications, use memory to store data. With **File manager**, you can store and browse files and folders in your device, or edit, move, copy files; you can send files to compatible devices as well.

Sound Recorder

With **Recorder**, you can record a voice memo. From application list, tap **Recorder**.

1. To record a voice memo, tap .
2. To pause the recording, tap .
3. To listen to a voice recording that you just recorded, tap .

Calculator

With this feature, you can use the device as a calculator. The calculator provides the basic arithmetic functions. Tap the virtual numeric and calculation keys to perform a calculation.

Care & Maintenance

- ◆ Use only manufacturer-approved accessories. Use general accessories may shorten the life of your device or cause device to malfunction.
- ◆ Keep your device dry. Humidity and all types of liquids may damage device parts or electronic circuits.
- ◆ Do not use or store the device in dusty, dirty areas.
- ◆ Do not store the device in hot or cold areas.
- ◆ Do not store your device near magnetic fields.
- ◆ Do not store your device with such metal objects as coins, keys and necklace.
- ◆ Do not drop your device or cause impacts to your device.

FCC RF Exposure Information and Statement

The SAR limit of USA (FCC) is 1.6 W/kg averaged over one gram of tissue. Device types 4G Tablet (FCC ID: 2ABOSSKYELITE70) has also been tested against this SAR limit. The highest reported SAR values for head, body-worn accessory, product specific (wireless router), and simultaneous transmission conditions are 0.34W/kg, 0.85W/kg, 1.12W/kg, and 1.12W/kg respectively. This device was tested for typical body-worn operations with the back of the handset kept 0mm from the body. To maintain compliance with FCC RF exposure requirements, use accessories that maintain a 0mm separation distance between the user's body and the back of the handset. The use of belt clips, holsters and similar accessories should not contain metallic components in its assembly. The use of accessories that do not satisfy these requirements may not comply with FCC RF exposure requirements, and should be avoided.

FCC Warning

This device complies with Part 15 of the FCC Rules. Operation is subject to the following two conditions:

(1) This device may not cause harmful interference, and (2) this device must accept any interference received, including interference that may cause undesired operation.

NOTE 1: This equipment has been tested and found to comply with the limits for a Class B digital device, pursuant to part 15 of the FCC Rules. These limits are designed to provide reasonable protection against harmful interference in a residential installation. This equipment generates, uses and can radiate radio frequency energy and, if not installed and used in accordance with the instructions, may cause harmful interference to radio communications. However, there is no guarantee that interference will not occur in a particular installation. If this equipment does cause harmful interference to radio or television reception, which can be determined by turning the equipment off and on, the user is encouraged to try to correct the interference by one or more of the following measures:

- Reorient or relocate the receiving antenna.
- Increase the separation between the equipment and receiver.
- Connect the equipment into an outlet on a circuit different from that to which the receiver is connected.
- Consult the dealer or an experienced radio/TV technician for help.

NOTE 2: Any changes or modifications to this unit not expressly approved by the party responsible for compliance could void the user's authority to operate the equipment.