

## STREAMING VIDEO DRONE

### POWERING UP AND PAIRING

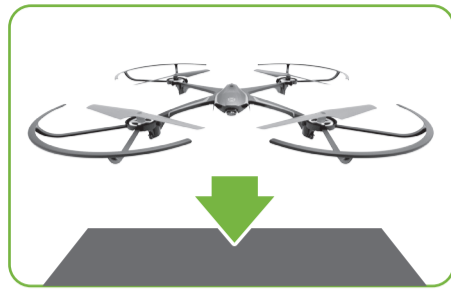

Insert fully charged LiPo battery into the underside of drone, then connect the battery to back of the drone. [See reverse.]



Place the drone on level surface for calibration.



Turn on controller. (Before initial use, install new batteries into controller. See reverse.)



Remove plastic film from lens before use. Once lights turn solid, drone is ready to fly.

### BASIC FLIGHT MANEUVERS

To make flying easier, place the drone on the ground in front of you with the drone facing away from you (green blades forward). You should be facing the same way the drone is facing.

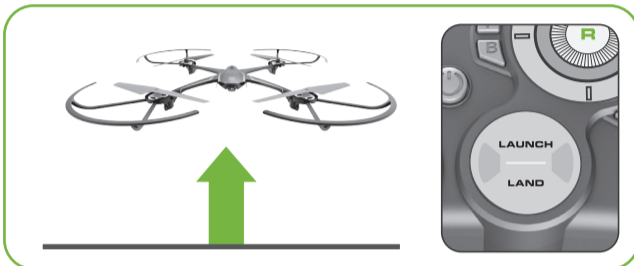

Press **LAUNCH** to automatically launch a few feet off the ground.

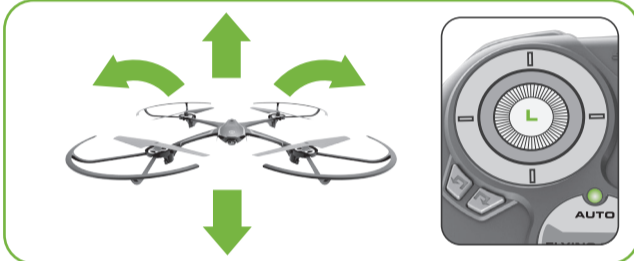

Move **LEFT (Throttle)** thumbstick up or down to make drone fly higher or lower and left or right to rotate.

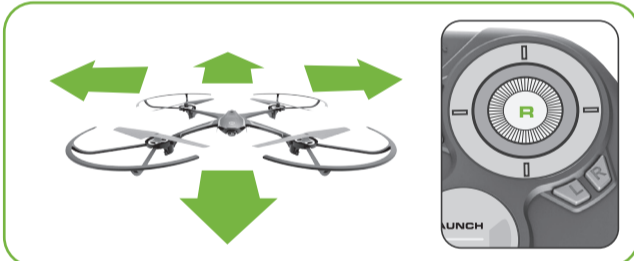

Use **RIGHT (Directional)** thumbstick to fly forward, backward, left or right.

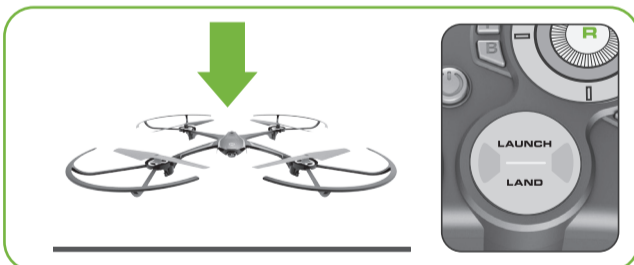

Press **LAND** to automatically land.

Alternatively you can use the left thumbstick to land the drone. Hold the left thumbstick all the way down for about 2.5 seconds after the drone has safely reached the ground, and the motors will stop spinning.

### AUTO AND MANUAL FLIGHT MODES

**AUTO** mode is best for new pilots. Begin by pressing the Launch button for takeoff. The drone will hold its altitude, and gradually fly up or down when you press up or down on the left thumbstick.

**MANUAL** mode is better for experienced pilots. When the left thumbstick is pushed all the way up the drone will spin its motors as fast as it can while maintaining stability, and when the left thumbstick is pushed all the way down the motors will stop spinning.



### FLIGHT CONTROLS

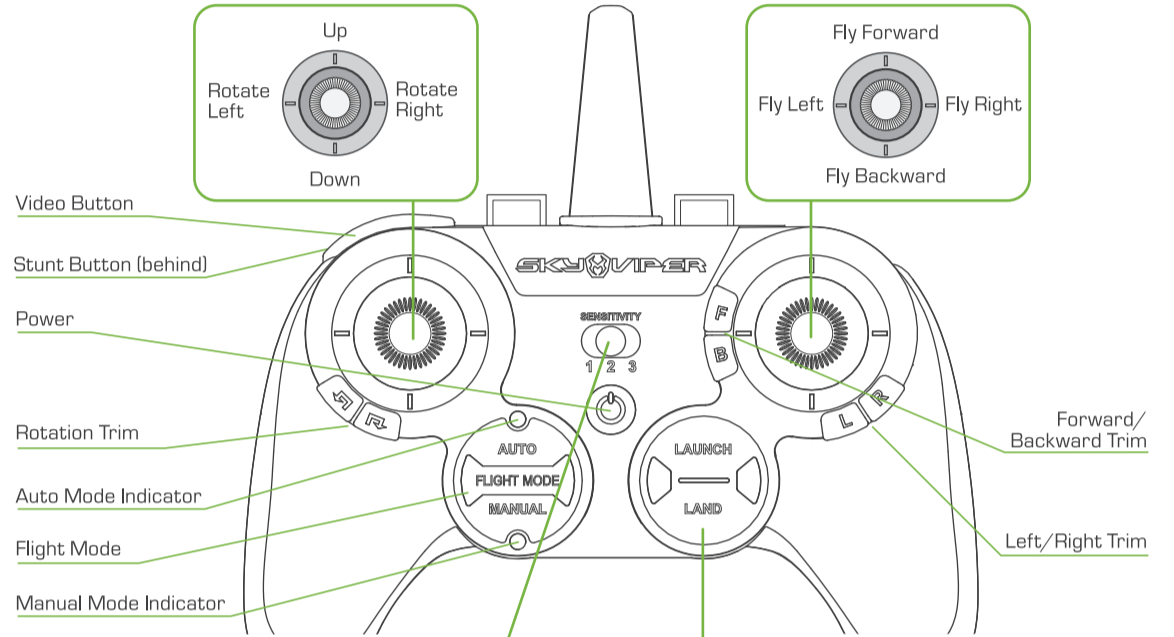

#### FLIGHT SENSITIVITY SWITCH



It is best to start with **LOW** sensitivity until you master flying.

• Reset drone WiFi password: Hold L Trim, R Trim and Power for 3 seconds. (Controller and drone must be paired)

• Reset controller to factory settings: Hold F Trim, B Trim, and Power for 3 seconds.

#### LAUNCH/LAND BUTTON

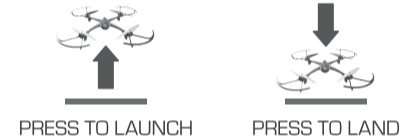

⚠ If for any reason you need to immediately stop the drone, hold down the stunt button (for drones that don't have a stunt button, use the video button) and move both thumbsticks down and away from the center of the controller.

### STREAMING AND RECORDING VIDEO

#### LIVE STREAMING AND RECORDING

Download the **SKY VIPER VIDEO VIEWER** app from the App Store or Google Play. Follow the instructions in the app to stream and/or record video and take photos.



#### RECORDING HIGHER QUALITY VIDEO TO MICRO SD CARD

(MICRO SD CARD SOLD SEPARATELY)

To record video in 720p insert Micro SD card (sold separately) into the back of drone. Follow the instructions in the app to toggle recording to your mobile device or your Micro SD card. Record directly to the Micro SD card without the app by using the button on the controller.



### ONE TOUCH STUNTS

#### BARREL ROLL LEFT OR RIGHT

While flying forward (or reverse), tap the **STUNT** button.

#### FLIP IN 4 DIRECTIONS

- 1 Bring the drone to a mid-air hover without flying in any direction. Remove finger from the **RIGHT** thumbstick.
- 2 While hovering, tap and hold the **STUNT** button.
- 3 Then quickly tap the **RIGHT** thumbstick in the direction you want the drone to flip.

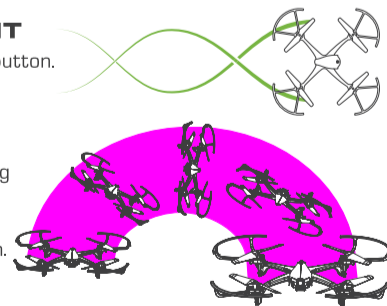

#### NOTE:

Once a stunt has been initiated, **DO NOT** adjust Throttle or press any other controls until the stunt has been completed.

#### CAUTION!

The drone should be flying at least 6 feet in the air with a minimum clearance of 6 feet in all directions before attempting stunt functions.

### REPLACING DAMAGED BLADES

Use the included screwdriver to unscrew the propeller, then pull up on propeller to detach. Match A propellers to A legs and B propellers to B legs when replacing. See image to right.

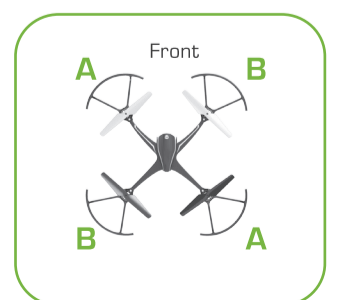
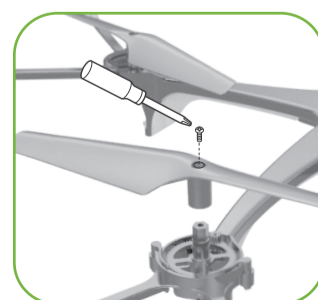

### STREAMING VIDEO DRONE

#### ADJUSTABLE CAMERA ANGLE

The drone camera angle is adjustable to suit your preference. Recommended position is pointing slightly downward.

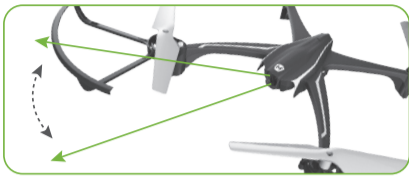

#### BATTERY UPGRADE

**Double your flying time with an additional battery!**

Details of how to purchase additional or replacement battery packs available at SKYVIPER.COM

#01739

#### CONTENTS

- Streaming Video Drone
- USB Charging Cable
- Rechargeable 3.7V 650 mAH LiPo Battery
- Controller
- Phone Mount
- 4 Replacement Blades
- 4 Blade Guards
- Screwdriver & Extra Screws
- 2 Pro Style Thumbsticks

#### SKY VIPER FLIGHT SIMULATOR

Learn and practice maneuvers on your phone, then apply your new skills in real life.



#### FAILSAFE GUIDE



When the drone turns upside down, the motors will stop spinning.



When the drone goes out of range of the controller, it will automatically land itself in its current position. If the controller comes back in to range before the drone lands, it is possible to cancel this automatic landing by pressing up on the throttle.



When the drone's battery is at 10% or less, the LEDs on the drone will begin to blink rapidly, and a tone is played continuously on the controller until the controller and drone are turned off.



When the drone's battery is depleted, the drone will automatically land itself in its current position. This automatic landing cannot be interrupted with the controller.

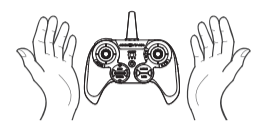

If the drone detects that no input has been received by the controller for 15 seconds, the drone will automatically land itself in its current position.

#### TRIM ADJUSTMENTS



**IF THE DRONE DRIFTS FORWARD:** Press "B" button several times until the drone stops drifting forward.

**IF THE DRONE DRIFTS BACKWARD:** Press "F" button several times until the drone stops drifting backward.



**IF THE DRONE DRIFTS LEFT:** Press "R" button several times until the drone stops drifting left.

**IF THE DRONE DRIFTS RIGHT:** Press "L" button several times until the drone stops drifting right.



**IF THE DRONE SPINS COUNTER-CLOCKWISE (VIEWED FROM ABOVE):** Press the button several times until the drone stops spinning.

**IF THE DRONE SPINS CLOCKWISE (VIEWED FROM ABOVE):** Press the button several times until the drone stops spinning.

#### TIPS:

**#1:** When the controller LED flashes 3 times quickly, the trim is at middle of trim range.

**#2:** If you are uncomfortable trimming the drone in flight, you can land onto a flat surface and make your trim adjustments.

**#3:** To reset trim adjustments, hold the button and the button down for 2 seconds.

#### CONTROLLER MODE SET-UP

When the controller is OFF, press and hold the flight mode button, LAUNCH/LAND button, and POWER button for three seconds to toggle between mode 1 and mode 2.

#### Mode 2 (default, most commonly used)

LEFT thumbstick makes the drone go up/down, and rotate clockwise/counter-clockwise. RIGHT thumbstick makes the drone fly forward, backward, left, and right.

#### Mode 1 (used in Australia and most Asian & European countries)

LEFT thumbstick makes the drone fly forward/backward, and rotate clockwise/counter-clockwise. RIGHT thumbstick makes the drone go up/down, and fly left and right.

#### INSTALLING BATTERIES IN THE CONTROLLER

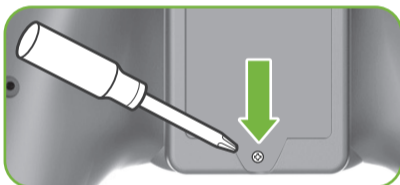

\*Screwdriver not included.

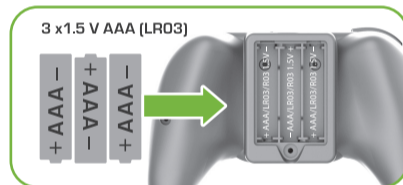

\*Batteries not included.

#### ADULT SUPERVISION REQUIRED

Before each use, an adult should check this product and the LiPo battery to ensure no damage or hazards exist. Drone has rotating blades that move at high speed, posing danger of damage and injury. Use of included blade guards strongly recommended. Pilots are responsible for any actions that result in damage or injury from the improper operation of drone. Adequate flying space is required. Avoid flying near interior fans and/or vents as they may make flying difficult to control. Keep a safe distance away from streets, public thoroughfares and power lines. Never attempt to retrieve drone from any location higher than your reach (such as rooftops or trees) or from any location that poses a safety hazard. Never fly drone at night. Keep drone in sight at all times during operation. Discontinue operation immediately if drone flies out of your field of view. Do not fly near spectators or animals. Keep spinning rotors away from fingers, hair, eyes and other body parts. Always launch from a flat surface. Never leave drone unattended while it is turned on. Read all enclosed information before operating.

#### CHARGING THE LIPO BATTERY

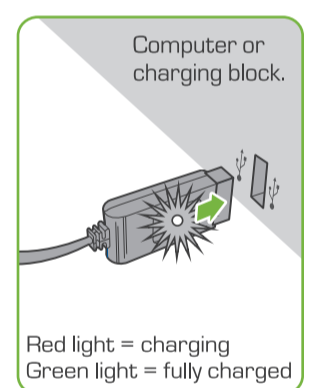
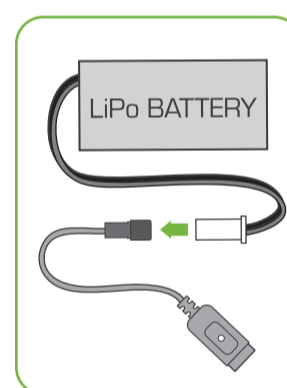

#### CHARGING PRECAUTIONS:

- After use, allow drone (battery on bottom) to cool down to room temperature before charging again.
- Charge battery in an isolated area, away from excessive heat or moisture.
- If you suspect that the battery is damaged or swelling, discard the battery in accordance with your country's recycling laws.
- Do not modify, heat, or wet the battery in any way. Only recharge with provided charger.

#### THIS PRODUCT CONTAINS A LITHIUM-POLYMER BATTERY 3.7V 650mAh:

LiPo batteries have a severe risk of fire and injury if they are improperly handled or misused. They may explode, overheat or ignite. Read all following precautions and instructions regarding the care and use of LiPo batteries.

The LiPo battery is only to be used with the drone and charger included with this product.

- Keep away from flammable materials.
- Do not expose to direct sunlight.
- Do not place in fire or leave in hot places.
- Do not drop or make subject to strong impact.
- Keep dry and away from water.
- Remove exhausted battery as soon as possible and discard properly.
- Remove battery from the compartment if toy is not used for a long period of time.
- The supply terminals are not to be short circuited.
- Never throw battery in a fire or attempt to open outer casing.
- Do not leave battery connected to drone when not in use.

LiPo Battery Disposal: LiPo batteries must be recycled or disposed of properly. They should not be disposed of with other household waste. Check your local laws and regulations for correct recycling and/or battery disposal.

#### AAA BATTERY CAUTIONS

- Do not use rechargeable batteries.
- Different types of batteries or new and old batteries are not to be mixed.
- Batteries are to be inserted using correct polarity.
- Remove exhausted batteries as soon as possible and discard properly.
- Remove all batteries from compartment if toy is not used for a long period of time.
- Never throw batteries in a fire or attempt to open the outer casing.
- Non-rechargeable batteries are not to be recharged.
- The supply terminals are not to be short circuited.
- Batteries should be replaced by an adult.

**WARNING:** Batteries are harmful if swallowed. Please keep away from children.

Battery Disposal: Dispose of batteries according to the local laws and regulations of your region. Some batteries may be recycled, and may be accepted for disposal at your local recycling center. If you are not able to identify the applicable rules in your area, please check the instructions of the battery manufacturer.

This device complies with PART 15 of the FCC Rules. Operation is subject to the following two conditions. (1) This device may not cause harmful interference, and (2) this device must accept any interference received, including interference that may cause undesired operation. CAUTION: Changes or modifications to this unit not expressly approved by the party responsible for compliance could void the user's authority to operate the equipment.

NOTE: This equipment has been tested and found to comply with the limits for a Class B digital device, pursuant to Part 15 of the FCC Rules. These limits are designed to provide reasonable protection against harmful interference in a residential installation. This equipment generates, uses and can radiate radio frequency energy and, if not installed and used in accordance with the instructions, may cause harmful interference to radio communications. However, there is no guarantee that interference will not occur in a particular installation. If this equipment does cause harmful interference to radio or television reception, which can be determined by turning the equipment off and on, the user is encouraged to try to correct the interference by one or more of the following measures: Reorient or relocate the receiving antenna - Increase the separation between the equipment and receiver - Connect the equipment into an outlet on a circuit different from that to which the receiver is connected - Consult the dealer or an experienced radio/TV technician for help.

This equipment complies with FCC radiation exposure limits set forth for an uncontrolled environment. This transmitter must not be co-located or operating in conjunction with any other antenna or transmitter.

For Drone: This equipment should be installed and operated with minimum distance 20cm between the radiator & your body.

When you use Spiderman Remote on hand, please keep 20cm from your body.

Remove all packaging attachments before giving the toy to a child.

Not suitable for children under 3 years due to small parts that could be swallowed.

Conforms to product safety standards ASTM F963.

Keep instructions for future reference. Do not discard.



©2017 Skyrocket Toys LLC, Los Angeles CA 90066 USA. All Rights Reserved. Sky Viper and Skyrocket and their respective logos are trademarks and/or registered trademarks of Skyrocket Toys LLC. All other trademarks, logos and copyrights are the property of their respective owners, and there is no relationship express or implied with Skyrocket Toys LLC.

MADE IN CHINA.

SKYROCKET

Google Play and the Google Play logo are trademarks of Google Inc.

Apple and the Apple logo are trademarks of Apple Inc., registered in the U.S. and other countries. App Store is a service mark of Apple Inc., registered in the U.S. and other countries.

The software included in this product contains copyrighted software that is licensed under the GPLv3. A copy of that license is included in our website at the URL below. You may obtain the complete Corresponding Source code from us for a period of three years after our last shipment of this product and/or spare parts therefor, which will be no earlier than 05-01-2020, on our website at <http://www.skyrockettoys.com/GPL/>

**WE'RE HERE TO HELP**  
For questions about this product:

Online: [skyviper.com/support](http://skyviper.com/support)

Email: [support@skyrockettoys.com](mailto:support@skyrockettoys.com)

Phone: 1-888-674-5650  
M-F 9am to 6pm PST

## ISED RSS warning

This device complies with ISED licence-exempt RSS standard (s). Operation is subject to the following two conditions: (1) this device may not cause interference, and (2) this device must accept any interference, including interference that may cause undesired operation of the device.

Under ISED regulations, this radio transmitter may only operate using an antenna of a type and maximum (or lesser) gain approved for the transmitter by ISED. To reduce potential radio interference to other users, the antenna type and its gain should be so chosen that, the equivalent isotropically radiated power (e.i.r.p.) is not more than that necessary for successful communication.

### ISED Radiation Exposure Statement:

This equipment complies with ISED RF radiation exposure limits set forth for an uncontrolled environment. This transmitter must not be co-located or operating in conjunction with any other antenna or transmitter.

For Quadcopter: This equipment should be installed and operated with minimum distance 20cm between the radiator & your body.

When you use Spiderman Remote on hand, please keep 20cm from your body.

Le présent appareil est conforme aux CNR d'ISED applicables aux appareils radio exempts de licence.

L'exploitation est autorisée aux deux conditions suivantes:

- (1) l'appareil ne doit pas produire de brouillage, et
- (2) l'utilisateur de l'appareil doit accepter tout brouillage radioélectrique subi, même si le brouillage est susceptible d'en compromettre le fonctionnement.

Conformément à la réglementation ISED, le présent émetteur radio peut fonctionner avec une antenne d'un type et d'un gain maximal (ou inférieur) approuvé pour l'émetteur par ISED. Dans le but de réduire les risques de brouillage radioélectrique à l'intention des autres utilisateurs, il faut choisir le type d'antenne et son gain de sorte que la puissance isotrope rayonnée équivalente (p.i.r.e.) ne dépasse pas l'intensité nécessaire à l'établissement d'une communication satisfaisante.

ISEDexposition aux radiations:

Cet équipement est conforme avec ISED les limites d'exposition aux rayonnements définies pour un contrôlé environnement.

Cet émetteur ne doit pas être co-localisés ou fonctionner en conjonction avec une autre antenne ou émetteur.

Cet équipement doit être installé et utilisé avec un minimum de 20cm de distance entre le radiateur et votre corps.

Lorsque vous utilisez Spiderman Remote en main, gardez 20 cm de votre corps.