

1. Download and Install the Smart Drone App

App Name: SMD Smart Drone

IOS mobile device please download "SMD Smart Drone" from App Store;

Android mobile device please search "SMD Smart Drone" from Google Play to download the App. Or you can download it from our website: www.smd-uav.com.

2. Check Battery Levels

- Press and hold the Power Button once either on your Intelligent Flight Battery or Remote Controller to display the battery level.
- Be sure to fully charge both batteries before your first flight.
- Press and hold the Power Button for 2 seconds to start the Remote Controller (Repeat to turn off the Remote Controller).
- Press and hold the Power Button for 3 seconds to start the Intelligent Flight Battery (Repeat to turn off the Intelligent Flight Battery).



3. Charging the Batteries

- Only use the official Smart Drone charger. Remove the Intelligent Flight Battery from the aircraft before charging.
- Connect the charger to a suitable power source (100~240 V, 50/60 Hz).
- Both intelligent flight battery and the remote controller can be charged either the power button turns on /off, but it is recommended that you should turn off the power button before charging.
- If to charge the remote controller with the power button turning on, the status indicator LED is the same with the one when it is in normal working status.
- If to charge the remote controller with the power button turning off, the status indicator LED is as the figure 1 shown.
- If to charge the intelligent flight battery with power button turning off, the battery level indicator LED is as the figure 2 shown.

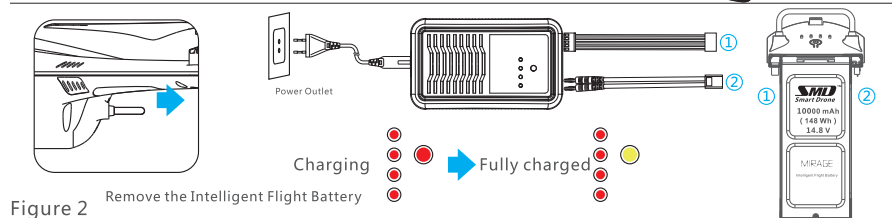
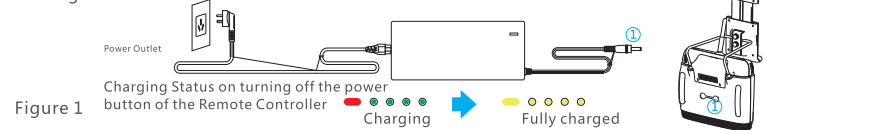
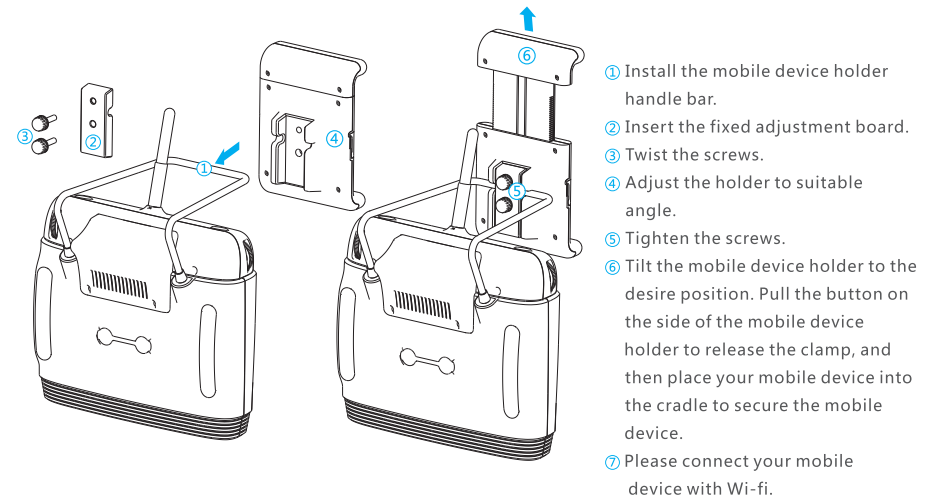

Figure 2

© 2016 Designed by SMD

4. Connecting Your Mobile Device



⚠ To avoid signal interference, please do not use other 2.4GHz devices when flying.

5. Remote Controller (Mode 2)

Moving the left stick up and down changes the aircraft's elevation. Push the stick up to ascend and down to descend.

Moving the left stick to the left or right controls the rudder and rotation of the aircraft.

Moving the right stick up and down changes the aircraft's forward and backward pitch.

Moving the right stick control left and right changes the aircraft's left and right pitch.

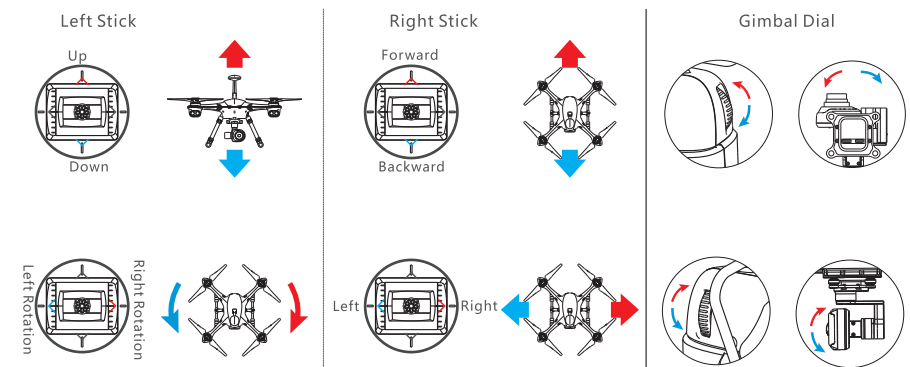

©2016 Designed by SMD

6. Ready (Prepare) to Fly

Place the aircraft in an open, flat area with battery level indicators facing towards you. Please make sure the GPS support is well engaged before your flight. You will hear a slight locking voice when the GPS support is locked correctly.

- Toggle the Flight Mode Switch to center position (Center position is GPS Mode; Up is Obstacle Avoidance Mode; Down is Altitude Mode).
- Turn on the remote controller power (Press and hold for 2 seconds).
- Please keep the aircraft in an open, flat area before you turn on the intelligent flight battery (Press and hold for 3 seconds to turn on the battery), and then the gimbal is turning on and Self Diagnostic Testing. Please do not move the aircraft during this time period.
- Make sure the remote controller and the aircraft is connected properly (the remote controller status indicator is in solid green).
- Turn on the power button of camera, the status indicator will flash alternatively in blue and red. Please wait for camera for the Self Diagnostic Testing until the blue indicator turn off, the red indicator is solid red. And then the camera Self Diagnostic Testing is finished.
- Now open the mobile device WIFI, search the WiFi of Radio Controller, choose the WiFi name of "SMD-5G-AP*****". Let's launch the "SMD Smart Drone" APP and tap the "START" icon enter into the camera interface.
- Wait for a successful connection.

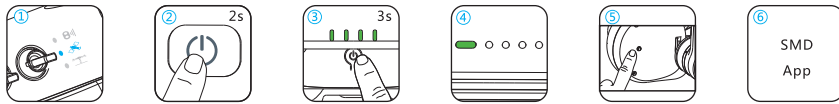
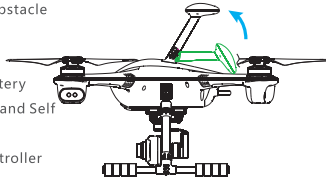

Calibrating the Compass When the aircraft is in lock status, please toggle the flight mode switch in rapid succession 6 times (within 3 seconds) to enter into the calibration mode. When the blue light is turning on, hold the aircraft horizontally and rotate (clockwise) 360 degrees. The Aircraft Status Indicators will display a solid green light. Hold the aircraft vertically, with nose pointing downward, and rotate (clockwise) it 360 degrees around the center axis until the front LEDs display a solid red and the Aircraft Status Indicators yellow flash twice (Altitude Mode) or Green flash twice (GPS Mode) or Yellow flash single (Obstacle avoidance Mode). Then the calibration is finished and put the aircraft on a flat, open ground.

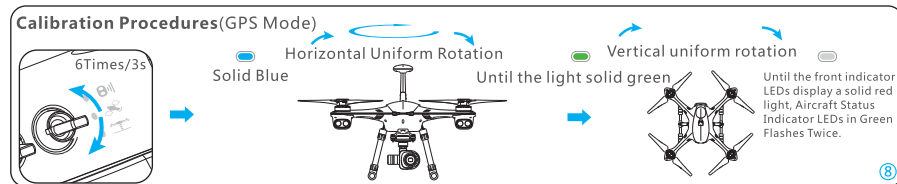

Compass Calibration Attention

Please do the Compass Calibration before your flight, otherwise it may cause the system not to work correctly and then it will affect the flight safety.

- Do not calibrate your compass where there is any possibility of sources of potential interference include magnetite, parking structures, and subterranean metal structures, strong magnetic interference.
- Do not carry ferromagnetic materials with you during calibration such as keys or cellular phones.
- Different place have different magnetite. Always calibrate the compass in every new flight location although you already calibrate the compass in different location. In order to avoid poor flight performance or flight failure.
- If the calibrate failure, the Aircraft Status Indicator solid red, then recalibrate. If the calibrate success, And then put the aircraft on flat surface, the Aircraft indicator blinks red and yellow, it show the subterranean may have metal etc. to affect compass, move your aircraft to a different location and try again.

- Confirm that the aircraft has been properly installed battery; make sure the camera Micro-SD card is installed.
- Smart mode: Turn on TOF intelligent obstacle avoidance function, if the GPS signal strength meets the requirements, then turn on GPS positioning, if the GPS signal strength does not meet the targeting requirements, provides only altitude and obstacle avoidance function.
- Point mode: If the GPS signal strength meets the requirements, then turn on GPS positioning, if the GPS signal strength does not meet the targeting requirements, provides only altitude function.
- Altitude mode: Only provides attitude stability augmentation, and control the altitude.

7. Flight

- One key Unlock (Lock)/Take off/Return to Home/Landing

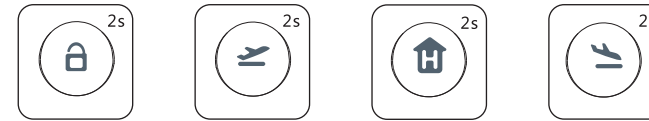

- Press and hold the Unlock key 2 seconds, the propeller will spin in low speed.
- Press and hold the "One key to start" for 2 seconds, the aircraft will take off automatically. The Aircraft will be hovering in 3 meters height and meanwhile the landing gear will be put up automatically.
- Press and hold the "One key go home" for 2 seconds, the aircraft will go home automatically.
- Press and hold the "One key landing" for 2 seconds, the aircraft will start to land to the place where it is located.

- One key to Start, One Key Go Home, One Key to Landing only is valid under the GPS Mode with GPS signals is not less than 10 stars.
- Please Press and hold the "One Key to Unlock" for 2 seconds to unlock the Aircraft before you start the "One key to Take off".
- Before the one key operation is finished, if you would like to control the Aircraft manually, please toggle the flight mode stick to switch the flight mode and then you can control the Aircraft.

- Manual Take off /Landing

Take off:

Press and hold Unlock button for 2s to start the motor, once the motors spun up, they will idle. Then push the throttle up gently, the aircraft will start to take off.

Landing:

When landing, pull the throttle stick to the lowest position slowly, the motors will enter into idling. Then press and hold the "Luck button" for 2s to lock the motor.

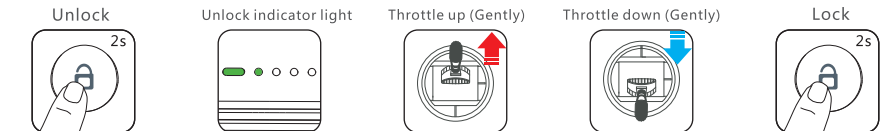

- Please do not stop the motors when the aircraft in the mid air, otherwise it will crash. If there is some emergence situation (i.e. the Aircraft fly into the crowds), then please stop the motor immediately to reduce the damage to minimum
- Critical Battery Warning, the aircraft can not to fly.
- Start aircraft motors, the propeller will high speed spin, having dangerous. Operator should keep a safety distance. Meanwhile, control the aircraft avoid crowds, structures, trees, and other obstacles, just in case crash.
- After landing, please turn off the power of Camera first, and then turn off the power of the

Go Home

Intelligent Go Home:

Press and hold the Go Home key for 2s to activate Intelligent Go Home system, the aircraft will automatically return to the Home Point. Back height can be set by APP, if the current height is below the set height, the aircraft will climb up to the set height then return, if the current height is above the set height, the aircraft will keep the current height and flying back.



8. Turn off the power

Please turn the camera off before turning off the aircraft power (If not turn the camera off may damage the camera).

Intelligent Low Battery Return To Home :

The aircraft will automatic landing when reach critical low battery warn.

Failsafe Return To Home

When the remote controller single lost, the aircraft will automatically return to home.

- The Return-to-Home process may be interrupted and the operator may regain control of the aircraft if the remote controller signal connection is re-established.

Appendix

Aircraft status indicator LED

Mode status indicator LED

- X2... Yellow lights flash twice, Attitude Mode
- X2... Green lights flash twice, GPS Mode
- ... Yellow lights single flash, Obstacle Avoidance Mode
- ... Green and Red Alternate Blinks, GPS signal is not sufficient
- Fast Blue Flashing, Detected Obstacles
- Fast Green Flashing, One Key to Start/Landing/Go Home

Calibration Status Indicator LED

- ... Red, Green, Blue alternate flash, aircraft self diagnostic testing
- Solid Blue/Green, Calibration the electronic compass

System status indicator LED

- Solid Red, Critical Error(Not Fly)
- ... Slow Red Flashing, 1 Level Low Battery Warning
- Fast Red Flashing, 2 Level Low Battery Warning
- Fast Yellow Flashing, Disconnect Remote Controller

Remote controller status indicator LED

- Green Flashing, The Remote Controller is Disconnected from The Aircraft
- Solid Green, The Remote Controller is Connected to The Aircraft
- Solid Red, Critical Low Remote Controller Battery
- Status Indicator LED/Battery Level LEDs

Intelligent Flight Battery Safety Guidelines

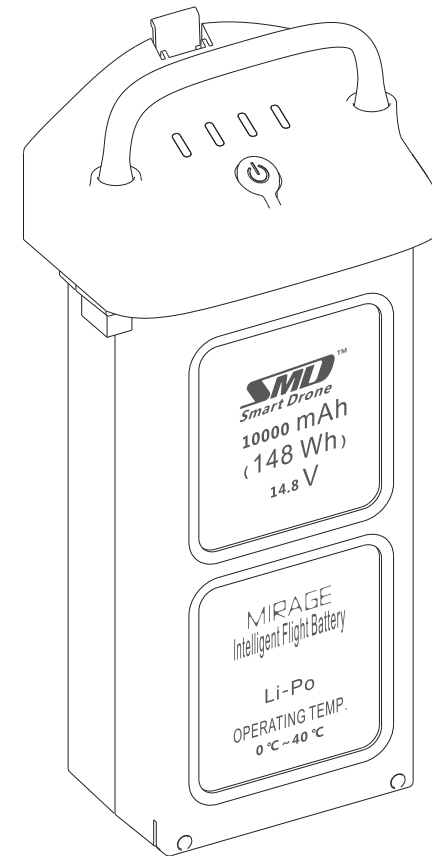

*** CAUTION**
RISK OF EXPLOSION IF BATTERY IS REPLACED
BY AN INCORRECT TYPE.
DISPOSE OF USED BATTERIES ACCORDING
TO THE INSTRUCTIONS.

Glossary

The following terms are used throughout the product literature to indicate various levels of potential harm when operating this product:

NOTICE Procedures, which if not properly followed, create a possibility of physical property damage and a little or no possibility of injury.

WARNING Procedures, which if not properly followed, create the probability of property damage, collateral damage, and serious injury OR create a high probability of superficial injury.

WARNING

The product is not intended for use by below 15 years old without direct adult supervision. This is a sophisticated product. It must be operated with caution and common sense and requires some basic mechanical ability. Failure to operate this product in a safe and responsible manner could result in injury or damage to the product or other property. Do not use with incompatible components or alter this product in any way outside of the documents provided by Shenzhen Smart Drone UAV Co., Ltd.. It is essential to read and follow all of the instructions and warnings in the Mirage user manual, prior to assembly, setup or use, in order to operate the product correctly and avoid damage or serious injury. User install, using, SMD believe that User already read and understand SMD all products explain and safety warm.

Intelligent Flight Battery Safety Guidelines

To avoid fire, serious injury, and property damage, observe the following safety guidelines when using, charging, or storing your batteries.

WARNING Battery Charging

- Warn Do NOT attach the batteries to wall outlets directly, and always use a SMD approved adapter. SMD takes no responsibility if the battery is charged using a non-SMD charger. Never leave the battery unattended during charging.
- DO NOT charge the battery near flammable materials or on flammable surfaces such as carpet or wood.
- DO NOT charge the battery immediately after flight, because the battery temperature may be too high. DO NOT charge the battery until it cools down to near temperature, Charging the Battery outside of the temperature range of 0°C -40°C may lead to leakage, overheating, or battery damage.
- Disconnect the charger when not in use. Examine the charger regularly for damage to the cord, plug, enclosure, or other parts. Do NOT clean the charger with denatured alcohol or other flammable solvents. Never use a damaged charger.

NOTICE

The Intelligent Flight Battery is designed to stop charging when it is full. However it is a good practice to monitor the charging progress and disconnect the batteries when fully charged.

Battery Use

WARNING DO NOT allow the batteries to come into contact with any kind of liquid. DO NOT leave batteries out in the rain or near a source of moisture. Do NOT drop the battery into water. If the inside of the battery comes into contact with water, chemical decomposition may occur, potentially resulting in the battery catching on fire and may even lead to an explosion.

- Never use non-SMD batteries. Go to www.smd-uav.com to purchase new batteries. SMD takes no responsibility for any damage caused by non-SMD batteries.
- Never use or charge swollen, leaky, or damaged batteries. If your batteries are abnormal, contact SMD or a SMD authorized dealer for further assistance. Never install or remove the battery from the aircraft when it is turned on. Do NOT insert or remove batteries if the plastic cover has been torn or compromised in any way.
- The battery should be used in temperatures from -10°C to 40°C. Use of the battery in environments above 50°C can lead to a fire or explosion. Use of battery below -10°C can lead to permanent damage.
- Do NOT use the battery in strong electrostatic or electromagnetic environments. Otherwise, the battery control board may malfunction and cause a serious accident during flight.
- Never disassemble or pierce the battery in any way or the battery may leak, catch fire, or explode.
- Electrolytes in the battery are highly corrosive. If any electrolytes make contact with your skin or eyes, immediately wash the affected area with fresh running water for at least 15 minutes, and then see a doctor immediately.
- Check the condition of the battery if it falls out of the aircraft. Make sure the battery is NOT damaged or leaking before putting it back into the aircraft.
- If the battery falls into water with the aircraft during flight, take it out immediately and put it in a safe and open area. Maintain a safe distance from the battery until it is completely dry. Never use the battery again, and dispose of the battery properly as described in the Battery Disposal section below. Do NOT hear batteries. Put out any battery fire using sand or a dry powder fire extinguisher. Never use water to put out a battery fire.
- Do NOT put batteries in a microwave oven or in a pressurized container.
- Do NOT place loose battery cells on any conductive surface, such as a metal table.
- Do NOT put the loose cells in a pocket, bag or drawer where they may short-circuit against other items or where the battery terminals could be pressed against each other.
- Do NOT drop or strike batteries. Do NOT place heavy objects on the batteries or charger. Avoid dropping batteries.
- Clean battery terminals with a clean, dry cloth.
- Battery does not use for a long time, to be separately stored in a cool dry place, and supplement charge about per month.

NOTICE

- Make sure the batteries are fully charged before each flight.
- It is recommended that you do NOT charge the Intelligent Flight Battery and remote controller at the same time.
- If the aircraft enters the low battery level warning Mode, should stop flying and landing it as soon as possible, replace the battery or charge the battery.

Battery Storage and Shipping

⚠ WARNING

Keep batteries out of the reach of children and pets.

- Do NOT leave the battery near heat sources such as a furnace or heater. Do NOT leave the batteries inside of a vehicle on hot days. The ideal storage temperature is 22°C ~ 28°C.
- Keep the battery dry. Never drop the battery into water.
- Do NOT drop, strike, impale, or manually short-circuit the battery.
- Keep the battery away from metal objects such as glasses, watches, jewelry, and hairpins.

⚠ NOTICE

Discharge the battery to 40-65% if it will NOT be used for 10 days or more. This can greatly extend battery life.

- The battery automatically discharges to below 65% when it is idle for more than 10 days to prevent it from swelling. It takes approximately 2 days to discharge the battery to 65%. It is normal that you may feel moderate heat emitting from the battery during the discharge process. Set the discharging thresholds in the Smart Drone App.

⚠ WARNING

Note for the Smart Battery boarding.

Before take the battery to flight, be sure to discharge the battery to less than 5%. Be sure to stay away from fire before discharge.

⚠ NOTICE

Store Intelligent Flight Batteries in a ventilated location.

⚠ WARNING

Battery Maintenance

- Never use the battery when the temperature is too high or too low.
- Never store the battery in environments with a temperature higher than 60°C.

⚠ NOTICE

- Never over-discharge, as this may lead to battery cell damage.
- Battery life may be reduced if not used for a long time.
- Charge and discharge battery per 3 months to keep battery active.

Battery Disposal

⚠ WARNING

- If the power on/off button on the intelligent flight battery is disabled and the battery cannot be fully discharged, please contact a professional battery disposal /recycling agent for further assistance.

⚠ NOTICE

- If the power on/off button on the intelligent flight battery is disabled and the battery cannot be fully discharged, please contact a professional battery disposal /recycling agent for further assistance.

In the Box

Check that all of the following items are in your package. If any items are missing, please contact SMD or your local Dealer

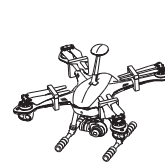

Aircraft Body×1



Remote Controller×1



Propeller pairs×4



Intelligent Battery×1

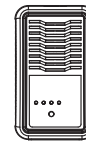

Intelligent Battery Charge×1



Power Cable×1



Xt60 Extension Cable×1

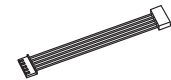

5PIN Flexible Printed Circuit×1



Remote Controller Charge×1

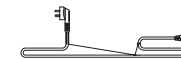

Power Cable×1

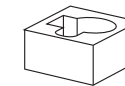

Gimbal Clamp foam×1



Gimbal Rivet X2



Micro-SD Card (16GB) ×1



Vibration Absorbers×4



L-type wrench×1



Quick Start Guide×1

Hereby, Shenzhen Smart Drone UAV Co., Ltd., declares that this Mirage is in compliance with the essential requirements and other relevant provisions of Directive 2014/53/EU.

Warning: Changes or modifications to this unit not expressly approved by the party responsible for compliance could void the user's authority to operate the equipment.

NOTE: This equipment has been tested and found to comply with the limits for a Class B digital device, pursuant to Part 15 of the FCC Rules. These limits are designed to provide reasonable protection against harmful interference in a residential installation. This equipment generates, uses and can radiate radio frequency energy and, if not installed and used in accordance with the instructions, may cause harmful interference to radio communications.

However, there is no guarantee that interference will not occur in a particular installation. If this equipment does cause harmful interference to radio or television reception, which can be determined by turning the equipment off and on, the user is encouraged to try to correct the interference by one or more of the following measures:

- Reorient or relocate the receiving antenna.
- Increase the separation between the equipment and receiver.
- Connect the equipment into an outlet on a circuit different from that to which the receiver is connected.
- Consult the dealer or an experienced radio/TV technician for help.

"This device complies with FCC and IC radiation exposure limits set forth for general population (uncontrolled exposure)."

"The device must not be co-located or operating in conjunction with any other antenna or transmitter."

High power radars are allocated as primary users of the 5 GHz bands. These radar stations can cause interference with and/or damage this device. No configuration controls are provided for this wireless equipment allowing any change in the frequency of operations outside the FCC grant of authorization for US operation according to Part 15.407 of the FCC rules.