



User Manual

Contents

Precautions before Use.....	2
Tablet introduction	3
Introduction to Desktop	4
1. Windows 10 start image:.....	4
2. Image slide applications.....	4
3. Introduction to app Interface.....	5
4. Start Menu.....	7
5. Multitasking operating interface	8
Basic Operations	9
1. Sleep, restart and power off.....	9
2. WIFI function;.....	9
3. Bluetooth function;	10

Introduction

Thank you for your choosing the new Tablet PC.

This guide serves to enable users to get to know and familiar with our product as soon as possible. Here we have made a brief introduction to the key layout and definitions in figures and words.

Precautions before Use

1. This production is suitable for use in non-tropic areas below 2,000 meters, and the mark  in the nameplate indicates the product is suitable for use in non-tropic areas.
2. Prevent the Tablet PC from falling to the ground or being strongly impacted otherwise.
3. Do not use it in the long term in any environment where the air is too cold, too hot (<math><35^{\circ}\text{C}</math>), too humid or with too much dust. Do not expose the Tablet PC to sunlight.
4. Avoid using it in the strong magnetic and strong static environment as much as possible.
5. Once any water or other liquid splashes onto the Tablet PC, close it immediately and do not use it until it dries out.
6. Do not clean the Tablet PC with any detergent containing chemical element or other liquid to avoid causing damage due to corrosion and becoming damp. If cleaning is really necessary, clean it with dry soft cloth tissue paper.
7. Our company shall not bear any and all responsibilities for loss or deletion of material inside the machine caused due to abnormal software and hardware operation, maintenance or any other accident.
8. Please back up your important material at any time to avoid loss.

Tablet

9. Please do not disassemble the Tablet PC by yourself; otherwise you will lose the right to warranty.

10. This product supports the overwhelming majority of mainstream brands of 3G DONGLE network cards. The cases for 3G Dongle may be different. It is suggested that you test it to make sure it is OK before buying it.

11. Replacement with incorrect type batteries may cause explosion. Make sure to use original batteries.

Tablet introduction

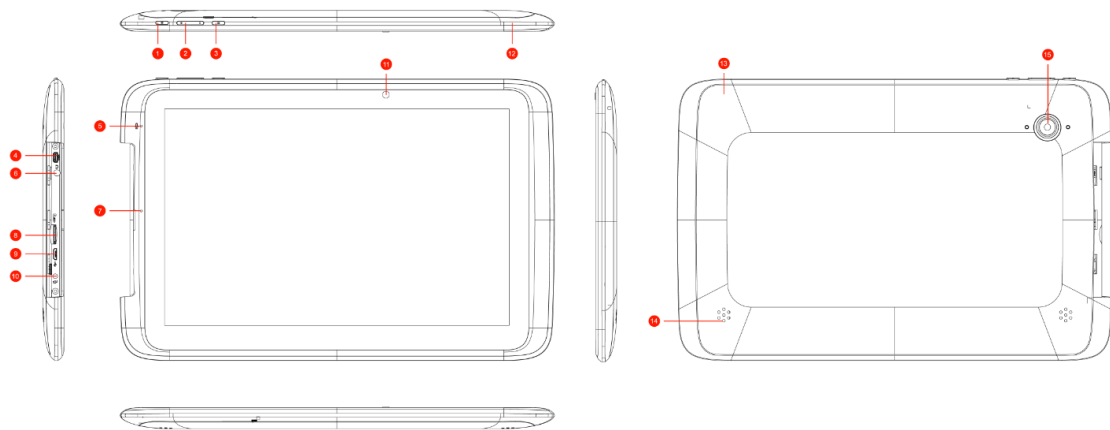

1. Power key: Press it down to start or close the touch screen panel. You can also let the computer to enter dormancy through this button or wake from the dormancy mode.
2. Sound-/sound+: Lower/raise volume
Loudspeaker: The built-in loudspeaker enables you to hear the sound without having to linking additional device.
3. Home key: Press this button to return to the Start screen.
4. HDMI interface: High-Definition Multimedia Interface
5. MIC
6. Earphone Interface
7. De-noising MIC
8. TF Card
9. USB interface: You can read the data through USB.
10. DC interface
11. Front camera

- Tablet
- 12. Front case
- 13. Rear case
- 14. Speaker
- 15. Rear camera

Introduction to Desktop

1. Windows 10 start image:

On the start screen, you can see many programs fixed in the image. These application programs are displayed in the form of “magnet”. As long as you click them, you can easily visit them.

You need to log on your Microsoft account before the application program completely runs.

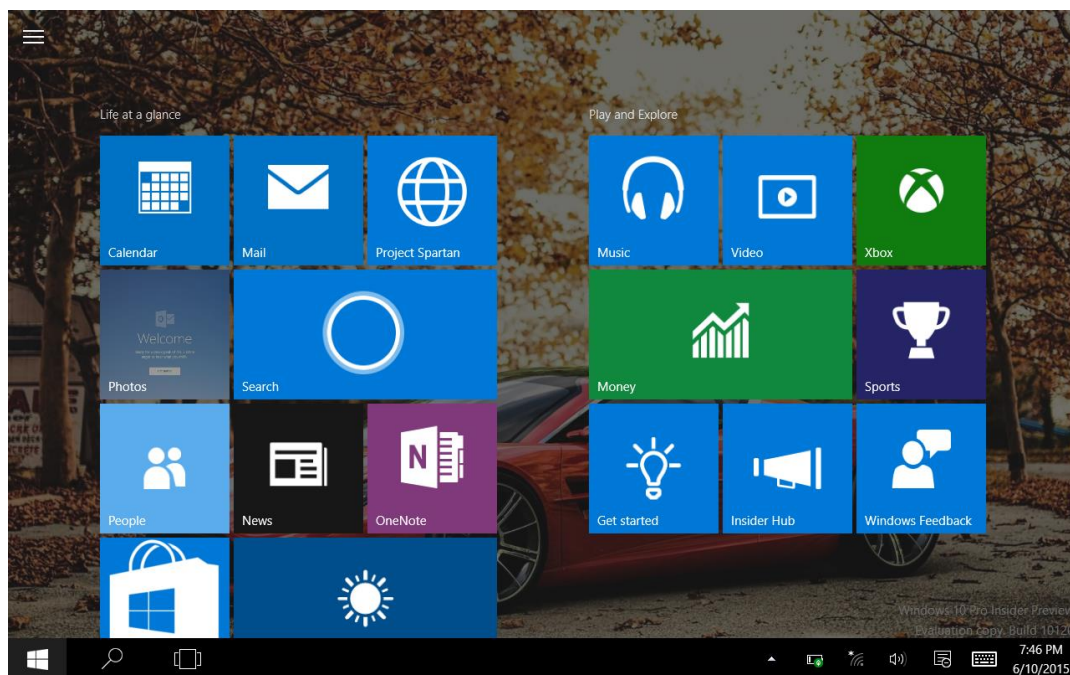

2. Image slide applications

Slide to right

Slide to left

Tablet



Slide to the right from the left side of the screen to scan the application program in running.



Slide to the left from the screen to setting Action Center.

Slide downward

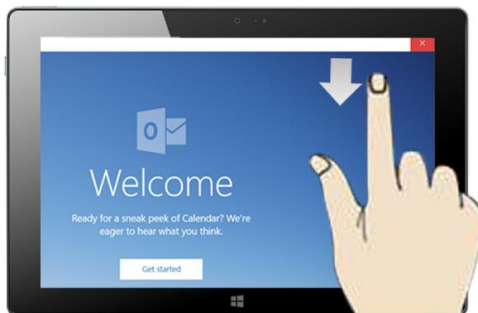

In start screen, slide from the top of the screen and down to view application programs to move the image.

Slide with finger



3. Introduction to app Interface

Besides the application programs already fixed on the start screen, you can also start other application programs in all application programs, such as other software application programs attached to the Tablet PC.

Tablet

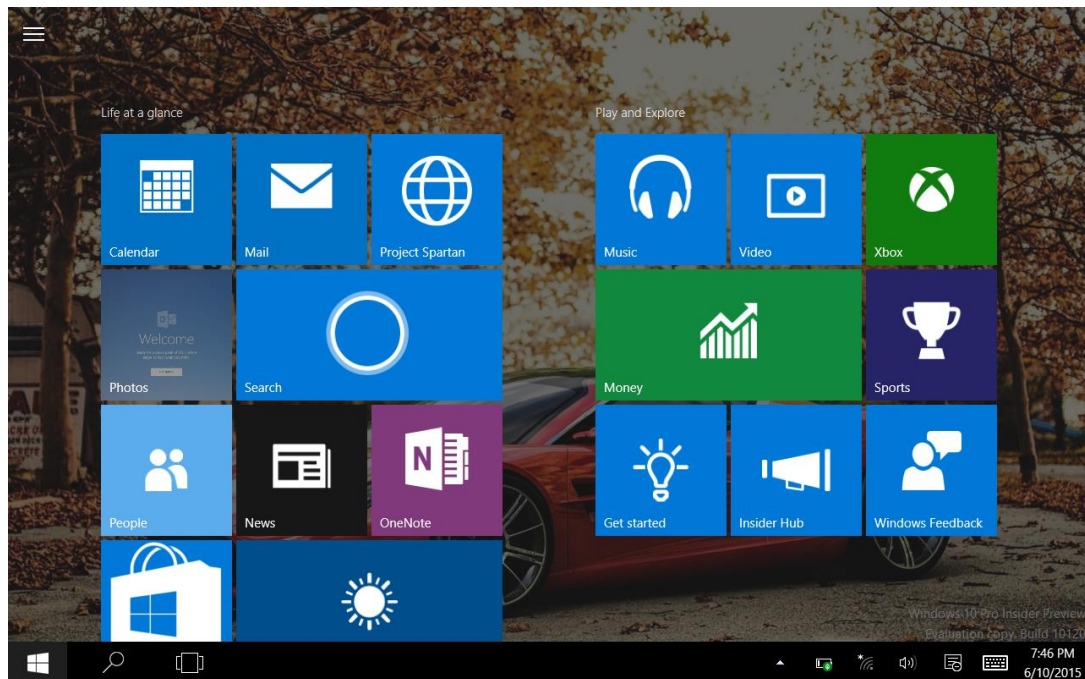

If you want to fix more application programs on the start interface, see the operation in the figure below, (1) Click the properties icon (2) press and hold the application program magnet for about one second and then let go (3) Click the Pin to start

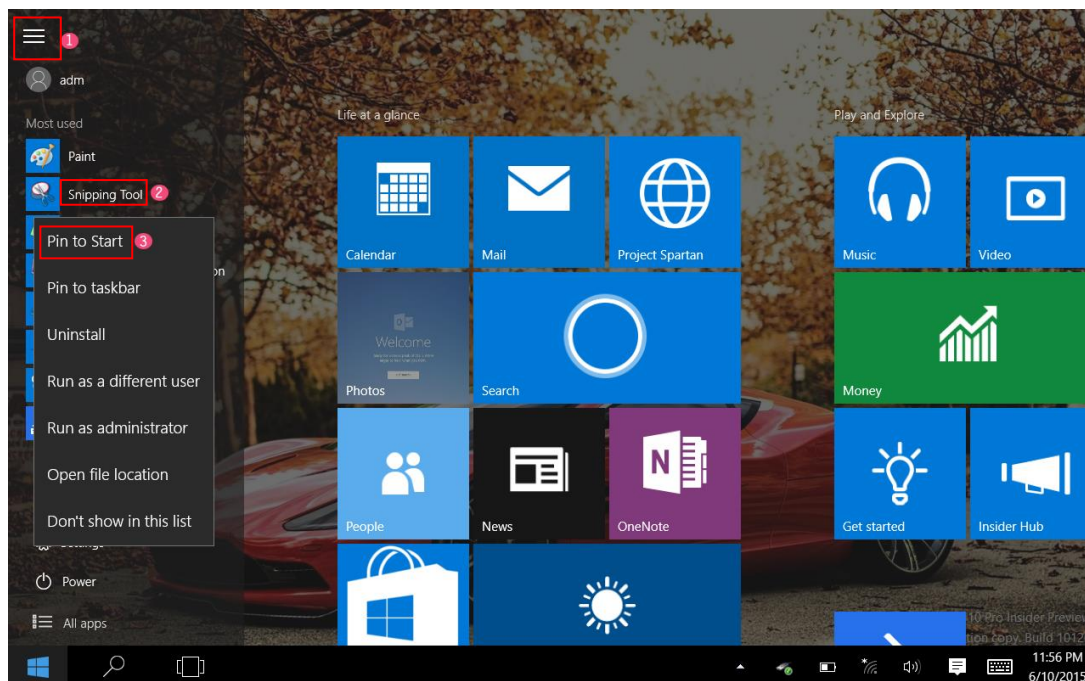

Conversely, if you want to cancel or delete a certain application in the start screen, (1) lightly touch, press and hold the application program magnet for about one second and then let it go and run, and select

Tablet

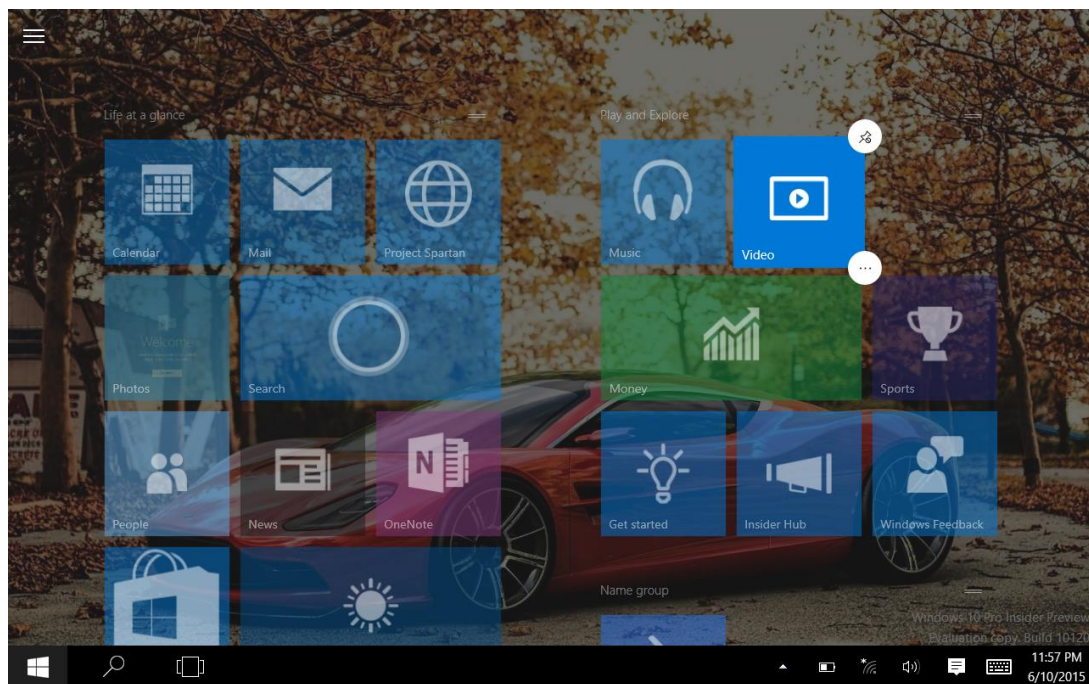

4. Start Menu

Under PC mode, press Start icon, Start Menu will display, including: Start, Device, Setup, Share, and Search Program.

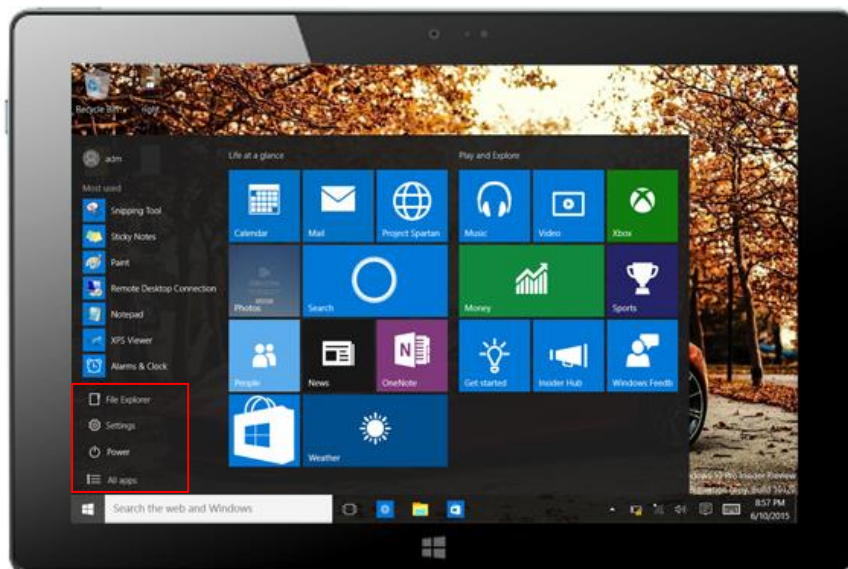

Usually: File Explorer, Settings, Power, and All apps

Tablet

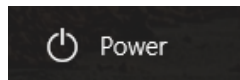

Can Sleep/Shut down/Restart the Tablet PC

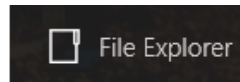

Can let you search the files and application programs in the Tablet PC.

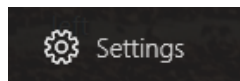

Can let you set up the Table PC.

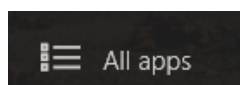

Can scan more apps

Search menu



Action Center

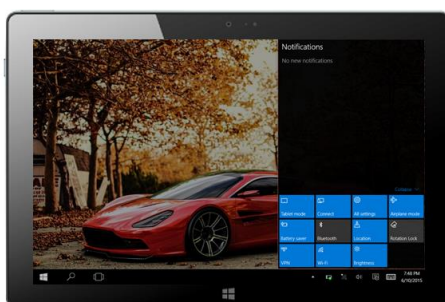

Setup Menu

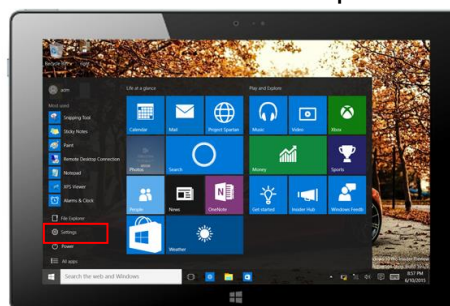

Action Center is a notification center also allows for quick settings like Tablet / PC mode, Wi-Fi, Bluetooth etc.

5. Multitasking operating interface

slide it right from the left side of the screen, Let go when Can see the running applications. We can enter the application, also can be deleted.

Tablet

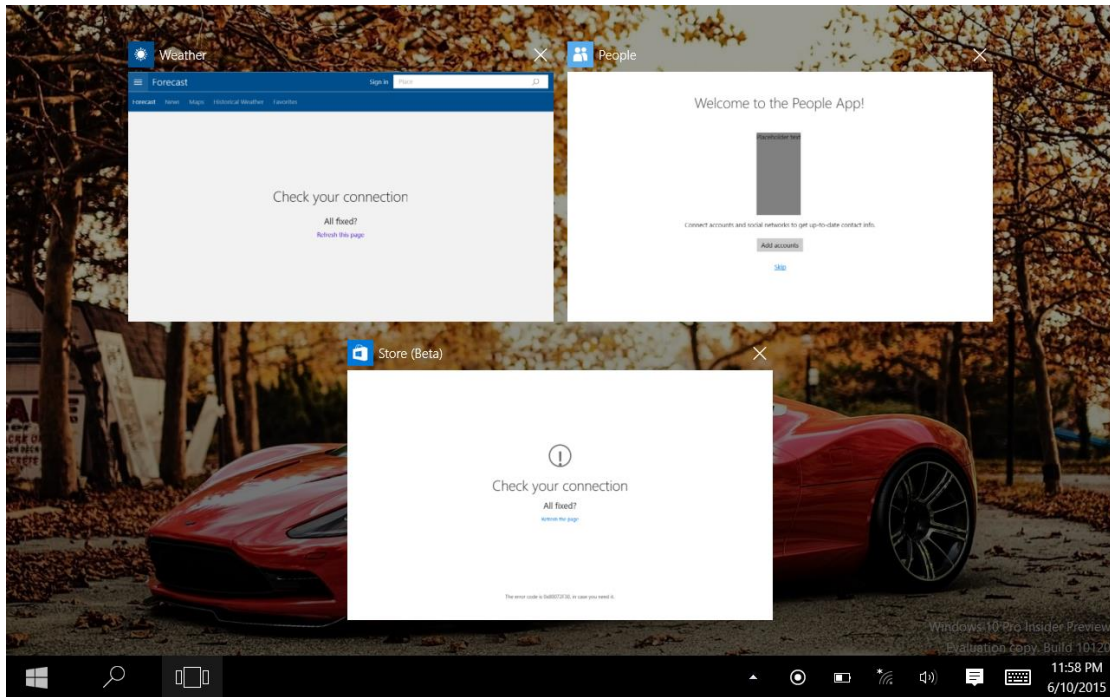

Basic Operations

1. Sleep, restart and power off

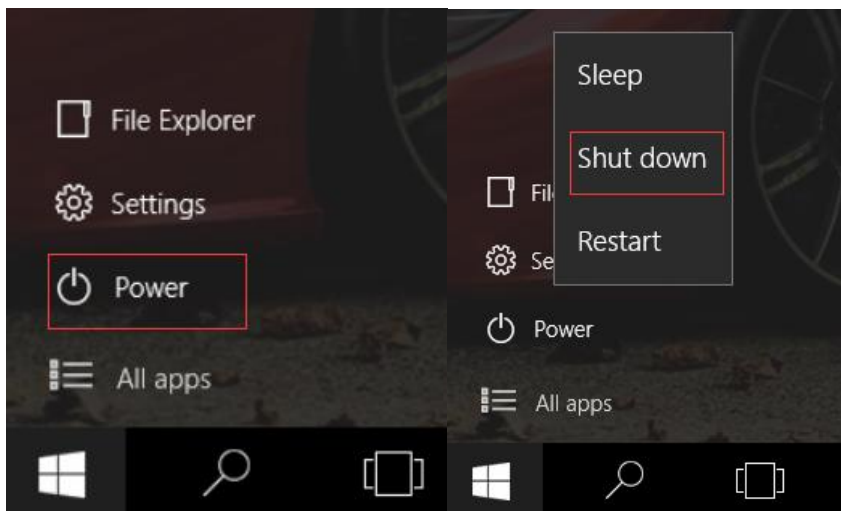

2. WIFI function;

Tablet

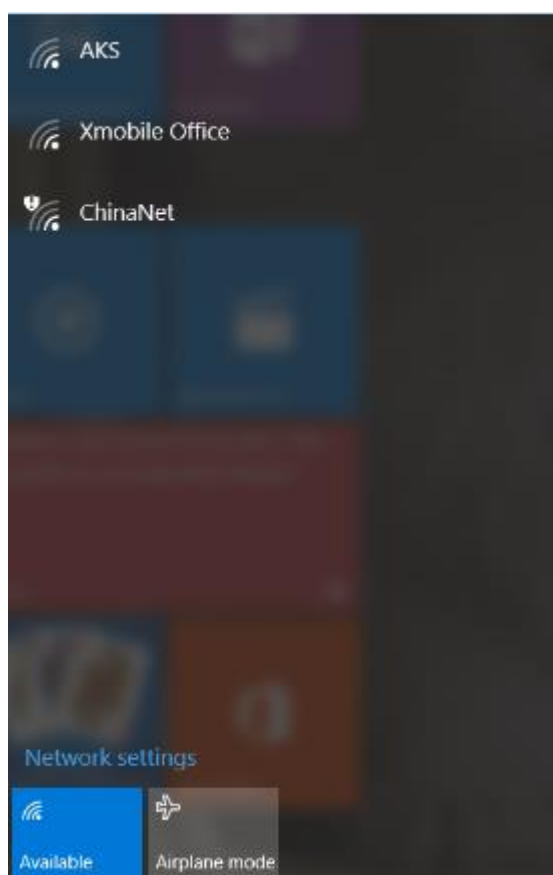
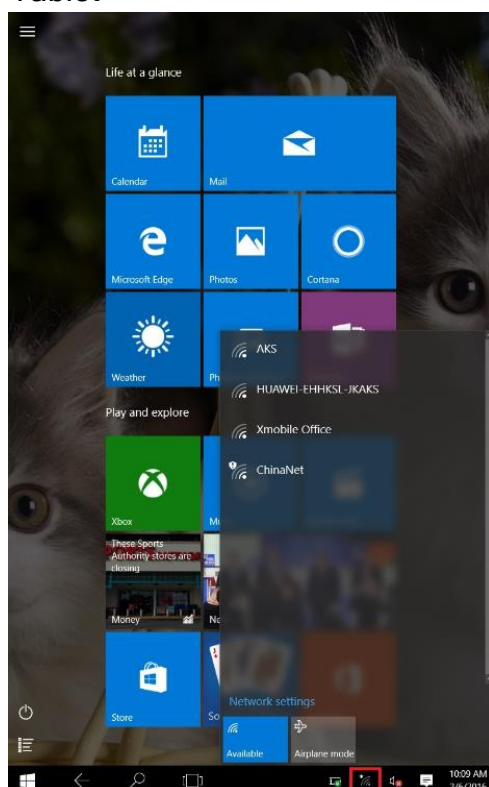

3. Bluetooth function

Tablet

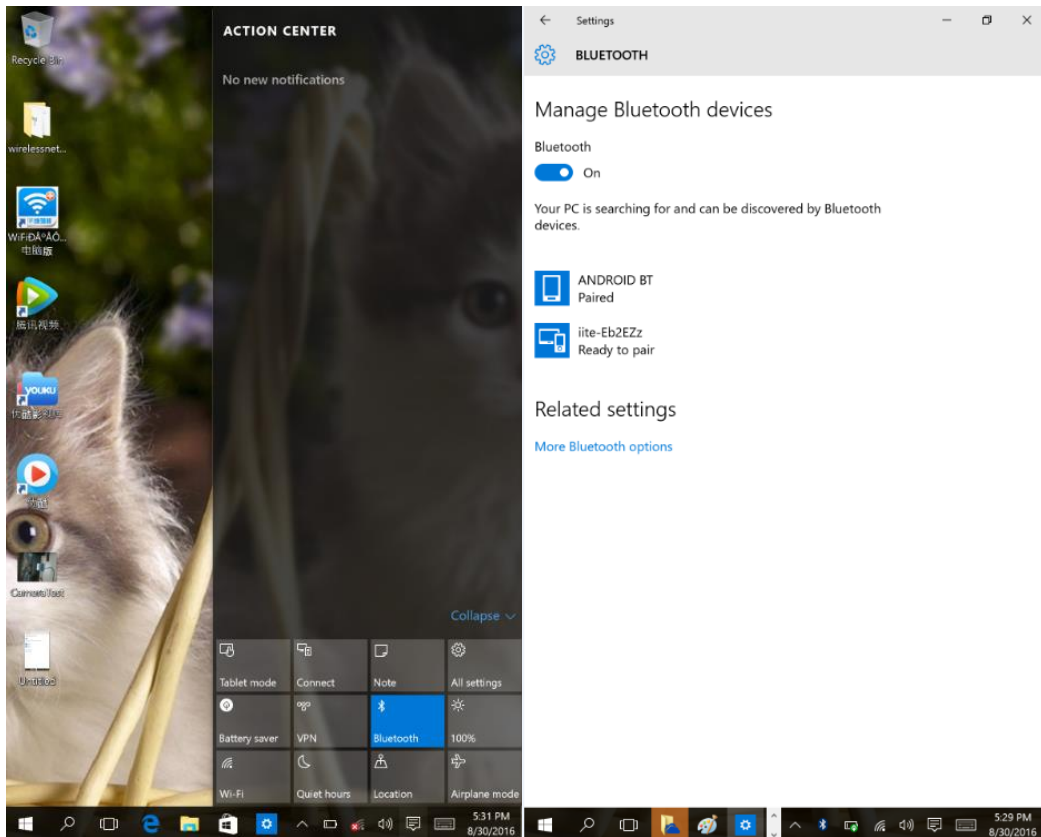



FCC Warning:

This equipment has been tested and found to comply with the limits for a Class B digital device, pursuant to part 15 of the FCC Rules. These limits are designed to provide reasonable protection against harmful interference in a residential installation. This equipment generates, uses and can radiate radio frequency energy and, if not installed and used in accordance with the instructions, may cause harmful interference to radio communications. However, there is no guarantee that interference will not occur in a particular installation. If this equipment does cause harmful interference to radio or television reception, which can be determined by turning the equipment off and on, the user is encouraged to try to correct the interference by one or more of the following measures:

- Reorient or relocate the receiving antenna.
- Increase the separation between the equipment and receiver.
- Connect the equipment into an outlet on a circuit different from that to which the receiver is connected.
- Consult the dealer or an experienced radio/TV technician for help.

Caution: Any changes or modifications to this device not explicitly approved by manufacturer could void your authority to operate this equipment.

This device complies with part 15 of the FCC Rules. Operation is subject to the following two conditions: (1) This device may not cause harmful interference, and (2) this device must accept any interference received, including interference that may cause undesired operation.

The device has been evaluated to meet general RF exposure requirement. The device can be used in portable exposure condition without restriction.