User Operating Manual

Contents

Contents	- 2 -
1 Introduction	1
1.1 Acknowledgements	1
1.2 Safety Notice	1
1.3 Abbreviation/term	2
2 Brief introduction for MID product	3
2.1 Diagram for MID complete machine	3
2.2 Introduction to accessories of MID	4
2.3 MID state and notice	4
3 Quick start	5
3.1 Key function	5
3.2 Starting up and turning off	5
3.3 Unlocking and closing of the screen	6
3.4 Use of touch screen	7
3.5 Homepage interface	8
3.6 USB connection	9
3.7 Memory card	10
4 Connection Establishment	11
4.1 WIFI Connection	11
4.2 Bluetooth Connection	12
5 Communication	13
5.1 Camera	13
5.2 HDMI	15
6 Other Applications	15
6.1 File Management	15

1 Introduction

1.1 Acknowledgements

Many thanks for you choosing this product. The product belongs to MID(Mobile Internet Device), which is a kind of mobile internet device, delicate, small and exquisite, and also portable. It is also equipped with a piece of touch LCD of high definition, which can be used to watch vedios and pictures of high definition. It supports installation of multiple application programs on office and entertainment. The fantastic operation interface will give you a brand-new user experience.

This manual systematically introduces diversified functions, using skills and matters needing attention of this MID, please read this manual carefully before using it.

1.2 Safety Notice

Before using MID, please read information in this section, and make your children learn about the information. About more detailed information, please refer to safety instructions and matters needing attention.

- Please don't use MID when you are driving, for fear of hindering safe driving.
- In medical places, please observe relevant stipulations and regulations. And in regions near the medical devices, please shut down MID.
- Please shut down MID or enable the airplane mode when boarding, so that the wireless signals will not interfere control signal of the airplane.
- Please shut down MID neighboring electronic equipments with high accuracy, otherwise, breakdown of electronic equipments may be brought about.
- Please don't dismantle the MID and its accessories on yourself, and only the authorized agency can maintain this MID.

-
- Please keep MID far away from magnetic equipment, radiation from MID will erase information stored on the magnetic equipment.
 - Please don't use MID in places with high temperature and inflammable gas (such as nearby gas station).
 - Please put MID and its accessories in places beyond children's touch, please don't let children use MID without supervision.
 - During using of this MID, please observe related laws and regulations, respect privacy and legitimate rights of others.
 - Please strictly abide by relevant explanations in this manual when using USB data line, otherwise, MID or personal computer may be damaged.
 - Please don't use the MID in humid environment such as bathroom, etc., and the MID being soaked or rinsed by liquid must be avoided.

1.3 Abbreviation/term

Abbreviation/term	Full name	Explanations
MID	Mobile Internet Device	Mobile internet terminal
WIFI	Wireless Fidelity	Wireless Local Area Network based on IEEE 802.11b standard
TF	TransFlash	Alternate name Micro SD, superminiature storage card
HDMI	HighDefinition Multimedia Interface	High definition multi-media interface

2 Brief introduction for MID product

2.1 Diagram for MID complete machine

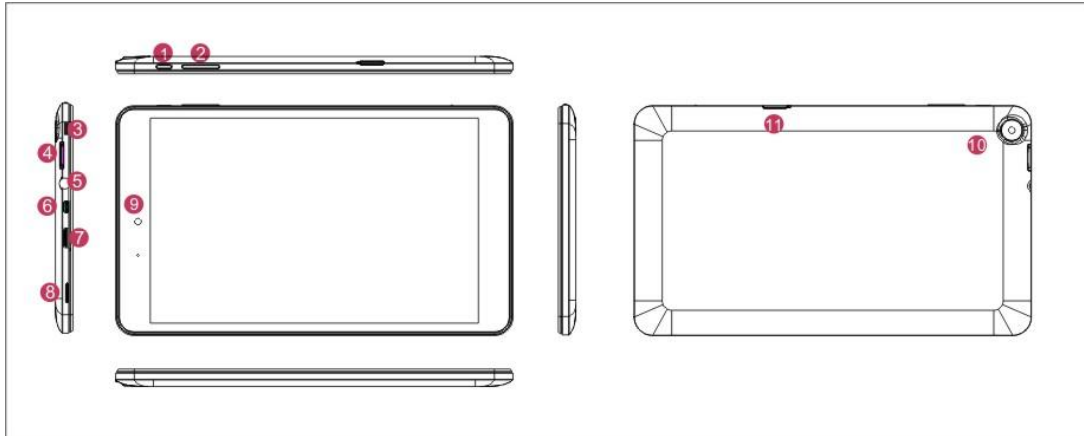

- ① Power button: Press it down to start or close the touch screen panel. You can also let the computer to enter dormancy through this button or wake from the dormancy mode.
- ② Sound-/sound+: Lower/raise volume
- ③ Windows key: Press this button to return to the Start screen.
- ④ MicroSD&MicroSDHC Micro SD card slot: The built-in storage card reader slot supports MicroSD and MicroSDHC format.
- ⑤ Socket for earphone and microphone: This socket can transmit the audio signals of Tablet PC to loudspeaker or earphone.
- ⑥ Micro HDMI Interface: High-Definition Multimedia Interface
- ⑦ Micro USB Interface: You can read the data through USB.
- ⑧ Loudspeaker: The built-in loudspeaker enables you to hear the sound without having to linking additional device.
- ⑨ Front camera: take photos, and record pictures
- ⑩ Back camera: take photos, and record pictures.
- ⑪ 3G Interface: Built-in 3G module, 3G Internet support.

2.2 Introduction to accessories of MID

Packing list













The following articles are included in your packing box of MID:









- Complete machine of MID
- Power adaptor
- USB connecting line
- Mini USB tieline
- 4G TF card (selective pairing)
- Earphone (selective pairing)
- User's manual
- Optical disk (selective pairing)
- USBkeyboard (selective pairing)

2.3 MID state and notice

Iconograph for notification

When a prompt message shows on your notice panel, please click the column box and slide on the screen with your finger to open the notice list. Click options needing to check to see detailed information. Then you may click the message box and slide upwards to close the message window. The following are iconography for icons in status bar:

	Mail notice		Mute
	Gmail notice		Without SD card
	Computer and MID are connected through USB line		Uploading/Downloading
	Events waiting to be done		Downloading finished
	Alarm clock opening		General notice (for example: synchronous error)
	Playing music		In data synchronism

	Insufficient space of SD card		More
	WIFI service is connected, netwrk is available		Battery symbol
	Airplane mode		Charging
	Bluetooth is already connected		GPS

3 Quick start

3.1 Key function

Descriptions for key function:

Power key	<ul style="list-style-type: none"> ● Press this key for a long time to start up ● Under starting up state, press this key for a long time to pop up shutdown option ● Under starting up state, press this key to close the screen ● Under starting up state or when breakdown appears, press the power key for 7 seconds to make your device enter into shutdown state
Menu key	<ul style="list-style-type: none"> ● Press this key to open menu of the current interface
Return key	<ul style="list-style-type: none"> ● Press this key to return the last operating step or the previous operating interface
Homepage key	<ul style="list-style-type: none"> ● Press this key to return back main function interface from any interface

3.2 Starting up and turning off

Starting up

Press the power key for 3 seconds, you can see the starting up picture. After the system is

started, the machine enters into screen lock state, please unlock according to direction indication of sliding icon on the interface.

Turning off

1. After pressing the **power key** for a long time, the shutdown option will pop up.
2. Click **OK**.

3.3 Unlocking and closing of the screen

The machine will close automatically when the screen is left unused

1. After the screen being left unused for a period of time, the machine will close screen automatically, so as to save battery power.
2. Under screen on state, press the power key, the screen will close immediately.

Prompt: if you want to inquire how to set turn-off time of screen, please refer to chapter 9.1.

Turning on under screen off state

If the screen is in off state, you can unlock the screen by pressing power key for a short time or the return key for a long time. After opening, the screen will enter lock state, press “lock” icon by your finger and slide rightwards, the screen will be unlocked, press “lock” icon and slide leftwards, you can enter the camera function.

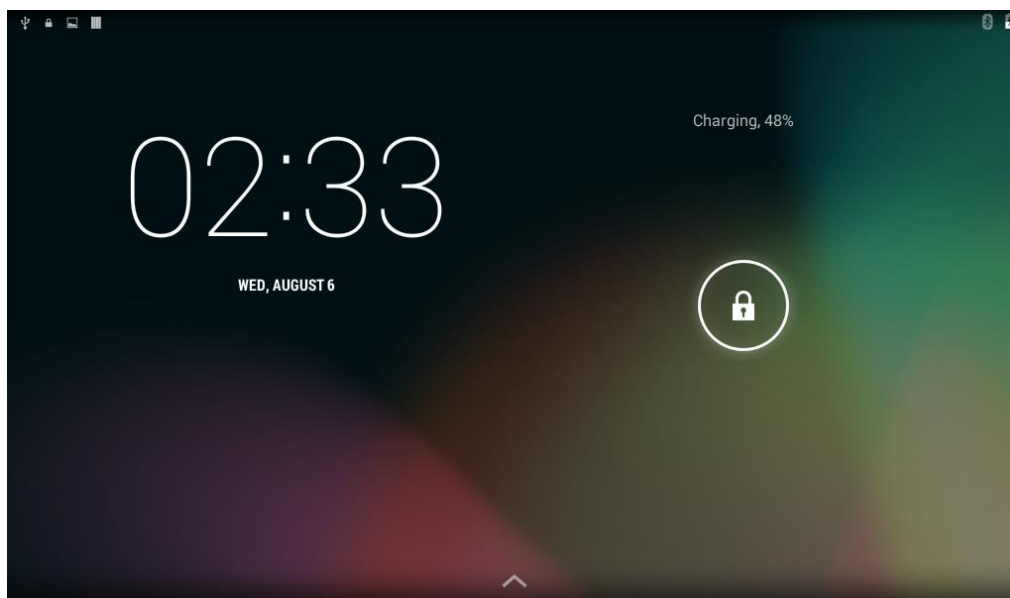

Figure 3-1

3.4 Use of touch screen

Operating mode in MID

There are various ways to skim the main screen, menu and application program, etc. on your MID.

Click to select

When you want to use screen keyboard entry, and you want to select items on the homepage interface such as application program, you only use your finger to click.

Press on

If you want to unlock the available option of a certain item (such as textbox or interlinkage in the webpage), or move shortcut on the homepage interface and menu of main program, only press the item.

Slide quickly or slide

Quick sliding or sliding means doing rapid vertical or horizontal drag movement by using finger on the picture.

Drag

Before you starting to drag, you must press it with your finger and impose a certain pressure, and don't loosen the finger before dragging to the wanted position.

Rotate

Aiming at most of pictures, only turn the MID in side direction, the screen direction can be shifted from cross direction to vertical direction. For example, when you input characters, watch cinema, etc.

3.5 Homepage interface

All application programs on the machine will be displayed on the main menu screen. You may use application program, shortcut and user-defined mode to set wallpaper of your homepage interface

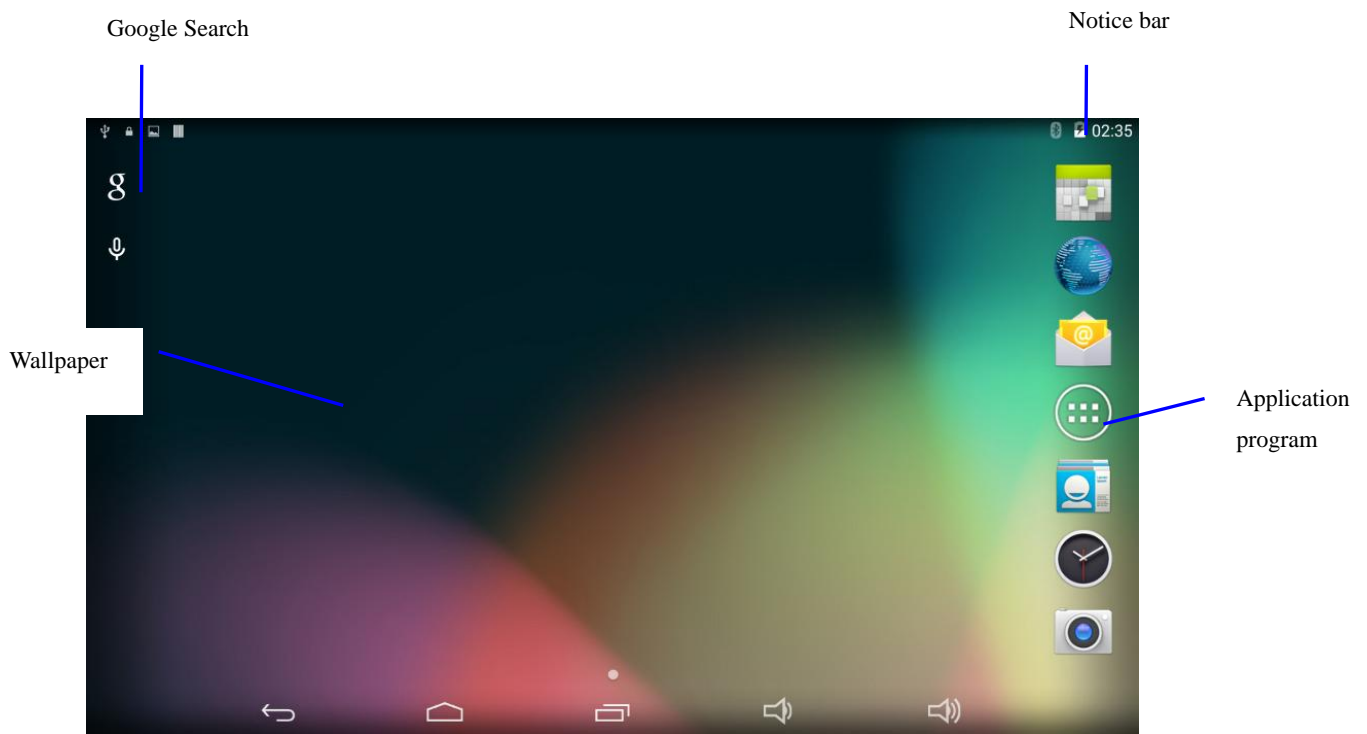

Figure 3-2

Skill: in any application programs, you can press homepage key to return homepage interface.

Custom homepage interface

Change desktop wallpaper

1. Press blank region on the homepage interface to pop up the menu.
2. When the menu popping up, choose source of homepage interface wallpaper you want to change.
3. After clicking source of wallpaper, click picture you want, and then select “setting wallpaper”.

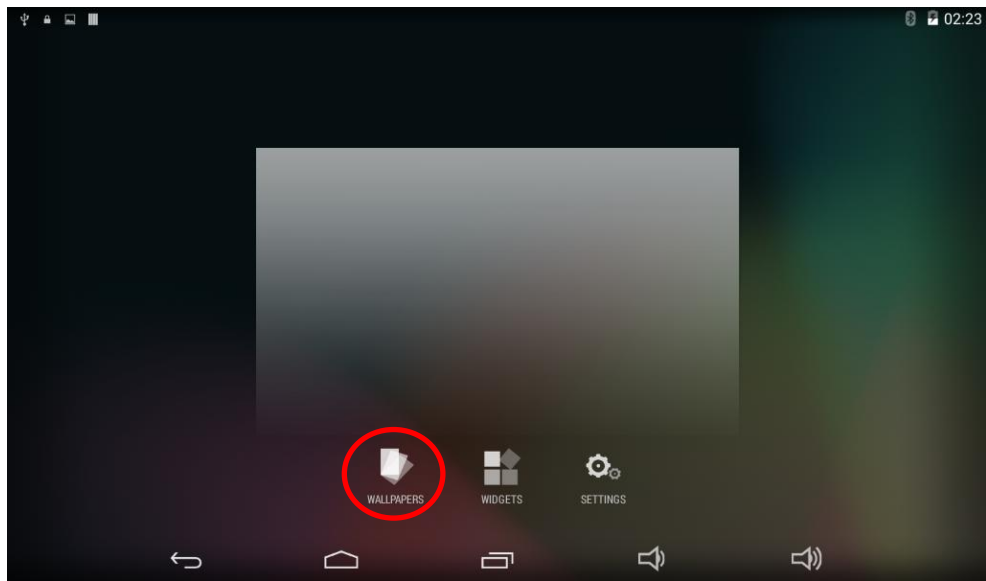

Figure 3-3

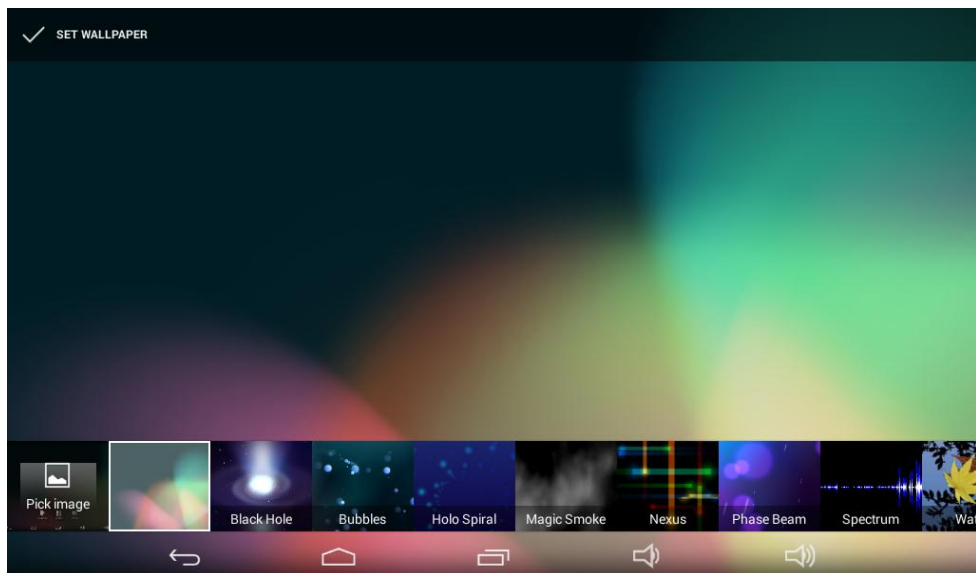

Figure 3-4

3.6 USB connection

Storage setting of MID

Before transmitting document, you must set storage mode for your MID firstly:

1. Connect MID with computer by using USB transmission line. Notice bar will show the notice prompt.
2. Click status bar, options of status bar show.
3. Among options of status, click to choose **USB connected**, then click to **open USB storage device**.

-
4. At this time, USB has already been connected.



Figure 3-5

Copy the document to storage card

1. Connect MID and computer together with USB cable.
2. After **setting** according to **storage of MID**, connect with computer successfully.
3. Open your computer, in **my computer**, examine content in “removable disk (x)”.
4. Find the document you want to copy, copy it to “removable disk(x)”.
5. After completion of copying, click “safely remove hardware” in taskbar of your computer to unload.

Content of MID storage device

1. NAND FLASH storage device, space for MID to store document itself.
2. TF removable memory card.
3. The two above-mentioned storage devices both can be visited through connection with your computer with USB.

Attention: when your MID is connected with USB cable, if you start up USB storage device, you will cannot visit the memory card through MID, if you want to visit memory card in MID, only disconnect USB cable.

3.7 Memory card

Copy the document to storage card

You can transmit document between MID and computer, such as music and picture, etc. If you want to see documents in MID, only click the file browser to look through content in the

SD card.

Delete documents on the storage card of MID

1. Find document you want to delete.
2. Press the document name you need to delete, a file menu will pop up.
3. Click **delete**.

Removing storage card when the MID is in starting up state

If need to remove storage card under starting up state of MID, you must unload the storage card firstly, for fear of failure or damage of the storage card.

1. In the homepage interface, press the menu key, then click **setting**.
2. Pull the setting menu downwards, then click **storage**.
3. Click **SD card setting**.
4. Click **to uninstall the SD card**.

4 Connection Establishment

4.1 WIFI Connection

Your MID can be connected onto Wi-Fi network to connect the operation:

1. On the homepage interface, click and select the menu key and pop up the menu setting;
2. Click and select the **System Setting**;
3. Click Wi-Fi and open wi-fi switch;
4. After opening Wi-Fi, the searched Wi-Fi network can be scanned automatically from the equipment in the windows on the right.
5. Select the Wi-Fi network required to be connected, if the password is added, pop up the password input windows and input the corresponding password.
6. Click the **Connection**

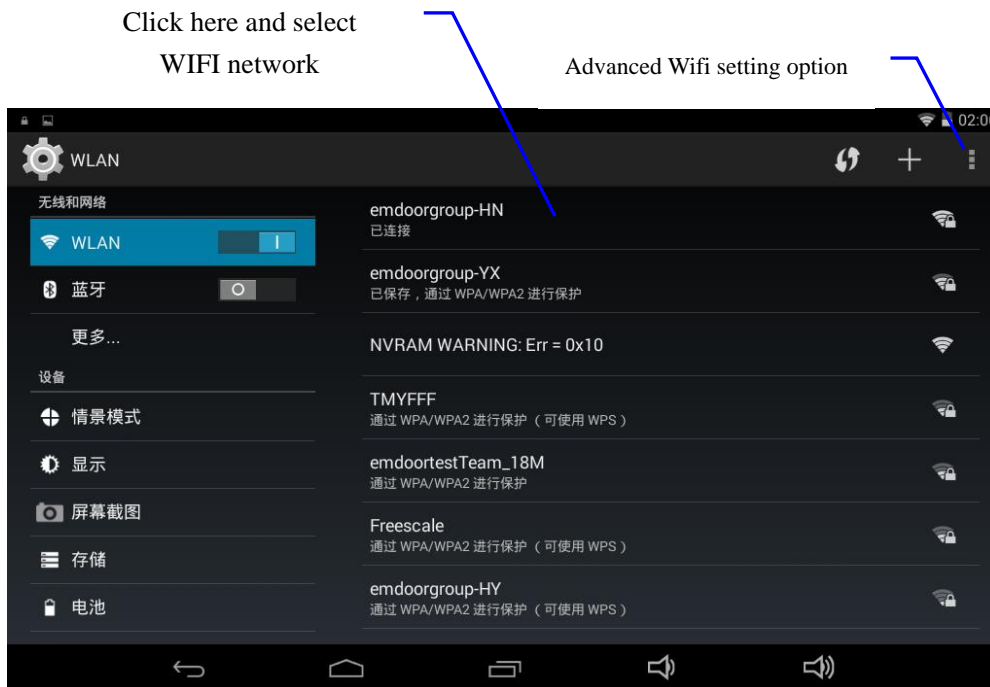

Figure 4-1

4.2 Bluetooth Connection

Functions of bluetooth:

1. You can exchange the files between two blueteeeth. You can exchange the files with other computers, mobile phones and pda.
2. You can synchronously exchange pims data with mobile phones, pda and laptop to support the bluetooth (data of outlook E-mail address).
3. You can You can exchange the electronic name card with mobile phones, pda and laptop to support the bluetooth.
4. You can connect the keyboard, mouse and joystick to support the bluetooth.

Application of bluetooth (Figure 4-3)

1. Setting procedure of entering into bluetooth: set -> bluetooth set, open the bluetooth equipment
2. Name of equipment: you can randomly change the name of bluetooth for your MID by pressing **Menu key**.
3. Detectability: open this function by clicking the place for name of bluetooth, which indicates that your MID bluetooth can be searched by other bluetooth equipments, this default time for this opening is of 120 seconds.
4. Scan and look for equipment: you can detect the equipment desired to be connected by

utilizing this function.

5. Bluetooth: after employing the scan to look for the equipment, all bluetooth equipments searched by your MID can display under this function.

Click this and open the detectability function

Click this scan to search for the equipment

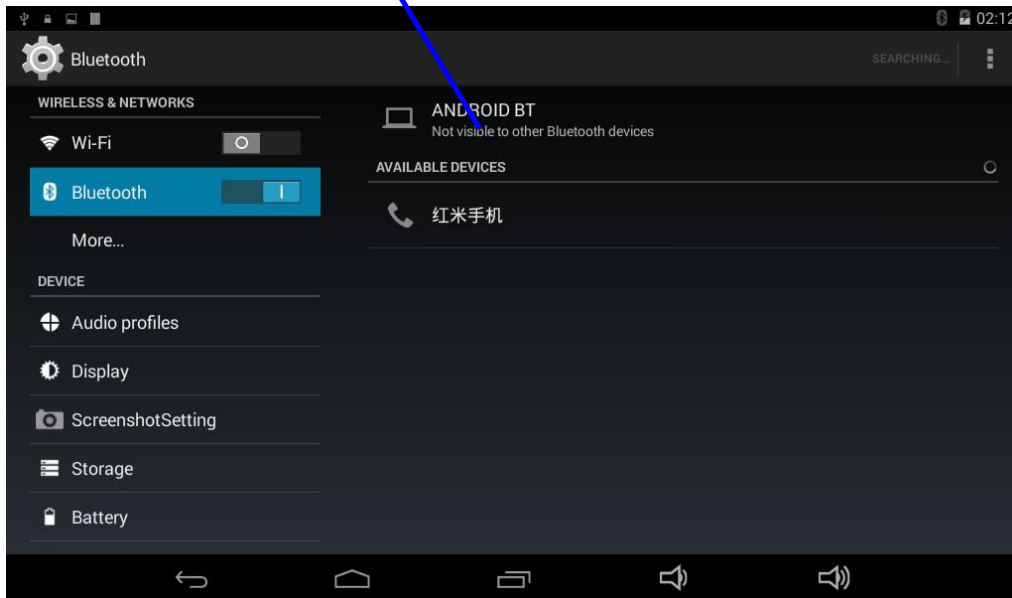

Figure 4-3

5 Communication

5.1 Camera

Camera functions

1. Click and select the **camera**;
2. The system enters into the camera interface;
3. Click and select the Photo button and easily take the photos;
4. Set such functions as photo size, storage location, white balance and focal length regulating;
5. After completion of taking photo, there is the display for previewed minimap.

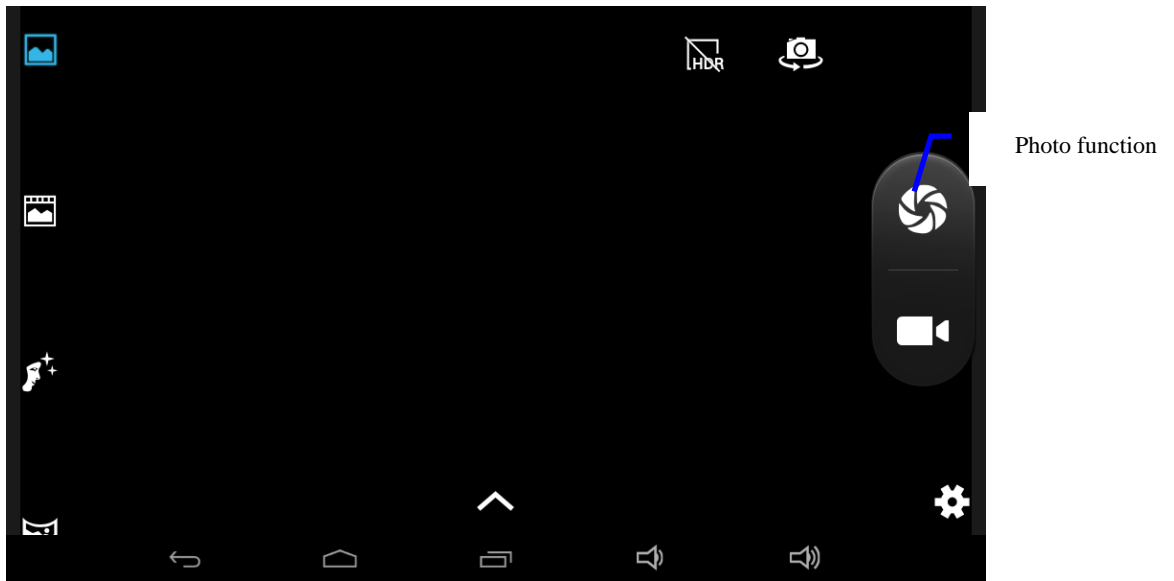

Figure 6-2

Videotape function

1. Click the videotape icon and convert it as video recorder mode;
2. Click and select the red videotape button to take video ;
3. Set such setting functions as color effect, white balance and video quality;
4. Switch 720P and 480P high-definition videorecording.
5. Click and select the videorecording button, end the videorecording, and observe the previewed video.

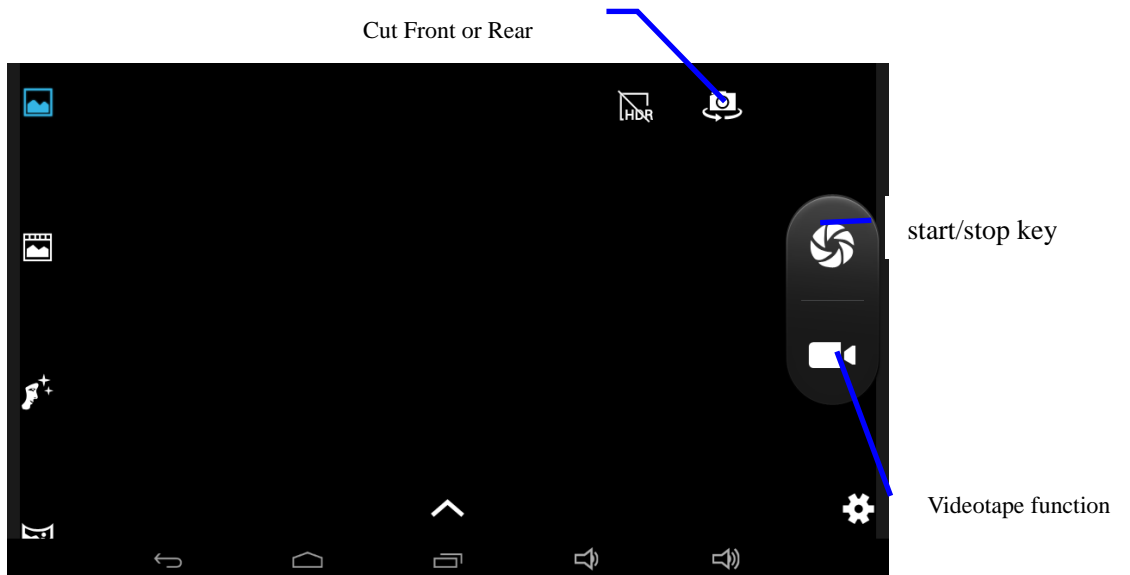

Figure 6-3

5.2 HDMI

HDMI High-definition video interface

The MID and the high-definition television are connected by a standard HDMI cable. This interface supports the picture with highest quality of 1080p resolution ratio.

1. MID is in the boot status.
2. The MID and the high-definition television are connected by a standard HDMI cable.
3. The system interface on MID is automatically synchronized with the high-definition TV screen.
4. Click **Display** in the settings menu.
5. Click **Output Select** to switch HDMI mode.
6. Click **Resolution** to set the resolution ratio of HD TV.

6 Other Applications

6.1 File Management

Browse files

Slide the desktop to locate the **File browser**.

You can use the file browser to manage, edit and delete the files and folders, or to create sharing and FTP server to achieve resource sharing.

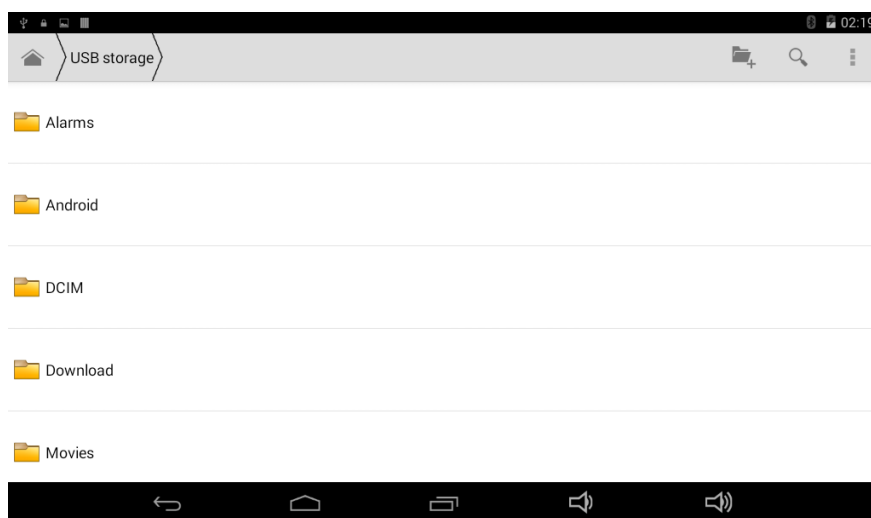

Fig. 8-4

Cut and copy files

1. In the file browser, press and select the file you want to operate.
2. Pop up operating menus, including **Cut, Copy, Delete, Rename, Move to, Copy to, Play music, Select all, Set home directory and Attributes**, etc.
3. Click **Cut** or **Copy** file or folder.
4. Click into the folder you want to paste, and pop up menu by pressing the Menu key.
5. Click **Operate** and then click **Paste**.

Delete files

1. In the file browser, press the file you want to delete.
2. Click **Delete**.
3. Click **OK** to delete file.

Folder setup

1. In the file browser, pop up menu by pressing the Menu key.
2. Click **Create**.
3. Click **Folder**.
4. Click pop-up window and input the name of the new folder in the text box.
5. Click **OK** to create the folder.

Quick search

1. In the toolbar of the file browser
2. Click **Search icon**.
3. Pop up the search panel and enter the keywords you need to find.
4. Click **OK** and the search progress bar will appear in the notification bar.
5. When the search is completed, pop up the dialog box to confirm whether to show the results.
6. Click **OK** to show the search results.

Create sharing

1. Load ES file browser. (Fig. 8-5)
2. Click **'Local'** at the upper left corner and select **'Share'** in the pop-up window.
3. Click the menu bar **'Create'**, and select **'Search'** in the pop-up window .
4. The system will automatically search all the computers within the LAN, and each drive of your computer can be seen by clicking OK.
5. You can **Copy, Delete, Rename** here.

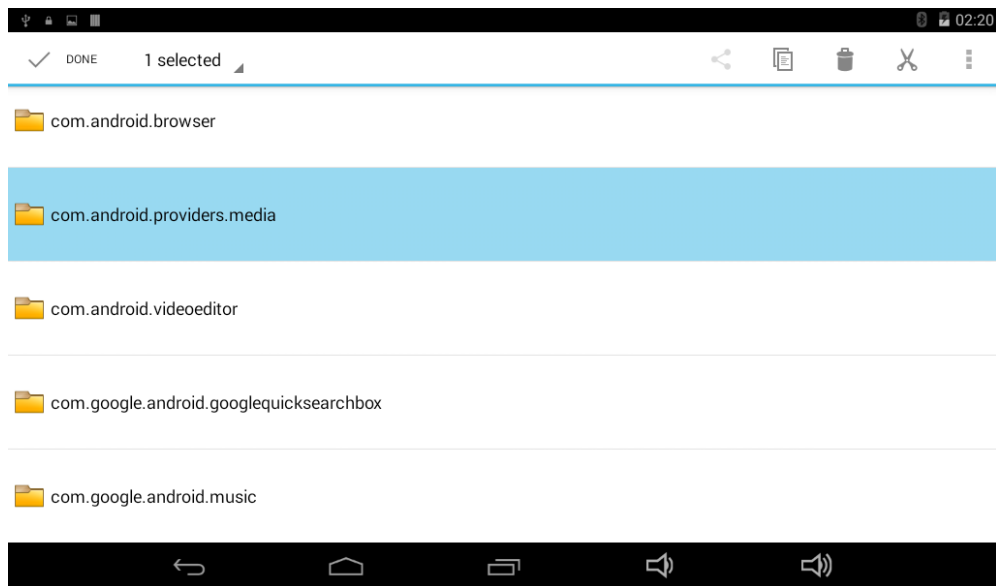

Fig. 8-5

FCC statement

This device complies with Part 15 of the FCC Rules: Operation is subject to the following two conditions:

1. This device may not cause harmful interference and
2. This device must accept any interference that is received, including any interference that may cause undesired operation.

*RF warning for Portable device: The device has been evaluated to meet general RF exposure requirement. The device can be used in portable exposure condition without restriction.

This device is acting as slave and operating in the 2.4 GHz (2412 ~2462 MHz) band.

Do not use the device with the environment which below minimum -10°C or maximum over 50°C .

NOTE: This equipment has been tested and found to comply with the limits for a Class B digital device, pursuant to part 15 of the FCC Rules. These limits are designed to provide reasonable protection against harmful interference in a residential installation. This equipment generates uses and can radiate radio frequency energy and, if not installed and used in accordance with the instructions, may cause harmful interference to radio communications. However, there is no guarantee that interference will not occur in a particular installation. If this equipment does cause harmful interference to radio or television reception, which can be determined by turning the equipment off and on, the user is encouraged to try to correct the interference by one or more of the following measures:

- Reorient or relocate the receiving antenna.
- Increase the separation between the equipment and receiver.
- Connect the equipment into an outlet on a circuit different from that to which the receiver is connected.
- Consult the dealer or an experienced radio/TV technician for help

Changes or modifications to this unit not expressly approved by the party responsible for compliance could void the user's authority to operate the equipment.