

# Owner's Manual

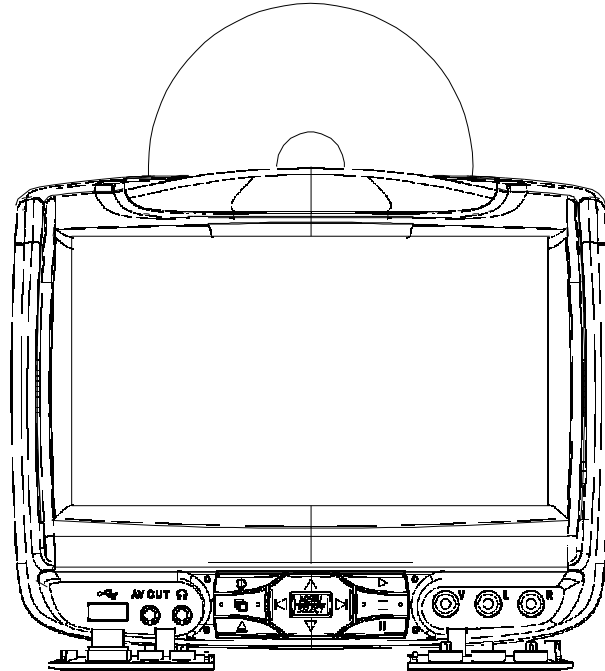

**SSLM7BA1 MONITOR-SLIMLINE 7 INCH-A**

**SSLM7BB1 MONITOR-SLIMLINE 7 INCH-B**

**SSLM8AA1 MONITOR-SLIMLINE 8 INCH-A**

**SSLM8AB1 MONITOR-SLIMLINE 8 INCH-B**

# **SSLM7BA1/SSLM7BB1/SSLM8AA1/SSLM8AB1 MONITOR-SLIMLINE 7 INCH and 8 INCH**

## **Important Notice**

It is unlawful in most jurisdictions for a person to drive a motor vehicle which is equipped with a television viewer or screen that is located in the motor vehicle at any point forward of the back of the driver's seat, or that is visible, directly or indirectly, to the driver while operating the vehicle. In the interest of safety, the unit should never be installed where it will be visible, directly or indirectly, by the operator of the motor vehicle.

If your vehicle is equipped with a Wireless Rear Seat Audio System or any other Wireless IR Device, power system off in order to operate the DVD Headrest System. If system is powered on, the two systems may interfere with each other cancelling out or creating undesirable audio through the Wireless headphones.

## **Safety Precaution**

For safety reasons, when changing video disc it is recommended that the vehicle be not in motion, and that you do not allow children to unfasten safety belts to change disc or make any adjustments to the system. System adjustments can be accomplished using the remote control unit, while safety belts remain fastened. Enjoy your entertainment system but remember safety of all passengers remains the number one priority.

- 2 -

## Product Features

- 7-inch Color TFT-LCD Panel (480x3(RGB)x234) with 16:9 Aspect for SLIMLINE 7-inch model
- 8-inch Color TFT-LCD Panel (800x3(RGB)x480) with 16:9 Aspect for SLIMLINE 8-inch model
- Built-in Slim Type Top-Loading Slot-In DVD Player
- Infrared Transmitters for IR Wireless Headphones
- Audio/Video Source Input- 3 RCA Jacks
- Audio/Video Signal Output- 1/8-inch Headphone Jack
- 1/8-inch Stereo Headphone Jack
- USB Port compliant with 1.1 specifications
- Forward Remote Sensor on the Front Panel
- Full Function Remote Control
- 7 Control Buttons on the Front Panel- POWER/SOURCE, STOP/LEFT, UP, SETUP/ENTER, PLAY/PAUSE/RIGHT, EJECT, DOWN
- OSD (On Screen Display) Control
- 12V DC Power Input
- FM Transmitter (may be optional)

### Caution:

- Be sure run the vehicle engine while using the device. Use this device without running the engine can result in battery drainage. To avoid the risk of battery drainage, please remember turn off the device when the vehicle unused for long periods of time.

Any changes or modifications not expressly approved by the grantee of this device could void

the user's authority to operate the equipment.

## **FEDERAL COMMUNICATIONS COMMISSION INTERFERENCE STATEMENT**

This equipment has been tested and found to comply with the limits for a Class B digital device, pursuant to Part 15 of the FCC Rules. These limits are designed to provide reasonable protection against harmful interference in a residential installation. This equipment generates, uses and can radiate radio frequency energy and, if not installed and used in accordance with the instructions, may cause harmful interference to radio communications. However, there is no guarantee that interference will not occur in a particular installation. If this equipment does cause harmful interference to radio or television reception, which can be determined by turning the equipment off and on, the user is encouraged to try to correct the interference by one or more of the following measures:

- Reorient or relocate the receiving antenna.
- Increase the separation between the equipment and receiver.
- Connect the equipment into an outlet on a circuit different from that to which the receiver is connected.
- Consult the dealer or an experienced radio/TV technician for help.

## **FCC RF Radiation Exposure Statement**

This equipment complies with FCC RF radiation exposure limits set forth for an uncontrolled environment. This equipment should be installed and operated with a minimum distance of 20cm between the radiator and your body.

- 3 -

# Table of Contents

<b>1. Optional Accessories</b> .....	7
Wireless Headphone .....	7
Wired Headphone .....	7
AV Control Box .....	7
Wired FM Modulator .....	7
<b>2. Installation Sequence</b> .....	8
Pre-Installation Precaution .....	8
Battery Disconnect .....	8
Remove Factory Headrest .....	8
Install SLIMLINE Headrest Monitor A and Monitor B .....	8
Router Cabling under Driver Seat & Passenger Seat .....	10
Functional Verification .....	11
<b>3. Control Description on the Front Panel</b> .....	12
<b>4. Remote Control Operations</b> .....	15
Installing the Battery .....	15
Warning/Caution on using Batteries .....	15
Button Function Descriptions .....	16
<b>5. General Operating Instructions</b> .....	22
Turning the Device ON or OFF .....	22
Channel Tuning Setup .....	22
<b>6. DVD Basic</b> .....	23
Regional Coding .....	23
Type of Discs your DVD will Play .....	23

Loading and Playing Discs .....	23
To Load and Play a Disc .....	23
<b>7. Notes on Discs .....</b>	<b>24</b>
<b>8. How to use the DVD OSD Menu .....</b>	<b>25</b>
Using the Setup Menu .....	25
To Cancel using the Setup Display .....	25
General Setup Page .....	26
Setting the Language for On-Screen Display .....	26
OSD (On Screen Display) Language Menu .....	26
Setting for Display .....	26
Preference Page .....	27
Default Setting .....	27
Setting for Parental (Parental Control) .....	27
Password Setup Page .....	28
Setting for Password (Parental Control Password) .....	28
<b>9. Playing Audio CD .....</b>	<b>29</b>
Using the REPEAT Feature .....	29
<b>10. Playing MP3 Discs .....</b>	<b>30</b>
Selecting Folders and Songs .....	30
Skipping Songs .....	31
Selecting a Play Mode .....	31
<b>11. How to use the Device OSD Menu .....</b>	<b>32</b>
Picture Adjustment .....	32
<b>12. Technical Data .....</b>	<b>33</b>

<b>13. Troubleshooting</b>	-----35
<b>14. WEEE Notice</b>	-----37



## Optional Accessories

### **Wireless Headphone**

This SLIMLINE includes a built-in dual channel infrared transmitter for use with a wireless headphone. The volume can then be adjusted with the controls on each headset. The wireless headphone must be used within a line of sight from the transmitter, as infrared transmission, like visible light travels only in a straight line.

### **Wired Headphone**

There is a 1/8-inch headphone jack on the device that can be used with any standard stereo headphone. Remove and save the protective plastic cover to access the jacks. Remember to replace the cover when the jacks are not in use.

### **AV Control Box**

The additional audio/video input may connected such as a DVD player, video game device, or other audio/video devices. To play the second AV source, turn the SLIMLINE on and press the SOURCE button on the remote control until “AV or AUX” is displayed on the screen. Turn the source component on with its power button or remote control. The SLIMLINE is now ready to play the audio and video signals from the source connected to AV or AUX input.  
location.

### **Wired FM Modulator**

Your video device may be equipped with an external FM modulator, which allows you to listen to the audio signal by tuning your vehicle’s FM radio to the selected frequency (88.3, 88.7, 89.1, 89.5, 89.9, and 90.3MHz check with your installer) and turning on the remote. Whenever the RF modulator is on broadcast radio reception will be poor. Turning the remote to switch SOUND AROUND off, FM modulator will allow normal radio reception.

## **Installation Sequences**

After safety mandated preparatory steps have been taken, the installation sequence is the suggested method for completing the accessory installation. In some instances the suggested sequence is written for one associate to install and in others the sequence is given as part of a team accessory installation. Unless otherwise stated in the document, the associates may perform the installation steps in any order to make the installation as efficient as possible while maintaining consistent quality.

### **Pre-Installation Precaution**

- Use Seat and Floor Protectors to avoid damage to surfaces.
- If the vehicle is equipped with an Anti-theft radio the radio code must be written down prior to disconnecting the battery cable. The code must be re-entered when the negative battery cable is reinstalled.

### **Battery Disconnect**

- Move seats forward and recline back slightly.
- Remove the Negative (-) battery terminal using 10 mm socket before starting any disassembly.

### **Remove Factory Headrests**

- Remove driver side headrest while depressing release button, and repeat for passenger side.
- Disconnect elastic straps, and repeat for passenger side.

### **Install SLIMLINE Headrests Monitor A and Monitor B**

- Insert wire puller into left hand hole of seat back and pull through to bottom, and feed cable #1 from Monitor A down left hole in top of driver side seatback.
- Repeat the above steps for the right hole of seat back and cable #2.
- Insert headrest while pulling cable #1 and cable #2 down seat back.
- Repeat for passenger side and Monitor B.

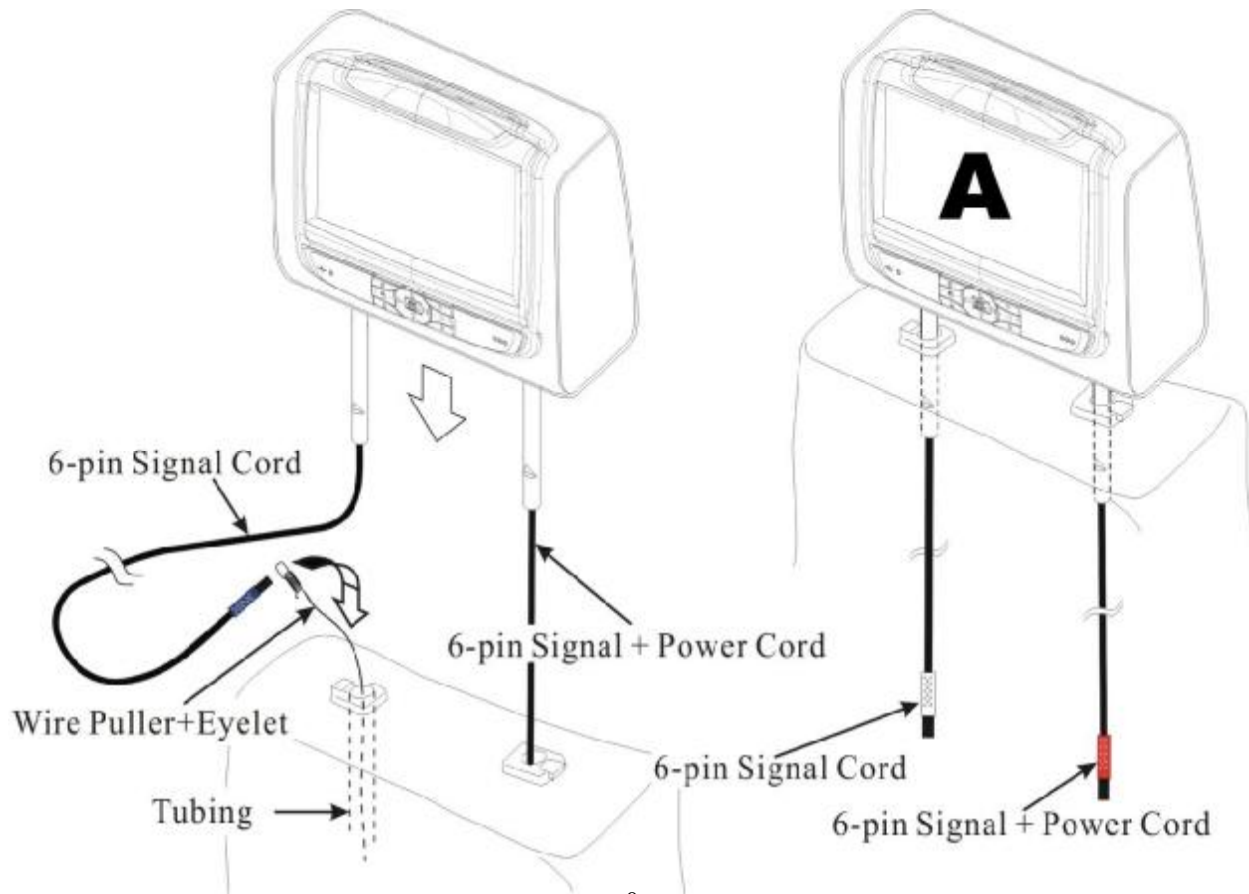

## Router Cabling under Driver Seat & Passenger Seat

- Connect **6-pin signal cord 1A** (white) and **6-pin signal + power cord 2A** (red) of driver seat to corresponding with the connectors of **signal cord 3A**, and then fix both connectors with a clamp if available. And connect other end connectors (white and red) of **signal cable 3A** to corresponding with connectors of Control Box as shown below. Repeat for passenger seat.
- Connect **FM antenna cable** to Control Box 2-pin connector.
- Connect **power cable** to Control Box 3-pin connector, then to vehicle power.

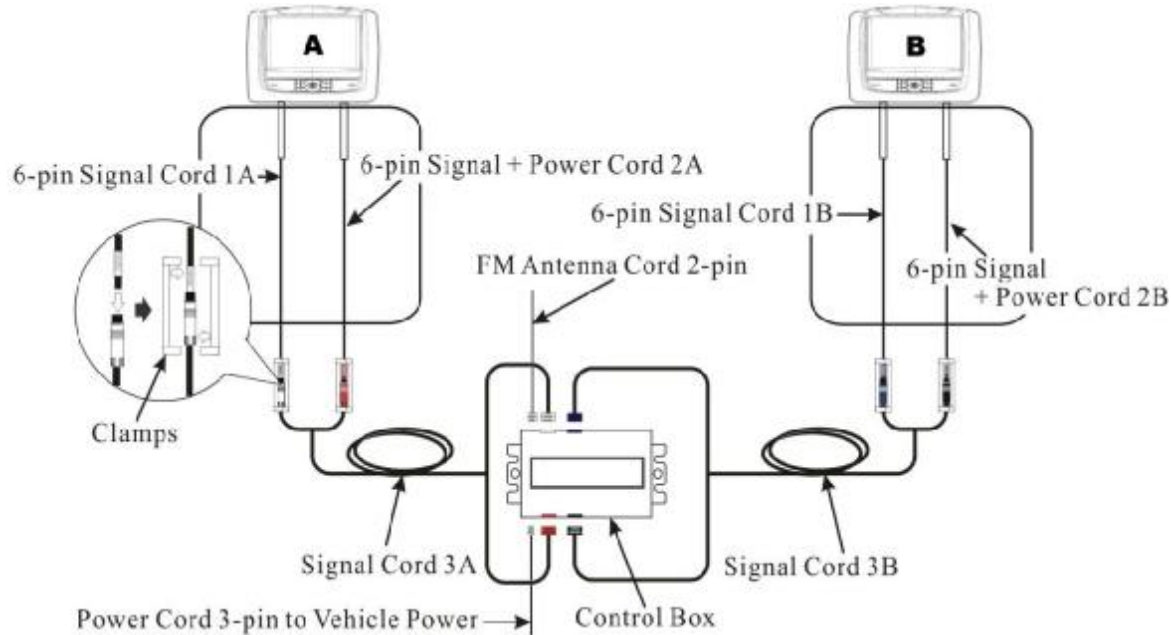

## Functional Verification

Accessory Function Checks:		Look for:
<input type="checkbox"/>	Turn vehicle ignition to ON, depress power button on each headrest monitor.	Monitor should power on start up screen should appear on screen.
<input type="checkbox"/>	Insert disc into DVD player, press ENTER button on the remote control or LCD panel.	Disc should begin playing.
<input type="checkbox"/>	Listen with wireless headphones (be sure to set to channel "A" to listen to Monitor A and channel "B" to listen to Monitor B.	Audio should be heard through vehicle headphones.
<input type="checkbox"/>	Connect jumper cable from output Monitor A to inputs on Monitor B, and then press source button on Monitor B to "AV".	DVD in Monitor A should be displayed on Monitor B also.
<input type="checkbox"/>	Connect jumper cable from output Monitor B to inputs on Monitor A, and then press source button on Monitor A to "AV".	DVD in Monitor B should be displayed on Monitor A also.
<input type="checkbox"/>	Depress eject button on the remote control or LCD panel.	Disc should eject.
<input type="checkbox"/>	Turn on vehicle radio and set station to station per set on FM transmitter.	Audio from Monitor A should be heard through vehicle speakers.

## Control Description on the Front Panel

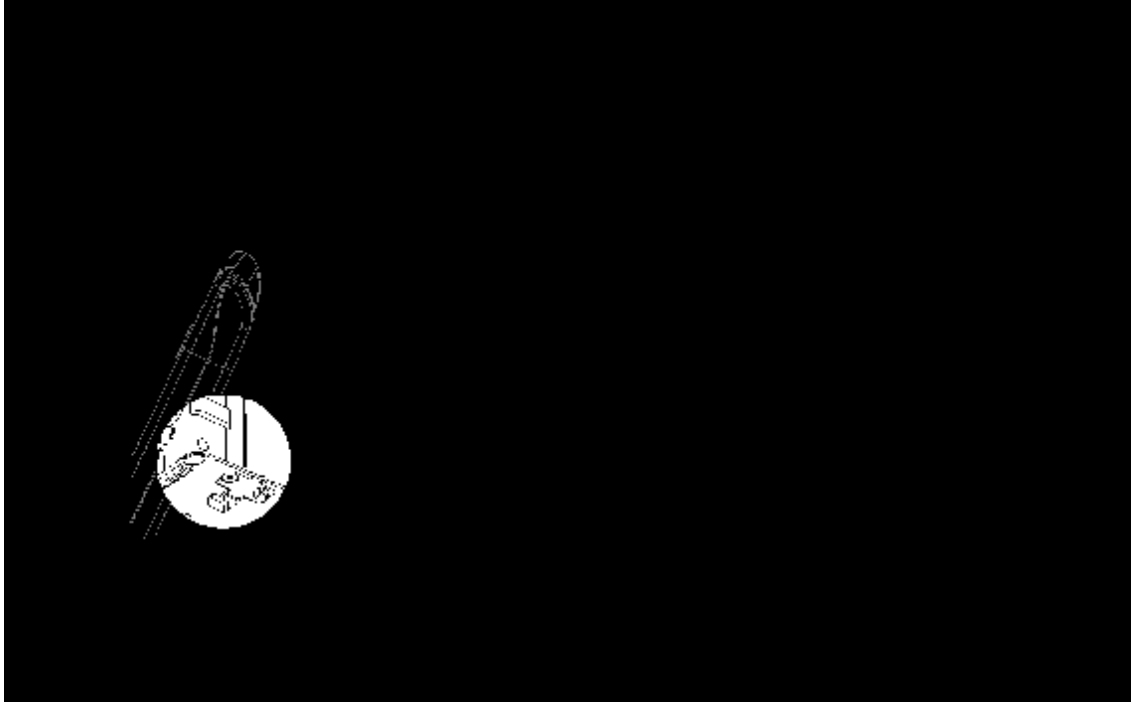

### **1. DVD Player Busy Light**

The busy light indicates the activity state of the DVD player.

### **2. DVD Compartment Slot**

Insert a disc to play.

### **3. IR Sensor - Forward Sensor Eye**

Allow the remote control to navigate the OSD ( On Screen Display) on the device and to control the other accessories.

### **4. Latch Tip**

Allow the user to adjust the viewing angle of the LCD panel.

### **5. TFT LCD Panel**

8-inch TFT LCD Panel (800x3 (RGB)x 480).

7-inch TFT LCD Panel (480x3 (RGB)x234).

#### **Warnings**

- Do not use any solvents or cleaning materials when cleaning the video device.
- Do not use any abrasive cleaners, they may scratch the screen. Use only a lightly dampened lint free cloth to wipe the screen if it is dirty.
- Lock the LCD screen in the fully closed position when not in use.
- Do not pull pressure on the screen.

- Caution children to avoid touching or scratching the screen, as it may become dirty or damaged.

### **6. USB 1.1 Port**

You can play videos, music, and images stored in a USB device such as USB-compatible stick memory or memory card reader, etc.

### **7. 1/8-inch AV Output Jack**

Allow CVBS signal being output for monitoring.

### **8. 1/8-inch Headphone Jack**

Allow plug-in of wired headphones with 1/8-inch stereo connector plug for monitoring the audio from the program.

### **9. AV Input Jacks (Yellow/White/Red)**

Connect using a cable (RCA connectors) from your infotainment device's video/audio output to the device's AV Input jacks.

### **10. Protection Cover**

Insert the protection cover into position when not in use.

### **11. Level Lock & Release Latch**

Allow the user to lock the LCD panel into the secure position.

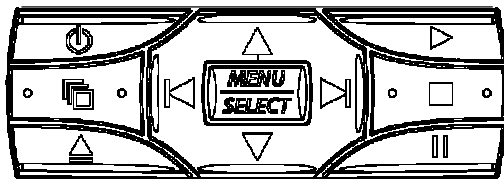

## 12. STOP/LEFT Button

This button function allows you to navigation the contents when enter DVD menu, besides this button is act as STOP function for DVD playback control.

## 13. POWER/SOURCE Button

- Switches device ON or to standby/on mode.
- This device is turned on by selecting a source. Press to cycle through all of the available sources.
- The device will turned off by press this button exceed over 3 seconds when the device on status.

## 14. SETUP/ENTER Button

This button is used for DVD control only, press this button to enter the DVD OSD setup menu when the SOURCE is in device itself DVD.

This button function will changed to ENTER when the DVD is running in the title menu or DVD OSD setup menu.

## 15. UP Button

Navigation button within DVD OSD menu.

## 16. PLAY/PAUSE/RIGHT Button

Press this button to switch sequentially between Playback and pause play, and navigation the DVD OSD menu.

## 17. EJECTL Button

Press this button to eject the disc from disc compartment or pull disc into the compartment.

## 18. DOWN Button

Navigation button within DVD OSD menu.



# Remote Control Operations

## Installing the Battery

Before attempting to operate your remote control, install the batteries as described below.

1. Turn the remote control face down. Press down on the ridged area of the battery cover and slide it off.
2. Install two “AAA” batteries as shown. Make sure that proper polarity (+ or -) is observed.
3. Slide the cover back until it clicks.

The remote control will operate this device. It is not a universal remote control and will not control other equipment.



## Warning/Caution on using Batteries

- Always ensure that the batteries are inserted with the positive and negative terminals in the correct direction as shown in the battery compartment.
- Different types of batteries have different characteristics. Do not mix different types.
- Do not mix old and new batteries. Mixing old and new batteries will shorten battery life and/or cause chemical leaks from the old batteries.
- When batteries fail to function, replace them immediately.
- Keep the batteries out of the reach of children. Should the batteries be swallowed, immediately consult a doctor. Also, when disposing of used batteries, please comply with governmental regulations or environmental public institution rules that apply in your country/area.
- Remove the batteries if the remote control is not used for a month or longer.

## Button Function Descriptions

### 1. SOURCE

Any video equipment connected to the audio/video inputs can be used with the monitor by pressing this button. Each time the button is pressed, the audio/video source will change in the following sequence: Monitor A→Monitor B→AUX→TV.

### 2. POWER

Press the button to turn the DSLM7AA1/DSLM7AB1 device on. The current video source will be displayed on the screen, and the picture will appear in a few seconds. Press the button again to turn the device off.

### 3. DVD-Monitor A

Transmit IR codes for DVD mode of MONITOR A.

### 4. TV-Monitor A (If TV mode is available)

Transmit IR codes for TV mode of MONITOR A.

### 5. SOUND AROUND ON/OFF (If available)

Turn the FM transmitter ON/OFF.

### 6. MUTE (for DVD only)

Press the button to shut off the sound transmitted to the headphone stations. The screen will display that the sound has been turned off. Pressing the button again restores sound to the previously set level.

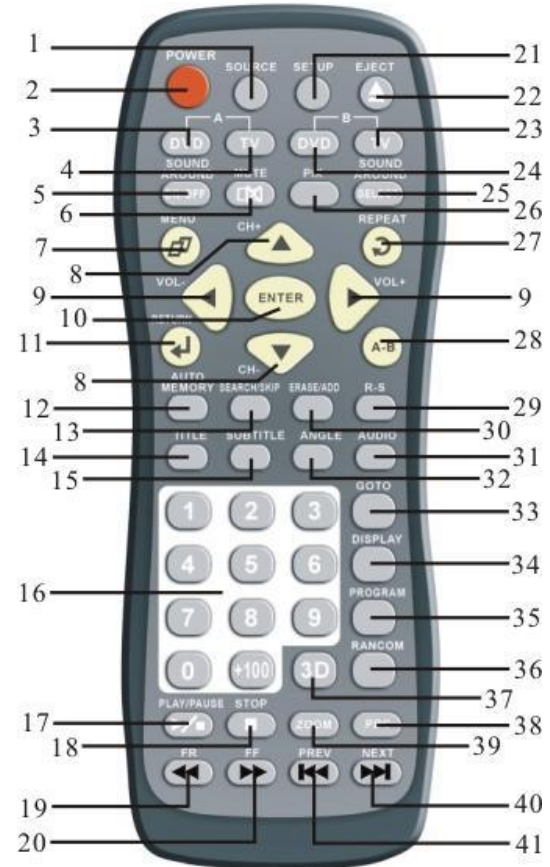

## **7. MENU**

Press the button to go to the Root Menu included on the disc.

## **8. UP, DOWN**

For DVD: Navigation button, you can use this button to move the select bar to one of items among the menu or file list.

For TV: Use these buttons to advance to the next higher or lower channel.

For OSD: Increase or decrease the setting of selected item.

## **9. LEFT, RIGHT**

Navigation button, you can use this button to move the select bar to one of items among the menu or file list.

## **10. ENTER**

Makes a selection or begins playback of the disc.

## **11. RETURN**

Return to the previous menu screen or resumes disc playback.

## **12. AUDIO MEMORY (If TV mode is available)**

When the AUDIO MEMORY button is pressed, all channels in TV mode are searched and tuned; all the channels with signals that are detected are automatically stored.

## **13. CH-SEARCH/SKIP (If TV mode is available)**

This button selects between SEARCH and SKIP modes. SKIP mode, the TV only stops on channels that are programmed into memory when the UP/DOWN buttons are used. When the SKIP mode is off, TV will stop on all active channels.

## **14. TITLE**

Navigate the Title menu included in the disc.

## **15. SUBTITLE**

Press this button. If the current disc has different subtitles options, this now appears on the screen.  
Press this button repeatedly until you have reached your desired subtitles option.

## **16. Numbers**

Decimal number: 0 to 9; and +100: Add 100.

## **17. PLAY/PAUSE**

While playing, press this button once to pause the playback, press the button again to resume the playback.

## **18. STOP**

Stop playing the movie or songs.

STOP→PLAY: Resumes disc playback.

STOP→STOP→PLAY: Resumes from the beginning of the disc.

## **19. FR (Fast Rewind)**

Press this button to search disc backward continuously. There are 5 speed options to choose: 2X, 4X, 8X, 16X, and 32X.

## **20. FF (Fast Forward)**

Press this button to search disc forward continuously. There are 5 speed options to choose: 2X, 4X, 8X, 16X, and 32X.

## **21. SETUP**

Navigate the Setup Menu. The following 4 pages are used to configure the system: General Setup Page; Audio Setup Page; Preference Page; and Password Setup Page.

## **22. EJECT**

Eject the disc from the disc compartment or load the disc into the disc compartment.

**23. TV-Monitor B** (If TV mode is available)

Transmit IR codes for TV mode of monitor B.

**24. DVD-Monitor B**

Transmit IR codes for DVD mode of monitor B.

**25. SOUND AROUND SELECT** (If available)

Select a FM transmitter channel. There are 6 channels:

CH1: 88.3MHz; CH2: 88.7MHz; CH3: 89.1MHz; CH4: 89.5MHz; CH5: 89.9MHz; CH6: 90.3MHz.

**26. PIX** (Picture Selection)

Each time the button is pressed, the picture adjustment OSD, cycles through bars for BRIGHTNESS, CONTRAST, SATURATION, HUE, SHARPNESS, IR HEADPHONE, and RESET. Once the desired adjustment bar is displayed, use the UP/DOWN button to adjust the setting. The bar display will automatically disappear, if no adjustments are made within 6 seconds or if any button is pressed.

**27. REPEAT**

Press this button to switch the repeat mode by “ALL”, “TITLE”, “CHAPTER” and cancel the repeat mode while playing DVD-video. Others disc type such as VCD, CD, and SVCD that only has “TRACK” and “ALL” two repeat mode can be selected.

Note: The both repeat function of VCD and SVCD need to turn the PBC status to ON then available.

**28. A-B** (Expect MP3)

Repeat from point A to point B.

**29. R-S** (If TV mode is available)

The button selects between Air TV and CATV modes.

**30. ERASE/ADD** (If TV mode is available)

When tuned to a channel, press the button to store or erase the channel from memory. The stored channel numbers are displayed in green on the screen, and the non-stored channel numbers are in

red. When the SKIP mode is on, the device will be tuned to only the stored channels when using the UP/DOWN buttons.

### **31. AUDIO**

Press this button. If the current disc has different language options, this now appears on the screen. Press this button repeatedly until you have reached your desired language option.

### **32. ANGLE**

View with a different camera angle (The button takes effect only on the DVD that supports frames with multiple angles). Press this button repeatedly until you have reached your desired viewing angle.

### **33. GOTO**

For the DVD, press this button can enter the menu to set the Title/Chapter/Audio/Subtitle/Angle/Title Time/Chapter Time/Repeat Mode/Time display mode while normal playing.

For the SVCD and VCD, press this button can enter the menu to set the Track/Disc Time/Track Time/Repeat Mode/Time display mode while normal playing.

### **34. DISPLAY**

Show information on the screen including title, chapter/track, time elapsed, and time remaining, or turn off the display.

### **35. PROGRAM**

Edit a playback program containing desired titles in the DVD or tracks in the CD-DA.

### **36. RANDOM**

Play titles randomly.

### **37. 3D**

Press this button to setting of audio effect for the following audio options.

DVD mode: Off, Rock, Pop, Live, Dance, Techno, Classic, and Soft.

CD mode: Off, Concert, Living Room, Hall, Bathroom Cave, Arena, and Church.

**38. PBC (Video CD only)**

Turn the PBC (Play Back Control) on or off.

**39. ZOOM**

Enlarge the picture in the movie by **2x**, **3x**, and **4x**, or  
Shrink the picture in the movie by **1/2x**, **1/3x**, and **1/4x**.

**40. NEXT**

When a disc has more than one Chapter, Track, or File, you can move to another Chapter/Track/File. Press the button briefly during play to select the next Chapter for DVD-video or Track/File for VCD, SVCD, MP3, CD, etc.

**41. PREV**

When a disc has more than one Chapter, Track, or File, you can move to another Chapter/Track/File. Press this button briefly during play to step back to the previous Chapter for DVD-video or Track/File for VCD, SVCD, MP3, CD, etc.

**Note:**

The remote control incorporate an infrared sensor which relays signals from the remote control to be controlled simply by pointing its remote control at the remote sensor eye. This provides control of auxiliary equipment such as an video DVD player. The infrared sensor can relay signals from any manufacturer's remote control to its respective component connected to the AUX input, such as a DVD player. In this case you must use the remote control supplied with the device.

# General Operating Instructions

## Turning the Device ON or OFF

1. Pivot the screen downward until a comfortable viewing angle is reached.
2. Pressing the **POWER** button on the lower-left corner of the front panel or the remote control will turn the device on or off. When in use, the controls will be lit.
3. After the device has been turned on and is displaying a picture, adjust the viewing angle by pivoting the screen to optimize the picture quality.
4. **Remember** to turn the device off and pivot the LCD panel to the lipped position when not in use.

## Channel Tuning Setup (If TV mode is available)

In order to easily access all available TV channels, it may be necessary to perform channel auto-programming whenever the vehicle's geographic location has changed i.e. city to city, weak signal area.

1. Press the **AUTO MEMORY** button on the remote control unit or the **AUTO PROGRAM** button on the drop-down video unit. You will see the TV cycling through all its channels. The built-in microprocessor will automatically note each channel that is actively broadcasting in your area.
2. (A) To tune only strong clear channels with the channel **UP/DOWN** buttons, press the **SKIP/SEARCH** buttons on the remote control unit until "SKIP MODE ON" is displayed on the bottom of the screen. The TV will now tune only to strong active channels when the **UP** or **DOWN** buttons are used on the monitor or remote control.
3. (B) To tune weak or marginal channels with the channel **UP/DOWN** buttons, press the **SKIP/SEARCH** buttons on the remote control unit until "SKIP MODE ON" is displayed on the bottom of the screen. Tune to the desired channel using the **UP** or **DOWN** buttons or go directly to the channel by using the **0-9** buttons on the remote control.
4. To erase a channel, press the **ERASE/WRITE** buttons on the remote control unit until "MANUAL MEMORY XX ERASE" is displayed on screen. To store a channel, press the buttons until the "MANUAL MEMORY XX ADD" is displayed on screen.



## DVD Basic

To get the most use out of each DVD, make sure you read this section completely.

### Regional Coding

Both the DVD player and disc are coded by region. These regional codes must match in order for the disc to play. If the codes do not match, the disc will not play. The system's code may be region 1. Other regional may not be played in this system.

### Type of Discs your DVD will Play

DVD-Video: DVD contains video.

CD-DA: CD contains musical or sound content only.

CD-Video: CD contains movie only.

CD-R/RW: A disc that contains audio files (for example, a CD-R with downloaded MP3 files), MPEG, or JPEG files.

### Loading and Playing Discs

Before you load a disc, make sure that it is compatible with the player. Note that the following discs

**CANNOT** be used with this player:

Optical disc- CD-1, CD-ROM, and DVD-ROM

Mini disc- CDG (audio only, not graphics)

### To Load and Play a Disc

When you press the **POWER** button the system on and in DVD mode. Put the disc's printed-side facing rear of vehicle into the disc compartment about halfway into the slot. The disc will loaded automatically and begin to play .

(Some discs may start at the root menu, where play must be selected to start movie.)

Depending on the disk and playback location on the disc, the icon  may be displayed in the upper-left corner of the screen indicating that still playback is not possible.

## Notes on Discs

- To keep a disc clean, do not touch its surface. Handle the disc by its edge.
- Keep your discs in their cases or disc magazines when not in use. Also, do not subject disc to heat/high temperature. Avoid leaving them in a parked vehicle or on a dashboard/rear tray.
- Do not attach labels, or use discs with sticky ink/residue. Such discs may stop spinning when used, causing a malfunction, or may ruin the disc.

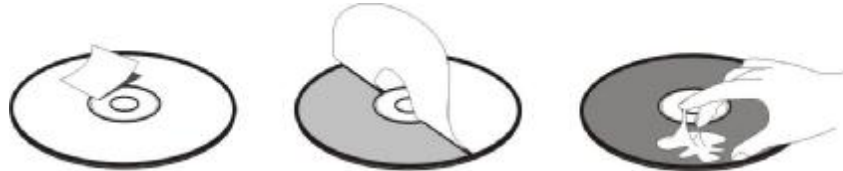

- Do not use any discs with labels or stickers attached. The following malfunctions may result from using such discs:
  - Inability to eject a disc (due to a label or sticker peeling off and jamming the eject mechanism).
  - Inability to read audio data correctly (e.g., playback skipping, or no playback) due to heat shrinking of a sticker or label causing a disc to warp.
- Before playing, clean the discs with a commercially available cleaning cloth. Wipe each disc from the centre out. Do not use solvents such as benzine, thinner, commercially available cleaners, or antistatic spray intended for analogue discs.
- Use only normal, round disk. If you insert irregular, non-round, shaped discs they may jam in the DVD player or not play properly.



## How to use the DVD OSD Menu

This section describes how to set and adjust using the on-screen setup pages included in the OSD Menu. You can use the OSD menu screen to adjust all the settings on your screen. Follow the steps outlined below to select the function you desire, and refer to the pages indicated for more information.

### Using the Setup Menu

Using the setup display that you can do the initial setup, adjust the picture quality, and set the various output. You can also set a language for the on-screen display, the setup display, and limit playback by children.

- (1) Press the **SETUP** button on the remote control will bring up the following Setup Menu on screen.
- (2) Press the < or > buttons to select the desired page on screen, choose functions or change settings.



### To Cancel using the Setup Display

Press the **SETUP** button on the remote control.

## General Setup Page

### Setting the Language for On-Screen Display

Press the **SETUP** button on the remote control, use the  $\langle \triangleright$  buttons to navigating to General Setup Page, then use the  $\surd$  buttons to select OSD Lang sub-menu.

### OSD (On Screen Display) Language Menu

The OSD Lang sub-menu allows the user to select the language for the on-screen display. Press the  $\triangleright$  button and then use the  $\surd/\triangle$  buttons on the remote control to select the desired language. The user can select either English, French, or Spanish for the OSD language.

### Setting for Display

Press the **SETUP** button on the remote control, use  $\langle \triangleright$  buttons navigating to General Setup Page, and then use the  $\surd$  button to select TV Display sub-menu. The setup allows you to adjust the screen setting (aspect ratio). Press the  $\triangleright$  and then use the buttons  $\surd/\triangle$  to select the appropriate setting. The options are as follows:

#### Normal/PS (Pan and Scan)

This displays the wide picture on the screen with a portion of the left and right sides removed.

#### Normal/LB (Letter-Box)

This displays the wide picture with black bands on the upper and lower portions of the screen.

#### Wide (16:9)

This option is choose if the LCD panel is of wide screen. Then press the **ENTER** button on the remote control to confirm the screen.



## Preference Page

### Default Setting

Press the **SETUP** button, and use the ◀▶ and ▼ buttons on the remote control to navigate to the Default sub-menu under Preference Page. The default setup allows you to reset all options to factory defaults. Press the ▶ button and then press **ENTER** button to carry out the reset. *Note: This function will not effect the parental setting.*

**Setting for Parental (Parental Control)** (Accessible only when no disc is loaded)

This section of the Setup Menu allows user to control the content of movie playback from **G** to **ADULT**. The parental control function allows you to limit viewing to your preference.

1. After navigating to the Parental sub-menu under the Preference Page, use the ▶ and ◀ buttons on the remote control to select: **KID SAF** (Children); **G**; **PG**; **PG 13**; **PGR**; **R**; **NC 17**; **ADULT**.

*Note: The lower the value, the more strict the limitation.*

2. Press the **ENTER** button on the remote control to confirm the selection.
3. Input a password in 6 digits using the numeric buttons and then press the **ENTER** button on the remote control. *Note: The default password is 136900.*

Note: If a disc is inserted into the DVD Compartment Slot and exceeds the Parental Setting, the following message appears on the screen:

**The Parental Settings of this player prohibits play.  
Would you like to allow this disc to play?**

If you select yes, the password must be entered for the disc to play. If wrong password is entered, the following message appears on the screen:

**This movie will not play due to the Parental Settings of the player.**



## Password Setup Page

### Setting for Password (Parental Control Password)

Press the **SETUP** button and navigate to the Password submenu under the Password Setup Page. The menu appears and allows you to change the parental control password. Press the **▷** button and then press the **ENTER** button on the remote control to entering the sub-menu.



### Old Password

Input the old password or the default password (4 digits).

### New Password

Input a new password (4 digits) using numeric buttons.

### Confirm PWD

Confirm the new password by entering the same new password again.

Then scroll to the OK button and press the **ENTER** button on the remote control. Your password has been changed.

*Note: The default password is 0000*



## Playing Audio CD

When playing an audio CD, the DISPLAY banner appears automatically. It displays the current track and the amount of the time that track playing, the total amount of time on the disc and the current time running on the disc. Press the **DISPLAY** button on the remote control to display the DISPLAY banner. The options below show you what happens when you press the **DISPLAY** button.

### Press **DISPLAY** (1x)

“Single Elapsed” appears along with the current track playing and the time of that track.

### Press **DISPLAY** (2x)

“Single Remain” appears along with the current track playing and the amount of time left.

### Press **DISPLAY** (3x)

“Total Elapsed” appears along with the current track playing and the total time playing on CD.

### Press **DISPLAY** (4x)

“Total Remain” appears along with the current track playing and the amount of time left on CD.

## Using the REPEAT Feature

The default mode for the REPEAT feature is OFF. Pressing **REPEAT** button on the remote control consecutively changes the REPEAT options as follows:

- **Track** - repeat the track that is playing.
- **All** - repeat the disc that is playing.

As you toggle through the options, the REPEAT option changes that time. The track repeats once that track has ended. The selected repeat option loops repeatedly until you turn it off.



## Playing MP3 Discs

MP3 is the format for storing digital audio. An audio CD-quality song can be compressed into the MP3 format with very little loss of quality, while taking up much less space. CD-R discs that have been encoded in MP3 format can be played on your DVD player. Press the **DISPLAY** button on the remote control to show DISPLAY Banner. The options below show you what happens when you press the **DISPLAY** button.

- Press DISPLAY (1x) “TIME REMAIN”

Appears along with the amount of time left in the song that is playing. “TIME REMAIN” and the time that is left remain on-screen until you press **DISPLAY** button again.

- Press DISPLAY (2x) “TIME ELAPSED”

Appears along with the amount of time the song that is played. “TIME ELAPSED” and the elapsed time will remain on-screen until you press **DISPLAY** button again.

- Press DISPLAY (3x) “OFF”

Appears screen along with the amount of time the song that is played. The time remains on-screen until you press **DISPLAY** button again to see the time left in the song that is playing.

### Selecting Folders and Songs

When an MP3 disc is inserted in the player, the navigation screen appears automatically. You can change folders and songs by navigating the file system. The DVD player plays the songs in the order they were burned to the disc.

1. If a disc is playing, press the **STOP** button on the remote control, and then press the **UP** or **DOWN** arrow buttons to go through the folder list on the left side of the navigation screen.
2. Once the folder you want is highlighted, press the **ENTER** button on the remote control (the folder list







shift to left side of the screen and the songs in the folder appear on the right).

3. Press the **UP** or **DOWN** arrow button on the remote control to go through the song list and highlight the song you want. Press the **ENTER** button to begin the playback of the highlighted song.

### Skipping Songs

Use the  (NEXT) button on the remote control to move to the next song. Use the  (PREV) button to move to the beginning of the currently playing song. Press the  button 2 times to move to the previous song.

### Selecting a Play Mode

You can choose what order the songs will play on a disc temporarily. The FOLDER play mode is the default. To access the play mode operations, press the **REPEAT** button on the remote control. The play mode options are as follows:

- **Single:** Play a selected song.
- **Repeat One:** Repeat the song that is playing.
- **Folder:** Play the folder in the order the songs were recorded.
- **Folder Repeat:** Repeat the folder that is playing.
- **Disc:** Play the entire disc.
- **Disc Repeat:** Repeat the disc that is playing.
- **Random:** Play the songs in the random order.
- **Shuffle:** Play the songs in random order (within the selected folder).



## How to use the Device OSD Menu

### Picture Adjustment

This section describes how to set and adjust using the on-screen in the device OSD Menu. You can use the device OSD menu screen to adjust advanced picture selections on your screen.

- Press the **PIX** button by continuously hitting on the remote control to select the BRIGHTNESS, CONTRAST, SATURATION, HUE, SHARPNESS, IR HEADPHONE, RESET options to adjust value and setting.
- After selecting the desired option, and use the  $\triangle$  or  $\nabla$  buttons to adjust the setting.



Option	Description	Range	Default	
			7-inch	8-inch
Brightness	Adjust to brighten or darken the picture.	0-100	47	50
Contrast	Adjust to increase or decrease picture contrast.	0-100	44	51
Saturation	Adjust to increase or decrease color intensity.	0-100	50	55
Hue	Adjust to increase or decrease the green tones.	0-100	50	50
Sharpness	Adjust to sharpen or soften the picture.	0-100	38	38
IR Headphone	Select to turn on or off IR headphone function.	ON or OFF	ON	
Reset	Resets the current settings to default values.			

## Technical Specification

---

Dimensions	SLIMLINE SSLM7A: 204.90(W)x160.18(H)x57.62(D) mm SLIMLINE SSLM8A: 232.76(W)x180.63(H)x57.88(D) mm
Weight	SLIMLINE 7A: 1.26Kg SLIMLINE 8A: 1.55Kg
Power Consumption	Operation <16W (max.)/SSLM7A, <15.6W (max.)/SSLM8A Standby <1.5W (max.)/SSLM7A, <1.5W (max.)/SSLM8A
LCD Backlight	LED
Resolution	480x3(RGB)x234 for 7-inch TFT LCD Panel 800x3(RGB)x480 for 8-inch TFT LCD Panel
Luminance	400cd/m <sup>2</sup> (min.)
DVD	Slim Type Slot-In Loader
Supported Disc	DVD (Single, Dual Layer), DVD-R/+R, DVD+R Dual layer, DVD-RW/+RW, CD, CD-R, CD-RW
Supported Format	DVD-Video Navigation Ver1.0, VCD Ver1.0/2.0, SVCD, CD-DA, Data (MP3, WMA, JPEG, MPEG 1/2/4, Divx)
Source	Internal DVD, CD, USB Flash Memory (USB play MP3, JPEG only)
Operation Temperature/Humidity	0°C~60°C/20~90% RH
Storage Temperature/Humidity	-20°C~70°C/5~95% RH
Expected Backlight Lifetime	10,000 hours
Video Display System	NTSC/PAL

Supply Input Voltage	10V~16V DC
Maximum Input Current	1.3A $V_{in}= 10V$ DC (DSL7A) 1.56A $V_{in}= 10V$ DC (DSL8A)
Frequency Response	20Hz~20KHz $\pm 1$ dB
Signal/Noise Ratio	$\geq 85$ dB
Audio Distortion	$\leq 0.02$
Acoustic Noise	40dB
Control Button on the Front Panel	POWER/SOURCE, STOP/LEFT, UP, SETUP/ENTER, PLAY/PAUSE/RIGHT, EJECT, and DOWN
I/O Ports	USB 1.1 Port, 1/8" AV Out Jack, 1/8" Headphone Jack, AV In RCA Jacks
Audio Out (analog audio)	Output Level: $2V \pm 10\%$
Load Impedance (Audio Out)	10K $\Omega$
Video Out Output Level	1Vp-p $\pm 20\%$
Load Impedance (Video Out)	75 $\Omega$
FM Reception	6 odd channels (Software Command Control to Control Box)
Wireless Audio	Dual channel infrared audio transmitter, Support IR receiver stereo headphone (reception: 0.9 m; 80°, 1.8 m; 50°)

---

## Troubleshooting

If it appears that the device is faulty, first consult this checklist. It may be that something has been overlooked.

Symptom	Remedy
Device does not power “ON”	<ul style="list-style-type: none"><li>• Check if both plugs of the main cord are properly connected.</li><li>• Is ignition turned “ON”?</li><li>• Are batteries installed in remote control?</li></ul>
IR sensor inoperative	<ul style="list-style-type: none"><li>• Verify that the batteries in the remote control are fresh.</li><li>• Verify that the remote sensor eye is not obstructed.</li><li>• Verify that the infrared transmitter is affixed over the sensor eye of the component to be controlled.</li></ul>
Poor in vehicle radio reception (FM modulator installed)	<ul style="list-style-type: none"><li>• Check the condition of the vehicle’s radio antenna.</li><li>• Verify that the antenna is fully raised.</li><li>• If a wired RF modulator has been installed, verify that it is turned on by using remote.</li></ul>
Disc won’t play	<ul style="list-style-type: none"><li>• Insert a disc with label side rear of the vehicle.</li><li>• Check if the disc id defective by trying another disc.</li><li>• Check the type of disc you put into DVD compartment slot. This DVD player only plays DVDs, audio CDs, and MP3s.</li><li>• Both the device and the disc are coded by region. If the regional codes don’t match, the disc can’t be played. The DVD play is region number 1.</li></ul>
Play starts, but then stops immediately	<ul style="list-style-type: none"><li>• The disc is dirty and then cleaning it.</li><li>• Condensation has formed. Allow player to dry out.</li></ul>

No picture	<ul style="list-style-type: none"> <li>• Check that the signal source is connected.</li> <li>• Check that the setting may be in the wrong status. Match your source selected correctly.</li> <li>• Contact the service department.</li> </ul>
Distorted picture	<ul style="list-style-type: none"> <li>• Check the disc for fingerprints and clean with a soft cloth, wiping from center to edge.</li> <li>• Sometimes a small amount of picture distortion may appear. This is not a malfunction.</li> </ul>
Cannot advance through a movie	<ul style="list-style-type: none"> <li>• You cannot advance through the opening credits and warning information that appears at the beginning of movies because the disc is programmed to prohibit that action.</li> </ul>
No sound or distorted sound	<ul style="list-style-type: none"> <li>• Make sure that the DVD player is connected properly, and all cables are securely inserted into the appropriate jacks.</li> <li>• If you are using the IR headphones, make sure you turn on the IR power.</li> <li>• Make sure the FM modulator is on and the proper frequency has been selected.</li> <li>• Is volume turned “UP” on headphones?</li> <li>• Is anything blocking signal between monitor and headphones?</li> </ul>
Player does not respond to all operating commands during playback	<ul style="list-style-type: none"> <li>• Operations are not permitted by the disc.</li> <li>• Refer to the instructions in the disc inlay.</li> </ul>
Device feels warm	<ul style="list-style-type: none"> <li>• When the device is in use for a long period of time, the surface will heated. This is normal.</li> </ul>

## WEEE Notice

**Disposal of Old Electrical & Electronic Equipment (Applicable in the European Union and other European countries with separate collection systems).**



This symbol on the product or on its packaging indicates that device shall not be treated as household waste. Instead it shall be handed over to the applicable collection point for the recycling of electrical and electronic equipment. By ensuring this device is disposed of correctly, you will help prevent potential negative consequences for the environment and human health, which could otherwise be caused by inappropriate waste handling of this device.

The recycling of materials will help to conserve natural resources. For more detailed information about recycling of this device, please contact your local city office, your household waste disposal service or the shop where you purchased the device.

Applicable accessory: remote control.