

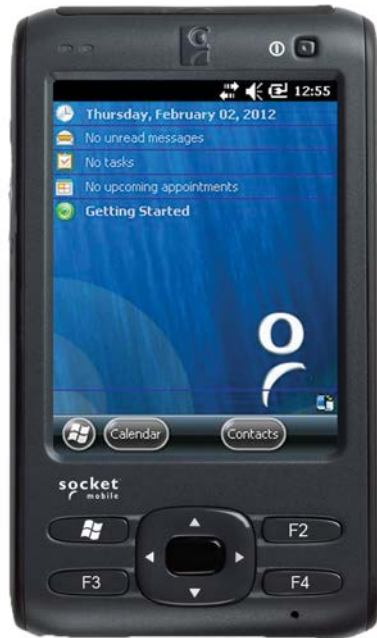

# USER'S GUIDE

SOMO<sup>®</sup> 655

HANDHELD COMPUTER



**COPYRIGHT NOTICE**

Copyright © 2008-2012 Socket Mobile, Inc. All rights reserved.

Socket, the Socket logo, SoMo, SocketCare, SocketScan, Connect!Agent, and Wi-Fi Companion are trademarks or registered trademarks of Socket Mobile, Inc. *Bluetooth* and the *Bluetooth* logos are registered trademarks owned by *Bluetooth* SIG, Inc., U.S.A. and licensed to Socket Mobile, Inc. Wi-Fi and the Wi-Fi logo is a registered trademark of the Wi-Fi Alliance. Windows Mobile is a trademark of the Microsoft group of companies. All other brand and product names are trademarks of their respective holders.

The SoMo 655 includes technology licensed under European Community Registered Design Nos. 000745245-0001, 000745245-0002 and 000745245-0003.

Reproduction of the contents of this manual without the permission of Socket Mobile is expressly prohibited. Please be aware that the products described in this manual may change without notice.

Feel free to contact Socket Mobile at:

**Socket Mobile, Inc.**  
39700 Eureka Drive  
Newark, CA 94560-4808  
USA

[www.socketmobile.com/contact](http://www.socketmobile.com/contact)

Other than the above, Socket Mobile can assume no responsibility for anything resulting from the application of information contained in this manual.

Please refrain from any applications of the SoMo 655 that are not described in this manual. Please refrain from disassembling the SoMo 655. Disassembly of this device will void the product warranty.

You can track new product releases, software updates and technical bulletins by visiting the Socket Mobile website at: [www.socketmobile.com](http://www.socketmobile.com)



## IMPORTANT SAFETY INSTRUCTIONS

Please read and follow these safety instructions before using your device for the first time, and save them for future reference.

- Keep away from extremely hot, cold or humid conditions.
- Avoid using in dusty environments.
- Do not allow the device to get wet.
- Avoid strong force, shock or vibrations.
- Do not open your device. Any attempts to open this device will void the warranty.
- Do not place objects on top of the device.
- Avoid removing the battery without turning off the device.
- Do not charge the device in extremely hot or cold conditions.
- Please only use the supplied USB synchronization cable.
- Please do not use other chargers or AC adapters, as these may damage your device.
- Do not remove MSD/MMC or CF cards while they are being accessed.
- Do not use this device in damp, wet or rainy conditions.
- Do not insert metal objects into the sync/charging port of the SoMo.
- Keep the SoMo and its accessories away from children.

# Table of Contents

1   Introduction.....	7
Ready to Customize.....	7
Power Management Software .....	8
Package Contents.....	8
Product Registration .....	8
Socketcare™ Extended Warranty.....	9
Socket Third-Party Accessories Recommendation (STAR) .....	9
Synchronization Software .....	9
Hardware Features.....	10
2   Getting Started .....	14
STEP 1: Install the Battery .....	14
STEP 2: Charge the Battery .....	15
STEP 3: Set up your SoMo 655 .....	16
STEP 4: Install Synchronization Software on Host PC .....	17
STEP 5: Connect to Host Computer.....	17
STEP 6: Set Up Your Device Partnership .....	19
3   Using the SoMo 655 .....	30
Stylus .....	30
<b>A/B Mode Switch</b> .....	30
Start Menu .....	31
Online Help .....	31
Wireless Radio Manager .....	32
<b>SoMo 655 Power Plus Battery Friendly® Utility</b> .....	34
Backlight and Power Settings.....	36
CPU Performance Utility .....	37

Voice Recorder .....	38
Adding a USB Keyboard/Mouse .....	38
4   Wi-Fi Companion .....	39
Additional Documentation .....	39
Useful Links .....	40
Turning on the Wi-Fi Radio .....	40
Main Screen of Wi-Fi Companion .....	42
Wi-Fi Status Icon .....	42
Wi-Fi Finder .....	43
Finding and Connecting to a WLAN.....	44
5   Socketscan 10 for CHS Series 7 Barcode Scanners .....	47
Additional Documentation .....	47
Useful Links .....	47
Socketscan 10 Icons .....	47
STEP 1: Charge the CHS .....	48
STEP 2: Install Socketscan 10 .....	48
STEP 3: Pair the CHS with the SoMo .....	49
STEP 4: Start Application .....	50
STEP 5: Scan Barcodes.....	50
6   Socketscan Plug-In for Scanners and Readers .....	51
STEP 1: Assign a Trigger Button.....	52
STEP 2: Start Socketscan .....	53
STEP 3: Insert the Card.....	54
STEP 4: Start Application .....	54
STEP 5: Scan or Read Data .....	54
Appendix A Specifications .....	55

Specifications .....	55
Appendix B Care and Maintenance.....	58
Cleaning the SoMo 655 or SoMo 655DXS:.....	58
Cleaning the SoMo 655Rx (antimicrobial version):.....	58
Carrying or Storing the SoMo:.....	58
Appendix C Resetting the SoMo 655.....	59
Soft Reset .....	60
Hard Reset.....	61
Appendix D Upgrading the ROM Image.....	64
Appendix E Troubleshooting .....	67
Appendix F Technical Support.....	68
Online Knowledge Base:.....	68
Online Requests: .....	68
By Phone: .....	68
Limited Warranty .....	69
Disclaimer.....	70
Limited Software Warranty.....	70
Regulatory Compliance .....	71
<b>FCC Interference Statement (USA)</b> .....	71
<b>Industry Canada Statement:</b> .....	72
<b>European Union Notice:</b> .....	72

# 1 | Introduction

Thank you for purchasing the SoMo 655 handheld computer. The SoMo 655 is a durable, Windows Mobile powered device that can help your business increase the productivity of mobile workers, improve the visibility of data in the field, and automate manual processes.



There are multiple configurations to suit different types of applications:

Model	Configuration	Target Industry
SoMo 655	Standard	Various
SoMo 655Rx	Antimicrobial with Extended Battery	Healthcare
SoMo 655DXS	Radio-free (No <i>Bluetooth</i> or Wi-Fi) and no microphone	Government/high-security applications

## Ready to Customize

The SoMo 655 can be deployed out of the box with a wide range of Socket or third-party peripherals because it comes pre-loaded with the following software:

Socket/Third-Party Peripheral	Pre-loaded Software
Socket CHS v3 <i>Bluetooth</i> barcode scanners	SocketScan™ 10 keyboard wedge software
Socket barcode, RFID and magnetic stripe readers (plug-in cards, CRS, CHS v2)	SocketScan™ keyboard wedge software Connect!Agent <i>Bluetooth</i> software <sup>1</sup>
Socket 56K Modem Cards	Modem Utilities
Socket 10/100 Ethernet Card	Ethernet Utilities
Socket SoMo 655 Back Pack wireless broadband ExpressCard adapter	Drivers, utilities
UIC UIC683 contactless/mag stripe card reader	SocketScan keyboard wedge software
SocketSerial Serial I/O Card, Shielded USB-to-Serial Adapter, USB Ethernet Gigabit Adapter	Drivers



Socket also offers a wide range of accessories for the SoMo 655, including screen protectors, Four-Bay Chargers, and more: <http://www.socketmobile.com/products/>

<sup>1</sup> For Windows Mobile 6 Service Pack 8 or later, Connect!Agent software is pre-loaded but not installed.

## Power Management Software

The SoMo 655 features the following power management software so you can optimize battery life according to your performance needs:

Software	Description
Socket Power Plus Battery Friendly® utility	Performance optimization, analysis and troubleshooting utility
Socket CPU Performance utility	Processor performance optimization utility
A/B Mode Switch utility	Configuration utility for A/B Mode switch

## Package Contents

All SoMo 655, SoMo 655Rx, and SoMo 655DXS configurations come with the following items:

- SoMo 655 handheld computer
- Lithium-ion battery
- USB sync cable
- AC adapter
- USB power cable
- 2 rubber screw caps
- Quick Start Guide

## Product Registration

Socket highly recommends that all customers register their products. Warranty is valid only if Product is registered within 30 days of purchase. Registered users benefit from access to technical support, free service packs and other updates for the SoMo 655. Register online at: <http://support.socketmobile.com/>

Alternatively, use the Getting Started wizard for SoMo registration. In the Today screen, tap **Getting Started**.



## Socketcare™ Extended Warranty

SocketCare is an enhanced service program, purchasable from an Authorized SocketCare Reseller within 30 days of your SoMo purchase. Program features include:

- Faster turnaround for product repair, replacement, and support
- Exclusive access to technical support

For a list of Authorized SocketCare Resellers, please visit: <http://www.socketmobile.com/support/socketcare>

## Socket Third-Party Accessories Recommendation (STAR)

The **STAR Program** assembles third-party accessories that have been tested for compatibility with Socket products. Find featured products including keyboards, smart card readers, cases, and more at:

<http://ww1.socketmobile.com/products/star.aspx>.

The SoMo comes pre-loaded with software for STAR products from UIC and SocketSerial.

## Synchronization Software

Before you start using your new SoMo 655, install **Windows Mobile Device Center** synchronization software on your PC. For the most current version, go to

<http://www.microsoft.com/windowsmobile/devicecenter.mspx> for a free download.

# Hardware Features

## Front

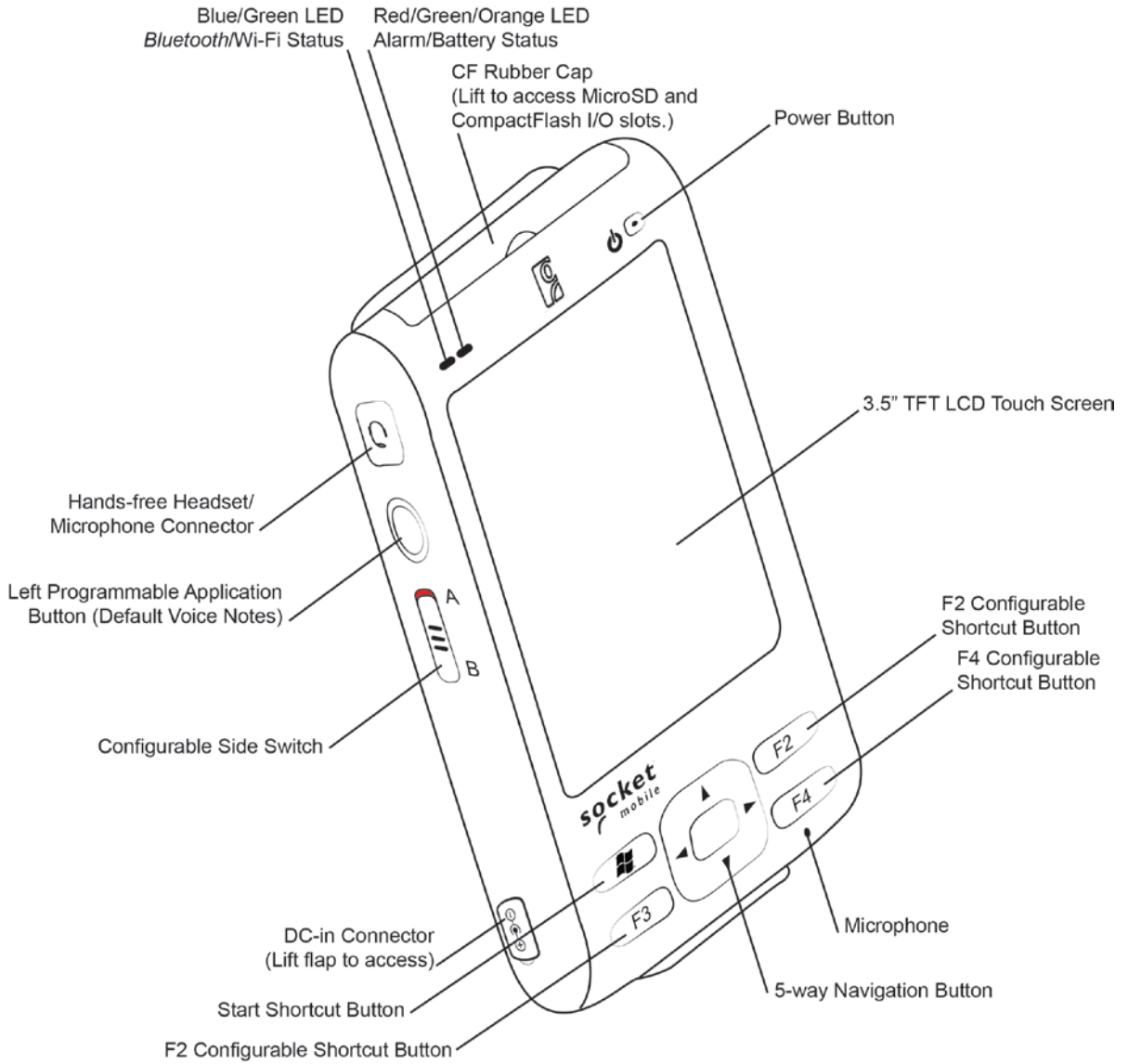

## Back

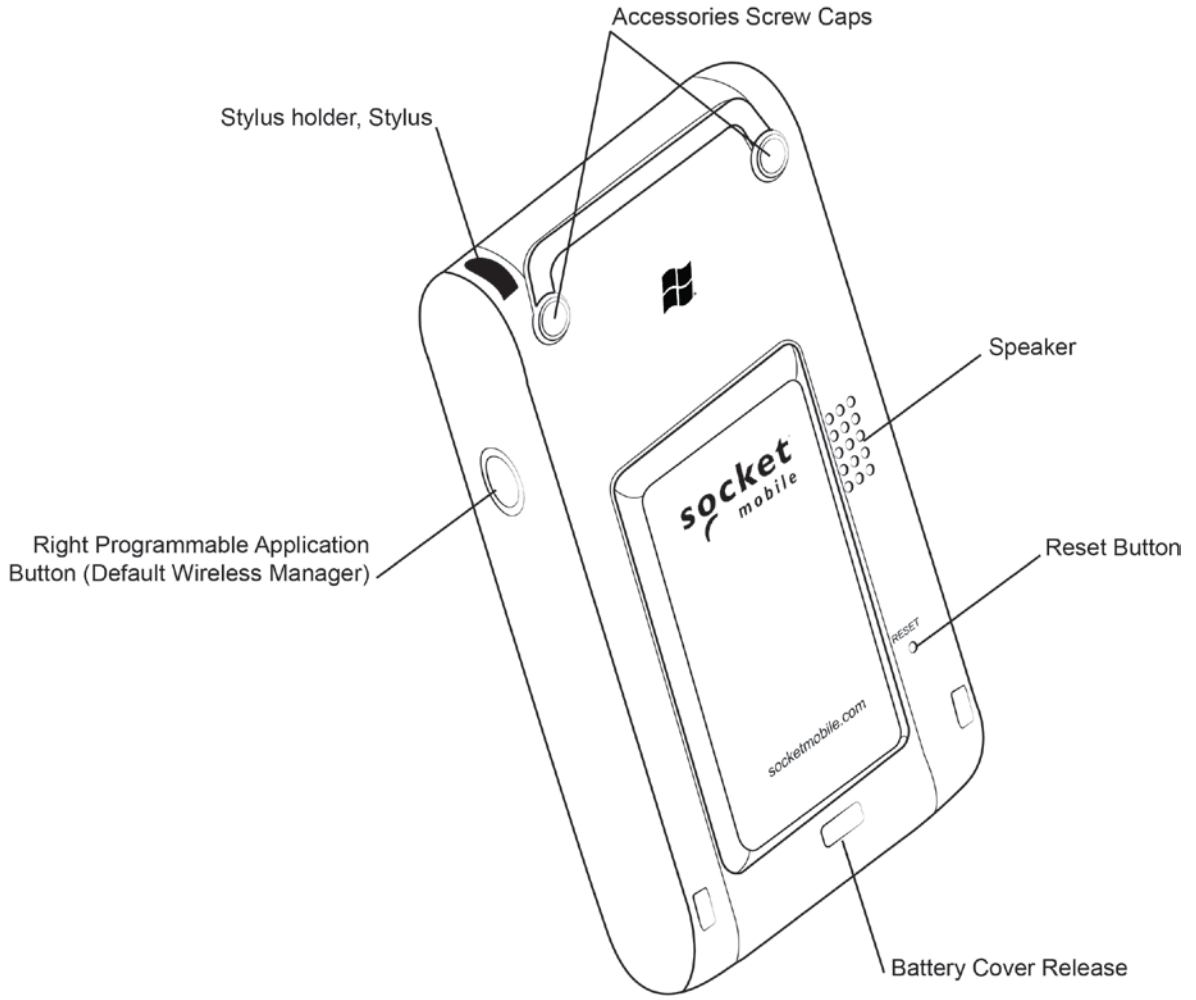

## Bottom

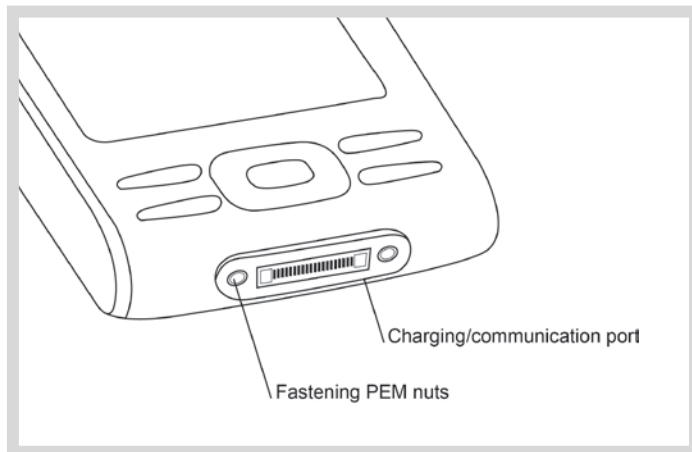

## Bluetooth/Wireless Status

### Blue/Green LED (*left*)

LED Behavior	Meaning
Flashing blue	Bluetooth radio is on
Flashing green	Wi-Fi radio is on
Flashing blue and green	Bluetooth and Wi-Fi radios are on
OFF	Wireless radios are OFF or unit is in suspend mode

## Alarm/Battery Status

### Red/Green/Orange LED (*right*)

LED Behavior	Meaning
Flashing red	Alarm or Low battery notification: <20% charge remaining for 1200 mAh battery <15% charge remaining for 2600 mAh battery
OFF	Running on battery power or device powered off
Solid red light when connected to charger	Charging battery
Solid green light when connected to charger	Battery is fully charged
Flashing orange	Battery data is unavailable

SoMo Behavior Under Low Battery Conditions	Remaining Charge for 1500 mAh Battery	Remaining Charge for 2600 mAh Battery
Low Battery Alert in title bar of Today screen and flashing red LED	20%	15%
Critical Battery Alert in title bar of Today screen and flashing red LED	10%	5%
SoMo will shut down to preserve data until the battery charged. The SoMo should be able to maintain a standby state for 160 hours.	5%	3%



To determine the battery life of the SoMo with your application, please visit:

<http://www.socketmobile.com/products/handheld-computer/BatteryEstimator/index.html>

To learn about SoMo battery best practices, please visit:

[http://ww1.socketmobile.com/Libraries/Documents/Battery\\_Best\\_Practices.sflb.ashx](http://ww1.socketmobile.com/Libraries/Documents/Battery_Best_Practices.sflb.ashx)

[http://support.socketmobile.com/FrontLinesGlobalSupport\\_Socket\\_Ext/SocketMobile/Attach/Answer3-0-34\\_CS1006%20%20Socket%20Customer%20Notice%20%20Batteries%20discharging%20quickly%20200100524.pdf](http://support.socketmobile.com/FrontLinesGlobalSupport_Socket_Ext/SocketMobile/Attach/Answer3-0-34_CS1006%20%20Socket%20Customer%20Notice%20%20Batteries%20discharging%20quickly%20200100524.pdf)

## Charging/Sync Cradle

With two USB ports, the cradle can act as a hub to connect a keyboard, mouse or other device. There is a compartment for charging a spare battery, which can be charged at the same time as a SoMo.

**Front**

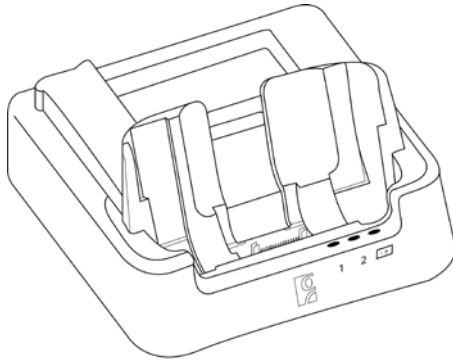

**Back**

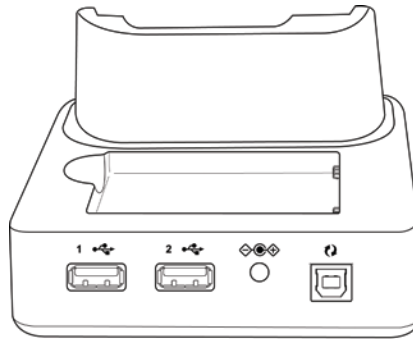

*If your SoMo does not include a cradle, you can buy one at:*

<http://ww1.socketmobile.com/products/handheld-computers/accessories-hc.aspx?cat=Charging>

*Socket offers a broad range of charging accessories for the SoMo, including durable charging cradles, four-bay chargers, car chargers, and more.*

*Certain USB devices may require additional software or drivers.*

***The cradle for the SoMo 650 is NOT compatible with the SoMo 655.***

## 2 | Getting Started



**CAUTION: TO ENSURE PROPER OPERATION OF YOUR SOMO 655, FOLLOW THE BELOW INSTRUCTIONS PRIOR TO USE. FAILURE TO FOLLOW THESE INSTRUCTIONS COULD RESULT IN YOUR SOMO TEMPORARILY NOT TURNING ON.**

### STEP 1: Install the Battery

1. To remove the battery cover, press the release button on the bottom of the battery cover with your thumb. Use your opposite hand to slide the cover off.

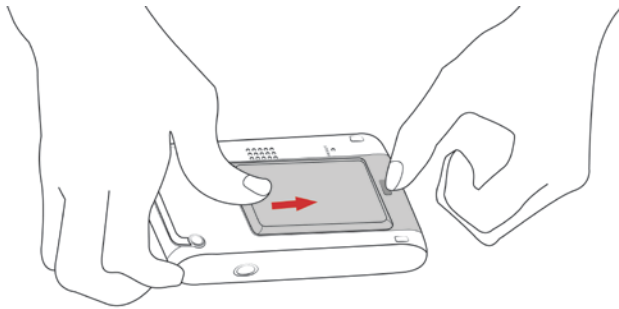

2. Place the Lithium-ion battery into the battery compartment with the contacts side first (bar code label is facing up).

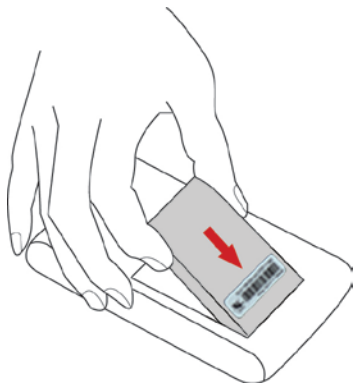

**CAUTION: THERE IS RISK OF EXPLOSION IF BATTERY IS REPLACED BY AN INCORRECT TYPE. DISPOSE OF BATTERIES ACCORDING TO YOUR LOCAL REGULATIONS FOR BATTERY DISPOSAL.**

3. To replace the battery cover, align the top end of the cover carefully, leaving a small gap. Then slide the cover on till it clicks.

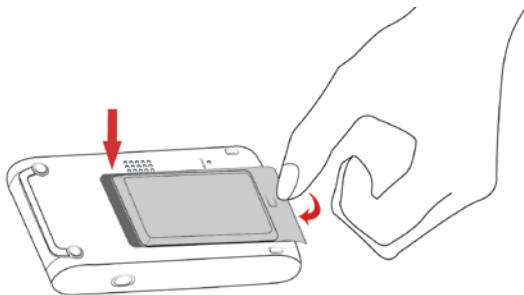

**CAUTION: DO NOT PRESS THE BATTERY COVER DIRECTLY DOWN OR THE BATTERY DOOR SENSING SWITCH COULD BE DAMAGED.**

## STEP 2: Charge the Battery

**OPTION 1:** Charge the SoMo directly from an outlet using the 1A AC adapter.

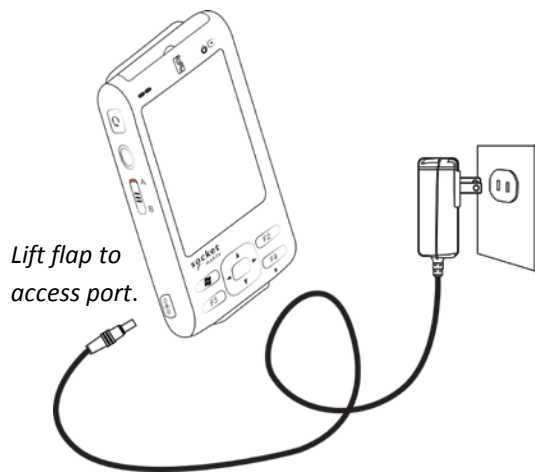

**OPTION 2:** Charge the SoMo using the Sync-charge cradle.

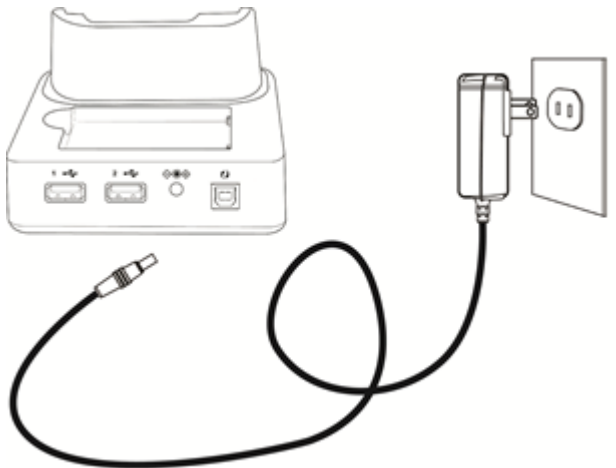

*The SoMo 655 should be charged for at least 4 hours before first use. Afterwards, charge the device as needed according to its battery level.*

*The right LED indicator on the front of the SoMo turns red while charging, then green when fully charged.*



**CAUTION: WHEN CHANGING BATTERIES, DO NOT REMOVE THE MAIN BATTERY FOR MORE THAN 5 MINUTES UNLESS AC POWER IS APPLIED TO THE UNIT. REMOVING EITHER AC POWER OR THE MAIN BATTERY FOR MORE THAN 5 MINUTES COULD RESULT IN THE SOMO FAILING TO POWER ON AFTER CHANGING THE BATTERY.**

### STEP 3: Set up your SoMo 655



**NOTE:** For optimal results, make sure the SoMo 655 is fully charged before proceeding.

1. Check to see that the A/B Mode switch on the left side of the device is up, in the A position.
2. Press the power button.

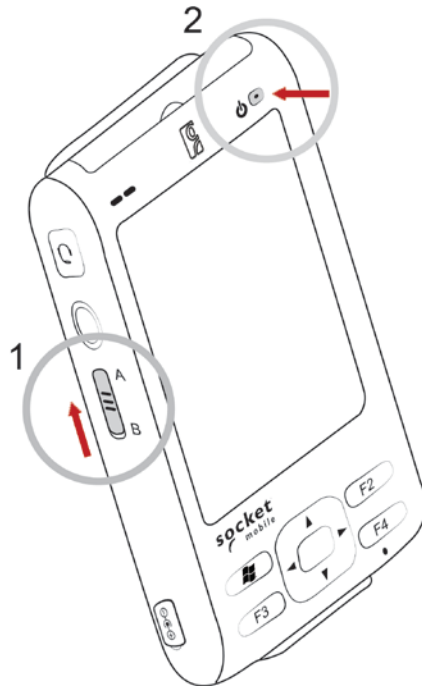



## STEP 4: Install Synchronization Software on Host PC

**i** Do not connect your SoMo 655 to your host PC until the synchronization software has been installed on the PC.

### Windows 7/Vista

1. Enable **Windows Mobile Device Center** which comes installed on your computer. Download the latest version for free at: <http://www.microsoft.com/download/en/details.aspx?id=14>
2. Follow the instructions on the webpage to install the software.

**i** Refer to the Microsoft website for information on how to use the software.

### Windows XP/2000

**i** ActiveSync version 4.2 or greater is required to connect to Windows Mobile 5.0, and version 4.5 or greater is required to connect to Windows Mobile 6.

1. If your host PC runs Windows XP or 2000, install **Microsoft ActiveSync** which is available free online at: <http://www.microsoft.com/download/en/details.aspx?id=15>
2. After installation, the ActiveSync icon will appear on your system tray (lower right corner of the screen). 

**i** Refer to the ActiveSync online Help for information on how to use the software.

## STEP 5: Connect to Host Computer

**OPTION 1: Connect the SoMo to the host computer with the Sync Cable.**

**NOTE: It is recommended that you also connect the AC adapter.**

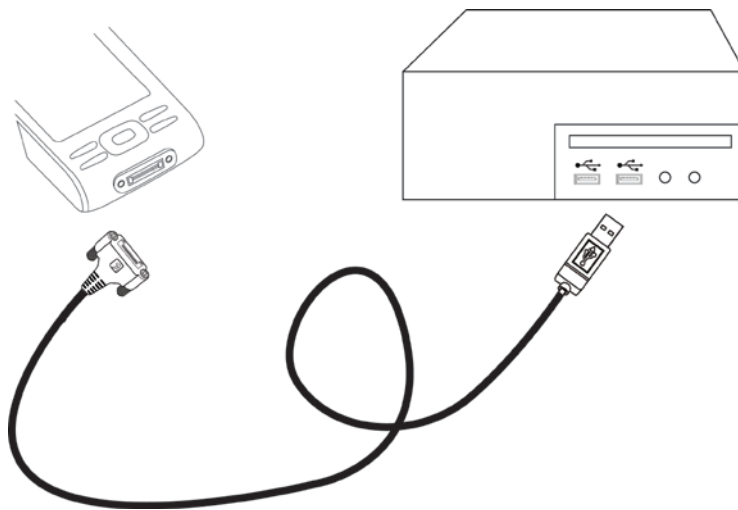

**OPTION 2: Connect to the host computer with the optional Cradle.**  
*NOTE: It is recommended that you also connect the AC adapter.*

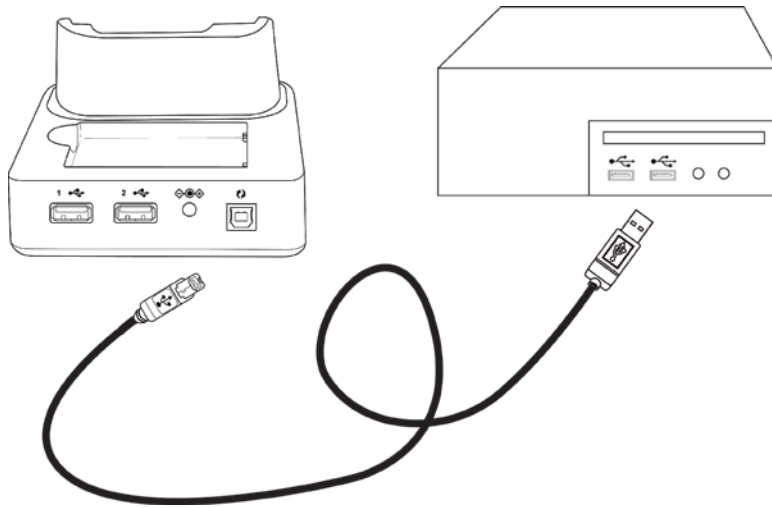

## STEP 6: Set Up Your Device Partnership

### Windows 7/Vista

1. When you connect your SoMo 655 to your computer for the first time, the **Windows Mobile Device Center** will automatically start.
2. Click **Set up your device**.
3. Select the information you want to synchronize and click **Next**.
4. Follow the instructions in the remaining screens to complete the setup.



### Windows XP/2000

1. When you connect your SoMo 655 to your computer for the first time, the **New Partnership** wizard will automatically launch.



**NOTE: If the wizard does not automatically appear, click Start | All Programs | Microsoft ActiveSync.**

2. Follow the setup wizard to set up the partnership. Once completed, the first synchronization will start automatically.
3. After the synchronization is complete, you will see that the **Calendar, Contacts and Tasks** and other applications on your SoMo 655 have been updated.



The next time you wish to use the synchronization software, just plug your SoMo 655 into your computer. The software will open automatically and update your device.

## Getting Started Wizards

1. In the Today screen, tap **Getting Started**.
2. A list of wizards will appear. Some are generic for Windows Embedded Handheld 6.5, but some are specifically for the SoMo 655:

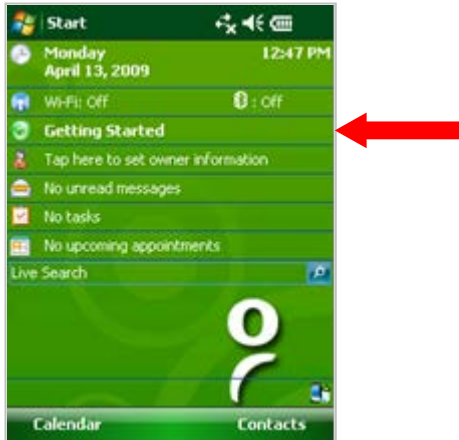

*Some of the latest wizards included with Windows Embedded Handheld 6.5 include the following:*

- Register SoMo 655
- Install Microsoft Windows Mobile Updates
- Set up e-WFC
- Set up SocketScan 10
- Configure hold switch
- Set up Connect!Agent
- Sprite Backup Trial
- MobiScan Rapid Configuration Tool
- Set up Data Capture Triggers
- Set up WAN connections
- Configure CF/SD slots
- Additional wizards generic to Windows Mobile 6.1 devices

3. Tap on a title to launch the wizard.

## Register SoMo 655

Socket highly recommends that all customers register their SoMo devices. Registered users benefit from update notifications and expedited service and support.

1. In the list of Getting Started wizards, tap **Register SoMo 655**.



2. In the next screen, tap on the link.



3. The registration wizard will begin. Make sure the SoMo has Internet access and follow the wizard to register your SoMo.



## Install Microsoft Windows Mobile Updates

In most cases, you will not need to use this utility.

1. In the list of **Getting Started** wizards, tap **Install Microsoft Windows Mobile Updates**.

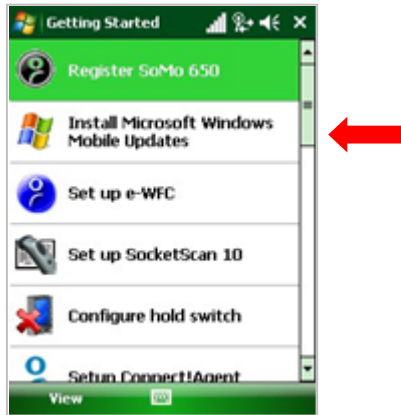

2. Tap on the links for the updates you wish to install.

- **Microsoft Update** (KB980993) – For improving security of Internet Explorer Mobile 6 to prevent remote code execution
- **Microsoft Certificates Update** (KB2524375) –For preventing spoofing

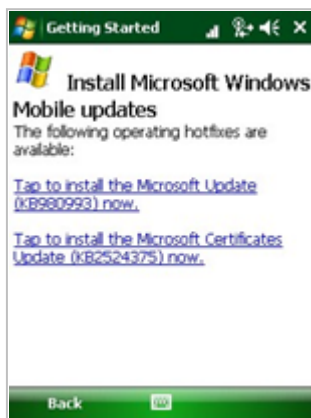

## Set up Enhanced Wi-Fi Companion

By default, the SoMo has Wi-Fi Companion (WFC) installed. For SoMo devices running Windows Mobile 6 Service Pack 4 or later, Enhanced Wi-Fi Companion (e-WFC) is also pre-loaded but must be manually installed.

Enhanced Wi-Fi Companion offers many benefits, including advanced authentication (including PEAP-GTC, EAP-TTLS, LEAP, EAP-FAST); WMM including transmit power control and CCKM; Cisco CCX 4.0 certification; and a Socket profile editor with advanced functionality.

1. In the list of Getting Started wizards, tap **Set up e-WFC**.
2. To install the application, tap on the first link.



3. The device will begin to install the software. When prompted, choose where you will like the software installed. Tap **Install**.



*If you install the software in SoMo File Store, it will remain installed after a hard reset, but not after a ROM flash.*

4. After installation, you will be prompted to restart the SoMo. Tap **OK**.

## Set up SocketScan 10

SocketScan 10 software is for Socket CHS Series 7 v3 barcode scanners.

1. In the list of Getting Started wizards, tap **Set up SocketScan 10**.



2. To install the application, tap on the link.



3. Follow the remaining screens to install the software.



## Configure A/B Mode Switch

The **A/B Mode Switch Utility** lets you change the default behavior of the switch.



*ROM v1.1 and later includes the utility. For previous ROMs, download the utility from: <http://www.socketmobile.com/support/downloads/handheld-computer/somo-655/>*

*When the A/B Mode switch is activated, any connections or programs running on the SoMo will remain active. By default the screen will turn off.*

*By default, the SoMo automatically suspends according to settings saved in the Power applet. To access the applet, tap **Start | Settings | System tab | Power**.*

1. In the list of Getting Started wizards, tap **Configure A/B Mode switch**.
2. Tap on the link in the wizard to access the **A/B Mode Switch Utility**.

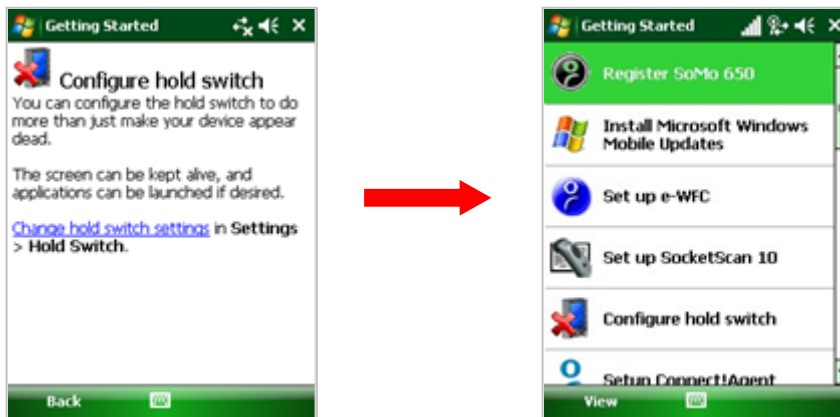

Alternatively, tap **Start | Settings | System tab | A/B Mode Switch**.

3. Use the utility to configure your settings.



NEED NEW SCREEN SHOT THAT DOESN'T SAY

HOLD SWITCH

- **Leave screen enabled:** Select this checkbox to keep the screen on when the A/B Mode switch is activated. A dialog will confirm the switch is activated. Tap **OK** or deactivate the switch to close the dialog.



*When the SoMo is reset, this option is automatically re-enabled.*

- **Disable backlight:** Select to keep the screen on but disable the backlight, recommended for conserving battery life.
- **Disable auto-suspend:** Select to keep the SoMo alive when the hold switch is activated, regardless of settings chosen in the Power applet.



*Use this option with caution to avoid accidental battery depletion.*

- **Launch program when switch is activated/deactivated:** Use the menu to select a program for the SoMo to automatically launch when the hold switch is **activated (in the down position, B) or deactivated (in the up position, A).**



4. After entering your settings, tap **OK**.

## Set up Connect!Agent

Connect!Agent software is compatible with the Socket CHS Series 7 v1 or v2 and the Socket CRS Series 9.

1. In the list of **Getting Started** wizards, scroll down and tap **Set up Connect!Agent**.
2. Tap on the link. Follow the on-screen instructions to install the software.



## Sprite Backup Trial

SoMo devices running Windows Mobile 6 Service Pack 5 or later include a free 10-day trial of Sprite Backup software.

1. In the list of Getting Started wizards, tap **Sprite Backup Trial**.
2. Tap on the first link. Follow the on-screen instructions to install the software.

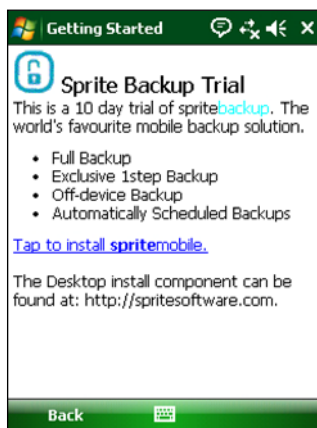

For more information about Sprite Backup, please visit: <http://www.spritesoftware.com/products/sprite-backup/full-edition>

## MobiScan Rapid Configuration Tool

1. In the list of Getting Started wizards, tap **MobiScan Rapid Configuration Tool**.
2. Tap on the link. Follow the on-screen instructions to install the software.

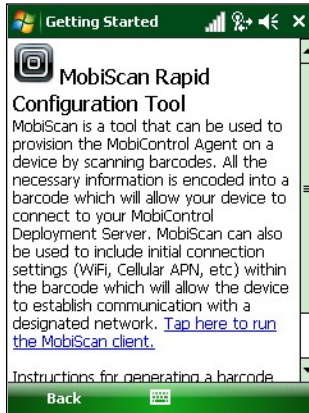

For more information about SOTI MobiScan, please visit:

<http://soti.net/mc/help/Content/Manager/MobiScan.htm>

## Set up Data Capture Triggers

For instructions on how to set up data capture triggers for Socket barcode scanners or RFID readers, please refer to Chapter 6.

## Set up WAN Connections

For instructions on how to set up WAN Connections with the SoMo 655 Back Pack wireless broadband ExpressCard adapter (sold separately), please refer to Chapter 7.

## Configure CF/SD slots

In most cases you will not need to use this utility. If you insert a memory card into the SoMo and cannot access data from the card after the device suspends/resumes, use the utility to leave the card slot enabled even when the device has suspended.

1. In the list of Getting Started wizards, tap **Configure CF/SD** slots.
2. Check the appropriate box to enable a card slot after the SoMo suspends/ resumes.
3. Tap **OK**.

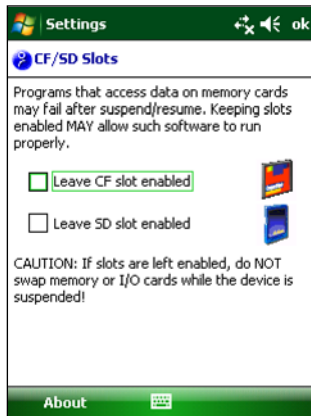

**CAUTION: ONLY LEAVE A SLOT ENABLED TO INSERT A MEMORY CARD. DO NOT LEAVE A SLOT ENABLED TO INSERT A SOCKET CF / SD DEVICE OR OTHER I/O CARD.**

**LEAVING A SLOT ENABLED WHEN THE SOMO IS NOT IN USE CAN DEplete THE BATTERY.**

**IF YOU LEAVE A SLOT ENABLED WHEN THE SOMO IS POWERED ON, DO NOT REMOVE OR INSERT A CARD UNLESS IT IS A MEMORY CARD.**

## 3 | Using the SoMo 655

This chapter explains how to use your SoMo 655 through its buttons, the **A/B Mode** switch, stylus, Start menu, online Help, and the Radio Manager.

### Stylus

You can use the stylus in three ways.

- Tap an item: Use to select an option, similar to left-clicking a mouse.
- Tap and hold an item: Reveals a submenu, if available. It is similar to right-clicking a mouse.
- Drag: Hold the stylus against the screen and drag to highlight multiple items, or to move the position of an item. Similar to left-clicking and dragging a mouse.



*A tethered stylus is also available online at:*

<http://ww1.socketmobile.com/products/handheld-computers/accessories-hc.aspx?cat=Input>

### A/B Mode Switch

The A/B Mode switch on the left side of the SoMo 655 can be used to prevent accidental input by disabling all buttons and the screen. Any applications or wireless connections running on the device will remain active.

To put your device on hold, move the switch down, to the **B** position.



*The A/B Mode switch is not related to the software lock function accessible from the Today screen.*

*When the A/B Mode switch is activated, by default, the screen will turn black, and the screen and all buttons on the sides and front of the SoMo will be disabled, including the power button.*

*To enhance your user experience, Socket has a A/B Mode Switch Utility that enables you to configure the switch settings. (See Chapter 2.)*

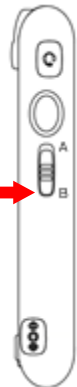

## Start Menu





From the **Start** menu, you can access **programs, settings** and **Help topics**. The **Start** menu can be accessed by tapping the **Windows logo** .

## Online Help

Your SoMo 655 contains online help files. These can be accessed in two ways:



1. Tap **Windows logo**  > **Help** > **Contents** for a list of Help topics.
2. To access Help for any particular application, open the application and then tap **Windows logo**  > **Help**.



*Alternatively, tap on the Help icon  if your application has one.*

## Wireless Radio Manager

### Microsoft Wireless Manager



*SoMo devices running Windows Mobile 6 include the Microsoft Wireless Manager by default. If you install Enhanced Wi-Fi Companion, the Socket Radio Manager will appear instead (see next page).*

1. To open the **Microsoft Wireless Manager**, press the button on the right side of the SoMo. Alternatively, tap the **Wi-Fi and Bluetooth status** line in the Today screen.

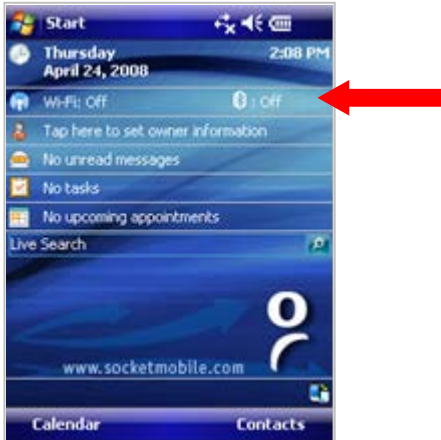

2. In the Wireless Manager, an X appears next to the Wi-Fi or *Bluetooth* icon when the radio is off. Tap on the button to turn on the radio.



*Wi-Fi Companion software automatically launches after Wi-Fi is turned on.*



## Socket Radio Manager



*SoMo devices running Windows Mobile 5 include the Microsoft Wireless Manager by default. The Socket Radio Manager also appears on SoMo devices running Windows Mobile 6 with Enhanced Wi-Fi Companion installed.*

1. To open the **Socket Radio Manager**, press the button on the right side of the SoMo 655. Alternatively, tap the **Wi-Fi and Bluetooth status** line in the Today screen.

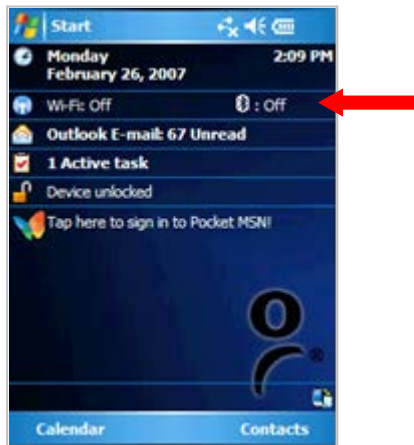

2. In the Radio Manager, a red X appears on the *Bluetooth* or *Wi-Fi* button when the radio is off. Tap on the button to turn on the radio.



*Wi-Fi Companion software automatically launches after Wi-Fi is turned on.*

*Flight mode turns off Bluetooth and Wi-Fi. When flight mode is disabled, the previously running wireless radio(s) will turn on again.*

## SoMo 655 Power Plus Battery Friendly® Utility

This utility provides advanced power management and monitoring and is available on SoMo devices running Windows Mobile 6 Service Pack 6 or later.



With **MCU** firmware 2.7 or later, the utility provides detailed information on SoMo performance. To determine your MCU version, tap **Start | Settings | System tab | System info | OS Version**.

To learn more about the utility, please visit:

<http://www.socketmobile.com/support/downloads/handheld-computer/somo-655/?page=Detail>

1. In the Today screen, tap on the **Battery** icon or **Power Plug** icon. (These icons indicate whether the SoMo is running on battery power or connected to AC power.)

Battery icon

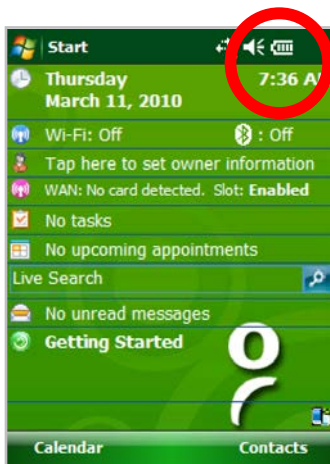

Power Plug icon

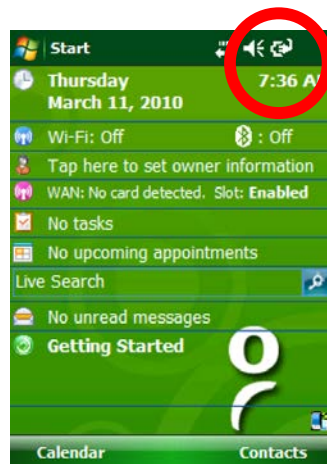

Alternatively, tap **Start | Settings | System tab | Power Plus**.

2. The Power Plus utility will appear, displaying the Battery screen.

Battery charging

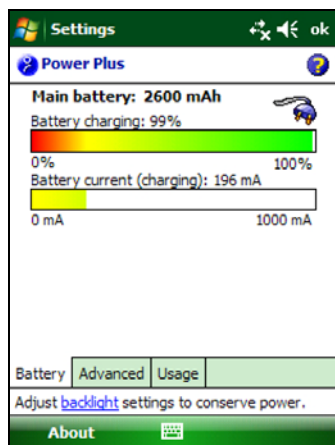

Battery discharging

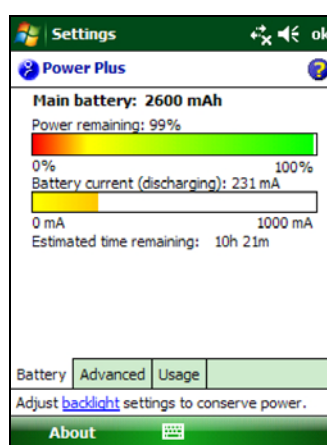



*Current usage typically ranges from 150 mA to over 450 mA depending on how the SoMo is being used.*

*After a suspend/resume, it can take up to 30 seconds for the applet to make a reasonable determination of time remaining.*

*If a battery is changed and the SoMo reset, it may take several minutes to report the battery current usage and estimated time remaining.*

3. Tap on the **Advanced** tab. If desired, configure the SoMo to automatically turn off if not used for a specific amount of time.

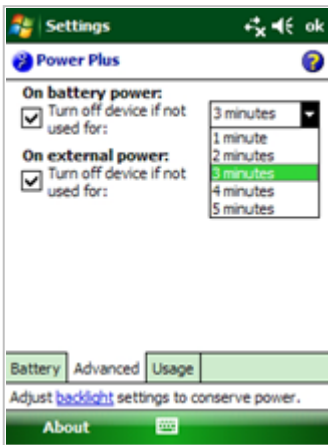

4. Tap on the **Usage** tab. Information about the battery ID, last charging session, and charge remaining is provided.



If desired, enable a power log:

- Power log interval: Select the duration of each power logging interval.
- Reset log: Tap to clear the power log data.
- Export CSV file: Tap to export the power log as a CSV file.

5. Tap **OK**.



*To determine the battery life of the SoMo with your application, please visit:*

<http://www.socketmobile.com/products/handheld-computer/BatteryEstimator/index.html>

## Backlight and Power Settings

You may want to adjust the backlight and power settings to maximize the battery life of your SoMo 655.

1. Tap the **Windows logo**  > **Settings** > **System tab** > **Backlight**.
2. The Backlight utility will appear. Adjust the settings as desired and tap **OK**.

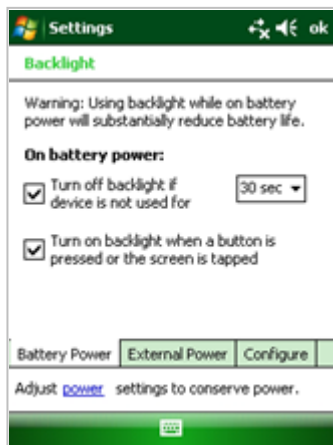

3. In the Settings screen, tap **Power**.
4. Tap on the **Advanced** tab and adjust the settings as desired. Tap **OK**.

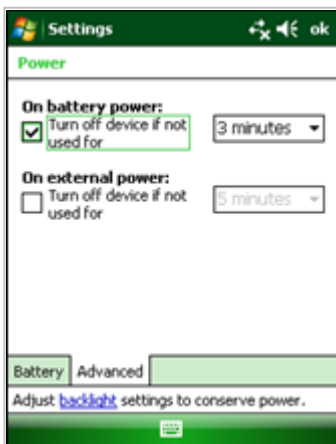

## CPU Performance Utility

The CPU Performance utility allows you to choose a fixed processor speed based on your own criteria of performance versus battery life. This utility is available with SoMo devices running Windows Mobile 6 Service Pack 6 or later.

1. Tap the **Windows logo**  > **Settings** > **System tab** > **CPU**.
2. The CPU Performance utility will appear, displaying the real-time processor speed and a graph of the current processor load percentage.

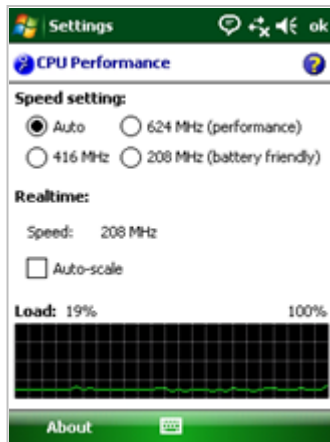

3. If desired, adjust the speed setting.
  - **Auto:** Select for the SoMo to monitor processor usage and adjust the processor speed accordingly.
  - **624 MHz:** Select for the best performance but least battery life.
  - **416 MHz:** Select for a good balance between performance and battery life.
  - **208 MHz:** Select for the best battery life but slower processor performance.

You can also adjust how the load graph appears:

- **Auto-scale:** Select to change the scaling shown in the load graph.

4. Tap **OK**.

## Voice Recorder

By default, the left programmable application button is set for Voice Recorder. Tap on the **red circle icon** to begin recording sound.

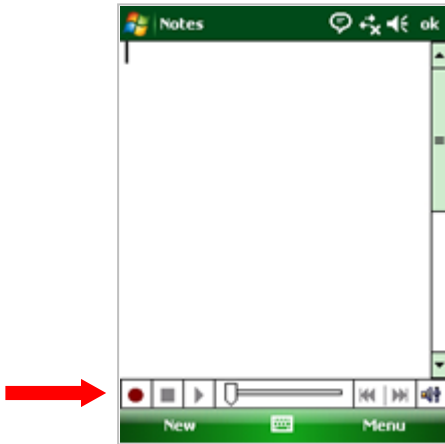

*Note: Manually access Notes by tapping: Windows logo  > Programs > Notes.*

*Note: If the toolbar does not appear, tap Menu | View Recording Toolbar.*

## Adding a USB Keyboard/Mouse

If you are using the SoMo 655??, add a USB Keyboard and/or mouse by docking the SoMo in the cradle and using the cradle's two USB ports to connect.



*Socket also offers an optional USB host cable and Y cable, sold separately at;*  
<http://ww1.socketmobile.com/products/handheld-computers/accessories-hc.aspx?cat=Charging>

## 4 | Wi-Fi Companion

Wi-Fi Companion (WFC) is a powerful and easy-to-use utility for managing Wi-Fi connections from your SoMo 655 handheld computer. Intuitive graphics display connection properties at a glance. Tap on icons to quickly perform a variety of networking tasks. For advanced users, the software also offers advanced diagnostic tools and connection statistics.



In addition, the SoMo comes with the Enhanced Wi-Fi Companion Software (e-WFC) pre-installed and offers the following advantages over WFC:

- Advanced authentication (including PEAP-GTC, EAP-TTLS, LEAP, and EAP-FAST)
- WMM including transmit power control and CCKM
- Cisco CCX 4.0 compatibility
- Socket profile editor with advanced functionality

Software	OS on SoMo	Installation status
Wi-Fi Companion	All	Pre-installed on device
Enhanced Wi-Fi Companion	Windows Mobile 5	Not compatible
	Windows Mobile 6 prior to Service Pack 4	Not included on device. Register SoMo at <a href="http://support.socketmobile.com/">http://support.socketmobile.com/</a> and request a free copy of the software.
	Windows Mobile 6 Service Pack 4 or later	Pre-loaded on device but optional to install



*To view a chart comparing WFC and e-WFC, please download the white paper:*

*[http://www.socketmobile.com/pdf/techbrief/e-WFC\\_white-paper.pdf](http://www.socketmobile.com/pdf/techbrief/e-WFC_white-paper.pdf)*

*For instructions on how to install e-WFC, please refer to Chapter 2.*

*This chapter primarily refers to standard WFC and shows WFC screens. Instructions and screens for e-WFC will be equivalent unless otherwise noted.*

*Socket now offers two WLAN configuration options for the SoMo: Persistence Mode and Fast Roaming. To learn more, read our white paper:*

*[http://www.socketmobile.com/pdf/techbrief/somo-wifi-persistence-mode\\_white-paper.pdf](http://www.socketmobile.com/pdf/techbrief/somo-wifi-persistence-mode_white-paper.pdf)*

### Additional Documentation

This chapter covers basic instructions for using Wi-Fi Companion on the SoMo 655. For detailed instructions, please refer to the User's Guide available online at: <http://www.socketmobile.com/support/downloads/>

## Useful Links

Registered users can download software updates free. Log into: <http://support.socketmobile.com>

## Turning on the Wi-Fi Radio

Wi-Fi Companion will automatically launch after you turn on the Wi-Fi radio.

1. Open the Radio Manager. Press the button on the right side of the SoMo 655. Alternatively, you can tap on the Wi-Fi and *Bluetooth* status line in the Today screen.

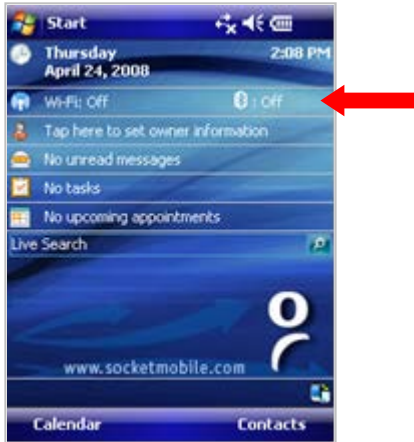

2. In the radio manager, an X will appear on the Wi-Fi button to indicate that the Wi-Fi radio is off. Tap on the button to turn on the radio. The X will disappear.

*Socket Radio Manager*



*Microsoft Wireless Manager*





- The Wi-Fi status icon will appear at the top of the screen. The icon varies based on your connection status. Tap on the icon to view the main screen of Wi-Fi Companion. To view the different versions of the icon, please refer to the chart on the next page.

*Socket Radio Manager*



*Microsoft Wireless Manager*



***If you tap Enable Flight Mode (Socket Radio Manager) or All (Microsoft Wireless Manager), the Bluetooth and Wi-Fi radios will both be disabled. The manager will remember which wireless radio(s) were running, so when you later tap Disable Flight Mode or All, the same one(s) will turn on again.***

## Main Screen of Wi-Fi Companion

The screen content varies depending on your connection status.

**Your device properties**

- Device name
- IP address
- Packets sent and received

The icon always appears regardless of connection status.  
Tap to view more IP addresses or access the radio manager.

**Wi-Fi status icon**  
Tap to access this screen from outside the utility

**Valid IP address**  
Tap to access email, the Internet, ping or trace route.

**Data rate**  
Tap to view signal strength and data rate distribution.

**Encryption status**  
Tap to access a certificate management utility for WPA or 802.1x if needed

**Access point/remote device properties**

- SSID (network name)
- Connection duration
- Signal quality rating and percentage
- MAC address (also known as BSSID)
- Channel number (in black circle)

Tap for Wi-Fi Finder.

The screenshot shows the main interface with a blue background. At the top, it says 'Wi-Fi Companion' and 'Pocket\_PC'. Below that, it displays 'DHCP: 216.31.250.160', 'Packets Sent: 43', and 'Packets Received: 1020'. There's a 'WEP enabled.' status and a 'socketcomm' connection with 'Duration: 00:06:22', 'Quality: Good', and '00:a0:f8:39:be:eb'. A signal strength indicator shows '11 Mbps' and '43%'. At the bottom, there are tabs for 'Tools', 'Statistics', and 'About'.



*For Enhanced Wi-Fi Companion, the screen has a green background.*

## Wi-Fi Status Icon

The icon appears at the top of every screen when Wi-Fi Companion is running.







	Associated or Connected. Number of bars indicates signal strength.
	Networks available.
	Searching for networks.
	Networks out of range but configured.

## Wi-Fi Finder

The Wi-Fi Finder displays a list of WLAN networks found in range. To access the Wi-Fi Finder, tap on the **large tower icon** in the bottom right corner of the main screen of Wi-Fi Companion.



## Wi-Fi Finder Icons

	Current connection
	Signal strength of strongest AP (access point)/ad hoc radio
	WEP encryption, WPA (PSK), WPA (TKIP), WPA2 or 802.1x
	No encryption
	Channel number
	Profile saved
	802.11b, 802.11g

## Finding and Connecting to a WLAN

Ask your network administrator for the necessary security settings for your WLAN. If the WLAN uses 802.1x, WPA or WPA2, you need to install authentication certificate(s) before you can connect. Refer to the Wi-Fi Companion User's Guide for instructions on the Socket certificate utility.

1. In the main screen of Wi-Fi Companion, tap on the tower icon  or tap **Tools | Wi-Fi Finder**.
2. Wi-Fi Finder will appear, listing WLANs detected in range. Tap on any WLAN in the list to view additional properties.

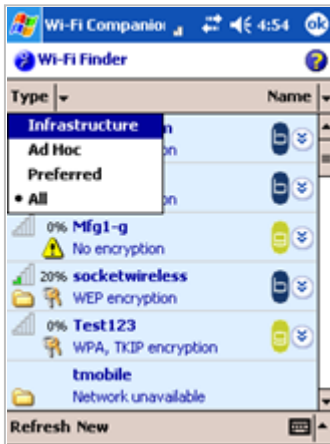

If desired, tap on the **Type** or **Sort by** drop-down menus to change how the list is displayed.

If your WLAN is not listed, tap **Refresh** at the bottom of the screen.

3. If Wi-Fi Finder cannot find your WLAN because its SSID (network name) is hidden, tap **New** at the bottom of the screen.

A wizard will launch to help you create a profile for your network. Complete the wizard, entering the security settings obtained from your network administrator.

*Microsoft profile editor*

*Socket profile editor*

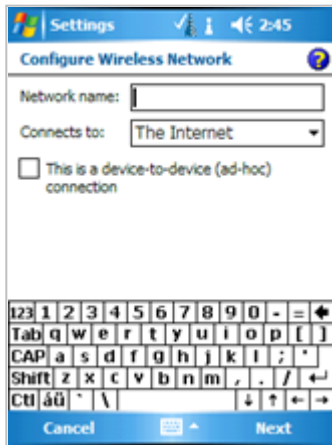

**i** For Wi-Fi Companion, the Microsoft profile editor (Wireless Zero Configuration) will launch.

*For Enhanced Wi-Fi Companion, a Socket profile editor will launch with dynamic configuration and advanced security options.*

4. If your WLAN does not have a profile (i.e., no folder icon is shown next to it), tap and hold your stylus on the WLAN in the list. In the pop-up menu, tap **Get Connected**.

A wizard will launch to help you create a profile for the selected SSID. Complete the wizard, entering the security settings obtained from your network administrator.



5. After a profile is saved, if the WLAN is in range, the SoMo will automatically try to connect to it. To connect to another network in the list, tap and hold your stylus on the WLAN. In the pop-up menu, tap **Connect**.

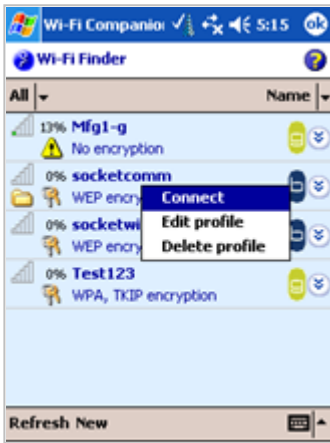

## 5 | SocketScan 10 for CHS Series 7 Barcode Scanners

SocketScan 10 software sends data from your Socket *Bluetooth* Cordless Hand Scanner (CHS) Series 7 v3 into any application running on the SoMo 655. This lets you use the CHS without having to program custom applications. The software comes pre-loaded on the SoMo 655 running Windows Mobile 6 Service Pack 8 or later but needs to be installed.



*These instructions do not apply to version 1 or 2 of the CHS, nor to the CRS Series 9.*

*These instructions are for using the CHS in Bluetooth SPP mode. For Bluetooth HID instructions please refer to your CHS manual.*

### Additional Documentation

This chapter covers basic instructions for using SocketScan 10 on the SoMo 655 with a CHS v3. For detailed instructions, please refer to the appropriate User's Guide for your type of CHS:



- **1D versions (7C, 7E, 7M, 7P, 7NRx):** [http://www.socketmobile.com/pdf/data-collection/chs-series7-v3\\_ug.pdf](http://www.socketmobile.com/pdf/data-collection/chs-series7-v3_ug.pdf)
- **2D versions (7X, 7XRx, 7Xi, 7XiRx):** [http://www.socketmobile.com/pdf/data-collection/chs-7x\\_ss10-ug.pdf](http://www.socketmobile.com/pdf/data-collection/chs-7x_ss10-ug.pdf)

### Useful Links

Registered users can download free software updates by logging into: <http://support.socketmobile.com>

### SocketScan 10 Icons

The icon indicates whether SocketScan 10 is connected to your CHS and ready to read data. The icon appears at the bottom of the Today screen.

Icon	Meaning
	CHS not connected.
	CHS connected and ready to scan barcodes

## STEP 1: Charge the CHS

Refer to your CHS manual for hardware preparation instructions. You may also want to attach the tether.

If you have a 1D version of the CHS (7C, 7E, 7M, 7NRx or 7P) you will need to perform extra steps:

Change the CHS to SPP mode. Power on the CHS. Print out this page and scan this barcode. **Do not scan this barcode on your computer screen.**



Use the *Bluetooth* software to start a device search and pair with the CHS.

- Press the **right side application button**, which by default launches the wireless manager.
- If *Bluetooth* is not enabled, tap on the **Bluetooth button**.
- Tap **Options | Bluetooth Settings**
- At the bottom of the screen, tap **Add**.
- In the list of found devices, select the CHS.
- Complete the remaining screens.
- If prompted for a passkey, enter 0000 (four zeroes).
- After pairing, tap on the **COM Ports** tab. Add an outgoing COM port for the CHS.



**PASSKEY = 0000**

## STEP 2: Install SocketScan 10

1. In the Today screen, tap **Getting Started**.
2. In the list of Getting Started wizards, tap **Set up SocketScan 10**.
3. Tap the link to install the software.



### STEP 3: Pair the CHS with the SoMo

1. Tap **Start | Programs | SocketScan 10 folder | SocketScan 10** .
2. In the Today screen, tap on the **SocketScan 10 icon**  in the task tray. In the pop-up menu, tap **SocketScan 10 Settings**.
3. Make sure an available COM port is selected. Tap **OK**.

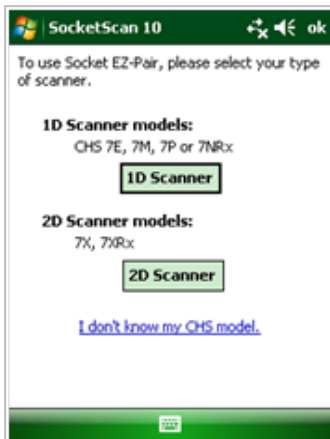

4. In the Today screen, tap on the **SocketScan 10 icon**  in the task tray. In the pop-up menu, tap **EZ Pair**. Tap the type of CHS barcode scanner you have.

- If you have a 2D Scanner, the next screen will show a barcode. Power on the CHS and scan the barcode. If prompted for a passkey, enter 0000 (four zeroes).
- If you have a 1D Scanner, in the next screen select your CHS and tap Pair.

After they pair and connect, the CHS will beep once. The task tray icon will also change .

If you have a 1D scanner, the CHS will disconnect from the SoMo, indicated by 2 beeps. The CHS will then reconnect to the SoMo, indicated by 1 beep.

## STEP 4: Start Application

Start the application that you want to enter data into (e.g., Excel Mobile or Google.com). From the Today screen, tap **Start | Programs** and select your program. Make sure a document, spreadsheet or form is open in your program. Place the cursor where you want data from the next scan to be entered.

## STEP 5: Scan Barcodes

1. Press the trigger button to scan a barcode. Please refer to your scanner manual for the correct technique. Make sure the scanning beam covers the entire width of the barcode. For example, try scanning this barcode:
2. When data is read, it should appear in your document.



Depending on which scanner you have, it may also beep, or the LED may change colors to indicate a successful scan.

By default, the cursor automatically advances to the next cell or line, ready for the next scan/read.



*Wait for the “Good Scan” indication before you scan more data. If you try to scan too fast, the device can lock up until you stop scanning.*

*If the data does not appear how you expect it and you are using Excel Mobile, check the cell formatting.*

## 6 | SocketScan Plug-In for Scanners and Readers

SocketScan software sends data from your Socket barcode scanner, RFID reader or magnetic stripe reader into any application running on the SoMo 655. This lets you use Socket data collection peripherals without having to program custom applications. The software comes pre-loaded on the SoMo 655.

This chapter contains generic instructions for using SocketScan on the SoMo 655 with these products:

- SD Scan Card Series 3
- CF Mag Stripe Reader Card Series 4
- CF Scan Card Series 5
- CF RFID Reader Card Series 6

For specific instructions, please refer to the User's Guide for your specific Socket data collection product, available in the installation CD that came with the data collection product as well as online at:

<http://www.socketmobile.com/support/downloads/>



## STEP 1: Assign a Trigger Button

This step is NOT required for the CF Mag Stripe Reader Card.

### Method 1:

Use this method for the SD Scan Card, CF Scan Card or CF RFID Reader Card 6E with any version of Windows Mobile.

1. Tap **Start | Settings | Buttons**.
2. From the Button list, tap to select a button to trigger your scanner. For best ergonomics, the left or right button is recommended. In the drop-down menu, select **SocketScan**. Tap **OK**.

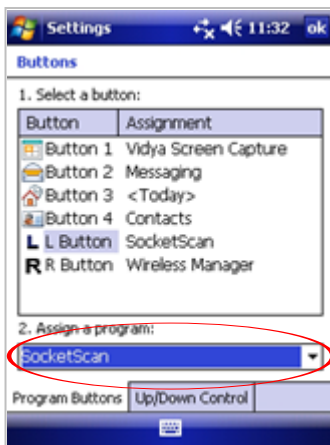

*Make sure you choose SocketScan and NOT SocketScan 10.*

### Method 2:

This method is only for Windows Mobile 6.1 or later

1. In the Today screen, tap **Getting Started**.



2. In the list, tap **Set up Data Capture triggers**.

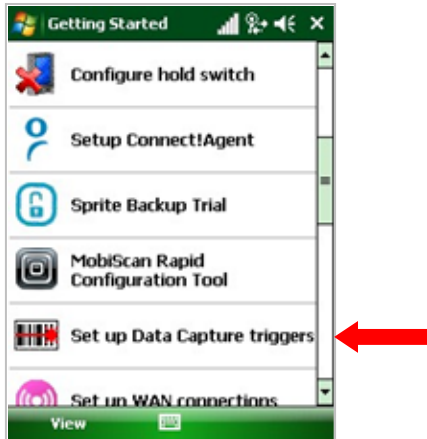

3. In the next screen, tap either **LEFT** or **RIGHT** in the appropriate section to select the button you want to use to trigger your device.



4. The SoMo will automatically set up the trigger button and send a confirmation message to your inbox.

## STEP 2: Start Socketscan

Press the trigger button that you assigned. This is a quick way of starting SocketScan.

Alternatively, tap **Start | Programs | SocketScan folder | SocketScan**.



A SocketScan icon should appear at the bottom of the Today screen indicating that no data collection device has been inserted.



### STEP 3: Insert the Card

1. Open the slot cover at the top of the SoMo 655 and then insert the card into the appropriate slot. Do not insert the card backwards or force the card in too hard.
2. When SocketScan is running, an icon will appear at the bottom of the Today screen. Make sure the proper icon appears to indicate that your device is ready to collect data.



Icon	Meaning
	No Socket data collection device detected.
	Ready to scan barcodes with the Secure Digital Scan Card
	Ready to read magnetic stripe data with the CF Mag Stripe Reader Card 4E
	Ready to scan barcodes with the CF Scan Card 5E2/5P or CF RFID Reader-Scan Card 6E/6P
	Ready to scan barcodes with the CF Scan Card 5X/5XRx
	Ready to read RFID tags with the CF RFID Reader Card



*If you insert the card before starting SocketScan, no icon will appear.*

### STEP 4: Start Application

Start the application that you want to enter data into (e.g., Excel Mobile). From the Today screen, tap **Start | Programs** and select your program. Make sure a document, spreadsheet or form is open in your program. Place the cursor where you want data from the next scan/read to be entered.

### STEP 5: Scan or Read Data

Scanning/RFID: Press the trigger button to scan a barcode or read an RFID tag. Please refer to your scanner manual for the correct technique.

When scanning a barcode, make sure the scanning beam covers the entire width of the barcode. For example, try scanning this barcode:



ABCDE12345

Mag Stripe: Swipe a magnetic stripe card through the slot, with the magnetic stripe facing the SoMo 655.

3. When data is read, it will appear in your document where you positioned the cursor.

Depending on which scanner/reader you have, it may also beep, or the LED may change colors to indicate a successful scan.



*Wait for the “Good Scan” indication before you scan more data. If you try to scan too fast, the device can lock up until you stop scanning. If the data does not appear how you expect it and you are using Excel Mobile, check the cell formatting.*

## Appendix A

### Specifications

Processor	Intel PXA270M@624MHz CPU
Memory	SDRAM: 128MB NAND Flash: 4GB SoMo File Store: 32 MB and 128 MB non-volatile memory configurations available.
Display	65K colors TFT LCD, 3.5" 16 bit-per-pixel 240 (w) x 320 (L) resolution (QVGA size) portrait and landscape modes, default portrait mode. Glass analog resistive touch panel White LED backlight
Audio	Headset Jack: 3.5mm, 4-ring type, support for both Voice & Stereo music 0.5W speaker Omni-directional microphone
Connectors	SoMo 655: DC-in (5V, 1A) USB synchronization/host cable connector Cradle: Docking connector DC-in (5V, 3A) USB synchronization cable connector USB v2 USB connector x 2 (Type A): USB v1
Wireless Connectivity (not included with SoMo 655DXS)	Bluetooth: v2.0 + EDR Class 2 IEEE® 802.11b/g/n WLAN with fast roaming client Cisco CCX 4.0 compatible with Enhanced Wi-Fi Companion software (requires separate install)
Mass Storage & Expansion Slots	microSD, Compact Flash. Supports up to 32GB of external memory
USB	USB 1.1 support host/client (x2) (Cradle only)
Battery	Standard: 3.7V 1500 mAh, rechargeable, Lithium-ion Extended: 3.7V 2600 mAh rechargeable, Lithium-ion (extended battery available separately or with <b>SoMo 655Rx</b> )
Dimensions	With standard battery: 5.00 x 2.94 x 0.81 inches (127 x 74.60 x 20.6 mm) Weight: 6.25 oz (177 g) (including stylus) With extended battery: 5.00 x 2.94 x 0.98 inches (127 x 74.60 x 25 mm) Weight: 7.20 oz (204 g) (including stylus)

Operating Temperature	0° to +40° C (+32° to +120° F)
Storage Temperature	-25° to 75° C (-13° to 167° F)
Humidity	95% non-condensing
Antimicrobial Rating (SoMo 655Rx only)	JIS Z2801:2000 Test <ul style="list-style-type: none"> <li>– 2.49 on Methicillin resistant Staphylococcus aureus (MRSA)</li> <li>– 6.07 when cleaned with Sani-Cloth® Plus brand disposable cloth wipes</li> </ul>
Drop Specification	Multiple 1 m (3.3 ft) drops to vinyl-covered concrete With optional DuraCase protective case (sold separately): Multiple 1.3 m (4.3 ft) drops to vinyl-covered concrete
ESD Specification	+/- 8kV air discharge, +/- 8kV direct discharge
Operating Systems Available	Microsoft Windows Embedded Handheld 6.5 (previously known as Windows Mobile Classic 6.5)
Pre-Loaded Socket Software	<p>Socket Wi-Fi Companion™</p> <p>Socket Enhanced Wi-Fi Companion™ (available in SP4 or later)*</p> <p>Socket SocketScan™ 10 (supports Socket CHS Series 7 v3 barcode scanners, available in SP8 or later)*</p> <p>Socket SocketScan™ (supports Socket plug-in barcode / RFID / magnetic stripe readers, Socket CHS Series 7 v2, Socket CRS Series 9 and UIC683 contactless smart card reader)</p> <p>Socket Connect!Agent™ (for Socket CHS Series 7 v2 and Socket CRS Series 9; needs to be manually installed via Getting Started wizard for SP8 or later)</p> <p>Socket Modem and Ethernet Utilities</p> <p><b>Socket SoMo 655 Back Pack Utilities</b></p> <p>Socket Power Plus Battery Friendly Utility</p> <p>Socket CPU Performance Utility</p> <p>Socket Hold Switch Utility</p> <p><i>*Enhanced Wi-Fi Companion and SocketScan 10 are pre-loaded but need to be manually installed via the Getting Started Wizard.</i></p>



Pre-Loaded Third-Party Software	Programmable Home Screen Calculator MSN Messenger Client Word Mobile 2010, Excel Mobile 2010, PowerPoint Mobile 2010 IE Mobile, Outlook Mobile .NET Compact Framework v2.0 Remote Desktop Mobile Windows Media Player 10.2 Mobile ActiveSync Client v4.x SocketSerial drivers SOTI MobiScan Agent Sprite Backup (trial version)
---------------------------------	--

## Appendix B

### Care and Maintenance



*For important safety and usage instructions, please refer to page 3.*

#### Cleaning the SoMo 655 or SoMo 655DXS:

- With the device switched off, clean the SoMo 655 by wiping it with a soft, clean cloth that is lint-free and slightly moistened. Do not allow the earpiece, microphone, speaker, card slots, sync/charging port or other metal surfaces to get wet.
- Do not wipe the SoMo with any corrosive liquid or coarse objects. This can damage the outer surface of the device.

#### Cleaning the SoMo 655Rx (antimicrobial version):

- Socket recommends Sani-Cloth® Plus brand disposable cloth wipes as the standard disinfectant wipe for the SoMo 655Rx handheld computer. Doing so will increase the JIS Z2801:2000 antimicrobial rating from 2.49 to 6.07.
- Do not use bleach-based or Dispatch® brand cloth wipes, as they negate all antimicrobial properties that have been added to the device.

#### Carrying or Storing the SoMo:

- Do not leave the SoMo in extremely high or low temperature environments.
- Remove the battery of the SoMo if it is not going to be used for a long period of time. Store the SoMo and its battery in a cool, dark, and dry place.

## Appendix C

### Resetting the SoMo 655

The SoMo 655 supports the three levels of reset defined by Microsoft for Windows Mobile powered devices:

- **Soft Reset** - sometimes called a “warm reset”
- **Hard Reset** - sometimes called a “cold reset”
- **Clean Reset** - sometimes called a “clean boot”

Each of these resets is designed to clear different levels of data storage and impact the hardware differently.

Additionally, removing the battery and any external sources of power from the SoMo 655 will result in the equivalent of a reset.

The following Table summarizes the system impact under these modes of operation:

<b>State of SoMo 655 After:</b>	<b>All Installed Applications and Registry Settings</b>	<b>Running Programs</b>	<b>Data Associated with Running Programs</b>	<b>Date and Time</b>
Soft Reset	No impact	Stopped	Lost	No impact
Hard Reset	No impact	Stopped	Lost	Lost
Clean Reset	Removed	Stopped	Lost	Lost
Battery & external power removed for less than 5 minutes	No impact	Stopped	Lost	No impact
Battery & external power removed for more than 10 minutes	No impact	Stopped	Lost	Lost



*The SoMo has a power backup that maintains the date and time if the battery and all external power sources are removed. If the SoMo does not have a battery or external power source for 10 minutes, the date and time will be lost, and the power backup must be recharged for at least 10 minutes for it to properly maintain the date and time.*

## Soft Reset

A soft reset is like rebooting a computer. It is designed to stop all applications and clear out temporary data associated with running programs. No files are deleted. A soft reset is the lowest level of reset, (i.e., it clears the least amount of the device state).

It can also be used to stop application programs that are “hung” and do not respond to external input. Since Windows Mobile powered devices do not normally shut down an application after it is started, this is one way to stop all applications.

### To perform a soft reset:

Using the tip of your stylus, lightly press the Soft Reset button inside the hole on the back of your SoMo 655 and then release.

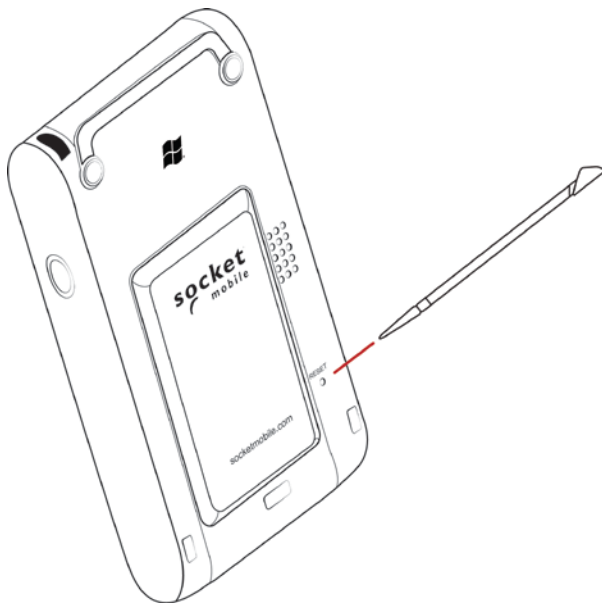

## Hard Reset

A hard reset is designed to clear all processor states, running programs, and user data. It also drives the hardware reset line to the processor, thereby clearing all system states, including the date and time. This reset should be used to remove the operating system from a “hung” or “frozen” state because of a fatal program or operating system error.

A hard reset will clear all user-installed settings, applications, and data from RAM (Random Access Memory), but any applications or configurations saved in the SoMo File Store will remain. It is useful for clearing some states that are not normally cleared with a Soft Reset

### To perform a hard reset:

1. With the SoMo upside-down in your right hand, press and hold the Start Control button and F2 Configurable button.
2. While holding the two buttons, use the tip of your stylus to lightly press and release the Reset button inside the hole on the back of your SoMo 655.
3. Release the Start Control button and F2 Configurable buttons.



***It is recommended that you hold the SoMo 655 upside-down in your right hand. Press the Start Control button and F2 Configurable button with the index and middle fingers. Hold the stylus in your other hand to press and release the reset button.***

4. A Socket Splash Screen will appear and disappear. Follow the onscreen instructions.



## Clean Reset

A clean reset reverts the device to its factory default settings (or the latest service pack ROM update). All installed programs, data and registry settings will be cleared, except those saved in the SoMo File Store. A clean reset also drives the processor with a hardware reset, thus clearing all system states, including the date and time.



**CAUTION: A CLEAN RESET IS MORE POWERFUL THAN A SOFT OR HARD RESET. IT WILL DELETE ALL USER APPLICATION FILES AND FOLDERS. WHEN YOU PERFORM A CLEAN RESET, FORMATS, PREFERENCES AND OTHER SETTINGS INCLUDING DATE AND TIME ARE RESTORED TO THEIR FACTORY DEFAULTS. ALL DATA, RECORDS AND ENTRIES, EXCEPT THOSE STORED IN ROM, WILL BE ERASED.**



*If you set a security password on the SoMo 655 and forget it, a clean reset will remove the password setting.*

### To perform a clean reset:

1. With the SoMo upside-down in your left hand, press and hold the Left Programmable Application Button, the Start Control button and F2 Configurable buttons.
2. While holding the three buttons, use the tip of your stylus to lightly press and release the Reset button inside the hole on the back of your SoMo 655.

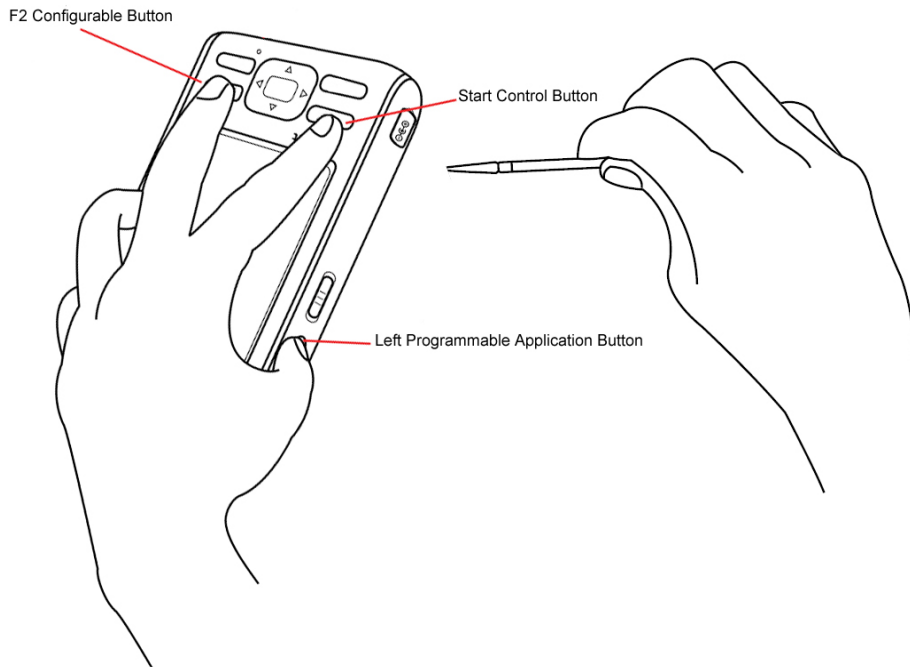

***It is recommended that you hold the SoMo 655 upside-down in your left hand. Press the Left Programmable Application button with your left thumb and the two shortcut buttons with your left index and middle finger. Hold the stylus in your right hand to press and release the reset button.***

3. A Socket Splash Screen will appear.



**After the Socket Splash Screen disappears,** release the three buttons and follow the onscreen instructions.

## Upgrading the ROM Image

### Advanced Users Only!

Upgrades are available free to registered users. Log in to submit a request at:

<http://support.socketmobile.com>. With Windows Mobile 6 SP6 and later the SoMo File Store can also be upgraded.



**WARNING! YOU WILL LOSE ALL DATA FILES AND APPLICATIONS DURING THE UPGRADE PROCESS!**

#### STEP 1: Power the Device

Socket highly recommends that you plug the SoMo 655 into an external power source using the charging cable/cradle. Alternatively, make sure the SoMo battery is adequately charged.

#### STEP 2: Back up Data on the Device

If you have any data on the SoMo 655, please back it up before you run the update.

#### STEP 3: Transfer Files using a Memory Card



**IMPORTANT! IT IS NOT RECOMMENDED TO TRANSFER THE FILES USING ACTIVESYNC OR THE WINDOWS MOBILE DEVICE CENTER!**

The directory SOMO655 containing the ROM image files must be moved to the SoMo 655 with a SD or CF memory card that is formatted in FAT12 or FAT16. Make sure your memory card has at least 40 MB of free space.



*Most higher-capacity cards are formatted by default in FAT32, which is not supported. SDHC cards are not supported in Windows Mobile 5.*

On your PC, use My Computer or Windows Explorer to locate the directory SOMO655, which contains the upgrade files.

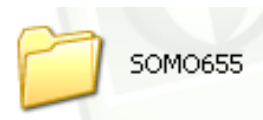

4. Copy the SOMO655 directory to the root of your memory card.



**IMPORTANT! COPY THE SOMO655 DIRECTORY TO THE ROOT OF THE MEMORY CARD!**

**EXAMPLE: F:/SOMO655, NOT: F:/SOCKET/SOMO655**

**DO NOT CHANGE THE NAME OF THE FOLDER!**

5. Insert the memory card into the SoMo 655.

#### STEP 4: Install the Files

1. Press and hold the **Right Programmable Application Button**, and the **F2 Configurable Button** and **Start Control Button** on your SoMo 655.



2. While holding the three buttons, use the stylus to quickly press the **Reset button** inside the hole on the bottom of your SoMo 655. Keep holding the **Right Programmable Application Button**.

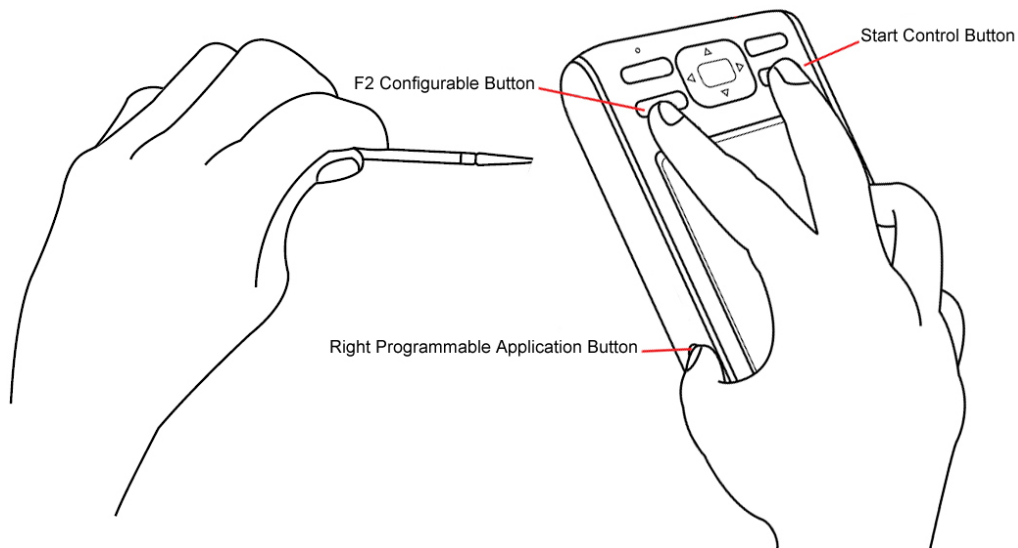

3. An EBOOT screen will appear with a timer, counting down from 5 seconds.



**IMPORTANT! KEEP HOLDING THE RIGHT PROGRAMMABLE APPLICATION BUTTON UNTIL THE TIMER REACHES 0 SECONDS! OTHERWISE THE INSTALLATION WILL BE ABORTED.**

4. The SoMo 655 will begin to download and update the ROM image.

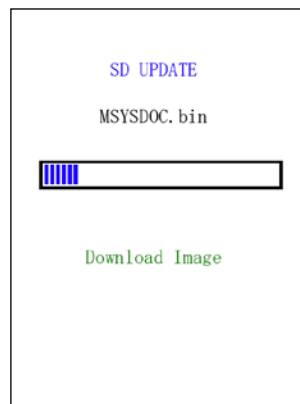
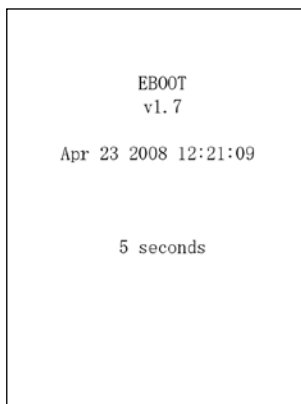

5. After the installation reports, "Update completed!" the Socket splash screen will appear for about 30 seconds.

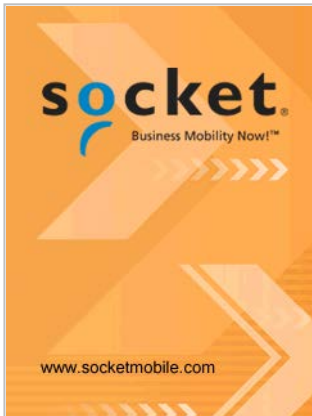

6. The Windows Mobile splash screen will appear for about 30 seconds.
7. The Windows Welcome wizard will prompt you to set up Windows Mobile. Follow the instructions on your screen.
8. After setting up Windows Mobile, the Today screen will appear, and the SoMo 655 will be ready to use.

# Appendix E

## Troubleshooting

*SYMPTOM: When I press the power button, the SoMo does not turn on.*

Possible Reason	Solution
The SoMo battery does not have adequate charge.	Plug the SoMo into AC power or insert a charged battery.
The SoMo hold switch is on.	Slide up the hold switch on the left side of the SoMo. If you have a new SoMo, remove the sticker on top of the hold switch.

*SYMPTOM: I connected the SoMo to a PC via the USB cable, but the SoMo does not charge.*

Possible Reason	Solution
Your SoMo runs Windows Mobile 6 Service Pack 7 or later and has USB charging disabled.	Tap <b>Start   Settings   System   Power Plus   Advanced</b> . Select Enable USB charging and tap <b>OK</b> .

## Appendix F

### Technical Support

If you have trouble installing or using the SoMo 655, Socket has different support options to help you.

#### Online Knowledge Base:

Search for articles, Frequently Asked Questions or Hot Topics any time, day or night.

[http://support.socketmobile.com/EU\\_S1a.asp](http://support.socketmobile.com/EU_S1a.asp)

#### Online Requests:

Register your product and submit a question to our Technical Support Team.

<http://support.socketmobile.com>

#### By Phone:

- Direct: +1- 510-933-3020
- EU +49 9401 5299 036

## Limited Warranty

Socket Mobile Incorporated (Socket) warrants this product against defects in material and workmanship, under normal use and service, for one (1) year from the date of purchase. Product must be purchased new from a Socket Authorized Distributor or Reseller. Used products and products purchased through non-authorized channels are not eligible for this warranty support.

**EXCEPTIONS: Consumables such as batteries, removable cables, cases, straps, styli, memory cards, chargers, and CF-to-PC Card adapters: 90 day coverage only.**

An enhanced warranty is available separately for some Socket products. For more information, please visit: <http://support.socketmobile.com>

Incompatibility is not a defect covered by the Socket warranty. During the warranty period, Socket will, at its option, repair or replace the defective product at no charge when furnished with proof of retail purchase, provided that you deliver the product to Socket or to an authorized Socket Service Center.

The returned product must be accompanied by a return material authorization (RMA) number issued by Socket or by an authorized Socket Service Center. If you ship the product, you must use the original container or equivalent and you must pay the shipping charges to Socket. Socket will pay surface shipping charges back to any location in the contiguous United States. This warranty applies only to the original retail purchaser and is not transferable.

Socket may, at its option, replace or repair the product with new or reconditioned parts and the returned product becomes Socket property. Socket warrants the repaired or replaced products to be free from defects in material or workmanship for ninety (90) days after the return shipping date, or for the remainder of the original warranty period, whichever is greater.

This warranty does not cover the repair or replacement of products damaged by abuse, accident, lost products, use beyond Socket's published specifications, liquid immersion, misuse or misapplication, damages caused by an act of God, nor as a result of service or modification other than by Socket unless specifically described by Socket in product documentation. This warranty does not provide coverage for any product updates, for example, updates due to design changes, except as deemed necessary by Socket, and does not cover any calibration or adjustments necessary for product functionality. This warranty does not cover refurbishing cosmetic damages such as scratched paint, cases or LCD screens. This warranty is void if you install batteries into the product that were not supplied or approved by Socket.

SOCKET IS NOT RESPONSIBLE FOR INCIDENTAL OR CONSEQUENTIAL DAMAGES RESULTING FROM BREACH OF ANY EXPRESS OR IMPLIED WARRANTY, INCLUDING DAMAGE TO PROPERTY AND, TO THE EXTENT PERMITTED BY LAW, DAMAGES FOR PERSONAL INJURY. THIS WARRANTY IS IN LIEU OF ALL OTHER WARRANTIES INCLUDING IMPLIED WARRANTIES OF MERCHANTABILITY AND FITNESS FOR A PARTICULAR PURPOSE.

Some states do not allow limitation of implied warranties, or the exclusion or limitation of incidental or consequential damages, so the above limitations or exclusions may not apply to you. This warranty gives you specific legal rights, and you may also have other rights that vary from state to state. This product may contain fully tested, recycled parts, warranted as if new. For more warranty information, please visit: <http://support.socketmobile.com>



**PRODUCT DISPOSAL:** Your device should not be placed in municipal waste. Please check local regulations for disposal of electronic products.

## Disclaimer

EXCEPT TO THE EXTENT EXPRESSLY WARRANTED BY SOCKET COMMUNICATIONS, INC, THIS PRODUCT IS PROVIDED "AS IS" WITHOUT WARRANTY OF ANY KIND, EXPRESS OR IMPLIED, INCLUDING WITHOUT LIMITATION, THE IMPLIED WARRANTIES OF MERCHANTABILITY OR FITNESS FOR A PARTICULAR PURPOSE. EXCEPT TO THE EXTENT REQUIRED BY LAW, SOCKET DOES NOT ASSUME ANY PRODUCT LIABILITY ARISING OUT OF, OR IN CONNECTION WITH, THE APPLICATION OR USE OF ANY PRODUCT OR APPLICATION DESCRIBED HEREIN.

## Limited Software Warranty

**LIMITED WARRANTY.** SOCKET warrants that the original disk or CD ROM is free from defects for 90 days from the date of delivery of the SOFTWARE.

**CUSTOMER REMEDIES.** SOCKET'S entire liability and your exclusive remedy shall be, at SOCKET'S option, either (a) return of the price paid or (b) replacement of the SOFTWARE which does not meet SOCKET'S Limited Warranty and which is returned to SOCKET with a copy of your receipt. Any replacement SOFTWARE will be warranted for the remainder of the original warranty period or 30 days, whichever is longer. THESE REMEDIES ARE NOT AVAILABLE OUTSIDE OF THE UNITED STATES OF AMERICA.

**NO OTHER WARRANTIES.** SOCKET disclaims all other warranties, either express or implied, including but not limited to implied warranties of merchantability and fitness for a particular purpose, with respect to the SOFTWARE and the accompanying written materials. This limited warranty gives you specific legal rights. You may have others which vary from state to state.

**NO LIABILITY FOR CONSEQUENTIAL DAMAGES.** In no event shall SOCKET or its suppliers be liable for any damages whatsoever (including, without limitation, damages for loss of business profits, business interruption, loss of business information, or other pecuniary loss) arising out of the use of or inability to use the SOFTWARE, even if SOCKET has been advised of the possibility of such damages. Because some states do not allow the exclusion or limitation of liability for consequential or incidental damages, the above limitation may not apply to you.

**EXPORT LAW ASSURANCES.** You may not use or otherwise export or reexport the SOFTWARE except as authorized by United States law and laws of the jurisdiction in which the SOFTWARE was obtained. In particular, but without limitation, none of the SOFTWARE may be used or otherwise exported or reexported (a) into (or to a national or resident of) a United States embargoed country or (b) to anyone on the U.S. Treasury Department's list of Specially Designated Nationals or the U.S. Department of Commerce's Table of Denial Orders. By using the SOFTWARE, you represent and warrant that you are not located in, under control of, or a national or resident of any such country or on any such list.

**GOVERNMENT END USERS.** If the SOFTWARE is supplied to the U. S. Government, the SOFTWARE is classified as "restricted computer software" as defined in clause 52.227-19 of the FAR. The U. S. Government 's rights to the SOFTWARE are as provided in clause 52.227-19 of the FAR.

CONTROLLING LAW AND SEVERABILITY. This License shall be governed by the laws of the United States and the State of California. If for any reason a court of competent jurisdiction finds any provision, or portion thereof, to be unenforceable, the remainder of this License shall continue in full force and effect.

## Regulatory Compliance

FCC: Part 15, Class B

Industry Canada

CE: EN

RoHS and WEEE compliant

Electrical Safety EN60950, UL, CUL

EMI/RFI

Wi-Fi Alliance Certification

Bluetooth Certification (BQB test), Bluetooth QD ID B012762

USB IF Test

Microsoft Embedded Hand Held 6.5 Logo Test Certification

EnergyStar

EU/International: EN301 489-1, -17

EN61000-4-2: 1995, ESD  $\pm 8\text{kV}$  air/ $\pm 4\text{kV}$  contact

EN61000-4-3: 1997, radiated Immunity 3V/m

EN61000-4-4: 1995, EFT  $\pm 0.5\text{kV}$

EN61000-4-5: 1995, Surge  $\pm 0.5\text{kV}$

EN61000-4-6: 1

### FCC Interference Statement (USA)

This equipment has been tested and found to comply with the limits for a Class B digital device, pursuant to Part 15 of the FCC Rules. These limits are designed to provide reasonable protection against harmful interference in a residential installation. This equipment generates, uses, and can radiate radio frequency energy and, if not installed and used in accordance with the instructions, may cause harmful interference to radio communications. However, there is no guarantee that interference will not occur in a particular installation. If this equipment does cause harmful interference to radio or television reception, which can be determined by turning the equipment off and on, the user is encouraged to try to correct the interference by one of the following measures:

- Reorient or relocate the receiving antenna.
- Increase the separation between the equipment and receiver.
- Connect the equipment into an outlet on a circuit different from that to which the receiver is connected.
- Consult the dealer or an experienced radio/TV technician for help.
- FCC Caution: Any changes or modifications not expressly approved by the party responsible for compliance could void the user's authority to operate this equipment.

This device complies with Part 15 of the FCC Rules. Operation is subject to the following two conditions: (1) This device may not cause harmful interference, and (2) this device must accept any interference received, including interference that may cause undesired operation.



### **IMPORTANT: RADIATION EXPOSURE STATEMENT**

THIS EQUIPMENT COMPLIES WITH FCC RADIATION EXPOSURE LIMITS SET FORTH FOR AN UNCONTROLLED ENVIRONMENT. END USERS MUST FOLLOW THE SPECIFIC OPERATING INSTRUCTIONS FOR SATISFYING RF EXPOSURE COMPLIANCE. TO MAINTAIN COMPLIANCE WITH FCC RF EXPOSURE COMPLIANCE REQUIREMENTS, PLEASE FOLLOW OPERATION INSTRUCTIONS AS DOCUMENTED IN THIS MANUAL.

This PDA has been tested and demonstrated compliance when Bluetooth and WLAN are transmitting simultaneously. This PDA must not be co-located or operating in conjunction with any other antenna or transmitter.

For body worn operation, this device has been tested and meets the FCC RF exposure guidelines when used with the Socket accessories supplied or designated for this product. Use of other accessories may not ensure compliance with FCC RF exposure guidelines."

### **Industry Canada Statement:**

This device complies with RSS-210 of the Industry Canada Rules. Operation is subject to the following two conditions: (1) This device may not cause harmful interference, and (2) this device must accept any interference received, including interference that may cause undesired operation.



### **IMPORTANT: RADIATION EXPOSURE STATEMENT**

THIS EQUIPMENT COMPLIES WITH IC RADIATION EXPOSURE LIMITS SET FORTH FOR AN UNCONTROLLED ENVIRONMENT. END USERS MUST FOLLOW THE SPECIFIC OPERATING INSTRUCTIONS FOR SATISFYING RF EXPOSURE COMPLIANCE. TO MAINTAIN COMPLIANCE WITH IC RF EXPOSURE COMPLIANCE REQUIREMENTS, PLEASE FOLLOW OPERATION INSTRUCTIONS AS DOCUMENTED IN THIS MANUAL.

### **European Union Notice:**

Radio products with the CE marking comply with the R&TTE Directive (1999/5/EC), the EMC Directive (89/336/EEC) and the Low Voltage Directive (73/23/EEC) issued by the Commission of the European Community.

Compliance with these directives implies conformity to the following European Norms:

- EN 60950 Product Safety
- EN 300 328 Technical requirement for radio equipment
- EN 301 489-1/-17 General EMC requirements for radio equipment