

USER'S GUIDE

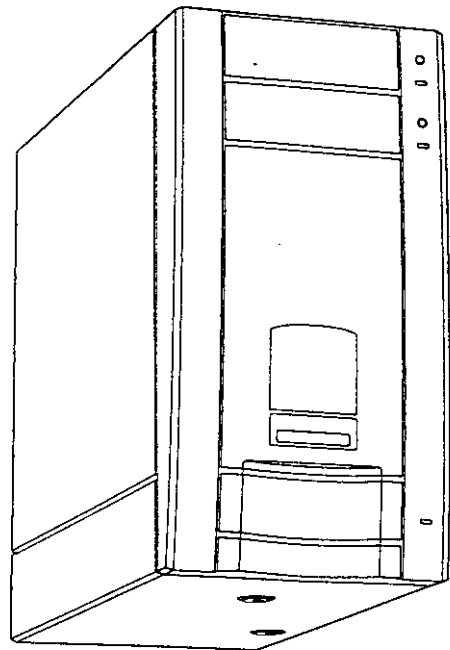

CDL1100

CD-ROM LIBRARY

DEC 10 1998

SC/MELTON

NOV 27 1998

INFORMATION

To prevent fire or shock hazard, do not expose the unit to rain or excessive moisture.

To avoid electrical shock, do not open the cabinet. The opening of the unit by unauthorized personnel voids the warranty. Refer servicing to qualified personnel only.

Because the disc drives in the CDL1100 use a laser beam that is harmful to the eyes, do not disassemble the disc drives. Refer servicing to qualified personnel only.

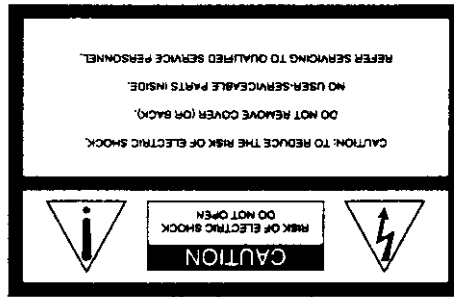

This symbol is intended to alert the user to the presence of uninsulated "dangerous voltage" within the product's enclosure that may be of sufficient magnitude to constitute a risk of electric shock to persons.

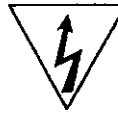

This symbol is intended to alert the user to the presence of important operating and maintenance (servicing) instructions in the literature accompanying the appliance.



Owner's record

The model and serial numbers are located on the bottom. Record these numbers in the spaces provided below. Refer to them whenever you call upon your dealer regarding this product.

Model No. _____

Serial No. _____



Caution

You are cautioned that any changes or modifications not expressly approved in this manual could void your authority to operate this equipment.

NOTICE

(For USA and Canada only)
If used in the USA, use the UL LISTED power cord specified below. If used in Canada, use the CSA CERTIFIED power cord specified below.

DO NOT USE ANY OTHER POWER CORD.

For ~~100-120V~~ *115V*

Plug Cap: Parallel blade with ground pin. (NEMA 5-15P)
Cord: Type SJT, three 16 or 18 AWG wires.
Length: Maximum 8.2 feet (2.5 m)
Rating: Minimum 10A, 125V

The power cord for the 220-240V AC area is not supplied.

REMARQUE

THIS NOTICE IS APPLICABLE FOR USA AND CANADA ONLY.

CETTE REMARQUE NE CONCERNE QUE LES ETATS-UNIS ET LE CANADA.

En cas d'utilisation aux Etats-Unis, n'utiliser que le cordon d'alimentation inscrit sur LISTE UL et specifié ci-dessous pour utilisation.

En cas d'utilisation au CANADA, n'utiliser que le cordon d'alimentation CERTIFIE par CSA et specifié ci-dessous pour utilisation.

N'UTILISER AUCUN AUTRE CORDON D'ALIMENTATION

Sur ~~100-120V~~ *115V*

Fiche: Lame parallele avec une broche de mise a la terre.

(Configuration NEMA 5-15P)

Cordon: Type SJT, trois fils 16 ou 18 AWG. (type blindé)

Longueur: Maximum 8.2 pied (2.5 m)

Capacité: Minimum 10A, 125V

Le cordon d'alimentation pour la région de 220 à 240 CA n'est pas fourni.

(For countries other than USA and Canada)

NOTICE

In countries other than the USA and Canada, use the power cord set approved by the appropriate testing organization for the specific countries where this unit is to be used.

For continued compliance with European safety regulations, the power cord shall be marked with <HAR> and the plug shall be appropriate for the country in which the device is to be installed and operated.

HINWEIS

Außerhalb der USA und von Kanada muß ein Netzkabel benutzt werden, das von der zuständigen Testbehörde des Staates zugelassen ist, in dem das Gerät installiert und betrieben wird.

Damit auch weiterhin die europäischen Sicherheitsvorschriften eingehalten werden, ist das Netzkabel mit der Aufschrift "HAR" zu kennzeichnen. Außerdem muß der Netzstecker den Anforderungen des jeweiligen Staates entsprechen, in dem das Gerät installiert und betrieben wird.

WARNING

(For Customers in the United Kingdom)
THIS APPARATUS MUST BE EARTHED.

CAUTION

The entire system power is controlled by the MAIN switch on the rear panel.

Die Systemversorgung wird am MAIN-Schalter an der Rückseite ein- und ausgeschaltet.

Selecting the Voltage

Set the voltage selector on the rear side to the appropriate voltage.
United States and Canada: Set to 120 V
Europe: Set to 230 V

Selection du voltage

Placer le sélecteur de voltage sur l'indication de la tension appropriée.
Etats-unis et Canada: Régler sur 120 V
Europe: Régler sur 230 V

Wahl der Stromspannung

Stellen Sie den Spannungswähler auf der Rückseite auf die richtige Spannung ein.
Vereinigte Staaten und Kanada: Auf 120 V stellen
Europa: Auf 230 V stellen

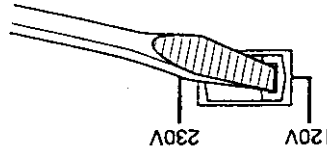

LASER SAFETY INFORMATION

The CD-ROM drives used in the CDL1100 CD-ROM Library are certified as Class 1 laser products per EN60825 and CFR 21 SUB J under the U.S. Department of Health and Human Services (DHHS) Radiation Performance Standard according to the Radiation Control for Health and Safety Act of 1968. This CD-ROM Library is classified as a CLASS 1 LASER PRODUCT per EN60825-1. The CLASS 1 LASER PRODUCT label is located on the rear panel. Bei dieser CD-ROM-Bibliothek handelt es sich um ein LASERPRODUKT DER KLASSE 1 nach EN60825-1. Das Etikett mit der Angabe LASERPRODUKT DER KLASSE 1 befindet sich an der Rückwand.

CLASS 1 LASER PRODUCT
LASER KLASSE 1 PRODUKT
LUOKAN 1 LASERLAITTE
KLASS 1 LASERAPPARAT

This label is affixed on the back of the front bezel of the CD-ROM Library.
 Dieses Etikett ist an der Rückseite des vorderen Randes der CD-ROM-
 Bibliothek angebracht.
 Dit label bevindt zich achteraan op het frontdeksel van de CD-ROM Library.
 Etiketten är fäst på kontakten till CD-ROM-bibliotekets främre infattning.
 Denne mærkat skal snrbringes bag på den forreste holder til CD-ROM-
 biblioteket.
 Tämä tarra on kiinnitetty CD-ROM Libraryn etuosassa olevan pitelevyn
 takaosaan.
 Denne etiketten er festet bak på frontpanelet til CD-ROM-biblioteket.

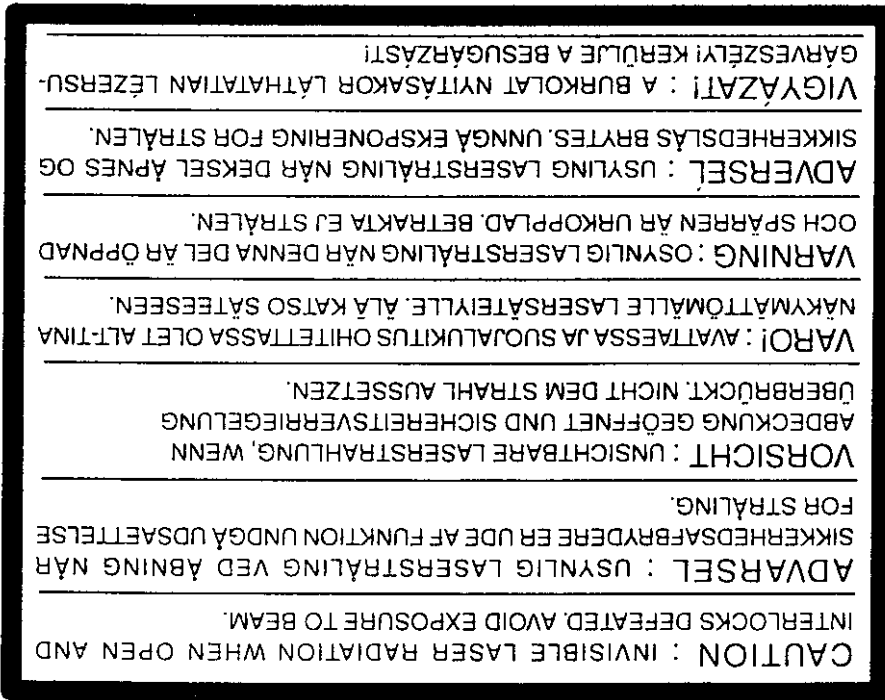

Das Tragen von Brillen oder Kontaktlinsen vergrößert die Gefahr. Da der interne Laserstrahl Augenverletzungen verursachen kann, darf das Gehäuse nicht geöffnet werden. Überlassen Sie Wartungsarbeiten stets nur einem Fachmann.

ACHTUNG

Use of controls, adjustments or performing procedures other than those specified in this manual may result in hazardous laser radiation exposure.

WARNING

<p>Laser use Type: Semiconductor laser GaAlAs Wave Length: 780 nm Laser output: Max 44.6 μW*</p>	<p>* This output is the value measured at a distance of 200 mm from the objective lens surface on the Optical Pick-up Block with 7 mm aperture. (DHH5 Sub clause 1040)</p>
<p>Laser Type: CD-ROM Halbleiterlaser GaAlAs Wellenlänge: 780 nm Laser-Ausgangsleistung: Max 44.6 μW*</p>	<p>* In einem Abstand von 200 mm vor der Linse-Oberfläche auf einem optischen Abtastblock mit einer 7-mm-Blende gemessener Wert.</p>
<p>Laser Type: CD-ROM Halveder GaAlAs laser Bølgelængde: 780 nm Laserutnivå: max 44.6 μW*</p>	<p>* Denna utnivå har mätts på 200 mm avstånd från objektvinsen på det optiska pick-upblocket och med 7 mm öppning.</p>
<p>Laser Type: CD-ROM Halvedarlaser av typ GaAlAs Våglängd: 780 nm Laser-output: Max 44.6 μW*</p>	<p>* Outputtet er den mätte værdi ved en afstand på 200 mm fra objektivets overflade på den optiske opsamlingsblok med 7 mm kontur.</p>
<p>Laser Type: CD-ROM Halvederlaser GaAlAs Bølgelængde: 780 nm Laserteho: Max 44.6 μW*</p>	<p>* Tämä arvo on mitattu 200 mm:n etäisyydellä laserlukupään linssin pinnasta, kun lukupäässä on 7 mm:n aukko.</p>

Zu Ihrer Sicherheit

VORSICHT

Um Feuergefahr und die Gefahr eines elektrischen Schlag zu vermeiden, darf das Gerät weder Regen noch Feuchtigkeit ausgesetzt werden.

Um einen elektrischen Schlag zu vermeiden, darf das Gehäuse nicht geöffnet werden. Überlassen Sie Wartungsarbeiten stets nur einem Fachmann.

Zur besonderen Beachtung

Zur Sicherheit

Sollte ein fester Gegenstand oder Flüssigkeit in das

Geräteinnere gelangen, ziehen Sie das Stromkabel aus der

Wandsteckdose, und lassen Sie das Gerät von einem Fachmann

überprüfen, bevor Sie es weiter verwenden.

Beim Herausziehen des Kabels fassen Sie stets am Stecker und niemals am Kabel selbst an.

Zur Aufstellung

Stellen Sie das Gerät weder auf eine weiche Unterlage (z.B. eine Decke oder einen Teppich), noch in die Nähe von Vorhängen, Tapeten usw., da hierdurch die Ventilationsöffnungen blockiert werden könnten.

Zur Reinigung

Reinigen Sie das Gehäuse, die Steuerkonsole und die Bedienelemente mit einem trockenen, weichen Tuch oder mit einem weichen Tuch, das mit einem milden Reinigungsmittel leicht angefeuchtet ist. Verwenden Sie keinesfalls Lösungsmittel, wie Alkohol oder Reinigungsbenzin, da diese die Gehäuseoberfläche angreifen.

HINWEIS

Diese Ausrüstung erfüllt die Europäischen EMC-Bestimmungen für die Verwendung in folgender/folgenden Umgebung(en):

- Wohngebieten

- Gewerbegebiete

- Leichtindustriengebiete

(Diese Ausrüstung erfüllt die Bestimmungen der Norm EN55022, Klasse B.)

This device complies with Part 15 of the FCC Rules. Operation is subject to the following two conditions: (1) This device may not cause harmful interference, and (2) this device must accept any interference received, including interference that may cause undesired operation.

Note:

This equipment has been tested and found to comply with the limits for a Class B digital device, pursuant to Part 15 of the FCC Rules. These limits are designed to provide reasonable protection against harmful interference in a residential installation. This equipment generates, uses, and can radiate radio frequency energy and, if not installed and used in accordance with the instructions, may cause harmful interference to radio communications. However, there is no guarantee that interference will not occur in a particular installation. If this equipment does cause harmful interference to radio or television reception, which can be determined by turning the equipment off and on, the user is encouraged to try to correct the interference by one or more of the following measures:

- Reorient or relocate the receiving antenna.
- Increase the separation between the equipment and receiver.
- Connect the equipment into an outlet on a circuit different from that to which the receiver is connected.
- Consult the dealer or an experienced radio/TV technician for help.

For CDL1100 customers in Canada

This class B digital apparatus meets all requirements of the Canadian Interference-Causing Equipment Regulations.

Pour les utilisateurs de CDL1100 au Canada

Cet appareil numérique de la Classe B respecte toutes les exigences du Règlement sur le matériel brouilleur du Canada.

Für Käufer des Modells CDL1100 in Deutschland

Diese Ausrüstung erfüllt die europäischen EMC-Richtlinien für die Verwendung in folgender/folgenden Umgebung(en):

- Wohngebieten
- Gewerbegebiete
- Leichtindustriengebiete

(Diese Ausrüstung erfüllt die Bestimmungen der Norm EN55022, Klasse B.)

Hinweis

Der Benutzer wird darauf hingewiesen, daß die im Land geltenden Vorschriften bzw. die EMC-Richtlinien auch für integrierte Systeme gelten.

DISCLAIMER

While every effort has been made to ensure the accuracy of all information in this document, we assume no liability to any party for any loss or damage caused by errors or omissions or by statements of any kind in the User's Manual, its updates, or special editions, whether such errors are omissions or statements resulting from negligence, accident or any other cause. We further assume no liability arising out of the application or use of any products or system described herein, nor any liability for incidental or consequential damages arising from the use of this document. We disclaim all warranties regarding the information contained herein, whether expressed, implied or statutory, including implied warranties of merchantability or fitness for a particular purpose.

We make no representation that the interconnection of products in the manner described herein will not infringe on existing or future patent rights, nor do the descriptions contained herein imply the granting of license to make, use, or sell equipment constructed in accordance with this description.

We reserve the right to make changes without further notice to any products herein to improve reliability, function, or design.

Reproduction in whole or in part without written permission is prohibited.

3M is a trademark of Minnesota Mining & Manufacturing Co.

Table of Contents

12	About This Manual
13	Overview
14	Features
14	Identifying the Parts
14	Front view
16	Rear view
17	Control panel
18	Unpacking
19	Unlocking the CD-ROM Library
19	Removing the shipping screws
19	Checking the shipping pole position
20	Setting Up the SCSI Interface
21	Connecting SCSI Cables
21	Connecting as single or last device
22	Caution for connecting the SCSI cable
22	Connecting in the middle of a SCSI chain
23	Notes on connecting SCSI Cables
24	Where to mount the ferrite core
24	Selecting the power voltage
25	Connecting Audio Equipment
25	Notes on using the LINE OUT jack
27	Connecting the AC Power Cord
27	Turning on/off the Power
18	Chapter 2 Installation
13	Chapter 1 Introduction
13	Overview
14	Features
14	Identifying the Parts
14	Front view
16	Rear view
17	Control panel
18	Unpacking
19	Unlocking the CD-ROM Library
19	Removing the shipping screws
19	Checking the shipping pole position
20	Setting Up the SCSI Interface
21	Connecting SCSI Cables
21	Connecting as single or last device
22	Caution for connecting the SCSI cable
22	Connecting in the middle of a SCSI chain
23	Notes on connecting SCSI Cables
24	Where to mount the ferrite core
24	Selecting the power voltage
25	Connecting Audio Equipment
25	Notes on using the LINE OUT jack
27	Connecting the AC Power Cord
27	Turning on/off the Power
28	Menu Map
29	About the Operation Modes
29	Selecting the normal mode
29	Selecting the manual mode
30	Normal Mode Operations
30	Loading a disc
31	Unloading a disc
32	Displaying SCSI ID
32	Displaying the error history
33	Manual Mode Operations
33	Loading a disc
33	Unloading a disc
34	Moving a disc to a different slot
35	Positioning the carrier to a slot
35	Initializing slots
36	Parking the carrier
36	Displaying the error history
37	Maintenance Schedule
37	Cleaning the Drives
38	Cleaning a Disc
38	For Technical Support
39	Operational Problems
39	Warning you can correct
40	Startup Warning Message
41	Other Error Message
42	If 'RST Sensor Err' appears on the screen
43	Caution
44	Transporting the CD-ROM Library
45	When temporarily moving the unit
46	Specifications
47	Chapter 6 General Information
39	Chapter 5 Troubleshooting
39	Operational Problems
39	Warning you can correct
40	Startup Warning Message
41	Other Error Message
42	If 'RST Sensor Err' appears on the screen
43	Caution
44	Transporting the CD-ROM Library
45	When temporarily moving the unit
46	Specifications

This manual describes how to use the CDL1100 CD-ROM Library to store CD-ROM discs and access them with the built-in CD-ROM drives. It consists of six chapters and an index.

Chapter 1 Introduction

Gives an overview of the CD-ROM Library and its functions.

Chapter 2 Installation

Describes how to unpack and set up the CD-ROM Library.

Chapter 3 Operation

Explains how to operate the CD-ROM Library from the control panel. You can also perform many of the operations from the host computer via the SCSI interface.

Chapter 4 Maintenance

Covers information on how to maintain the CD-ROM Library.

Chapter 5 Troubleshooting

Helps you troubleshoot problems that may occur during operations of the CD-ROM Library.

Chapter 6 General Information

Contains cautions, shipping, and specifications information on the CD-ROM Library.

Conventions

The CD-ROM Library is also referred to as "the unit" throughout this manual.

The CDLI100 CD-ROM Library is a CD-ROM library system that combines high performance "jukebox" robotics with two internal CD-ROM drives to provide access up to 100 CD-ROM discs stored in the system.

- The system consists of the following major components:
- Robotics (the mechanism for storing and moving discs)
 - CD-ROM drive A
 - CD-ROM drive B
 - Mailbox (Import/Export CD)

Overview

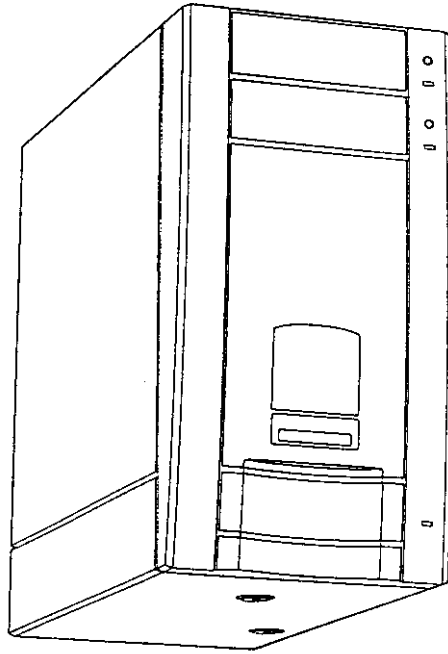

The system supports SCSI-2 jukebox commands. This means that you can control most of the CD-ROM Library functions from a host computer via the SCSI interface, or alternately from the control panel.

The RS-232C serial port allows for diagnostics while servicing the CD-ROM Library.

Features

The CD-ROM Library comes with the following features:

Compact design

The CD-ROM Library weighs only 13.7 kg (30.41 lb) with a small footprint that allows for desktop installation. It can store up to one hundred 12-cm CD-ROM discs.

24 discs.

High-speed CD-ROM drives

The 2-speed Partial CAV CD-ROM drives enable high-speed access to data stored on the CD-ROM discs.

Simple loading and unloading of discs

The built-in mailbox provides a disc drawer through which you can easily load and unload a disc. Control of the mailbox can be performed via SCSI commands or from the control panel.

Easy maintenance

The absence of any cooling fan makes operation quiet and maintenance easy.

Identifying the Parts

Be sure to familiarize yourself with the names and functions of parts on the CD-ROM Library.

Front view

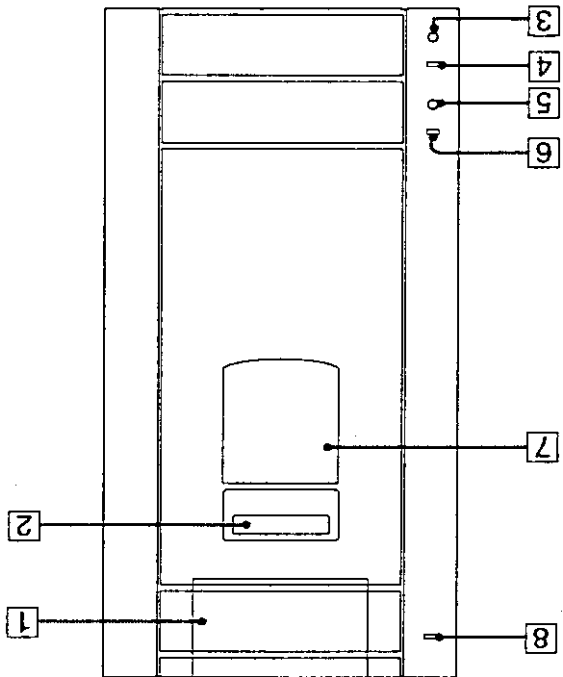

1 Mailbox
Use it to load or unload discs.

2 Display window
Display current status of the CD-ROM Library.

3 LINE OUT B jack
Plug in an audio connecting cord to connect to an audio equipment for audio output.

4 Drive B indicator
Lights in amber when drive B is being accessed, or in yellow when there is audio output from LINE OUT B jack.

5 LINE OUT A jack
Plug in an audio connecting cord to connect to audio equipment for audio output.

6 Drive A indicator
Lights in amber when drive A is being accessed, or in yellow when there is audio output from LINE OUT A jack.

7 Control Panel
Use it to control some of the CD-ROM Library functions such as loading or unloading a disc.

8 POWER indicator
Lights in green when the power is turned on, or flashes in green and red alternately when an error occurs.

Note

When a hardware error occurs during the power-on diagnostics, the POWER indicator flashes green and red alternately. Please check the LCD display window for any error message for troubleshooting the errors.
RST Sensor Err appears if the power is turned on without removing the shipping screws or the shipping pole.
In this case, remove the shipping screws and reset the CD-ROM Library. Refer to "If RST Sensor Err appears on the screen" on the Chapter 5 Troubleshooting.

'Gmp Err. nfd', 'Gmp Err. hld', or 'Return Err. ret'

← 11

- 1 **VOLTAGE SELECTOR switch**
Select 120V or 230V.
- 2 **POWER switch**
Press to turn on/off the power.
- 3 **AC power receptacle**
Plug the AC power cord into here.
- 4 **SCSI connectors**
Plug the SCSI cables into here to connect to the host computer or other SCSI devices.
- 5 **DRIVE B DIP switches**
Assign a SCSI ID to CD-ROM drive B.
- 6 **DRIVE A DIP switches**
Assign a SCSI ID to CD-ROM drive A.
- 7 **ROBOTICS DIP switches**
Assign a SCSI ID to the robotics of the CD-ROM Library.
- 8 **RS-232C connector**
Connect an RS-232C interface cable for diagnostics.
- 9 **Storage spaces**
Holes for storing the shipping screws.

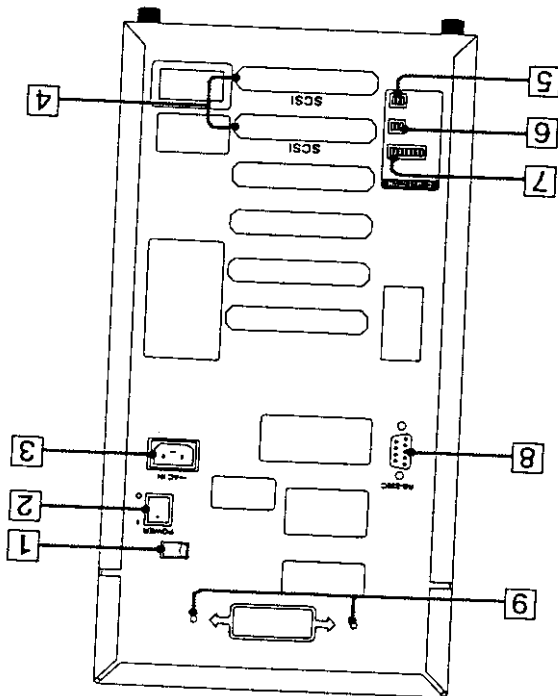

Rear view

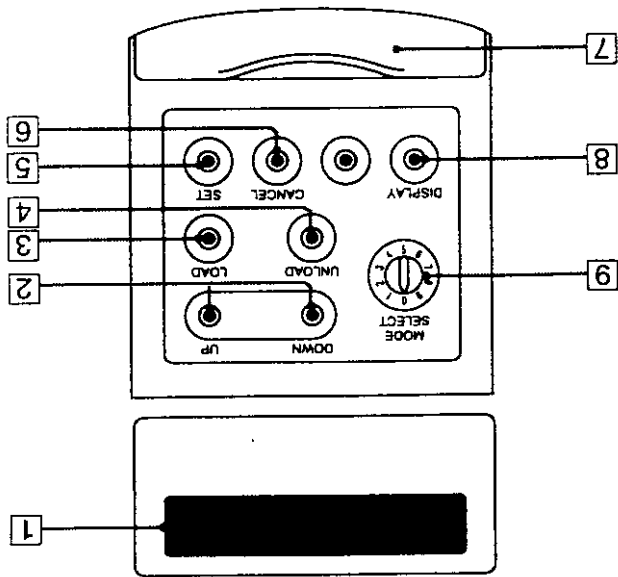

1 Display

Gives current status of the CD-ROM Library.

2 UP/DOWN keys

Press to show an item on the menu.

3 LOAD key

Press to load a disc into the mailbox.

4 UNLOAD key

Press to unload a disc through the mailbox.

5 SET key

Press to select the current menu item.

6 CANCEL key

Press to cancel the current operation.

7 Cover

Slide the cover to reveal or hide the control panel keys and dial.

8 DISPLAY key

Press to display a function.

9 MODE SELECT dial

Select "0" (default) for normal mode or "1" for manual mode operation. Do not select any other numbers as they are reserved for qualified service personnel.

This chapter describes how to unpack and set up the CD-ROM Library.

Unpacking

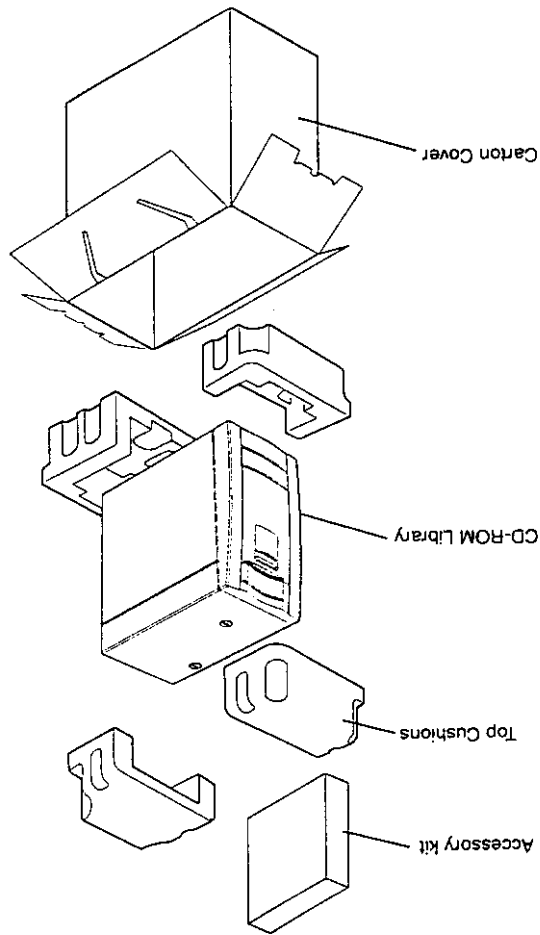

Follows the steps below to unpack the CD-ROM Library.

- 1 Place the package on a flat and sturdy surface. Make sure the top of the CD-ROM Library is facing up.
 - 2 Open the carton cover.
 - 3 Carefully lift and remove the top cushions.
 - 4 Take out the accessory box. Then lift up the CD-ROM Library from the carton tray.
 - 5 Remove the protective sheet from the CD-ROM Library.
- Carefully check the package for signs of shipping damage. Immediately report any damage to the carrier and dealer.
 - Reassemble the shipping carton and store it away for future shipping or storing the CD-ROM Library.

Note

Unlocking the CD-ROM Library

Before shipment, the CD-ROM Library has been locked to protect it from shock and vibration during transportation. Be sure to unlock it before operation, as follows:

Removing the shipping screws

1 Tilt the CD-ROM Library sideways, then loosen and remove the two shipping screws at the bottom.

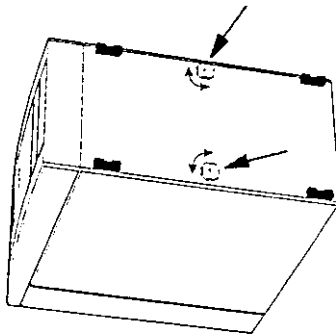

2 Insert them in the two storage holes on the rear side of the unit. Turn the screws to secure them as illustrated.

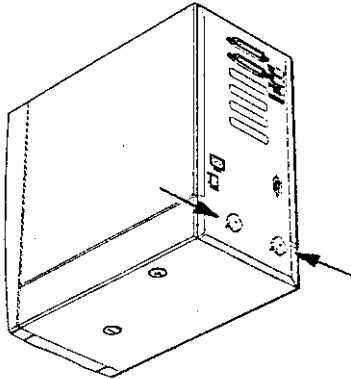

Checking the shipping pole position

Make sure the shipping pole is in the "operating" position shown below.

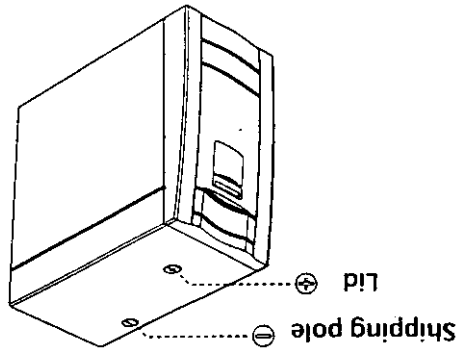

Before connecting the CD-ROM Library to the host computer and other SCSI devices, you need to assign a SCSI ID to each of the following components in the unit:

- Robotics (mechanism for storing and moving CD-ROM discs)
- Drive A
- Drive B

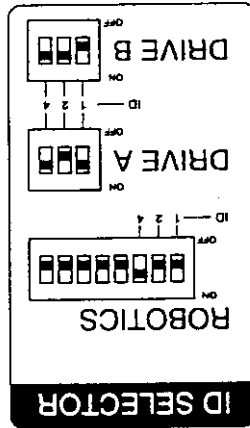

1 Check all SCSI devices connected to the host computer and find out their IDs.

2 Use the ROBOTICS, DISK DRIVE A or DRIVE B DIP switches on the rear side of the CD-ROM Library to assign an ID number still unused.

SCSI ID	1	2	4
0	OFF	OFF	OFF
1	ON	OFF	OFF
2	OFF	ON	OFF
3	ON	ON	OFF
4	OFF	OFF	ON
5	ON	OFF	ON
6	OFF	ON	ON
7	ON	ON	ON

Default ID
 ROBOTICS: 4
 DRIVE A: 5
 DRIVE B: 6

Before connection, you need to prepare the required number of SCSI cables (not supplied). The CD-ROM Library uses standard 50-signal shielded SCSI interconnecting cable.

Make sure the required number of addresses are available on the host computer's SCSI bus. If necessary, you can install an adapter into the host computer to increase the number of addresses. Contact your dealer, reseller or system supplier directly for more information.

About SCSI termination

When connecting the CD-ROM Library to the host's SCSI port, verify that the host has a termination installed (either internally or externally). Long cable runs, approaching the 19.7 feet (6 meter) total cable length limit including 5.2 feet (1.6 meter) internal cable length inside the library, or host systems using synchronous or fast SCSI protocols may benefit from the use of active or "forced perfect" termination. See the documentation supplied with the host computer for more information on SCSI termination.

Connecting as single or last device

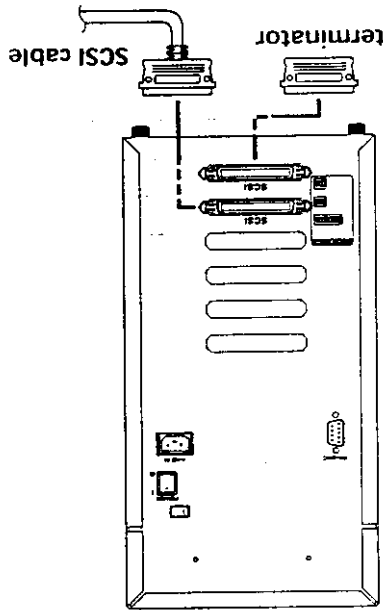

If the CD-ROM Library is the only SCSI device connected, or the last device connected in a SCSI chain, take the following steps:

- 1 Make sure the POWER switch is off (at the "O" position).
- 2 Plug one end of the SCSI cable into the host computer's SCSI port, and the other end into either one of the SCSI connectors on the CD-ROM Library.
- 3 Plug the supplied SCSI terminator into the unused SCSI connector, then close the connectors' locking balls.

- 1 Make sure the POWER switch is off (at the "O" position).
 - 2 Use one of the SCSI connector to connect to the host computer's SCSI port.
- If the CD-ROM Library is connected in the middle of a SCSI chain, take the following steps:

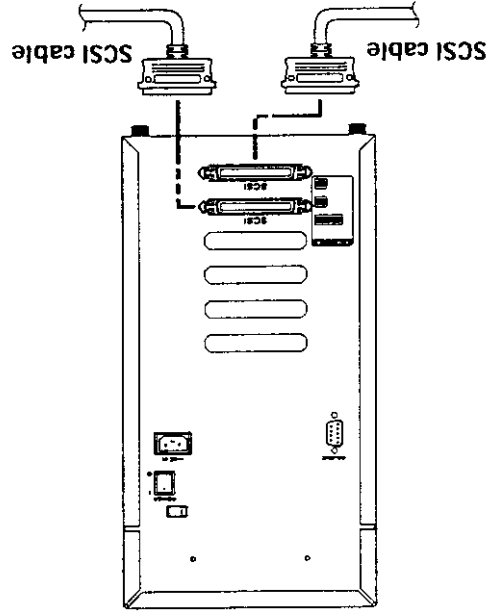

Connecting in the middle of a SCSI chain

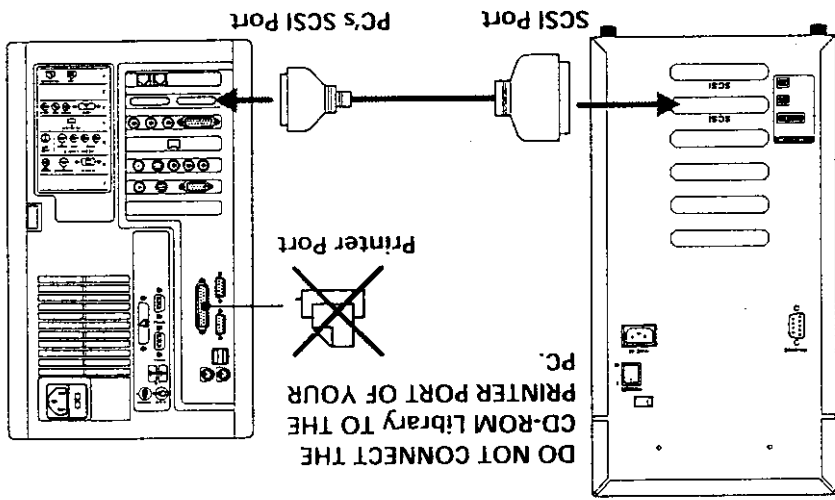

Ensure that the SCSI cable is properly attached to a host computer's SCSI adaptor port before powering on the CD-ROM Library. - Failure to attach the SCSI cable correctly will result in damage to the CD-ROM Library.

Caution for connecting the SCSI cable

Notes on connecting SCSI Cables

A ferrite core designed to suppress noise in the SCSI cable is supplied. Attach the ferrite core to the SCSI cable as shown below.

How to mount the ferrite core

1 Insert the SCSI cable into the groove of the opened ferrite core.

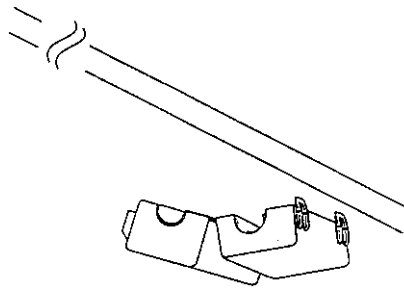

2 Close the ferrite core around the cable.

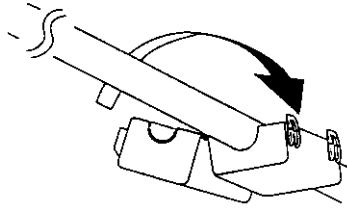

3 Make sure that the core is locked. It should audibly snap into place.

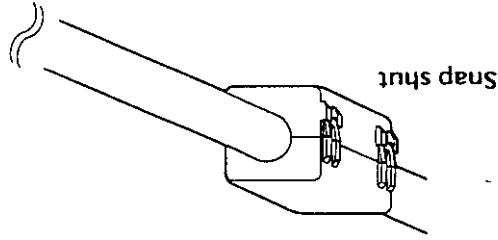

Note

On some cables, it may not be possible to mount the ferrite core.

Selecting the power voltage

When required, use the VOLTAGE SELECTOR switch on the rear side of the unit to select 120 V or 230 V for the (1) 120 V regions and 220-240 V regions respectively.

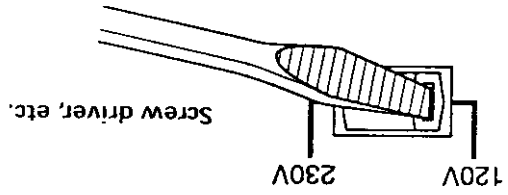

Handwritten notes: 'KIL-V-X' with an arrow pointing to the switch, and '≠' with an arrow pointing to the text above.

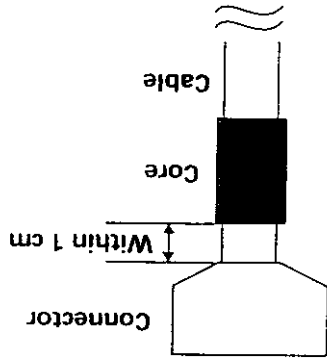

Location on SCSI cable

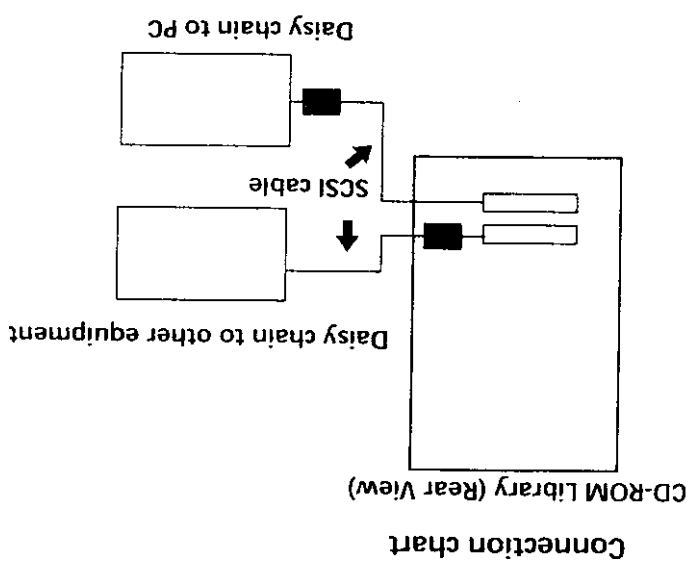

Connection chart

Where to mount the ferrite core



Connect an audio equipment, such as amplified speakers, to the LINE OUT jack. Do not connect headphones.

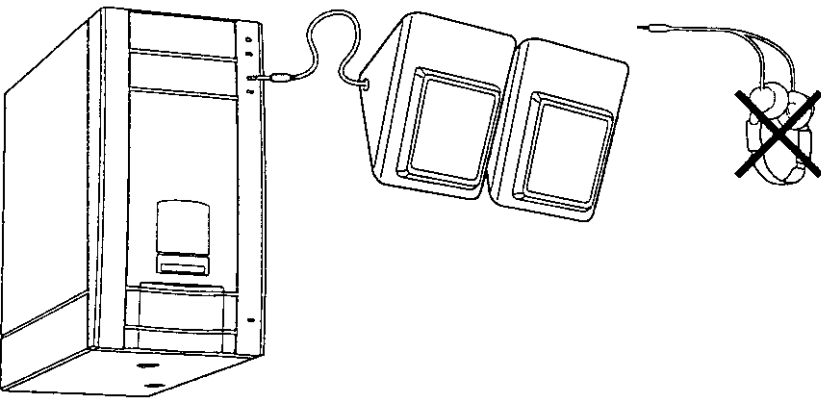

Notes on using the LINE OUT jack

Please attach the supplied ferrite core to audio cable that you connect to the LINE OUT terminal. Attach the ferrite core as shown below.

1 Make a **double loop** in the audio cable near the end which you will be connecting to the LINE OUT terminal.

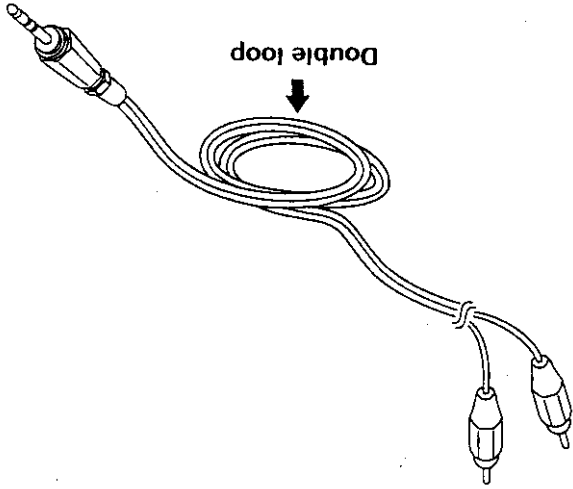

2 Set the tripled part of the cable into the groove in the opened ferrite core.

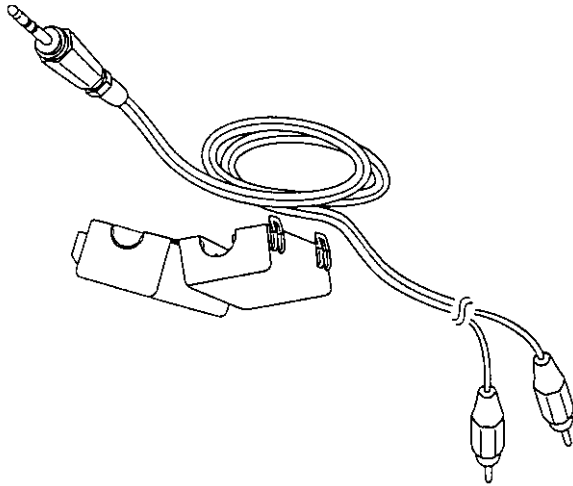

3 Close the ferrite core, making sure that it is locked. It should shut with an audible snap.

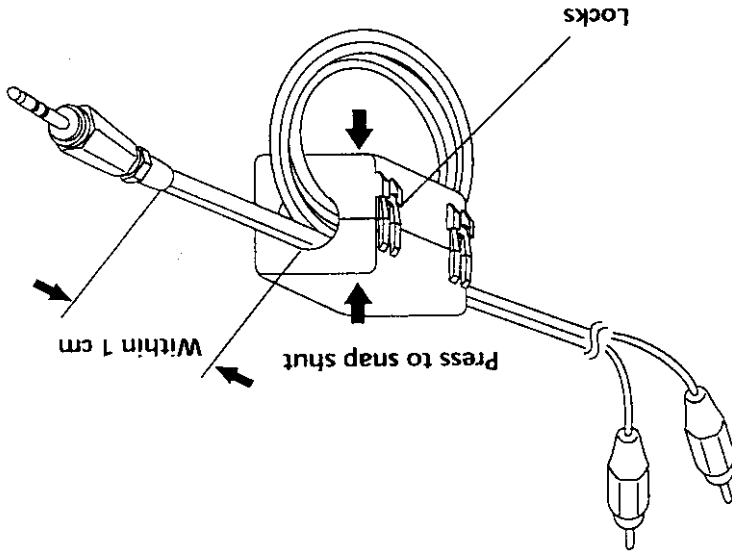

Connecting the AC Power Cord

Be sure to use an AC power cord appropriate for the voltage, then take the following steps to connect.

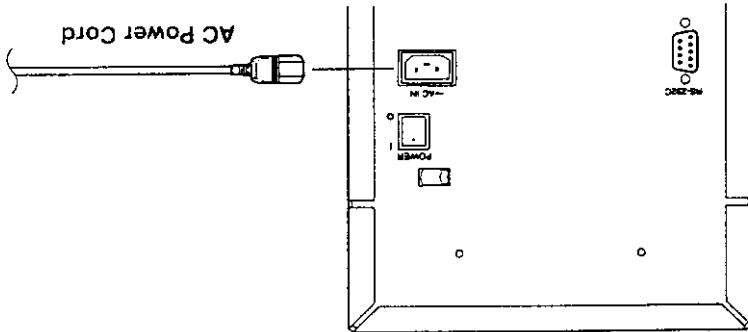

1 Check the VOLTAGE SELECTOR switch and the POWER switch on the rear side of the CD-ROM Library. Make sure the voltage is correct and the power switch is off.

2 Plug one end of the supplied AC power cord into the AC power receptacle, and the other end to an AC outlet.

Turning on/off the Power

Caution

Do not turn on the CD-ROM Library until you have set up SCSI IDs for the robotics and the CD-ROM drive(s). Otherwise, the CD-ROM Library may not function correctly.

To turn on the CD-ROM Library

Press the POWER switch so that it is at the "I" position. The CD-ROM Library starts up and indicates its model name and version on the display. The "Calibration" message follows. Finally, when the "Normal Mode" message appears, the CD-ROM Library is ready for operation.

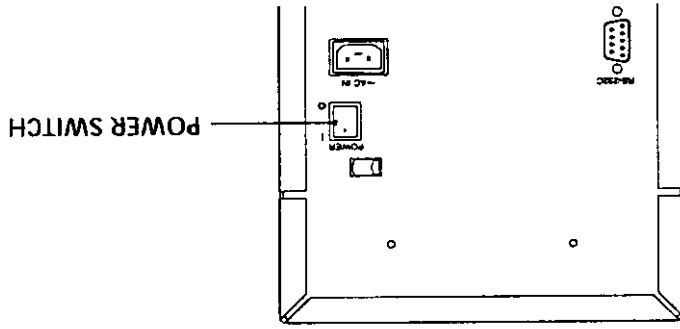

If an error message appears on the display during startup, see chapter 5 for troubleshooting information.

While you can perform most of the CD-ROM Library functions from the host computer, this chapter describes how to operate it using the control panel.

Menu Map

The following menu map contains the complete lists of all menus and submenus.
Use the MODE SELECT switch to select an operation mode, as follows:

MODE SELECT Switch	Mode	Item
0	Normal	LOAD UNLOAD ID Display Error History
1	Manual	LOAD UNLOAD MOVE POSITION INIT PARK Error History
2	Adjust	(For service personnel only)
3	Memory	(For service personnel only)
4	Agng	(For service personnel only)
5	History	(For service personnel only)
6	Diagnostics	(For service personnel only)
7-9	(Reserved)	(For service personnel only)

About the Operation Modes

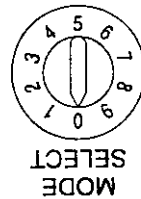

You can turn the MODE SELECT dial on the control panel to select a mode to control the CD-ROM Library. Select only "0" (normal mode) or "1" (manual mode) position. Do not select any other numbers as they are reserved for service personnel.

Selecting the normal mode

When shipped, the MODE SELECT dial has been set at the "0" position. If you turn on the power with the MODE SELECT dial set at this position, the CD-ROM Library will operate in the normal mode and you can control the CD-ROM Library from the host computer or the control panel.

Selecting the manual mode

To select the manual mode, set the MODE SELECT dial to the "1" position, then turn on the power. When in the manual mode, the CD-ROM Library can be controlled only from the control panel.

Normal Mode Operations

In the normal mode, you can perform many of the CD-ROM Library functions from the host computer using SCSI commands. In addition, you can perform the following operations from the control panel.

Note

You cannot load or unload discs using the control panel if they have been disabled with the RESERVE or PREVENT MEDIUM REMOVAL command.

Loading a disc

You can load a disc into a specified slot of the CD-ROM Library using the following steps.

- 1 Press LOAD.
The mailbox opens and the media tray slides out.

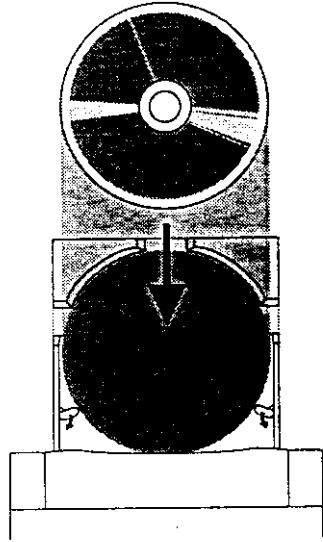
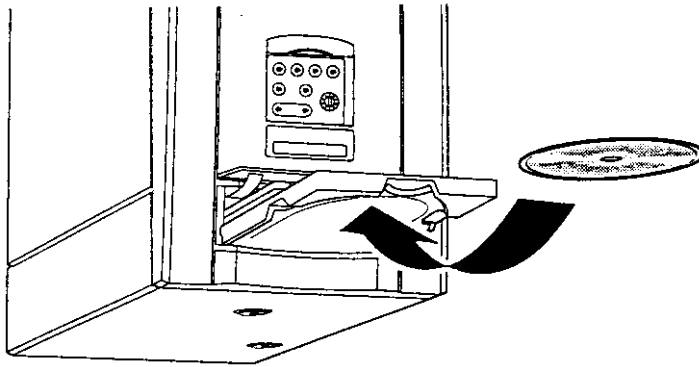

Unloading a disc

You can remove the disc from a specified slot of the CD-ROM Library using the following steps.

1 Press UNLOAD.

By default, the highest slot number being used is displayed (001 in this example).

Unload Add=[001]

2 If necessary, press UP or DOWN to select a different slot. Then press SFT.

3 Remove the disc from the media tray.

4 To remove more discs, repeat the steps starting from step 2. (The new number shown will be less than the last one.)
To cancel the operation, press CANCEL.

Note

If you press SFT while a disc is still in the media tray, the "Remove disc!" message will appear and the media tray will slide out again.

2

Place a disc into the media tray.

By default, the smallest slot number available is displayed (001 in this example).

Load Add=[001]

3 If necessary, press UP or DOWN to select a different slot. Then press SFT (or push the media tray).

4 After the disc is stored, the mailbox opens again so that you can load

additional discs.

To cancel the operation, press CANCEL. Alternatively, you can also press SFT or push the media tray without any disc loaded into the tray.

Displaying SCSI ID

Use the following steps to find out the SCSI IDs of the robotics, drive A, or drive B.
 Press DISPLAY until the following message appears. (The example here indicates that the IDs for the robotics, drive A and drive B are 4, 5, and 6 respectively.)

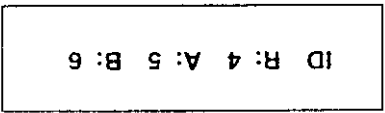

To cancel the operation at any time
 Press CANCEL.

Displaying the error history

If you want to check the error history and additional information, take the steps below to see the last 10 errors.

1 Press DISPLAY until the following message appears.

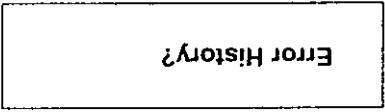

2 Press SFT to enter the error history mode.

3 Use UP or DOWN to cycle through the 10 most recent errors (Err0 being the newest error).

Err0:xxx -> Err1:xxx -> Err2:xxx -----> Err9:xxx

4 To see additional information related to the current error, press DISPLAY to cycle through the following:

Main Address -> Sub Address -> ATDrA (drive A access count) -> ATDrB (drive B access count) -> MTCLP (Clip count) -> Hours (power-on duration)

5 Press CANCEL to cancel this operation.

In the manual mode, you control the CD-ROM Library only from the control panel.

Loading a disc

You can load a disc into a specified slot of the CD-ROM Library using the following steps:

- 1 Press LOAD.
The mailbox opens and the media tray slides out.
- 2 Place a disc into the media tray.
By default, the smallest slot number available is displayed (1 in this example).

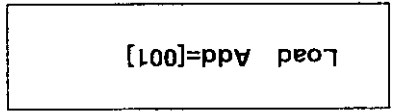

- 3 If necessary, press UP or DOWN to select a different slot. Then press SET (or push the media tray).
- 4 After the disc is stored, the mailbox opens again so that you can load additional discs.

To cancel the operation, press CANCEL. Alternatively, you can also press SET or push the media tray without any disc loaded into the tray.

Unloading a disc

You can remove the disc from a specified slot of the CD-ROM Library using the following steps:

- 1 Press UNLOAD.
By default, the highest slot number being used is displayed (001 in this example).

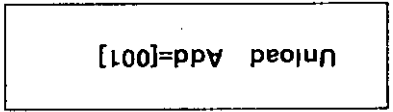

- 2 If necessary, press UP or DOWN to select a different slot. Then press SET.
- 3 Remove the disc from the media tray.

- 4 To remove more discs, repeat the steps starting from step 2. (The new number shown will be less than the last one.)
To cancel the operation, press CANCEL.

Moving a disc to a different slot

If you press SET while a disc is still in the media tray, the "Remove disc!" message will appear and the media tray will pop out again.

Note

You can move a disc to a different slot using the following steps. This allows you to rearrange the discs, for example.

Example: Moving a disc from slot 12 to drive A

Note

Be sure to select the manual mode before you operate the following procedure. To select the manual mode, set the MODE SELECT dial to the "1" position, then turn off and on the power.

1 Press DISPLAY until the following message appears:

Select Move?

2 Press SET.

3 Press UP or DOWN to select the slot in which the desired disc is currently stored.

Move [012] to 001

4 Press SET.

5 Press UP or DOWN to select the slot to move the disc to.

Move 012 to [DRA]

6 Press SET to move the disc. To cancel, press CANCEL.

Initializing slots

Positioning the carrier to a slot

Be sure to select the manual mode before you operate the following procedure. To select the manual mode, set the MODE SELECT dial to the "1" position, then turn off and on the power.

Note

1 Press DISPLAY until the following message appears.

Select Position?

2 Press SFT.

3 Press UP or DOWN to select the slot to position the carrier to.

4 Press SFT to position the carrier.
To cancel, press CANCEL.

By specifying a slot number, you can initialize all slots starting from this number (up to 100). This enables you to find out which slots are empty and which slots are occupied. The results are saved in the non-volatile memory.

Note

Be sure to select the manual mode before you operate the following procedure. To select the manual mode, set the MODE SELECT dial to the "1" position, then turn off and on the power.

1 Press DISPLAY until the following message appears.

Select Init?

2 Press SFT.

3 Press UP or DOWN to select the slot to start.

4 Press SFT to start the initialization.

Init Add=001 o

"o" indicates that the slot is occupied and "x" indicates that the slot is empty. The initialization takes slightly less than 2 minutes.

To cancel, press CANCEL.

Before shipping the CD-ROM Library to another location, be sure to park the carrier to the shipping position using the following steps.

Note

Be sure to select the manual mode before you operate the following procedure. To select the manual mode, set the MODE SELECT dial to the "1" position, then turn off and on the power.

1 Press DISPLAY until the following message appears.

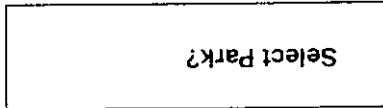

2 Press SFT.

If "Remove Disc!!" appears, remove the disc and close the mailbox. When the carrier is parked, the "Shipping Park ok" message appears for about 3 seconds.

Displaying the error history

If you want to check the error history and additional information, take the steps below to see the last 10 errors.

Note

Be sure to select the manual mode before you operate the following procedure. To select the manual mode, set the MODE SELECT dial to the "1" position, then turn off and on the power.

1 Press DISPLAY until the following message appears.

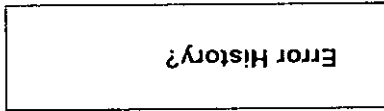

2 Press SFT to enter the error history mode.

3 Press UP or DOWN to see an error.

Error with the smallest number is the most recent one. To see additional information related to the current error, press DISPLAY. For details, see the "Displaying the error history" section on page 32.

4 Press CANCEL to cancel this operation.

This chapter describes how to maintain the CD-ROM Library at the best condition by cleaning it regularly.

Maintenance Schedule

Table below lists the recommended intervals for performing operator's preventive maintenance on the CD-ROM Library.

Interval	Action	Materials Required
As required	Clean Drives (only when operating in dusty environment or when excessive read errors occur).	CD Laser Lens Cleaning Discs: 3M
Six months	Clean Discs (only when operating in dusty environment or when excessive read errors occur).	CD cleaner

Cleaning the Drives

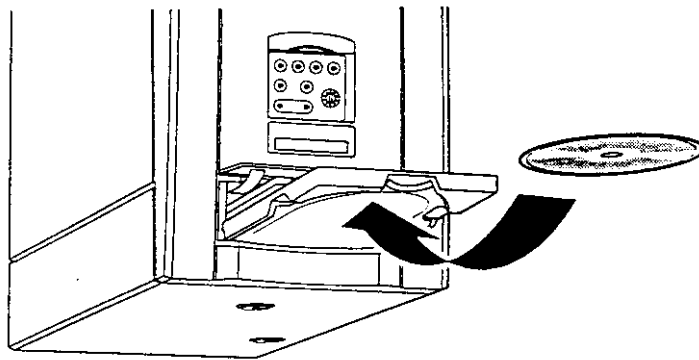

1 Press LOAD
The mailbox opens and the media tray slides out.

2 Place the cleaning disc into the media tray.
By default, the smallest slot number available is displayed (001 in this sample).

Load Add=[001]

For Technical Support

For questions about troubleshooting and other technical support, contact your dealer, reseller or system supplier directly.

Do not use solvents such as benzine, thinner, commercially available cleaners or anti-static spray intended for use with records. They may damage the disc.

Caution

If a CD-ROM disc becomes dirty, clean it with a cleaning kit. Wipe the disc from the center out.

Cleaning a Disc

8 Remove the cleaning disc from the media tray, then press CANCEL.

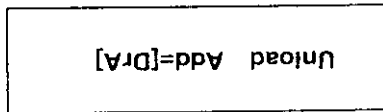

7 Press UP or DOWN to select the Drive A (or Drive B), then press SET.

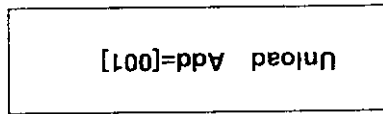

6 Press UNLOAD.
By default, the highest slot number being used is displayed (001 in this sample).

5 Play the cleaning disc in the Drive A (or Drive B) to the end via the SCSI interface.

4 After the disc is loaded, the mailbox opens again. Press CANCEL or push the media tray.

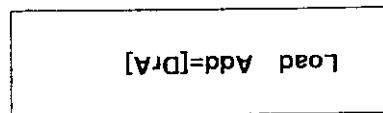

3 Press UP or DOWN to select Dra (or DrB), then press SET or push the media tray.

If 'RST Sensor Err', 'Grip Err. nfd', 'Return Err. hld' or 'Return Err. ret' appears on the screen

If 'RST Sensor Err', 'Grip Err. nfd', 'Return Err. hld' or 'Return Err. ret' appears if the power is turned on without removing the shipping screws or the shipping pole. In this case, remove the shipping screws or the shipping pole, reset the CD-ROM Library and initialize slots.

- 1 Turn off the CD-ROM Library.
- 2 Remove two shipping screws or the shipping pole.
Refer to "Unlocking the CD-ROM Library" on the Chapter 2 (Installation).
- 3 Set the MODE SELECT switch to select "1" (Manual Mode).
Refer to "About the Operation Modes" on the Chapter 3 (Operation).
- 4 Turn on the power again.
5 Set the ROBOTICS SW 8 to ON, then reset to OFF.

Attach the figure ID SELECTOR

- 6 Press DISPLAY until 'Select Init?' message appears.
Refer to "Initializing slots" on the Chapter 3 (Operation).
- 7 Press SET.
- 8 Press UP or DOWN to select until 'Init Add=[DrB]' message appears.
9 Press SET to start the initialization from the drive B to the slot 100.
It takes 2 minutes.
10 Turn off the power.
11 Set the MODE SELECT switch to select "0" (Normal Mode).

Caution
If you repeatedly encounter a hardware error, contact a qualified service personnel for assistance.
Repeatedly resetting SW 8 may damage the library unit or the discs.
Do not leave SW 8 in the ON position.

This chapter describes how to troubleshoot problems of the CD-ROM Library that may occur during the startup and operation of the unit.

Operational Problems

The following warning messages may appear during operation of the unit.

Warning you can correct

If these messages appear, you can correct the problems by taking the following steps:

Message	Meaning and Solution
Disc Full !!	All slots and drive(s) are full. →Remove one or more discs from the slots or drives before loading new discs.
No Disc !!	There is no disc in any slot and drive. →You must load some discs into the unit before you can use them.
Drive Full !!	The drive(s) is already full. →Remove discs from the drive(s).
No Drive !!	No drive is connected to the unit. →Be sure to install the drive(s) to the unit.
Slot Full !!	All slots are full. →Remove one or more discs from the slots.
Remove Disc !!	A disc still remains in the media tray. →Be sure to remove the disc from the media tray.
Load Disabled!	Disc loading is prohibited as set by the SCSI command. →Execute RELEASE command.
Unload Disabled!	Disc unloading is prohibited as set by the SCSI command. →Execute RELEASE or ALLOW MEDIUM REMOVAL command.

Startup Warning Message

The following is a list of warning message that must require servicing by a qualified service personnel.

If these messages appear at the startup of the CD-ROM Library, turn off the power and contact a qualified service personnel for assistance.

Error	Meaning
Check Sum NG !!	The ROM program's checksum is incorrect. The bus interface between the ROM program and the microprocessor may be malfunctioning, or the ROM program may be damaged.
ERAM RW NG !!	The microprocessor cannot read from and write to the external RAM correctly. The bus interface between the external RAM and the microprocessor may be malfunctioning, or the external RAM may be damaged.
EXIO RW NG !!	The microprocessor cannot read from and write to the I/O expander correctly. The bus interface between the I/O expander and the microprocessor may be malfunctioning, or the I/O expander may be damaged.
SCSI RW NG !!	The microprocessor cannot read from and write to the SCSI controller correctly. The bus interface between the SCSI controller and the microprocessor may be malfunctioning, or the SCSI controller may be malfunctioning or damaged.
NVRAM INIT !!	The non-volatile memory has just been initialized. If this message appears when you turn on the power, the backup using the battery may not have been done correctly.
EEPROM INIT !!	The EEPROM has just been initialized. If this message appears when you turn on the power, the bus interface between the EEPROM and the microprocessor may be malfunctioning, or the EEPROM may be damaged.

Other Error Message

If these messages appear, turn off the power and contact a qualified service personnel for assistance.

Indication	Contents
Grp Err. ...	An error occurred in the clip operation during gripping disc operation.
Return Err. ...	An error occurred in the clip operation during returning disc operation.
Init Err. ...	An error occurred in the clip operation during initializing disc operation.
FG Err. #####	The FG count error occurred while moving. "#####" indicates the number of the error counted.
Chuck Err.	An error occurred during chucking operation.
Unchuck Err.	An error occurred during unchucking operation.
EEPROM Err.	An error occurred during EEPROM operation.
Rst Sensor Err.	The carrier has urgently stopped because the reset position sensor could not perform the detection. See "If 'RST Sensor Err' appears on the screen" on the next page.

Above "....." of Grp, Return, Init errors indicate the clip position when an error occurred.

***Indication	Contents
hid	Time out while moving to the hold position
ret	Time out while moving to the return position
emp	Time out while moving to the empty position
hom	Time out while moving to home position
rls	Time out while moving to release position
pul	Failure in disc gripping (Clip sensor could not detect a disc after gripping.)
pus	Failure in disc returning (Clip sensor has detected a disc after returning.)
rfd	Failure in disc detecting (Detection was impossible through the return position when gripping the disc.)

For any other error messages, contact a qualified service personnel for assistance.

If 'RST Sensor Err' appears on the screen

'RST Sensor Err' appears if the power is turned on without removing the shipping screws.
In this case, remove the shipping screws and reset the CD-ROM Library.

- 1 Turn off the CD-ROM Library.
- 2 Remove two shipping screws.
- 3 Turn on the power again.
- 4 Set the ROBOTICS SW 8 to ON, then reset to OFF.

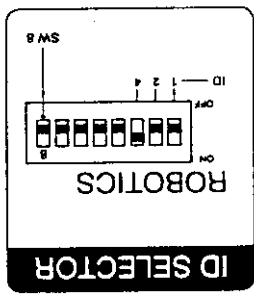

Caution

If you repeatedly encounter a hardware error, contact a qualified service personnel for assistance.
Repeatedly resetting SW 8 may damage the library unit or the discs.
Do not leave SW 8 in the ON position.

Warning you can correct the item (移動 (変更)) でき

On handling or loading discs

- Do not use 8-cm discs, even with an adapter.

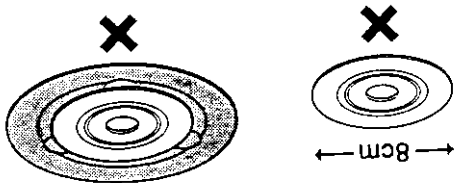

- Load the disc with the label side facing up.
- Do not use discs that are transparent at the edges. (This unit uses an optical sensor to determine whether a disc is loaded, and the sensor will not operate properly with a transparent disc.)

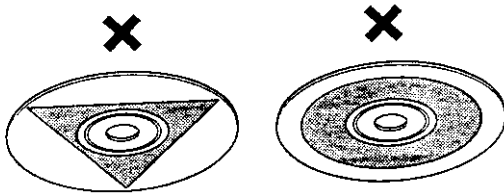

- Do not use discs that are warped. (Warped discs can jam in the slot or the carrier.)

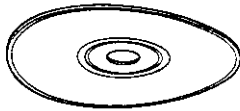

- Do not use discs with affixed labels other than the original one, or they may jam the unit and cause a malfunction.

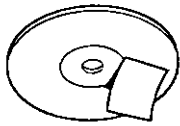

- Do not use dirty discs. Be sure to wipe off any dirt before loading a disc.

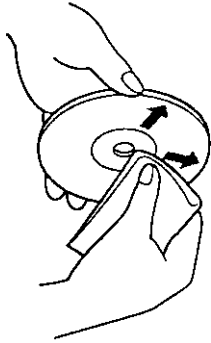

- Do not load two or more discs together into the media tray.
- When loading a disc, place it at the center of the media tray.

Transporting the CD-ROM Library

Before shipping the unit, remove all the disks inside the unit, then take the following steps:

- 1 Park the carrier.
See the "Parking the Carrier" section for more information.
- 2 Remove the two shipping screws from the rear side of the unit and put them back into the spaces at the bottom.
- 3 Repack the unit using the original shipping container and packing materials. If the original container and packing materials are not available, contact your dealer, reseller or system supplier directly for information on obtaining replacements.

General
Except when instructed, do not remove any screws on the panel or other parts of the unit. They must be handled by qualified service personnel.

- On changing voltage**
- When required, use the VOLTAGE SELECTOR switch on the rear side of the unit to select 120V or 230V for the ~~120V~~ 120V regions and 220V-240V regions respectively. *110V*
 - Be sure to change the AC power cord accordingly. *≠*

Noise from unbalanced discs
Some CD-ROM discs may be unbalanced when spinning at high speed because of uneven label silkscreening or applied labels. This will cause noise during operation of the Library. In this event, it is recommended that you avoid using these unbalanced discs.

When temporarily moving the unit

For small movement such as moving the unit across the room, you can leave the disks inside the unit but use the locking pole to secure the unit, as follows:

- 1 Park the carrier.
See the "Parking the Carrier" section for more information.
- 2 Remove the two shipping screws from the rear side of the unit and put them back into the spaces at the bottom.
- 3 Take out the locking pole from the operating position and insert it into the shipping position.

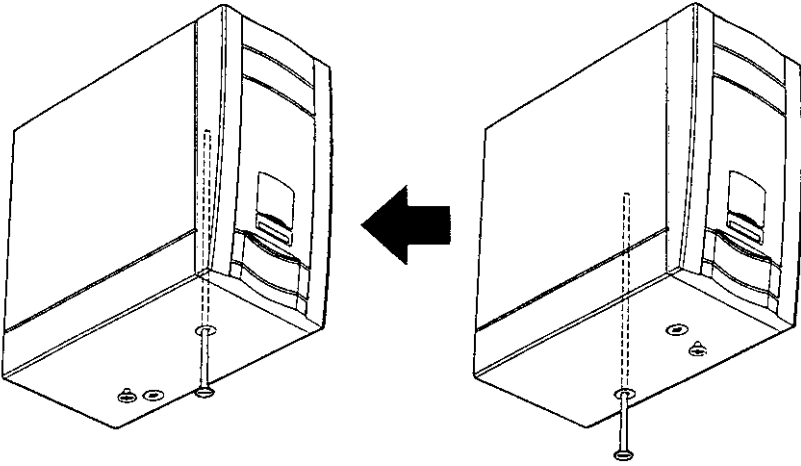

- 4 Repack the unit using the original shipping container and packing materials. If the original container and packing materials are not available, contact your dealer, reseller or system supplier directly for information on obtaining replacements.

Caution

Carrier parking is required even when you move the unit across the room.

Specifications

Number of drivers	2
Number of slots	100
Total Capacity	65 GB
Disc Exchange Time	Typ. 12.2 sec. (average)
Sustained Transfer Rate	1160-1800 KB (P-CAV)
Access Time	Typ. 130 ms (average)
Robotics	SCSI-2 single ended
Drives	SCSI-2 single ended
Interface	Stereo mini jack
	RS-232C
CD-ROM (Mode 1 and Mode 2)	CD-ROM XA
CD-ROM XA	(Mode 2 Form 1 and Mode 2 Form 2)
CD-I Ready	CD-Bridge
CD-EXTRA	Video CD
Photo CD (Single and multiple session)	Dimensions (W×H×D)
Physical Size	215×430×435 (mm)
	14
Weight	13.7 kg
Line Voltage	120 V/230 V
Line Frequency	50/60 Hz
Power consumption	0.25A 120V
	0.17A 230V
Temperature	Operating
Relative Humidity	Operating
	5 to 35 degC
	30 to 80%