

The Micro Cassette Memory

Labeling a cassette

The label can consist of up to 16 characters and is stored in cassette memory. When you insert the labeled cassette and set the POWER switch to CAMERA or VCR, the label is displayed for about five seconds.

- (1) Insert the cassette you want to label.
- (2) Set the POWER switch to CAMERA or VCR.
- (3) Press FN to display PAGE1.
- (4) Press MENU, then select TAPE TITLE in  in the menu settings, then press EXEC (p. ●●).
The TAPE TITLE screen appears.
- (5) Select a desired character. Repeat pressing a key to select the desired character on the key.
- (6) Press → to move the cursor for the next character. Repeat the same procedure as steps 5 and 6 to complete the label.
- (7) Press SET. The label is stored in memory.

Editing

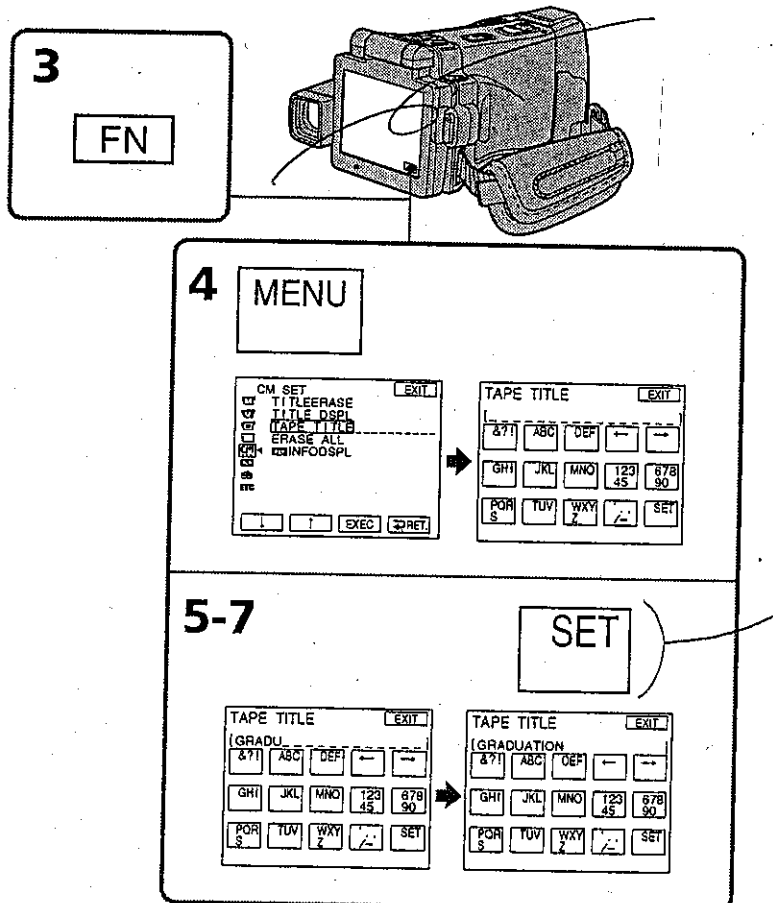

101

If you take five minutes or longer to enter characters in the standby mode while a cassette is in your camcorder, the power automatically goes off.

The characters you have entered remain stored in memory. Set the POWER switch to OFF (CHG) once and then to CAMERA again, then complete your cassette label.

The Micro Cassette Memory

To return to FN

Press EXIT.

To erase the label you have made

Select ← in step 4. The last character is erased.

To change the label you have made

Insert the cassette to change the label, and operate in the same way to make a new label.

If you set the write-protect tab of the tape to lock

You cannot label the tape. Slide the write-protect tab to release the write protection.

To erase the character

Press ←. The last character is erased.

To enter a space

Press →.

To enter the character on the same button in succession

Press → to move the cursor to the next position, and enter the character.

Erasing all the data in Micro Cassette Memory

You can delete all the data in Micro Cassette Memory at once.

- (1) Set the POWER switch to CAMERA or VCR.
- (2) Press FN to display PAGE1.
- (3) Press MENU, then select ERASE ALL in  in the menu settings, then press EXEC (p. ●●).
- (4) Press ↓/↑ to select OK, then press EXEC. "OK" changes to "EXECUTE."
- (5) Press ↓/↑ to select EXECUTE, then press EXEC. "ERASING" flashes on the LCD screen. Once deleting is completed, "COMPLETE" is displayed.

To return to FN

Press EXIT.

To cancel deleting

Select RETURN in step 4 or 5, then press EXEC.

Note

Once you delete all the data in the Micro Cassette Memory, the following operations do not work:

- MULTI-PICTURE SEARCH
- TITLE SEARCH
- DATE SEARCH

Note on the ID number

This item cannot be deleted.

Using a "Memory Stick" – Introduction

You can record and play back still images and moving pictures on a "Memory Stick" supplied with your camcorder. You can easily play back, record or delete images. You can exchange image data with other equipment such as your computer etc., using the USB cable for the "Memory Stick" supplied with your camcorder.

File format

Still image (JPEG)

Your camcorder compresses image data in JPEG format (extension .jpg).

Moving picture (MPEG)

Your camcorder compresses picture data in MPEG format (extension .mpg).

Typical image data file name

Still image

100-0001: This file name appears on the LCD screen of your camcorder.

Dsc00001.jpg: This file name appears on the display of your computer.

Moving picture

MOV10001: This file name appears on the LCD screen of your camcorder.

Mov10001.mpg: This file name appears on the display of your computer.

Using a "Memory Stick"

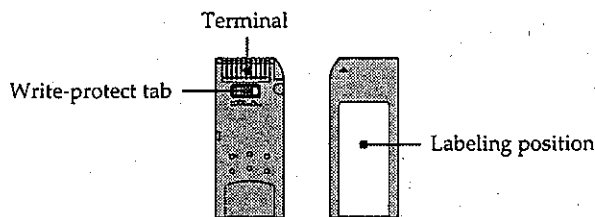

- You cannot record or erase images when the write-protect tab on the "Memory Stick" is set to LOCK.
- The position and shape of the write protect tab may be different depending on the model.
- We recommend backing up important data on the hard disk of your computer.
- Image data may be damaged in the following cases:
 - If you remove the "Memory Stick," turn the power off or take out the battery for replacement when the access lamp is flashing
 - If you use a "Memory Stick" near magnets or magnetic fields such as those of speakers and televisions
- Prevent metallic objects or your finger from coming into contact with the metal parts of the connecting section.
- Stick its label on the labeling position.
- Do not bend, drop or apply strong shock to a "Memory Stick."
- Do not disassemble or modify a "Memory Stick."
- Do not let a "Memory Stick" get wet.
- Do not use or keep a "Memory Stick" in locations that are:
 - Extremely hot such as in a car parked in the sun or under the scorching sun
 - Under direct sunlight
 - Very humid or subject to corrosive gases
- When you carry or store a "Memory Stick," put it in its case.

Using a "Memory Stick" – Introduction

"Memory Stick" formatted by a computer

The "Memory Stick" formatted by Windows OS or Macintosh computers do not have a guaranteed compatibility with your camcorder.

Notes on image data compatibility

- Image data files recorded on a "Memory Stick" by your camcorder conform with the Design Rules for Camera File Systems universal standard established by the JEITA (Japan Electronics and Information Technology Industries Association).
On your camcorder, you cannot play back still images recorded on other equipment (DCR-TRV890E/TRV900/TRV900E or DSC-D700/D770) that does not conform to this universal standard. (These models are not sold in some areas.)
- If you cannot use the "Memory Stick" that is used with other equipment, format it with your camcorder (p. ●●). Note that formatting erases all information on the "Memory Stick."

-
- "Memory Stick" and  are trademarks of Sony Corporation.
 - All other product names mentioned herein may be the trademarks or registered trademarks of their respective companies.
Furthermore, "TM" and "®" are not mentioned in each case in this manual.

Using a "Memory Stick" – Introduction

Inserting a "Memory Stick"

Insert a "Memory Stick" in the "Memory Stick" slot as far as it can go, as illustrated below.

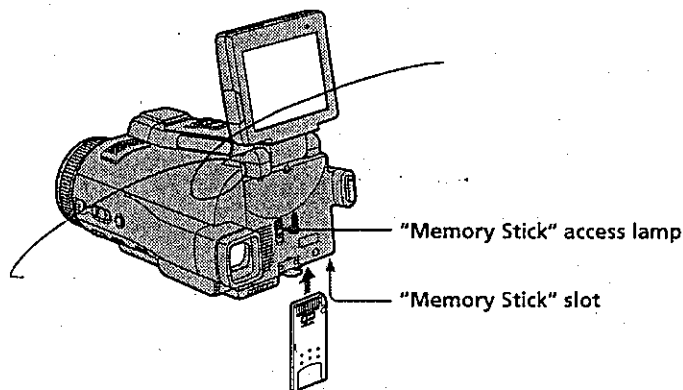

Ejecting a "Memory Stick"

Open the LCD panel and confirm that the "Memory Stick" access lamp is not lit. Then slide the MEMORY EJECT in the direction of the arrow.

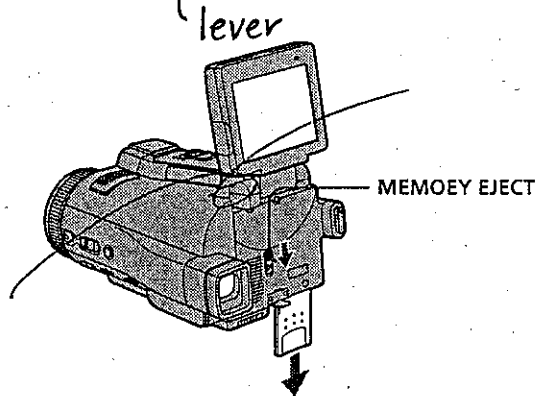

While the "Memory Stick" access lamp is lit or flashing

Do not shake or strike your camcorder because your camcorder is reading the data from the "Memory Stick" or recording the data on the "Memory Stick." Do not turn the power off, eject a "Memory Stick" or take out the battery pack. Otherwise, image data breakdown may occur.

If "MEMORYSTICK ERROR" is displayed

Reinsert a "Memory Stick" a few times. The "Memory Stick" may be damaged if the indicator is still displayed. If this occurs, use another "Memory Stick."

Using a "Memory Stick" – Introduction

Using a touch panel

Operation buttons for most functions using a "Memory Stick" are displayed on the LCD screen. Press the LCD panel directly with your finger or the supplied stylus (DCR-IP220 only) to operate each function.

- (1) Set the POWER switch to MEMORY.
- (2) Open the LCD panel. The operation buttons appear on the LCD screen. You can switch the memory playback/memory camera mode by pressing PLAY/CAM.
- (3) Press FN to display PAGE1. The operation buttons of PAGE1 appear on the LCD screen.
- (4) Press PAGE2 to go to PAGE2. The operation buttons of PAGE2 appear on the LCD screen.
- (5) Press PAGE3 to go to PAGE3. The operation buttons of PAGE3 appear on the LCD screen.
- (6) Press a desired operation item.
See relevant pages of this manual for each function.

Using a "Memory Stick" – Introduction

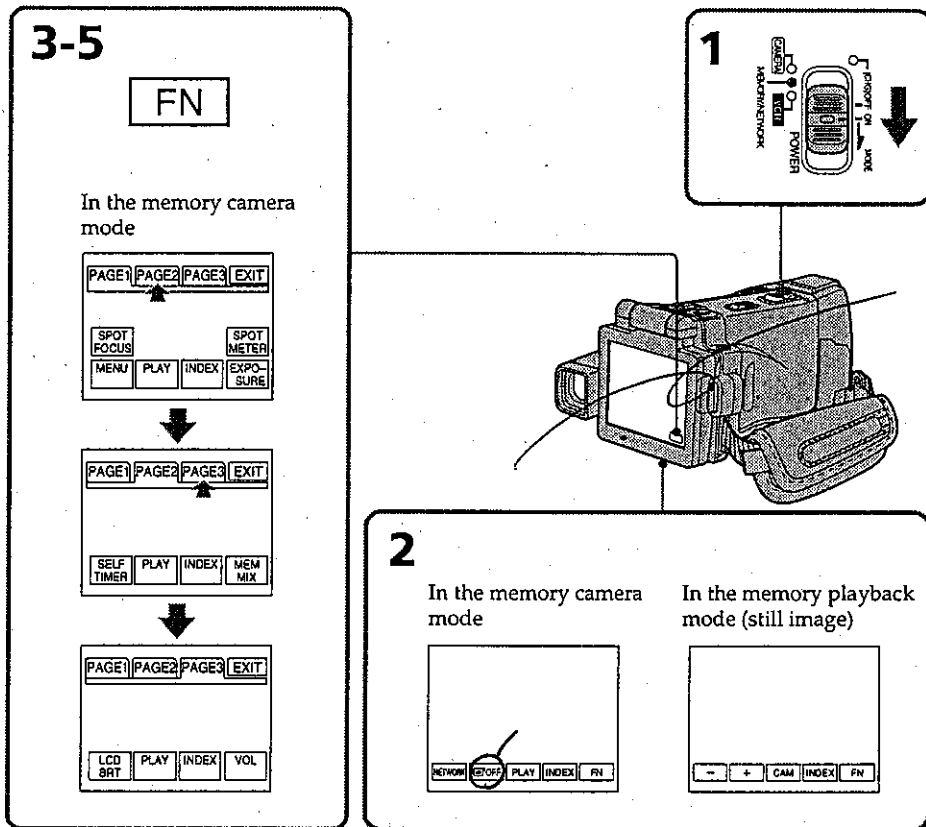

To return to FN

Press EXIT.

To execute settings

Press EXEC or \rightarrow OK.

To cancel settings

Press \rightarrow OFF or \rightarrow AUTO. The display returns to PAGE1, 2 or 3.

Using a "Memory Stick" – Introduction

Notes

- When using the touch panel, press the LCD screen lightly with your finger or the supplied stylus (DCR-IP220 only).
- Do not press the LCD screen with sharp objects other than the stylus supplied (DCR-IP220 only).
- Do not press the LCD screen too hard.
- Do not touch the LCD screen with wet hands.
- If FN is not on the LCD screen, touch the LCD screen lightly to make it appear. You can control the display with DISPLAY/TOUCH PANEL on your camcorder.
- When operation buttons do not work even if you press them, an adjustment is required (CALIBRATION) (p. ••).
- When the LCD screen gets dirty, use the supplied cleaning cloth.

When executing each item

The green bar appears above the item.

If the items are not available

The color of the items changes to gray.

Press FN to display the following buttons:

In the memory camera mode

PAGE1	SPOT FOCUS, MENU, PLAY, INDEX, SPOT METER, EXPOSURE
PAGE2	SELFTIMER, PLAY, INDEX, MEM MIX
PAGE3	LCD BRT, PLAY, INDEX, VOL

In the memory playback mode

PAGE1	MENU, CAM, INDEX, DELETE, [+], [-]
PAGE2	PB ZOOM, CAM, INDEX, DATA CODE, [+], [-]
PAGE3	LCD BRT, CAM, INDEX, VOL, [+], [-]

Using a "Memory Stick" - Introduction

Selecting still image quality mode

You can select the image quality mode in still image recording and store the setting in memory. The default setting is SUPER FINE.

- (1) Set the POWER switch to MEMORY or VCR.
- (2) Press FN to display PAGE1.
- (3) Press MENU, then select STILL SET in  in the menu settings, then press EXEC (p. ●●).
- (4) Press ↓/↑ to select QUALITY, then press EXEC.
- (5) Press ↓/↑ to select the desired image quality, then press EXEC.

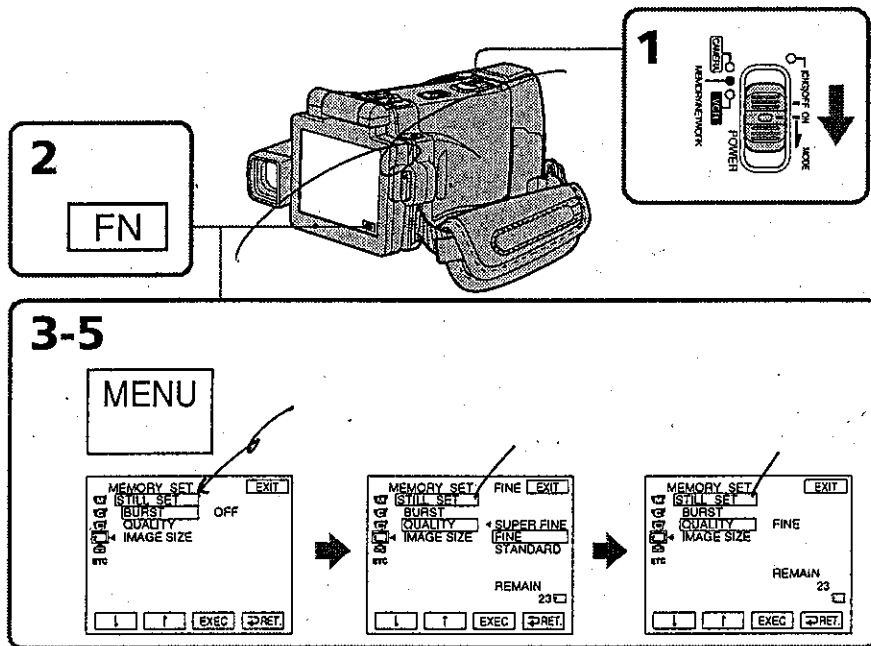

"Memory Stick" Operations

To return to FN
Press EXIT.

Using a "Memory Stick" – Introduction

Image quality settings

Setting	Meaning
SUPER FINE (SFN)	This is the highest image quality in your camcorder. The number of still images you can record is less than in FINE mode. Super fine images are compressed to about 1/3.
FINE (FINE)	Use this mode when you want to record high quality images. Fine images are compressed to about 1/6.
STANDARD (STD)	This is the standard image quality. Standard images compressed to about 1/10.

Note

In some cases, changing the image quality mode may not affect the image quality, depending on the type of images you are shooting.

Differences in image quality mode

Recorded images are compressed in JPEG format before being stored in memory. The memory capacity allocated to each image varies depending on the selected image quality mode and image size. Details are shown in the table below. (You can select 1600 × 1200 or 640 × 480 image size in the menu settings.)

1600 × 1200 image size

Image quality mode	Memory capacity
SUPER FINE	About xxx KB 1240
FINE	About xxx KB 620
STANDARD	About xxx KB 420

640 × 480 image size

Image quality mode	Memory capacity
SUPER FINE	About 190 KB
FINE	About 100 KB
STANDARD	About 60 KB

Image quality mode indicator

The image quality mode indicator is not displayed during playback.

When you select image quality

The number of images you can shoot in the currently selected image quality appears on the LCD screen.

Using a "Memory Stick" - Introduction

Setting the moving picture quality mode

There are SUPER FINE, FINE, STANDARD and LIGHTMODE in the moving picture quality mode. The default setting is SUPER FINE.



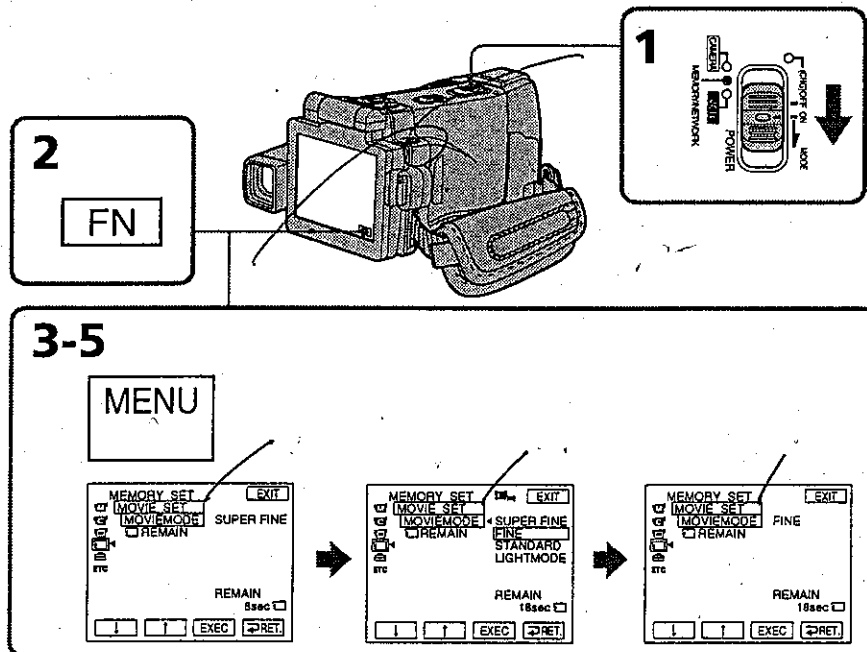

- (1) Set the POWER switch to MEMORY or VCR.
- (2) Select FN to display PAGE1.
- (3) Press MENU, then select MOVIE SET in  in the menu settings, then press EXEC (p. ••).
- (4) Press ↓/↑ to select MOVIEMODE, then press EXEC.
- (5) Press ↓/↑ to select the desired image quality, then press EXEC.



"Memory Stick" Operations

Using a "Memory Stick" – Introduction

Image quality settings

Setting	Meaning	Frame rate	Bit rate (image and audio) (Approx.)	Indicator (during recording)
SUPER FINE (SFN)	Records moving pictures at 352 × 240.	30 fps	1200 Kbps	 SFN
FINE (FINE)	Records moving pictures at 352 × 240.	30 fps	750 Kbps	 FINE
STANDARD (STD)	Records moving pictures at 144 × 96.	10 fps	400 Kbps	 STD
LIGHTMODE (LIGHT)	Records moving pictures at 144 × 96.	10 fps	200 Kbps	 LIGHT

SUPER FINE: You can record moving pictures at the highest quality. This mode is suitable when you intend to modify the pictures using your computer. SUPER FINE is the default setting of your camcorder.

FINE: You can record moving pictures for a longer time than with the SUPER FINE mode, the quality, however, declines slightly.

STANDARD: You can record moving pictures for a longer time than with the FINE mode, the image size, however, is smaller.

LIGHTMODE: Since the file size is small, this mode is suitable for e-mail transmission. The image quality, however, declines.

Frame rate

A moving picture consists of continuous still images. Frame rate indicates the number of images played back in one second. The more the number increases, the more natural the moving picture becomes.

Bit rate

The higher the ^{bit} transmission rate, the more natural the moving picture becomes.

Maximum recording time for moving pictures

Image quality mode	Maximum recording time
SUPER FINE	45 s
FINE	1 min 10 s
STANDARD	2 min 20 s
LIGHTMODE	4 min 40 s

Using a "Memory Stick" – Introduction

Selecting the size of still image

You can select either of two still image sizes.

1600 × 1200 or 640 × 480. (When the POWER switch is set to CAMERA or VCR, the image size is automatically set to 640 × 480.)

The default setting is 1600 × 1200.

- (1) Set the POWER switch to MEMORY.
- (2) Press FN to display PAGE1.
- (3) Press MENU, then select STILL SET (still image) in  in the menu setting, then press EXEC (p. ●●).
- (4) Press ↓/↑ to select IMAGE SIZE, then press EXEC.
- (5) Press ↓/↑ to select the desired image size, then press EXEC.

The indicator changes as follows:

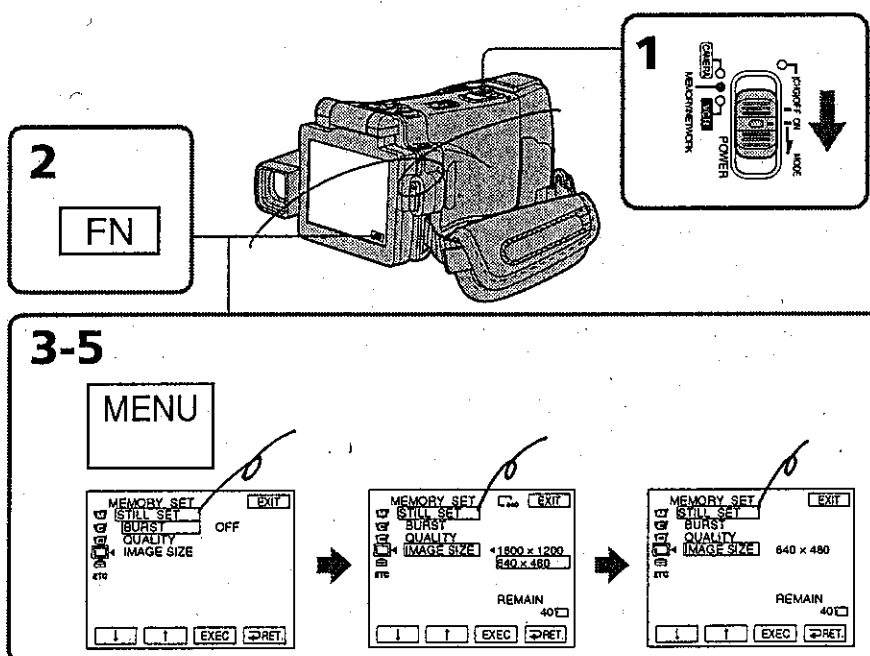
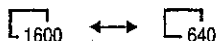



Memory Stick™ Operations

Note

When still images recorded on your camcorder in 1600 × 1200 size are played back on other equipment that does not support 1600 × 1200 size, the full image may not appear.

Using a "Memory Stick" - Introduction

Image size settings

Setting	Meaning	Indicator
1600 × 1200	Records 1600 × 1200 still images.	
640 × 480	Records 640 × 480 still images.	

Approximate number of still images you can record on a "Memory Stick"

The number of still images you can record varies depending on the complexity of the subject.

Image quality	Image size	Capacity of "Memory Stick"s				
		8MB (supplied)	16MB (optional)	32MB (optional)	64MB (optional)	128MB (optional)
SUPER FINE	1600 × 1200	xx images	xx images	xx images	xx images	xx images
	640 × 480	40 images	80 images	160 images	325 images	650 images
FINE	1600 × 1200	xx images	xx images	xx images	xx images	xx images
	640 × 480	80 images	160 images	325 images	650 images	1310 images
STANDARD	1600 × 1200	xx images	xx images	xx images	xx images	xx images
	640 × 480	120 images	240 images	485 images	980 images	1970 images

The table above shows approximate number of still images you can record on a "Memory Stick" formatted by your camcorder.

Approximate time of moving pictures you can record on a "Memory Stick"

The time of moving pictures you can record varies depending on the complexity of the subject.

Picture quality	Capacity of "Memory Stick"				
	8MB (supplied)	16MB (optional)	32MB (optional)	64MB (optional)	128MB (optional)
SUPER FINE	45 s	1 min	3 min	6 min	13 min
FINE	1 min	2 min	5 min	10 min	20 min
STANDARD	2 min	5 min	10 min	20 min	41 min
LIGHTMODE	5 min	10 min	20 min	41 min	82 min

The table above shows approximate times of moving pictures you can record on a "Memory Stick" formatted by your camcorder.

Recording still images on a "Memory Stick" – Memory photo recording

You can record still images on a "Memory Stick."

Before operation

Insert a "Memory Stick" into your camcorder.

- (1) Set the POWER switch to MEMORY.
- (2) Keep pressing PHOTO lightly. The green ● mark stops flashing, then lights up. The brightness of the image and the focus are adjusted and fixed while your camcorder is targeted at the middle of the image. Recording does not start yet.
- (3) Press PHOTO deeper. The image displayed on the LCD screen will be recorded on a "Memory Stick."

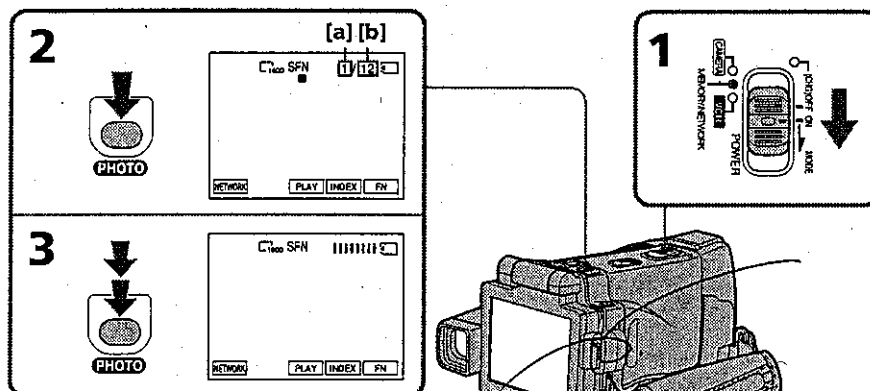

- [a]: Number of recorded images
[b]: Approximate number of images can be recorded on the "Memory Stick"

You can record still images on a "Memory Stick" in the recording standby mode or while recording on tape in CAMERA mode
For the details, see page ••.

"Memory Stick" Operations

Recording still images on a "Memory Stick" - Memory photo recording

When the POWER switch is set to MEMORY

The following functions do not work:

- Wide mode
- Digital zoom
- SteadyShot
- Super NightShot
- Color Slow Shutter
- Fader
- Picture effect
- Digital effect
- Title
- Sports lesson mode of PROGRAM AE (The indicator flashes.)

While you are recording a still image

You cannot turn off the power or press PHOTO.

When you press PHOTO on the Remote Commander

Your camcorder immediately records the image that is on the LCD screen when you press the button.

When you press PHOTO lightly in step 2

The image momentarily flickers. This is not a malfunction.

Recording data

The recording data (date/time or various settings when recorded) are not displayed while recording. However, they are recorded automatically onto the "Memory Stick." To display the recording data, press DATA CODE during playback. You can also use the Remote Commander for this operation (p. ●●).

When the POWER switch is set to MEMORY

The angle of view is slightly larger compared with the angle of view in CAMERA mode.

The number of still images you can record on a "Memory Stick"

It varies according to the image quality mode and the complexity of the subject.

Recording still images on a "Memory Stick" - Memory photo recording

Recording images continuously

You can record still images continuously. Before recording, select one of the four modes described below in the menu settings.

NORMAL [a]

Your camcorder shoots up to four still images in 1600 × 1200 size or 25 still images in 640 × 480 size at about 0.5 sec intervals. ()

HIGH SPEED [a]

Your camcorder shoots up to 32 still images in 640 × 480 size at about 0.07 sec intervals. ()

EXP BRKTG (Exposure Bracketing)

Your camcorder automatically shoots three images at about 0.5 sec intervals at different exposures. ()

MULTI SCRN (Multi Screen) [b]

Your camcorder shoots nine still images at about 0.5 sec intervals and displays the images on a single page divided into nine boxes. Still images are recorded in 640 × 480 size. ()

[a]

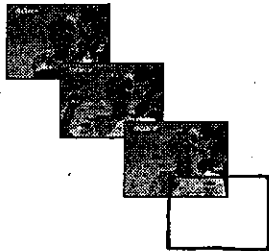

[b]

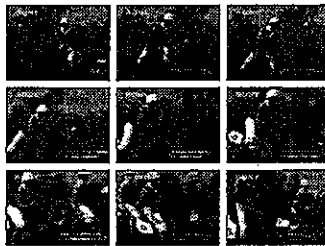

Recording still images on a "Memory Stick" - Memory photo recording

- (1) Set the POWER switch to MEMORY.
- (2) Press FN to display PAGE1.
- (3) Press MENU, then select STILL SET in  in the menu settings, then press EXEC (p. ●●).
- (4) Press ↓/↑ to select BURST, then press EXEC.
- (5) Press ↓/↑ to select the desired settings.
- (6) Press EXIT to make the menu settings disappear.
- (7) Press PHOTO deeper.

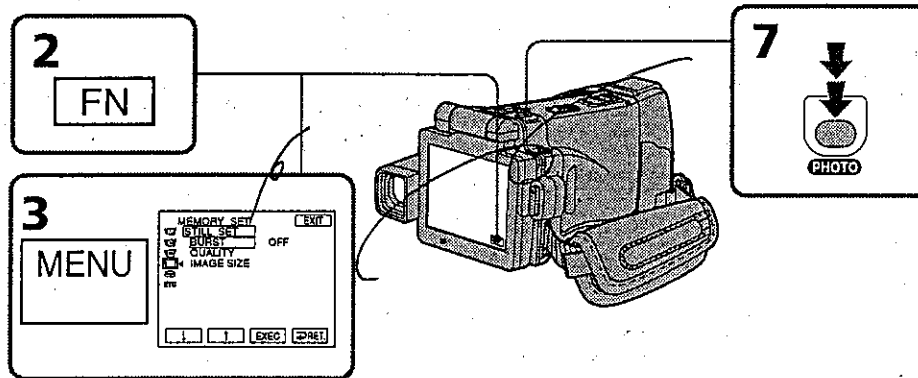

If the "Memory Stick" becomes full

" FULL" appears on the LCD screen, and you cannot record still images on this "Memory Stick."

The number of still images in continuous shooting

The number of still images you can shoot continuously varies depending on the image size and the capacity of the "Memory Stick."

During recording still images continuously

The flash does not work.

When shooting with the self-timer function ^{or} the Remote Commander

Your camcorder automatically records up to the maximum recordable number of still images.

When selecting HIGH SPEED

Flickering or changes in color may occur. Also, your camcorder prevents focusing on near objects.

If the remaining capacity of the "Memory Stick" is less than three images

EXP BRKTG does not work. When you press PHOTO lightly,  FULL" appears on the screen.

Recording still images on a "Memory Stick" - Memory photo recording

The effect of EXP BRKTG

The effect of EXP BRKTG may not be noticeable on the LCD screen.
We recommend viewing images on a TV or computer to realize the effect.

When selecting NORMAL or HIGH SPEED

Recording continues up to the maximum number of still images during pressing PHOTO deeper. Release PHOTO to stop recording.

Recording still images on a "Memory Stick" – Memory photo recording

Recording images with the flash

The flash automatically pops up to strobe. The default setting is auto (no indicator). To change the flash mode, press ⏏ (flash) repeatedly until the flash mode indicator appears on the LCD screen.

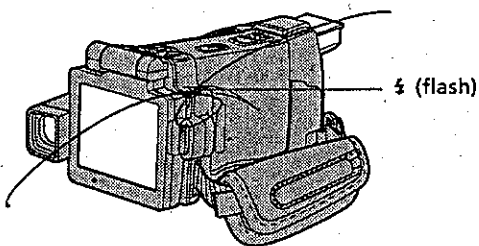

Each press of ⏏ (flash) changes the indicator as follows:

⏏ → ⊕ → AUTO (No indicator)

When you set RED EYE R to ON, the indicator changes as follows:

⦿ → ⏏ → ⊕ → AUTO (No indicator)

⦿ Auto red-eye reduction: The flash fires before recording to reduce the red-eye phenomenon.

⏏ Forced flash: The flash fires regardless of the surrounding brightness.

⊕ No flash: The flash does not fire.

The amount of flash is automatically adjusted to the appropriate brightness. You can also change FLASH LVL to the desired brightness in the menu settings (p. ●●). Try recording various images to find the most appropriate setting for FLASH LVL.

Notes

- The recommended shooting distance using the built-in flash is 0.3 m to 2.5 m (31/32 feet to 8 1/3 feet).
- Attaching the lens hood (supplied) or a conversion lens (optional) may block the light from the flash or cause lens shadow to appear.
- Auto red-eye reduction (⦿) may not produce the desired effect depending on individual differences, the distance to the subject, the subject not looking at the pre-recording flash or other conditions.
- The flash effect cannot be obtained easily when you use forced flash in a bright location.
- The flash CHG lamp flashes while the power for firing is being charged. After charging is completed, the flash CHG lamp lights up.
- If it is not easy to focus on a subject automatically, for example, when recording in the dark, use HOLOGRAM AF (p. ●●) or the focal distance information (p. ●●) for focusing manually.

If you leave your camcorder for five or more minutes after setting the POWER switch to OFF (CHG)

Your camcorder returns to the default setting (auto).

Recording still images on a "Memory Stick" – Memory photo recording



The flash does not fire even if you select AUTO and Auto red-eye reduction (●) during the following functions:

- NightShot
- Exposure
- Spotlight of PROGRAM AE
- Sunset & moon of PROGRAM AE
- Landscape of PROGRAM AE
- Flexible Spot Meter

During recording images continuously
The flash does not work.

Shooting with an auxiliary light – HOLOGRAM AF

The HOLOGRAM AF is an auxiliary light source used for focusing on subjects in dark places.

Set HOLOGRAM F in  to AUTO in the menu settings. (The default setting is AUTO.) When  appears on the LCD screen in a dark place, press PHOTO lightly. Then the auxiliary light will automatically emit until the subject is focused.

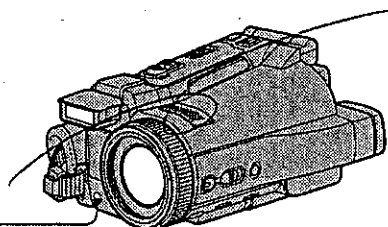

HOLOGRAM AF emitter

"Memory Stick" Operations

About HOLOGRAM AF

"HOLOGRAM AF (Auto-Focus)," an application of laser holograms, is a new AF optical system that enables still image shooting in dark places. Having gentler radiation than conventional high-brightness LEDs or lamps, the system satisfies Laser Class 1 (*) specification and thus maintains higher safety for human eyes.

No safety problems will be caused by directly looking into the HOLOGRAM AF emitter at a close range. However, it is not recommended to do so, because you may experience such effects like several minutes of image residual and dazzling, that you encounter after looking into a flashlight.

* HOLOGRAM AF satisfies Class 1 (time base 30 000 seconds), specified in all of JIS (Japan), IEC (EU), and FDA (US) industry standards.

Complying with these standards identifies the laser product to be safe, under a condition that a human looks at the laser light either directly or even through a lens for 30 000 seconds.

Recording still images on a "Memory Stick" - Memory photo recording

Notes

- A conversion lens (optional) may obstruct the HOLOGRAM AF light and make focusing difficult.
- If enough light does not reach the subject even if the HOLOGRAM AF emitter is emitted (recommended shooting distance is 2.5 m (8 1/3 feet)), the subject will not be focused.
- Focusing may be hampered if the light emitted from the HOLOGRAM AF is blocked by an obstruction.
- Focus is achieved as long as HOLOGRAM AF light reaches to the subject even if its light is slightly out of the middle position of the subject.
- If HOLOGRAM AF light is dim, it sometimes becomes difficult to focus. If this happens, wipe the HOLOGRAM AF emitter with a soft, dry cloth.

The HOLOGRAM AF does not emit when:



- Flash is set to  (No flash).
- NightShot
- Focusing manually
- Using Spot Focus
- Sunset & moon of PROGRAM AE
- Landscape of PROGRAM AE
- Continuous photo recording

Recording still images on a "Memory Stick" - Memory photo recording

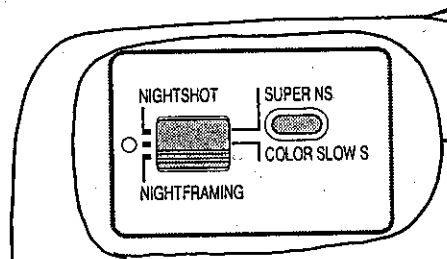
Using NightFraming



The NightFraming enables you to check a subject even at night and then record with natural colors using the flash.

- (1) Set the POWER switch to MEMORY.
- (2) Set NIGHTSHOT/NIGHTFRAMING to NIGHTFRAMING. The , ,  and NIGHTFRAMING indicators flash on the LCD screen.
- (3) Press PHOTO lightly.
The auxiliary light (HOLOGRAM AF) (p. ●●) emits to adjust the focus automatically.
- (4) Press PHOTO deeper.
The flash fires, then recording starts.
To cancel NightFraming, set NIGHTSHOT/NIGHTFRAMING to OFF.



Memory Stick Operations

While using NightFraming, you cannot use the following functions:

- Exposure
- Flexible Spot Meter
- PROGRAM AE
- White balance
- Spot Focus
- Continuous photo recording

While using NightFraming:

- Even if FOCUS is set to MANUAL, focus is automatically adjusted.
- Even if HOLOGRAM F is set to OFF in the menu settings, the auxiliary light emits light.
- Even if you set  No flash, the flash fires.

Recording still images on a "Memory Stick" - Memory photo recording

Self-timer memory photo recording

You can record images on a "Memory Stick" with the self-timer. You can also use the Remote Commander for this operation.

- (1) Set the POWER switch to MEMORY.
- (2) Press FN and go to PAGE2.
- (3) Press SELFTIMER.

The  (self-timer) indicator appears on the LCD screen.

- (4) Press PHOTO deeper.

The self-timer starts counting down from 10 with a beep sound. In the last two seconds of the countdown, the beep sound gets faster, then recording starts automatically.

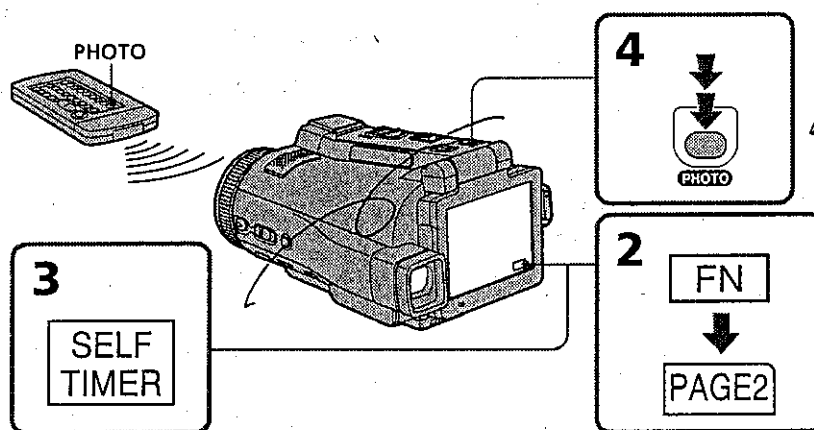

To cancel self-timer recording

Press SELFTIMER so that the  (self-timer) indicator disappears from the LCD screen. You cannot cancel self-timer recording using the Remote Commander.

Note

The self-timer recording mode is automatically canceled when:

- Self-timer recording is finished.
- While using NightFraming
- The POWER switch is set to OFF (CHG) or VCR.

To check the image to be recorded

You can check the image by pressing PHOTO lightly, then press it deeper to start the self-timer recording.

Recording an image from a tape as a still image

Your camcorder can read moving picture data from other equipment recorded on a tape and record it as a still image on a "Memory Stick."

Your camcorder can also take in moving picture data from other equipment through the input connector and record it as a still image on a "Memory Stick."

Before operation

- Insert a recorded tape into your camcorder.
- Insert a "Memory Stick" into your camcorder.

- (1) Set the POWER switch to VCR.
- (2) Press . The picture recorded on the tape is played back.
- (3) Keep pressing PHOTO lightly until the picture from the tape freezes. CAPTURE appears on the LCD screen. Recording does not start yet.
- (4) Press PHOTO deeper. The image displayed on the LCD screen will be recorded on a "Memory Stick." Recording is complete when the bar scroll indicator disappears.

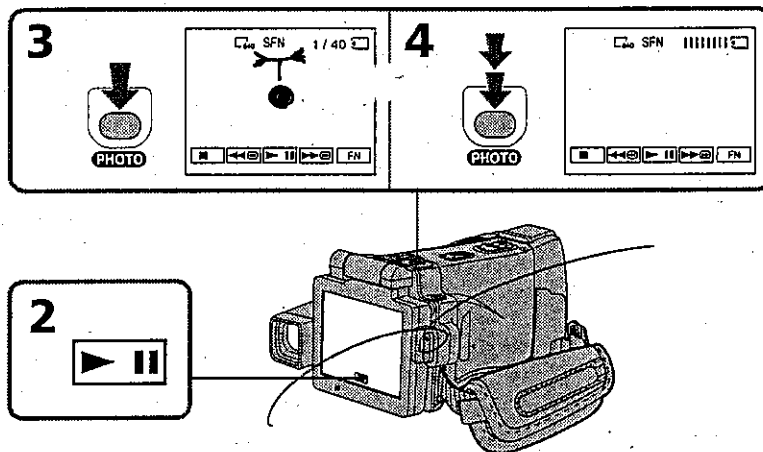

"Memory Stick" Operations

Recording an image from a tape as a still image

Image size of still images

Image size is automatically set to 640 x 480.

When the "Memory Stick" access lamp is lit or flashing

Do not shake or strike the unit. As well do not turn the power off, eject a "Memory Stick" or take out the battery pack. Otherwise, the image data breakdown may occur.

If "35" appears on the LCD screen

The inserted "Memory Stick" is incompatible with your camcorder because its format does not conform with your camcorder. Check the format of the "Memory Stick."

If you press PHOTO lightly in the playback mode

Your camcorder stops momentarily.

Sound recorded on a tape

You cannot record audio from a tape.

Titles which have already been recorded on tapes

You cannot record the titles on the "Memory Stick." The title does not appear while you are recording a still image with PHOTO.

Recording date/time

The date/time when it is recorded on a "Memory Stick" is recorded. You cannot record the camera data.

When you press PHOTO on the Remote Commander

Your camcorder immediately records the image that is on the LCD screen when you press the button.

Recording an image from a tape as a still image

Recording a still image from other equipment

Before operation

Set DISPLAY in  to LCD in the menu settings. (The default setting is LCD.)

- (1) Set the POWER switch to VCR.
- (2) When using the A/V connecting cable, set VIDEOINPUT to the appropriate position depending on the player. (p. ••)
- (3) Play back the recorded tape, or turn the TV on to see the desired program.
The image of the other equipment is displayed on the LCD screen or in the viewfinder.
- (4) At the point where you want to record, follow the steps 3 and 4 on page ••.

Using the A/V connecting cable

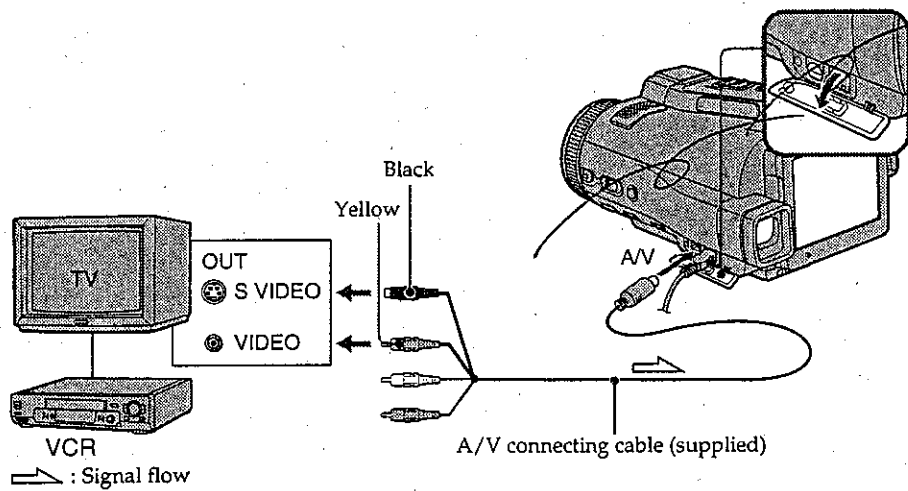

Connect the yellow plug of the A/V connecting cable to the video jack on the VCR or the TV.

Recording an image from a tape as a still image

If your TV or VCR has an S video jack

Connect using the S video plug to faithfully obtain original pictures. With this connection, you do not need to connect the yellow (video) plug of the A/V connecting cable. Connect the S video plug to the S video jack of the VCR. This connection produces higher quality MICROMV format pictures.

Using the i.LINK cable

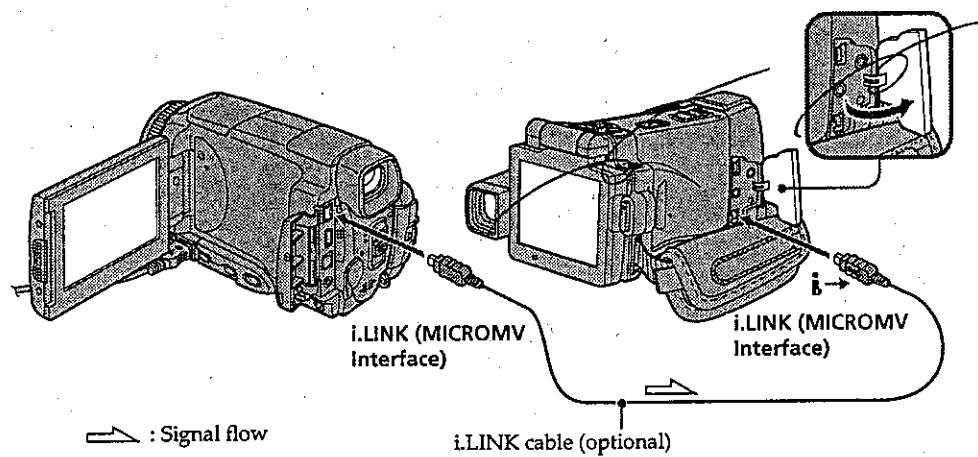

Note

When recording from a tape in poor recording condition, for example, a tape that is worn out from repeated dubbing, recording is interrupted, or "REC ERROR" appears and recording cannot be carried out. Record distortion-free images.

Superimposing a still image in a "Memory Stick" on an image

- MEMORY MIX

You can superimpose a still image you have recorded on a "Memory Stick" on top of the moving picture you are recording.

You can record the superimposed images on a tape or a "Memory Stick." (However, you can record only superimposed still images on the "Memory Stick.")

M. CHROM (Memory chroma key)

You can swap only the blue area of a still image such as an illustration or a frame with a moving picture.

M. LUMI (Memory luminance key)

You can swap the brighter area of a still image (such as a handwritten illustration or a title) with a moving picture. To use this function, we recommend recording a title on a "Memory Stick" before a trip or event.

C. CHROM (Camera chroma key)

You can superimpose a moving picture on top of a still image such as an image which can be used as background. Shoot the subject against a blue background. Only the blue area of the moving picture will be swapped with a still image.

M. OVERLAP* (Memory overlap)

You can make a moving picture fade in on top of a still image.

* The superimposed image using Memory overlap function can be recorded on tapes only.

"Memory Stick" Operations

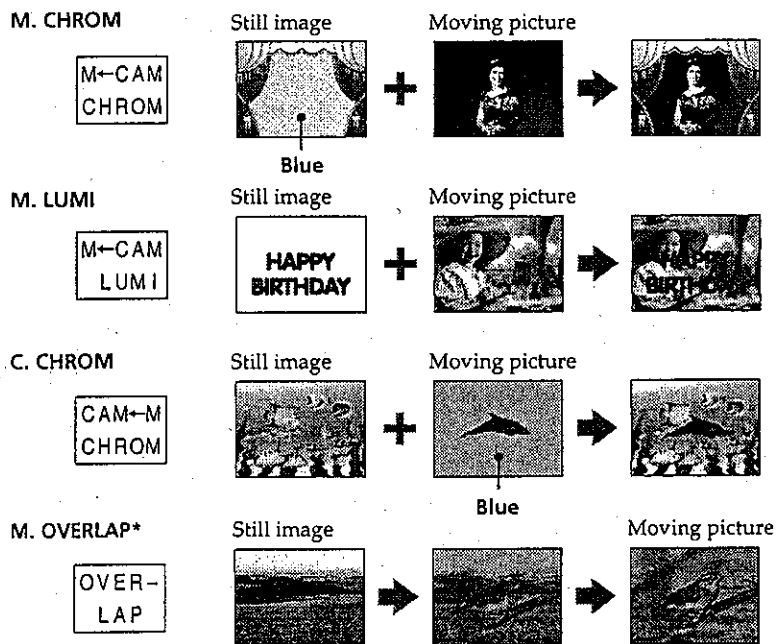

* The superimposed image using Memory overlap function can be recorded on tapes only.

Superimposing a still image in a "Memory Stick" on an image - MEMORY MIX

Recording a superimposed image to a tape

Before operation

- Insert a tape for recording into your camcorder.
- Insert a "Memory Stick" recorded with still images into your camcorder.

- (1) Set the POWER switch to CAMERA.
- (2) Press FN and go to PAGE2.
- (3) Press MEM MIX. The last image recorded on the "Memory Stick" appears on the right lower part of the LCD screen.
- (4) Press -/+ on the right lower corner of the LCD screen to select the still image which you want to superimpose.
 - : To see the previous image
 - + : To see the next image
- (5) Press a desired mode. The still image is superimposed on the moving picture.
- (6) Press -/+ on the left lower corner of the LCD screen to adjust the effect, then press \Rightarrow OK to return to PAGE2.

- M. CHROM: Blue chroma key (only blue background portion) to extract a still image and superimpose it on a moving picture
- M. LUMI: Brightness level used when extracting a still image and superimposing it on a moving picture
- C. CHROM: Blue chroma key (only blue background portion) to extract a moving picture and superimpose it on a still image
- M. OVERLAP: No adjustment necessary

The fewer bars there are on the LCD screen, the stronger the effect.

- (7) Press EXIT to return to FN.
- (8) Press START/STOP to start recording.

Superimposing a still image in a "Memory Stick" on an image - MEMORY MIX

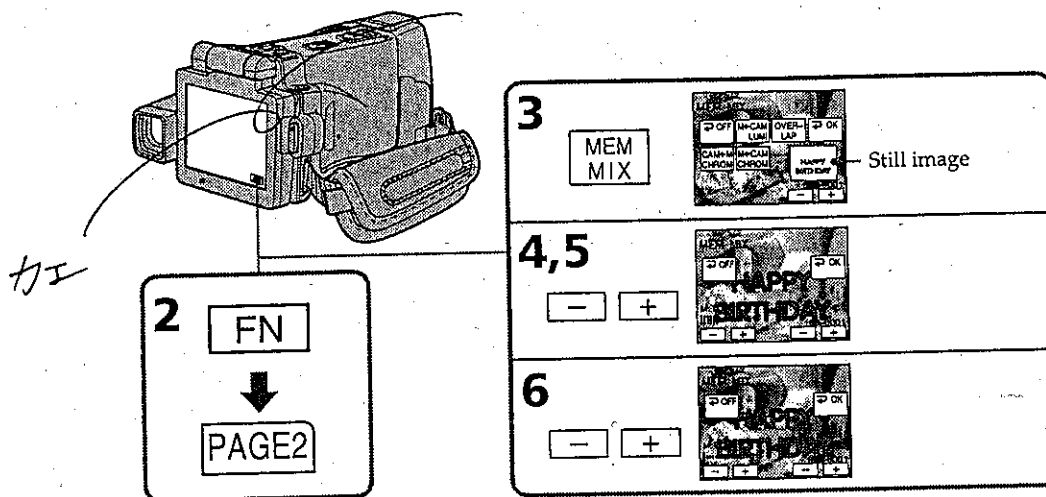

To change the still image to be superimposed

Press -/+ on the right lower corner before step 6.

To cancel MEMORY MIX

Press \Rightarrow OFF. The display returns to PAGE2.

Notes

- You cannot use the MEMORY MIX function for moving pictures recorded on the "Memory Stick."
- When the overlapping still image has a large amount of white, the thumbnail image of the picture may not be clear.
- During recording you cannot reselect the mode setting. Press \Rightarrow OFF to return to PAGE2.

Image data modified on your computer or shot with other equipment
You may not be able to play modified images back with your camcorder.

To record a still image on a tape as it is
In the M. LUMI mode press -/+ to increase the bar indicator to the maximum position.

When you select M. OVERLAP

You cannot change the still image. Press \Rightarrow OFF to cancel the M. OVERLAP mode, then select the image again.

"Memory Stick" Operations

Superimposing a still image in a "Memory Stick" on an image - MEMORY MIX

Recording a superimposed image to a "Memory Stick" as a still image

Before operation

Insert a recorded "Memory Stick" into your camcorder.

- (1) Set the POWER switch to MEMORY.
- (2) Press FN and go to PAGE2.
- (3) Press MEM MIX. The last image recorded on the "Memory Stick" appears on the right corner of the LCD screen.
- (4) Press -/+ on the right lower corner of the LCD screen to select the still image which you want to superimpose.
 - : To see the previous image
 - + : To see the next image
- (5) Press a desired mode. The still image is superimposed on the moving picture.
- (6) Press -/+ on the left lower corner of the LCD screen to adjust the effect, then press \Rightarrow OK. The display returns to PAGE2.

M. CHROM: Blue chroma key (blue background) to extract a still image and superimpose it on a moving picture

M. LUMI: Brightness level used when extracting a still image and superimposing it on a moving picture

C. CHROM: Blue chroma key (blue background) to extract a moving picture and superimpose it on a still image

The fewer bars there are on the LCD screen, the stronger the effect.

- (7) Press EXIT to return to FN.
- (8) Press PHOTO deeper to start recording.

The image displayed on the LCD screen will be recorded on a "Memory Stick."
Recording is complete when the bar scroll indicator disappears.

Recording moving pictures on a "Memory Stick" – MPEG movie recording

You can record moving pictures with sound on the "Memory Stick."

Before operation

Insert a "Memory Stick" into your camcorder.

- (1) Set the POWER switch to MEMORY.
- (2) Press START/STOP. Your camcorder starts recording. The camera recording lamp located on the front of your camcorder lights up.

Quality mode	recordable time
SUPER FINE	Maximum 45 s
FINE	Maximum 1 min 10 s
STANDARD	Maximum 2 min 20 s
LIGHTMODE	Maximum 4 min 40 s

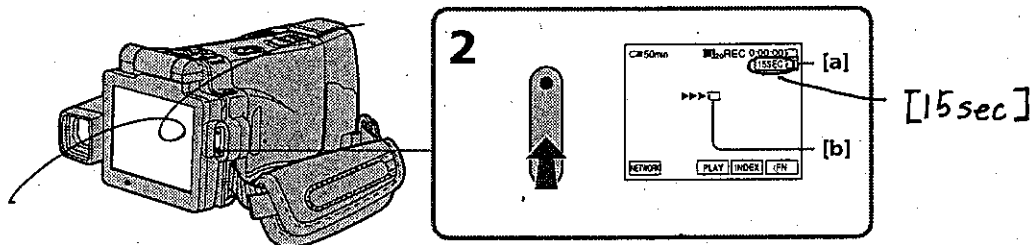

[a]: Recording time indicator can be recorded on the "Memory Stick."

[b]: This indicator is displayed for five seconds after pressing START/STOP. This indicator is not recorded.

To stop recording

Press START/STOP.

Recording moving pictures on a "Memory Stick" - MPEG movie recording

Note

Sound is recorded in monaural.

MPEG movie recorded with your camcorder:

- Is MPEG MOVIE AD
- Can only be played back on a digital still camera or digital video camera recorder which has an MPEG MOVIE AD function.
- Cannot be output from the i.LINK (MICROMV Interface).

When the POWER switch is set to MEMORY

The following functions do not work:

- Wide mode
- Digital zoom
- SteadyShot
- Super NightShot
- Color Slow Shutter
- Fader
- Picture effect
- Digital effect
- Title
- Sports lesson of PROGRAM AE (The indicator flashes.)

When using an external flash (optional)

Turn the power of the external flash off when recording moving pictures on a "Memory Stick."

Otherwise, the charging sound of the flash may be recorded.

Recording date/time

The date/time are not displayed while recording. However, they are automatically recorded onto the "Memory Stick." To display the recording date/time, press DATA CODE during playback. Various settings cannot be recorded. You can also use the Remote Commander for this operation (p. ●●).

During recording on a "Memory Stick"

Do not eject the cassette from your camcorder. While ejecting the tape, sound is not recorded on "Memory Stick."

When the POWER switch is set to MEMORY

The angle of view is slightly larger compared with the angle of view in CAMERA mode.

Recording moving pictures on a "Memory Stick" - MPEG movie recording

Self-timer MPEG movie recording

You can record pictures on the "Memory Stick" with the self-timer. You can also use the Remote Commander for this operation.

- (1) Set the POWER switch to MEMORY.
- (2) Press FN and go to PAGE2.
- (3) Press SELFTIMER.

The  (self-timer) indicator appears on the LCD screen.

- (4) Press START/STOP.

Self-timer starts counting down from 10 with a beep. In the last two seconds of the countdown, the beep gets faster, then recording starts automatically.

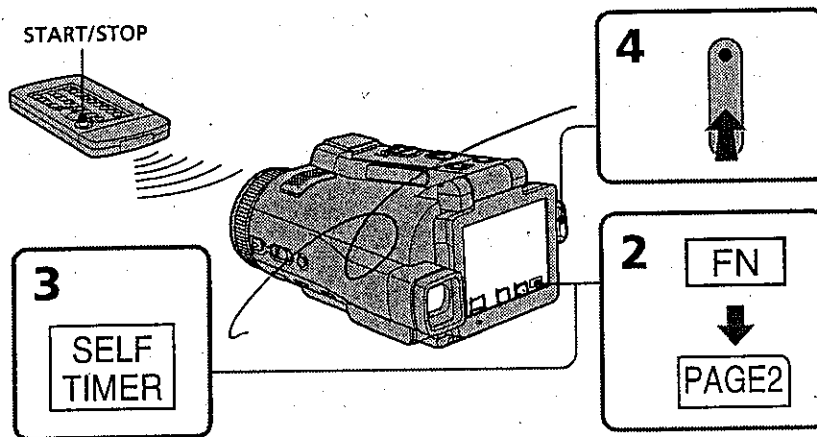

To stop the countdown

Press START/STOP.

To restart the countdown, press START/STOP again.

To cancel the self-timer recording

Press SELFTIMER so that the  (self-timer) indicator disappears on the LCD screen. You cannot cancel the self-timer recording using the Remote Commander.

Note

The self-timer recording mode is automatically canceled when:

- Self-timer recording is finished.
- The POWER switch is set to OFF (CHG) or VCR.

Recording a picture from a tape as a moving picture

Your camcorder can read moving picture data recorded on a tape and record it as a moving picture on a "Memory Stick." Your camcorder can also take in moving picture data through the input connector and record it as a moving picture on a "Memory Stick."

Before operation

- Insert a recorded tape into your camcorder.
- Insert a "Memory Stick" into your camcorder.

- (1) Set the POWER switch to VCR.
- (2) Press . The picture recorded on the tape is played back.
- (3) Press START/STOP at the scene where you want to start recording from.

Quality mode	recordable time
SUPER FINE	Maximum 45 s
FINE	Maximum 1 min 10 s
STANDARD	Maximum 2 min 20 s
LIGHTMODE	Maximum 4 min 40 s

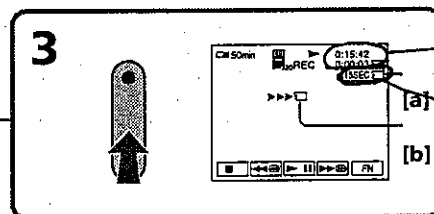
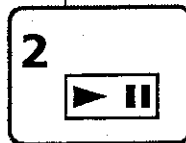
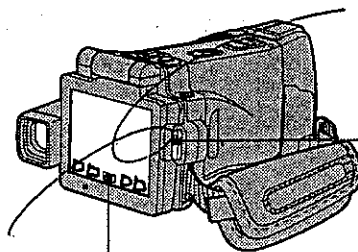

- [a]: Recording time indicator can be recorded on the "Memory Stick."
 [b]: This indicator is displayed for five seconds after pressing START/STOP. This indicator is not recorded.

0:15:42
 0:03:15
 [15sec]

To stop recording

Press START/STOP.

Note

Sound recorded in stereo is converted to monaural sound when recording from a tape.

When the "Memory Stick" access lamp is lit or flashing

Do not shake or strike the unit. As well do not turn the power off, eject a "Memory Stick" or take out the battery pack. Otherwise, the image data breakdown may occur.

Titles which have already been recorded on tapes

You cannot record the titles on the "Memory Stick." The title does not appear while you are recording a moving picture with START/STOP.

Recording date/time

The date/time when it is recorded on a "Memory Stick" is recorded. You cannot record the camera data.

Recording a picture from a tape as a moving picture

Recording a moving picture from other equipment

Before operation

Set DISPLAY in  to LCD in the menu settings. (The default setting is LCD.)

- (1) Set the POWER switch to VCR.
- (2) When using the A/V connecting cable, set VIDEOINPUT to the appropriate position depending on the player. (p. ••)
- (3) Play back the recorded tape, or turn the TV on to see the desired program. The image of the other equipment is displayed on the LCD screen or in the viewfinder.
- (4) Perform step 3 on page •• at the point where you want to start recording.

Using the A/V connecting cable

Press START/STOP at the scene where you want to start recording from.

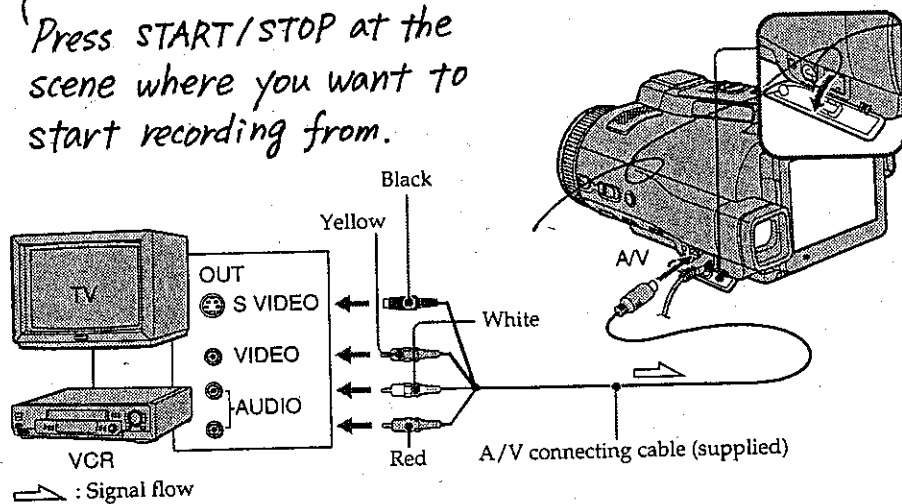

Connect the yellow plug of the A/V connecting cable to the video jack on the VCR or the TV.

If your TV or VCR has an S video jack

Connect using the S video plug to faithfully obtain original pictures. With this connection, you do not need to connect the yellow (video) plug of the A/V connecting cable. Connect the S video plug to the S video jack of the VCR. This connection produces higher quality MICROMV format pictures.

Recording a picture from a tape as a moving picture

Using the i.LINK cable

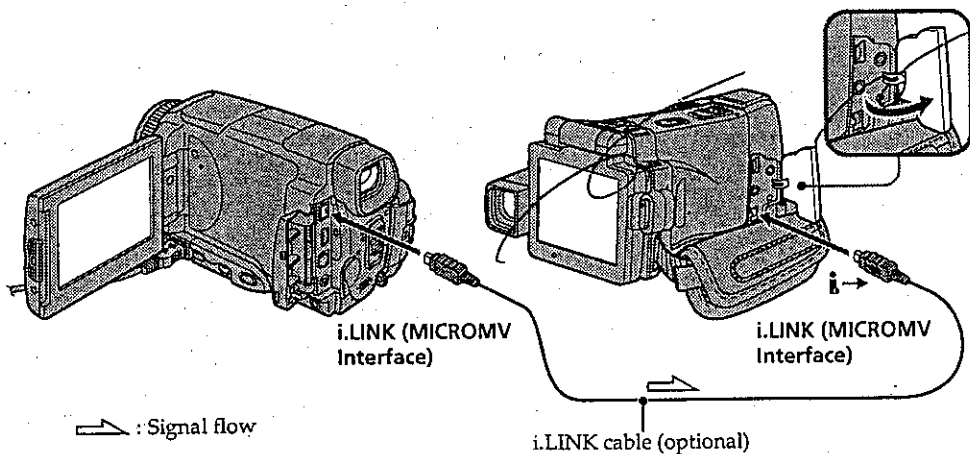

Note

In the following instances "REC ERROR" appears and recording is canceled:

- When recording from a tape in poor recording condition, for example, a tape that is worn out from repeated dubbing.
- When the input signal is cut off.

During recording on a "Memory Stick"

Do not eject the cassette from your camcorder. During ejecting the tape, sound is not recorded on a "Memory Stick."

"Memory Stick" Operations

Viewing a still image – Memory photo playback

You can play back still images recorded on a "Memory Stick." You can also play back six images including moving pictures on single screen arranged in the same order as a "Memory Stick" by selecting the index screen.

Before operation

Insert a "Memory Stick" into your camcorder.

- (1) Set the POWER switch to MEMORY or VCR.
- (2) Press PLAY or  PB. The last recorded image is displayed.
- (3) Press -/+ to select the desired still image.
 - : To see the previous image
 - + : To see the next image

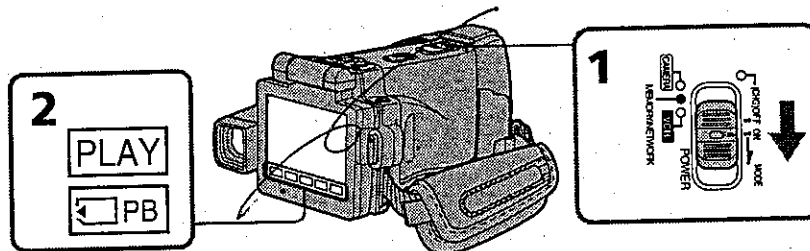

To stop memory photo playback

Press CAM, VCR on your camcorder or MEMORY PLAY on the Remote Commander.

Note

You may not be able to play back images with your camcorder:

- When playing back image data modified on your computers
- When playing back image data shot with other equipment

Playback still images recorded on the "Memory Stick"

Playback images are not output from the i.LINK (MICROMV Interface).

File name

- The directory number may not be displayed and only the file name may be displayed if the structure of the directory does not conform to the DCF standard.
- " DIRECTORY ERROR" may appear on the LCD screen if the structure of the directory does not conform to the DCF standard. If this message appears, you can play back images but cannot record them on the "Memory Stick."
- The file name flashes on the LCD screen if the file is corrupted or the file is unreadable.

Viewing a still image – Memory photo playback

To play back recorded images on a TV screen

- Connect your camcorder to the TV with the A/V connecting cable supplied with your camcorder before the operation.
- When operating memory photo playback on a TV or on the LCD screen, the image quality may appear to have deteriorated. This is not a malfunction. The image data is as good as ever.
- Turn the audio volume of the TV down before operation, or noise (howling) may be output from the TV speakers.

Still image

You can select still images also with -/+ on PAGE1, PAGE2 or PAGE3.

Screen indicators during still image playback

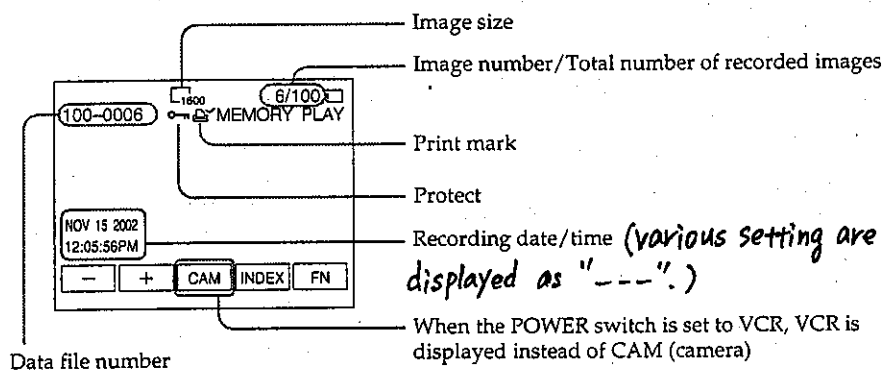

"Memory Stick" Operations

When no images are recorded on the "Memory Stick"

When you press MEMORY PLAY on the Remote Commander, "NO FILE" appears.

Recording data

To display the recording data (date/time or various settings when recorded), press DATA CODE during playback. You can also use the Remote Commander for this operation (p. ●●).

To make LCD screen indicators disappear

Press DISPLAY/TOUCH PANEL.



Viewing a still image – Memory photo playback

Playing back six recorded images at a time (index screen)

You can play back six recorded images at a time. This function is especially useful when searching for a particular image.

- (1) Set the POWER switch to MEMORY or VCR.
- (2) In VCR mode, press  PB.
In MEMORY mode, go to step 3.
- (3) Press INDEX to display the index.

A red  mark appears above the image that is displayed before changing to the index screen mode.

- To display the previous six images, press .
 - To display the following six images, press .
- You can also use -/+ on the Remote Commander.

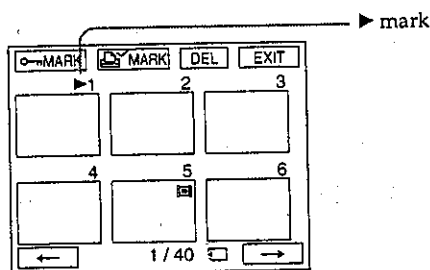

To return to FN
Press EXIT.

To return to the normal playback screen (single screen)
Press the image you want to display.

Note

When displaying the index screen, the number appears above each image. This indicates the order in which images are recorded on the "Memory Stick." These numbers are different from the data file names (p. **).



Image data modified with personal computers or shot with other equipment
These files may not be displayed on the index screen.

Viewing a moving picture – MPEG movie playback

You can play back moving pictures recorded on a "Memory Stick." You can also play back six images including still images in order at a time by selecting the index screen.



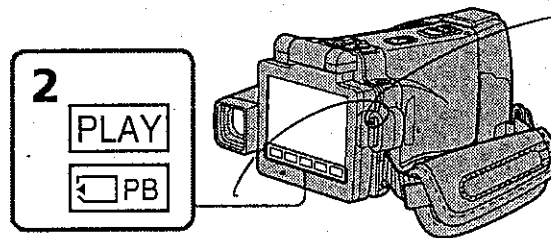

Before operation

Insert a "Memory Stick" into your camcorder.

- (1) Set the POWER switch to MEMORY or VCR.
 - (2) Press PLAY or  PB. The last recorded image is displayed.
 - (3) Press -/+ to select the desired moving pictures.
 - : To see the previous picture
 - + : To see the next picture
 - (4) Press MPEG   to start playback.
 - (5) Press VOL- or VOL+ to adjust the volume.
 - VOL- : To decrease the volume
 - VOL+ : To increase the volume
- When the LCD screen is closed, no sound is heard from your camcorder.



To pause MPEG movie playback

Press MPEG  . To resume playback, press MPEG   again.

To change the screen size

Press SCR N SIZE. The screen size changes as follows:

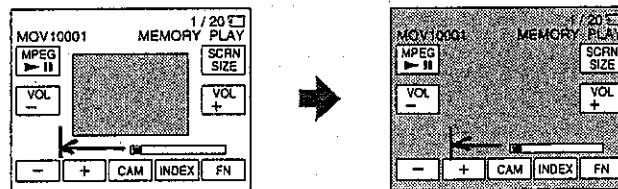

Notes on the screen size

- The picture may not be displayed at the middle of the LCD screen, depending on the movie.
- Even if you switch the screen size, the picture may not be displayed full-screen size, depending on the movie.

Note

- You may not be able to play back images with your camcorder:
- When playing back image data modified on your computers
 - When playing back image data shot with other equipment

Viewing a moving picture – MPEG movie playback

MPEG movie recorded with your camcorder:

- Is MPEG MOVIE AD
- Can only be played back on a digital still camera or digital video camera recorder which has an MPEG MOVIE AD function.
- Cannot be output from the i.LINK (MICROMV Interface).

To play back recorded images on a TV screen

- Connect your camcorder to the TV with the A/V connecting cable supplied with your camcorder before operation.
- Turn the audio volume of the TV down before operation, or noise (howling) may be output from the TV speakers.

Moving picture

You can select moving pictures also with -/+ on PAGE1, PAGE2 or PAGE3.

When no images are recorded on the "Memory Stick"

When you press MEMORY PLAY on the Remote Commander, "NO FILE" appears.

Screen indicators during moving picture playback

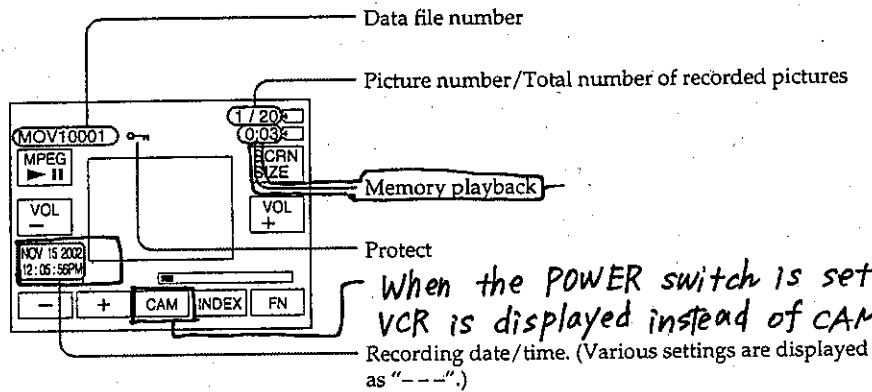

Recording date/time

To display the recording date/time, press DATA CODE during playback. You can also use the Remote Commander for this operation (p. **).

To make screen indicators disappear

Press DISPLAY/TOUCH PANEL.

Copying still images recorded on a "Memory Stick" to a tape

You can copy still images recorded on a "Memory Stick" and record them to a tape. You can also use the Remote Commander for this operation.

Before operation

- Insert a tape for recording into your camcorder.
- Insert a "Memory Stick" into your camcorder.

- (1) Set the POWER switch to VCR.
- (2) Using the video control buttons, search a point where you want to record the desired images and stop playback.
- (3) Press PB. The last recorded image is displayed.
- (4) Press -/+ to select the desired image.
 - : To see the previous image
 - + : To see the next image
- (5) Press FN and go to PAGE3.
- (6) Press REC CTRL, then REC START. Copying starts. Press REC PAUSE at the scene where you want to stop recording.
- (7) If you have more to copy, repeat steps 4 to 6.

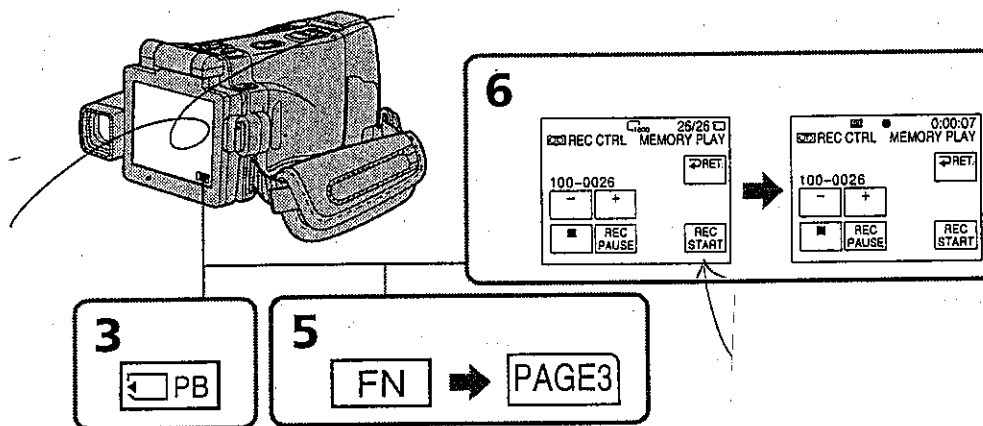

To stop copying in the middle

Press on the LCD screen or STOP on the Remote Commander.

To start copying using the Remote Commander

After step 4, press REC and the right button to start copying.

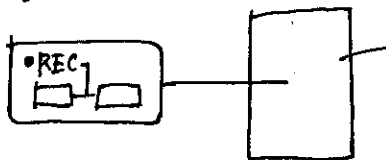

Copying still images recorded on a "Memory Stick" to a tape

Notes

- You cannot copy MPEG movie files to the tape.
- You cannot copy the index screen to the tape.

During copying

You cannot operate the following functions:

- MEMORY PLAY
- MEMORY INDEX
- MEMORY DELETE
- MEMORY +/-
- MEMORY MIX

Image data modified on your computers or shot with other equipment
You may not be able to copy modified images with your camcorder.

Enlarging still images recorded on a "Memory Stick" – Memory PB ZOOM

You can enlarge still images recorded on a "Memory Stick." You can select and view a desired part from the enlarged still image. Also, you can copy the desired part of the enlarged still image to a "Memory Stick."

Before operation

Insert a "Memory Stick" into your camcorder.

- (1) In the memory playback mode, press FN and go to PAGE2.
- (2) Press PB ZOOM. PB ZOOM screen appears.
- (3) Press the area that you want to enlarge in the frame on the PB ZOOM screen.
The area you pressed moves to the center of the LCD screen, and the playback image is enlarged at twice the size. If you press the other area, the area moves to the center of the LCD screen.
- (4) Adjust the zoom ratio by the zoom lever.
You can select the image from 1.1 times up to five times its size.
"W" side: Decrease the zoom ratio.
"T" side: Increase the zoom ratio.

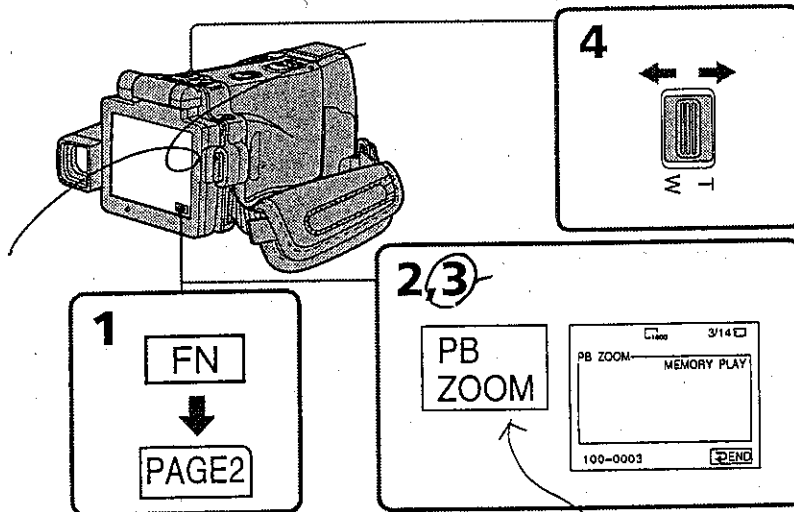

To cancel the Memory PB ZOOM function
Press \Rightarrow END.

Enlarging still images recorded on a "Memory Stick" - Memory PB ZOOM

Images in the Memory PB ZOOM mode

Images are not output through the i.LINK (MICROMV Interface).

In the Memory PB ZOOM mode

If you press DISPLAY/TOUCH PANEL, the frame on the Memory PB ZOOM screen disappears. You cannot move the part you pressed to the center of the LCD screen.

Edge of an enlarged image

The edge of an enlarged image cannot be displayed in the center of the LCD screen.

Moving pictures recorded on the "Memory Stick"

The PB ZOOM function does not work.

To record an image processed by PB ZOOM on the "Memory Stick"

Press PHOTO to record the image processed by PB ZOOM. (Images are recorded at 640 x 480 size.)

Playing back images continuously - SLIDE SHOW

Your camcorder can automatically play back images in sequence. This function is especially useful when checking recorded images or during a presentation.

Before operation

Insert a "Memory Stick" into your camcorder.

- (1) Set the POWER switch to MEMORY.
- (2) Press FN to display PAGE1.
- (3) Press MENU, then select SLIDE SHOW in  in the menu settings (p. ●●). And press EXEC.
- (4) Press START. Your camcorder plays back the images recorded on a "Memory Stick" in sequence.

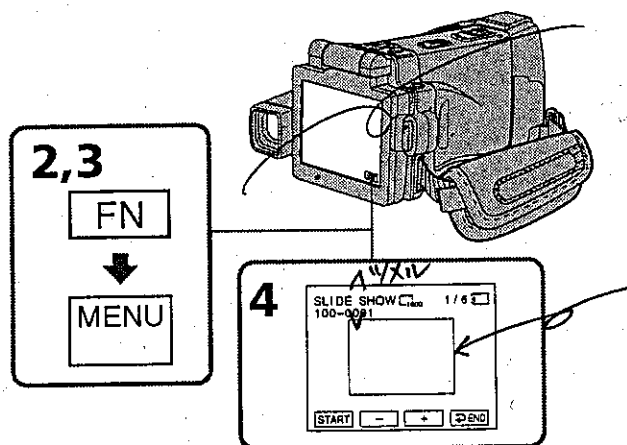

To stop the slide show

Press  END.



To pause during a slide show

Press PAUSE.

To return to FN

Press  END, then press EXIT.

To start the slide show from a particular image

Select the desired image using  /  buttons before step 4.

To view the recorded images on TV

Connect your camcorder to a TV with the A/V connecting cable supplied with your camcorder (p. ●●) before operation.

If you change the "Memory Stick" during operation

The slide show does not operate. If you change the "Memory Stick," be sure to follow the steps again from the beginning.

When there are no images on the "Memory Stick"



 NO FILE" appears.

Preventing accidental erasure – Image protection

To prevent accidental erasure of important images, you can protect selected images.

Before operation

Insert a "Memory Stick" into your camcorder.

- (1) Set the POWER switch to MEMORY or VCR.
- (2) In VCR mode, press  PB.
In MEMORY mode, go to step 3.
- (3) Press INDEX to display the index.
- (4) Press  MARK. The screen to protect the image appears.
- (5) Press the image you want to protect. The "

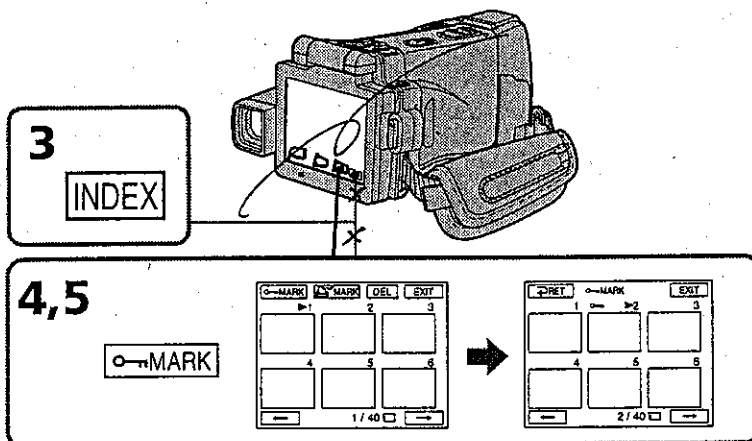

To return to FN

Press EXIT.

To cancel image protection

Press the image you want to cancel image protection in step 5 again. The "

Note

Formatting erases all information on the "Memory Stick," including the protected image data. Check the contents of the "Memory Stick" before formatting.

If the write-protect tab on the "Memory Stick" is set to LOCK
You cannot carry out image protection.