

FM/AM Digital Media Player

Operating Instructions GB

Mode d'emploi FR

Owner's Record

The model and serial numbers are located on the bottom of the unit.
Record the serial number in the space provided below.
Refer to these numbers whenever you call upon your Sony dealer regarding this product.

Model No. DSX-A415BT

Serial No. _____

To cancel the demonstration (DEMO) display, see page 21.

For the connection/installation, see page 37.

Pour annuler l'affichage de démonstration (DEMO), reportez-vous à la page 23.

Pour le raccordement/l'installation, reportez-vous à la page 41.



* 4 6 9 7 4 1 8 2 1 * (1)

For safety, be sure to install this unit in the dashboard of the car as the rear side of the unit becomes hot during use.

For details, see "Connection/Installation" (page 37).

The nameplate indicating operating voltage, etc., is located on the bottom of the chassis.

Warning

**FOR THE CUSTOMERS IN THE USA.
NOT APPLICABLE IN CANADA,
INCLUDING IN THE PROVINCE OF
QUEBEC.**

**POUR LES CLIENTS AUX ÉTATS-UNIS.
NON APPLICABLE AU CANADA, Y
COMPRIS LA PROVINCE DE QUÉBEC.**

This equipment has been tested and found to comply with the limits for a Class B digital device, pursuant to Part 15 of the FCC Rules.

These limits are designed to provide reasonable protection against harmful interference in a residential installation. This equipment generates, uses, and can radiate radio frequency energy and, if not installed and used in accordance with the instructions, may cause harmful interference to radio communications. However, there is no guarantee that interference will not occur in a particular installation. If this equipment does cause harmful interference to radio or television reception, which can be determined by turning the equipment off and on, the user is encouraged to try to correct the interference by one or more of the following measures:

- Reorient or relocate the receiving antenna.
- Increase the separation between the equipment and receiver.
- Connect the equipment into an outlet on a circuit different from that to which the receiver is connected.
- Consult the dealer or an experienced radio/TV technician for help.

You are cautioned that any changes or modifications not expressly approved in this manual could void your authority to operate this equipment.

This device complies with Part 15 of the FCC Rules and Industry Canada's licence-exempt RSSs. Operation is subject to the following two conditions:

- (1) This device may not cause interference; and
- (2) This device must accept any interference, including interference that may cause undesired operation of the device.

This transmitter must not be co-located or operated in conjunction with any other antenna or transmitter.

Under Industry Canada regulations, this radio transmitter may only operate using an antenna of a type and maximum (or lesser) gain approved for the transmitter by Industry Canada. To reduce potential radio interference to other users, the antenna type and its gain should be so chosen that the equivalent isotropically radiated power (e.i.r.p.) is not more than that necessary for successful communication.

This equipment complies with FCC/IC radiation exposure limits set forth for an uncontrolled environment and meets the FCC radio frequency (RF) Exposure Guidelines and RSS-102 of the IC radio frequency (RF) Exposure rules. This equipment has very low levels of RF energy that is deemed to comply without maximum permissive exposure evaluation (MPE).

Avertissement

Le présent appareil est conforme aux CNR d'Industrie Canada applicables aux appareils radio exempts de licence.

L'exploitation est autorisée aux deux conditions suivantes :

- (1) l'appareil ne doit pas produire de brouillage;
- (2) l'utilisateur de l'appareil doit accepter tout brouillage radioélectrique subi, même si le brouillage est susceptible d'en compromettre le fonctionnement.

l'exposition aux RF

L'antenne (ou les antennes) doit être installée de façon à maintenir tout instant une distance minimum de au moins 20 cm entre la source de radiation (l'antenne) et toute personne physique.

CAUTION

The use of optical instruments with this product will increase eye hazard.

For the State of California, USA only

Perchlorate Material – special handling may apply, See www.dtsc.ca.gov/hazardouswaste/perchlorate



WARNING: Do not ingest battery, Chemical Burn Hazard.

The remote commander contains a coin/button cell battery. If the coin/button cell battery is swallowed, it can cause severe internal burns in just 2 hours and can lead to death.

Keep new and used batteries away from children. If the battery compartment does not close securely, stop using the product and keep it away from children.

If you think batteries might have been swallowed or placed inside any part of the body, seek immediate medical attention.

Note on the lithium battery

Do not expose the battery to excessive heat such as direct sunlight, fire or the like.

Warning if your car's ignition has no ACC position

Be sure to set the AUTO OFF function (page 22). The unit will shut off completely and automatically in the set time after the unit is turned off, which prevents battery drain. If you do not set the AUTO OFF function, press and hold OFF until the display disappears each time you turn the ignition off.

Disclaimer regarding services offered by third parties

Services offered by third parties may be changed, suspended, or terminated without prior notice. Sony does not bear any responsibility in these sorts of situations.



Important notice

Caution

IN NO EVENT SHALL SONY BE LIABLE FOR ANY INCIDENTAL, INDIRECT OR CONSEQUENTIAL DAMAGES OR OTHER DAMAGES INCLUDING, WITHOUT LIMITATION, LOSS OF PROFITS, LOSS OF REVENUE, LOSS OF DATA, LOSS OF USE OF THE PRODUCT OR ANY ASSOCIATED EQUIPMENT, DOWNTIME, AND PURCHASER'S TIME RELATED TO OR ARISING OUT OF THE USE OF THIS PRODUCT, ITS HARDWARE AND/OR ITS SOFTWARE.

Dear customer, this product includes a radio transmitter.

Please check your vehicle operation manual or contact the manufacturer of your vehicle or your vehicle dealer, before you install this product into your vehicle.

Emergency calls

This BLUETOOTH car handsfree and the electronic device connected to the handsfree operate using radio signals, cellular, and landline networks as well as user-programmed function, which cannot guarantee connection under all conditions. Therefore do not rely solely upon any electronic device for essential communications (such as medical emergencies).

On BLUETOOTH communication

- Microwaves emitting from a BLUETOOTH device may affect the operation of electronic medical devices. Turn off this unit and other BLUETOOTH devices in the following locations, as it may cause an accident.
 - where inflammable gas is present, in a hospital, train, airplane, or petrol station
 - near automatic doors or a fire alarm
- This unit supports security capabilities that comply with the BLUETOOTH standard to provide a secure connection when the BLUETOOTH wireless technology is used, but security may not be enough depending on the setting. Be careful when communicating using BLUETOOTH wireless technology.

- We do not take any responsibility for the leakage of information during BLUETOOTH communication.

If you have any questions or problems concerning your unit that are not covered in this manual, consult your nearest Sony dealer.

Table of Contents

Warning	2
Guide to Parts and Controls	6

Getting Started

Detaching the Front Panel	8
Resetting the Unit	8
Setting the Clock	8
Preparing a BLUETOOTH Device	8
Connecting a USB Device	11
Connecting Other Portable Audio Device	11

Listening to the Radio

Listening to the Radio	11
Using Radio Data System (RDS)	12
Listening to the SiriusXM Radio	12

Playback

Playing a Disc	14
Playing a USB Device	14
Playing a BLUETOOTH Device	14
Searching and Playing Tracks	15

Listening to Pandora®

Setting up Pandora®	16
Streaming Pandora®	16
Available Operations in Pandora®	16

Handsfree Calling (via BLUETOOTH only)

Receiving a Call	17
Making a Call	17
Available Operations during Call	18

Useful Functions

Sony Music Center with iPhone/Android	19
Using Siri Eyes Free	20

Settings

Canceling the DEMO Mode	21
Basic Setting Operation	21
General Setup (GENERAL)	22
Sound Setup (SOUND)	23
Display Setup (DISPLAY)	24
BLUETOOTH Setup (BLUETOOTH)	24
Sony Music Center Setup (SONY APP)	25

Additional Information

Updating the Firmware	25
Precautions	25
Maintenance	27
Specifications	27
Troubleshooting	30
Messages	33

Connection/Installation

Cautions	37
Parts List for Installation	37
Connection	38
Installation	40

Guide to Parts and Controls

Main unit

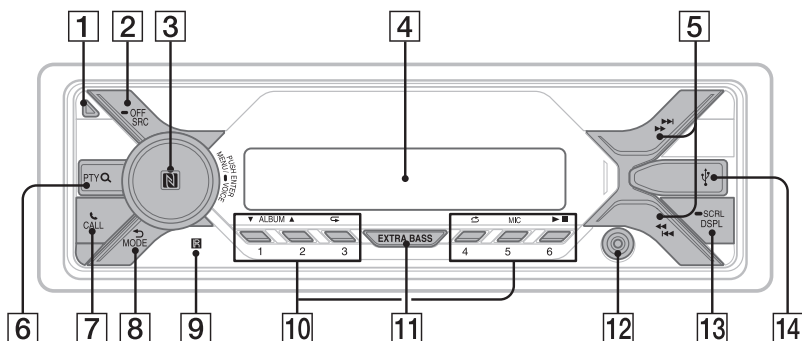

1 Front panel release button

2 SRC (source)

Turn on the power.
Change the source.

●OFF

Press and hold for 1 second to turn the source off and display the clock.
Press and hold for more than 2 seconds to turn off the power and the display.
If the unit is turned off and the display disappears, operation by the remote commander is not available.

3 Control dial

Rotate to adjust the volume.

PUSH ENTER

Enter the selected item.
Press SRC, rotate then press to change the source (timeout in 2 seconds).

MENU

Open the setup menu.

●VOICE (page 18,20,21)

Press and hold for more than 2 seconds to activate voice dial, voice recognition (Android™ smartphone only), or the Siri function (iPhone only).

N-Mark

Touch the control dial with Android smartphone to make BLUETOOTH connection.

4 Display window

⏮/⏭ (SEEK +/-)

Tune in radio stations automatically. Press and hold to tune manually.

⏪/⏩ (prev/next)

⏮/⏭ (fast-reverse/fast-forward)

6 PTY (program type)

Select PTY in RDS.

Q (browse) (page 13)

Enter the browse mode during playback.
(Not available when a USB device in Android mode or iPod is connected.)

7 CALL

Enter the call menu. Receive/end a call.
Press and hold for more than 2 seconds to switch the BLUETOOTH signal.

8 ↶ (back)

Return to the previous display.

MODE (page 8,11,18)

9 Receptor for the remote commander

10 Number buttons (1 to 6)

Receive stored radio stations. Press and hold to store stations.

ALBUM ▼/▲

Skip an album for audio device. Press and hold to skip albums continuously. (Not available when a USB device in Android mode or iPod is connected.) Press ▲ to thumbs up, or ▼ to thumbs down in Pandora® (page 16).

↺ (repeat)

(Not available when a USB device in Android mode is connected.)

↻ (shuffle)

(Not available when a USB device in Android mode is connected.)

MIC (page 18)

▶|| (play/pause)

13 EXTRA BASS

Reinforce bass sound in synchronization with the volume level. Press to change the EXTRA BASS setting: [1], [2], [OFF].

14 AUX input jack

15 DSPL (display)

Change display items.

■ SCRL (scroll)

Press and hold to scroll a display item.

16 USB port

RM-X231 Remote commander

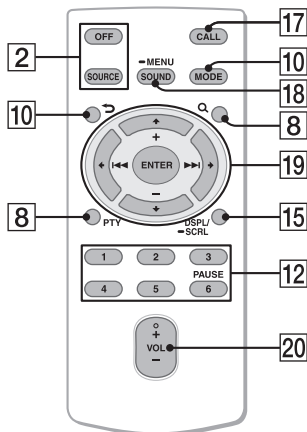

The VOL (volume) + button has a tactile dot.

17 CALL

Enter the call menu. Receive/end a call.

18 SOUND

Open the SOUND menu directly.

■ MENU

Press and hold to open the setup menu.

19 ◀/↑/↓/▶

Select a setup item, etc.

ENTER

Enter the selected item.

Press and hold for more than 2 seconds to establish or terminate the "SongPal" function.

◀◀/▶▶ (prev/next)

+/- (album +/-)

20 VOL (volume) +/-

Remove the insulation film before use.



Getting Started

Detaching the Front Panel

You can detach the front panel of this unit to prevent theft.

- 1 Press and hold OFF ① until the unit turns off, press the front panel release button ②, then pull the panel towards you to remove.

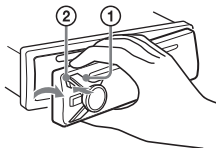

Caution alarm

If you turn the ignition switch to the OFF position without detaching the front panel, the caution alarm will sound for a few seconds. The alarm will only sound if the built-in amplifier is used.

Serial numbers

Make sure the serial numbers on the bottom of the unit and the back of the front panel are matched correctly. Otherwise you cannot make BLUETOOTH pairing, connection and disconnection by NFC.

Attaching the front panel

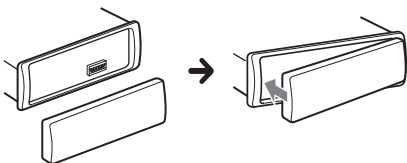

Resetting the Unit

Before operating the unit for the first time, or after replacing the car battery or changing connections, you must reset the unit.

- 1 Press DSPL and ↶ (back)/MODE for more than 2 seconds.

Note

Resetting the unit will erase the clock setting and some stored contents.

Setting the Clock

- 1 Press MENU, rotate the control dial to select [GENERAL], then press it.
- 2 Rotate the control dial to select [SET CLOCK-ADJ], then press it.
The hour indication flashes.
- 3 Rotate the control dial to set the hour and minute.
To move the digital indication, press ◀◀/▶▶ (SEEK -/+).
- 4 After setting the minute, press MENU.
The setup is complete and the clock starts.

To display the clock

Press DSPL.

Checking the Battery Voltage

You can check the current battery voltage. (Not available while the source is off and the clock is displayed.)

- 1 Press DSPL repeatedly until the battery voltage display appears.

Preparing a BLUETOOTH Device

You can enjoy music, or perform handsfree calling depending on the BLUETOOTH compatible device such as a smartphone, cellular phone and audio device (hereafter "BLUETOOTH device" if not otherwise specified). For details on connecting, refer to the operating instructions supplied with the device.

Before connecting the device, turn down the volume of this unit; otherwise, loud sound may result.

Connecting with a Smartphone by One touch (NFC)

By touching the control dial on the unit with an NFC* compatible smartphone, the unit is paired and connected with the smartphone automatically.

* NFC (Near Field Communication) is a technology enabling short-range wireless communication

between various devices, such as mobile phones and IC tags. Thanks to the NFC function, data communication can be achieved easily just by touching the relevant symbol or designated location on NFC compatible devices.

For a smartphone with Android OS 4.0 or lower installed, downloading the app "NFC Easy Connect" available at Google Play™ is required. The app may not be downloadable in some countries/regions.

1 Activate the NFC function on the smartphone.

For details, refer to the operating instructions supplied with the smartphone.

2 Touch the N-Mark part of the unit with the N-Mark part of the smartphone.

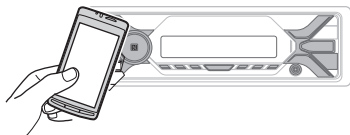

Make sure that  lights up on the display of the unit.

To disconnect by One touch

Touch the N-Mark part of the unit with the N-Mark part of the smartphone again.

Notes

- When making the connection, handle the smartphone carefully to prevent scratches.
- One touch connection is not possible when the unit is already connected to two NFC compatible devices. In this case, disconnect either device, and make connection with the smartphone again.

Pairing and connecting with a BLUETOOTH device

When connecting a BLUETOOTH device for the first time, mutual registration (called "pairing") is required. Pairing enables this unit and other devices to recognize each other. This unit can connect two BLUETOOTH devices (two cellular phones, or a cellular phone and an audio device).



- 1 Place the BLUETOOTH device within 1 m (3 ft) of this unit.
- 2 Press MENU, rotate the control dial to select [BLUETOOTH], then press it.
- 3 Rotate the control dial to select [SET PAIRING], then press it.
- 4 Rotate the control dial to select [SET DEVICE 1]* or [SET DEVICE 2]*, then press it.

 flashes while the unit is in pairing standby mode.

* [SET DEVICE 1] or [SET DEVICE 2] will be changed to the paired device name after pairing is complete.

- 5 Perform pairing on the BLUETOOTH device so it detects this unit.
- 6 Select [DSX-XXXX] (your model name) shown in the display of the BLUETOOTH device.

If your model name does not appear, repeat from step 2.



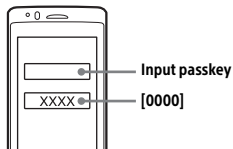

- 7 If passkey* input is required on the BLUETOOTH device, input [0000].

* Passkey may be called "Passcode," "PIN code," "PIN number" or "Password," etc., depending on the device.



When pairing is made,  stays lit.

- 8 Select this unit on the BLUETOOTH device to establish the BLUETOOTH connection.

 or  lights up when the connection is made.

Note

While connecting to a BLUETOOTH device, this unit cannot be detected from another device. To enable detection, enter the pairing mode and search for this unit from another device.

To start playback

For details, see "Playing a BLUETOOTH Device" (page 14).



To disconnect the paired device

Perform steps 2 to 4 to disconnect after this unit and the BLUETOOTH device are paired.



Connecting with a paired BLUETOOTH device

To use a paired device, connection with this unit is required. Some paired devices will connect automatically.



- 1 Press **MENU**, rotate the control dial to select **[BLUETOOTH]**, then press it.
- 2 Rotate the control dial to select **[SET BT SIGNL]**, then press it.
Make sure that  lights up.
- 3 Activate the BLUETOOTH function on the BLUETOOTH device.
- 4 Operate the BLUETOOTH device to connect to this unit.
 or  lights up.

Icons in the display:

	Lights up when handsfree calling is available by enabling the HFP (Handsfree Profile).
	Lights up when the audio device is playable by enabling the A2DP (Advanced Audio Distribution Profile).

To connect the last-connected device from this unit

Activate the BLUETOOTH function on the BLUETOOTH device.

To connect with the audio device, press **SRC** to select **[BT AUDIO]** and press  (play/pause).

To connect with the cellular phone, press **CALL**.

Note

While streaming BLUETOOTH audio, you cannot connect from this unit to the cellular phone. Connect from the cellular phone to this unit instead.

Tip

With BLUETOOTH signal on: when the ignition is turned to on, this unit reconnects automatically to the last-connected cellular phone.

To install the microphone

For details, see "Installing the microphone" (page 40).

Connecting with an iPhone/iPod (BLUETOOTH Auto Pairing)

When an iPhone/iPod with iOS5 or later installed is connected to the USB port, the unit is paired and connected with the iPhone/iPod automatically.

To enable BLUETOOTH Auto Pairing, make sure **[SET AUTOPAIR]** in **[BLUETOOTH]** is set to **[ON]** (page 24).

- 1 Activate the BLUETOOTH function on the iPhone/iPod.
- 2 Connect an iPhone/iPod to the USB port.

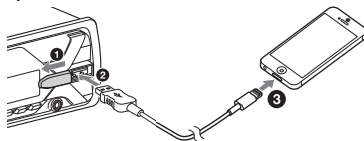

Make sure that  lights up on the display of the unit.

Notes

- BLUETOOTH Auto Pairing is not possible if the unit is already connected to two BLUETOOTH devices. In this case, disconnect either device, then connect the iPhone/iPod again.
- If BLUETOOTH Auto Pairing is not established, see "Preparing a BLUETOOTH Device" (page 8).

Connecting a USB Device

- 1 Turn down the volume on the unit.
- 2 Connect the USB device to the unit.
To connect an iPod/iPhone, use the USB connection cable for iPod (not supplied).

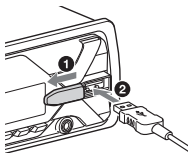

Connecting Other Portable Audio Device

- 1 Turn off the portable audio device.
- 2 Turn down the volume on the unit.
- 3 Connect the portable audio device to the AUX input jack (stereo mini jack) on the unit with a connecting cord (not supplied)*.

* Be sure to use a straight type plug.

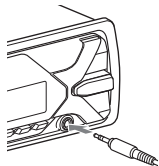

- 4 Press SRC to select [AUX].

To match the volume level of the connected device to other sources

Start playback of the portable audio device at a moderate volume, and set your usual listening volume on the unit.

Press MENU, then select [SOUND] → [SET AUX VOL.] (page 23).

Listening to the Radio

Listening to the Radio

To listen to the radio, press SRC to select [TUNER].

Storing automatically (BTM)

- 1 Press MODE to change the band (FM1, FM2, FM3, AM1 or AM2).
- 2 Press MENU, rotate the control dial to select [GENERAL], then press it.
- 3 Rotate the control dial to select [SET BTM], then press it.
The unit stores stations in order of frequency on the number buttons.

Tuning

- 1 Press MODE to change the band (FM1, FM2, FM3, AM1 or AM2).
- 2 Perform tuning.
To tune manually
Press and hold ◀◀/▶▶ (SEEK -/+) to locate the approximate frequency, then press ◀◀/▶▶ (SEEK -/+) repeatedly to finely adjust to the desired frequency.
To tune automatically
Press ◀◀/▶▶ (SEEK -/+).
Scanning stops when the unit receives a station.

Storing manually

- 1 While receiving the station that you want to store, press and hold a number button (1 to 6) until [MEM] appears.

Receiving the stored stations

- 1 Select the band, then press a number button (1 to 6).

Using Radio Data System (RDS)

Selecting program types (PTY)

- 1 Press PTY during FM reception.
- 2 Rotate the control dial until the desired program type appears, then press it.
The unit starts to search for a station broadcasting the selected program type.

Type of programs

NEWS (News), **INFORM** (Information), **SPORTS** (Sports), **TALK** (Talk), **ROCK** (Rock), **CLS ROCK** (Classic Rock), **ADLT HIT** (Adult Hits), **SOFT RCK** (Soft Rock), **TOP 40** (Top 40), **COUNTRY** (Country), **OLDIES** (Oldies), **SOFT** (Soft), **NOSTALGA** (Nostalgia), **JAZZ** (Jazz), **CLASSICL** (Classical), **R & B** (Rhythm and Blues), **SOFT R&B** (Soft Rhythm and Blues), **LANGUAGE** (Foreign Language), **REL MUSC** (Religious Music), **REL TALK** (Religious Talk), **PERSNLTY** (Personality), **PUBLIC** (Public), **COLLEGE** (College), **HABL ESP** (Spanish Talk), **MUSC ESP** (Spanish Music), **HIP HOP** (Hip-Hop), **WEATHER** (Weather)

Setting clock time (CT)

The CT data from the RDS transmission sets the clock.

- 1 Set [SET CT-ON] in [GENERAL] (page 22).

Listening to the SiriusXM Radio

Activating your SiriusXM Subscription

Only SiriusXM brings you more of what you love to listen to, all in one place. Get over 140 channels, including commercial-free music plus the best sports, news, talk, comedy and entertainment. Welcome to the world of satellite radio. A SiriusXM Connect Vehicle Tuner and Subscription are required. For more information, visit www.siriusxm.com

After installing your SiriusXM Connect Vehicle Tuner and antenna, press SRC to select [SIRIUSXM]. You should be able to hear the SiriusXM preview channel on Channel 1. After verifying that you can hear the preview channel, select Channel 0 to find the Radio ID of your tuner. In addition, the Radio ID is located on the bottom of the SiriusXM Connect Vehicle Tuner and its packaging. You will need this number to activate your subscription. Write the number down for reference.

In the USA, you can activate online or by calling SiriusXM Listener Care:

- Online: Visit www.siriusxm.com/activatenow
- Phone: Call 1-866-635-2349

In Canada, you can activate online or by calling SiriusXM Listener Care:

- Online: Visit www.siriusxm.ca/activatexm
- Phone: Call 1-877-438-9677

As part of the activation process, the SiriusXM satellites will send an activation message to your tuner. When your radio detects that the tuner has received the activation message, your radio will display: [SUBSCRIPTION UPDATED - PRESS ENT TO CONTINUE]. Once subscribed, you can tune to channels in your subscription plan.

Notes

- The activation process usually takes 10 to 15 minutes, but may take up to an hour.
- Your radio will need to be turned on and receiving the SiriusXM signal to receive the activation message.

Selecting channels for SiriusXM

- 1 Press **Q** (browse).
- 2 Rotate the control dial to select [CHANNEL], then press it.
- 3 Rotate the control dial to select the desired channel, then press it.

To select channels from categories

- 1 Press **Q** (browse).
- 2 Rotate the control dial to select [CATEGORY], then press it.
- 3 Rotate the control dial to select the desired category, then press it.
The channel list appears.
- 4 Rotate the control dial to select the desired channel, then press it.

To store channels

- 1 While receiving the channel that you want to store, press and hold a number button (1 to 6) until [MEM] appears.

To receive the stored channel, press **MODE** to select [SX1], [SX2] or [SX3], then press a number button (1 to 6).

To set a parental control

The parental control feature allows you to limit access to SiriusXM channels with mature content. When enabled, the parental control feature requires you to enter a passcode to tune to the locked channels. Information on setting up the passcode and locking channels can be found below.

- 1 Press **MENU** and rotate the control dial.
- 2 Select [GENERAL] → [SXM PARENTAL] → [LOCK SELECT] → [LOCK-ON].
- 3 Enter the passcode by rotating the control dial on the unit or pressing **↑/↓** on the remote commander.
To move the entry position, press **◀◀/▶▶** (SEEK -/+) on the unit or **←/→** on the remote commander.
The initial passcode is [0000].

- 4 After entering the passcode, press **ENTER**.

To unlock the channels, select [LOCK-OFF].

To change the passcode

- 1 Press **MENU** and rotate the control dial.
- 2 Select [GENERAL] → [SXM PARENTAL] → [CODE EDIT].
- 3 Enter the current passcode on the current passcode input display, then press **ENTER**.
The initial passcode is [0000].
- 4 Enter your new 4-digit passcode on the new passcode input display, then press **ENTER**.

To change display items

Press **DSPL** to change as follows:
Channel Number (Default) → Channel Name
→ Artist Name → Song Title → Content Info →
Category Name → Clock

Playback

Playing a USB Device

In these Operating Instructions, “iPod” is used as a general reference for the iPod functions on an iPod and iPhone, unless otherwise specified by the text or illustrations.

For details on the compatibility of your iPod, see “About iPod” (page 26) or visit the support site on the back cover.

AOA (Android Open Accessory) 2.0, MSC (Mass Storage Class) and MTP (Media Transfer Protocol) type USB devices* compliant with the USB standard can be used. Depending on the USB device, the Android mode or MSC/MTP mode can be selected on the unit.

Some digital media players or Android smartphones may require setting to MTP mode.

* e.g., a USB flash drive, digital media player, Android smartphone

Notes

- For details on the compatibility of your USB device, visit the support site on the back cover.
- Smartphones with Android OS 4.1 or higher installed support Android Open Accessory 2.0 (AOA 2.0). However, some smartphones may not fully support AOA 2.0 even if Android OS 4.1 or higher is installed.
For details on the compatibility of your Android smartphone, visit the support site on the back cover.

- Playback of the following files is not supported.
MP3/WMA/FLAC:
 - copyright-protected files
 - DRM (Digital Rights Management) files
 - Multi-channel audio filesMP3/WMA:
 - lossless compression files

Before making a connection, select the USB mode (Android mode or MSC/MTP mode) depending on the USB device (page 22).

1 Connect a USB device to the USB port (page 11).

Playback starts.

If a device is already connected, to start playback, press SRC to select [USB] ([IPD] appears in the display when the iPod is recognized).

2 Adjust the volume on this unit.

To stop playback

Press and hold OFF for 1 second.

To remove the device

Stop playback, then remove the device.

Caution for iPhone

When you connect an iPhone via USB, phone call volume is controlled by the iPhone, not the unit. Do not inadvertently increase the volume on the unit during a call, as a sudden loud sound may result when the call ends.

Playing a BLUETOOTH Device

You can play contents on a connected device that supports BLUETOOTH A2DP (Advanced Audio Distribution Profile).



1 Make BLUETOOTH connection with the audio device (page 8).

To select the audio device, press MENU, then select [BLUETOOTH] → [SET AUDIODEV] (page 24).

2 Press SRC to select [BT AUDIO].

3 Operate the audio device to start playback.

4 Adjust the volume on this unit.

Notes

- Depending on the audio device, information such as title, track number/time and playback status may not be displayed on this unit.
- Even if the source is changed on this unit, playback of the audio device does not stop.
- [BT AUDIO] does not appear in the display while running the "SongPal" application via the BLUETOOTH function.

To match the volume level of the BLUETOOTH device to other sources



Start playback of the BLUETOOTH audio device at a moderate volume, and set your usual listening volume on the unit.

Press MENU, then select [SOUND] → [SET BTA VOL] (page 23).

Searching and Playing Tracks

Repeat play and shuffle play

Not available when a USB device in Android mode is connected.

- 1 During playback, press  (repeat) or  (shuffle) repeatedly to select the desired play mode.

Playback in the selected play mode may take time to start.

Available play modes differ depending on the selected sound source.

Searching a track by name (Quick-BrowZer™)

Not available when a USB device in Android mode or iPod is connected.

- 1 During USB playback, press  (browse)* to display the list of search categories.

When the track list appears, press  (back) repeatedly to display the desired search category.

* During USB playback, press  (browse) for more than 2 seconds to directly return to the beginning of the category list.

- 2 Rotate the control dial to select the desired search category, then press it to confirm.



- 3 Repeat step 2 to search the desired track.
Playback starts.

To exit the Quick-BrowZer mode

Press  (browse).

Searching by skipping items (Jump mode)

Not available when a USB device in Android mode or iPod is connected.

- 1 Press  (browse).
- 2 Press  (SEEK +).
- 3 Rotate the control dial to select the item.
The list is jumped in steps of 10% of the total number of items.
- 4 Press ENTER to return to the Quick-BrowZer mode.
The selected item appears.
- 5 Rotate the control dial to select the desired item, then press it.
Playback starts.

Listening to Pandora®

Pandora® is available to stream music through your iPhone and Android smartphone. You can control Pandora® on a BLUETOOTH connected iPhone/Android smartphone from this unit. Pandora® is only available in certain countries. Please visit <http://www.pandora.com/legal> for more information.

Setting up Pandora®

- 1 Check the compatibility of your mobile device by visiting the support site on the back cover.
- 2 Download the latest version of the Pandora® application from your smartphone's app store. A list of compatible devices can be found at www.pandora.com/everywhere/mobile

Streaming Pandora®

- 1 Make BLUETOOTH connection with the audio device (page 8).
To select the audio device, press MENU, then select [BLUETOOTH] → [SET AUDIODEV] (page 24).
- 2 Press SRC to select [PANDORA].
- 3 Launch Pandora® application on your mobile device.
- 4 Press ►|| (play/pause) to start playback.

If the device number appears

Make sure that the same numbers are displayed (e.g., 123456) in this unit and the mobile device, then press ENTER on this unit and select [Yes] on the mobile device.

When activating the BLUETOOTH function

You can adjust the volume level. Press MENU, then select [SOUND] → [SET BTA VOL] (page 23).

Available Operations in Pandora®

"Thumbs" feedback

"Thumbs Up" or "Thumbs Down" feedback allows you to personalize stations.

- 1 During playback, press ▲ (Thumbs Up) or ▼ (Thumbs Down).

Using the station list

The station list allows you to easily select a desired station.

- 1 During playback, press Q (browse).
- 2 Press ►► (SEEK +) to select the sorting order [BY DATE] or [A TO Z].
- 3 Rotate the control dial to select the desired station, then press it. Playback starts.

Bookmarking

The track currently being played can be bookmarked and stored in your Pandora® account.

- 1 During playback, press MODE.

Handsfree Calling (via BLUETOOTH only)

To use a cellular phone, connect it with this unit. You can connect two cellular phones to the unit. For details, see "Preparing a BLUETOOTH Device" (page 8).



Receiving a Call

- 1 Press **CALL** when a call is received with a ringtone.
The phone call starts.

Note

The ringtone and talker's voice are output only from the front speakers.

To reject the call

Press and hold **OFF** for 1 second.

To end the call

Press **CALL** again.

Making a Call

You can make a call from the phonebook or call history when a cellular phone supporting PBAP (Phone Book Access Profile) is connected.

When two cellular phones are connected to the unit, select either phone.

From the phonebook

- 1 Press **CALL**.
When two cellular phones are connected to the unit, rotate the control dial to select either phone, then press it.
- 2 Rotate the control dial to select [**PHONE BOOK**], then press it.

- 3 Rotate the control dial to select an initial from the initial list, then press it.
- 4 Rotate the control dial to select a name from the name list, then press it.
- 5 Rotate the control dial to select a number from the number list, then press it.
The phone call starts.

From the call history

- 1 Press **CALL**.
When two cellular phones are connected to the unit, rotate the control dial to select either phone, then press it.
- 2 Rotate the control dial to select [**RECENT CALL**], then press it.
A list of the call history appears.
- 3 Rotate the control dial to select a name or phone number from the call history, then press it.
The phone call starts.

By phone number input

- 1 Press **CALL**.
When two cellular phones are connected to the unit, rotate the control dial to select either phone, then press it.
- 2 Rotate the control dial to select [**DIAL NUMBER**], then press it.
- 3 Rotate the control dial to enter the phone number, and lastly select [] (space), then press **ENTER***.
The phone call starts.

* To move the digital indication, press **◀▶** (SEEK -/+).

Note

[.] appears instead of [#] on the display.

By redial

- 1 Press **CALL**.
When two cellular phones are connected to the unit, rotate the control dial to select either phone, then press it.

- 2 Rotate the control dial to select [REDIAL], then press it.

The phone call starts.

By voice tags

You can make a call by saying the voice tag stored in a connected cellular phone that has a voice dialing function.

- 1 Press CALL.

When two cellular phones are connected to the unit, rotate the control dial to select either phone, then press it.

- 2 Rotate the control dial to select [VOICE DIAL], then press it.

Alternatively, press and hold VOICE for more than 2 seconds.

- 3 Say the voice tag stored on the cellular phone.

Your voice is recognized, and the call is made.

To cancel voice dialing

Press VOICE.

To switch between handsfree mode and handheld mode

During a call, press MODE to switch the phone call audio between the unit and cellular phone.

Note

Depending on the cellular phone, this operation may not be available.

Available Operations during Call

To adjust the ringtone volume

Rotate the control dial while receiving a call.

To adjust the talker's voice volume

Rotate the control dial during a call.

To adjust the volume for the other party (Mic gain adjustment)

Press MIC.

Adjustable volume levels: [MIC-LOW], [MIC-MID], [MIC-HI].

To reduce echo and noise (Echo Canceled/Noise Canceled Mode)

Press and hold MIC.

Settable mode: [EC/NC-1], [EC/NC-2].

Useful Functions

Sony | Music Center with iPhone/Android smartphone

Downloading the latest version of “Sony | Music Center” application is required from the App Store for iPhone or from Google Play for Android smartphone.

Notes

- For your safety, follow your local traffic laws and regulations, and do not operate the application while driving.
- “Sony | Music Center” is an app for controlling Sony audio devices which are compatible with “Sony | Music Center”, by your iPhone/Android smartphone.
- What you can control with “Sony | Music Center” varies depending on the connected device.
- To make use of “Sony | Music Center” features, see the details on your iPhone/Android smartphone.
- For further details on “Sony | Music Center,” visit the following URL: <http://www.sony.net/smcqa/>
- Visit the website below and check the compatible iPhone/Android smartphone models.
For iPhone: visit the App Store
For Android smartphone: visit Google Play

Establishing the Sony | Music Center connection

- 1** Make the BLUETOOTH connection with iPhone/Android smartphone (page 8). To select the audio device, press MENU, then select [BLUETOOTH] → [AUDIO DEV] (page 24).
- 2** Launch the “Sony | Music Center” application.
- 3** Press MENU, rotate the control dial to select [SONY APP], then press it.
- 4** Rotate the control dial to select [CONNECT], then press it.
Connection to iPhone/Android smartphone starts.
For details on the operations on iPhone/Android smartphone, see the help of the application.

If the device number appears

Make sure that the number is displayed (e.g., 123456), then select [Yes] on the iPhone/Android smartphone.

To terminate connection

- 1** Press MENU, rotate the control dial to select [SONY APP], then press it.
- 2** Rotate the control dial to select [CONNECT], then press it.

Selecting the source or application

You can operate to select the desired source or application on iPhone/Android smartphone.

To select the source

Press SRC repeatedly. Alternatively, press SRC, rotate the control dial to select the desired source, then press ENTER.

To display the source list

Press SRC.

Announcement of various information by voice guide (Android smartphone only)

When SMS, Twitter/Facebook/Calendar notifications, etc., are received, they are automatically announced through the car speakers.

For details on settings, refer to the help of the application.

Activating voice recognition (Android smartphone only)

By registering applications, you can control an application by voice command. For details, refer to the help of the application.

To activate voice recognition

- 1** Press and hold VOICE to activate voice recognition.
- 2** Say the desired voice command into the microphone when [Say Source or App] appears on the Android smartphone.

Notes

- Voice recognition may not be available in some cases.
- Voice recognition may not work properly depending on the performance of the connected Android smartphone.
- Operate under conditions where noise such as engine sound is minimized during voice recognition.

Replying a message of SMS (Android smartphone only)

You can reply a message by voice recognition.

- 1 Activate voice recognition, then input "Reply."**
The message input display appears on the "Sony | Music Center" application.
- 2 Input a reply message by voice recognition.**
The list of message candidates appears on the "Sony | Music Center" application.
- 3 Rotate the control dial to select the desired message, then press it.**
The message is sent out.

Making sound and display settings

You can adjust the settings relating to sound and display via iPhone/Android smartphone.

For details on settings, refer to the help of the application.

Using Siri Eyes Free

Siri Eyes Free allows you to use an iPhone handsfree by simply speaking into the microphone. This function requires you to connect an iPhone to the unit via BLUETOOTH. Availability is limited to iPhone 4s or later. Make sure that your iPhone is running the latest iOS version.

You must complete BLUETOOTH registration and connection configurations for the iPhone with the unit in advance. For details, see "Preparing a BLUETOOTH Device" (page 7). To select the iPhone, press MENU, then select [BLUETOOTH] → [SET AUDIODEV] (page 21).

- 1 Activate the Siri function on the iPhone.**
For details, refer to the operating instructions supplied with the iPhone.
- 2 Press and hold VOICE for more than 2 seconds.**
The voice command display appears.
- 3 After the iPhone beeps, speak into the microphone.**
The iPhone beeps again, then Siri starts responding.

To deactivate Siri Eyes Free

Press VOICE.

Notes

- The iPhone may not recognize your voice depending on usage conditions. (For example, if you are in a moving car.)
- Siri Eyes Free may not function properly, or the response time may lag in locations where iPhone signals are difficult to receive.
- Depending on the iPhone's operating condition, Siri Eyes Free may not function properly, or may quit.
- If you play a track with an iPhone using the BLUETOOTH audio connection, when the track starts playback via BLUETOOTH, Siri Eyes Free automatically quits and the unit switches to the BLUETOOTH audio source.
- When Siri Eyes Free is activated during audio playback, the unit may switch to the BLUETOOTH audio source even if you do not specify a track to play.
- When connecting the iPhone to the USB port, Siri Eyes Free may not function properly, or may quit.
- When connecting the iPhone to the unit via USB, do not activate Siri with the iPhone. Siri Eyes Free may not function properly, or may quit.
- There is no audio sound while Siri Eyes Free is activated.

Canceling the DEMO Mode

You can cancel the demonstration display which appears when the source is off and the clock is displayed.

- 1** Press MENU, rotate the control dial to select [GENERAL], then press it.
- 2** Rotate the control dial to select [SET DEMO], then press it.
- 3** Rotate the control dial to select [SET DEMO-OFF], then press it.
The setting is complete.
- 4** Press ↵ (back) twice.
The display returns to normal reception/play mode.

Basic Setting Operation

You can set items in the following setup categories:

General setup (GENERAL), Sound setup (SOUND), Display setup (DISPLAY), BLUETOOTH setup (BLUETOOTH), Sony | Music Center Setup (SONY APP).

- 1** Press MENU.
- 2** Rotate the control dial to select the setup category, then press it.
The items that can be set differ depending on the source and settings.
- 3** Rotate the control dial to select the options, then press it.

To return to the previous display

Press ↵ (back).

General Setup (GENERAL)

DEMO (demonstration)

Activates the demonstration: [ON], [OFF].

CLOCK-ADJ (clock adjust) (page 8)

CAUT ALM (caution alarm)

Activates the caution alarm: [ON], [OFF] (page 8).

(Available only while the source is off and the clock is displayed.)

BEEP

Activates the beep sound: [ON], [OFF].

AUTO OFF

Shuts off automatically after a desired time when the unit is turned off: [ON] (30 minutes), [OFF].

STEERING

Registers/resets the setting of the steering wheel remote control. (Available when connected with the connection cable (not supplied).) (Available only while the source is off and the clock is displayed.)

STR CONTROL (steering control)

Selects the input mode of the connected remote control. To prevent a malfunction, be sure to match the input mode with the connected remote control before use.

CUSTOM

Input mode for the steering wheel remote control

PRESET

Input mode for the wired remote control excluding the steering wheel remote control (automatically selected when [RESET CUSTOM] is performed.)

EDIT CUSTOM

Registers the functions (SOURCE, ATT, VOL +/-, SEEK +/-, VOICE, ON HOOK, OFF HOOK) to the steering wheel remote control:

- 1 Rotate the control dial to select the function you want to assign to the steering wheel remote control, then press it.
- 2 While [REGISTER] is blinking, press and hold the button on the steering wheel remote control you want to assign the

function to. When registration is complete, [REGISTERED] is displayed.

- 3 To register other functions, repeat steps 1 and 2.

(Available only when [STR CONTROL] is set to [CUSTOM].)

RESET CUSTOM

Resets the setting of the steering wheel remote control: [YES], [NO].

(Available only when [STR CONTROL] is set to [CUSTOM].)

Notes

- While making settings, only button operation on the unit is available. For safety, park your car before making this setting.
 - If an error occurs while registering, all the previously-registered information remains. Restart registration from the function where the error occurred.
 - This function may not be available on some vehicles. For details on the compatibility of your vehicle, visit the support site on the back cover.
-

USB MODE

Changes the USB mode: [ANDROID], [MSC/MTP].

(Available only when the USB source is selected.)

CT (clock time)

Activates the CT function: [ON], [OFF].

BTM (best tuning memory) (page 11)

(Available only when the tuner is selected.)

SXM PARENTAL

Sets the parental lock to [ON], [OFF], and edits the passcode (page 13).

(Available only when SiriusXM is selected.)

SXM RESET

Initializes the SiriusXM Connect Vehicle Tuner settings (preset channels/parental lock): [YES], [NO].

(Available only when SiriusXM is selected.)

FIRMWARE

(Available only while the source is off and the clock is displayed.)

Checks/updates the firmware version. For details, visit the support site on the back cover.

FW VERSION (firmware version)

Displays current firmware version.

FW UPDATE (firmware update)

Enters firmware update process: [YES], [NO].

Updating the firmware takes a few minutes to complete. During the update, do not turn the ignition to the OFF position, nor remove the USB device.

Sound Setup (SOUND)

This setup menu is not available when the source is off and the clock is displayed.

EQ10 PRESET

Selects an equalizer curve from 10 equalizer curves or off:

[OFF], [R&B], [ROCK], [POP], [HIP-HOP], [EDM], [JAZZ], [SOUL], [COUNTRY], [KARAOKE]*, [CUSTOM].

The equalizer curve setting can be memorized for each source.

* [KARAOKE] reduces the vocal sound but cannot fully remove it during playback. Also, using a microphone is not supported.

EQ10 CUSTOM

Sets [CUSTOM] of EQ10.

Selects the equalizer curve: [BAND1] 32 Hz, [BAND2] 63 Hz, [BAND3] 125 Hz, [BAND4] 250 Hz, [BAND5] 500 Hz, [BAND6] 1 kHz, [BAND7] 2 kHz, [BAND8] 4 kHz, [BAND9] 8 kHz, [BAND10] 16 kHz.

The volume level is adjustable in 1 dB steps, from -6 dB to +6 dB.

BALANCE

Adjusts the sound balance: [RIGHT-15] – [CENTER] – [LEFT-15].

FADER

Adjusts the relative level: [FRONT-15] – [CENTER] – [REAR-15].

S.WOOFER (subwoofer)

SW LEVEL (subwoofer level)

Adjusts the subwoofer volume level:

[+6 dB] – [0 dB] – [-6 dB].

([ATT] is displayed at the lowest setting.)

SW PHASE (subwoofer phase)

Selects the subwoofer phase: [NORM], [REV].

LPF FREQ (low pass filter frequency)

Selects the subwoofer cut-off frequency: [80Hz], [100Hz], [120Hz].

HPF FREQ (high pass filter frequency)

Selects the front/rear speaker cut-off frequency: [OFF], [80Hz], [100Hz], [120Hz].

AUX VOL (AUX volume level)

Adjusts the volume level for each connected auxiliary device: [+18 dB] – [0 dB] – [-8 dB].

This setting negates the need to adjust the volume level between sources.

(Available only when the AUX is selected.)

BTA VOL (BLUETOOTH audio volume level)

Adjusts the volume level for each connected BLUETOOTH device: [+6 dB] – [0 dB] – [-6 dB].

This setting negates the need to adjust the volume level between sources.

(Available only when the BT audio, application or Pandora® is selected.)

Display Setup (DISPLAY)

DIMMER

Changes the display brightness: [ON], [OFF], [CLK] (clock).

To set this function to be active only during a fixed period, select [CLK], then set the start and end times.

- To set the brightness when the dimmer function is activated:
Set [DIMMER] to [ON], then adjust [BRIGHTNESS].
- To set the brightness when the dimmer function is deactivated:
Set [DIMMER] to [OFF], then adjust [BRIGHTNESS].

The brightness setting is stored and applied when the dimmer function is activated or deactivated.

BRIGHTNESS

Adjusts the display brightness. The brightness level is adjustable: [1] – [10].

SND SYNC (sound synchronization)

Activates the synchronization of the illumination with the sound: [ON], [OFF].

AUTO SCR (auto scroll)

Scrolls long items automatically: [ON], [OFF].

(Not available when the AUX or tuner is selected.)

BLUETOOTH Setup (BLUETOOTH)

PAIRING (page 9)

Connects up to two BLUETOOTH devices: [DEVICE 1], [DEVICE 2].
[DEVICE 1] or [DEVICE 2] will be changed to the paired device name after pairing is complete.

AUDIODEV (audio device)

Selects the audio device.
[*] appears on the device paired with [DEVICE 1] or the current A2DP compatible audio device.

RINGTONE

Selects whether this unit or the connected cellular phone outputs the ringtone: [1] (this unit), [2] (cellular phone).

AUTO ANS (auto answer)

Sets this unit to answer an incoming call automatically: [OFF], [1] (about 3 seconds), [2] (about 10 seconds).

AUTOPAIR (auto pairing)

Starts BLUETOOTH pairing automatically when iOS device version 5.0 or later is connected via USB: [ON], [OFF].

BT SIGNAL (BLUETOOTH signal) (page 10)

Activates/deactivates the BLUETOOTH function.

BT INIT (BLUETOOTH initialize)

Initializes all the BLUETOOTH related settings (pairing information, preset number, device information, etc.): [YES], [NO].

When disposing the unit, initialize all the settings.

(Available only while the source is off and the clock is displayed.)

Sony | Music Center Setup (SONY APP)

AUTO LAUNCH (auto launch)

Activates the "Sony | Music Center" auto launch: [ON], [OFF].

When [ON] is selected, "Sony | Music Center" will automatically connect after the BLUETOOTH connection is complete.

CONNECT (connect) (page 19)

Establish and terminate "Sony | Music Center" function (connection).

Additional Information

Updating the Firmware

To update the firmware, visit the support site on the back cover, then follow the online instructions.

Notes

- Using a USB device (not supplied) is required for updating the firmware. Store the updater in the USB device, and connect the device to the USB port, then perform the update operation.
- Updating the firmware takes a few minutes to complete. During the update, do not turn the ignition to the OFF position, nor remove the USB device.

Precautions

- Cool off the unit beforehand if your car has been parked in direct sunlight.
- Do not leave the front panel or audio devices brought in inside the car, or it may cause malfunction due to high temperature in direct sunlight.
- Power antenna (aerial) extends automatically.

Moisture condensation

Should moisture condensation occur inside the unit, remove the disc and wait for about an hour for it to dry out; otherwise the unit will not operate properly.

To maintain high sound quality

Do not splash liquid onto the unit or discs.

Playback order of audio files

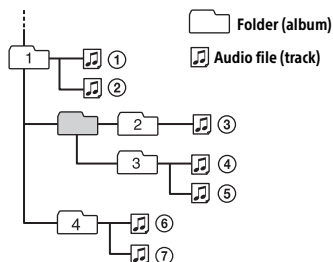

About iPod

- You can connect to the following iPod models. Update your iPod devices to the latest software before use.

Compatible iPhone/iPod models

Compatible Model	Bluetooth®	USB
iPhone SE	✓	✓
iPhone 6s Plus	✓	✓
iPhone 6s	✓	✓
iPhone 6 Plus	✓	✓
iPhone 6	✓	✓
iPhone 5s	✓	✓
iPhone 5c	✓	✓
iPhone 5	✓	✓
iPhone 4s	✓	✓
iPod touch (6th generation)	✓	✓
iPod touch (5th generation)	✓	✓
iPod nano (7th generation)		✓

- “Made for iPod,” and “Made for iPhone,” mean that an electronic accessory has been designed to connect specifically to iPod or iPhone, respectively, and has been certified by the developer to meet Apple performance standards. Apple is not responsible for the operation of this device or its compliance with safety and regulatory standards. Please note that the use of this accessory with iPod or iPhone may affect wireless performance.

If you have any questions or problems concerning your unit that are not covered in this manual, consult your nearest Sony dealer.

Maintenance

Replacing the lithium battery of the remote commander

Under normal conditions, the battery will last approximately 1 year. (The service life may be shorter, depending on the conditions of use.)

When the battery becomes weak, the range of the remote commander becomes shorter.

CAUTION

Danger of explosion if battery is incorrectly replaced. Replaced only with the same or equivalent type.

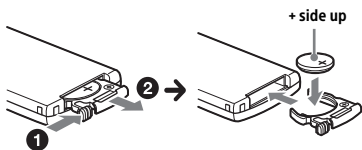

Notes on the lithium battery

- Keep the lithium battery out of the reach of children. Should the battery be swallowed, immediately consult a doctor.
- Wipe the battery with a dry cloth to ensure a good contact.
- Be sure to observe the correct polarity when installing the battery.
- Do not hold the battery with metallic tweezers, otherwise a short-circuit may occur.

Cleaning the connectors

The unit may not function properly if the connectors between the unit and the front panel are not clean. In order to prevent this, detach the front panel (page 8) and clean the connectors with a cotton swab. Do not apply too much force. Otherwise, the connectors may be damaged.

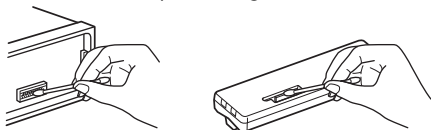

Notes

- For safety, turn off the ignition before cleaning the connectors, and remove the key from the ignition switch.
- Never touch the connectors directly with your fingers or with any metal device.

Specifications

FOR THE CUSTOMERS IN THE USA. NOT APPLICABLE IN CANADA, INCLUDING IN THE PROVINCE OF QUEBEC.

POUR LES CLIENTS AUX ÉTATS-UNIS. NON APPLICABLE AU CANADA, Y COMPRIS LA PROVINCE DE QUÉBEC.

AUDIO POWER SPECIFICATIONS



CTA2006 Standard
Power Output: 20 Watts RMS \times 4
at 4 Ohms $<$ 1% THD+N
SN Ratio: 80 dBA
(reference: 1 Watt into 4 Ohms)

Tuner section

FM

Tuning range: 87.5 MHz – 107.9 MHz

Antenna (aerial) terminal:

External antenna (aerial) connector

Intermediate frequency:

FM CCIR: -1,956.5 kHz to -487.3 kHz and
+500.0 kHz to +2,095.4 kHz

Usable sensitivity: 8 dBf

Selectivity: 75 dB at 400 kHz

Signal-to-noise ratio: 73 dB

Separation: 50 dB at 1 kHz

Frequency response: 20 Hz – 15,000 Hz

AM

Tuning range: 530 kHz – 1,710 kHz

Antenna (aerial) terminal:

External antenna (aerial) connector

Sensitivity: 26 μ V

USB Player section

Interface: USB (Full-speed)

Maximum current: 1 A

The maximum number of recognizable tracks:

– folders (albums): 256

– files (tracks) per folder: 256

Compatible Android Open Accessory protocol (AOA): 2.0

Corresponding codec:

MP3 (.mp3)

Bit rate: 8 kbps – 320 kbps (Supports VBR (Variable Bit Rate))

Sampling rate: 16 kHz – 48 kHz

WMA (.wma)

Bit rate: 32 kbps – 192 kbps (Supports VBR (Variable Bit Rate))

Sampling rate: 32 kHz, 44.1 kHz, 48 kHz

FLAC (.flac)

Bit depth: 16 bit, 24 bit

Sampling rate: 44.1 kHz, 48 kHz

Wireless Communication

Communication System:

BLUETOOTH Standard version 3.0

Output:

BLUETOOTH Standard Power Class 2 (Max. +4 dBm)

Maximum communication range:

Line of sight approx. 10 m (33 ft)*1

Frequency band:

2.4 GHz band

(2.4000 GHz – 2.4835 GHz)

Modulation method: FHSS

Compatible BLUETOOTH Profiles*2:

A2DP (Advanced Audio Distribution Profile) 1.3

AVRCP (Audio Video Remote Control Profile) 1.3

HFP (Handsfree Profile) 1.6

PBAP (Phone Book Access Profile)

SPP (Serial Port Profile)

Corresponding codec:

SBC (.sbc), ACC (.m4a)

*1 The actual range will vary depending on factors such as obstacles between devices, magnetic fields around a microwave oven, static electricity, reception sensitivity, antenna (aerial)'s performance, operating system, software application, etc.

*2 BLUETOOTH standard profiles indicate the purpose of BLUETOOTH communication between devices.

Power amplifier section

Output: Speaker outputs

Speaker impedance: 4 Ω – 8 Ω

Maximum power output: 55 W × 4 (at 4 Ω)

General

Outputs:

Audio outputs terminal: REAR, SUB

Power antenna (aerial)/Power amplifier control terminal (REM OUT)

Inputs:

SiriusXM input terminal

Remote controller input terminal

Antenna (aerial) input terminal

AUX input jack (stereo mini jack)

USB port

Power requirements: 12 V DC car battery (negative ground (earth))

Rated current consumption: 10 A

Dimensions:

Approx. 178 mm × 50 mm × 119 mm (7 1/8 in × 2 in × 4 3/4 in) (w/h/d)

Mounting dimensions:

Approx. 182 mm × 53 mm × 102 mm (7 1/4 in × 2 1/8 in × 4 1/8 in) (w/h/d)

Mass: Approx. 0.7 kg (1 lb 9 oz)

Package contents:

Main unit (1)

Remote commander (1): RM-X231

Parts for installation and connections

(1 set)

Optional accessories/equipment:

SiriusXM Connect Vehicle Tuner: SXV100, SXV200, SXV300

Cable for steering wheel remote input: RC-SR1

Your dealer may not handle some of the above listed accessories. Please ask the dealer for detailed information.

Design and specifications are subject to change without notice.

Copyrights



SiriusXM Connect Vehicle Tuner and Subscription sold separately.

www.siriusxm.com

Sirius, XM and all related marks and logos are trademarks of Sirius XM Radio Inc. All rights reserved.

The Bluetooth® word mark and logos are registered trademarks owned by Bluetooth SIG, Inc. and any use of such marks by Sony Corporation is under license. Other trademarks and trade names are those of their respective owners.

The N-Mark is a trademark or registered trademark of NFC Forum, Inc. in the United States and in other countries.

Windows Media is either a registered trademark or trademark of Microsoft Corporation in the United States and/or other countries.

This product is protected by certain intellectual property rights of Microsoft Corporation. Use or distribution of such technology outside of this product is prohibited without a license from Microsoft or an authorized Microsoft subsidiary.

iPhone, iPod, iPod classic, iPod nano, iPod touch, and Siri are trademarks of Apple Inc., registered in the U.S. and other countries. App Store is a service mark of Apple Inc.

MPEG Layer-3 audio coding technology and patents licensed from Fraunhofer IIS and Thomson.

Pandora®, the Pandora® logo, and the Pandora® trade dress are trademarks or registered trademarks of Pandora Media, Inc., used with permission.

Google, Google Play and Android are trademarks of Google Inc.

libFLAC

Copyright (C) 2000-2009 Josh Coalson
Copyright (C) 2011-2013 Xiph.Org Foundation

Redistribution and use in source and binary forms, with or without modification, are permitted provided that the following conditions are met:

- Redistributions of source code must retain the above copyright notice, this list of conditions and the following disclaimer.
- Redistributions in binary form must reproduce the above copyright notice, this list of conditions and the following disclaimer in the documentation and/or other materials provided with the distribution.
- Neither the name of the Xiph.org Foundation nor the names of its contributors may be used to endorse or promote products derived from this software without specific prior written permission.

THIS SOFTWARE IS PROVIDED BY THE COPYRIGHT HOLDERS AND CONTRIBUTORS "AS IS" AND ANY EXPRESS OR IMPLIED WARRANTIES, INCLUDING, BUT NOT LIMITED TO, THE IMPLIED WARRANTIES OF MERCHANTABILITY AND FITNESS FOR A PARTICULAR PURPOSE ARE DISCLAIMED. IN NO EVENT SHALL THE FOUNDATION OR CONTRIBUTORS BE LIABLE FOR ANY DIRECT, INDIRECT, INCIDENTAL, SPECIAL, EXEMPLARY, OR CONSEQUENTIAL DAMAGES (INCLUDING, BUT NOT LIMITED TO, PROCUREMENT OF SUBSTITUTE GOODS OR SERVICES; LOSS OF USE, DATA, OR PROFITS; OR BUSINESS INTERRUPTION) HOWEVER CAUSED AND ON ANY THEORY OF LIABILITY, WHETHER IN CONTRACT, STRICT LIABILITY, OR TORT (INCLUDING NEGLIGENCE OR OTHERWISE) ARISING IN ANY WAY OUT OF THE USE OF THIS SOFTWARE, EVEN IF ADVISED OF THE POSSIBILITY OF SUCH DAMAGE.

Troubleshooting

The following checklist will help you remedy problems you may encounter with your unit. Before going through the checklist below, check the connection and operating procedures.

For details on using the fuse and removing the unit from the dashboard, see

"Connection/Installation" (page 37).

If the problem is not solved, visit the support site on the back cover.

General

No power is being supplied to the unit.

- If the unit is turned off and the display disappears, the unit cannot be operated with the remote commander.
 - Turn on the unit.

No sound or the sound is very low.

- The position of the fader control [FADER] is not set for a 2-speaker system.
- The volume of the unit and/or connected device is very low.
 - Increase the volume of the unit and connected device.

No beep sound.

- An optional power amplifier is connected and you are not using the built-in amplifier.

The contents of the memory have been erased.

- The power supply lead or battery has been disconnected or not connected properly.

Stored stations and correct time are erased.

The fuse has blown.

Makes a noise when the position of the ignition is switched.

- The leads are not matched correctly with the car's accessory power connector.

During playback or reception, the demonstration mode starts.

- If no operation is performed for 5 minutes with [DEMO-ON] set, the demonstration mode starts.
 - Set [DEMO-OFF] (page 22).

The display disappears from/does not appear in the display window.

- The dimmer is set to [DIM-ON] (page 24).
- The display disappears if you press and hold OFF.
 - Press OFF on the unit until the display appears.
- The connectors are dirty (page 27).

The display/illumination flashes.

- The power supply is not sufficient.
 - Check that the car battery supplies enough power to the unit. (The power requirement is 12 V DC.)

The operation buttons do not function.

The disc will not eject.

- Press DSPL and  (back)/MODE for more than 2 seconds to reset the unit. The contents stored in memory are erased.

For your safety, do not reset the unit while you are driving.

Radio reception

Stations cannot be received.

The sound is hampered by noises.

- The connection is not correct.
 - If your car has built-in radio antenna (aerial) in the rear/side glass, connect an REM OUT lead (blue/white striped) or accessory power supply lead (red) to the power supply lead of a car's antenna (aerial) booster.
 - Check the connection of the car antenna (aerial).
 - If the auto antenna (aerial) will not extend, check the connection of the power antenna (aerial) control lead.

Preset tuning is not possible.

- The broadcast signal is too weak.

RDS

PTY displays [- - - - -].

- The current station is not an RDS station.
- RDS data has not been received.
- The station does not specify the program type.

USB device playback

You cannot play items via a USB hub.

- This unit cannot recognize USB devices via a USB hub.

A USB device takes longer to play.

- The USB device contains files with a complicated tree structure.

The sound is intermittent.

- The sound may be intermittent at a high-bit-rate.
- DRM (Digital Rights Management) files may not be playable in some cases.

The audio file cannot be played.

- USB devices formatted with file systems other than FAT16 or FAT32 are unsupported.*

* This unit supports FAT16 and FAT32, but some USB device may not support all of these FAT. For details, refer to the operating instruction of each USB device or contact the manufacturer.

Operations for skipping an album, skipping items (Jump mode), and searching a track by name (Quick-BrowZer) cannot be performed.

- These operations cannot be performed when a USB device in Android mode or iPod is connected.
 - Set [USB MODE] to [MSC/MTP] (page 22).
 - Remove the iPod.
- The USB mode of the device is not set to the appropriate mode.
 - Make sure that the USB mode of the device is set to MSC/MTP mode.

The sound cannot be output during playback in Android mode.

- While the unit is in Android mode, the sound outputs only from the Android smartphone.
 - Check the status of the audio playback application on the Android smartphone.
 - Playback may not perform properly depending on the Android smartphone.

NFC function

One touch connection (NFC) is not possible.

- If the smartphone does not respond to the touching.
 - Check that the NFC function of the smartphone is turned on.
 - Move the N-Mark part of the smartphone closer to the N-Mark part on this unit.
 - If the smartphone is in a case, remove it.
- NFC receiving sensitivity depends on the device.
If One touch connection with the smartphone fails several times, make BLUETOOTH connection manually.

BLUETOOTH function

The connecting device cannot detect this unit.

- Before the pairing is made, set this unit to pairing standby mode.

- While connected to two BLUETOOTH devices, this unit cannot be detected from another device.
 - Disconnect either connection and search for this unit from another device.
- When the device pairing is made, set the BLUETOOTH signal output to on (page 10).

Connection is not possible.

- The connection is controlled from one side (this unit or BLUETOOTH device), but not both.
 - Connect to this unit from a BLUETOOTH device or vice versa.

The name of the detected device does not appear.

- Depending on the status of the other device, it may not be possible to obtain the name.

No ringtone.

- Adjust the volume by rotating the control dial while receiving a call.
- Depending on the connecting device, the ringtone may not be sent properly.
 - Set [RINGTONE] to [1] (page 24).
- The front speakers are not connected to the unit.
 - Connect the front speakers to the unit. The ringtone is output only from the front speakers.

The talker's voice cannot be heard.

- The front speakers are not connected to the unit.
 - Connect the front speakers to the unit. The talker's voice is output only from the front speakers.

A call partner says that the volume is too low or high.

- Adjust the volume accordingly using Mic gain adjustment (page 18).

Echo or noise occurs in phone call conversations.

- Lower the volume.
- Set EC/NC Mode to [EC/NC-1] or [EC/NC-2] (page 18).
- If the ambient noise other than the phone call sound is loud, try reducing this noise. E.g.: If a window is open and road noise, etc., is loud, shut the window. If an air

conditioner is loud, lower the air conditioner.

The phone is not connected.

- When BLUETOOTH audio is played, the phone is not connected even if you press CALL.
 - Connect from the phone.

The phone sound quality is poor.

- Phone sound quality depends on reception conditions of cellular phone.
 - Move your car to a place where you can enhance the cellular phone's signal if the reception is poor.

The volume of the connected audio device is low (high).

- Volume level will differ depending on the audio device.
 - Adjust the volume of the connected audio device or this unit (page 23).

The sound skips during playback of a BLUETOOTH audio device.

- Reduce the distance between the unit and the BLUETOOTH audio device.
- If the BLUETOOTH audio device is stored in a case which interrupts the signal, remove the audio device from the case during use.
- Several BLUETOOTH devices or other devices which emit radio waves are in use nearby.
 - Turn off the other devices.
 - Increase the distance from the other devices.
- The playback sound stops momentarily when the connection between this unit and the cellular phone is being made. This is not a malfunction.

The connected BLUETOOTH audio device cannot be controlled.

- Check that the connected BLUETOOTH audio device supports AVRCP.

Some functions do not work.

- Check if the connecting device supports the functions in question.

A call is answered unintentionally.

- The connecting phone is set to answer a call automatically.

Pairing failed due to a timeout.

- Depending on the connecting device, the time limit for pairing may be short.
 - Try completing the pairing within the time.

BLUETOOTH function cannot operate.

- Turn off the unit by pressing OFF for more than 2 seconds, then turn the unit on again.

No sound is output from the car speakers during handsfree call.

- If the sound is output from the cellular phone, set the cellular phone to output the sound from the car speakers.

Siri Eyes Free is not activated.

- Perform the handsfree registration for an iPhone that supports Siri Eyes Free.
- Set the Siri function on the iPhone to on.
- Cancel the BLUETOOTH connection with the iPhone and the unit, and reconnect.

Sony | Music Center operation

Application name is mismatched with the actual application in “Sony | Music Center”.

- Launch the application again from the “Sony | Music Center” application.

While running the “Sony | Music Center” application via BLUETOOTH, the display automatically switches to [BT AUDIO].

- The “Sony | Music Center” application or BLUETOOTH function has failed.
- Run the application again.

The “Sony | Music Center” application is automatically disconnected when the display switches to [IPOD].

- The “Sony | Music Center” application on iPhone/iPod does not support iPod playback.
 - Change the source of the unit to other than [IPOD], then establish the “Sony | Music Center” connection (page 19).

The “Sony | Music Center” connection is automatically disconnected when the USB mode of the unit is changed to [ANDROID].

- The Android smartphone is not supporting playback in Android mode.
 - Set the USB mode of the unit to [MSC/MTP], then establish the “Sony | Music Center” connection (page 19).

Pandora® operation

Pandora® connection is not possible.

- Shut down the Pandora® application on the mobile device, and then launch it again.

Messages

The following messages may appear or flash during operation.

HUB NO SUPRT: USB hubs are not supported.

INVALID

- The selected operation could be invalid.
- [USB MODE] cannot be changed during iPod playback.

IPD STOP: iPod playback has finished.

- Operate your iPod/iPhone to start playback.

NOT SUPPORT - ANDROID MODE

- A USB device not supporting AOA (Android Open Accessory) 2.0 is connected to the unit while [USB MODE] is set to [ANDROID].
 - Set [USB MODE] to [MSC/MTP] (page 22).

OVERLOAD: The USB device is overloaded.

- Disconnect the USB device, then press SRC to select another source.
- The USB device has a fault, or an unsupported device is connected.

READ: Now reading information.

- Wait until reading is complete and playback starts automatically. This may take some time depending on the file organization.

USB ERROR: The USB device cannot be played.

- Connect the USB device again.

USB NO DEV: A USB device is not connected or recognized.

- Make sure the USB device or USB cable is securely connected.

USB NO MUSIC: There is no playable file.

- Connect a USB device containing playable files (page 28).

USB NO SUPRT: The USB device is not supported.

- For details on the compatibility of your USB device, visit the support site on the back cover.

LLLL or ךךךך: The beginning or the end of the disc has been reached.

_ (underscore): The character cannot be displayed.

For BLUETOOTH function:

BTA NO DEV: The BLUETOOTH device is not connected or recognized.

- Make sure the BLUETOOTH device is securely connected, or the BLUETOOTH connection is established with the BLUETOOTH device.

ERROR: The selected operation could not be performed.

- Wait for a while, then try again.

UNKNOWN: A name or phone number cannot be displayed.

WITHHELD: The phone number is hidden by the caller.

For Sony | Music Center operation:

APP -----: A connection with the application is not established.

- Make the "Sony | Music Center" connection again (page 16).

APP DISPLAY: A screen setting display of the application is open.

- Exit the screen setting display of the application to enable button operation.

APP LIST: The contents list of the CD/USB is open.

- Exit the list of the application to enable button operation.

APP MENU: A setting display of the application is open.

- Exit the setting display of the application to enable button operation.

For Pandora® operation:

BOOKMARK - ERROR: Bookmarking failed.

- Wait for a while, then try again.

CANNOT SKIP: Skipping tracks is not allowed.

- Wait until the commercial ends, next track begins, or select another station on the list. Pandora® limits the number of skips allowed on their service.

LICENSING - RESTRICTIONS: Pandora® is not available outside your country.

MAINTENANCE - PLEASE - TRY AGAIN - LATER: The Pandora® server is under maintenance.

- Wait for a while, then try again.

NO NETWORK: The network connection is unstable or lost.

- Make the network connection again on the device, or wait until the network connection is established.

NO STATION - PLEASE - CREATE - STATION - IN - PANDORA APP: No stations on your account.

→ Create the station on the mobile device.

NOT ALLOWED: The selected operation is not allowed.

- "Thumbs" feedback is not allowed.
 - Wait until the commercial ends.
 - Some functions, such as Shared Station, do not permit feedback. Wait until the next track begins, or select another station on the list.
- Bookmark is not allowed.
 - Wait until the commercial ends.
 - Select another track or station, then try it again.

PAN ERROR: The selected operation could not be performed.

→ Wait for a while, then try again.

PAN OPEN APP - PRESS PAUSE: Pandora® is not running.

- Launch the Pandora® application on the mobile device, then press ►|| (play/pause).

PLEASE LOGIN - PANDORA APP: You are not logged into your Pandora® account.

- Disconnect the device, log into your Pandora® account, then connect the device again.

RATING ERROR: "Thumbs" feedback failed.

→ Wait for a while, then try again.

UPDATE - PANDORA APP: An old version of Pandora® is connected.

- Update the Pandora® application to the latest version.

For SiriusXM operation:

CH LOCKED

- The channel that you have requested is locked by the radio parental control feature.
See "To set a parental control" (page 13) for more information on the parental control feature and how to access locked channels.

CH UNAVAIL

- The channel that you have requested is not a valid SiriusXM channel or the channel that you were listening to is no longer available.
- You may also see this message briefly when first connecting a new SiriusXM Connect Vehicle Tuner.
Visit www.siriusxm.com in the USA or www.siriusxm.ca in Canada for SiriusXM channel lineup information.

CHAN UNSUB

- The channel that you have requested is not included in your SiriusXM subscription package or the channel that you were listening to is no longer included in your SiriusXM subscription package.
If you have questions about your subscription package or would like to subscribe to this channel, please contact SiriusXM.
In the USA, visit www.siriusxm.com or call 1-866-635-2349.
In Canada, visit www.siriusxm.ca or call 1-877-438-9677.

CHK ANT

- The radio has detected a fault with the SiriusXM antenna.
- The antenna cable may be either disconnected or damaged.
 - Verify that the antenna cable is connected to the SiriusXM Connect Vehicle Tuner.
 - Inspect the antenna cable for damage and kinks.
 - Replace the antenna if the cable is damaged. SiriusXM products are available at your local car audio retailer or online at www.shop.siriusxm.com

CHECK TUNER

- The radio is having difficulty communicating with the SiriusXM Connect Vehicle Tuner.
- The tuner may be disconnected or damaged.
 - Verify that the SiriusXM Connect Vehicle Tuner cable is securely connected to the radio.

NO SIGNAL

- SiriusXM Connect Vehicle Tuner is having difficulty receiving the SiriusXM satellite signal.
 - Verify that your vehicle is outdoors with a clear view of the sky.
 - Verify that the SiriusXM magnetic mount antenna is mounted on a metal surface on the outside of the vehicle.
 - Move the SiriusXM antenna away from any obstructions.
 - Inspect the antenna cable for damage and kinks.
 - Consult the SiriusXM Connect Vehicle Tuner installation manual for more information on antenna installation.
 - Replace the antenna if the cable is damaged. SiriusXM products are available at your local car audio retailer or online at www.shop.siriusxm.com

SUBSCRIPTION UPDATED - PRESS ENT TO CONTINUE

- The radio has detected a change in your SiriusXM subscription status.
 - Press ENTER to clear the message.
 - If you have questions about your subscription, please contact SiriusXM. In the USA, visit www.siriusxm.com or call 1-866-635-2349.
 - In Canada, visit www.siriusxm.ca or call 1-877-438-9677.

For steering wheel remote control operation:

ERROR: An error occurred during the function registration.

- Register again from the function where the error occurred (page 22).

TIMEOUT: The function registration failed due to a timeout.

- Try completing the registration while [REGISTER] is blinking (about 6 seconds) (page 22).

If these solutions do not help improve the situation, consult your nearest Sony dealer. If you take the unit to be repaired because of CD playback trouble, bring the disc that was used at the time the problem began.

Connection/Installation

Cautions

- Run all ground (earth) leads to a common ground (earth) point.
- Do not get the leads trapped under a screw, or caught in moving parts (e.g., seat railing).
- Before making connections, turn the car ignition off to avoid short circuits.
- Connect the **yellow** and **red** power supply leads only after all other leads have been connected.
- Be sure to insulate any loose unconnected leads with electrical tape for safety.

Precautions

- Choose the installation location carefully so that the unit will not interfere with normal driving operations.
- Avoid installing the unit in areas subject to dust, dirt, excessive vibration, or high temperature, such as in direct sunlight or near heater ducts.
- Use only the supplied mounting hardware for a safe and secure installation.

Note on the power supply lead (yellow)

When connecting this unit in combination with other stereo components, the amperage rating of the car circuit to which the unit is connected must be higher than the sum of each component's fuse amperage rating.

Mounting angle adjustment

Adjust the mounting angle to less than 45°.

Parts List for Installation

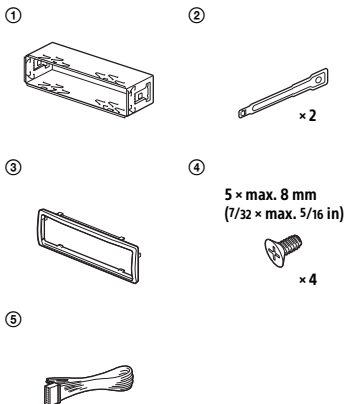

- This parts list does not include all the package contents.
- The bracket ① and the protection collar ③ are attached to the unit before shipping. Before mounting the unit, use the release keys ② to remove the bracket ① from the unit. For details, see "Removing the protection collar and the bracket" (page 40).
- Keep the release keys ② for future use as they are also necessary if you remove the unit from your car.

Connection

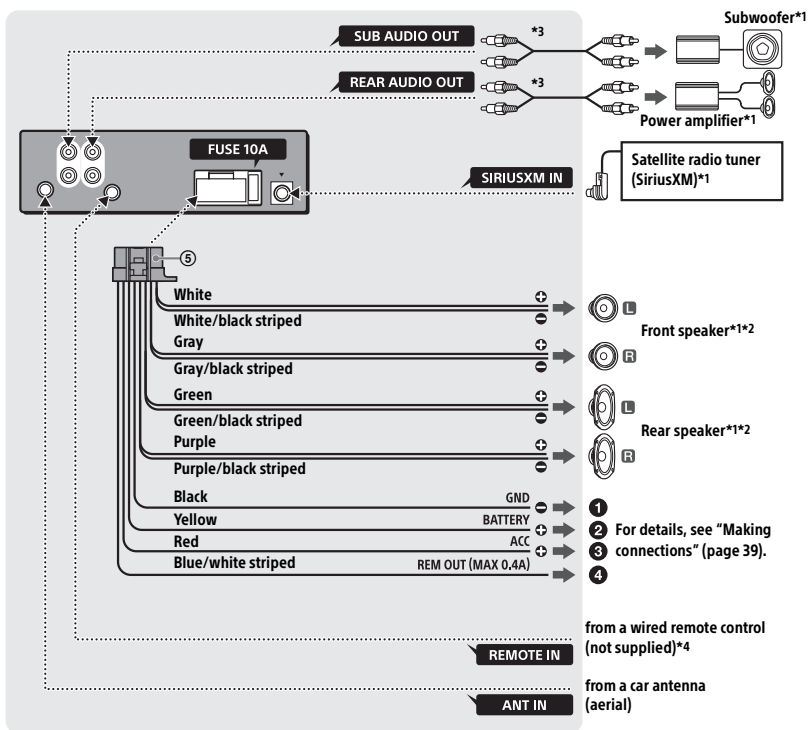

*1 Not supplied

*2 Speaker impedance: $4 \Omega - 8 \Omega \times 4$

*3 RCA pin cord (not supplied)

*4 Depending on the type of car, use an adaptor for a wired remote control (not supplied).

Making connections

1 To a common ground (earth) point

First connect the black ground (earth) lead, then connect the yellow and red power supply leads.

2 To the +12 V power terminal which is energized at all times

Be sure to first connect the black ground (earth) lead to a common ground (earth) point.

3 To the +12 V power terminal which is energized when the ignition switch is set to the accessory position

If there is no accessory position, connect to the +12 V power (battery) terminal which is energized at all times.

Be sure to first connect the black ground (earth) lead to a common ground (earth) point.

4 To the power antenna (aerial) control lead or the power supply lead of the antenna (aerial) booster

It is not necessary to connect this lead if there is no power antenna (aerial) or antenna (aerial) booster, or with a manually-operated telescopic antenna (aerial).

To AMP REMOTE IN of an optional power amplifier

This connection is only for amplifiers and a power antenna (aerial). Connecting any other system may damage the unit.

Memory hold connection

When the yellow power supply lead is connected, power will always be supplied to the memory circuit even when the ignition switch is turned off.

Speaker connection

- Before connecting the speakers, turn the unit off.
- Use speakers with an impedance of $4\ \Omega$ to $8\ \Omega$, and with adequate power handling capacities to avoid damage.

Subwoofer Easy Connection

You can use a subwoofer without a power amplifier when it is connected to a rear speaker cord.

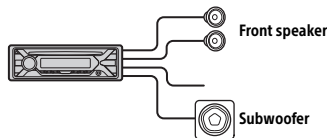

Note

Use a subwoofer with an impedance of $4\ \Omega$ to $8\ \Omega$, and with adequate power handling capacities to avoid damage.

Installation

Removing the protection collar and the bracket

Before installing the unit, remove the protection collar ③ and the bracket ① from the unit.

- 1 Pinch both edges of the protection collar ③, then pull it out.

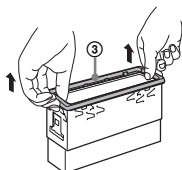

- 2 Insert both release keys ② until they click, and pull down the bracket ①, then pull up the unit to separate.

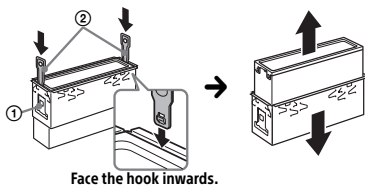

Mounting the unit in the dashboard

- Before installing, make sure the catches on both sides of the bracket ① are bent inwards 2 mm (3/32 in).
- For Japanese cars, see “Mounting the unit in a Japanese car” (page 41).

- 1 Position the bracket ① inside the dashboard, then bend the claws outward for a tight fit.

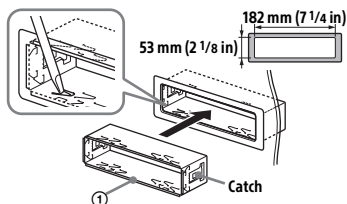

- 2 Mount the unit onto the bracket ①, then attach the protection collar ③.

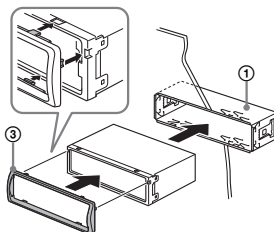

Notes

- If the catches are straight or bent outwards, the unit will not be installed securely and may spring out.
- Make sure the 4 catches on the protection collar ③ are properly engaged in the slots of the unit.

Mounting the unit in a Japanese car

You may not be able to install this unit in some makes of Japanese cars. In such a case, consult your Sony dealer.

TOYOTA

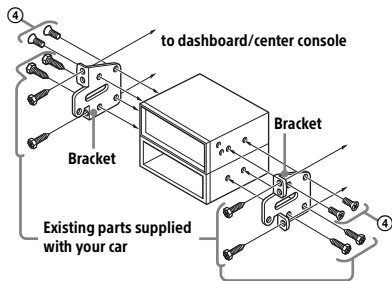

NISSAN

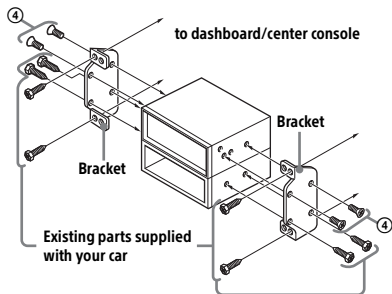

Note

To prevent malfunction, install only with the supplied screws (4).

Detaching and attaching the front panel

For details, see "Detaching the Front Panel" (page 8).

Fuse replacement

When replacing the fuse, be sure to use one matching the amperage rating stated on the original fuse. If the fuse blows, check the power connection and replace the fuse. If the fuse blows again after replacement, there may be an internal malfunction. In such a case, consult your nearest Sony dealer.

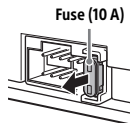

Support site

If you have any questions or for the latest support information on this product, please visit the web site below:

Site d'assistance

Si vous avez des questions ou si vous souhaitez consulter les toutes dernières informations techniques sur ce produit, rendez-vous sur le site Web suivant :

<http://esupport.sony.com/>

If you have any questions/problems regarding this product, try the following:

- 1 Read Troubleshooting in these Operating Instructions.**
- 2 Please contact (U.S.A. only);**
Call **1-800-222-7669**
URL **<http://www.SONY.com>**



Made for



iPod



iPhone

pandora®

(((SiriusXM)))
READY



 **Bluetooth®**