



Development Tool

Instruction manual

SCE CONFIDENTIAL

This manual contains safety precautions for the prevention of accidents, and instructions for the use and handling of this product. Read this manual carefully and use the product in a safe manner. After reading the manual, store it in an accessible location for future reference.

DTP-T1000 A

WARNING

WARNING

To avoid electrical shock, do not open the cabinet. Refer servicing to qualified personnel only.

Use the supplied AC adaptor only. If you use other types, it may cause fire, electrical shocks or a malfunction.

Laser specifications

UMD™

Wave length: 655-665 nm
Power: max 0.28 mW
Type: Semiconductor, continuous

DVD-ROM

Wave length: 640-660 nm (DVD)
775-805 nm (CD)
Power: max 0.3 mW (DVD)
0.23 mW (CD)
Type: Semiconductor, continuous

For customers in the U.S.A. and Canada

CAUTION

The use of optical instruments with this product will increase eye hazard. As the laser beams used in the DVD-ROM and UMD™ drives are harmful to eyes, do not attempt to disassemble the cabinet. Refer servicing to qualified personnel only.

CLASS 1 LASER PRODUCT KLASS 1 LASER APPARAT	LASER KLASSE 1 EN60825-1	LUOKAN 1 LASERLAITE APPAREIL À LASER DE CLASSE 1
CAUTION - CLASS 1M VISIBLE AND INVISIBLE LASER RADIATION WHEN OPEN DO NOT VIEW DIRECTLY WITH OPTICAL INSTRUMENTS VORSICHT - SICHTBARE UND UNSICHTBARE LASERSTRÄHLUNG KLASSE 1M WENN ABDECKUNG GEÖFFNET. NICHT DIREKT MIT OPTISCHEN INSTRUMENTEN BETRACHTEN. ADVARSEL - KLASSE 1M SYNLIG OG USYNLIG LASERSTRÅLING VED ÅBNING. SE IKKE IND I STRÅLEN MED OPTISKE INSTRUMENTER ADVARSEL - KLASSE 1M SYNLIG OG USYNLIG LASERSTRÅLING NÅR DEKSEL ÅPNES. SE IKKE DIREKTE MED OPTISKE INSTRUMENTER VARNING - SYNLIG OCH OSYNLIG LASERSTRÅLNING KLASSE 1M VID ÖPPEN LUCKA. SE INTE IN I STRÅLEN MED OPTIK VARO - AVÄTTÄESSÄ OLET ALTIINA LUOKAN 1M NÄKYVÄÄ JA NÄKYMÄTÖNTÄ LASERSÄTEILYÄ. ÄLÄ KATSO OPTISELLA LAITTEELLA SUORAAN SÄTEESEEN.		
CAUTION - Laser radiation when open. DO NOT STARE INTO BEAM.		

This label is located on the DVD-ROM laser protective housing inside the enclosure.

For customers in the U.S.A.

CAUTION

Use of controls, adjustments or performance of procedures other than those specified herein may result in hazardous radiation exposure.

NOTE:

This equipment has been tested and found to comply with the limits for a Class A digital device, pursuant to Part 15 of the FCC Rules. These limits are designed to provide reasonable protection against harmful interference when the equipment is operated in a commercial environment. This equipment generates, uses, and can radiate radio frequency energy and, if not installed and used in accordance with the instructions, may cause harmful interference to radio communications.

Operation of this equipment in a residential area is likely to cause harmful interference in which case the user will be required to correct the interference at his own expense.

You are cautioned that any changes or modifications not expressly approved in this manual could void your authority to operate this equipment.

FCC Radio-Frequency Exposure Statement

This equipment complies with FCC radiation exposure limits set forth for an uncontrolled environment. This equipment should be installed and operated with minimum distance 20 cm between the radiator and body. This transmitter must not be co-located or operating in conjunction with any antenna or transmitter.

Owner's Record

The model and serial numbers are located on the side of the unit. Record the serial number in the space provided below. Refer to these numbers whenever you call for technical assistance at the number shown in "Contact information" on the back cover of this instruction manual.

Model No. DIP-T1000 A

Serial No. _____

For customers in Canada

This Class A digital apparatus complies with Canadian ICES-003.

The term "IC" before the equipment certification number only signifies that the Industry Canada technical specifications were met.

Operation is subject to the following two conditions; (1) this device may not cause interference, and (2) this device must accept any interference, including interference that may cause undesired operation of the device.

Pour les utilisateurs au Canada

Cet appareil numérique de la classe A est conforme à la norme NMB-003 du Canada.

Le terme "IC" avant le numéro d'homologation ne signifie seulement que les normes d'Industrie Canada ont été respectées.

L'utilisation de ce dispositif est autorisée seulement aux conditions suivantes : (1) il ne doit pas produire de brouillage et (2) l'utilisateur du dispositif doit être prêt à accepter tout brouillage radioélectrique reçu, même si ce brouillage est susceptible de compromettre le fonctionnement du dispositif.

WARNING

For customers in Europe

CAUTION

The use of optical instruments with this product will increase eye hazard. As the laser beams used in the DVD-ROM and UMD™ drives are harmful to eyes, do not attempt to disassemble the cabinet. Refer servicing to qualified personnel only.

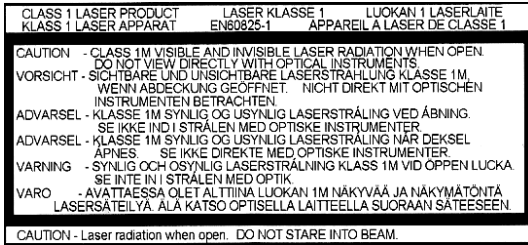

This label is located on the DVD-ROM laser protective housing inside the enclosure.

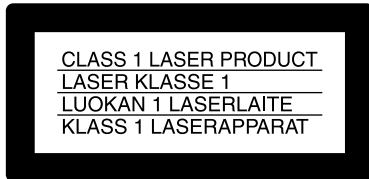

This appliance is classified as a CLASS 1 LASER product. The CLASS 1 LASER product marking is located on the side of the product.

This equipment complies with EN55022 CLASS B and EN55024 for use in the following areas: residential, business, and light-industrial.

This equipment has been tested and found to comply with the limits set out in the R&TTE Directive using a connection cable shorter than 3 metres.

Audio and picture distortion may occur if this equipment is positioned in close proximity to any equipment emitting electromagnetic radiation.

If this unit is affected by static electricity or burst-noise, it may not work correctly.

Dit apparaat bevat een vast ingebouwde batterij die niet vervangen hoeft te worden tijdens de levensduur van het apparaat. Raadpleeg uw leverancier indien de batterij toch vervangen moet worden. De batterij mag alleen vervangen worden door vakbekwaam servicepersoneel.

Gooi de batterij niet weg maar lever deze in als klein chemisch afval (KCA).

Lever het apparaat aan het einde van de levensduur in voor recycling, de batterij zal dan op correcte wijze verwerkt worden.



For customers in Korea

한국 소비자용

이 기기는 업무용으로 전자파적합등록을 한 기기이므로 판매자 또는 사용자는 이 점을 주의하시기 바라며 만약 잘못 판매 또는 구입하였을 때에는 가정용으로 교환하시기 바랍니다.

주의

이 제품을 광학기계와 함께 사용하면 시력을 해칠 우려가 있습니다. 이 제품의 DVD-ROM과 UMD™ 드라이브에 사용된 레이저 빔은 눈에 해로우므로 케이스를 분해하지 마십시오.

우리는 반드시 전문 기술자에게 의뢰하십시오.

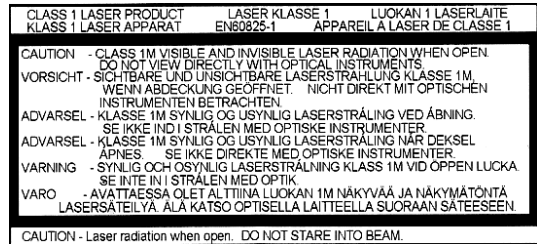

이 라벨은 내부의 DVD-ROM 레이저 보호장치에 표시되어 있습니다.

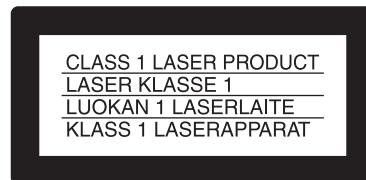

이 기기는 CLASS 1 LASER 제품으로 분류됩니다. CLASS 1 LASER 표시는 제품 옆면에 있습니다.

AC 어댑터의 제조년월

AC 어댑터의 라벨 아래 부분에 제조년월이 표시되어 있습니다.

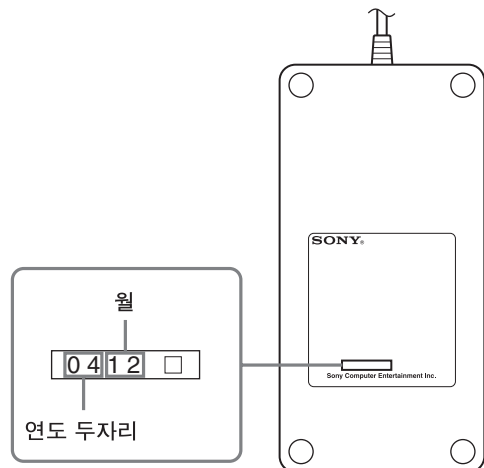

Important safeguards

For your protection, please read these safety instructions completely before operating the appliance, and keep this manual for future reference.

Carefully observe all warnings, precautions and instructions on the appliance, or those described in the instruction manual and adhere to them.

USE

Power sources

This unit should be operated only from the type of power source indicated on the marking label. If you are not sure of the type of electrical power supplied to your home, consult your dealer or local power company. For those units designed to operate from battery power, or other sources, refer to the operating instructions.

Overloading

Do not overload wall outlets, extension cords or convenience receptacles beyond their capacity, since this can result in fire or electric shock.

Liquid and foreign objects

Never push objects of any kind into the unit through openings as they may touch dangerous voltage points or short out parts that could result in a fire or electric shock. Never spill liquid of any kind on the unit.

Attachments

Do not use attachments not recommended by the manufacturer, as they may cause hazards.

Cleaning

Unplug the unit from the wall outlet before cleaning or polishing it. Do not use liquid cleaners or aerosol cleaners. Use a cloth lightly dampened with water for cleaning the unit exterior.

INSTALLATION

Water and moisture

Do not use the powerline operated unit near water – for example, near a bathtub, washbowl, kitchen sink, or laundry tub, in a wet basement or near a swimming pool, etc.

Power cord protection

Route the power cord so that it is not likely to be walked on or pinched by items placed upon or against it, paying particular attention to the plugs, receptacles, and the point where the cord exits from the unit.

Ventilation

The slots and openings in the cabinet are provided for necessary ventilation. To ensure reliable operation of the unit, and to protect it from overheating, these slots and openings must never be blocked or covered.

- Never cover the slots and openings with a cloth or other materials.
- Never block the slots and openings by placing the unit on a bed, sofa, rug or other similar surface.

Accessories

Do not place the unit on an unstable cart, stand, bracket or table. The unit may fall, causing serious injury to a child or an adult, and serious damage to the unit.

Use only a cart, stand, tripod, bracket, or table recommended by the manufacturer.

An appliance and cart combination should be moved with care. Quick stops, excessive force, and uneven surfaces may cause the appliance and cart combination to overturn.

- Never place the unit in a confined space, such as a bookcase, or built-in cabinet, unless proper ventilation is provided.
- Do not place the unit near or over a radiator or heat register, or where it is exposed to direct sunlight.

SERVICE

Damage requiring service

Unplug the unit from the wall outlet and refer servicing to qualified service personnel under the following conditions:

- When the power cord or plug is damaged or frayed.
- If liquid has been spilled or objects have fallen onto the unit.
- If the unit has been exposed to rain or water.
- If the unit has been subject to strong physical shock by being dropped, or the cabinet has been damaged.
- If the unit does not operate normally when following the instruction manual. Adjust only those controls that are specified in the instruction manual. Improper adjustment of other controls may result in damage and will often require extensive work by a qualified technician to restore the unit to normal operation.
- When the unit exhibits a distinct change in performance – this indicates a need for service.

Servicing

Do not attempt to service the unit yourself as opening or removing the exterior casing may expose you to dangerous voltage or other hazards.

Refer all servicing to an authorized service center. Refer to the contact information on the back cover to receive instructions on obtaining repair/replacement services.

Replacement parts

When replacement parts are required, be sure the service technician has used replacement parts specified by the manufacturer that have the same characteristics as the original parts.

Unauthorized substitutions may result in fire, electric shock, or other hazards.

Safety check

Upon completion of any service or repairs to the unit, ask the service technician to perform routine safety checks (as specified by the manufacturer) to determine that the unit is in safe operating condition.

Table of contents

WARNING	2
Important safeguards	4
Precautions	7

Chapter 1

Overview	About this product	9
	Part names and usage	10
	System configuration example	14

Chapter 2

Preparing to use the unit	Connecting to a network	15
	Unit or accessories necessary for connecting	15
	Connection diagrams	15
	Connecting peripherals	16
	Setting up	17
	Information necessary for setup	17
	Preparing for setup	17
	Turning on the unit	17
	Confirming information settings	18
	Starting the Administration Tool	18
	Setting up	19
	Showing status	24
	Usage notice	25

Chapter 3

Appendices	Troubleshooting	26
	Specifications	28
	R&TTE Directive "Informal DoC" statement	29
	Limitations of liability	30

Precautions

Safety

This product has been designed with the highest concern for safety. However, any electrical device, if used improperly, has the potential for causing fire, electrical shock or personal injury. To help ensure accident-free operation, follow these guidelines.

- Observe all warnings, precautions and instructions.
- Stop use and unplug the AC power cord from the electrical outlet if the unit functions in an abnormal manner, or produces unusual sounds or smells.
- Call the number listed on the back cover for technical assistance if the device does not operate properly.
- Do not remove the unit's exterior or disassemble the unit. The laser beam emitted from the lens of this unit may be harmful to the eyes.
- Do not use the unit near water.
- Stop using the unit immediately if you experience any of the following symptoms. If the condition persists, consult a doctor.
 - Lightheadedness, nausea or a sensation similar to motion sickness
 - Tired, uncomfortable or aching hands or arms
 - Tired, dry or aching eyes
- Avoid looking at the screen for prolonged periods of time.
- Listening to sound continuously for a long time with a high volume may adversely affect the ears. Be careful, especially when using headphones. Adjust the volume so that surrounding sounds can be heard.
- Do not close the disc tray or disc cover in a way that could pinch your hand or fingers, as personal injury or damage to the unit could result.
- The socket outlet shall be installed near the equipment and shall be easily accessible.

Use and handling

- Do not use the unit or accessories outdoors.
- Do not throw or drop the unit or accessories, or expose the devices to strong physical shock. Handle the analog stick with care.
- Do not forcibly twist the controller or expose it to strong physical shock, as doing so can cause damage.
- Do not place the unit or accessories on surfaces that are unstable, tilted or subject to vibration.
- Do not expose the unit or accessories to high temperatures, high humidity or direct sunlight.
- Do not block the vents.
- Do not wrap the unit or accessories in cloth or similar materials.
- Do not allow dust to build up on the unit.
- Do not place the unit in locations of poor ventilation, such as small, enclosed areas, directly against a wall or on a thick carpet or bedding.
- Do not expose the unit to dust, smoke or steam.
- Do not allow liquid or small particles to get into the unit.
- Do not put heavy objects on the unit.
- Do not place anything in front of the disc tray.
- Do not use damaged, reshaped or repaired discs.
- Do not touch or insert foreign objects into the connectors of the unit or accessories.
- Do not insert cords and cables at an angle. Doing so may damage the connector pins or create the risk of fire.
- Do not set the unit other than in the vertical position.
- If a spring or screw is provided to secure a cable connector, use the provided spring or screw to secure it. Take care to prevent making faulty connections.

Precautions

AC adaptor and AC power cord use

- To help ensure safe operation, during initial setup and regularly thereafter, inspect the AC adaptor and AC power cord. If damaged, stop use immediately and call the number on the back cover for assistance.
- Do not use AC adaptors or AC power cords other than those provided or designated in the instruction manual. If the provided or designated AC adaptor or power cord is not used, electrical shock may result or the unit may not operate.
- Do not modify or damage the AC power cord.
- Do not place the AC adaptor between the unit and a wall or shelf.
- Do not place heavy objects on the AC power cord.
- Check that there is no dust or lint on the power plug before inserting into an electrical outlet. If the plug becomes dirty, wipe it off with a dry cloth before connecting.
- When inserting the AC power cord into an electrical outlet, insert the plug straight into the electrical outlet and not at an angle.
- Unplug the AC power cord from the electrical outlet before cleaning or moving the unit, or when you do not intend to use the unit for an extended period of time. When disconnecting, grasp the power cord by the plug and pull straight out of the electrical socket. Never pull by the cord and do not pull out at an angle.
- Do not touch the plug of the AC power cord with wet hands.
- Do not touch the power plug during an electrical storm.
- Do not touch the unit or AC adaptor for extended periods of time while the unit is turned on, as extended contact may cause low-temperature burns.

Cleaning

- For safety reasons, before cleaning the unit or connected accessories, 1) turn off the unit, 2) disconnect the power plug for the unit from the electrical outlet.

Moisture condensation

- If the unit or disc is brought directly from a cold location to a warm one, moisture may condense on the lens inside the unit or on the disc. Should this occur, the unit may not operate properly. In this case, remove the disc and turn off and unplug the unit. Do not put the disc back in until the moisture evaporates (this may take several hours). If the unit still does not operate properly, obtain technical assistance using the contact information on the back cover.

Photosensitivity

- A very small percentage of individuals may experience epileptic seizures when exposed to certain light patterns or flashing lights. Exposure to certain patterns or backgrounds on a television screen or while playing video games, including games played on the unit, may trigger an epileptic seizure in these individuals. Certain conditions may trigger previously undetected epileptic symptoms even in persons who have no history of prior seizures or epilepsy. If you, or anyone in your family, has an epileptic condition, consult your physician prior to playing. If you experience any of the following symptoms while playing a video game - dizziness, altered vision, eye or muscle twitches, loss of awareness, disorientation, any involuntary movement or convulsions - IMMEDIATELY discontinue use and consult your physician before resuming play.

Radio waves

- Radio waves may affect electronic equipment or medical devices (for example, pacemakers), which may cause malfunctions and possible injuries.
 - If you use a pacemaker or other medical device, consult your physician or the manufacturer of your medical device before using the wireless networking feature.
 - Keep the unit at least 9 inches (23 cm) away from a pacemaker or other medical devices when using the wireless networking feature.

About this product

This unit is equipped with features for the development of PSP™ software. The unit can download software or data from a local area network, allowing for the efficient debugging, running and checking of programs.

- PSP™ features are provided for efficient software development.
- A built-in communication processor allows software, data etc. to be easily sent and received through the development PCs and networks.
- A direct network connection can be established for easy installation and additions. Also, the load on development PCs can be reduced.
- Two types of drives are built in: a UMD™ drive, and a DVD-ROM drive, which is used during development. A switch is used to select the desired drive.

For proper operation, separate development software and a development PC are required. For details, contact technical support using the contact information on the back cover.

Part names and usage

Unit front

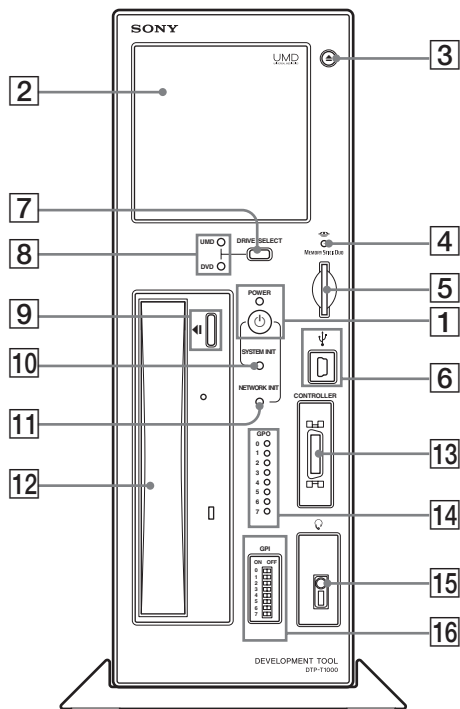

1 On/standby button, power indicator

This button turns the unit on and off.

To turn on the unit

Press the on/standby button while it is in standby mode. The power indicator flashes green as the power turns on. The indicator then turns solid green when the system is ready. The system status can be determined by the color and status of the power indicator.

Flashing green	The system is preparing to start up (flashes until the system becomes available after the on/standby button is pressed)
Solid green	The system is starting up (the unit can now be used)
Flashing red	During system initialization (auto-recovery)
Solid red	System initialization or update failure (indicates the need to initialize the system)
Flashing orange	During network initialization
Solid orange	Standby mode

Turning the unit off (standby mode)

- Press the on/standby button and hold it down for three seconds. The power indicator will flash and then turn orange, at which point the power will be turned off (and the system will enter standby mode).
- Remove the power plug from the electrical outlet after the power indicator turns a solid orange. If the plug is removed before the indicator turns orange, failure of the unit may result.

2 Disc cover

The open button (3) is used to open the cover so that UMD™ can be inserted. When closing, press the middle of the upper edge of the disc cover.

3 Open button

This button is used to open the disc cover (2).

4 Memory Stick Duo™ access indicator

Turns orange while the unit is accessing a Memory Stick Duo™ or Memory Stick PRO Duo™ that has been inserted into the unit.

5 Memory Stick Duo™ slot

This slot accepts Memory Stick Duo™ or Memory Stick PRO Duo™ media.

6 USB connector

For connecting USB connectors (mini-B type). When the included controller is connected to the USB connector, the controller's USB connector becomes functional.

7 Drive select button

Switches between the UMD™ drive and the DVD-ROM drive.

The selected drive is identified by the UMD™/DVD-ROM drive indicators (8). The drive select button (7) can be used only when the power indicator of the controller is not lit.

8 UMD™/DVD-ROM drive indicator

The indicator for the drive, UMD™ or DVD-ROM, turns orange to indicate which drive is selected.

9 Open/close button

This button is used to open/close the DVD-ROM drive.

Part names and usage

10 System initialise button

While holding down this button, pressing the on/standby button (1) returns the communication processor software to the factory default initial state.

11 Network initialise button

While holding down this button, pressing the on/standby button (1) restores the factory default values for the IP address settings.

12 DVD-ROM drive

This drive accepts DVD-ROM discs. Use the open/close button (9) to insert and remove discs.

13 Controller port

Connects with the commander interface connector of the attached controller.

14 GPO indicator

These are eight indicators that are user-definable by PSP™ software developers.

15 Headset connector

A dedicated PSP™ headset remote controller or a commercially sold headset (with a stereo mini-plug) can be connected here.

16 GPI switch

These are eight dip switches that are user-definable by PSP™ software developers.

Unit rear

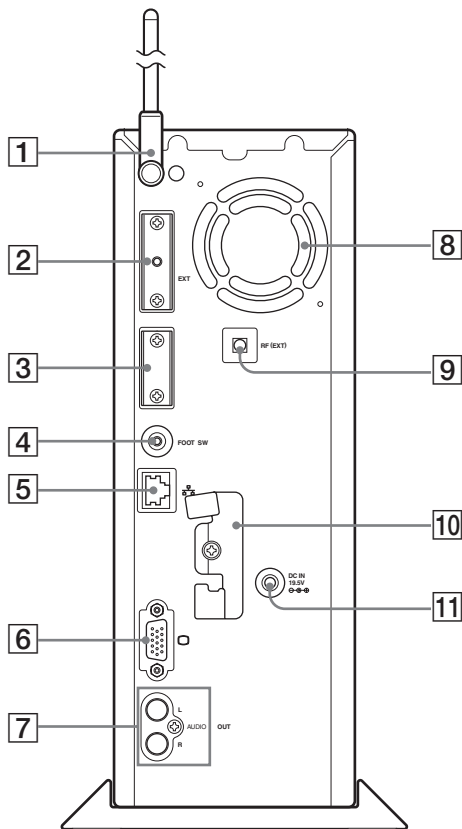

1 Aerial

For wireless LAN use.

2 Extension connector

For use by service personnel only.

3 Dedicated connector for servicing

For use by service personnel only.

Caution

Usage of this port may cause irreparable damage to the system.

4 Foot switch connector

Connects to the supplied foot switch.

5 Network connector

Connector for a network cable. Allows connection to a local area network.

6 VGA connector

Connects to a device with a VGA IN connector.

7 AUDIO OUT connector

Connects to a device with an AUDIO IN connector.

8 Vent fan

Vent for internal fan used to cool unit. Be sure not to obstruct this vent, as doing so may cause a fire. Also, to prevent any hindrance to air flow, position the unit an adequate distance from walls.

Part names and usage

9 RF (extension) connector

Connects to an access point using a coaxial cable.

10 Clamp

For securing the aerial and AC adaptor to the unit.

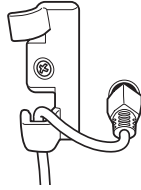

11 DC IN 19.5V connector

For attaching the included AC adaptor.

Controller front

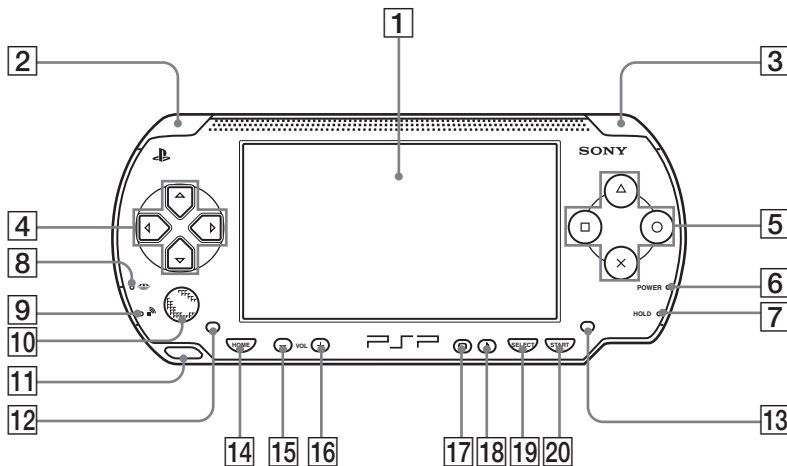

1 LCD screen

2 L button

3 R button

4 Up, down, left, right buttons

5 Δ , \circ , \times , \square buttons

6 Power indicator

7 Hold indicator

8 Memory Stick Duo™ access indicator

9 WLAN access indicator

10 Analog stick

11 Strap holder

12 Left speaker

13 Right speaker

14 Home button

15 Volume - button

16 Volume + button

17 Display button

18 Sound button

19 Select button

20 Start button

Controller front

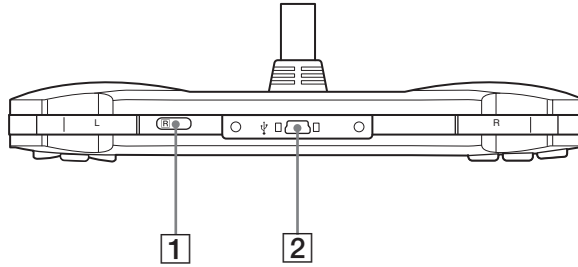

- 1 IR port
- 2 USB connector

Controller bottom

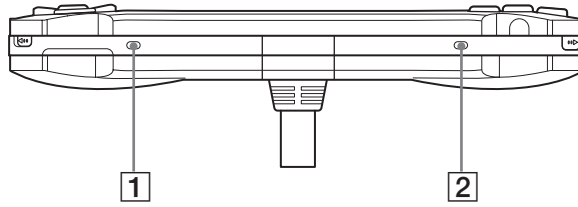

- 1 Left speaker
- 2 Right speaker

Caution

Do not cover or insert foreign objects into the speakers as doing so may result in damage to the controller.

Controller left

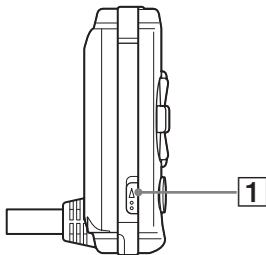

- 1 WLAN switch

Controller right

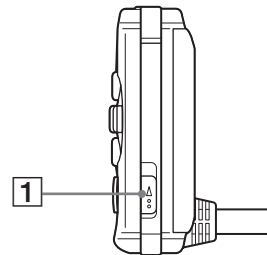

- 1 Power/hold switch

Caution

For this product, the debugger (dstdb) reset command cannot be used when the power/hold switch of the controller is in the hold position. Make sure that the controller's power/hold switch is not in the hold position when operating the debugger.

System configuration example

Overview

The following accessories may be connected to the unit.

Unit front

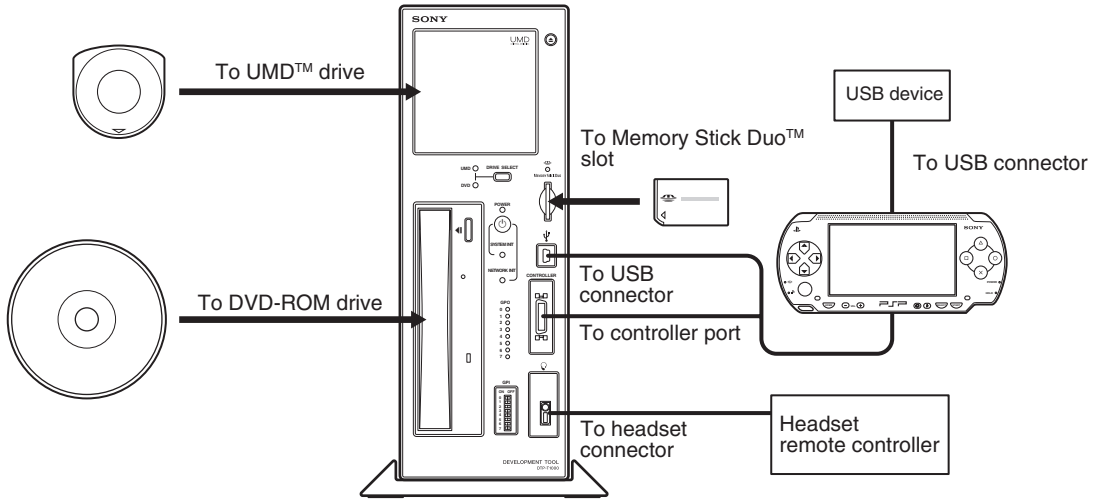

Caution

When you connect or disconnect the controller, turn off power to the unit (keep it in standby mode). If the power is left on, it may result in damage to the unit or the controller.

Unit rear

Before connecting a cable, rotate the aerial in a clockwise direction, and raise it upright. If the cable is connected first, it may not be possible to rotate the aerial.

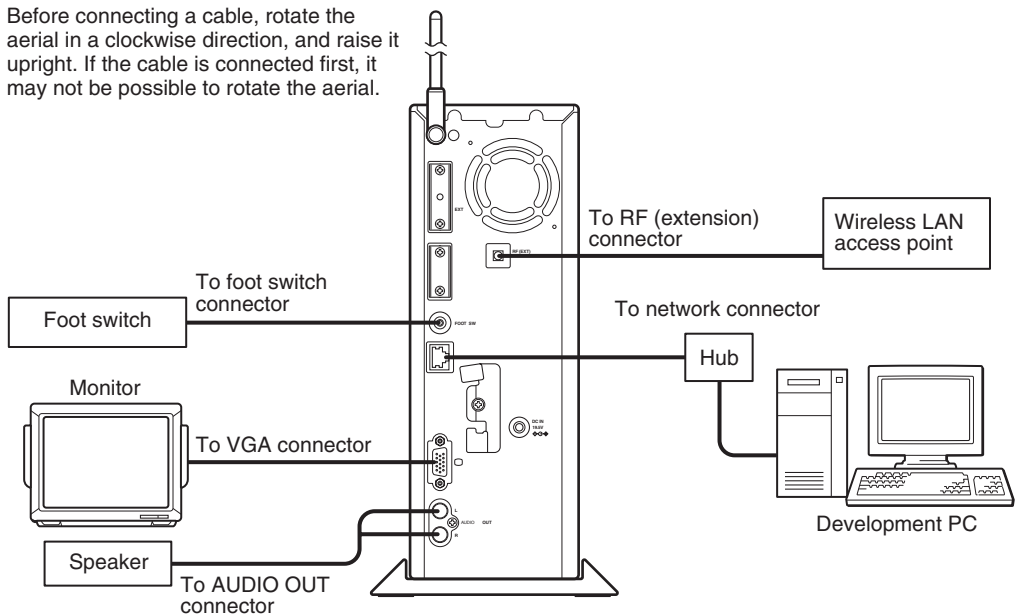

Preparing to use the unit

Connecting to a network

Unit or accessories necessary for connecting

The following devices and accessories are necessary in order to use this unit as a development machine:

- Development Tool
- Network cable
- Hub
- Development PC

Connection diagrams

Before connecting a cable, rotate the aerial in a clockwise direction, and raise it upright. If the cable is connected first, it may not be possible to rotate the aerial.

Connecting to a network without a DHCP server

You can build a local network with this unit and a development PC in the following manner.

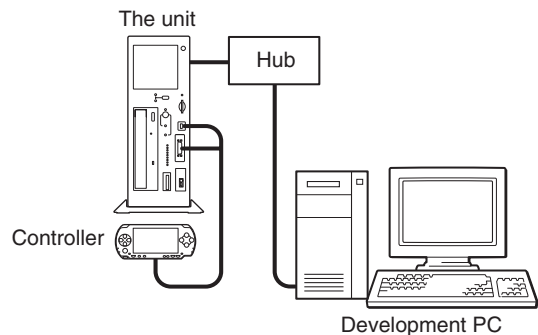

At this time, the following static IP addresses are automatically set for the unit:

- IP address : 192.168.0.10
- Subnet mask : 255.255.255.0

Caution

- The IP address and subnet mask settings are default factory settings. When the network settings for the unit are modified, these settings are also modified accordingly.
- To modify the IP address, start up both the unit and the development PC, and configure their respective settings to support the network to which they are to be connected. After configuration, use a network cable to connect the unit and the development PC to a hub within the network in use. Refer to “Setting up” on page 17 for information on how to set up the unit.

Connecting to a network

Connecting to a network with a DHCP server

Connect the unit and a development PC running the DHCP client software to a hub on the network.

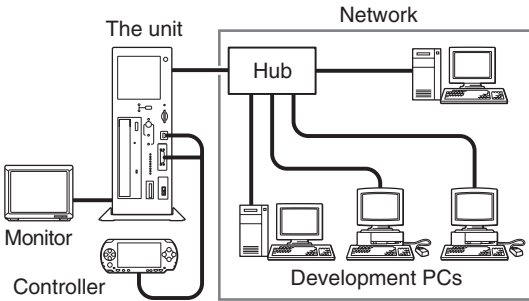

In this case, the IP address and subnet mask settings will be obtained automatically when the unit is turned on. Depending on the settings of the DHCP server, other network settings, such as the DNS server and default gateway, may also be obtained. For details on which settings can be automatically obtained, contact your network administrator.

Connecting peripherals

- 1 Connect the unit to a hub using a network cable.
- 2 Connect the hub to the development PC using a network cable.

Caution

When using the wireless LAN function, keep the controller away from the unit's aerial. If the unit is used with the controller and aerial in close proximity, radio frequency interference from the controller can affect the radio waves of the wireless LAN.

When using the unit in Europe, Oceania and Korea

Install the supplied RFI filter on the network cable (unshielded twisted pair cable). Install the RFI filter near the main unit.

When installing the RFI filter on the cable, wind the cable once around the RFI filter, as shown below.

There is a band supplied for use with the RFI filter. Use the band to attach the RFI filter to the cable. Fit the band to the cable, as shown below.

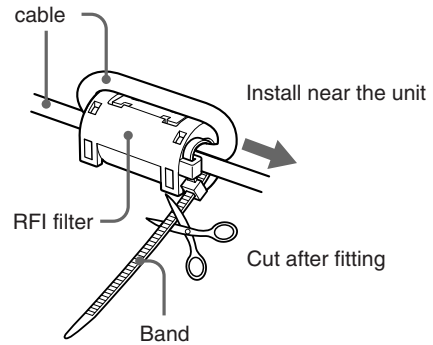

Information necessary for setup

The following information is required for the setup of the unit.

- DHCP server availability
- IP address
- Subnet mask
- IP address of the default gateway

Check with your network administrator about the structure of the network to which this unit will be connected.

Preparing for setup

Before setting up the unit, you need to configure your development PC.

Connecting to a network without a DHCP server

- 1 Turn on the development PC.**
- 2 Configure the TCP/IP settings of the development PC.**

Configure the TCP/IP settings as follows:

- IP address of the development PC
192.168.0.2
- Subnet mask of the development PC
255.255.255.0

Activate the Web browser on the development PC, and configure it so that it does not use a proxy.

Refer to the development PC's instruction manual for details.

Connecting to a network with a DHCP server

- 1 Turn on the development PC.**
- 2 Configure the development PC.**

Run the DHCP client software and configure it so that the development PC can obtain the IP address and other settings from the DHCP server. Refer to the instructions supplied with the development PC for details on how to configure the PC to run the software and obtain an IP address. Next, configure the development PC to run a Web browser.
- 3 Configure the DHCP server.**

When the IP address is automatically obtained by the DHCP server, the specific IP address allotted to a device is generally different each time the device is connected to the network. However, the use of the unit can be made more convenient by setting the same IP address to be allotted each time the device is connected. Contact your network administrator for details on how to set a static IP address.

Turning on the unit

After configuring the TCP/IP settings of the development PC, turn on the unit.

- 1 Connect the AC power cord to the AC adaptor, then connect the AC adaptor to the unit.**
- 2 Insert the AC power cord into an electrical outlet.**

The power indicator turns orange, and the unit enters standby mode.
- 3 Press the on/standby button.**

This turns on the unit and starts system initialization. During initialization, the power indicator flashes green. This indicator stops flashing when initialization is complete.

Caution

- When turning on the unit, be sure to use the supplied AC adaptor.
- Do not operate the unit during initialization.

Confirming information settings

Confirm that the information below is displayed on the controller LCD:

- IP Address
- Subnet mask
- Broadcast address
- IP address of the default gateway
- Mac address
- Host name

Caution

When you connect or disconnect the controller, turn off power to the unit (keep it in standby mode). If the power is left on, it may result in damage to the unit or the controller.

Starting the Administration Tool

Start up the Administration Tool on the development PC. The following section assumes use of the IP address 192.168.0.10 for the unit.

- 1 Start the Web browser on the development PC.**
- 2 Type “http://192.168.0.10/” and press the “Enter” key.**
The language selection screen is displayed.

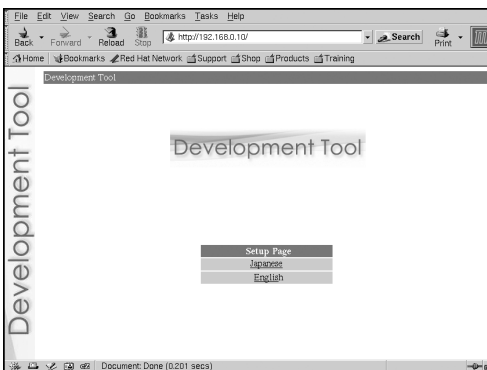

- 3 Select the display language for the administration tool.**

The login screen is displayed.

Select the language (for example English) here.

Login

Log in with a user name and password.

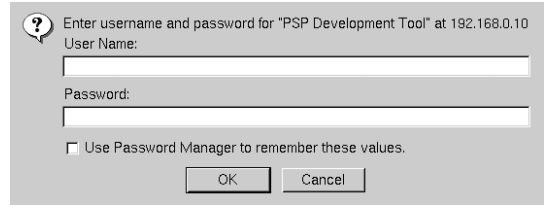

Enter the user name and password.

- 1 Enter the user name and password as follows.**

To log in as the administrator, enter the “Administrator” user name and password as follows:

- user name: Administrator
- password: Administrator
- * These are the factory default settings.

When logged in as the administrator, all of the functions shown in the Administration Tools menu are active.

To log in as a user, enter the user name and password as follows:

- user name: User
- password: User
- * These are the factory default settings.

When logged in as a user, only the “Status Display” functions shown in the Administration Tools menu are active. The “Settings” functions cannot be used.

- 2 Click [OK].**

Upon successfully logging in, the main screen of the Administration Tool is displayed.

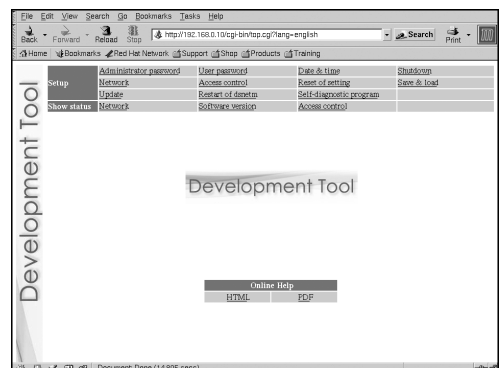

Setting up

Setup

These options allow the user to modify settings, update the software and shut down the unit.

Administrator password	Change the administrator password
User password	Change the user password
Date & time	Configure the time and time zone
Shutdown	Reboot/Shutdown
Network	Configure the necessary network settings
Access control	Configure dsnet access control
Reset of setting	Initialize the selected settings
Save & load	Save settings, and synchronize the saved settings with this unit
Update	Update the system
Restart of dsnetm	Restart programs communicating with the host PC
Self-diagnostic program	Conduct a variety of tests

Show status

The following unit settings can be displayed.

Network	Verify the network settings
Software version	Verify the version numbers of installed software packages
Access control	Display dsnet access control settings

Online help

You can view the Help for the Administration Tool.

Setting up

Click on the items to the right of “Setup” to configure each setup.

Administrator password

Upon clicking “Administrator password”, the following screen is displayed. This screen is utilized to change the password used for administrator authentication.

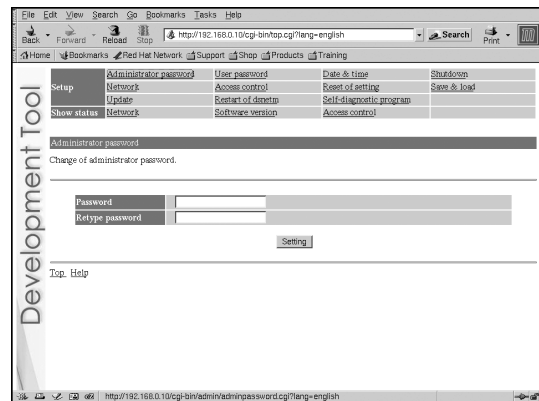

Enter the desired password in the “Password” and “Retype Password” fields. Click “Setting” to complete the configuration.

Caution

- For security purposes, be sure to change the default password.
- The password must be a combination of both letters and numeric characters. Passwords consisting of all lowercase, all uppercase or all numeric characters are not allowed.
- A password may be seven or eight characters long. Passwords fewer than seven characters long are not allowed. Also, if nine or more characters are entered, only the first eight characters are set as the password.
- If an error is made in entering the password, or the values entered into the “Password” and “Retype password” fields do not match, an error message is displayed. If this occurs, enter the password again.

User password

Upon clicking “User password”, the following screen is displayed. This screen is utilized to change the user password used to log in to the system.

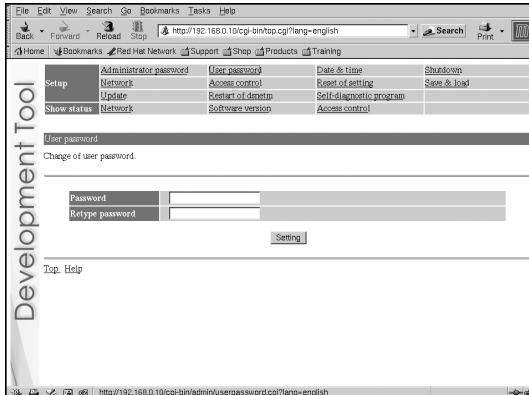

Enter the desired password in the “Password” and “Retype Password” fields. Click “Setting” to complete the configuration.

Caution

- For security purposes, be sure to change the default password.
- The password must be a combination of both letters and numeric characters. Passwords consisting of all lowercase, all uppercase or all numeric characters are not allowed.
- A password may be seven or eight characters long. Passwords fewer than seven characters long are not allowed. Also, if nine or more characters are entered, only the first eight characters are set as the password.
- If an error is made in entering the password, or the values entered into the “Password” and “Retype password” fields do not match, an error message is displayed. If this occurs, enter the password again.

Date & time

Upon clicking “Date & time”, the following screen is displayed. This screen is used to configure the date, time and time zone.

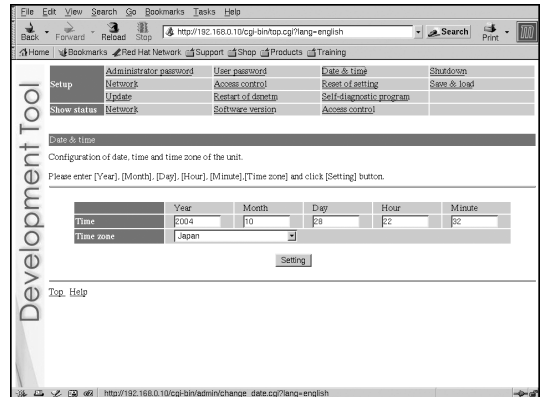

Enter values for the year, month, day and time, and select the time zone. Click “Setting” to complete the configuration.

Network

Upon clicking “Network”, the following program is displayed. This screen is used to change the method for obtaining an IP address and to change the values required for network configuration.

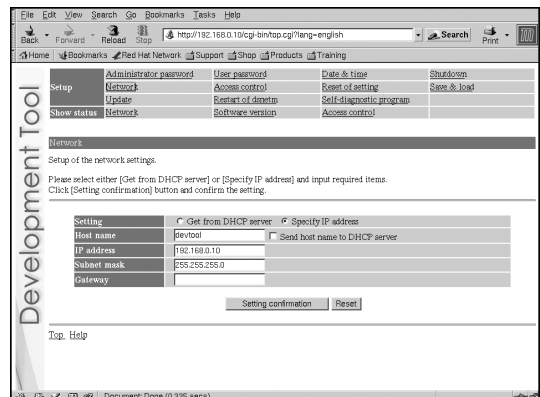

If you want to change the network settings, enter the new network settings in the appropriate fields in this screen and then click “Setting confirmation”. The following confirmation screen is then displayed.

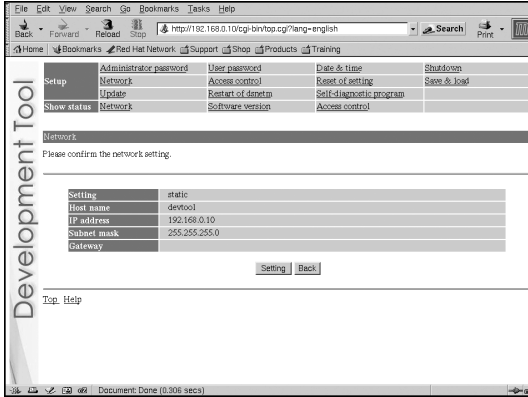

Click “Setting” to begin processing the settings. After the configuration is set, the following screen is displayed.

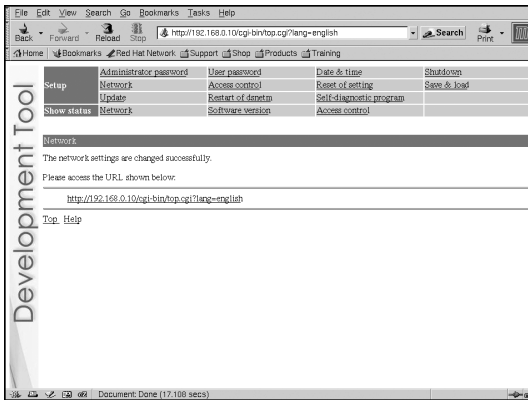

Modify the network connection mode as needed, and access the URL displayed on the screen.

Update

Upon clicking “Update”, the following screen is displayed. This screen is used to update the software required by the unit.

- 1 Place the files to be updated in the appropriate directories on the development PC, and click “Update”. The following screen appears.

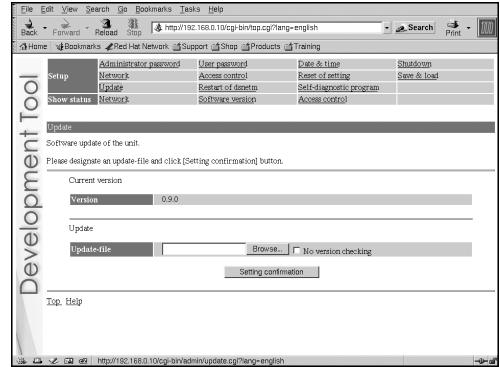

Caution

Upon clicking “Setting confirmation” (see the step below), the versions of files that are already installed and the versions of the update files are checked to confirm whether the update files are more recent and to confirm the dependency relationships between files. This check is not performed if “No version checking” is selected. It is recommended that the default setting (“Check versions”) be used.

- 2 Enter the path to the file to be updated, and click “Setting confirmation”.

The following screen is displayed, and the contents of the update file are displayed.

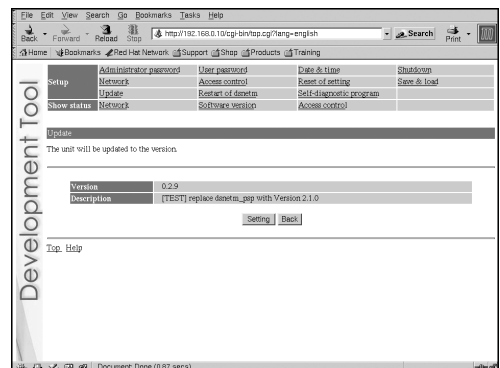

Setting up

3 Verify the contents of the files, and click “Setting”.

The installation will begin.

If the contents are incorrect, click “Back” to make corrections.

Reset of setting

Upon clicking “Reset of setting”, the following screen is displayed. This screen is used to restore the factory default network settings and administrator password.

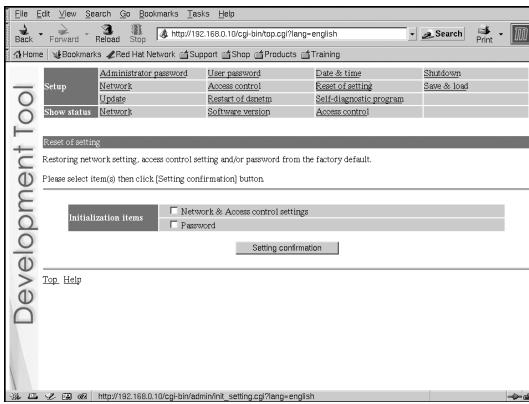

Select the setting(s) to be initialized and click “Setting confirmation” to complete initialization.

Save & load

Upon clicking “Save & load”, the following screen is displayed. This screen is used to save the settings and to synchronize the settings with the unit.

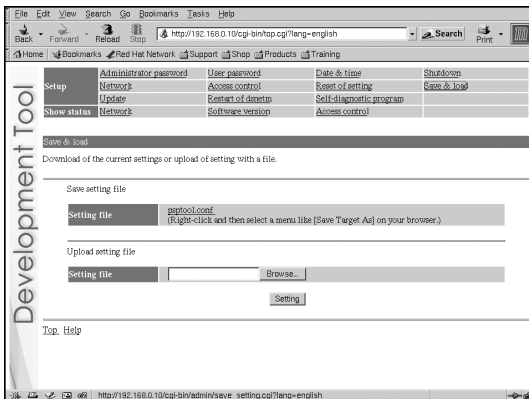

To save the unit’s settings on the development PC:

Right-click on “psptool.conf” and then select “Save Target As” or “Save Link As”.

Caution

This procedure may vary depending on the web browser used. For details, refer to the instructions for the web browser.

To configure the unit using settings saved on the development PC:

1 Check that the IP address defined in the development PC’s settings file is the same as the IP address assigned to the unit.

If the IP address defined in the settings file and the unit’s IP address are different, use a text editor to change the IP address in the settings file of the development PC.

2 Click “Browse” and select a file to use for configuring the unit.

3 Click “Setting”.

The settings will be saved on the unit, and the information will be modified.

Access control

Upon clicking “Access control”, the following screen is displayed. This screen is used to configure the PCs that will be allowed to access dsnet.

“dsnet” is a program package for operating the unit.

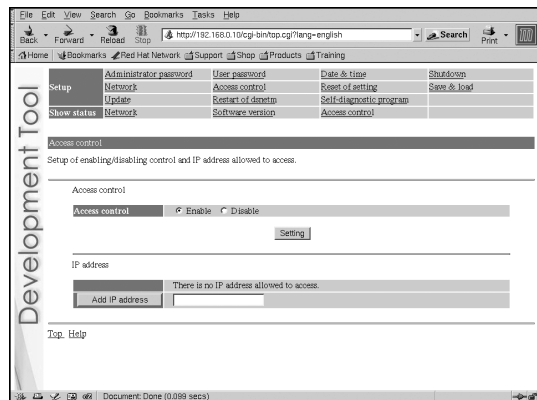

To deactivate access control:

- 1 Select “Disable”, and click “Setting”.
This allows access from a PC that has been configured with any IP address.

To activate access control:

- 1 Select “Enable”, and click “Setting”.
This allows access only from a PC that has been configured with one of the set IP addresses.
- 2 Enter the IP address to be registered, and then click “Add IP address”.
This registers the IP address to which access is permitted.
Click on “Delete” next to an IP address that has already been registered to delete that address.

Caution

- Enter an IP address using one of the following formats:
- xxx.xxx.xxx.xxx (xxx = 0-255)
 - xxx.xxx.xxx.xxx/yy (xxx = 0-255, yy = 0-32)

Self-diagnostic program

Upon clicking “Self-diagnostic program”, the following screen is displayed. This screen is used to perform a variety of self-diagnostic tests.

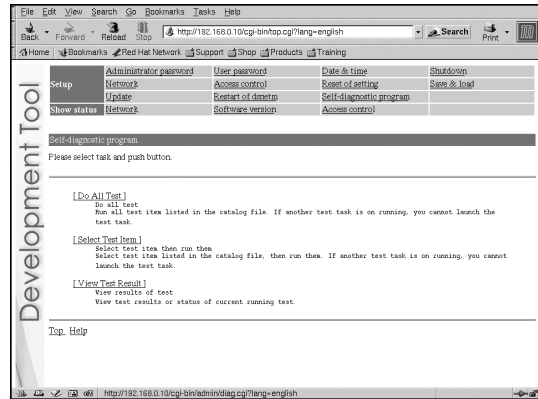

- 1 Click on the process to be performed.
The test will begin.

Restart of dsnetm

“dsnetm” is a program used to communicate between the TCP/IP sockets on the unit and a host PC.

Upon clicking “Restart of dsnetm”, the following screen is displayed.

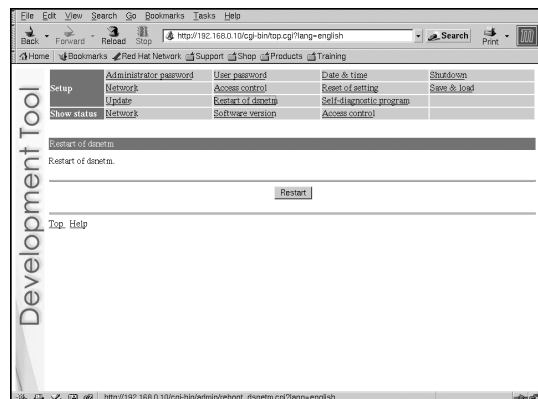

Click “Restart” to restart dsnetm and display the restart status. After completing the restart, the following screen is displayed.

Access control

Upon clicking “Access control”, the following screen is displayed. This screen lists the dsnet access control status and the IP addresses that have been granted access. This allows the user to verify this information.

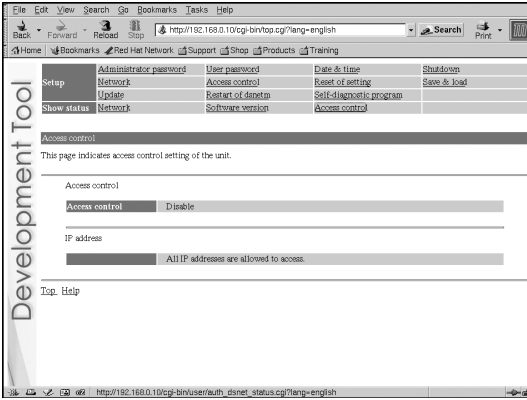

Usage notice

For this product, the debugger (dstdb) reset command cannot be used when the power/hold switch of the controller is in the hold position. Make sure that the controller’s power/hold switch is not in the hold position when operating the debugger.

Appendices

Troubleshooting

The power does not turn on.

- Check that the AC adaptor and the AC power cord are securely connected.

The unit cannot be accessed over the network while in use.

- Check that the power indicator lights up in green to verify that the unit is turned on.
- Check that the network cable is securely connected.
- Check that the unit's settings have not been changed by other PCs. Contact your network administrator for assistance.

When network settings are modified, the unit can no longer be accessed.

- The network setting may not be correct.
Check the settings displayed on the connected controller. If no settings are displayed on the controller, disconnect and reconnect the power. The settings will then be displayed on the controller.

About checking settings

Check that you can access the currently connected network using the values for IP address/subnet mask that have been configured. For details, please consult your network administrator.

To check whether the development computer and the unit are correctly communicating, start the ping command from the development computer. For details regarding the use of the ping command, see the “About the ping command” section below, or refer to the instruction manual supplied with the development computer.

Also, by pressing the network initialise button, you can return the IP address settings to their factory default state.

About the ping command

If your development PC's operating system supports the “ping” command, enter the ping command as shown below.

```
# ping (the IP address of the unit)
```

When network communications are functioning, you will see information like the following at a fixed interval:

```
PING 192.168.0.10 (192.168.0.10): 56(84) data bytes
64 bytes from 192.168.0.10: icmp_seq=0
ttl=64 time=0.1 ms
64 bytes from 192.168.0.10: icmp_seq=1
ttl=64 time=0.1 ms
64 bytes from 192.168.0.10: icmp_seq=2
ttl=64 time=0.1 ms
(continued below)
```

When network communications are not functioning, the information will stop after the following:

```
PING 192.168.0.10 (192.168.0.10): 56 data bytes
```

If the display appears as shown above, check the following items:

- Is the network cable securely connected to the network connector on the unit?
- Is the network cable securely connected to the hub?
- Is the network cable securely connected to the development PC?
- Do the network settings of the development PC match those of the unit?

After checking the above items, start the ping command from the development PC. Then check the indicator next to the network connector on the rear of the unit.

- When the indicator flashes orange:
The communications are functioning properly.
- When the indicator is not turned on:
The communications are not functioning properly. This may be due to disconnected cables, damaged connections, or a unit malfunction.

The unit cannot be accessed, even though five minutes have elapsed since it was turned on.

→ Check that the power indicator lights up in green.

If so,

there may be a problem with the network cable or the connected hub. Change the network cable or hub, or contact your network administrator for assistance.

Wireless LAN communications are not working properly.

→ High-frequency noise from the controller may be affecting network communications. Try moving the controller away from the unit's aerial. Also try adjusting the position of the aerial or moving the unit to a different location.

Specifications

Main unit (DTP-T1000 A)

Compatible discs

CD-ROM / CD-R / DVD-ROM / DVD-R /
UMD™

Power

Input voltage DC IN 19.5V
Power consumption 5A

Operating environment

Operating temperature 10°C - 35°C
Operating humidity 30% - 70%
(not condensed)

Dimensions (excluding protrusions)

Development tool 100 x 280 x 298 mm
Controller 170 x 74 x 23 mm
(w/h/d)

Weight

Development tool 5.0 kg or less
Controller Approx. 470 g
(including cables)

Processor

Dedicated processor (max 333 MHz)

Built-in memory

64 MB (fixed)

Built-in peripherals

Communication processor (300 MHz)

External interfaces

USB connector x 1
Memory Stick Duo™ slot x 1
Controller connector x 1
Foot switch connector x 1
Headset connector x 1
RF (extension) connector x 1
Aerial x 1
(For wireless LAN IEEE 802.11b)
Network connector x 1
(100 BASE-TX/10 BASE-T)
VGA connector x 1
(Analog RGB, D-SUB, 15-pin)

AUDIO OUT (audio output) connector x 1
(RCA pin)

Dedicated connector for servicing x 1
(For use by service personnel only.)

Extension connector x 1
(Devices other than those designated
cannot be used.)

Wireless LAN channels

USA and Canada 1-11 ch.
Europe 1-13 ch.

AC adaptor (DTP-H100)

Power

Input voltage AC 100 - 240V (±10%)
Output voltage DC 19.5 V
Rated frequency 50/60Hz (±2%)
Power consumption 1.6A (100V), 0.7A
(240V)

External dimensions

160 x 38 x 80 mm
(w/h/d)

Weight

Approx. 570 g

Supplied accessories

Instruction manual x 1
AC power cord for use in Oceania x 1
AC power cord for use in Europe x 1
AC power cord for use in Korea x 1
AC power cord for use in the UK x 1
AC power cord for use in the USA and
Canada x 1
AC adaptor x 1
Controller x 1
(With controller-interface cable [1.5 m])
Foot switch [1.9 m] x 1
RFI filter for use in Europe, Oceania and
Korea x 1
Fitting band for use in Europe, Oceania and
Korea x 1

**Design and specifications are subject to
change without notice.**

R&TTE Directive "Informal DoC" statement

For customers in Europe

Language	"Informal DoC"
Danish	Undertegnede Sony Computer Entertainment Inc. erklærer herved, at følgende udstyr DTP-T1000 overholder de væsentlige krav og øvrige relevante krav i direktiv 1999/5/EF. For yderligere information gå ind på følgende hjemmeside: http://www.compliance.sony.de/
Dutch	Hierbij verklaart Sony Computer Entertainment Inc. dat het toestel DTP-T1000 in overeenstemming is met de essentiële eisen en de andere relevante bepalingen van richtlijn 1999/5/EG. Nadere informatie kunt u vinden op: http://www.compliance.sony.de/
English	Hereby, Sony Computer Entertainment Inc. declares that this DTP-T1000 is in compliance with the essential requirements and other relevant provisions of Directive 1999/5/EC. For details, please access the following URL: http://www.compliance.sony.de/
Finnish	Sony Computer Entertainment Inc. vakuuttaa täten että DTP-T1000 tyyppinen laite on direktiivin 1999/5/EY oleellisten vaatimusten ja sitä koskevien direktiivin muiden ehtojen mukainen. Halutessasi lisätietoja, käy osoitteessa: http://www.compliance.sony.de/
French	Par la présente Sony Computer Entertainment Inc. déclare que l'appareil DTP-T1000 est conforme aux exigences essentielles et aux autres dispositions pertinentes de la directive 1999/5/CE. Pour toute information complémentaire, veuillez consulter l'URL suivante: http://www.compliance.sony.de/
German	Hiermit erklärt Sony Computer Entertainment Inc. dass sich dieser/diese/dieses DTP-T1000 in Übereinstimmung mit den grundlegenden Anforderungen und den anderen relevanten Vorschriften der Richtlinie 1999/5/EG befindet. Weitere Informationen erhältlich unter: http://www.compliance.sony.de/
Greek	Με την παρούσα η Sony Computer Entertainment Inc. δηλώνει ότι DTP-T1000 συμμορφώνεται προς της ουσιώδεις απαιτήσεις και της λοιπές σχετικές διατάξεις της οδηγίας 1999/5/EK. Για λεπτομέρειες παρακαλούμε όπως ελέγξετε την ακόλουθη σελίδα του διαδικτύου: http://www.compliance.sony.de/
Italian	Con la presente Sony Computer Entertainment Inc. dichiara che questo (DTP-T1000) è conforme ai requisiti essenziali ed alle altre disposizioni pertinenti stabilite dalla direttiva 1999/5/CE. Per ulteriori dettagli, si prega di consultare il seguente URL: http://www.compliance.sony.de/
Portuguese	Sony Computer Entertainment Inc. declara que este DTP-T1000 está conforme com os requisitos essenciais e outras provisões da Directiva 1999/5/CE. Para mais informacoes, por favor consulte a seguinte URL: http://www.compliance.sony.de/
Spanish	Por medio de la presente Sony Computer Entertainment Inc. declara que el (DTP-T1000) cumple con los requisitos esenciales y cualesquiera otras disposiciones aplicables o exigibles de la Directiva 1999/5/CE. Para mayor información, por favor consulte el siguiente URL: http://www.compliance.sony.de/
Swedish	Härmed intygar Sony Computer Entertainment Inc. att denna DTP-T1000 står i överensstämmelse med de väsentliga egenskapskrav och övriga relevanta bestämmelser som framgår av direktiv 1999/5/EG. För ytterligare information gå in på följande hemsida: http://www.compliance.sony.de/

Limitations of liability

This product is supplied pursuant to and subject to the terms of the tool loan agreement with Sony Computer Entertainment Inc. or its affiliates. Other than as expressly set forth by SCEI and/or any of its affiliates, except to the extent prohibited by applicable laws, SCEI and/or any of its affiliates shall not be liable for any damages, including special, incidental or consequential damages, or fees arising out of the use or inability to use this product.



Appendices

This product may fall within the scope of national export control legislation.
You must comply fully with the requirements of such legislation and of all other applicable laws of any jurisdiction in relation to this product.

Contact information:



Japan

3rd Party Relations Division
Sony Computer Entertainment Inc.
7-1-1 Akasaka, Minato-ku,
Tokyo 107-0052 Japan
TEL: +81-3-6438-8635 (direct)

Korea

Technology Group
Sony Computer Entertainment Korea Inc.
14Fl. Koosan Tower, 3250, Bangbae2-Dong
Seocho-Gu, Seoul, #137-853 Korea
E-mail: psp_support@scek.co.kr
TEL: +82-2-6230-3596 (direct)



United Kingdom (Europe)



Technology Group
Sony Computer Entertainment Europe
25 Golden Square
London W1F 9LD UK
TEL: +44-207859-5777 (direct)
<http://www.scee.sony.co.uk/>

USA

Developer Support
Sony Computer Entertainment America
919 East Hillsdale Boulevard, 2nd Floor
Foster City, CA 94404-2175 USA
TEL: +1-650-655-5566 (direct)
FAX: +1-650-655-5511 (direct)

Without obtaining the consent of the owner, no part of the content of this document may be copied, pursuant to the provisions of the Copyright Act.

“” is a registered trademark and “” and “UMD” are trademarks of Sony Computer Entertainment Inc.

“SONY” and “” are registered trademarks and “Memory Stick Duo”, “Memory Stick PRO Duo” and “” are trademarks of Sony Corporation.