

Digital Wireless Transmitter

Operating Instructions

DWT-P01N

DWX **WiDIF-HP**
DIGITAL WIRELESS  Cross Remote

Table of Contents

Features	3
Parts Identification	4
Power Supply	6
Installing the batteries	6
Setting the Transmission Channel	6
Selecting the group/channel	6
Using the Cross Remote	7
Pairing with a receiver	7
Using the Encrypted Transmission Function	8
Using secure key mode (SECURE KEY)	8
Using password mode (PASSWORD)	9
Using a USB Keyboard	10
Basic Menu Operations	10
Setting Menus	11
Naming of transmitter (NAME)	11
Selecting the frequency band (BAND)	11
Selecting the group/channel (GP/CH)	11
Setting the RF output power (RF POWER)	11
Setting the audio input level (INPUT LEVEL) ...	12
Low-cut filter setting (LCF)	12
Power save setting (POWER SAVE)	12
Setting the battery type (BATTERY TYPE)	12
Displaying the accumulated use time (TIME)	12
+48 V power supply setting (+48V)	13
Setting the encrypted transmission function (ENCRYPTION)	13
Setting the audio codec mode (CODEC MODE)	13
Setting the maximum RF output power (MAX RF POWER)	13
Generating an internal signal (INTERNAL SG)	13
Locking the POWER switch (POWER SW LOCK)	14
Cross Remote (RF REMOTE)	14
Setting the brightness of the display (BRIGHTNESS)	14
Automatic dimming of the display (DIMMER MODE)	14
Resetting parameters to their factory settings (FACTORY PRESET)	14
Displaying the software version (VERSION)	14
Block Diagram	15
Troubleshooting	16
Important Notes on Operation	17
Notes on using the transmitter	17
On cleaning	17
Specifications	18
Carrier Frequencies and Channel Steps	19

Features

The DWT-P01N is a digital wireless transmitter for a UHF synthesized wireless microphone system to be used for broadcast or movie production purpose. This transmitter is suitable for Electronic News Gathering (ENG).

What is DWX?

DWX refers to Sony's new digital wireless microphone system. The DWX series reflects Sony's extensive expertise in professional microphones and sound design. It represents a successful blend of Sony know-how, wireless technology renowned for stability, and cutting-edge digital audio technology.

In addition to realizing the high sound quality possible with a digital system, the DWX series supports multi-channel simultaneous operation, encrypted transmission, and metadata transmission for monitoring the status of multiple transmitters. Using a main link and a separate additional link, remote control of transmitters from the receiver is also possible. With its many advanced features, the system has the potential to revolutionize the workflow of professional applications.

What is WiDIF-HP?

WiDIF-HP (WiDIF: Wireless Digital Interface Format, HP: High Profile) is a wireless digital audio interface format developed by Sony.

It enables highly secure transmission with high sound quality and low system latency, and supports simultaneous multi-channel operation.

What is Cross Remote?

Cross Remote is a system that allows transmitters to be monitored and controlled from a receiver and the Wireless Studio control software installed on a computer connected to the receiver.

For example, the settings of a transmitter worn under clothing can be easily changed over the wireless link.

Wide RF carrier frequency range

The DWT-P01N transmitter covers an extremely wide RF carrier frequency range. Depending on the model, the transmitter can cover bandwidths between 48-MHz and 72-MHz (e.g., 72-MHz with the CE4248¹⁾) — much wider than 24-MHz of the analog wireless microphone system. This remarkably wide coverage on a single model offers cost efficiency and operational convenience, because it allows one transmitter to be operated in many different areas.

¹⁾ Carrier frequencies differ depending on the model.

Switchable mic or line input level and adjustable attenuator

For details, see “Setting the audio input level (INPUT LEVEL)” on page 12.

Three audio codec modes

Switch between audio codec modes based on your operational needs.

For details, see “Setting the audio codec mode (CODEC MODE)” on page 13.

Switchable RF output power

For details, see “Setting the RF output power (RF POWER)” on page 11 and “Setting the maximum RF output power (MAX RF POWER)” on page 13.

Power sleep mode

For details, see “Power save setting (POWER SAVE)” on page 12.

Digital low-cut filter

For details, see “Low-cut filter setting (LCF)” on page 12.

Easy-to-see, full dot-matrix OLED (Organic Light-Emitting Diode) Display

The quick response of the OLED display enables real-time operating conditions to be displayed clearly and accurately.

+48 V power supply for a microphone

For details, see “+48 V power supply setting (+48V)” on page 13.

Parts Identification

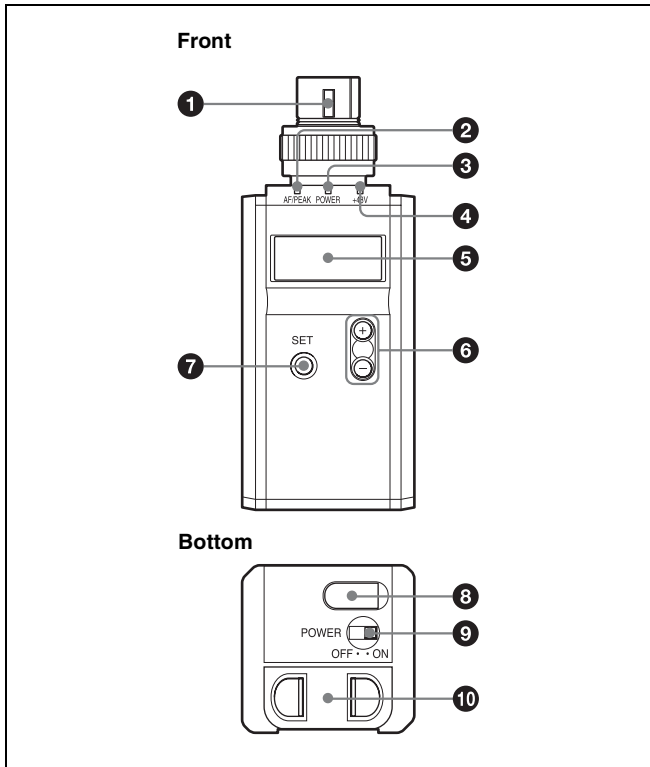

1 Audio input connector (XLR-3-11C)
Connects a microphone with an XLR-3-12C-type output connector or an audio cable with an XLR-3-12C-type connector.

Caution

Be sure that the transmitter is turned off before connecting a microphone or cable to the transmitter.

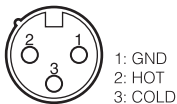

To connect a microphone or a cable

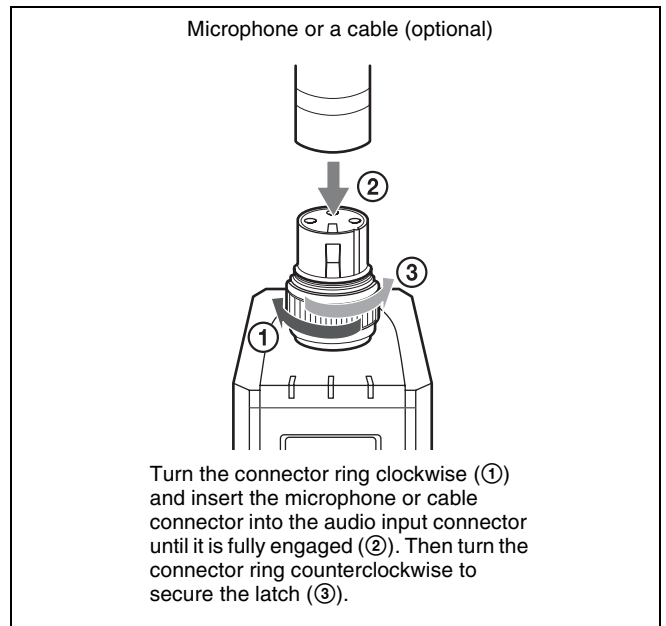

2 AF (audio input level) / PEAK indicator
Lights up green when the signal input is stronger than the reference level.
Lights up red when the signal input is 3 dB below the level at which distortion begins.

3 POWER indicator
Lights up green when the transmitter is turned on. When the battery is exhausted, the indicator starts flashing.

4 +48V indicator
Lights up when INPUT LEVEL is set to MIC and +48 V power is being supplied to a connected microphone or other device.

5 Display section

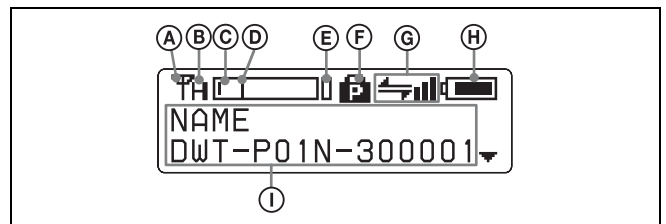

A RF (radio frequency) transmission indication
Indicates the current transmission status.
☐: Currently transmitting
—: Transmission stopped

B RF (radio frequency) transmission power indication
Indicates the current transmission power setting. You can change the setting with the RF POWER function.
H: Transmitting at 50 mW
M: Transmitting at 10 mW
L: Transmitting at 1 mW

C Audio input level meter
Indicates the input signal level.

Ⓓ Reference level gauge

Indicates the reference input level. When the attenuation is 0 dB with INPUT LEVEL set to MIC, -58 dBu (-60 dBV) is indicated. When LINE is selected for INPUT LEVEL, +4 dBu is indicated.

Ⓔ Peak indicator

Warns of excessive input by lighting up when the signal is 3 dB below the level at which distortion begins.

Ⓕ POWER switch lock indicator

Indicates that the POWER switch is locked, preventing the transmitter from being accidentally turned off or on.

For details, see “Locking the POWER switch (POWER SW LOCK)” on page 14.

Ⓖ Cross Remote condition indication

Indicates the signal transmission condition of the wireless remote control function (4 levels).

 : Good transmission

 : Somewhat good transmission

 : Somewhat poor transmission

 : Poor transmission

 : Unable to communicate with paired receiver

When the wireless remote control function is off, this indication does not appear.

Ⓗ Battery indication

Shows the battery condition.

For details, see “Battery indication” on page 6.

Ⓘ Menu display section

The status of 20 different functions are displayed here. To select the function, press the + or – button repeatedly.

For details, see “Setting Menus” on page 11

Ⓖ + or – button

Selects functions or values shown on the display. Holding down the – button while switching on the transmitter activates the pairing operation for the wireless remote control function.

Ⓙ SET button

Adjusts displayed function settings and enters the value. Holding down the SET button while switching on the power turns the transmitter on without sending a signal.

Ⓚ USB connector (Micro USB)

Use this connector to connect an optional USB keyboard to carry out menu functions using key operations. By connecting the digital wireless receiver to this connector using a USB cable (not supplied) and the USB adapter cable (supplied), you can exchange the encryption key for encrypted transmission function.

Ⓛ POWER switch

Turns the transmitter ON or OFF.

Ⓜ Battery compartment

Accommodates two LR6 (size AA) alkaline batteries.

For details on how to insert the batteries, see “Power Supply” on page 6.

Power Supply

The transmitter can operate on two LR6 (size AA) alkaline batteries continuously for about 5.0 hours at 25 °C (77 °F).

Installing the batteries

- 1 Squeeze the battery-holder tabs inward (in the direction of the arrows) and slide out the battery holder.

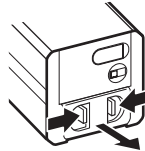

- 2 Insert new batteries, making sure the polarities are correct, and then return the battery holder to its original position.

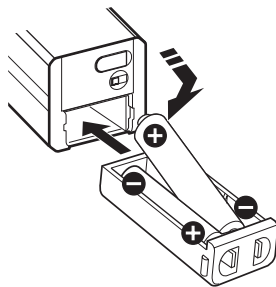

Battery indication

The power status is indicated by eight level indications. Replace both batteries when the battery indication starts to flash.

Be sure to check the expiration date printed on the new batteries before using them.

Notes

- When BATTERY TYPE is set to TYPE1, the power status is indicated based on the use of new LR6 (size AA) Sony Alkaline batteries. An incorrect indication may result when a different kind of batteries, a different brand of batteries or old batteries are used. If you plan to use other kind of batteries than alkaline, set the BATTERY TYPE function according to the type of batteries to be used.
- If you plan to use the transmitter for a long period of time, it is recommended that you replace the batteries with brand new ones.

For details on BATTERY TYPE setting, see “Setting the battery type (BATTERY TYPE)” on page 12.

Setting the Transmission Channel

The transmitter provides groups of interference-free channels. When using multiple microphones and transmitters at the same time (simultaneous multi-channel operations) within the same area, selecting the same group and using a channel within that group can prevent signal interference.

To set the transmission channel on the transmitter, first you select the group and channel using the RF indicator and scanning functions on the receiver. Next you set the group and channel parameters to match the setting on the receiver.

Notes

- Certain transmission channels cannot be used with the wireless remote control function.
- “(INCOMPATIBLE WITH RF REMOTE)” will slide across the display during group/channel selection for transmission channels that cannot be used with the wireless remote control function.
- When a transmission channel that cannot be used with the wireless remote control function is selected, “RESTRICTED BY GP/CH SETTING” appears on the RF REMOTE screen and the wireless remote control function cannot be used. When using the wireless remote control function, select transmission channels for which “(INCOMPATIBLE WITH RF REMOTE)” does not appear during group/channel selection.

Selecting the group/channel

Notes

- Before doing this procedure, use the BAND function (see page 11) to set the transmitter to the bandwidth of the receiver you are using.
- The setting for this function cannot be changed during actual signal transmission.

Set the transmitter group (GP) and channel (CH) as follows:

For details on groups and channels, refer to “Sony Digital Wireless Microphone System Frequency Lists” on the supplied CD-ROM.

For details on menu operation, see “Basic Menu Operations” on page 10.

- 1 Turn off the power, and then while holding down the SET button, turn the power on.

The signal transmission stops.

- 2 Press the + or – button repeatedly until the GP/CH indication is displayed.

- 3 Hold down the SET button until the group indication flashes.
- 4 Press the + or – button repeatedly to select a group.
- 5 Press the SET button to enter the group.
The channel indication starts flashing.
- 6 Press the + or – button repeatedly to select a channel.
- 7 Press the SET button to enter the channel.

Note

To start signal transmission with the selected channel, turn off the power and then turn it on again.

To set the group/channel using the pairing mode of the Cross Remote

When the transmitter is paired with the receiver, the transmission channel of the transmitter is set to the receiving channel on the receiver automatically.

For details, see “Pairing with a receiver” on page 7.

Using the Cross Remote

This transmitter is equipped with a wireless remote control function that can be used to set the parameters (low-cut filter, attenuation operation, power save mode, etc.) of the transmitter through the receiver or other devices. This function makes it easier to operate and manage the microphone system while in the field.

This wireless control is 2.4-GHz IEEE802.15.4 compliant and has no effect on the RF band of digital wireless audio. This function is activated when pairing is established between the transmitter and the receiver using the RF REMOTE function.

Pairing must be done first before the wireless remote control function can be used.

Note

If “RESTRICTED BY GP/CH SETTING” appears on the RF REMOTE screen, the wireless remote control function cannot be used. To use the wireless remote control function, select a different transmission channel.

For details on how to change the transmission channel, see “Setting the Transmission Channel” on page 6.

Pairing with a receiver

Pairing links the transmitter with the receiver for which the wireless remote control function is to be used.

When the transmitter has been paired with a receiver through the receiver operation, turning on the transmitter while holding down the – button establishes the pairing immediately.

To carry out pairing through menu operations on the transmitter, do the following.

- 1 Set the receiver to be used for controlling the transmitter to pairing mode.
For details, refer to the operating instructions supplied with the receiver.
- 2 Press the + or – button repeatedly until the RF REMOTE indication is displayed.
- 3 Hold down the SET button until the item to be set flashes.
- 4 Press the + or – button repeatedly to select PAIRING.
- 5 Press the SET button to enter.

The transmitter sends a pairing request to the receiver which is on pairing mode.

Before established pairing, if you press any operation key on the transmitter, pairing mode will be cancelled. When pairing has been established, the wireless remote control condition level (indicated by )

goes up, the RF REMOTE function turns on, and the remote control function becomes operative.

To use the Cross Remote with a previous pairing

In the RF REMOTE indication, select ON.

Notes

- When you set RF REMOTE to ON, the transmitter will communicate with the receiver to which it was previously paired. To use the wireless remote control function with another receiver, you must perform the pairing procedure for that receiver.
- Multiple transmitters cannot be paired with the same receiver.
- If you reset all parameters by using the FACTORY PRESET function (*see page 14*), the pairing setting of the transmitter is also cleared.

The following transmitter settings can be done from the remote control:

- Transmitter name setting
- Frequency band/group/channel selection
- RF transmission power setting
- MIC/LINE setting and attenuator setting for audio input level
- Low-cut filter setting
- Power save setting
- +48 V power supply setting
- Resetting accumulated use time
- Audio codec mode setting
- Internal signal setting
- POWER switch lock setting

For details on menu operation, see “Setting Menus” on page 11.

To perform remote control, the receiver must be equipped with a control function for the setting you want to control. For details, refer to the operating instructions supplied with the receiver.

To cancel the Cross Remote

In the RF REMOTE indication, select OFF.

Notes on the Cross Remote

The wireless remote control function on the transmitter uses the 2.4-GHz band and may thus be subject to interference from other devices.

- When pairing fails (“Pairing fail” is displayed), successful communication between the transmitter and the receiver has not occurred within a given amount of time. Pairing may be harder to do when another receiver is engaged in pairing nearby.
- When it becomes hard to use the remote control, the remote control may be improved by switching the wireless remote control function off, then on again in the RF REMOTE indication, then re-pairing with the transmitter (change to a channel with less interference).

Using the Encrypted Transmission Function

To prevent hacking of the signal, the transmitter scrambles the signal during transmission. To use this function, select one of the following encrypted transmission modes:

Secure key mode: An encryption key that is automatically generated by the transmitter is used by both the transmitter and receiver in this one-to-one encrypted transmission method.

Password mode: You choose a password of up to eight characters that can be set for multiple transmitters and receivers. This enables encrypted transmission within a group.

Note

Make sure the same mode is set on the transmitter and receiver.

Using secure key mode (SECURE KEY)

Use this mode for one-to-one encrypted transmission between one transmitter and one receiver.

An encryption key that cannot be read from the outside is automatically generated by the transmitter. This key is transmitted to the receiver through a USB connection or the RF REMOTE function, enabling encrypted transmission to take place.

The encryption key used by the transmitter and receiver is newly generated for each key transmission, resulting in highly secure communication.

The encryption key used between the transmitter and the receiver is saved when the power is turned off, so the encrypted transmission can be resumed the next time the power is turned on.

1 Preparing the transmitter (this unit)

- ① Hold down the SET button until the item to be set flashes in the ENCRYPTION indication on the transmitter.
- ② Press the + or – button repeatedly to select SECURE KEY, and then press the SET button.

2 Preparing the receiver

Select SECURE KEY on the receiver that receives the encryption key.

For details on receiver operations, refer to the operating instructions supplied with the receiver.

3 Exchanging the encryption key

On the receiver, select USB or REMOTE (wireless remote) as the method for encryption key exchange.

When the RF REMOTE function is off, REMOTE cannot be selected.

Note

When the receiver does not support encryption key exchange through USB connection, select REMOTE.

When you select USB:

Connect the transmitter to the receiver using a USB cable (not supplied) and the USB adapter cable (supplied).

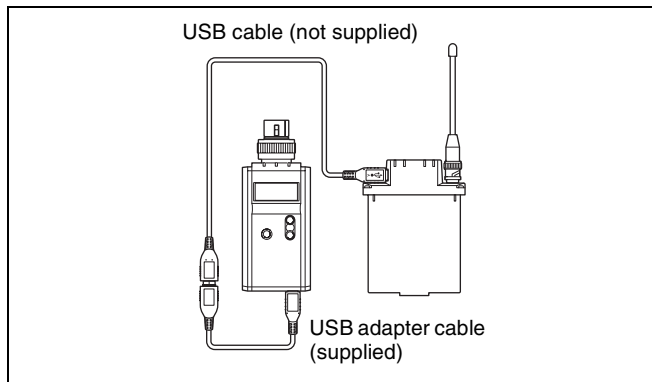

For details on receiver operations, refer to the operating instructions supplied with the receiver.

When you select REMOTE:

The transmitter searches for a receiver that it has been paired with. After the transmitter detects the receiver, the transmitter exchanges the encryption key with receiver and encrypted transmission begins.

- 5 Set the same password that was set on the transmitter.

For details on receiver operations, refer to the operating instructions supplied with the receiver.

Note

It is recommended that you change the password periodically.

Using password mode (PASSWORD)

Set this mode when multiple transmitters are paired with multiple receivers for encrypted transmission.

If both transmitters and receivers are set with the same user-designated password, the audio signal can be decoded. This mode is useful when multiple transmitters and receivers are used as a single group, or when the audio signal from one transmitter is received by multiple receivers at the same time.

- 1 Hold down the SET button until the item to be set flashes in the ENCRYPTION indication on the transmitter.
- 2 Press the + or – button repeatedly to select PASSWORD, and then press the SET button.
- 3 Input a password of up to eight characters on the transmitter.

To enter a password, use the procedure described in “Naming of transmitter (NAME)” on page 11.

- 4 Set the encrypted transmission function setting on the receiver to PASSWORD.

Using a USB Keyboard

Connecting an optional USB keyboard to the transmitter allows you to perform menu operations and enter your name and password for the encrypted transmission function from the keyboard.

A Micro USB connector is used on the transmitter. For this reason, use the supplied USB adapter cable.

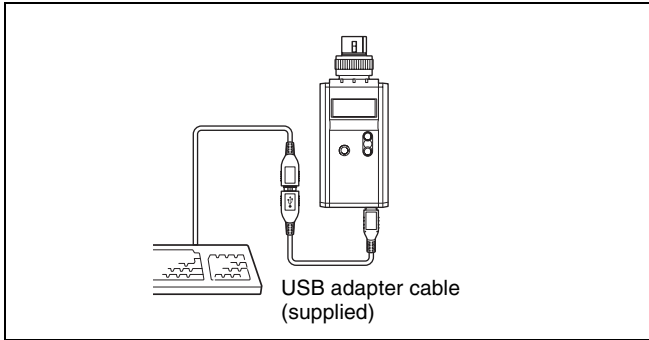

Menu operations with a USB keyboard

You can use a USB keyboard to perform the same menu operations that you do on the transmitter.

The transmitter buttons correspond to the following keys on a USB keyboard:

Buttons on the transmitter	USB keyboard
SET	ENTER
+	↑
-	↓

To enter a text

With a USB keyboard, you can enter names and passwords for encrypted transmissions.

Characters that can be entered from a USB keyboard:

(space), 0, 1, 2, 3, 4, 5, 6, 7, 8, 9, A, B, C, D, E, F, G, H, I, J, K, L, M, N, O, P, Q, R, S, T, U, V, W, X, Y, Z, !, #, &, \$, @, +, -, =, _, (,), [,]

(Passwords may consist of the numbers 0 to 9 and letters A to Z only.)

Special key: Backspace (BS) and Delete (DEL) keys.

Notes

- The number keys on the keyboard cannot be used.
- This transmitter is compatible with English-language keyboards only.
- USB keyboards with multiple functions, such as USB hub and pointing device, cannot be used.
- Power to the connected keyboard is supplied by the USB connector on the transmitter. The power rating is 100 mA. Keyboards that consume more power than that cannot be used.
- Do not leave the transmitter connected to the keyboard when not in use. If you do, the batteries in the transmitter will be drained more quickly.
- Text editing should be done with the alphabet, BS, DEL, and Enter keys.

Basic Menu Operations

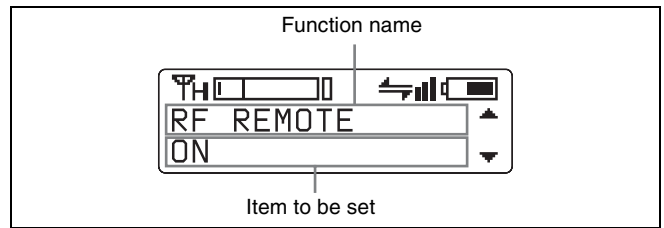

- 1 Press the + or - button repeatedly until the function to be set appears.
- 2 Hold down the SET button until the item to be set flashes.
- 3 Press the + or - button to change the setting.
- 4 Press the SET button to enter the setting.

Types of menu:

- NAME (transmitter name) setting
- BAND (frequency band) selection
- GP/CH (group/channel) selection
- RF POWER (RF transmission power) setting
- INPUT LEVEL (audio input level) setting
- LCF (low-cut filter) setting
- POWER SAVE setting
- BATTERY TYPE (battery type) setting
- TIME (accumulated use time) indication
- +48V (+48 V power supply) setting
- ENCRYPTION (encrypted transmission function) setting
- CODEC MODE (audio codec mode) setting
- MAX RF POWER (maximum RF output power) setting
- INTERNAL SG (internal signal generator)
- POWER SW LOCK (POWER switch lock) function
- RF REMOTE (wireless remote control) function
- BRIGHTNESS (display brightness) setting
- DIMMER MODE (automatic dimming of the display) setting
- FACTORY PRESET (factory setting) function
- VERSION (software version) indication

Setting Menus

The functions and parameters of the settings menu are explained here. Underlined items are the factory setting.

Naming of transmitter (NAME)

You can specify a transmitter name of up to 16 characters. The factory setting for the transmitter name is the model name and serial number. The transmitter name is sent to the receiver as metadata and is used by the receiver to distinguish between different transmitters.

+: The first press on the + button displays the character set. You can then use the + and – buttons to select the desired character. And then, pressing the SET button adds the selected character to the end of the current name.

– : Deletes the last character in the current name.

SET: Enters the character or edited name.

Note

You cannot insert or delete a character in the middle of the name.

Using wireless remote control, this function can be controlled from the receiver and other devices.

For details on wireless remote control function, see “Using the Cross Remote” on page 7.

To edit with a keyboard

You can enter data from an optional keyboard connected to the USB connector.

For details, see “Using a USB Keyboard” on page 10.

Selecting the frequency band (BAND)

Match the frequency range on this transmitter to that of the Sony digital wireless receiver.

See “Carrier Frequencies and Channel Steps” on page 19 for differences in frequency ranges that can be set for optional receivers combined with this transmitter.

For details on the frequency range of each band, refer to “Sony Digital Wireless Microphone System Frequency Lists” on the supplied CD-ROM.

Using wireless remote control, this function can be controlled from the receiver and other devices.

For details on wireless remote control function, see “Using the Cross Remote” on page 7.

Notes

- The setting for this function cannot be changed during actual signal transmission. To change the setting, turn off the transmitter first. Then, while holding down the SET button, turn the power on. Then change the setting after the signal transmission has stopped.
- Be sure to select the group/channel right after selecting the frequency band. To start signal transmission with the selected frequency band/group/channel, turn off the power and then turn it on again.

Selecting the group/channel (GP/CH)

See “Carrier Frequencies and Channel Steps” on page 19 for factory settings.

For details, see “Selecting the group/channel” on page 6.

Using wireless remote control, this function can be controlled from the receiver and other devices.

For details on wireless remote control function, see “Using the Cross Remote” on page 7.

Setting the RF output power (RF POWER)

You can set the RF output power.

1 mW (LOW): Transmitted by 1 mW

10 mW (MID): Transmitted by 10 mW

50 mW (HIGH): Transmitted by 50 mW

Notes

- The setting for this function cannot be changed during actual signal transmission. To change the setting, turn off the transmitter first. Then, while holding down the SET button, turn the power on. And then, change the setting after the signal transmission has stopped.
- To start signal transmission with the selected RF output power setting, turn off the power and then turn it on again.

Using wireless remote control, this function can be controlled from the receiver and other devices.

For details on wireless remote control function, see “Using the Cross Remote” on page 7.

The maximum RF output power can be configured on the unit.

For details, see “Setting the maximum RF output power (MAX RF POWER)” on page 13.

Setting the audio input level (INPUT LEVEL)

You can set the input level to an analog head amp. Select LINE or MIC, depending on the audio source connected to the audio input connector.

When MIC is selected, ATT (attenuation level) will flash next. With the microphone connected, speak into the microphone as you monitor the audio input level meter and press the + or – button repeatedly to select the appropriate attenuation level.

The reference levels for the various settings are as follows:

Input	Attenuation (dB)	Reference input level (dBu)	Maximum input level (dBu)	Headroom (dB)
MIC	0	–58	–22	36
	3	–55	–19	
	6	–52	–16	
	9	–49	–13	
	3 dB steps	3 dB steps	3 dB steps	
	45	–13	+23	
	48	–10	+24	34
LINE	–	+4	+24	20

MIC/LINE settings and attenuator settings for the audio input level can be changed from the receiver and other devices via the wireless remote control function.

For details on wireless remote control function, see “Using the Cross Remote” on page 7.

Low-cut filter setting (LCF)

The frequency of the low-cut filter can be set.

OFF: Turns off the low-cut filter.

20 30 40 50 60 70 80 90 100 120 140 160 180 200 220 (Hz): Low-cut filter is set according to the selected frequency.

Using wireless remote control, this function can be controlled from the receiver and other devices.

For details on wireless remote control function, see “Using the Cross Remote” on page 7.

Power save setting (POWER SAVE)

To conserve power, this setting allows you to put all transmitter functions to sleep.

ACTIVE: The transmitter operates normally.

SLEEP: The sleep function is on. During sleep, the POWER indicator flashes at 2-second intervals.

To change back to normal operation

During sleep, press the SET, +, or – button.

You can also use the wireless remote control to change the receiver back to normal operation.

For details on wireless remote control function, see “Using the Cross Remote” on page 7.

Note

If the transmitter is turned off while SLEEP is selected, the setting will return to ACTIVE (normal operation) automatically.

Setting the battery type (BATTERY TYPE)

Set this item according to the type of batteries you use to obtain accurate battery power status indication.

TYPE1: The power status is indicated based on characteristics of new LR6 (size AA) Sony Alkaline batteries. Select this for LR6 (size AA) alkaline batteries.

TYPE2: Select this for rechargeable nickel-metal-hydrate batteries with capacities of about 2000 mAh.

TYPE3: Select this for lithium batteries.

TYPE4: Select this for rechargeable nickel-metal-hydrate batteries with capacities of about 2500 mAh.

Note

The characteristics of batteries change according to battery type and environmental conditions. It is recommended that you learn the characteristics of batteries you use before using them.

Displaying the accumulated use time (TIME)

You can display the accumulated battery use time as a rough estimate of total transmitter usage. The factory setting is “00:00”.

To reset the accumulated time indication

- 1 Hold down the SET button until the time indication flashes.
- 2 Press the – button so “00:00 RESET” appears, and then press the SET button.

Using wireless remote control, this function can be controlled from the receiver and other devices.

For details on wireless remote control function, see “Using the Cross Remote” on page 7.

+48 V power supply setting (+48V)

You can turn the +48 V power supply on or off for microphones that require an external power supply.

OFF: Power is not supplied to the connected microphone.
ON: Power is supplied to the connected microphone.

Using wireless remote control, this function can be controlled from the receiver and other devices.

For details on wireless remote control function, see “Using the Cross Remote” on page 7.

Note

The +48 V power supply can be turned on or off, regardless of INPUT LEVEL setting. Note, however, that the +48 V power is actually supplied only when INPUT LEVEL is set to MIC.

Setting the encrypted transmission function (ENCRYPTION)

You can set the encrypted transmission function.

SECURE KEY: Sets the secure key method.
PASSWORD: Sets the password method.
OFF: The encrypted transmission function is not used.

For details, see “Using the Encrypted Transmission Function” on page 8.

Setting the audio codec mode (CODEC MODE)

MODE1: This audio codec mode is compatible with the first generation DWX series.
MODE2: Delay times are reduced in this audio codec mode. Audio quality is also improved when compared to MODE1. We recommend using this mode under normal circumstances.
MODE3: This audio codec mode prioritizes stable transmission performance. Additional signal processing is used to suppress noise and audio interruptions caused by

unexpected interference, resulting in more reliable transmission.

The audio delay durations that occur when transmitting and receiving with each mode will differ depending on the receiver’s operating environment.
For details, refer to the operating instructions supplied with the receiver.

The audio codec mode setting can be configured via the wireless remote control function from the receiver, for example.

For details, see “Using the Cross Remote” on page 7.

Setting the maximum RF output power (MAX RF POWER)

You can set the maximum RF output power of the unit.
1mW MAX: Sets the maximum to 1 mW.
10mW MAX: Sets the maximum to 10 mW.
50mW MAX: Sets the maximum to 50 mW.

Notes

- The setting for this function cannot be changed during actual signal transmission. To change the setting, turn off the transmitter first. Then, while holding down the SET button, turn the power on. And then, change the setting after the signal transmission has stopped.
- To start signal transmission with the selected RF output power setting, turn off the power and then turn it on again.
- Always perform pairing after changing the maximum RF output power setting for a transmitter. If you fail to do so, configuration of RF output power settings via the wireless remote control function may become impossible.

For details on pairing, see “Using the Cross Remote” on page 7.

Generating an internal signal (INTERNAL SG)

This transmitter generates a 1-kHz reference level sine wave that can be used to adjust or check the audio level of the receiver or the system that you are using. This internal signal is outside the control of the attenuator.

1 kHz: A 1-kHz internal signal is generated.
OFF: An internal signal is not generated.

Note

If the transmitter is turned off while the reference signal function is on, the function will turn off automatically.

Using wireless remote control, this function can be controlled from the receiver and other devices.

For details on wireless remote control function, see “Using the Cross Remote” on page 7.

Locking the POWER switch (POWER SW LOCK)

The POWER switch can be locked to prevent the transmitter from being accidentally turned off or on. Even when the POWER switch is locked, all parts of the transmitter other than the POWER switch remain functional.

UNLOCK: The POWER switch is not locked.

LOCK: The POWER switch is locked.

When LOCK is selected, the POWER switch lock indicator appears in the display.

Using wireless remote control, this function can be controlled from the receiver and other devices.

For details on wireless remote control function, see “Using the Cross Remote” on page 7.

Cross Remote (RF REMOTE)

This function must be set to allow the wireless remote control function to be used between the transmitter and receiver.

OFF: Stops the wireless remote control function.

ON: Starts the wireless remote control function with the previously paired receiver.

PAIRING: Executes a new pairing.

For details, see “Pairing with a receiver” on page 7.

Note

If “RESTRICTED BY GP/CH SETTING” appears on the RF REMOTE screen, the wireless remote control function cannot be used. To use the wireless remote control function, select a different transmission channel.

For details on how to change the transmission channel, see “Setting the Transmission Channel” on page 6.

Setting the brightness of the display (BRIGHTNESS)

Ten levels of brightness can be selected for the organic light-emitting diode display.

The selectable settings are the following:

(Dark) **1 2 3 4 5 6 7 8 9 10** (Bright)

Automatic dimming of the display (DIMMER MODE)

The organic light-emitting diode display can be set to dim or turn off after a certain amount of time.

AUTO OFF: The display turns off after 30 seconds. The display goes on again when you press the SET, +, or – button.

AUTO DIMMER: The display dims after 30 seconds. The display becomes bright again when you press the SET, +, or – button.

ALWAYS ON: The display stays on at the brightness level set with the BRIGHTNESS function.

Resetting parameters to their factory settings (FACTORY PRESET)

All parameter settings can be returned to their factory settings.

Holding down the SET button until a message appears asking for confirmation. Press the + or – button repeatedly to select YES, and then press the SET button to enter. The transmitter parameters are reset to their factory settings.

Notes

- The setting for this function cannot be changed during actual signal transmission. To change the setting, turn off the power first. Then while holding down the SET button, turn the power on. Then change the setting after the signal transmission has stopped.
- To start signal transmission with the factory parameter settings, turn off the power and then turn it on again.

Displaying the software version (VERSION)

The version of the transmitter software can be displayed.

Block Diagram

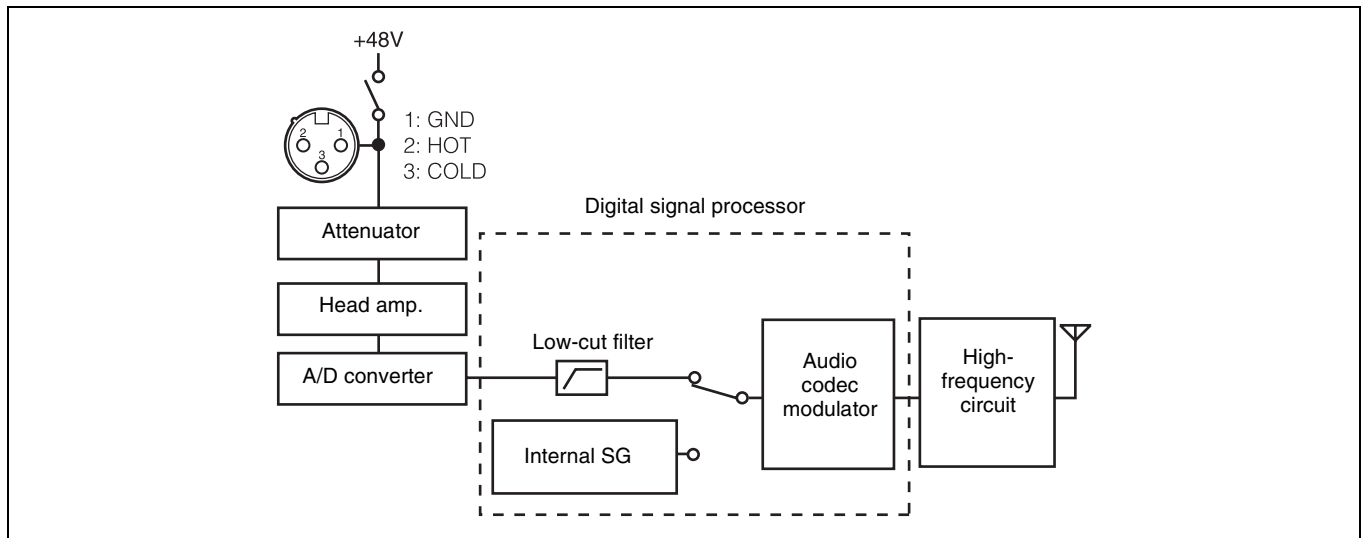

Troubleshooting

If you encounter a problem using this transmitter, use the following checklist to find a solution. For any problems with the receiver or adapter, refer to the operating instructions supplied with the respective device. If the problem persists, consult your Sony dealer.

Symptom	Meanings	Remedy
The transmitter does not turn on.	The batteries are inserted backwards in the battery compartment.	Reinsert the batteries with the correct orientation.
	The batteries are exhausted.	Replace the batteries with new ones.
The batteries drain quickly.	Manganese batteries are being used.	Use alkaline batteries.
	The transmitter is being used under cold conditions.	The batteries drain quickly under cold conditions.
Interruptions in the reception occurs.	The transmitter is too far from the receiver.	Decrease the distance to the receiver and check the reception.
	The RF output power setting is set to 1 mW (LOW).	Increase the RF output power.
There is no sound.	The channel setting on the transmitter is different from that on the receiver.	Use the same channel setting on both the transmitter and receiver.
	The setting of the encrypted transmission function on the receiver is different from that on the transmitter.	Confirm that the setting of the encrypted transmission function is the same on both the transmitter and the receiver.
	The audio codec mode settings on the receiver and transmitter do not match.	Configure the same audio codec mode setting for both the receiver and transmitter (<i>see page 13</i>).
The sound is weak.	The audio input level of the transmitter is set to LINE or the attenuation level is too high.	If a microphone is connected to the transmitter, set the audio input to MIC. While monitoring the audio input level meter, set the attenuator to an appropriate level.
There is distortion in the sound.	The attenuator is set too low for the audio input level of the transmitter.	While monitoring the audio input level meter, set the attenuator to a level that does not produce distortion.
The bass is weak.	The frequency of the low-cut filter is set too high.	While monitoring the sound, decrease the low-cut filter frequency to a level that produces the proper sound quality.
There is too much bass.	The microphone connected to the transmitter produces excessive bass because the frequency response of the transmitter extends into the low 20-Hz range.	Use the low-cut filter to cut the bass.
The power does not turn off even though the POWER switch is turned to OFF.	The POWER switch is locked.	Turn off the POWER switch locking function.
Wireless remote control is not possible.	Pairing has not been established between the transmitter and receiver.	Carry out pairing (<i>see page 7</i>).
	The receiver is too far from the transmitter for communication to occur.	Check the wireless remote control condition level. If it is low, decrease the distance between the transmitter and the receiver.
	The transmitter that was paired with the receiver has been paired with another receiver.	On the receiver, carry out pairing again with the transmitter that you want to control.
The USB keyboard does not work.	You are using a USB keyboard that is not compatible with the transmitter.	Check the conditions for using a USB keyboard with the transmitter (<i>see page 10</i>).
The display is too dark.	The display brightness is set to low.	Adjust the brightness of the display (<i>see page 14</i>).
The RF output power cannot be configured.	The maximum RF output power function may be set to limit the RF output power.	Check and adjust the setting.

Important Notes on Operation

Notes on using the transmitter

- The digital wireless microphone system product must be used within a temperature range of 0 °C to 50 °C (32 °F to 122 °F).
- Operating the transmitter near electrical equipment (motors, transformers, or dimmers) may cause it to be affected by electromagnetic induction. Keep the transmitter as far from such equipment as possible.
- The presence of the lighting equipment may produce electrical interference over the entire frequency range. Position the transmitter so that interference is minimized.
- To avoid degradation of the signal-to-noise ratio, do not use the transmitter in noisy places or in locations subject to vibration, such as the following:
 - near electrical equipment, such as motors, transformers or dimmers
 - near air conditioning equipment or places subject to direct air flow from an air conditioner
 - near public address loudspeakers
 - where adjacent equipment might knock against the tunerKeep the transmitter as far from such equipment as possible or use buffering material.

On cleaning

- If the transmitter is used in a very humid or dusty place or in a place subject to an active gas, clean its surface as well as the connectors with a dry, soft cloth soon after use. Lengthy use of the transmitter in such places or not cleaning it after its use in such places may shorten its life.
- Clean the surface and the connectors of the transmitter with a dry, soft cloth. Never use thinner, benzene, alcohol or any other chemicals, since these may mar the finish.

Notes on simultaneous multi-channel operation

- Keep the microphone at least 30 cm (11 ⁷/₈ inches) away from another transmitter/microphone. When the distances between transmitters need to be closer than the distances above, use a grouping system for multi-channel systems that include both digital wireless and analog wireless devices.

For details, refer to “Sony Digital Wireless Microphone System Frequency Lists” on the supplied CD-ROM.

- When only digital wireless microphones are being used, keep the transmitter at least 4 meters (13 feet) away from the antenna of a receiver for up to 10 channels, and at least 6 meters (20 feet) away for 11 or more channels.
- When a mixture of digital and analog wireless microphones is being used, keep the transmitter at least 6 meters (20 feet) away from the antenna of a receiver.
- This system should be kept at least 100 meters (328 feet) away from any analog wireless systems using the same frequency when both are being used in a wide area with no walls or obstructions.
- If you experience noise, increase the distance between the transmitter and receiver or decrease the transmission power on the transmitter.

Note on microphone and transmitter combinations

It is recommended that you use the Sony ECM-673/9X, ECM-674/9X, or ECM-678/9X Electret Condenser Microphone with this transmitter. The transmission signal may cause noise on some microphones. If you experience noise, you may be able to reduce it by lowering the transmission power.

To prevent electromagnetic interference from portable communication devices
--

The use of portable telephones and other communication devices near the DWT-P01N may result in malfunction and interference with audio signals. It is recommended that portable communication devices near the DWT-P01N be turned off.
--

Specifications

Transmitting section

Oscillator type	Crystal-controlled PLL synthesizer
RF power output	1 mW/10 mW/50 mW (e.r.p) selectable
Occupied RF bandwidth	192 kHz or less
Audio delay	MODE1: 1.5 ms MODE2: 1.0 ms MODE3: 2.1 ms
Allowable deviation of transmission frequency	±6.5 ppm
Type of emission	G1E or G1D
Modulation method	$\pi/4$ Shift QPSK

Audio section

Maximum input level	MIC: -22 dBu (with 0 dB attenuator) LINE: +24 dBu
Audio attenuator adjustment range (pad)	0 dB to 48 dB (3-dB steps, MIC input mode only)
Microphone input connector	XLR-3-11C (female)
Input impedance	4.7 kohms or more
Frequency response	20 Hz to 22 kHz
T.H.D	MODE1, MODE2: 0.03% or less MODE3: 0.3% or less

0 dBu = 0.775 V

General

Operating voltage	3 V DC, with two LR6 (AA) alkaline batteries
Battery life	Continuous operating time 5 hours (at 25 °C (77 °F), 10-mW output using Sony LR6 (AA)-size alkaline batteries with CODEC MODE set to MODE1 and the wireless remote control function off and DIMMER MODE set to AUTO OFF and +48V set to OFF)
Operating temperature	0 °C to 50 °C (32 °F to 122 °F)
Storage temperature	-20 °C to +60 °C (-4 °F to +140 °F)
Wireless remote control	2.4-GHz IEEE802.15.4 compliant

Dimensions (unit: mm (inches))

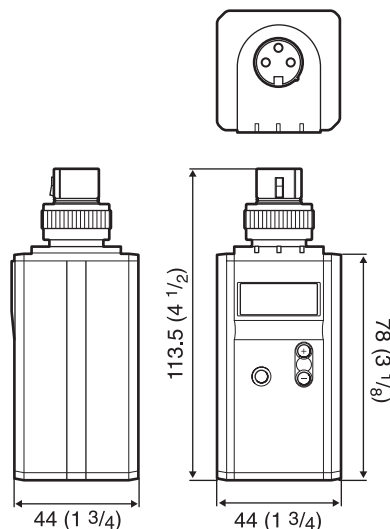

Mass Approx. 245 g (8.6 oz) including batteries
Supplied accessories

- Spare battery case (1)
- Soft case (1)
- USB adapter cable (1)
- Before Using this Unit (3)
- CD-ROM (1)

Optional accessories

- Electret Condenser Microphones
- ECM-673/9X
- ECM-674/9X
- ECM-678/9X

Design and specifications are subject to change without notice.

Notes

- Always verify that the unit is operating properly before use. SONY WILL NOT BE LIABLE FOR DAMAGES OF ANY KIND INCLUDING, BUT NOT LIMITED TO, COMPENSATION OR REIMBURSEMENT ON ACCOUNT OF THE LOSS OF PRESENT OR PROSPECTIVE PROFITS DUE TO FAILURE OF THIS UNIT, EITHER DURING THE WARRANTY PERIOD OR AFTER EXPIRATION OF THE WARRANTY, OR FOR ANY OTHER REASON WHATSOEVER.
- SONY WILL NOT BE LIABLE FOR CLAIMS OF ANY KIND MADE BY USERS OF THIS UNIT OR MADE BY THIRD PARTIES.
- SONY WILL NOT BE LIABLE FOR THE TERMINATION OR DISCONTINUATION OF ANY SERVICES RELATED TO THIS UNIT THAT MAY RESULT DUE TO CIRCUMSTANCES OF ANY KIND.

Carrier Frequencies and Channel Steps

Underlined items are the factory setting.

US models

Channel step: 25 kHz

Model No.	Frequency band	Frequency	Group/channel (factory setting)
U14 (TV14-25)	TV14-17	470.125 - 493.875 MHz	<u>00 1801 494.125 MHz</u>
	<u>TV18-21</u>	494.125 - 517.875 MHz	
	TV22-25	518.125 - 541.875 MHz	
U30 (TV30-41)	<u>TV30-33</u>	566.125 - 589.875 MHz	<u>00 3001 566.125 MHz</u>
	TV34-36	590.125 - 607.875 MHz	
	TV37	Not available	
	TV38-41	614.125 - 637.875 MHz	
U42 (TV42-51)	<u>TV42-45</u>	638.125 - 661.875 MHz	<u>00 4201 638.125 MHz</u>
	TV46-49	662.125 - 685.875 MHz	
	TV50-51	686.125 - 697.875 MHz	

European models

Channel step: 25 kHz

Model No.	Frequency band	Frequency	Group/channel (factory setting)
CE21 (TV21-29)	<u>TV21-23</u>	470.025 - 494.000 MHz	<u>00 2101 470.125 MHz</u>
	TV24-26	494.025 - 518.000 MHz	
	TV27-29	518.025 - 542.000 MHz	
CE33 (TV33-40)	<u>TV33-35</u>	566.025 - 590.000 MHz	<u>00 3301 566.125 MHz</u>
	TV36-37	590.025 - 606.000 MHz	
	TV38-40	606.025 - 630.000 MHz	
CE42 (TV42-50)	<u>TV42-44</u>	638.025 - 662.000 MHz	<u>00 4201 638.125 MHz</u>
	TV45-47	662.025 - 686.000 MHz	
	TV48-50	686.025 - 710.000 MHz	

<http://www.sony.net/>

Sony Corporation